

## PIC16C620A Rev. A Silicon Errata Sheet

The PIC16C620A (Rev. A) parts you have received conform functionally to the Device Data Sheet (DS30235G), except for the anomalies described below.

All the problems listed here will be addressed in future revisions of the PIC16C620A silicon.

### 1. Module: RESET

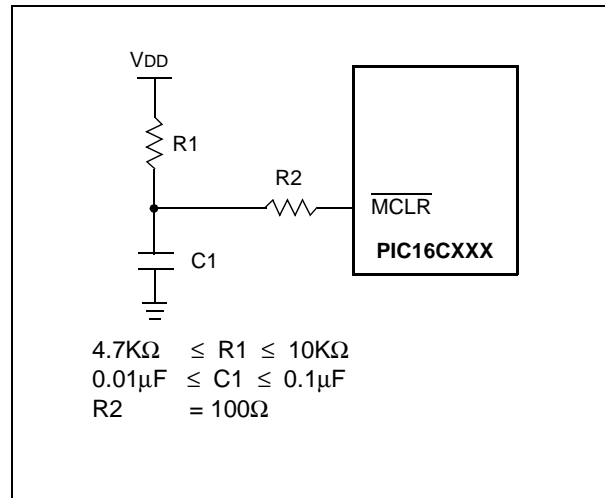
The minimum specification for the  $\overline{\text{MCLR}}$  must be met in order to RESET the PIC16CXXX. If a  $\overline{\text{MCLR}}$  pulse occurs that is less than the minimum specification (parameter #30), improper device operation can occur.

If the Minimum specification cannot be met, then an external circuit must be used to insure that any pulse width less than the specification will be filtered before it reaches the  $\overline{\text{MCLR}}$  pin.

#### Work Around

A possible circuit is shown in Figure 1. Proper design validation needs to be done to ensure desired operation over the applications operating conditions

**FIGURE 1:  $\overline{\text{MCLR}}$  EXTERNAL CIRCUIT**



**Note:** As with any windowed EPROM device, please cover the window at all times, except when erasing.

# PIC16C620A

## 2. Module: OSCILLATOR

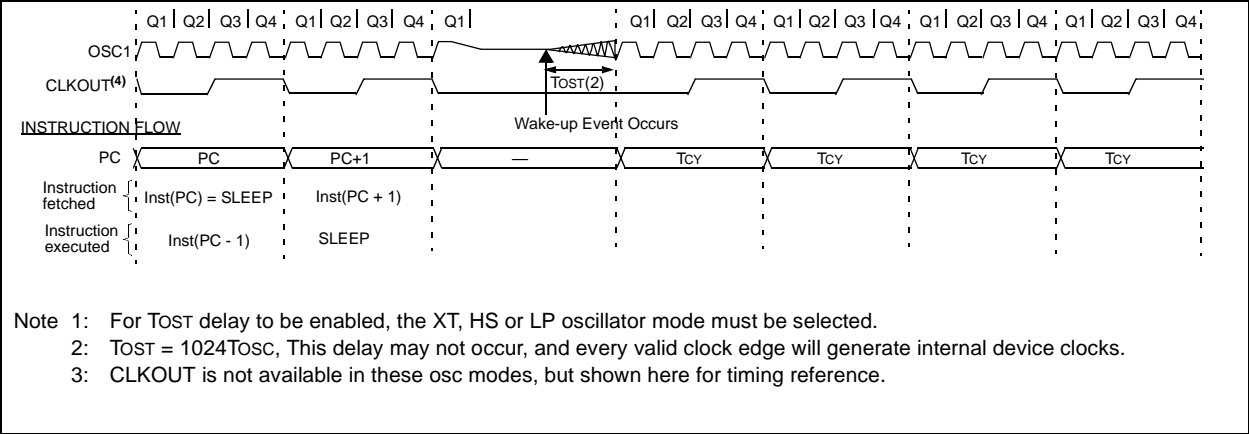
The Oscillator Start-up Timer (TOST) delay may not occur when the device wakes-up from sleep.

Figure 1 shows the start-up of the crystal after the event that causes the device to wake up from sleep mode (as specified in device data sheet). The start-up time (TOST) may not occur.

The events that wake-up the device from sleep are:

- An interrupt
- A WDT overflow (wake-up)
- A Brown-out Reset
- A  $\overline{\text{MCLR}}$  reset

**Figure 1: Wake-up from Sleep**

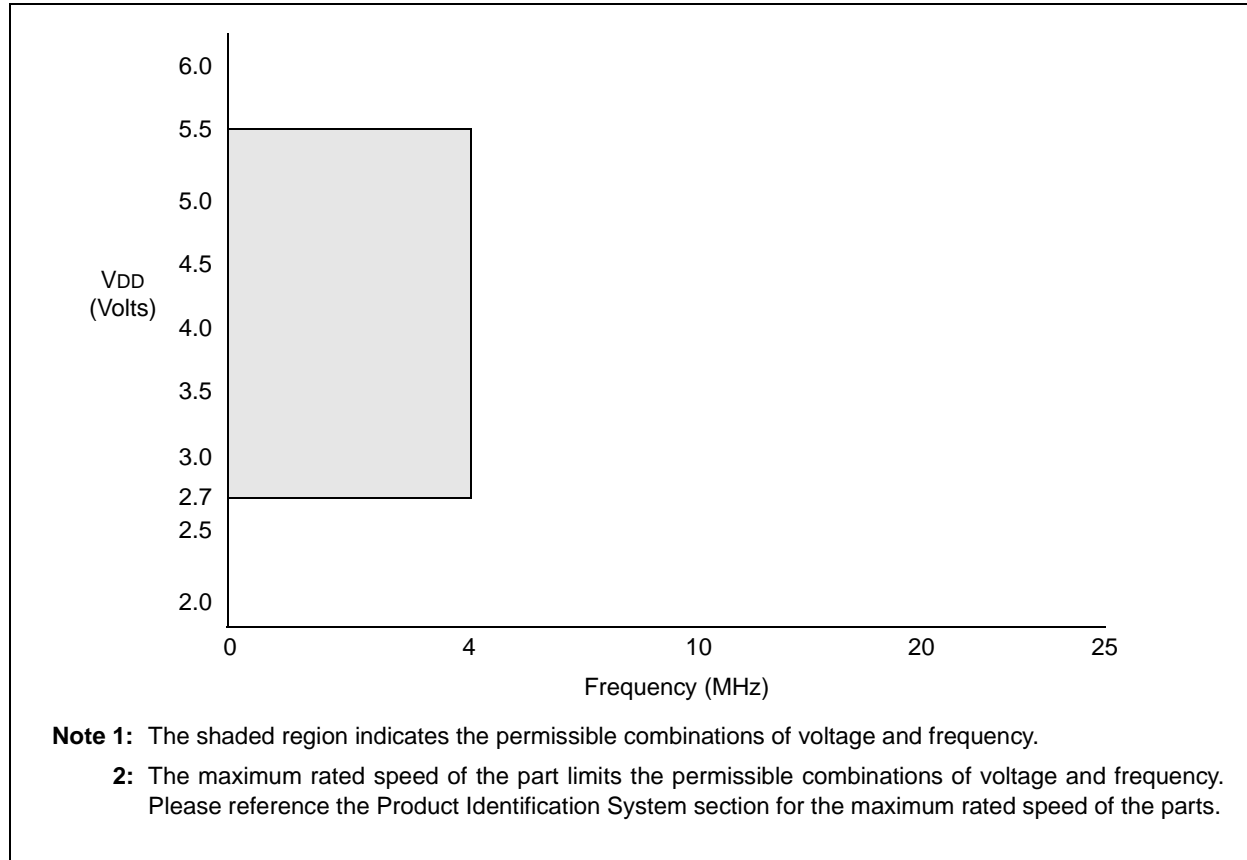


In applications where time based measurements are started immediately after wake-up from sleep, the suggested work around should be implemented.

### Work Around

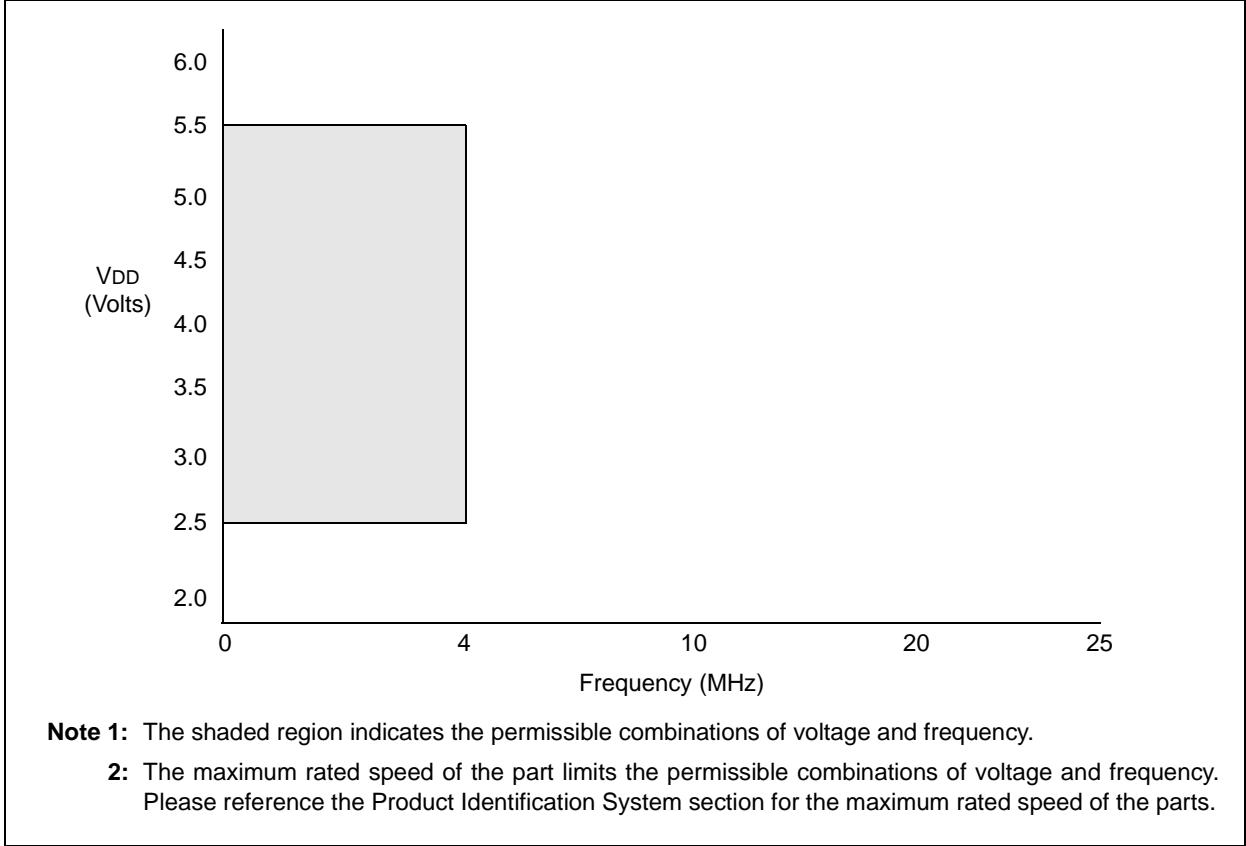
After the SLEEP instruction, do a software delay of 256 TcY (same as 1024 TOSC). At the Reset and Interrupt vector addresses, test to see if the device woke from sleep (the  $\overline{\text{TO}}$  and  $\overline{\text{PD}}$  bits), and if the device did wake from sleep, ensure that the total cycle delay is 256 TcY.

**FIGURE 2: PIC16LC620A VOLTAGE-FREQUENCY GRAPH,  $-40^{\circ}\text{C} \leq T_A \leq 0^{\circ}\text{C}$**

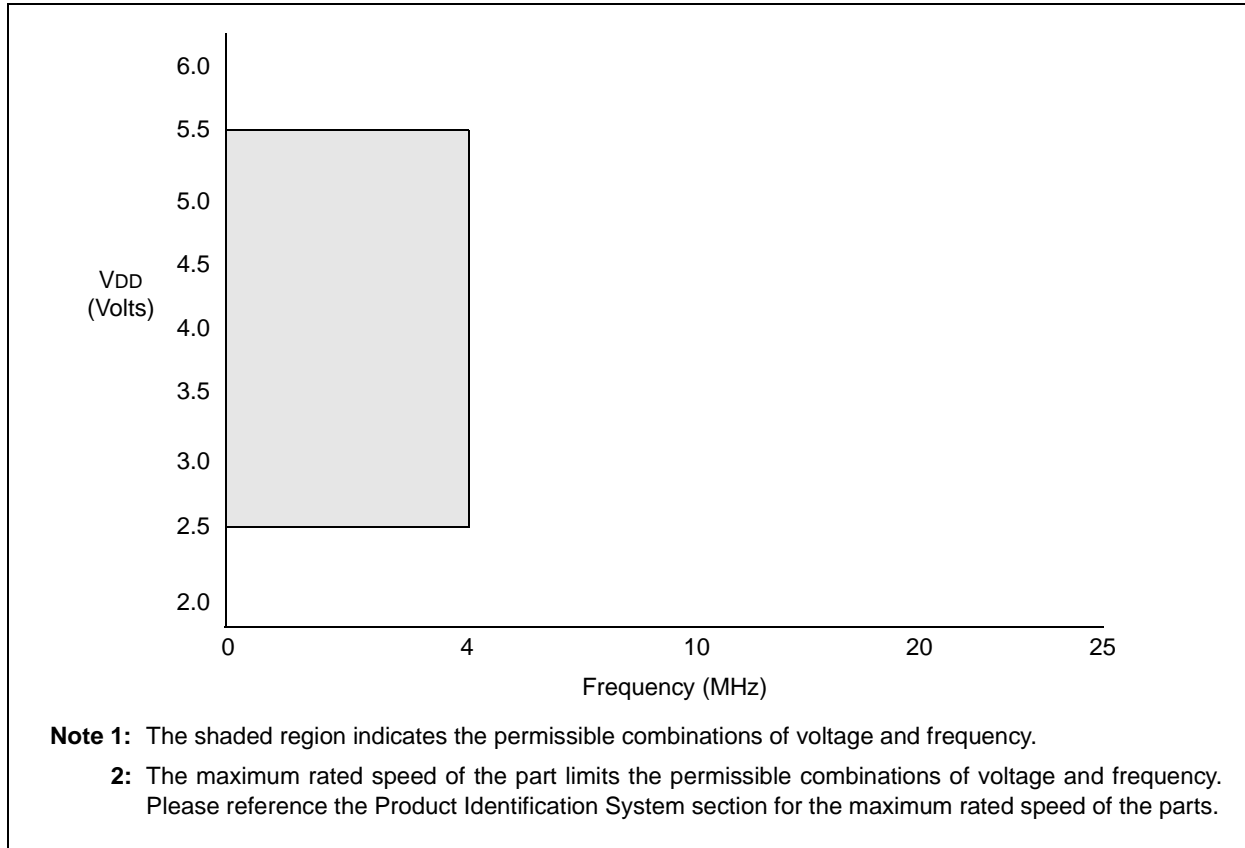


# PIC16C620A

FIGURE 3: PIC16LC620A VOLTAGE-FREQUENCY GRAPH,  $0^{\circ}\text{C} \leq T_A \leq +70^{\circ}\text{C}$

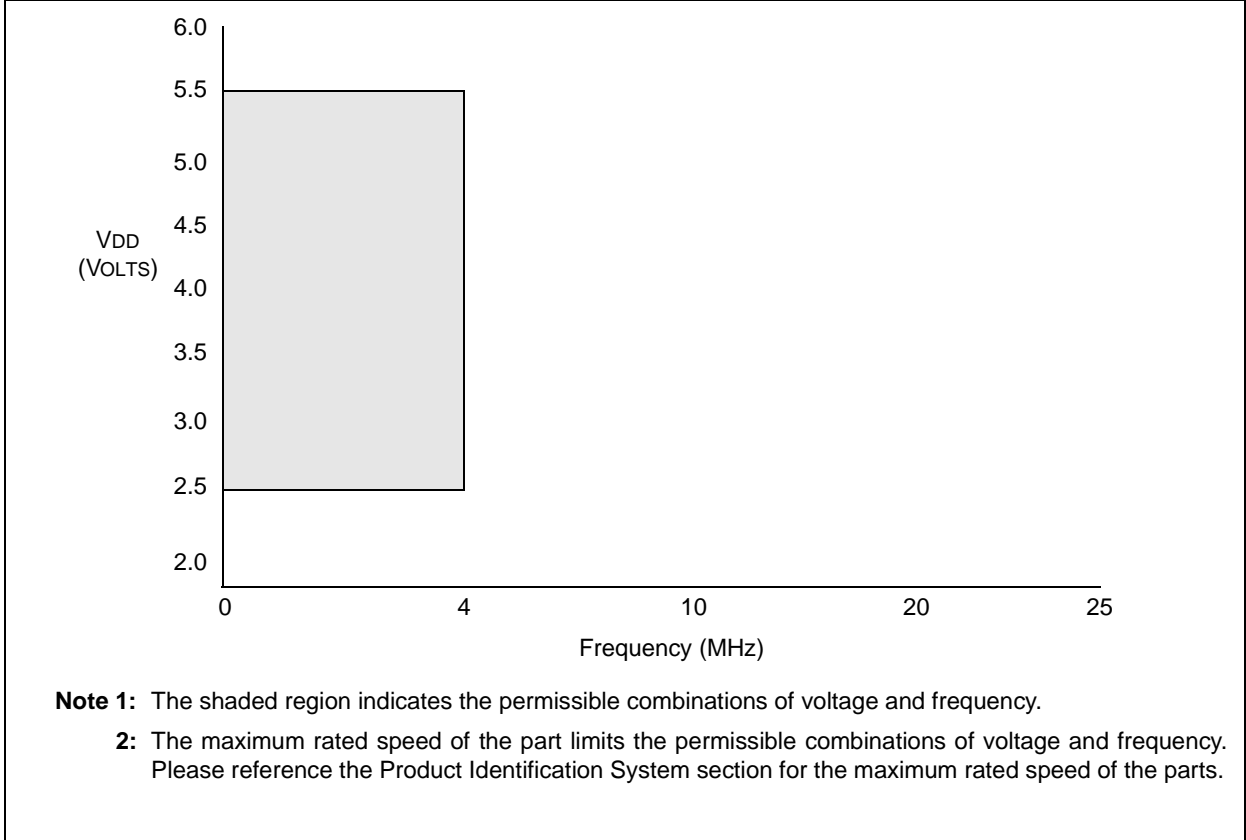


**FIGURE 4: PIC16LC620A VOLTAGE-FREQUENCY GRAPH,  $+70^{\circ}\text{C} \leq T_A \leq +125^{\circ}\text{C}$**



# PIC16C620A

FIGURE 5: PIC16LCR620A VOLTAGE-FREQUENCY GRAPH,  $-40^{\circ}\text{C} \leq T_A \leq +125^{\circ}\text{C}$



**Clarifications/Corrections to the Data Sheet:**

In the Device Data Sheet (DS30235G), the following clarifications and corrections should be noted.

none



## WORLDWIDE SALES AND SERVICE

### AMERICAS

#### Corporate Office

Microchip Technology Inc.  
2355 West Chandler Blvd.  
Chandler, AZ 85224-6199  
Tel: 480-786-7200 Fax: 480-786-7277  
Technical Support: 480-786-7627  
Web Address: <http://www.microchip.com>

#### Atlanta

Microchip Technology Inc.  
500 Sugar Mill Road, Suite 200B  
Atlanta, GA 30350  
Tel: 770-640-0034 Fax: 770-640-0307

#### Boston

Microchip Technology Inc.  
2 LAN Drive, Suite 120  
Westford, MA 01886  
Tel: 508-480-9990 Fax: 508-480-8575

#### Chicago

Microchip Technology Inc.  
333 Pierce Road, Suite 180  
Itasca, IL 60143  
Tel: 630-285-0071 Fax: 630-285-0075

#### Dallas

Microchip Technology Inc.  
4570 Westgrove Drive, Suite 160  
Addison, TX 75001  
Tel: 972-818-7423 Fax: 972-818-2924

#### Dayton

Microchip Technology Inc.  
Two Prestige Place, Suite 150  
Miamisburg, OH 45342  
Tel: 937-291-1654 Fax: 937-291-9175

#### Detroit

Microchip Technology Inc.  
Tri-Atria Office Building  
32255 Northwestern Highway, Suite 190  
Farmington Hills, MI 48334  
Tel: 248-538-2250 Fax: 248-538-2260

#### Los Angeles

Microchip Technology Inc.  
18201 Von Karman, Suite 1090  
Irvine, CA 92612  
Tel: 949-263-1888 Fax: 949-263-1338

#### New York

Microchip Technology Inc.  
150 Motor Parkway, Suite 202  
Hauppauge, NY 11788  
Tel: 631-273-5305 Fax: 631-273-5335

#### San Jose

Microchip Technology Inc.  
2107 North First Street, Suite 590  
San Jose, CA 95131  
Tel: 408-436-7950 Fax: 408-436-7955

### AMERICAS (continued)

#### Toronto

Microchip Technology Inc.  
5925 Airport Road, Suite 200  
Mississauga, Ontario L4V 1W1, Canada  
Tel: 905-405-6279 Fax: 905-405-6253

### ASIA/PACIFIC

#### China - Beijing

Microchip Technology, Beijing  
Unit 915, 6 Chaoyangmen Bei Dajie  
Dong Erhuan Road, Dongcheng District  
New China Hong Kong Manhattan Building  
Beijing, 100027, P.R.C.  
Tel: 86-10-85282100 Fax: 86-10-85282104

#### China - Shanghai

Microchip Technology  
Unit B701, Far East International Plaza,  
No. 317, Xianxia Road  
Shanghai, 200051, P.R.C.  
Tel: 86-21-6275-5700 Fax: 86-21-6275-5060

#### Hong Kong

Microchip Asia Pacific  
Unit 2101, Tower 2  
Metroplaza  
223 Hing Fong Road  
Kwai Fong, N.T., Hong Kong  
Tel: 852-2-401-1200 Fax: 852-2-401-3431

#### India

Microchip Technology Inc.  
India Liaison Office  
No. 6, Legacy, Convent Road  
Bangalore, 560 025, India  
Tel: 91-80-229-0061 Fax: 91-80-229-0062

#### Japan

Microchip Technology Intl. Inc.  
Benex S-1 6F  
3-18-20, Shinyokohama  
Kohoku-Ku, Yokohama-shi  
Kanagawa, 222-0033, Japan  
Tel: 81-45-471-6166 Fax: 81-45-471-6122

#### Korea

Microchip Technology Korea  
168-1, Youngbo Bldg. 3 Floor  
Samsung-Dong, Kangnam-Ku  
Seoul, Korea  
Tel: 82-2-554-7200 Fax: 82-2-558-5934

### ASIA/PACIFIC (continued)

#### Singapore

Microchip Technology Singapore Pte Ltd.  
200 Middle Road  
#07-02 Prime Centre  
Singapore, 188980  
Tel: 65-334-8870 Fax: 65-334-8850

#### Taiwan

Microchip Technology Taiwan  
10F-1C 207  
Tung Hua North Road  
Taipei, Taiwan  
Tel: 886-2-2717-7175 Fax: 886-2-2545-0139

### EUROPE

#### Denmark

Microchip Technology Denmark ApS  
Regus Business Centre  
Lautrup hof 1-3  
Ballerup DK-2750 Denmark  
Tel: 45 4420 9895 Fax: 45 4420 9910

#### France

Arizona Microchip Technology SARL  
Parc d'Activite du Moulin de Massy  
43 Rue du Saule Trapu  
Batiment A - 1er Etage  
91300 Massy, France  
Tel: 33-1-69-53-63-20 Fax: 33-1-69-30-90-79

#### Germany

Arizona Microchip Technology GmbH  
Gustav-Heinemann-Ring 125  
D-81739 München, Germany  
Tel: 49-89-627-144 0 Fax: 49-89-627-144-44

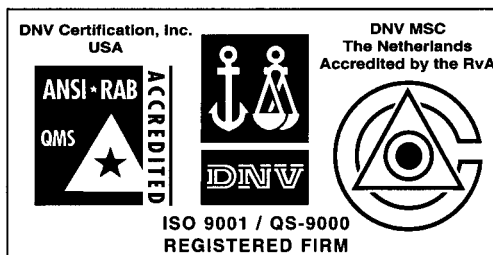
#### Italy

Arizona Microchip Technology SRL  
Centro Direzionale Colleoni  
Palazzo Taurus 1 V. Le Colleoni 1  
20041 Agrate Brianza  
Milan, Italy  
Tel: 39-039-65791-1 Fax: 39-039-6899883

#### United Kingdom

Arizona Microchip Technology Ltd.  
505 Eskdale Road  
Winnersh Triangle  
Wokingham  
Berkshire, England RG41 5TU  
Tel: 44 118 921 5858 Fax: 44-118 921-5835

05/16/00



Microchip received QS-9000 quality system certification for its worldwide headquarters, design and wafer fabrication facilities in Chandler and Tempe, Arizona in July 1999. The Company's quality system processes and procedures are QS-9000 compliant for its PICmicro® 8-bit MCUs, KEELoc® code hopping devices, Serial EEPROMs and microperipheral products. In addition, Microchip's quality system for the design and manufacture of development systems is ISO 9001 certified.

All rights reserved. © 2000 Microchip Technology Incorporated. Printed in the USA. 6/00 Printed on recycled paper.

Information contained in this publication regarding device applications and the like is intended through suggestion only and may be superseded by updates. It is your responsibility to ensure that your application meets with your specifications. No representation or warranty is given and no liability is assumed by Microchip Technology Incorporated with respect to the accuracy or use of such information, or infringement of patents or other intellectual property rights arising from such use or otherwise. Use of Microchip's products as critical components in life support systems is not authorized except with express written approval by Microchip. No licenses are conveyed, implicitly or otherwise, except as maybe explicitly expressed herein, under any intellectual property rights. The Microchip logo and name are registered trademarks of Microchip Technology Inc. in the U.S.A. and other countries. All rights reserved. All other trademarks mentioned herein are the property of their respective companies.