

CHAPTER
80
STARTING



CHAPTER 80
STARTING

CH-SC-SU	Schem	Page	Sheet	Date	CH-SC-SU	Schem	Page	Sheet	Date
80-EFFECTIVE PAGES									
		1		May 06/2009					
		2		BLANK					
80-CONTENTS									
R		1		May 06/2009					
		2		BLANK					
80-ALPHABETICAL INDEX									
		1		Dec 18/2007					
		2		BLANK					
80-00-00									
R		101		May 06/2009					
80-11-01									
R		101		May 06/2009					
D		102		May 06/2009					
80-11-02									
R		101		May 06/2009					
D		102		May 06/2009					

A = Added, R = Revised, D = Deleted, O = Overflow

80-EFFECTIVE PAGES



CHAPTER 80
STARTING

	Title	CH-SC-SU	Schem	Page	Sheet	Date	Effectivity
	<u>STARTING</u>						
I	ENGINE STARTING SYSTEM	80-00-00		101		May 06/2009	ALL
	<u>ENGINE STARTING SYSTEM</u>						
I	LEFT ENGINE START	80-11-01		101		May 06/2009	ALL
I	RIGHT ENGINE START	80-11-02		101		May 06/2009	ALL

CHAPTER 80
STARTING

CH-SC-SU	Title
80-00-00	ENGINE STARTING SYSTEM
80-11-01	LEFT ENGINE START
80-11-02	RIGHT ENGINE START

CH-SC-SU	Title
----------	-------

80-ALPHABETICAL INDEX

5000

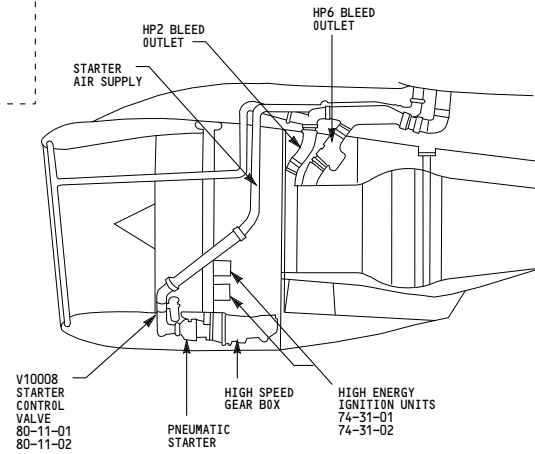
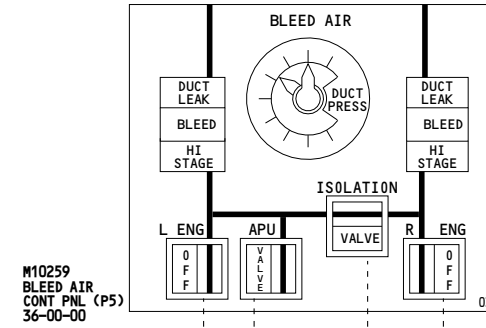
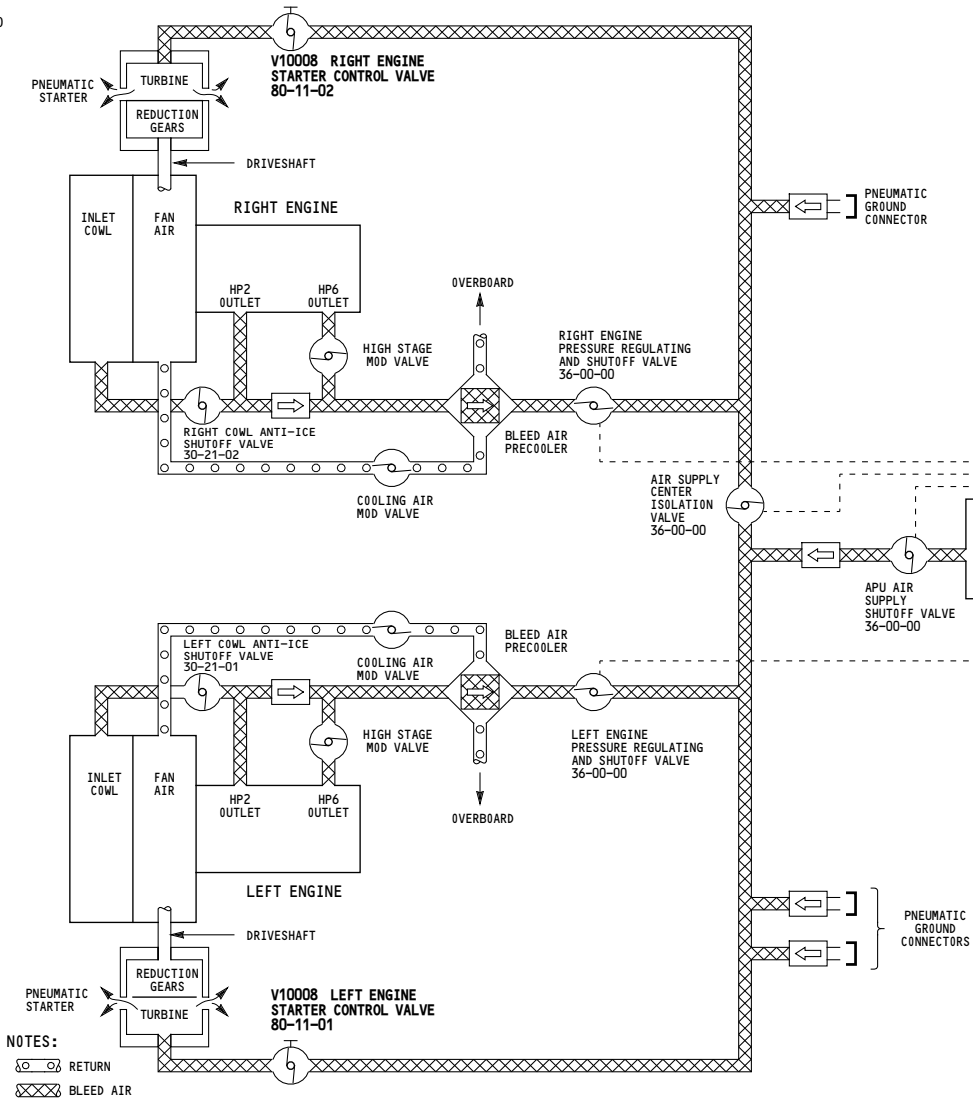

ALL	<p align="center">ENGINE STARTING SYSTEM</p> <p align="center">D280N032S</p>
-----	-------------------------------------------------------------------------------------

80-00-00

5028

WIRING DIAGRAMS
80-11-11

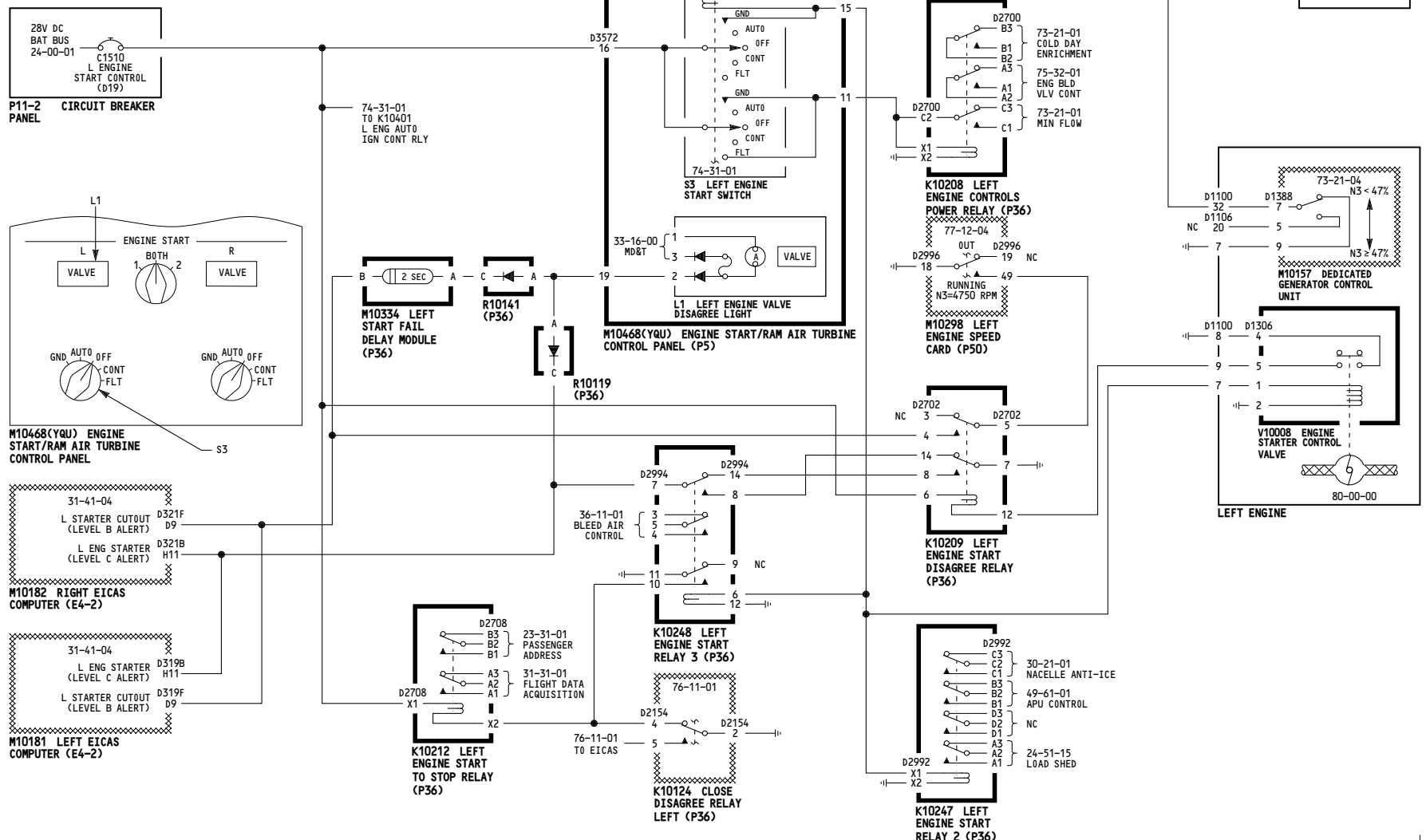

ALL	LEFT ENGINE START
	D280N032S

80-11-01

Page 101

May 06/2009

-B
5028

WIRING DIAGRAMS
80-11-21

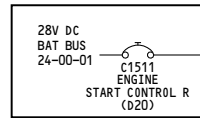

P11-2 CIRCUIT BREAKER PANEL

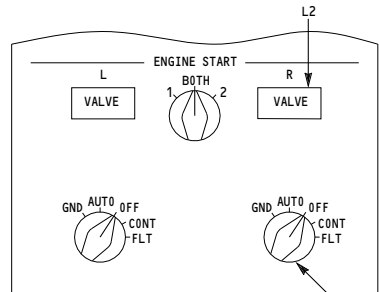

M10468(YQU) ENGINE START/RAM AIR TURBINE CONTROL PANEL

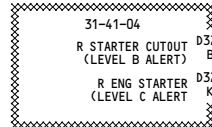

M10182 RIGHT EICAS COMPUTER (E4-2)

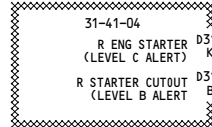

M10181 LEFT EICAS COMPUTER (E4-2)

74-31-02 TO K10402 D4498 PIN X1

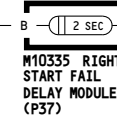

M10335 RIGHT START FAIL DELAY MODULE (P37)

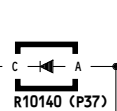

R10140 (P37)



R10120 (P37)

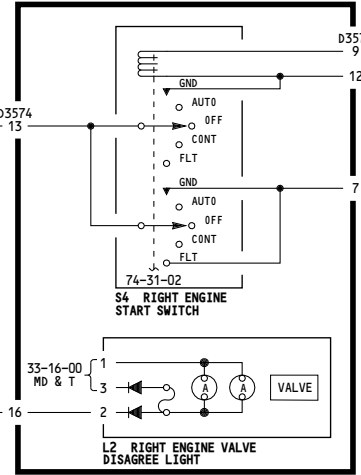

M10468(YQU) ENGINE START/RAM AIR TURBINE CONTROL PANEL (P5)

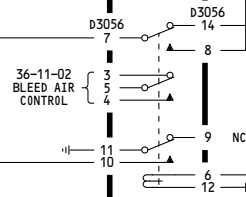

K10251 RIGHT ENGINE START RELAY 3 (P37)

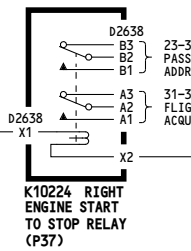

K10224 RIGHT ENGINE START TO STOP RELAY (P37)

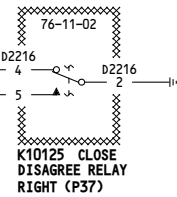

K10125 CLOSE DISAGREE RELAY RIGHT (P37)

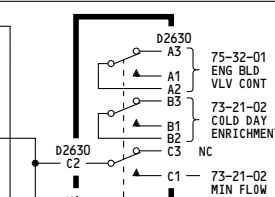

K10220 RIGHT ENGINE CONTROLS POWER RELAY (P37)

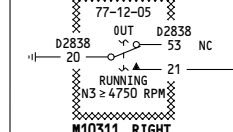

M10311 RIGHT ENGINE SPEED CARD (P50)

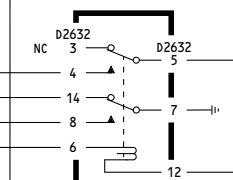

K10221 RIGHT ENGINE START DISAGREE RELAY (P37)

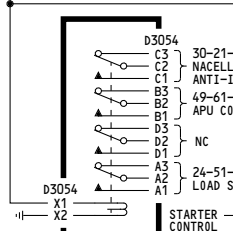

K10250 RIGHT ENGINE START RELAY 2 (P37)

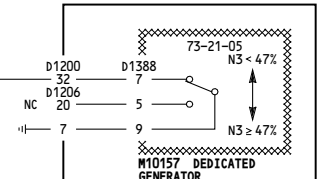

M10157 DEDICATED GENERATOR

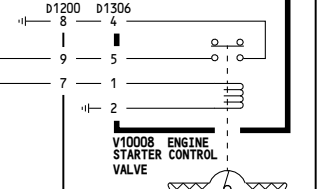

V10008 ENGINE STARTER CONTROL VALVE

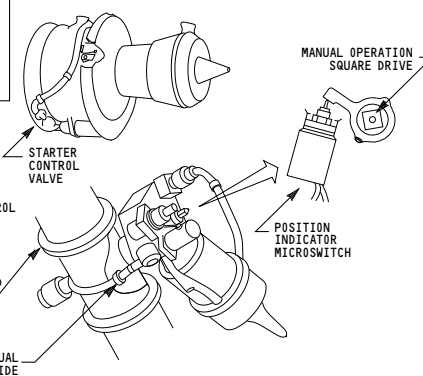

ALL	RIGHT ENGINE START
	D280N032S

80-11-02

Page 101

May 06/2009