

**BRONICA**

***RF645***

*Rangefinder 6x4.5 Medium Format Camera*

**CAMERA BODY** *INSTRUCTIONS*

Thank you for your purchase of the Bronica RF645 medium format rangefinder camera. Incorporating the best of Bronica's know-how and technological expertise, the Bronica RF645 achieves a new dimension in compactness as the world's first medium format 6 x 4.5 rangefinder camera to feature interchangeable lenses, and comes with a superb line up of lenses to take full advantage of the rangefinder camera. The RF645 employs manual film advance lever and dual-image superimposing rangefinder focusing for maximum user control where it counts, while enhancing handling ease with Program AE, automatic shutter cocking via a motor incorporated in the lens unit, and an automatic light shielding curtain to protect film as the lens being removed. This is a camera designed for the maximum enjoyment of photography in mind.

The features and handling procedures described in this owner's manual are based on use of the Bronica RF645 in combination with the Zenzanon RF65mm f/4 standard lens. To obtain best results from your new camera, please read this instruction manual carefully before use. With proper care and handling, the unit will continue to provide pleasure and performance for many years to come.

In this package, along with the camera body and the standard lens, you will find the following accessories.

- 1) 1 camera body cap RF (attached to the mount section on camera; remove when mounting a lens),
- 2) 1 sync terminal cover (attached to sync terminal),
- 3) 1 hotshoe cover (attached to hotshoe),
- 4) 1 interchangeable eyepiece lens RF (-1) (attached to viewfinder eyepiece),
- 5) 1 rubber eyecup RF (attached to viewfinder eyepiece),
- 6) 1 protective sheet for light shielding curtain (attached to film aperture of camera. Remove prior to using camera.),
- 7) 1 film take-up spool (installed in take-up side film chamber),
- 8) 1 camera strap RF (N),
- 9) 2 CR2 type 3V lithium batteries, and
- 10) 1 Owner's Manual (this booklet).

Note: The batteries included are intended for initial use, and the battery life may not be adequate for normal photographing. Please be prepared to purchase a new set of batteries of the same type to ensure best results







# Important Safety Information

- Please read these safety precautions and the owner's manual and follow the instructions carefully.
- This product is not to be used for purposes other than photography.





 **Warning:** This designation indicates that death or serious injury may result from ignoring these instructions.

 **Caution:** This designation indicates that personal injury or damage to equipment may be caused as a result of ignoring these instructions.



## Warning

-  • Never disassemble the unit. Electric shock may be sustained.
-  • If internal parts are exposed by dropping the equipment by accident etc., never touch these internal parts. High-voltage circuitry may cause electric shock.
-  • When attaching the Speedlight to the hotshoe or sync socket, do not touch the electric contacts. Electric shock may be caused. Always attach the appropriate cover to the hotshoe and sync socket when these are not in use.
-  • If the camera or batteries become hot, gives off smoke or a burning smell, immediately switch the unit off and remove the batteries. Fire and burn injuries may be caused. (When removing the batteries take proper precautions to avoid burns).
-  • Never use the camera unit in locations where flammable gases are present, or near flammable liquids such as gasoline, benzene, or paint thinner. Explosion or fire may break out, causing personal injury.
-  • Keep the camera unit out of the reach of infants and young children. Failure to do so may result in injuries such as choking caused by the camera strap.
-  • Never disassemble, heat, burn, recharge or short-circuit the batteries. Explosion may be triggered.

## Warning

-  • Do not use batteries other than the type as specified. Doing so may result in overheating or fire.
-  • Do not use new and old batteries together. Also, be sure not to align the + and - polarities incorrectly. Doing so may result in rupture or leaking, causing fire, injury and damage to equipment.
-  • Always keep batteries out of the reach of infants and young children to prevent accidental swallowing. If batteries are swallowed, seek immediate emergency medical attention.
-  • Do not look through the camera at direct sunlight or strong light sources. Eye injury may be caused.

## Caution

-  • Do not touch the camera with wet hands or allow the equipment to become soaked. Electric shock may be caused.
-  • Do not point the Speedlight toward people who are operating bicycles, automobiles or trains. Traffic accidents may be caused.

# Contents

Introduction .....	1	4. Other features .....	27
Important Safety Precautions .....	2	4-1 Multiple exposure .....	27
Contents .....	3	4-2 Selftimer .....	28
Special Features of the Bronica RF645 .....	4	4-3 Electronic Flash photography .....	29
Nomenclature .....	5	4-4 Long exposure photography .....	30
1. Getting started .....	8	4-5 Infrared photography .....	30
1-1 Loading batteries .....	8	4-6 Depth of field .....	31
1-2 Attaching and detaching lens .....	9	5. Troubleshooting .....	33
1-3 Attaching strap .....	10	6. References .....	35
1-4 Attaching the proper diopter adjustment lens .....	10	7. Specifications .....	37
2. Preparing to shoot .....	11	8. Preliminary checklist .....	38
2-1 Checking battery capacity .....	11	9. Ensuring years of enjoyment through proper care and handling .....	40
2-2 Loading film .....	12		
2-3 Setting film speed .....	15		
2-4 Exposure Counter, Film memo holder, How to remove a used roll of film .....	15		
3. Shooting .....	17		
3-1 Main switch .....	17		
3-2 Viewfinder, Holding the camera .....	17		
3-3 Shutter release button, Viewfinder display .....	18		
3-4 Exposures .....	20		
3-4-1 Shutter dial and lens aperture operations .....	20		
3-4-2 Exposure Metering system .....	21		
3-4-3 Exposure control modes .....	21		
1) Program AE mode .....	21		
2) Aperture-priority AE mode .....	22		
3) Manual exposure control .....	23		
3-4-4 Exposure compensation .....	24		
3-4-5 AE lock .....	25		
3-5 Focusing .....	25		
3-6 Automatic parallax compensation .....	26		

# Special Features of the Bronica RF 645

- \* A medium format coupled-meter rangefinder camera  
The Bronica RF 645 is a very compact and lightweight camera with a picture area approximately 2.7 times larger than the 35-mm format. The superior portability and versatility of this model compared with other medium format cameras ushers in an entirely new world of photographic possibilities..
- \* The remarkable lens shutter system  
The electronically-controlled #00 type lens shutter system developed for the Bronica RF 645 commands precise shutter speed control and automatic cocking, as well as aperture control incorporated within the shutter unit. The interface between the main camera body and the lens are conducted by means of a series of electronic contacts, resulting in high precision operation compared with conventional systems operated by mechanical couplers. The highly advanced lens shutter system is impressively stable and free of jolts caused by shutter shock, while it ensures synchronization with an electronic flash at any shutter speed allowing sophisticated flash photography.
- \* Automatic light shielding curtain engaged during lens interchange  
A lens shutter camera with interchangeable lens capability would normally require a light shielding curtain to be activated manually prior to detachment of the lens. The Bronica RF 645 has made such complex and awkward steps unnecessary, enabling photographers to focus on the shooting itself. In conjunction with the lens detachment operation, the light shielding curtain automatically covers the film aperture and locks into place. When the next lens is mounted on the camera, the curtain automatically opens to prepare the camera for the next shooting.
- \* Hi-tech magnesium alloy Thixomolding  
The top cover of the Bronica RF 645, a lightweight and extremely sturdy camera, is manufactured with an advanced Thixomolding technique. This technology enables a hard and rigid magnesium alloy to be molded into intricate and complex forms required to hold and protect internal mechanisms with precision in various, at times even adverse, operating conditions.
- \* Rear cover design provides sophisticated controls with easy access and handling.  
Switches and dials on the rear cover are grouped together on the rear cover for easy handling and to enable confirmation of settings at a glance, an extremely important feature for use in the hands of serious photographers.
- \* Shooting parameters of the camera are clearly indicated on the internal viewfinder display panel.  
An oversized LCD panel is installed inside the viewfinder to display constantly updated shooting status data such as shutter speed, lens aperture, AE lock setting, exposure compensation setting, correct exposure setting and exposure deviations of manually set exposure values and so on.
- \* Easy AE lock method with continuous AE lock memory system  
The AE lock feature of the Bronica RF 645 stores an exposure value into memory for an extended time without canceling it at a shutter click. The metered and stored exposure value can then be modified by the shutter speed and aperture combination variations, or even by compensating the stored exposure with exposure bracketing technique.  
Note: Repeated activation of the AE lock memory may be limited by the remaining battery capacity. Also, the AE lock memory will be automatically canceled if the power is switched off or camera is left unused for five minutes.
- \* The dedicated automatic flash unit that cross-couples with the AE setting on the camera  
The dedicated AE flash unit, the Bronica Speedlight RF 20, specially designed for the RF645 camera body, is coupled with the camera control system. The unit utilizes the electronic contacts of the hotshoe on the camera to transmit and receive lens aperture values, the aperture control signals and other control data, enabling the flash unit to compensate for the flash illumination by a half stop within -3 to +2 exposure compensation range.

# Nomenclature

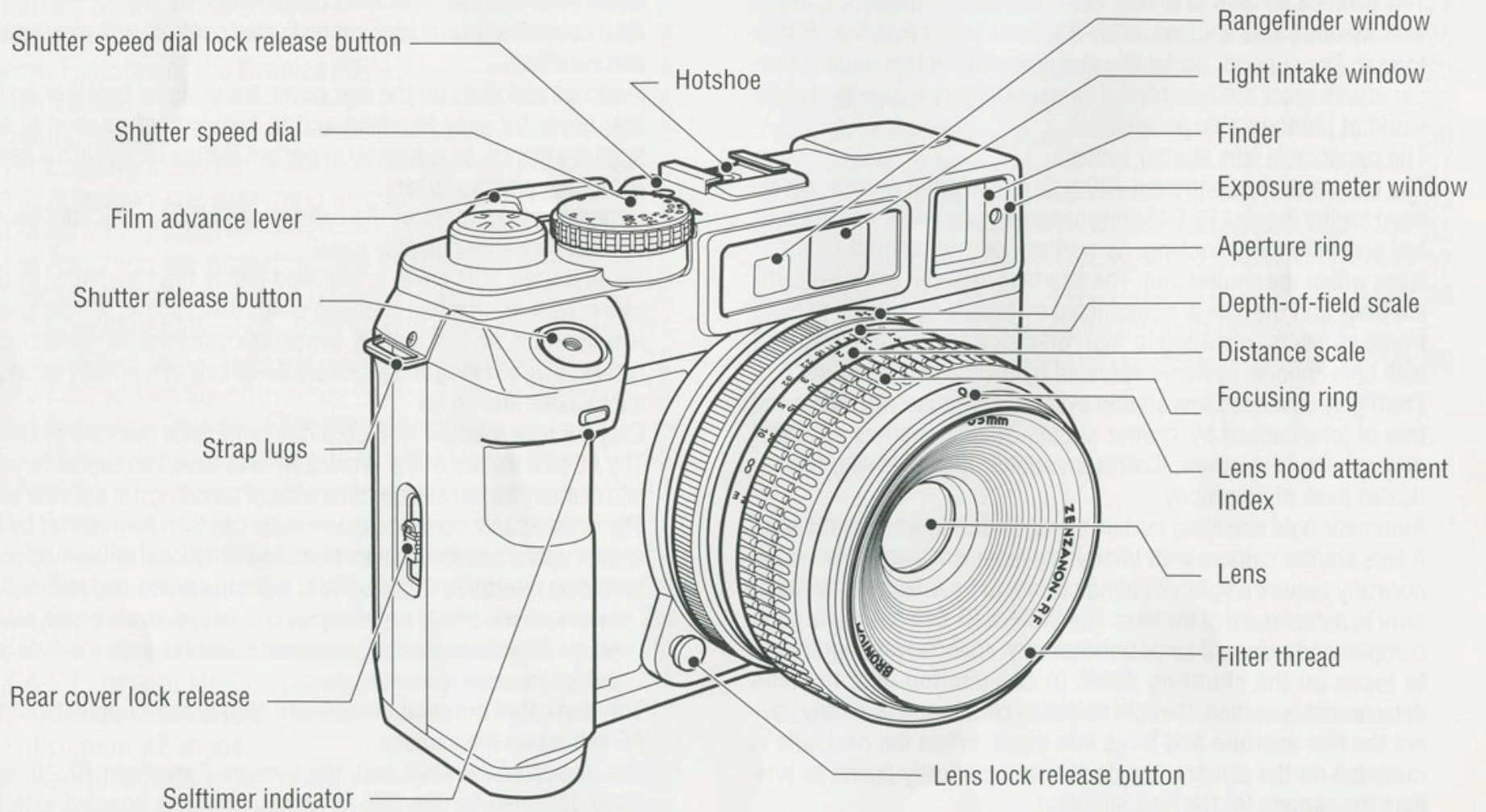

# Nomenclature

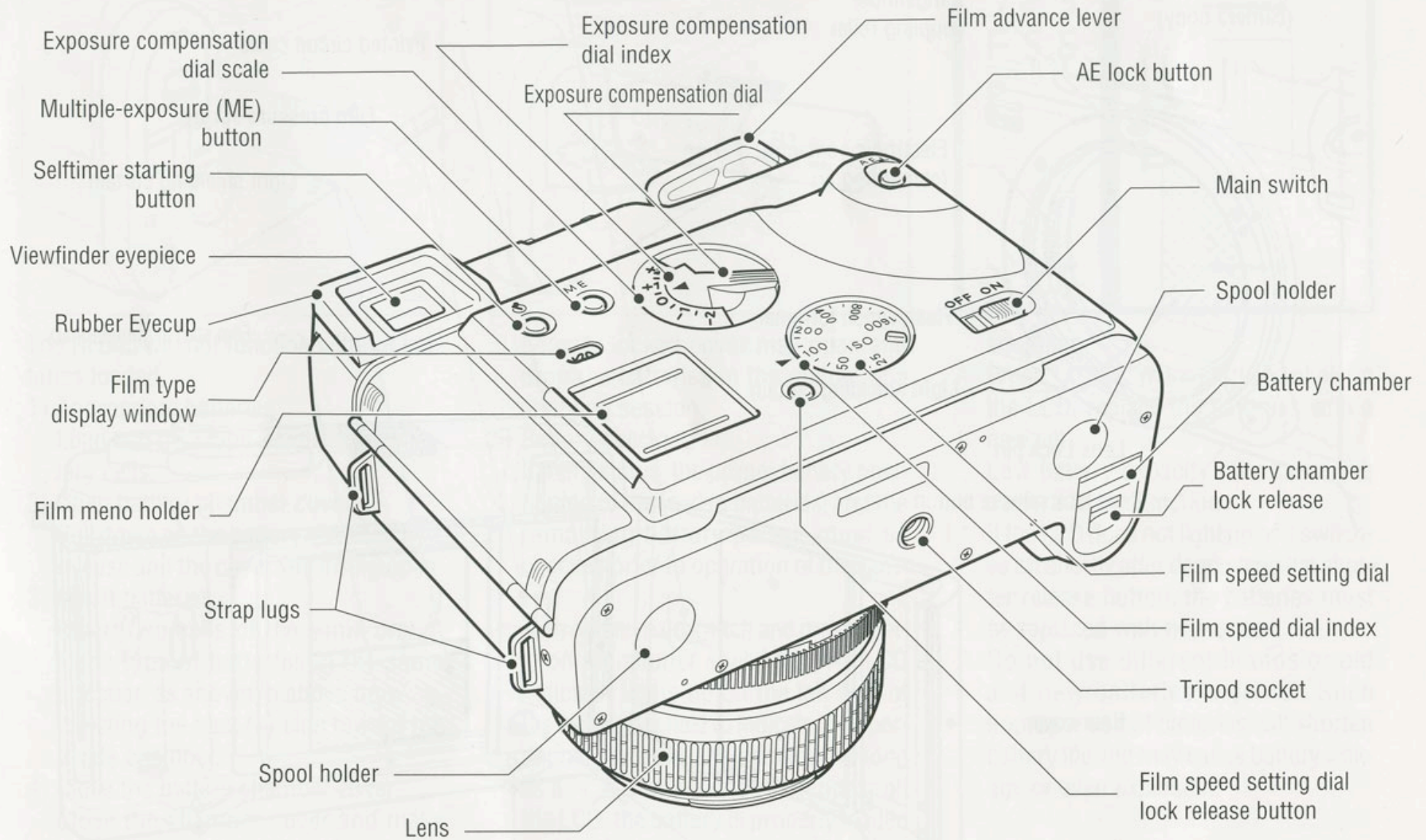

# Nomenclature

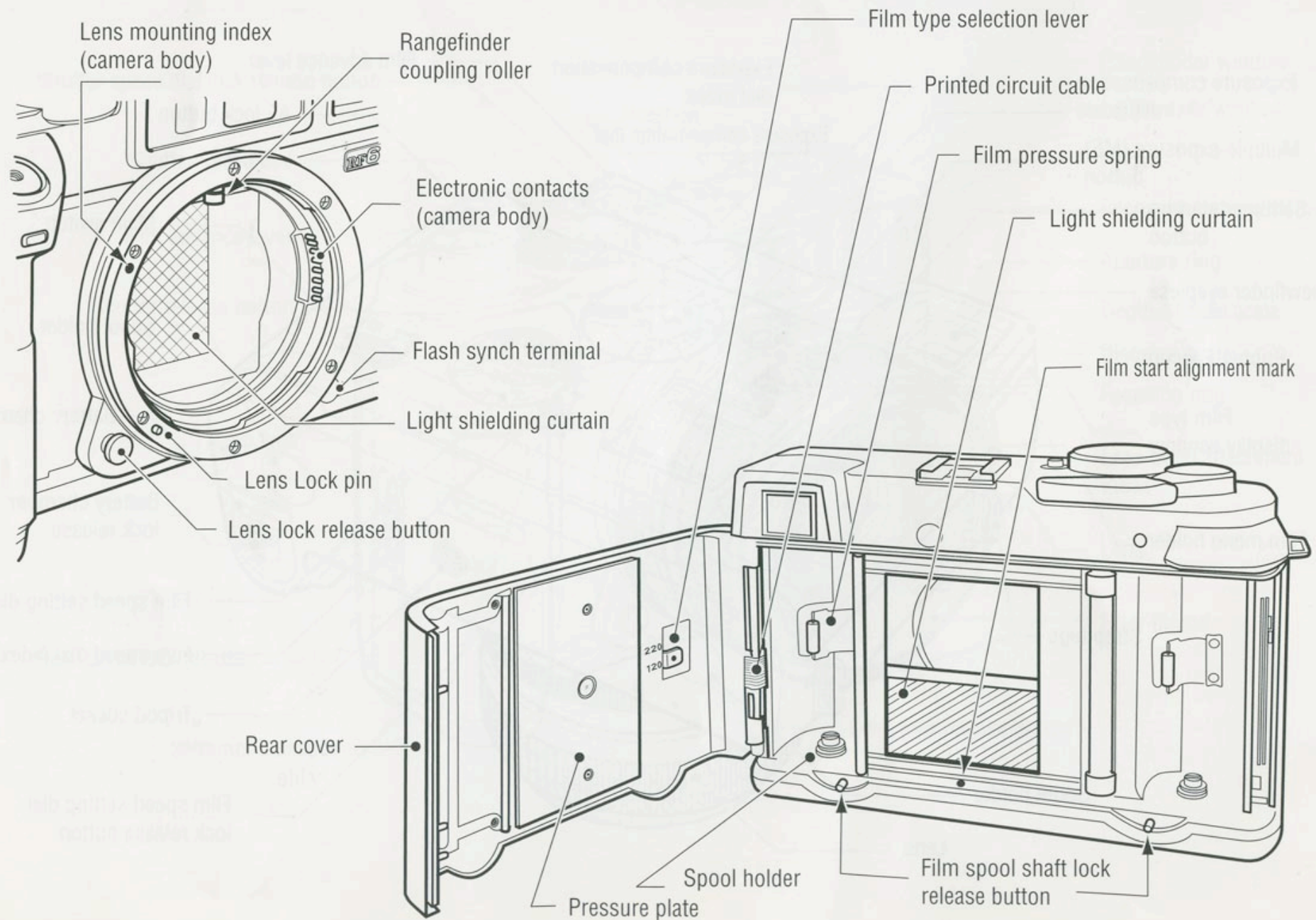



# 1. Getting started

## 1-1 Loading batteries

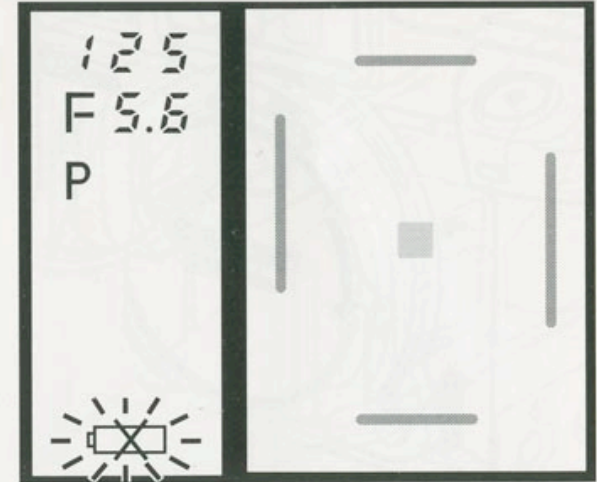
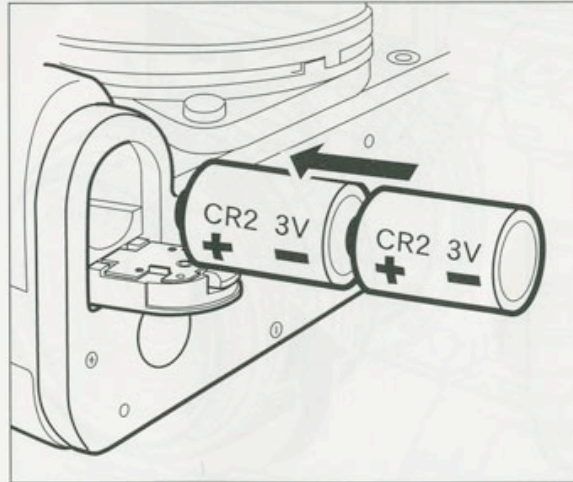
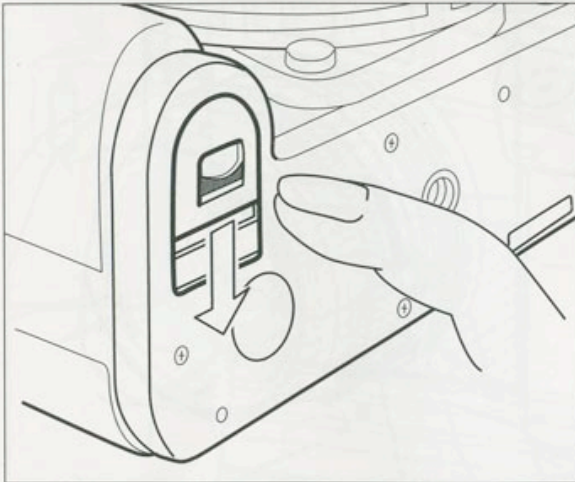

The RF645 will not function without batteries loaded.

### 1) Appropriate batteries

Load two CR2 type 3-volt lithium battery cells.

### 2) Open battery chamber cover.

Pull down on the battery chamber lock release and the cover will swing open.

### 3) Insert batteries.

Insert two cells of the same brand, same type of batteries in the same direction as shown in above drawing, directing the plus (+) side toward the inside chamber.

### 4) Close the battery chamber cover.

Close the chamber cover and make sure the cover is securely locked.

Loosely locked cover may open and drop the batteries in the middle of a shooting session.

### 5) Battery checking

Battery status, the proper battery positioning of the loaded batteries, and the remaining battery power, must be checked prior to operation of the camera.

Turn on the main switch and press lightly on the shutter speed dial. An LCD indicator lights up on the left side of the viewfinder field to indicate the operational status of the camera. As long as a "" mark does not appear on the LCD, the battery is properly loaded and the battery power is sufficient for

shooting.

- \* When "" mark starts to blink on the LCD, replace the batteries with a new set.

Low battery capacity may cause the camera to malfunction.

- \* If the LCD does not light up or it switches off shortly after depressing the shutter release button, the batteries must be replaced with new ones.

- \* Do not use different brands or old and new batteries together. Such improper use of batteries will shorten battery life and may cause battery leakage or even explosion.

# 1. Getting started

## 1-2 Attaching and detaching the lens

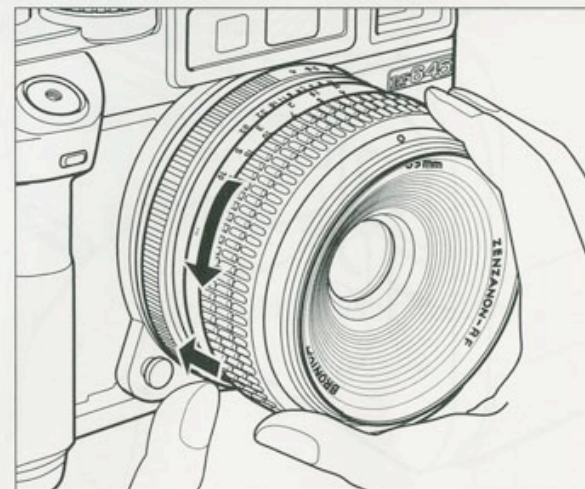
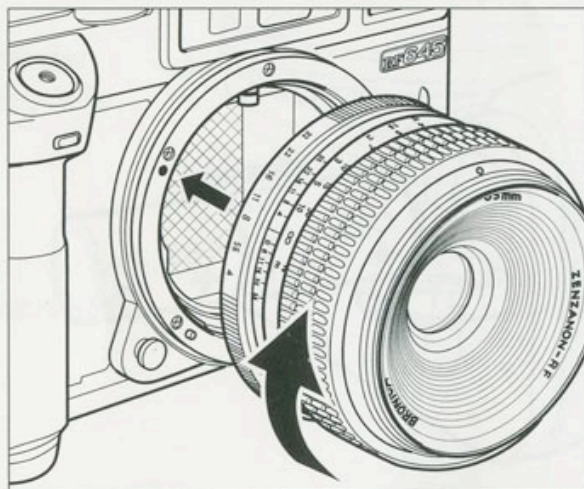
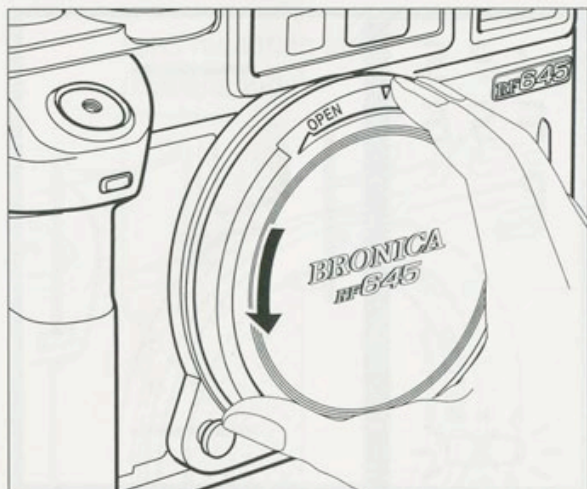

### 1-2-1 Attaching the lens

1) Rotate the rear lens cap of the lens counterclockwise about 70°, and lift it off when it comes to a mechanical stop.

2) Align the lens mounting index on the lens barrel with its counterpart on the camera body. Place the lens into the lens mount on the camera body, and then rotate the lens barrel clockwise until it clicks to a stop. Make sure the lens is locked in position before using.

Note: Do not touch the electronic contacts, the rangefinder coupling roller, or the light shielding curtain located around and behind the camera mount section. Contact with these may cause

damages and/or leave stains on vital systems, leading to malfunctioning of the camera.

### 1-2-2 Detaching the lens

1) Depressing the lens lock release button, rotate the lens barrel counterclockwise, until it comes to a mechanical end.

2) Pull out the lens barrel from the mount of the camera.

Note 1: The 65mm and 100mm viewframes in the viewfinder are automatically switched as the respective lenses are attached.

Note 2: When mounting the 45mm lens, insert the dedicated viewfinder into the accessory hotshoe on the camera body.

Refer to the instruction manual of the 45mm lens for more information.

Note 3: When attaching or detaching lenses, do not use excessive force to rotate or twist the lens.

Note 4: Never attempt to detach the lens while the shutter is open in B (bulb) shooting.

Note 5: This camera employs a lens shutter, so normally the film would be improperly exposed when changing lenses. To prevent this, a light shielding curtain is automatically drawn out by the lens detaching action, covering and protecting the film. Do not press or touch this curtain with fingers or sharp objects.

# 1. Getting started

## 1-3 Attaching strap

## 1-4 Attaching the proper diopter adjustment lens

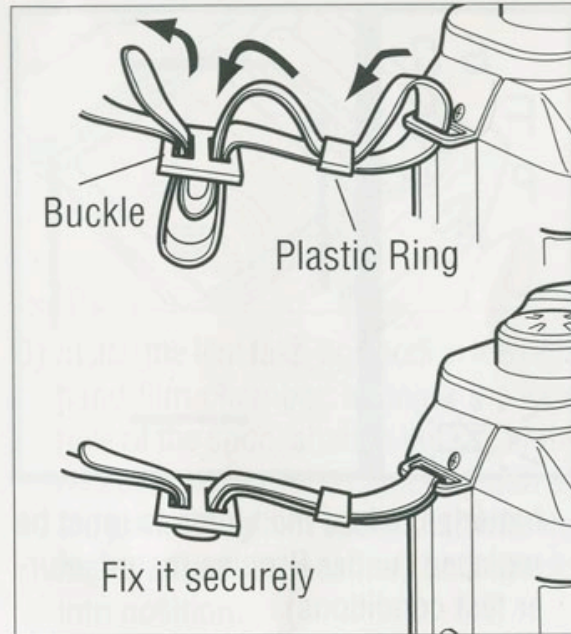
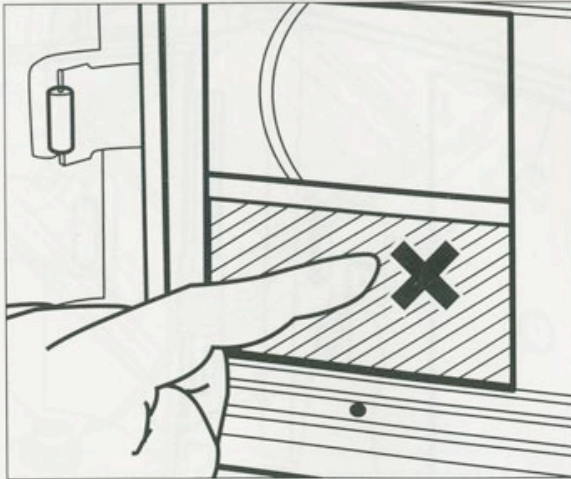

### 1-3 Attaching strap

Three camera strap lugs are provided with this camera. To carry the camera in horizontal position, attach the strap to the upper lugs on both sides. To suspend the camera in a vertical position, use the upper and lower lugs on the right side of the camera body. Follow the procedure illustrated above to thread the strap through the lugs and rings.

Note: Make sure the strap is properly attached to the lugs or the camera may be accidentally dropped.

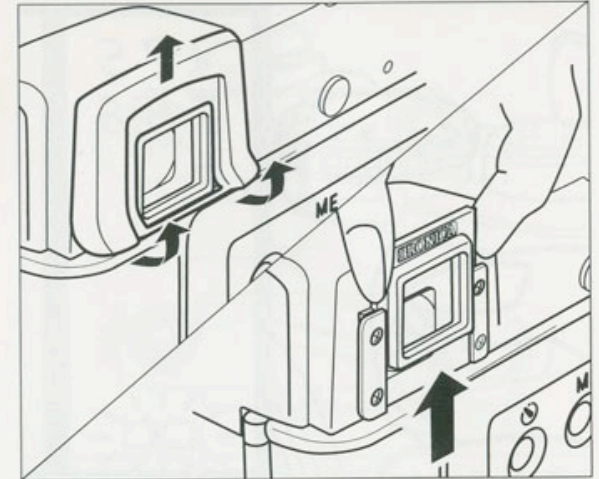

### 1-4 Attaching the proper diopter adjustment lens

1) A set of nine viewfinder eyepiece lenses are prepared as optional accessories, from -5 to +3 diopter, including the normal eyepiece lens of -1 diopter that comes attached to the camera.

-5 -4 -3 -2 (-1) 0 +1 +2 +3  
close view ← standard → far view

2) Detach the rubber viewfinder cup as shown above, and slide the standard viewfinder eyepiece lens out from the eyepiece frame.

3) Replace the proper diopter adjustment eyepiece lens by sliding it into the eyepiece frame. Attach the rubber eyecup.

## 2. Preparing to shoot

### 2-1 Check battery capacity

### 2-2 Loading film

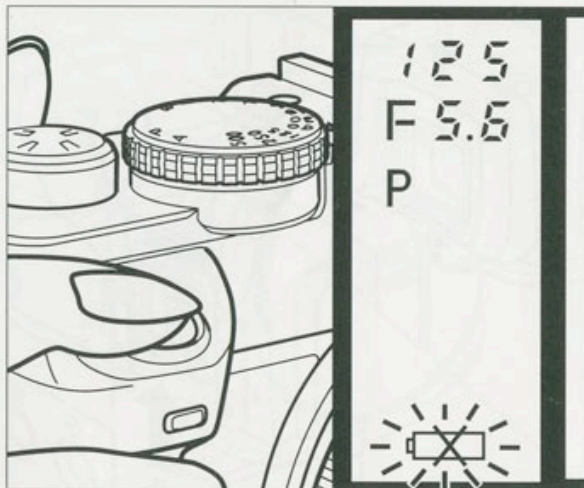

#### 2-1 Check battery capacity

The Bronica RF 645 requires a set of batteries to function, since the camera employs an electronically controlled shutter.

- 1) Check the battery level before each shooting session.
- 2) Turn on the main switch and lightly press the shutter release button while looking through the viewfinder. The battery power is at a satisfactory level for shooting if the LCD on the left side of the viewfinder turns on and the battery warning mark "  " does not appear.

Note 1: Approximately 100 rolls of 120 type film can be shot on a fresh set of

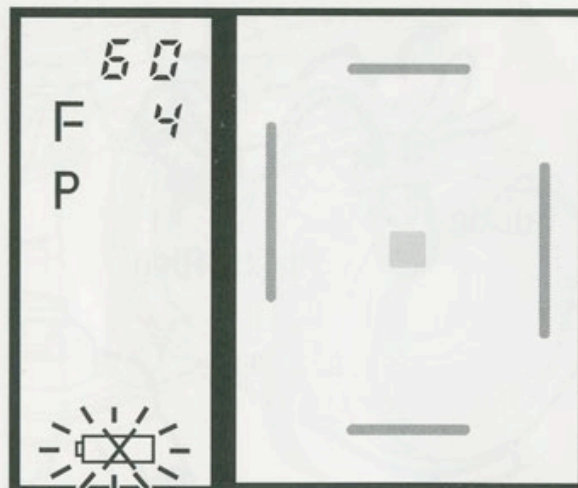

batteries before the batteries must be replaced (under Bronica manufacturer test conditions).

Note 2: Replace depleted batteries with new ones as soon as the battery warning mark begins to blink on the LCD. Low battery capacity may cause the camera to malfunction.

Note 3: If the LCD does not light up or switches off shortly after depressing the shutter release button, it is time to replace the batteries with new ones.



#### 2-2 Loading film

- 1) Choose a suitable film. The Bronica RF 645 can take either 120 or 220 film type. 120 type of film with light shielding back paper takes 16 frames to a roll while the 220 type without back paper takes 32 frames to a roll.

To load the film, open the rear camera cover and set the film type selection lever to either 120 or 220 position according to the film to be loaded. Make sure that the film type display window on the camera back shows the number you set on the lever.

Note 1: Take the cover sheet attached to the film gate section of the camera before loading the very first roll

## 2. Preparing to shoot

### 2-2 Loading film

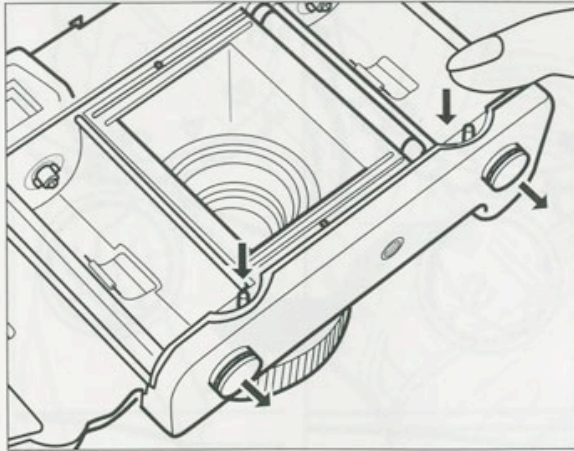

of film you use. The cover sheet is provided to protect the light shielding curtain.

Note 2: When loading a film, first attach a lens on the camera body so that the light shielding curtain opens. This precaution will protect the light shielding curtain from any accidental damage.

2) Depress both left and right side film spool shaft lock release buttons with the camera back open. The shafts pop downward from the bottom of the camera and are identified by red rings.

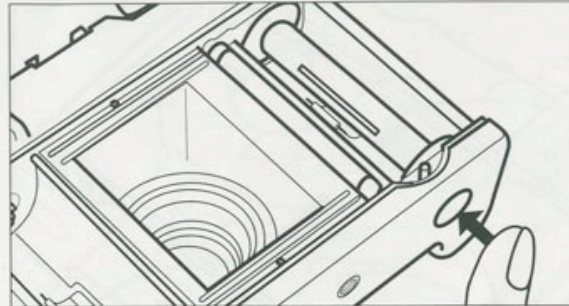

3) Install the film take-up spool in the right hand film chamber, aligning the key-hole of the spool shaft to the key of the receptor shaft of the camera. Push up the protruding film spool shaft into the bottom plate of the camera until it locks into position.

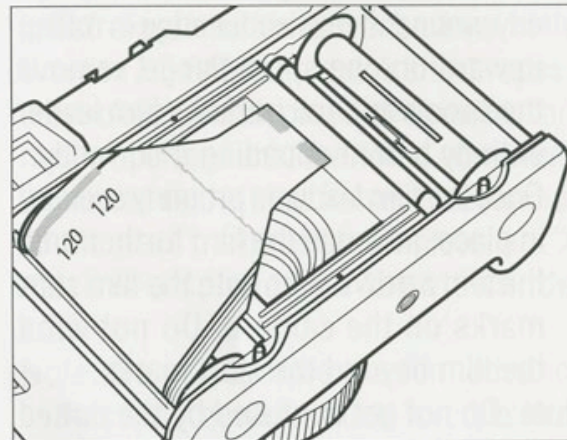

4) Load a fresh roll of film into the left hand film chamber as illustrated in the

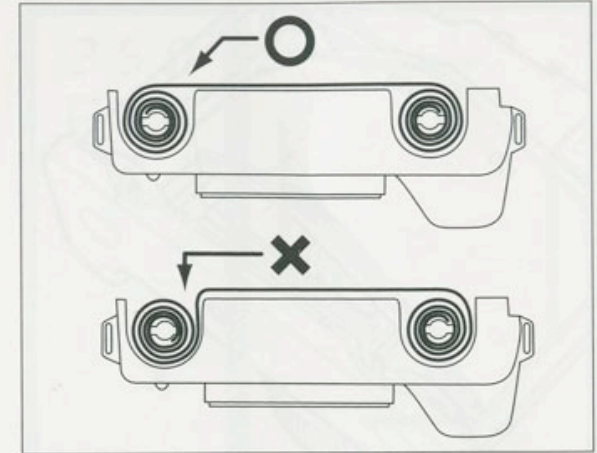

drawing. Ensure that the film leader rolls off the outer edge as shown instead of the inside edge of the film chamber. The inside black surface of the leader must face outward coming out of the chamber. If it faces inward, roll back the film, turn the roll upside down and then reload into the film chamber. Push the fresh film spool shaft into the bottom of the camera.

## 2. Preparing to shoot

### 2-2 Loading film

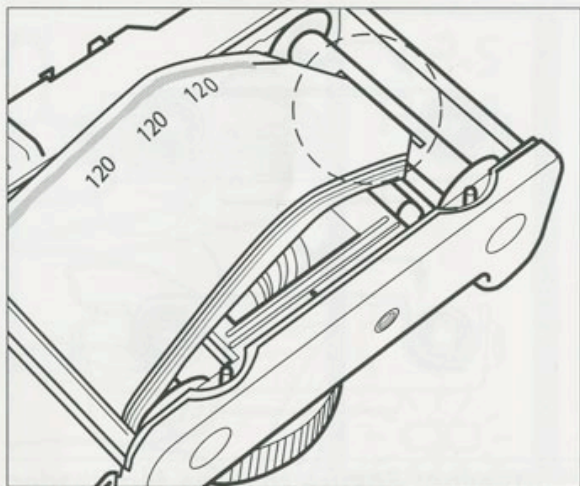

5) Roll out the film leader and insert the leading edge into the slit of the take-up spool shaft as far as possible.

Note: When a take-up spool is already installed in the right-hand film chamber, 2) and 3) procedures described above are not necessary.

6) Advancing the film gradually with short repeated strokes of the film advance

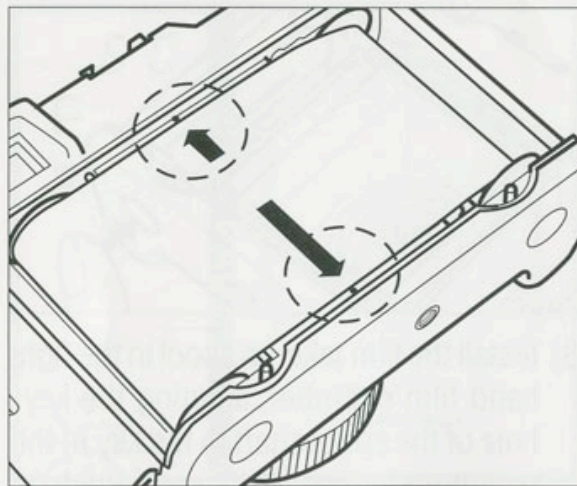
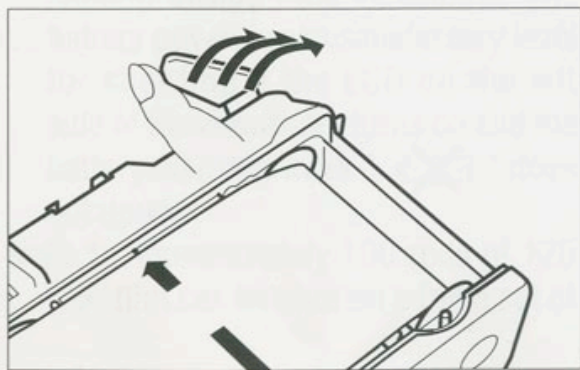

lever, check if the film leader is skewed on the take-up spool. When both film leader edges are evenly positioned between spool flanges, the film is properly wound. If one leader edge is rolling upward on one spool flange, remove the spools and roll back the film leader entirely before reloading it correctly.

7) Once the film leader is properly secured in place, advance the film further until the film arrows align with the film start marks on the camera. Do not wind the film beyond the start marks.

Note: Do not get confused by the dotted line printed on the leader paper of the 220 type of film right in front of the real starting arrow mark for the start mark

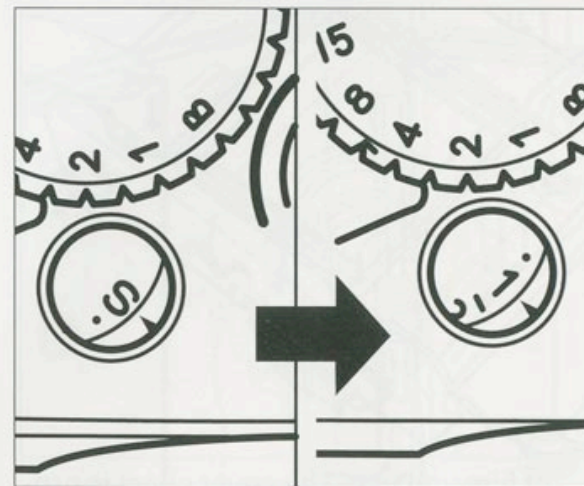

itself.

8) Close the back cover and lock it securely. Operate the film advance lever with few strokes until it stops. At this point, the exposure counter window displays a "1".

Note: After closing the camera back, make

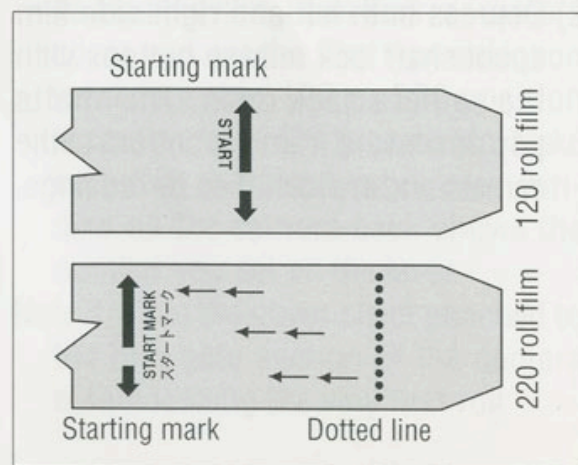

## 2. Preparing to shoot

### 2-2 Loading film

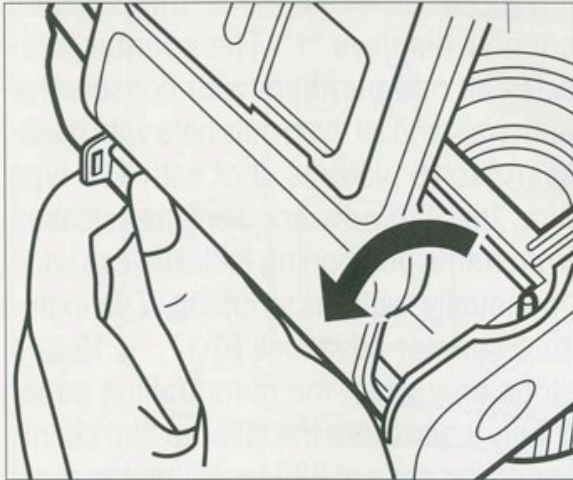

sure both film shafts are completely pressed back into the camera bottom.

**Caution:** Be careful not to pinch your finger or hand between the back cover and the camera body as you open or shut the cover. Be alert to prevent the skin of the hand from being pinched between the back hinge and one of the strap lugs in the rear cover, and to prevent the palm from being pinched between the closing cover and the camera body. Even minor pinching pains may cause you to drop the equipment and damage it. As an added precaution, hold the camera in a secure location during the film loading

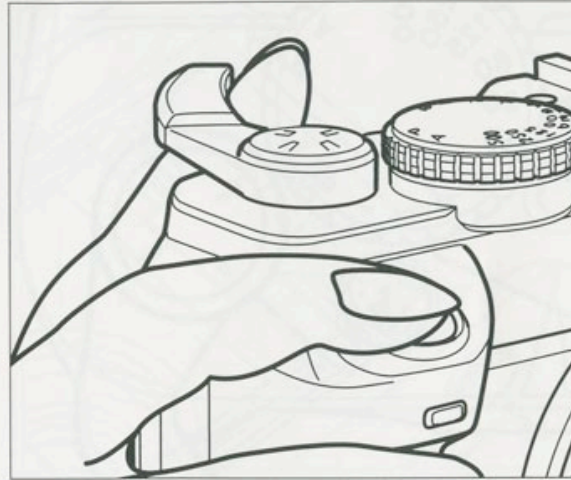

process.

#### **Film winding and ratcheted winding lever**

The film can be advanced either in one full stroke of the film advance lever of the Bronica RF 645 or in quick short repeated strokes. In both cases, the shutter cannot be operated until the film is completely advanced to the next frame. If advancing to the next frame is incomplete, an "X" mark is displayed on the viewfinder LCD.

**Note:** Do not operate the film advance lever too quickly. Such forcible handling may result in skewed film surface or uneven spacing between picture frames.

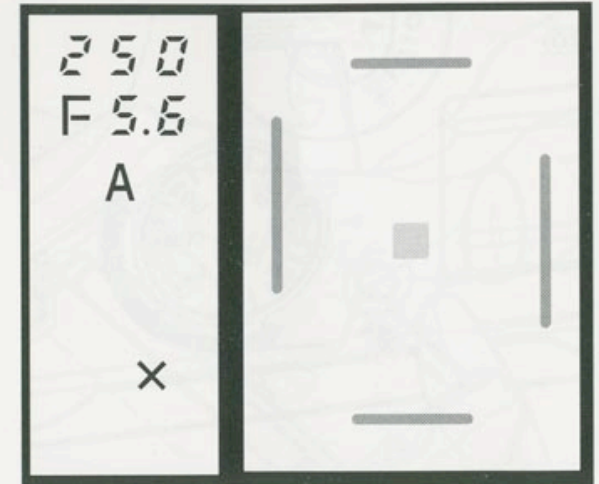

## 2. Preparing to shoot

### 2-3 Setting film speed

### 2-4 Exposure Counter

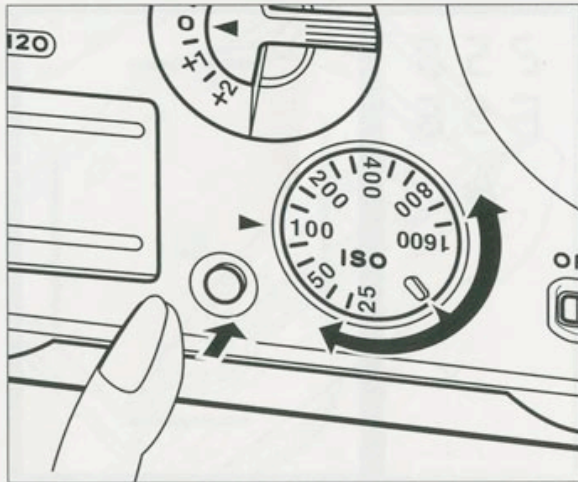

#### 2-3 Setting film speed

- 1) To set the film speed, rotate the film speed setting dial located on the rear operational panel by pressing the film speed setting dial lock release button positioned at the side of the dial. Adjust the speed number on the dial to the exposure index number of the film loaded in the camera. The film

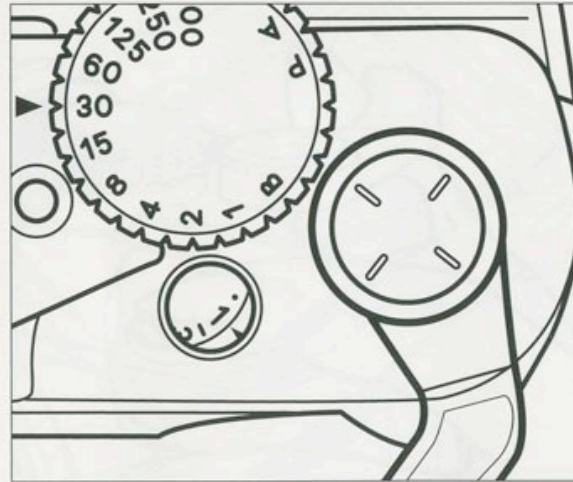

speed setting dial automatically locks as you reduce pressure on the release button.

#### 2-4 Check the number on the exposure counter.

##### 2-4-1 Exposure Counter

The exposure counter resets itself to the "S" (start) position as the camera back is opened. When the fresh film is loaded and

advanced to the first frame, the exposure counter displays "1". The counter indicates all odd numbers with consecutive numerals and all even numbers with dashes. After 16 pictures shot with 120 type film, the film advance lever is released from frame positioning lock and can wind continually without stopping. The exposure counter advances to 17, -, 19 and stops only when the film's trailing paper is fully wound into the take-up film chamber. In the case of 220 type film, the rapid wind lever is released when the film is fully used, and the exposure counter displays "E".

ISO speed	<b>25</b>	32	40	<b>50</b>	64	80	<b>100</b>	125	160	<b>200</b>	250	320	<b>400</b>	500	640	<b>800</b>	1000	1250	<b>1600</b>
Film speed dial scale	<b>25</b>			<b>50</b>			<b>100</b>			<b>200</b>			<b>400</b>			<b>800</b>			<b>1600</b>
DIN speed	<b>15</b>	16	17	<b>18</b>	19	20	<b>21</b>	22	23	<b>24</b>	25	26	<b>27</b>	28	29	<b>30</b>	31	32	<b>33</b>



## 2. Preparing to shoot

### 2-4 Film memo holder, How to remove a used roll of film

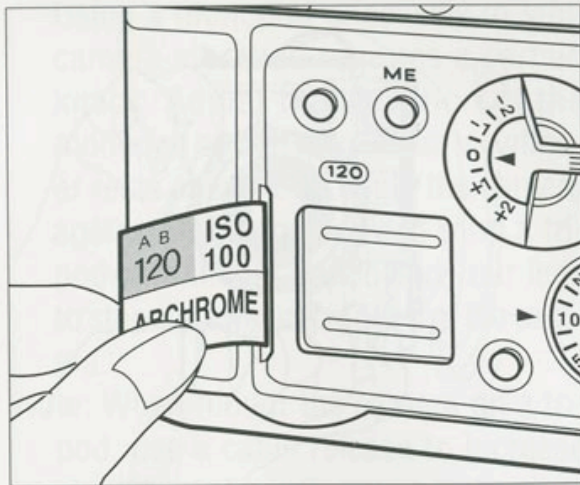

#### 2-4-2 Film memo holder

It may be necessary to reconfirm the type of film being used in the heat of a photo shooting session. To facilitate this, clip off the top or bottom flap of the film box and insert it into the memo holder located on the rear cover of the camera. Make sure to replace the film box flap when a new roll of film is loaded.

#### 2-4-3 How to remove a used roll of film.

- 1) The film advance lever will be released from the frame positioning lock mechanism and wind continually after the 16th frame in the case of 120 type film and the 32nd frame in the case of 220 type film, until the trailing paper is fully

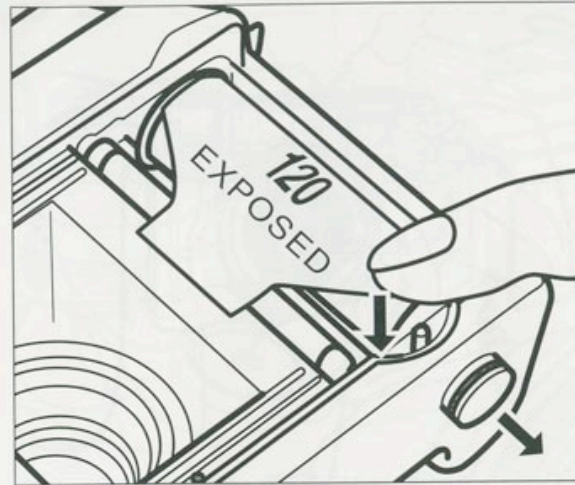

wound into the take-up film chamber. At that point, all the torque is removed from the film advance action.

- 2) Press the rear cover lock release of the camera upward to open the rear cover. Press down on the film spool shaft lock release button and push the top of the film spool lightly as illustrated and remove the spool from the film chamber. Hold the film roll so that the film's trailing light shielding paper does not slacken, and seal the film tightly with the adhesive paper band attached to the film trailing paper.
- 3) Remove the empty film spool from the feeding side film chamber and transfer it to the take-up film chamber in

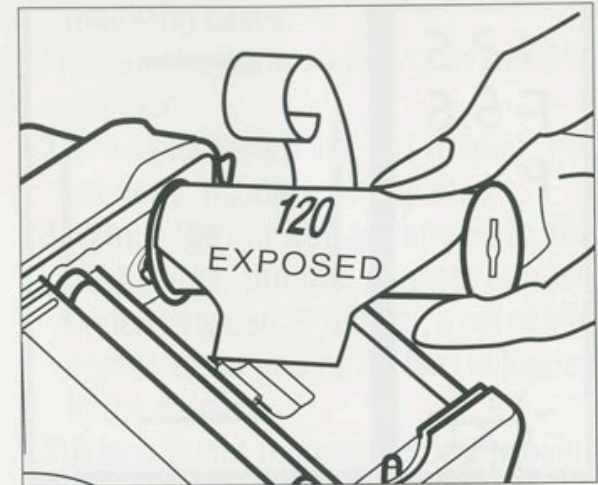

preparation for loading of the next roll of film.

Note: When opening the camera rear cover for film loading and removal, avoid exposing the camera to direct sunlight. Also, handle films in the shade at all times.

## 3. Shooting

### 3-1 Main switch 3-2 Viewfinder 3-2 Holding the camera

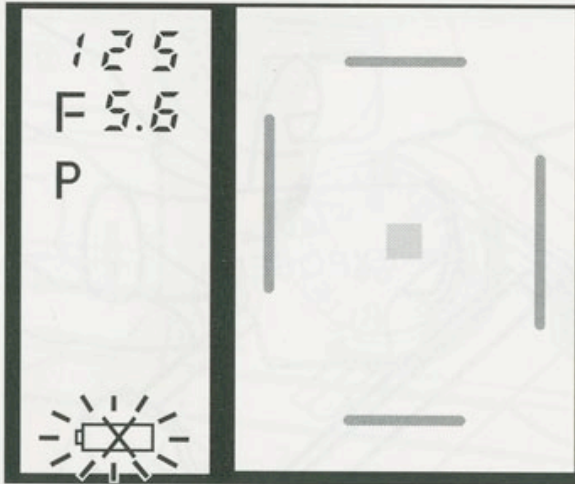

#### 3-1 Main switch

Turn on the main switch and take off the lens cap to prepare for shooting.

#### 3-2-1 Viewfinder

- 1) Check whether the battery warning mark is displayed on the LCD displayed to the left side in the viewfinder field. Also confirm that the proper exposure mode, shutter speed and aperture are set and displayed.
- 2) Bring your subject into focus in the focusing frame.
- 3) Compose a picture within the viewframe.

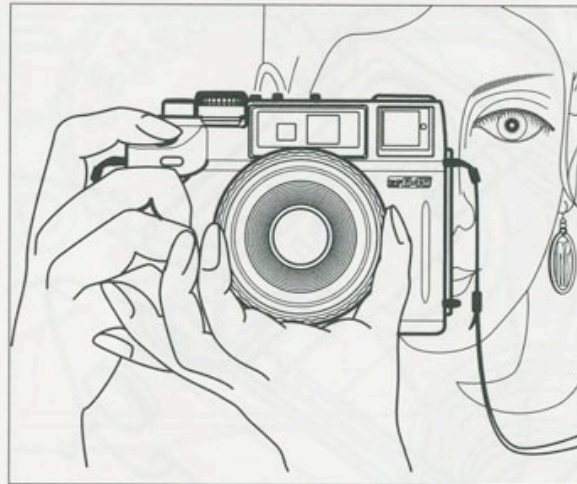

#### 3-2-2 Holding the camera

The Bronica RF 645 is a coupled rangefinder camera. If the view of the rangefinder is obstructed by a hand or other object, the camera cannot focus.

- 1) Holding the camera for a vertical composition  
Hold the camera normally as illustrated, and a vertical picture can be photographed.
- 2) Holding the camera for a horizontal composition  
Hold the camera with your right hand and turn the camera 90 degrees as illustrated, orienting the camera grip toward the bottom. Rotate the focusing ring with your left hand, being careful not

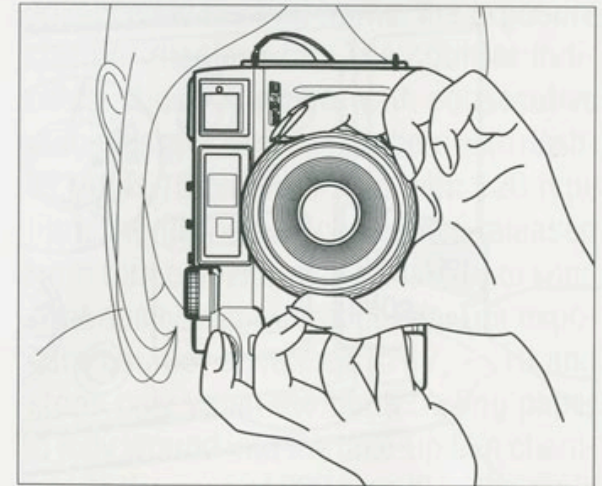

to obstruct the rangefinder view with your fingers or the camera strap.

- 3) Taking advantage of a tripod or a monopod

The difference between sharp pictures and shots blurred by a camera shake is one second away. When using a 100-mm lens, 1/100 sec. is the limitation for holding the camera steady. A faster shutter speed is strongly recommended for shooting with a medium format camera, since this unit is larger and heavier than a 35-mm camera. If a shutter speed slower than 1/60 second is required when using a 65 mm, a tripod or monopod is highly recommended.

## 3. Shooting

### 3-2 Holding the camera

Using a monopod effectively to stop camera vibration requires a certain knack. Adjust the elevation of the monopod so that the camera viewfinder rests at eye level. Hold the camera against your forehead and form a tripod with the monopod and your legs to stop the swaying motion of the camera.

Note: When mount the camera on a tripod, use a cable release to increase stability of the unit.

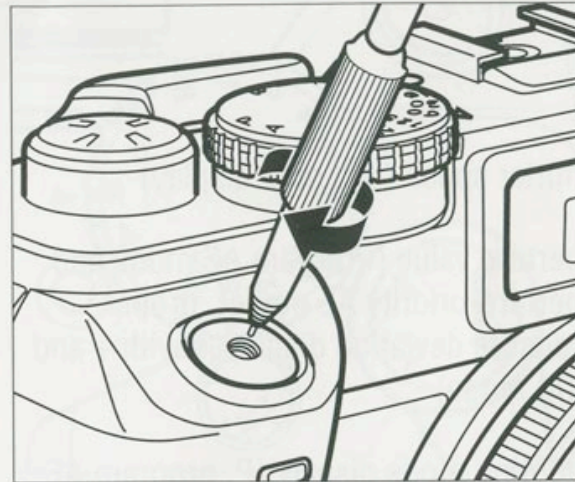

#### 3-3-1 Shutter release button

- 1) The Bronica RF 645 applies an electromagnetic release, and therefore requires batteries to operate the shutter mechanism.
- 2) The viewfinder LCD is automatically activated with the shutter release button pressed halfway. The next stroke triggers the shutter itself.
- 3) When released, the shutter opens and shuts with light clicking sounds followed by a low motor noise as the shutter cocks for the next shot.

Note 1: A standard mechanical cable release can be attached to the shutter release button of the Bronica RF 645.

Note 2: The shutter will not operate in the

### 3-3 Shutter release button

following cases.

- (1) When the main switch is in the OFF position.
- (2) When batteries are not loaded, not properly installed, or depleted.
- (3) When film is not advanced to the next frame, the film counter is positioned between "S" and "1", a roll of film comes to an end or no film is loaded in the camera.
- (4) A lens is not mounted or not properly locked in position.

Note: An "X" symbol is displayed in the viewfinder LCD in cases (3) and (4). Refer to the drawing on page 19.

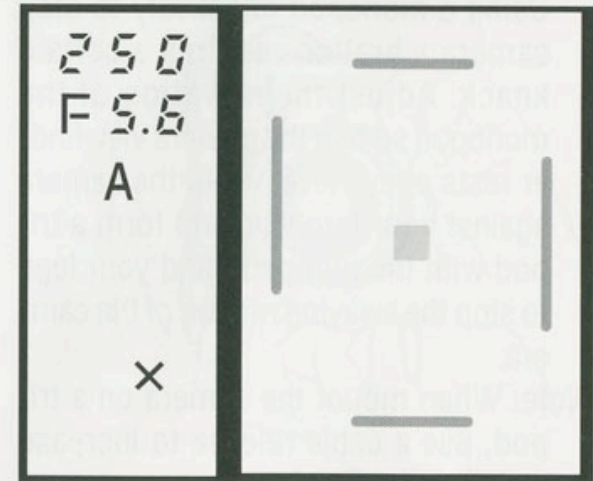
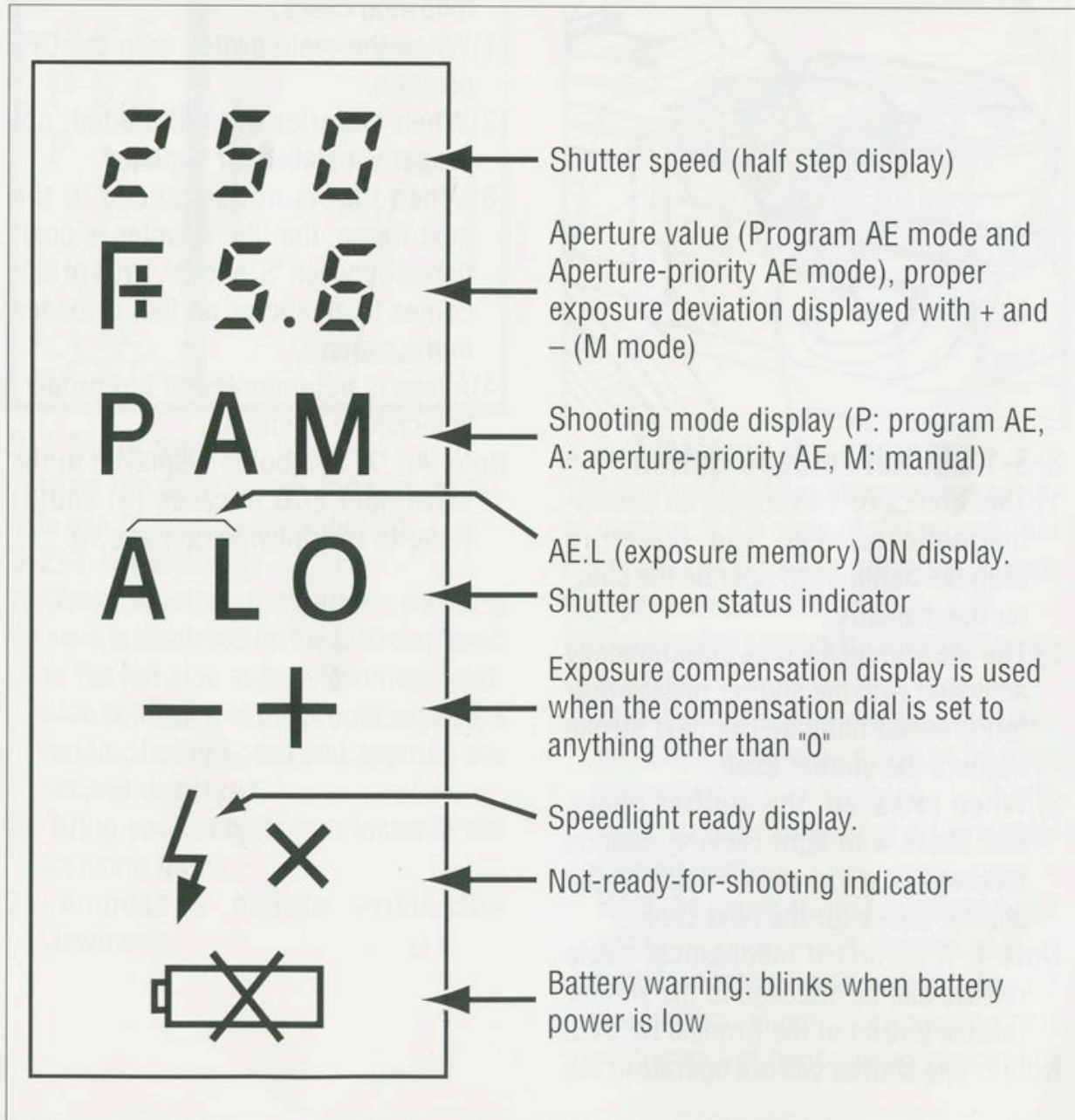

### 3-3-2 Viewfinder display

The viewfinder contains the following displays:

- 1) An LCD panel to the left of the viewfinder field,
- 2) Viewfinder bright frame display, and in its center, a focusing frame with dual superimposed images.

Note: The bright frame displays shift automatically corresponding to 65mm or 100mm lens when attached.

# 3. Shooting

## 3-3 Viewfinder display

## 3-4 Exposures 3-4 Shutter dial and lens aperture operations

View frame at 65mm Lens

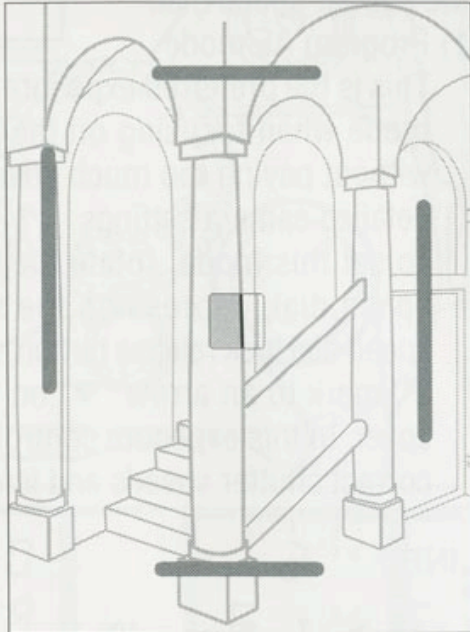

View frame at 100mm Lens

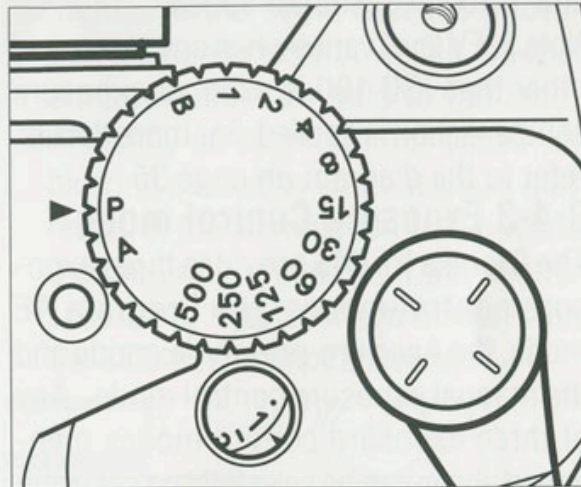
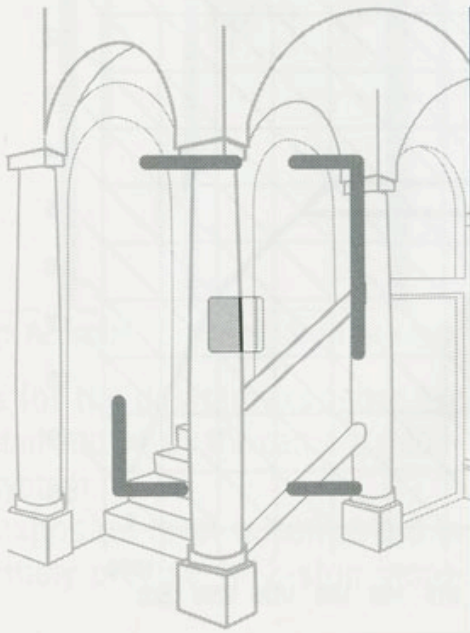

### 3-4-1 Shutter dial and lens aperture operations

Photographing modes and the shutter speeds can be selected on the shutter speed dial located on the top of the Bronica RF 645 main camera body. "P" represents Program AE mode, "A" designates Aperture-priority AE mode, while "B" indicates bulb mode, in which the shutter remains open as long as the shutter release button is pressed. The shutter dial is locked in these three positions to prevent unintentional changing of the setting.

Press down on the shutter speed dial lock release button while rotating the shutter dial between these three shooting mode

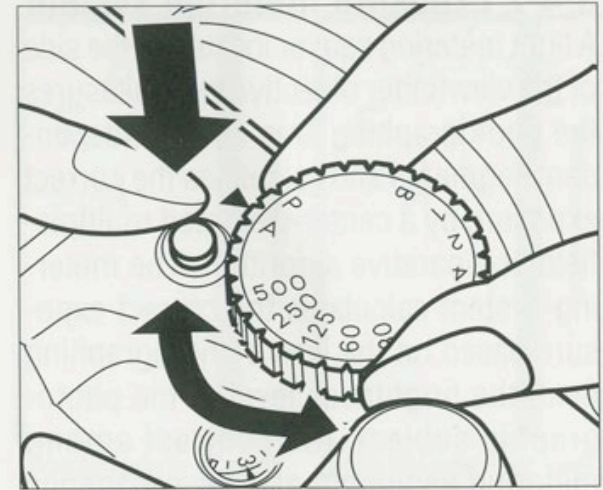

settings.

The numerals 1 to 500 on the shutter speed dial represent shutter speeds or exposure times expressed in reciprocals. In other words, "500" actually means 1/500 second and "60" is 1/60 second.

The lens aperture can be set by rotating the lens aperture ring. The 65mm lens provides an aperture range of f/4 to f/32. Between any two f-numbers, there is an intermediate stop. Align an f-number or an intermediate stop with the distance/aperture index line to set the aperture as required.

# 3. Shooting

## 3-4 Exposures

### 3-4 Exposure Control Mode 3-4 Program AE mode

#### 3-4-2 Exposure metering system

A light metering sensor located to the side of the viewfinder objective lens measures the photographing area in five independent segments and calculates the correct exposure by a center-weighted multiple-field comparative algorithm. The metering system calculates the correct exposure based on the lens's photographing field, the brightness level of the photographic subject, the contrast among metering segments and miscellaneous factors to achieve the best photographic image reproduction. Refer to Figres on page 36 for the metering pattern.

Note 1: The impact on exposure settings of any filters attached to the lens must be taken into consideration to determine the correct exposure when compensating for the exposure determined by the external metering system of the Bronica RF 645. Note 2: The metering range of the Bronica RF 645 is from EV 3 to EV 18 with the 65mm standard lens at ISO 100. EV 3 (at ISO 100) is an exposure level designated by a combination of f/4 aperture and 2 second shutter speed. EV 18 (at ISO 100) is an exposure level designated by a combination of f/22 aperture

and 1/500 sec. shutter speed.

Note 3: EV level varies when any film speed other than ISO 100 is used, or exposure compensation is applied. For more details, refer to the diagram on page 35.

#### 3-4-3 Exposure Control mode

The Bronica RF 645 provides three exposure control modes: the Program AE mode, the Aperture-priority AE mode and the manual exposure control mode. Any of three exposure control modes mentioned above can be selected and set using

the shutter speed dial.

#### 1) Program AE mode

This is the preferred exposure control mode when focusing on the subject without paying too much attention to detailed camera settings.

To set this mode, rotate the shutter speed dial, depressing the shutter speed dial lock release button, to align "P" mark to an arrow "▼" on the top cover. In this exposure control mode, correct shutter speeds and lens aper-

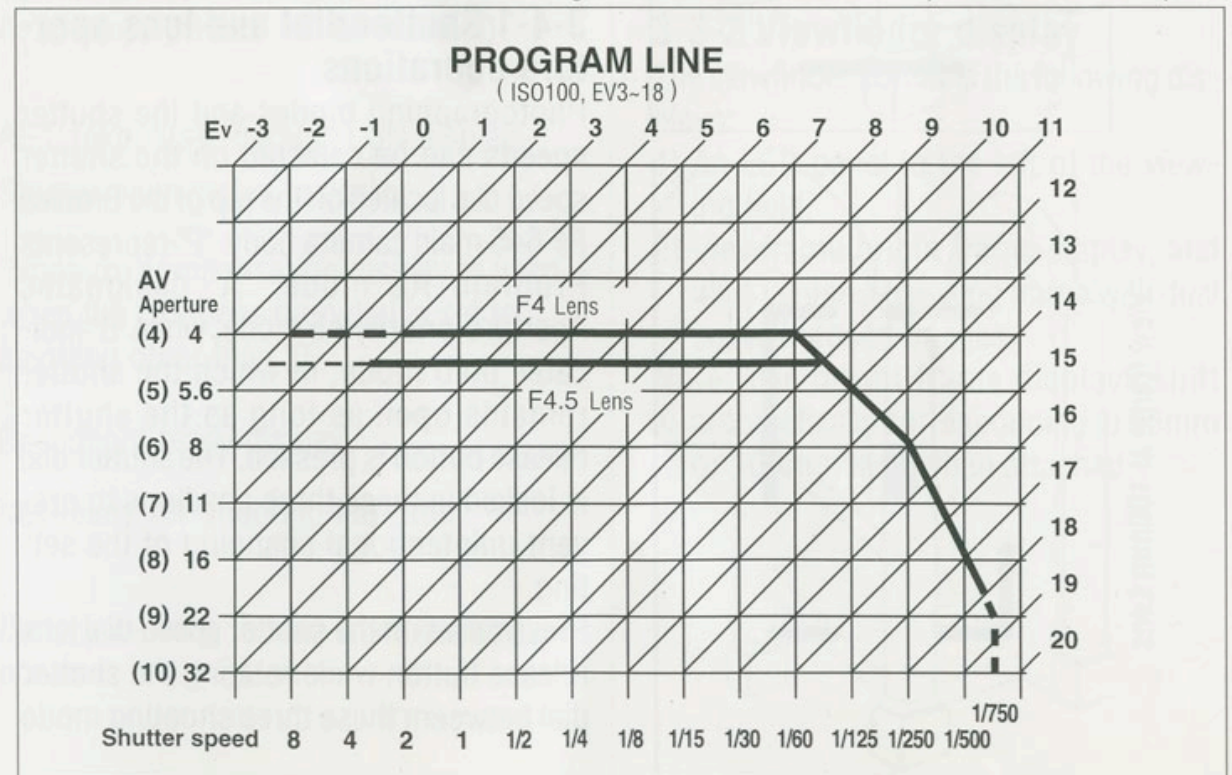

# 3. Shooting

## 3-4 Exposures

### 3-4 Exposure Control Mode 3-4 Aperture priority AE mode

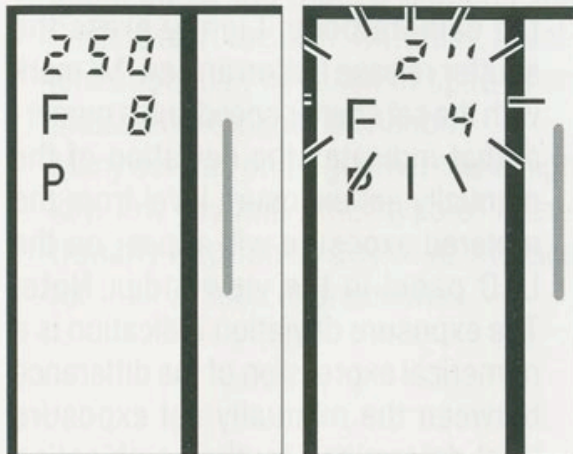
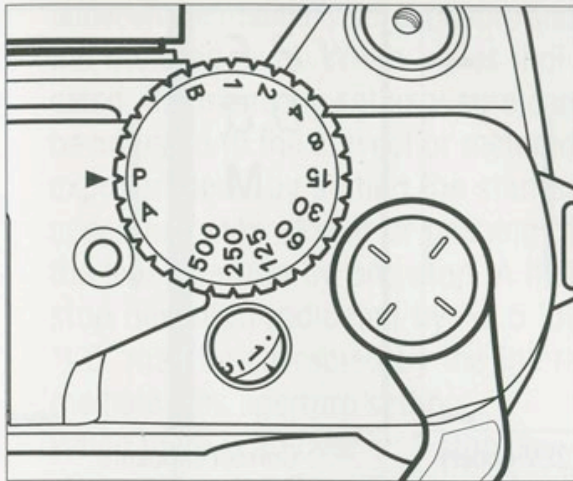

Program AE mode

Outside the Shutter Speed Range

tures for the desired exposure are selected and set by the camera's control system.

The exposure level is controlled in extremely precise 1/12-stop incre-

ments. In the event that the photographic subject is not well lit, special attention must be paid to the automatically selected shutter speed, or blurring caused by camera shake may result. If the illumination falls outside the metering range, both the shutter speed and lens aperture displays on the LCD flash simultaneously.

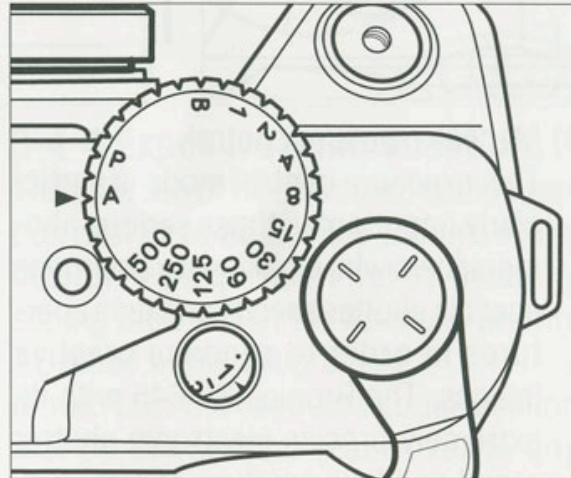

#### 2) Aperture priority AE mode

This is an automatic exposure control mode applicable to the most variable photographic situations. To set on the mode, rotate the shutter speed dial while pressing the shutter dial lock release button, and align "A" mark to the arrow "▼" on the top cover. An f-

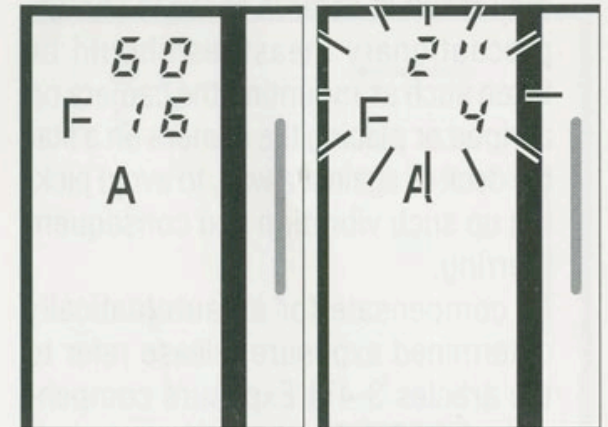

Aperture priority AE mode

Outside the Shutter Speed Range

number is then manually set on the lens aperture ring. For a shallow depth of field to obtain an out-of-focus background for portrait photography, select a small f-number (a large lens opening). Alternatively, to photograph the background in sharp focus for landscape photography, for example, select a large f-number (a small lens opening).

The Bronica RF 645 controls the exposure level in extremely precise 1/12-stop increments. Carefully observe the automatically selected shutter speed displayed on the LCD in the viewfinder when the subject area is comparatively dark. If a slow shutter speed that

## 3. Shooting

### 3-4 Exposures

### 3-4 Exposure Control Mode 3-4 Manual Exposure Control

may result in camera shake is shown, precautionary measures should be taken such as mounting the camera on a tripod or placing the camera on a stable deck or against a wall, to avoid picking up such vibration and consequent blurring.

To compensate for an automatically determined exposure, please refer to the articles 3-4-4 Exposure compensation and 3-4-5 AE lock. If proper shutter speed cannot be selected for the manually set f-number due to subject brightness that is out of metering range, the shutter speed display on the LCD flashes.

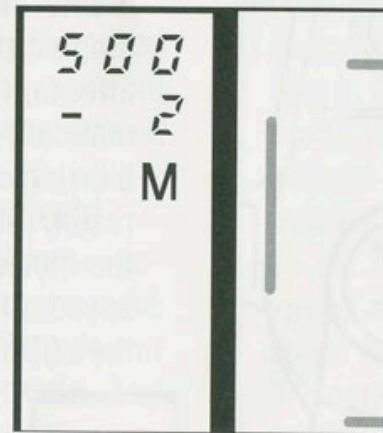
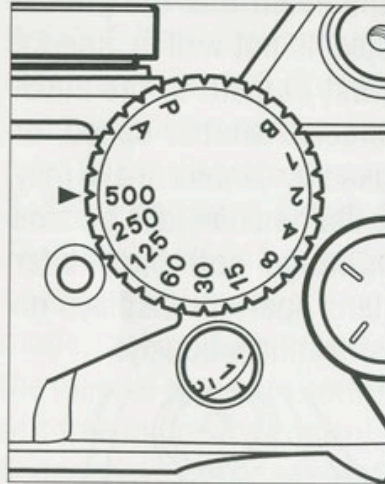

Manual exposure (2EV under)

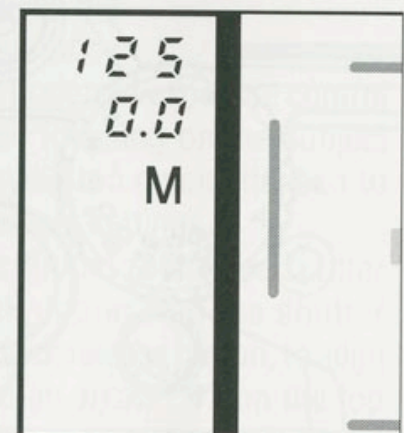

Correct exposure

#### 3) Manual exposure control

This exposure control mode is particularly important to those serious photographers who intentionally determine specific shutter speeds and lens apertures in order to produce creative images. The Bronica RF 645 with its extremely precise electronic shutter speed and lens aperture control systems makes an ideal manual exposure control camera.

To set the manual exposure control mode (from "P" or "A" modes), rotate the shutter speed dial while pressing the shutter speed dial lock release, and align the desired setting from the numerals 1 to 500 (1 to 1/500 sec.) with the arrow "▼" mark on the top of

the camera body. Lightly press the shutter release button and an "M" mark with the set shutter speed and a numeral that indicates the deviation of the manually set exposure level from the metered exposure will appear on the LCD panel in the viewfinder. Note: The exposure deviation indication is a numerical expression of the difference between the manually set exposure level determined by the combination of the set shutter speed and the f-number and the exposure level determined by the camera's metering and correct exposure calculation system. The exposure deviation is indicated in 1/2 stop increments up to  $\pm 3$  stops. When "0" is displayed there is no difference



## 3. Shooting

### 3-4 Exposures

### 3-4-4 Exposure Compensation

between the manually set exposure and the metered level. When "-1" is indicated, the manually set exposure can be adjusted to the correct or metered exposure level by setting the shutter speed one stop slower or opening of the lens aperture by one stop. A half stop deviation indicated by "-2.5" or "1.5" may be corrected by the intermediate lens aperture setting. When there is an over  $\pm 3$  stop deviation, either the 3 or -3 numeral will flash to alert the user. Naturally, excellent shots can be taken in spite of an indicated exposure deviation. Many serious photographers take high key, low key and other type of intentionally exposure-deviated images for their artistic expressions.

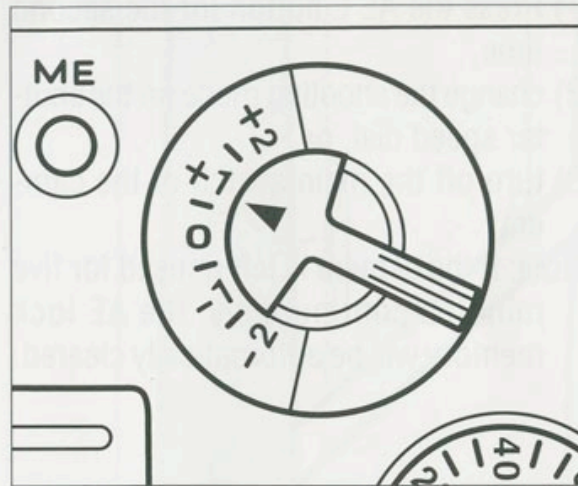

#### 3-4-4 Exposure compensation.

The purpose of the exposure compensation dial is to adjust the automatically determined exposure level by manually setting the value in the Aperture-priority AE mode or the Program AE mode. Turn the exposure compensation dial on the camera rear cover to any desired amount within the  $\pm 2$  stop compensation range, graduated in 1/2 stop increments. All exposures will be adjusted by that amount until the exposure compensation dial is turned back to "0" point. There is a strong click stop at "0" position and light click stops are present at all other graduated positions. When an exposure compensation is applied, a "+" or "-" warn-

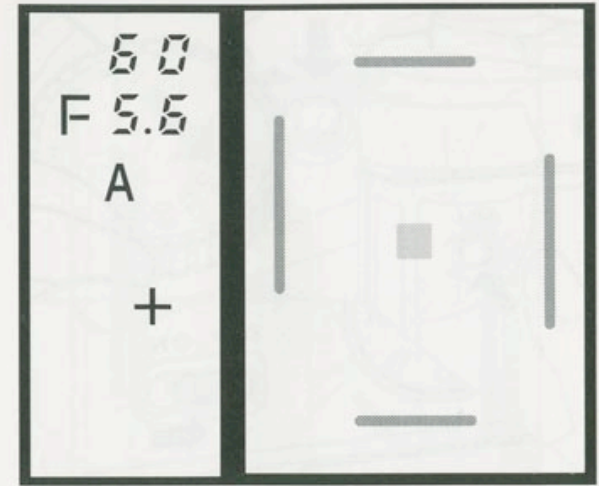

ing symbol is illuminated in the viewfinder LCD panel. It is important to remember there is no numerical indication for exposure compensation.

Note: Once the exposure compensation is completed in a photo session, do not forget to return the exposure compensation dial to the original "0" position.

## 3. Shooting

### 3-4 Exposures 3-5 Focusing

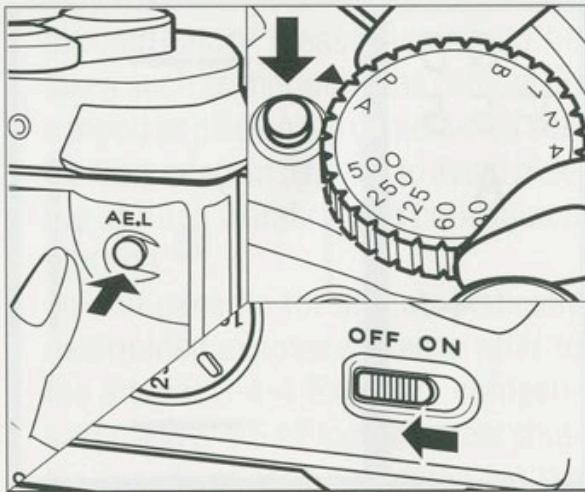

#### 3-4-5 AE lock

The AE lock system is a useful tool to obtain the correct exposure on a limited portion of the subject area. Close in on the subject and point the camera toward the area where the exposure must be correctly metered, then press the AE L button. The metering system of the camera stores the brightness level of that particular portion of the subject and displays an "AL" symbol on the LCD panel. The AE L button does not need to be pressed continually to maintain the metered exposure. The camera stores this metered brightness level for five minutes. To cancel the meter reading in memory, choose one of the actions described below.

- 1) Press the AE L button for the second time,
- 2) change the shooting mode on the shutter speed dial, or
- 3) turn off the main switch of the camera.

Note: If the camera is left unused for five minutes continuously, the AE lock memory will be automatically cleared.

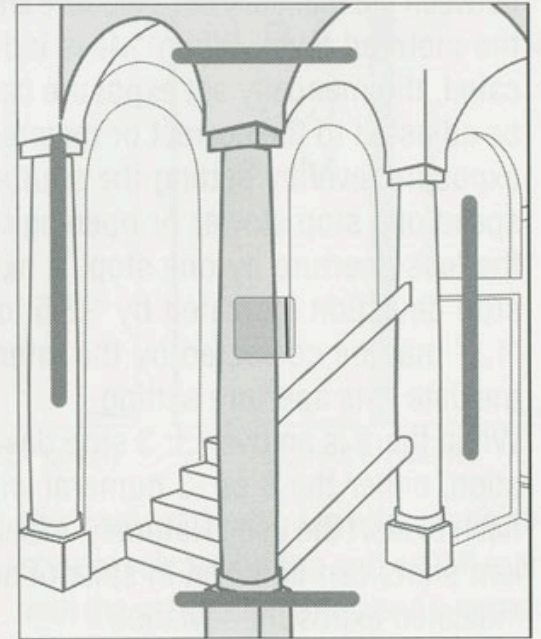

#### 3-5 Focusing

The Bronica RF 645 is a coupled-meter rangefinder camera in which focus is achieved by superimposing two viewfinder images obtained by two independent rangefinder windows.

- 1) Point the camera toward the subject so that the focusing portion of the subject fits into the focusing frame of the viewfinder. When the subject is not in sharp focus, two poorly contrasted, partially overlapped images will be seen in the focusing frame.

## 3. Shooting

### 3-4 Exposures

### 3-6 Automatic Parallax Compensation

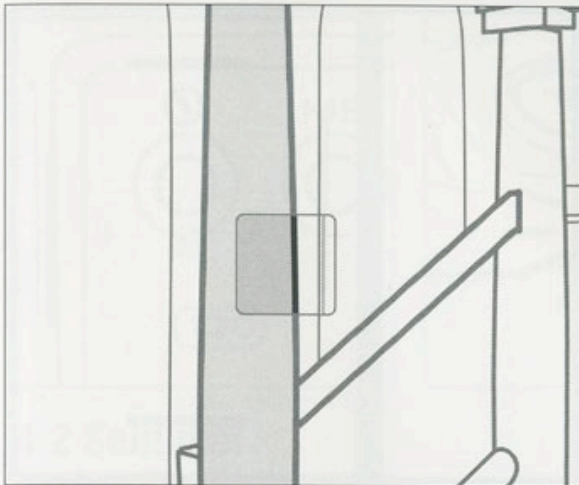

2) Focus by superimposing the two images. As the focusing ring is rotated with the camera held normally (i.e. vertically oriented), one of the images in the focusing frame slides sideways in response to the lens movement. Rotate the focusing ring further until both images in the focusing frame of the viewfinder align perfectly. The image contrast will become noticeably sharp when the two images superimpose precisely. That is the point where the lens critically focuses on the subject.

3) Split image focus:  
Split-image is an image divided into upper and lower halves. Human vision

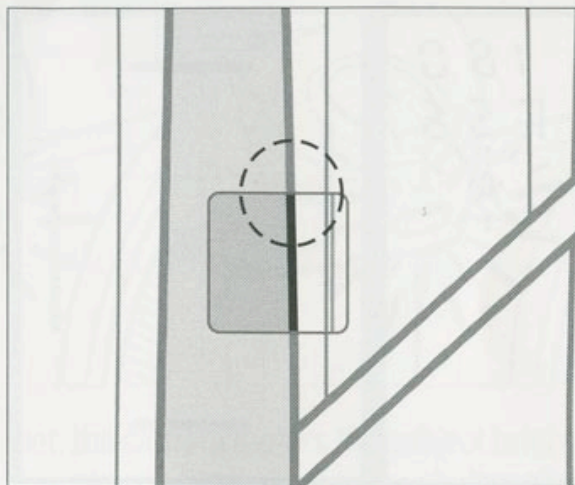

naturally perceives the most critical image matching when comparing the alignment of edges in a split image. The optical system of the Bronica RF 645 is so constructed that the sliding side image in the focusing frame is decisively sectioned at the upper and/or lower edge of the focusing frame. By aligning the edge of the moving image with the connecting edge (or lower part) of the stationary image, the lens can be very precisely focused on the subject.

### 3-6 Automatic parallax compensation

The viewframe of the Bronica RF 645 finder automatically compensates for the par-

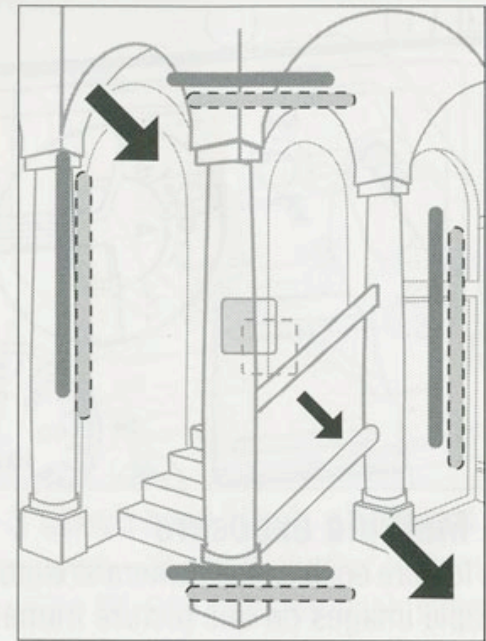

allax between the shooting lens and the viewfinder angle by compensating its position and viewing frame relative to the focusing distance. When mounting a 65mm or 100mm lens, focus on a moderately distant object. The angle of view of the bright frame in the viewfinder will shift toward the lower right hand corner of the viewfinder frame. The area enclosed by the bright frame, when focus is achieved, represents the area to be photographed.

## 4 Other features

### 4-1 Multiple Exposure

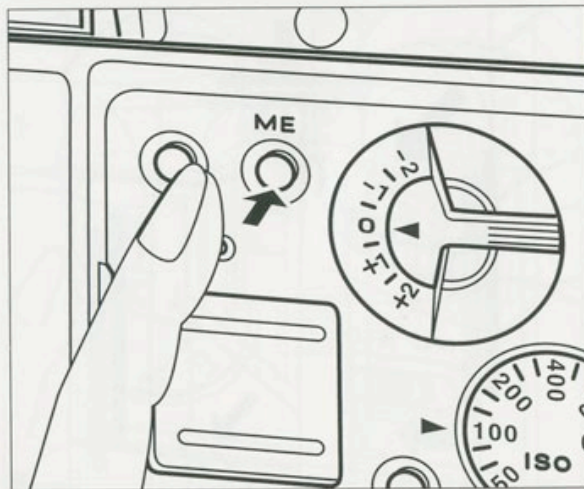

#### 4-1 Multiple exposure

This feature enables the camera to expose multiple images on one picture frame.

- (1) Firstly, take an image that forms the base of multiple exposures.
- (2) Looking through the viewfinder, make sure the LCD panel is activated. Then press the ME button on the back of the camera. Note: The ME button does not work if pressed while the LCD panel is not active. Press the shutter release button lightly and operate the ME button while the LCD is active.
- (3) The second image is exposed on the same picture frame as the shutter button is clicked. Repeat (2) and (3) consecutively to take as many exposures

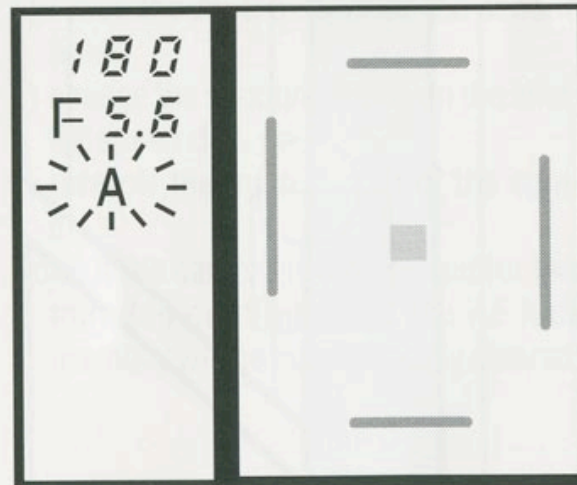

Multiple exposure Indication

as desired on one picture frame. Note 1: The ME button electronically cancels out the shutter release button lock system. Five second after pressing the ME button, the canceling effect of the ME button will be cleared, the shutter button will be locked, and the LCD will switch off once again.

Note 2: There is no exposure compensation feature in the Bronica RF645 for multiple exposure mode.

Multiple exposure therefore results in overexposure. Exposure must be calculated by the photographer in accordance with image composition. Note 3: Do not press the ME button during



ME button does not work

film advancing. This will cause incorrect film winding and cause a partially overlapped picture.

Note 4: The ME button may be activated when the camera is operated without loading a roll of film. One depression on the ME button enables the camera to operate its shutter just one time.

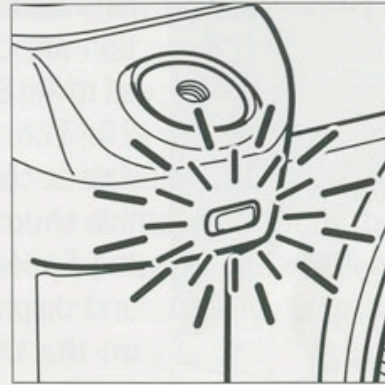
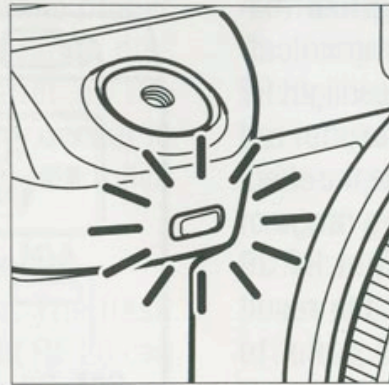
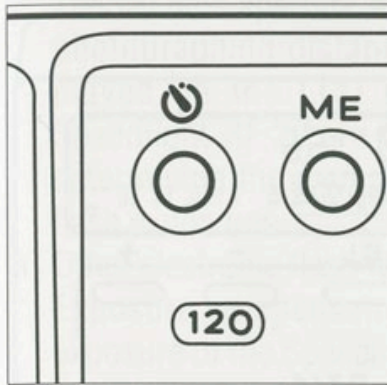

#### 4-2 Selftimer

The selftimer button on the camera back designated by the "  " symbol activates a delayed shutter release, bypassing the shutter release button. The shutter speed indicated in the LCD panel will switch to the selftimer display where the counter begins counting down a ten second delay time. At the same time, an LED located at the front of the camera grip begins to flash. The LED flashing accelerates two second prior to the shutter release, indicating the shutter release timing. To cancel the activated selftimer operation, press the selftimer button for a second time or turn off the main switch to achieve the same effect.

Note 1: If either program AE mode ("P") or the aperture-priority AE mode (A") is

set, the camera meters the subject brightness immediately before the shutter click and the exposure is controlled correctly. Note 2: The selftimer cannot be activated when the shutter dial is set to "B", the main switch is turn off, the battery is depleted, or the exposure counter is set between "S" and "1".

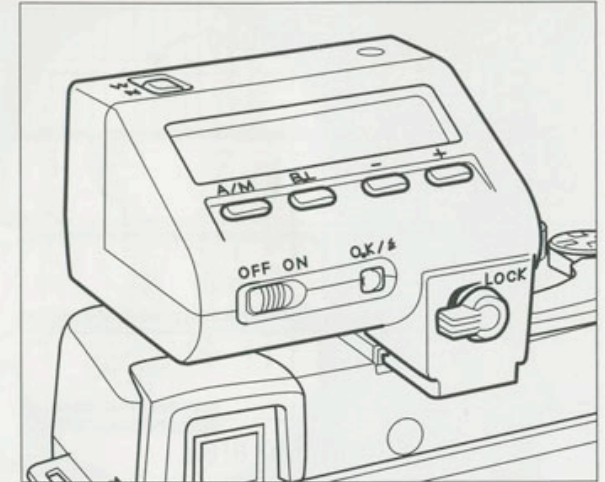

#### 4-3 Electronic flash photography

Equipped with a lens shutter system, the Bronica RF 645 features flash synchronization at all shutter speeds. Connect an electronic Speedlight unit to either the hotshoe or the sync terminal located at the front of the camera. When the dedicated Bronica Speedlight RF 20 is mounted on the hotshoe, vital data such as film speed, set lens aperture setting and exposure compensation factor will be transmitted between the flash unit, the camera body and the lens to control the flash exposure correctly.

- 1) Automatic shutter speed adjustment  
Provided that the shutter speed dial is set to "P" (Program AE mode), the

## 4 Other features

### 4-3 Electronic Flash Photography

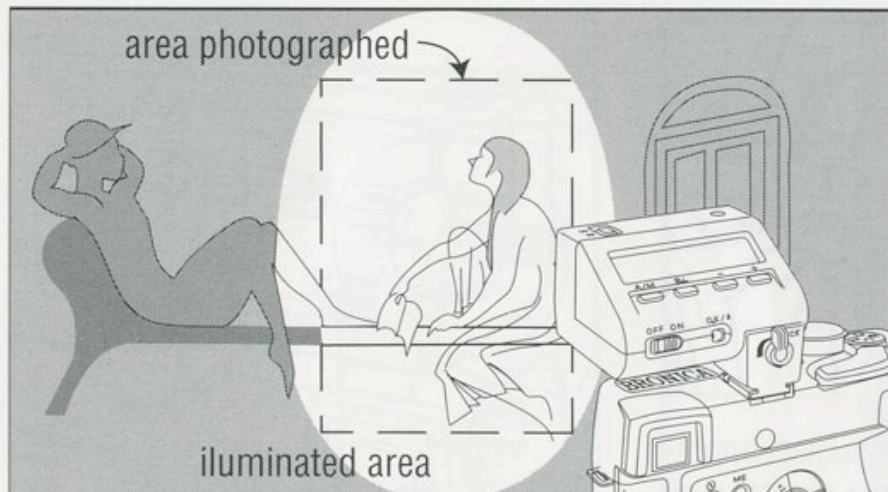

shutter speed is automatically set at 1/60 second for the 45mm and 65mm lenses and at 1/90 second or faster in accordance with the program line for the 100 mm lens as the Speedlight RF 20 completes its cycle.

Note: The shutter speed is not automatically adjusted if the camera is in the Aperture-priority AE mode or the manual exposure control mode. Care should be exercised to avoid picking up camera shake if the unit is set to a slow shutter speed.

- 2) Automatic lens aperture and film speed settings  
Through dedicated electronic contacts on the hotshoe, the film speed and the

lens aperture information are communicated to the Speedlight RF 20. The transferred data calculate the effective shooting range of the Speedlight RF 20 and display the result on the LCD panel to prevent exposure control mistakes that are common in flash pho-

tography. Unlike most external flash metering systems, the Bronica RF 645 / Speedlight RF 20 combination does not place any limitations on lens aperture selection in flash photography. This unlimited utilization of the lens aperture is extremely effective in the adjustment of the distance range and depth of field control in flash photography.

- 3) Manual flash exposure control  
The Bronica Speedlight RF 20 controls the flash light intensity manually in six steps from 1/1 to 1/32 in one-stop increments. Apply this manual flash exposure control for accent flash illumination, e.g.: to highlight a model's

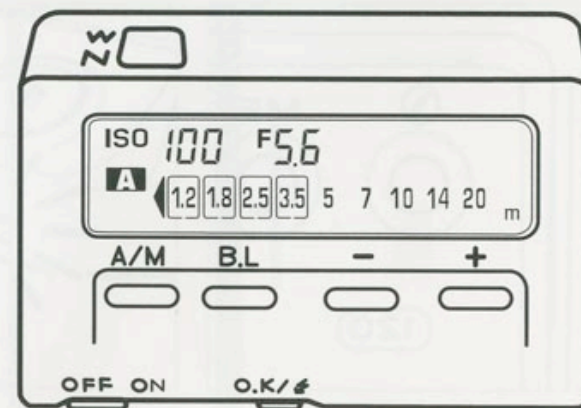

LCD display (Speed light RF 20)

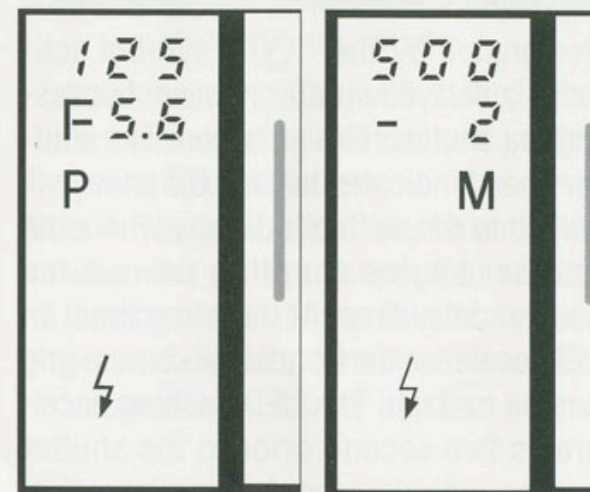

View finder display  
left: P mode, right: M mode

eyes, to illuminate the subject with constant flash power regardless of the ambient illumination or to illuminate a subject located at a specific distance.

## 4 Other features

The set lens aperture and the proper photographing distance range displayed on the LCD panel of the Speedlight RF 20 are very useful in determining the manually controlled flash exposures.

### 4) Other electronic flash features

- \* Exposure compensation: The flash exposure of the Speedlight RF 20 can be compensated from -3 to +2 stop in 1/2-stop increments according to the subject's reflectivity.
- \* Backlit LCD: For insufficient lighting, the LCD panel of the Speedlight RF 20 can be illuminated from the back for better legibility.
- \* Illumination angle adjustment: Two illumination angles for the 65 mm lens, the normal illumination angle, and the 45mm lens, the wide illumination angle, are provided with the Speedlight RF 20.

Note: The illumination range of the Speedlight RF 20 is a vertically-oriented rectangular area.

## 4-4 Long exposure photography 4-5 Infrared Photography

### 4-4 Long exposure photography

The longest nominal shutter speed of the Bronica RF 645 is eight full seconds. If a longer exposure is required, set the shutter speed dial on bulb ("B"). The electronically control shutter system of the Bronica RF 645 stops consuming battery power at one second after the shutter click in bulb operation in order to conserve battery. Still, it is strongly recommended to carry backup battery cells if repeated long exposures are anticipated.

Note 1: The viewfinder LCD displays "BUL" as the shutter dial is set on "B".

Note 2: Never try to remove the lens from the camera during a long exposure.

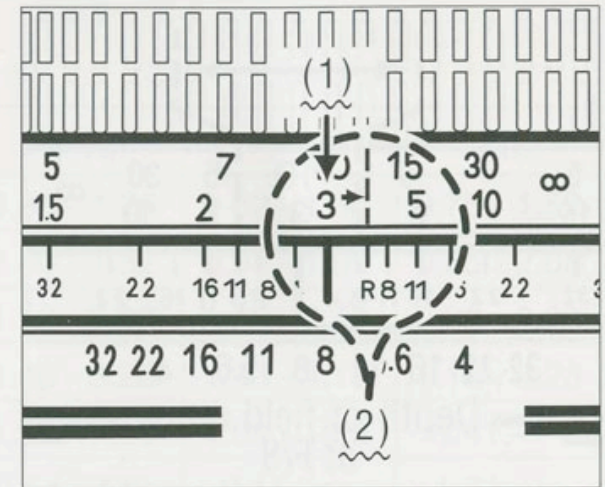

### 4-5 Infrared Photography

To photograph with a monochrome infrared film, follow the procedures described below.

- (1) Focus normally. Note the location on the distance scale corresponding to the distance scale index line.
- (2) Rotate the focusing ring slightly to shift the focus point to the marked point with the "R" symbol adjacent to the distance index line.
- (3) Attach an infrared filter on the lens and shoot. Note: For more details, refer to the infrared film instructions.

## 4 Other features

### 4-6 Depth of Field

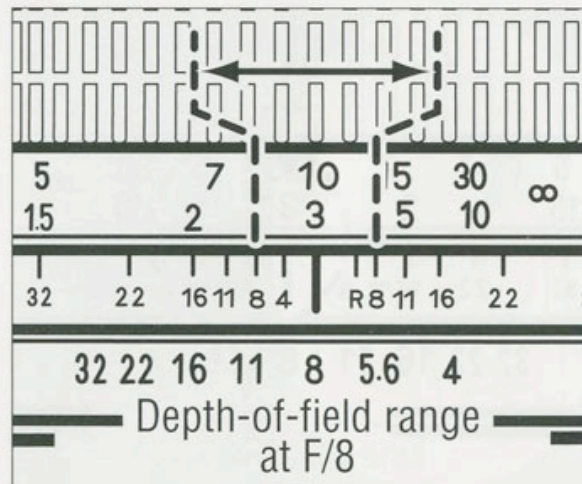

#### 4-6 Depth of Field

Since the Bronica RF 645 is a coupled rangefinder camera comprising separate shooting and viewfinder optical systems, the sharp focus range is not directly displayed in the viewfinder. The depth of field must therefore be read from the depth of field scale on the lens, or calculated from the depth of field table on page 32.

(1) To read the depth of field on the lens, focus on a subject, then read two distances on the distance scale between the pair of depth-of-field lines corresponding to the f-number set on the aperture ring. In the illustration above, the 65mm lens is focused on a subject at 3 meters with its aperture set at

f/8. The depth of field range of approximately 2.5 to 4 meters is found between the pair of f/8 lines on the depth of field scale. The subjects within these two distances will be photographed in sharp focus. On the depth of field table of the 65mm lens on page 32, the box located where the horizontal line for 3 meters and the vertical column for f/8 intersect includes the distance range corresponding to the depth of field of 2.52 to 3.71 meters.

Note: The depth of field tables other than the 65mm lens are printed on the instruction manual of each lens.



# 4 Other features

## 4-6 Depth of Field

RF 65mm F4 Depth of Field Table

65mm	Distance (m)	F4	F5.6	F8	F11	F16	F22	F32
	1.0	0.96 - 1.04	0.95 - 1.06	0.92 - 1.09	0.90 - 1.13	0.86 - 1.20	0.82 - 1.30	0.75 - 1.52
	1.2	1.14 - 1.27	1.12 - 1.29	1.09 - 1.34	1.05 - 1.40	1.00 - 1.52	0.94 - 1.69	0.85 - 2.08
	1.5	1.41 - 1.61	1.37 - 1.66	1.32 - 1.73	1.27 - 1.84	1.19 - 2.06	1.10 - 2.40	0.98 - 3.33
	2	1.83 - 2.21	1.77 - 2.30	1.69 - 2.46	1.60 - 2.69	1.46 - 3.20	1.33 - 4.15	1.16 - 8.28
	3	2.62 - 3.50	2.50 - 3.76	2.33 - 4.22	2.16 - 4.98	1.91 - 7.16	1.69 - 15.2	1.41 - ∞
	5	4.01 - 6.63	3.73 - 7.63	3.36 - 9.88	3.00 - 15.7	2.54 - 772	2.15 - ∞	1.71 - ∞
	10	6.67 - 20.1	5.89 - 33.7	5.01 - ∞	4.23 - ∞	3.36 - ∞	2.70 - ∞	2.04 - ∞
	∞	19.0 - ∞	13.7 - ∞	9.69 - ∞	7.10 - ∞	4.92 - ∞	3.60 - ∞	2.50 - ∞
	Distance (ft)	F4	F5.6	F8	F11	F16	F22	F32
3.5	3.35 - 3.67	3.29 - 3.74	3.21 - 3.85	3.12 - 4.00	2.97 - 4.28	2.81 - 4.68	2.59 - 5.54	
4	3.80 - 4.22	3.73 - 4.32	3.62 - 4.48	3.50 - 4.69	3.31 - 5.09	3.11 - 5.67	2.83 - 7.04	
5	4.68 - 5.37	4.57 - 5.53	4.40 - 5.80	4.21 - 6.17	3.94 - 6.91	3.65 - 8.09	3.26 - 11.4	
7	6.37 - 7.78	6.15 - 8.14	5.85 - 8.75	5.51 - 9.66	5.03 - 11.7	4.55 - 15.8	3.94 - 37.7	
10	8.73 - 11.7	8.31 - 12.6	7.75 - 14.2	7.15 - 16.8	6.34 - 24.4	5.59 - 54.4	4.67 - ∞	
15	12.3 - 19.3	11.4 - 21.9	10.4 - 27.3	9.32 - 39.5	7.96 - 158	6.79 - ∞	5.46 - ∞	
30	20.6 - 55.3	18.3 - 83.8	15.7 - 369	13.4 - ∞	10.7 - ∞	8.65 - ∞	6.57 - ∞	
∞	63.4 - ∞	45.6 - ∞	32.1 - ∞	23.4 - ∞	16.2 - ∞	11.9 - ∞	8.22 - ∞	

# 5 Troubleshooting

## Troubleshooting

Before taking your camera in for repairs, check your camera referring to the following table.

When photographing

What's happening	Viewfinder LCD	Cause of trouble	Means to solve	How to operate
Shutter release button depressed lightly but LCD does not light.	No LCD indication	Battery drained,	Load new batteries,	
		Improperly loaded batteries,	Properly replace batteries,	
		Main switch turned OFF	Turn ON main switch	
Flashing LCD warning	Shutter speed LCD flashing	Beyond exposure control range	Change f-number setting	When dark: Open aperture to smaller f-number, When bright: Close aperture down to larger f-number
	Aperture & shutter speed flashing	Beyond metering range, Subject too dark,	Too dark: Use photo lamp, flash unit,	
		Subject too bright	Too bright: Use ND filter	Adjust exposure by ND filter factor
	Battery mark flashing	Battery drained	Load new batteries	
"P, A, or M" mark flashing	Camera set on multiple exposure (ME) mode	Cancel ME mode	Press on ME button	
Warning indications	AL mark indication	Camera in AL lock mode	Cancel AE lock mode after shooting in this mode.	Press AE L button for second time, Turn OFF main switch, Change exposure control mode.
	"X" mark indication	Camera temporarily inoperable, Film not wound to next frame,	Wind film,	Wind rapid wind lever to end,
		No film loaded, Lens not mount properly	Load film, Replace lens correctly	Use ME button for camera check without film, Check if lens lock release button in original position after lens mounting.
Shutter does not click.	No LCD indication	Battery exhausted,	Load new batteries,	
		Main switch turned OFF	Turn main switch ON.	
	"X" mark flashing	Camera temporarily inoperable, Film not wound to next frame,	Wind film,	Wind rapid wind lever to end,
		No film loaded, Lens not mount properly	Load film, Replace lens correctly	Use ME button for camera check without film, Check if lens lock release button in original position after lens mounting.
Cause of trouble				
ME button does not work.	No LCD indication	In-finder LCD not activated.	Press shutter release button again to activate LCD panel.	In-finder LCD turns itself off 6 sec. after shutter release button depression for saving energy.
Selftimer does not work		Shutter dial set on "B"	Change shutter dial position.	

# 5 Troubleshooting

Exposed film is....

What's happening	Cause of trouble	Means to solve	How to operate
Under exposed,	Shot in AE lock mode	Cancel AE lock mode after shooting in this mode.	Press AE L button for second time, Turn OFF main switch, Change exposure control mode.
Over exposed	Shot in AE lock mode	Cancel AE lock mode after shooting in this mode.	Press AE L button for second time, Turn OFF main switch, Change exposure control mode.
Not exposed at all	Shot with lens cap on	Take lens cap off to photograph.	
Images very blurred	Camera shakes	Mount camera on a sturdy tripod.	

Flash picture appears to be...

What's happening	Cause of trouble	Means to solve	How to operate
Under exposed	Beyond exposure control range,	Cancel AE lock mode after shooting in this mode.	Check flash range on flash unit LCD.
	Exposed on white subject	Set Speedlight exposure compensation on plus (+) side.	
Over exposed	Beyond exposure control range,	Close lens aperture down or step back from subject,	Press AE L button for second time, Turn OFF main switch, Check flash range on flash unit LCD.
	Exposed on black subject	Set Speedlight exposure compensation on minus (-) side.	
Background streaked	Shutter speed too slow in aperture-priority AE mode	Select faster speed in manual (M) mode or change to programmed AE (P) mode.	

Others

What's happening	Cause of trouble	Means to solve	How to operate
Battery dries up too fast.	Used AE lock mode too long,	Load new batteries	Cancel AE lock after shooting in this mode,
	Used camera under low temperature atmosphere	Load new batteries	Take backup batteries for photographing at cold place.

# 6 References

## Relationship Between Shutter Speed, Aperture and Exposure

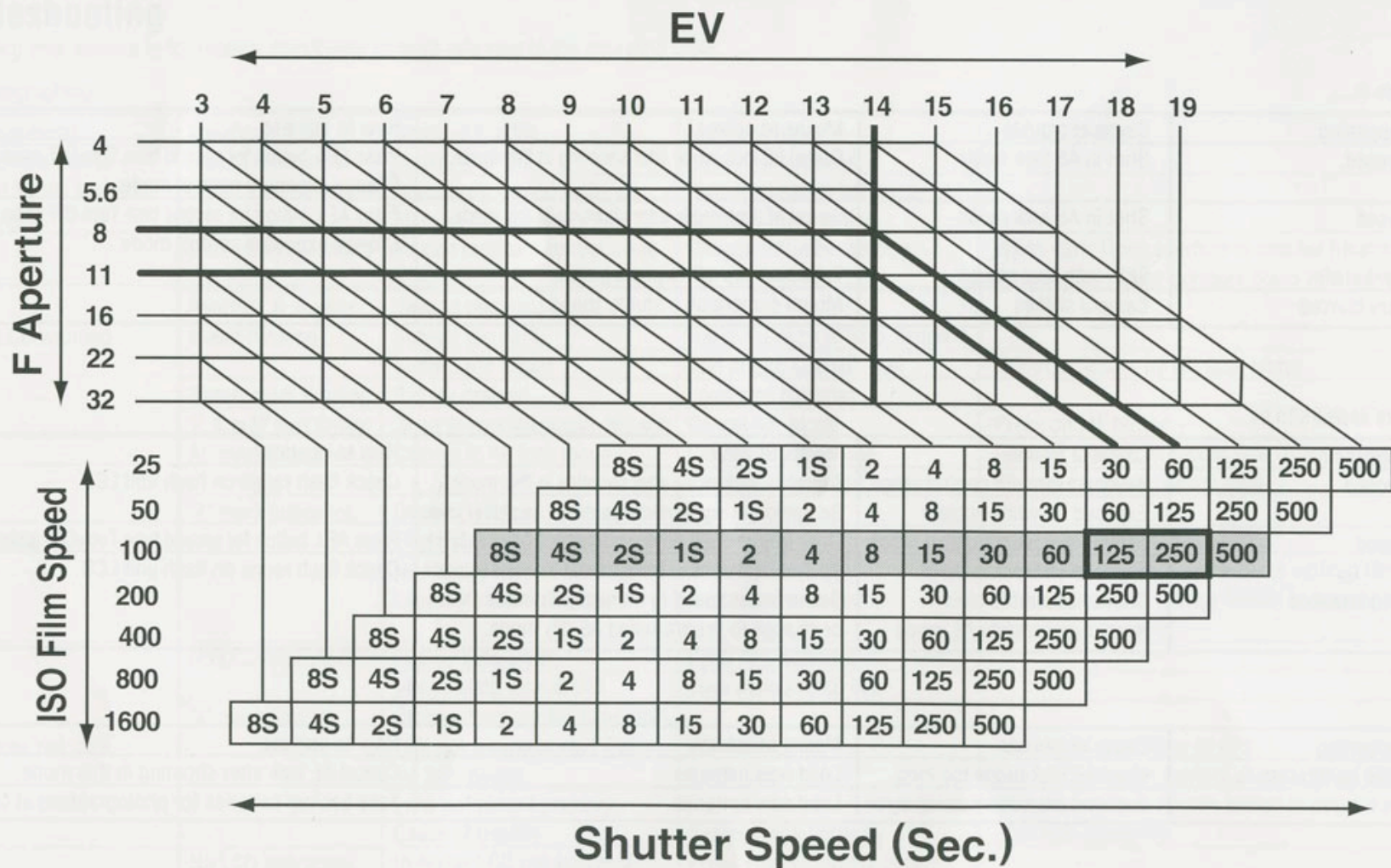

### Exposure Measuring Range and Ev

The exposure measuring range with the BRONICA RF645 is EV3 to 18 (with ISO 100 film).

For example: If EV 14 is the correct exposure with ISO 100 film, the shutter speed setting will be 1/250 sec. when f8 is set to the aperture ring. If the aperture is adjusted to, in the above case, the shutter speed setting will become 1/125 sec.

\*An EV 14 is the brightness outdoors on a bright sunny day.

# 6 References

## Exposure Measurement Sensivity Patterns

ZENZANON-RF  
45mm F4

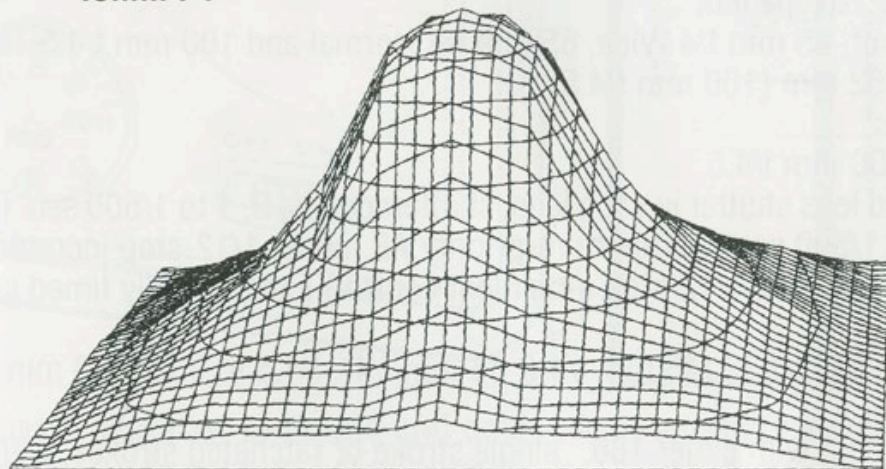

ZENZANON-RF  
65mm F4

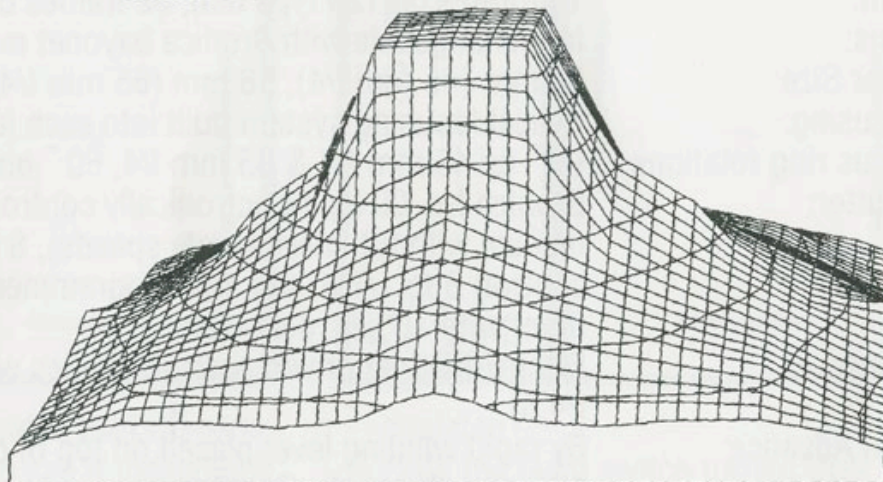

ZENZANON-RF  
100mm F4.5

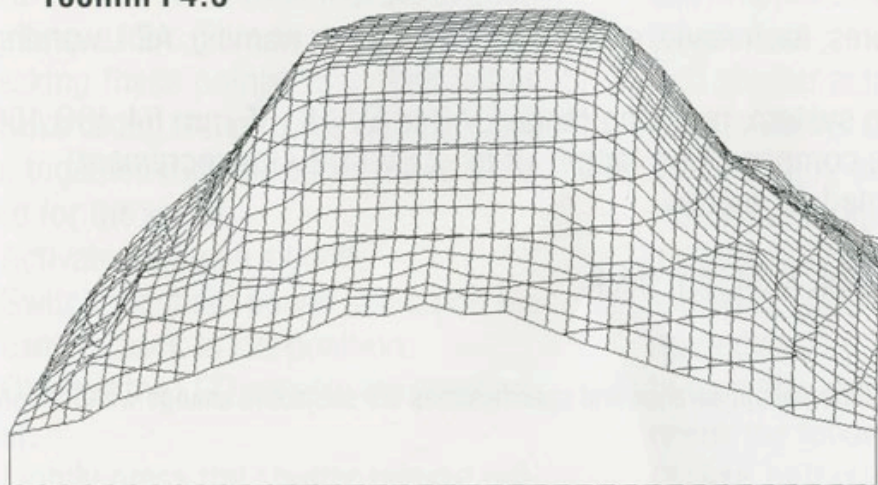

## 7 Specifications

Camera Type:	Coupled-meter rangefinder, lens shutter 6 X 4.5 format camera
Picture Format:	41.5 mm X 56 mm
Film:	16 frames on 120 type film, 32 frames on 220 type film
Lens:	Interchangeable with Bronica bayonet mount, 45 mm f/4 Wide, 65 mm f/4 Normal and 100 mm f/4.5 Tele.
Filter Size:	58 mm (45 mm f/4), 58 mm (65 mm f/4), 62 mm (100 mm f/4.5)
Focusing:	Helical focusing system built into each lens;
Focus ring rotations:	90° on 45 mm f/4 & 65 mm f/4, 60° on 100 mm f/4.5.
Shutter:	Bronica No. 00 type electronically controlled lens shutter in each lens, shutterspeeds; B, 1 to 1/500 sec. (on manual without intermediate speeds), 8 to 1/500 sec. (on aperture-priority AE mode, 1/12-stop increment control) 8 to 1/750 sec. (on programmed AE mode, 1/12-stop increment control) Electronically timed self timer with 10 sec. delay time
Aperture:	Electro-magnet driven aperture blades with f/4 to f/32 (45 mm f/4 & 65 mm f/4), f/4.5 to f/32 (100 mm f/4.5)
Film Advance:	By rapid winding lever placed on top of camera with either 186° single stroke or ratcheted strokes, with 12° standby angle. Coupled
Rangefinder:	Dual-image superimposing real image optical system, with 53.5 mm base line (effective base line: 33 mm)
Viewfinder:	Inverse Galilean optical system with coupled rangefinder bright frames automatically switched between 65 mm and 100 mm lens and automatically corrects parallax, finder magnification; 0.6X, viewing field 81% at 3 m.
In-Finder Display:	Shutter speeds, lens aperture, correct exposures, flash ready, exposure compensation warning, AE L warning, multiple exposure (ME) warning
Exposure Metering:	Center-weighted area-comparative metering system, metering range EV 3 to EV 18 (65 mm f/4, ISO 100), film speed range; ISO 25 to 1600, exposure compensation range; +2 to -2 EV (1/2-stop increment)
Exposure Control Modes:	Manual, Aperture-priority AE and Programmed AE modes
Battery:	2 cells of CR2, 3V Lithium type battery
Dimensions:	Camera body 145.6 mm wide X 107.3 mm high X 64 mm thick.
Weight:	Camera body 810g

External appearance and specifications are subject to change without notice.

## 8 Preliminary Checklist (Before loading film)

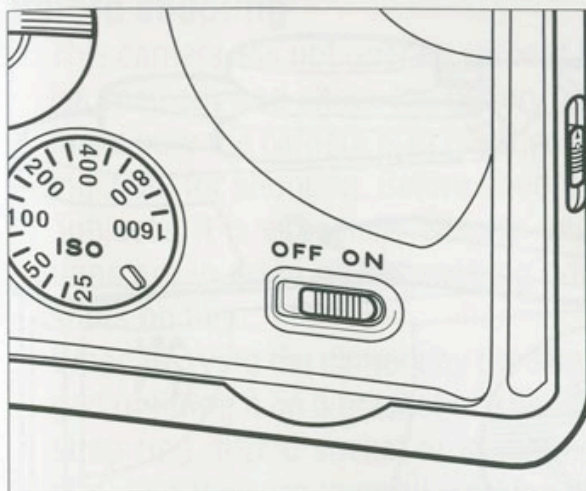

A basic checklist of points and basic procedures to confirm before embarking on a shoot are listed below. When you plan an important photographing session, it is essential to test your camera to ensure the unit and other equipment are in good working order. This includes not only checking these points described below but also taking test pictures with the camera, together with the accessories to be used for the shoot.

1) Activate the main switch:

Switch the main power switch on the camera back to ON position.

2) Observe the LCD panel in the viewfinder:

Lightly press the shutter release but-

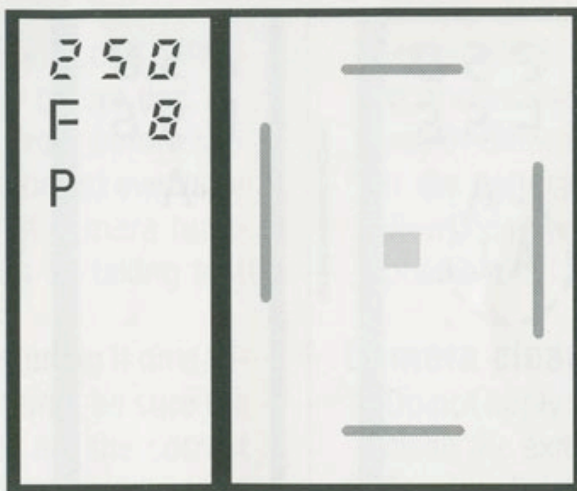

ton, and carefully watch the LCD panel in the viewfinder to see if indications respond properly to the aperture ring or shutter speed dial adjustments, or respond spontaneously to the various brightness of the scene pointed by the camera.

3) Test shutter action:

To activate the shutter without loading a roll of film, activate the LCD in the viewfinder by lightly pressing the shutter button, then press on the multiple exposure (ME) button on the camera rear cover.

4) In case the shutter does not operate, check the following:

(1) Are batteries loaded? Are they

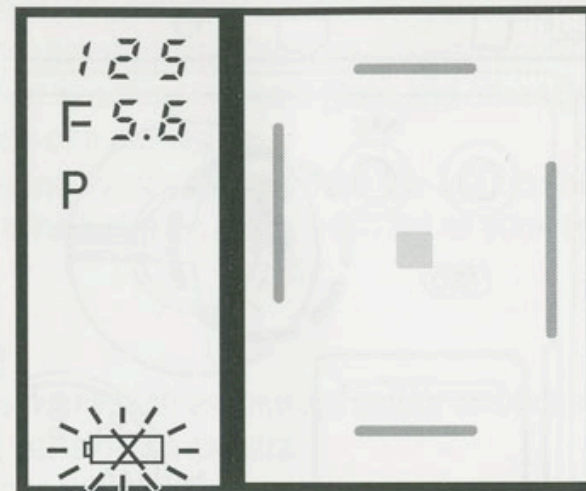

depleted?

(2) Is the main switch turned ON?

(3) Is the lens correctly mounted on the camera?

If the lens is not securely locked on the camera body, the light shielding curtain will remain activated and the shutter will be locked. Remount the lens correctly and lock it in position.

5) Other points to check:

(1) Is the exposure compensation dial set to the "0" position? If not, set the dial back to "0", or incorrect exposures may result. Do not forget to turn the exposure compensation dial back to the original "0" position after exposure compensated shooting.

## 8 Preliminary Checklist (Before loading film)

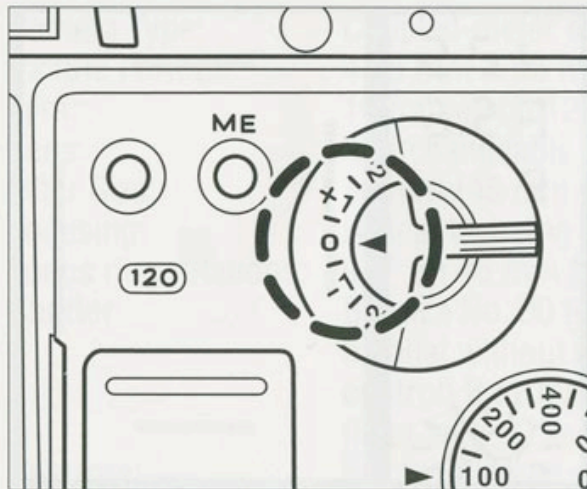

(2) Is the AE L mode canceled? If it is activated, an AE L mark appears on the LCD in the viewfinder. Once you press the AE L button located below the rapid wind lever, it maintains the metered brightness level for five continuous minutes. Be aware that the AE-locked exposure level may not be related to the subject you photograph at any given moment. To clear the AE L mode, press the AE L button for the second time or turn off the main switch momentarily. The camera now is in normal photographing mode.

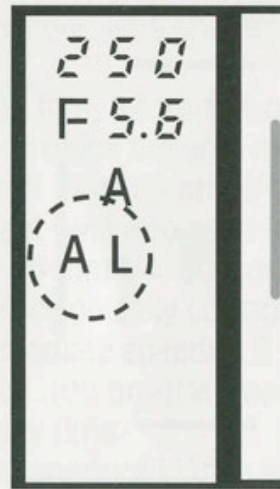

AE LOCK ON

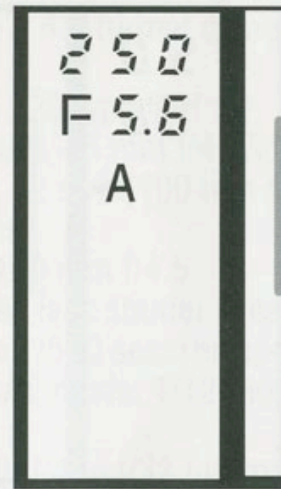

AE LOCK OFF

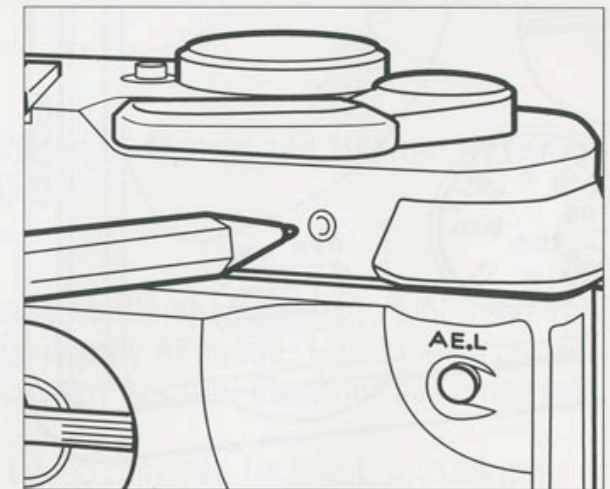

### Film wind lock release

If battery power drops below the camera's operational level, or the main switch is mistakenly turned off during a long exposure shot (B or longer than 1 second exposure), the film wind lock mechanism will interrupt the camera operation and prevent the film from being advanced any further. To release the film advance lock, press the lock release with a pointed object such as a ballpoint pen. The film wind lock will be released and the film can then be advanced.

Note 1: When the battery power becomes depleted, replace with fresh ones as soon as possible.

Note 2: Do not press the film advance lock release for any reason other than outlined above.



## 9 Ensuring years of enjoyment through proper care and handling

### Before shooting

- \* This camera will not operate without batteries. Load batteries correctly and check the battery capacity before use.
- \* Make sure the camera is in good working order before taking it out for shooting. Before shooting important events or subjects, it is especially wise to ensure all camera functions are in good photographing condition by taking test shots on film.
- \* When carrying the camera by the strap, fastening it on a tripod or fitting it on a bracket of a large flash unit, be sure the strap ring, tripod socket or mounting lock are the correct size, that they are in good working condition, and that the camera is securely fastened to these devices.

### About batteries

- \* Batteries left in a camera for prolonged periods may leak, resulting in malfunctioning of the circuitry or corrosion of internal mechanisms. When the camera is not used for an extended period, remove the batteries prior to stowing.
- \* In the event that a battery leak or corrosion is discovered? no matter how seemingly minor? have a detailed examination performed at a camera service center without delay.
- \* Stains, dirt or fingerprints on the battery contact may cause malfunctioning or corrosion of the circuitry. Wipe both contacts of the battery chamber and the ends of batteries clean with soft cloth or paper before loading the batteries to make sure contacts are all clean.
- \* Do not forget to carry backup batteries when setting out for a long photography trip or shooting in a cold place.

- \* Battery power lessens proportionally with the low surrounding temperature. Carry a set of backup batteries in a warm pocket or container when shooting in a cold place and alternate use of different sets of batteries.
- \* If the battery warning symbol appears on the LCD in the viewfinder, replace the batteries with a fresh set as soon as possible.

### Camera cleaning

- \* Do not apply any solvent such as thinners and/or alcohol to clean the external parts of the camera.
- \* To wipe dirt or finger prints from the camera surface, apply a soft cloth or silicone-treated cloth after blowing dust off the camera.
- \* Do not apply silicone-treated cloth to glass portions such as viewfinder windows or eyepiece lenses. Such chemically treated cloth may damage the optical coatings of the glass. Blow the dust off the glass surfaces and wipe dirt off the glass with lens cleaning tissues or well washed microfiber cloth, using a lens cleaning liquid available at camera stores.

### LCD (Liquid Crystal Display)

- \* The LCD may occasionally flicker or flare under bright ambient light. Such phenomena are not malfunctions, but typical attribute to LCD devices.
- \* The LCD may darken in an extremely high atmospheric temperature over 60 ° C or 140 ° F. The LCD appearance will return to normal when cooled to room temperature.
- \* The display speed of LCD may slow down in a low atmos-

## 9 Ensuring years of enjoyment through proper care and handling

pheric temperature. This is not a malfunction, but rather an inherent characteristic of LCD technology.

### Operational Conditions of Camera

- \* Temperature range: -5deg. C to +40deg. C or 23deg. F to 104deg. F. Relative humidity range: Less than 80%. If left in the direct sunlight or on the dashboard of a car, the camera may far exceed operational temperature range, causing damage to the camera. Do not leave your camera in conditions of heat or direct sunlight. If accidentally overheated, place your camera in a cool place until it returns to a normal room temperature before further use.

### Storage and Maintenance

- \* Your camera is a precision instrument. It is strongly recommended that you visit a service center or a repair station for routine checks every one to two years and for overhauls every three to five years. The best services will be provided at a Bronica/Tamron service centers.
- \* Store the camera in a dry, dust free, cool place. Put caps on the camera and lens openings, cavities, accessory mounting devices or electric terminals before storing your camera and lenses.
- \* Do not store your photographic equipment in cabinets or drawers containing insecticides, disinfectant, adhesives or other chemical substances. Chemical fumes are extremely harmful to precision mechanisms, electronic devices, optical elements of cameras and photographic films.

# BRONICA

Exported by:

**TAMRON CO.,LTD.**

17-11,7-chome,Takinogawa, Kita-ku, Tokyo 114-0023, Japan

Phone:(03)3916-0131 Fax:(03)3916-1860

0110U ④