

AP8A

8-BAND VERTICAL

10, 12, 15, 17, 20, 30, 40 & 80 METERS



951435 (12/93)

TA5FA

WARNING

THIS ANTENNA IS AN ELECTRICAL CONDUCTOR. CONTACT WITH POWER LINES CAN RESULT IN DEATH, OR SERIOUS INJURY. DO NOT INSTALL THIS ANTENNA WHERE THERE IS ANY POSSIBILITY OF CONTACT WITH OR HIGH VOLTAGE ARC-OVER FROM POWER CABLES OR SERVICE DROPS TO BUILDINGS. THE ANTENNA, SUPPORTING MAST AND/OR TOWER MUST NOT BE CLOSE TO ANY POWER LINES DURING INSTALLATION, REMOVAL OR IN THE EVENT PART OF THE SYSTEM SHOULD ACCIDENTALLY FALL. FOLLOW THE GUIDELINES FOR ANTENNA INSTALLATIONS RECOMMENDED BY THE U.S. CONSUMER PRODUCT SAFETY COMMISSION AND LISTED IN THE ENCLOSED PAMPHLET.

Your Cushcraft AP8A vertical antenna is designed and manufactured to give trouble free service. This antenna will perform as specified if the instructions and suggestions in this manual are followed and care is used in the assembly and installation. When checking the components received in your antenna package use the parts listed beside each diagram. There is a master parts list on page 2. If you are unable to locate any tube or component, check the inside of all tubing. **IMPORTANT:** Save the weight label from the outside of the carton. Each antenna is weighed at the factory to verify the parts count. If you claim a missing part, you will be asked for the weight verification label.

PLANNING

Plan your installation carefully. If you use volunteer helpers be sure that they are qualified to assist you. Make certain that everyone involved understands that you are in charge and that they must follow your instructions. If you have any doubts at all, employ a professional antenna installation company to install your antenna.

LOCATION

The AP8A will perform best if it is mounted vertically and located in the clear away from surrounding objects such as buildings, trees, power lines, towers, guy wires, antennas and metallic objects. The AP8A should be attached to a ground radial system (such as the Cushcraft APR-18A Radial Kit). Failure to heed these points will possibly degrade performance, detune the antenna and increase VSWR.

EXTREME CARE MUST BE USED FOR YOUR SAFETY. YOU MUST INSURE THAT WHILE THE AP8A IS IN OPERATION NEITHER PEOPLE OR PETS CAN COME IN CONTACT WITH ANY PORTION OF YOUR ANTENNA INCLUDING THE GROUND RADIALS. DEADLY VOLTAGES AND CURRENTS MAY EXIST. ALSO, SINCE THE EFFECTS OF EXPOSURE TO RF ARE NOT FULLY UNDERSTOOD, LONG TERM EXPOSURE TO INTENSE RF FIELDS IS NOT RECOMMENDED. THERE IS A WARNING STICKER ALREADY ATTACHED TO THE BASE OF THE AP8A.

MOUNTING

Your mast should be rigid and pointing straight up. Always use a mast at least 1.5 inches (3.8 cm) but not larger than 1.75 inches (4.5 cm) in diameter. If ground mounted, the AP8A should have its base at least 2" (5 cm) above the surface of the ground. A sufficiently heavy pipe with a minimum outside diameter of 1.5" (3.8 cm) should be securely anchored in the ground and a separate ground rod is required (see below).

SYSTEM GROUNDING

Direct grounding of the antenna mast is very important. This serves as protection from lightning strikes and static buildup, and from high voltages which may be present in the equipment attached to the antenna. A good electrical connection should be made to one or more ground rods directly at the base of the antenna using a least #10 AWG ground wire and non-corrosive hardware. For details and safety standards, consult the National Electrical Code. You should also use a coaxial lightning arrestor. Cushcraft offers several different models, such as the LAC-1, LAC-2 or the LAC-4 series.

Quarter-wave verticals require a good RF ground system with at least one radial per band for proper performance. Please see ground radial section for recommendations on ground radial installation.

ASSEMBLY

Assemble your AP8A by following steps 1 through 5. After assembling the antenna, verify all dimensions in figure 2 for accuracy. Then return to the adjustment section below for final tuning.

ADJUSTMENT

The dimensions in figure 2 normally allow proper operation on all the bands. However, some variations may occur from one location to another. Adjustments must be made from the bottom of the antenna (the higher bands) to the top (the lower bands). Adjusting the antenna from top to bottom will not work. This is because the settings at the top are severely affected by the adjustments at the bottom. Dimension A adjusts 10 and 12 meters. Dimension B adjusts 15 and 17 meters. Dimensions C, D, E and F adjust 20, 30, 40 and 80 meters in that order. We suggest measuring the VSWR of your antenna by using the SWR meter in your transceiver. If your transceiver does not have one, use a good quality VSWR bridge for this application. We will begin with 10 meters since this is at the bottom of the antenna. Set your transceiver at your favorite frequency on 10 meters. Key the rig and check your VSWR. The AP8A is extremely broadbanded on 10 meters and this section seldom needs adjustment. If the VSWR is low enough (below 1.5:1) move on to the 15 meters, section B (12 meters is not adjustable). If the 10 meter VSWR is not low enough, adjust the antenna as follows: Check several frequencies on 10 meters to find the frequency of lowest VSWR. If the frequency of lowest VSWR is above your favorite frequency, lengthen dimension A (figure 2) by 1 inch (2.5 cm). This should lower the frequency of lowest VSWR by 100 to 150 KHz. If the frequency of lowest VSWR is below your desired frequency, shorten dimension A (figure 2) by 1 inch (2.5 cm). Check your desired 10 meter operating frequency again to see if the VSWR is less than 1.5:1. Repeat this procedure until the VSWR at your desired frequency is low enough.

Continue this procedure by selecting your desired frequency on 15 meters and checking the VSWR there. Dimension B (figure 2) should not require any adjustment for 15/17 meters. However shortening this dimension will raise the frequency and lengthening it will lower the frequency.

The balance of the antenna should be adjusted in a like manner. The dimensions and the bands that they effect are shown in figure 2. On 10 through

20 meters 1 inch (2.5 cm) of change in length will change the operating frequency by 50 to 100 KHz. On 30 and 40 meters the change will be 15 to 25 KHz per inch (5 to 10 KHz/cm). When the antenna is completely adjusted, check all fasteners to be sure they are tight. Improving VSWR's that are less than 2:1 will not noticeably improve station performance.

INSTALLATION

Following the guidelines in the location and adjustment sections above, place the antenna on its mast in its final operating location. If you plan to install the antenna in a salty or corrosive environment, you may want to consider coating it with a clear marine varnish or equivalent *after final assembly and adjustment has been completed*. Now connect your transceiver. If you have any difficulties, reread the information above and the helpful hints below.

HELPFUL HINTS

- Try to locate your AP8A as far away from TV antennas and their feedlines as possible. This will help to avoid overloading your television with RF.
- High VSWR is sometimes caused by poor contact between the base and the radials. Make sure that corrosion has not formed on the radial clamp terminals. Check to insure that the hardware is tight.
- If your AP8A is very close to your station you may experience RF on the feedline. Try lengthening your feedline several feet, placing RF ferrite beads on the coax, winding the feedline on a toroid or winding the coax in a 10 turn coil 8 inches (20 cm) in diameter.
- Long periods (30 seconds or longer) of key down operation, such as RTTY, at high power (over 1000 Watts) may damage your AP8A.
- High winds may cause fluctuations in VSWR. This is normal.







MASTER PARTS LIST

KEY	P/N	DESCRIPTION	QTY	KEY	P/N	DESCRIPTION	QTY
VA	AP8VA	Base Section Assembly	1	41	011941	#8 stainless steel lock washer	2
VB	AP8VB	1-1/4" x 48" (3.2 x 121.9 cm) swaged aluminum tube slotted one end	1	77	050077	3/8" (.95 cm) black plastic cap	1
VC	AP8VC	1-1/8" x 5" (2.9 x 26.2 cm) aluminum tube slotted both ends	1	83	010083	1/4-20 x 1-1/4" (3.2 cm) stainless steel machine screw	7
VD	AP8VD	1-1/8" x 6-1/2" (2.9 x 16.5 cm) aluminum tube slotted both ends	1	84	010084	1/4" (.63 cm) stainless steel split lock washer	10
VE	AP8VE	1" x 26" (2.5 x 66 cm) aluminum tube slotted both ends	1	85	010085	1/4-20 stainless steel hex nut	10
VF	AP8VF	1/2" x 48" (1.3 x 122 cm) aluminum tube slotted one end	1	104	010104	1/4" (.8 cm) stainless steel flat washer	6
VG	AP8VG	3/8" x 48" (.95 x 122 cm) aluminum tube	1	105	200105	Aluminum guy wire radial clamp	3
XHR	AP8XHR	3/16 x 25" (.5 x 63.5 cm) aluminum rod with #18 hole drilled midpoint	2	110	203110	Mast mounting ring	2
TV6	TV6	10/12 meter trap assembly 34-5/8" (88 cm)	1	115	050115	Vinyl connector boot	1
TV7	TV7	15/17 meter trap assembly 15" (38.1 cm)	1	116	240116	Silicone grease packet	1
TV8	TV8	20 meter trap assembly 15-3/4" (40 cm)	1	231	010231	8-32 x 1-3/4" (4.44 cm) stainless steel machine screw	2
TV9	TV9	30 meter trap assembly 21" (53.3 cm)	1	326	290326	Warning label	1
TV	TV	40 meter trap assembly 22-1/4" (56.5 cm)	1	407	030407	5/8" (1.6 cm) stainless steel worm clamp	1
11	010011	8-32 stainless steel hex nut	2	409	030409	7/8" (2.22 cm) stainless steel worm clamp	1
26	190026	7/8" (2.22 cm) formed aluminum bracket with #8 hole	2	410	030410	1" (2.54 cm) stainless steel worm clamp	3
28	190028	Aluminum half washer	2	411	030411	1-1/4" (3.17 cm) stainless steel worm clamp	4
				412	030412	1-1/2" (3.81 cm) stainless steel worm clamp	2

#1 - ASSEMBLE BASE

Attach the mast mount rings (110) by sliding them over the bottom of the base tube. Thread a hex nut (85) onto a machine screw (83) and then slide on a lock washer (84) onto the same screw. Do this to 3 more screws for a total of 4 assemblies. Thread these screw assemblies into the mast mount rings (110) far enough so that the screw enter the holes drilled into the base tube. Assemble radial clamps 9-1/2" (24 cm) down from the top of the base tube (figure 1) using machine screws (83), lock washers (84), flat washers (104) and nuts (85) as shown. The radials shown in figure 1 are from the Cushcraft APR-18A Radial Kit. What you use for radials is up to your discretion.

FIGURE 1



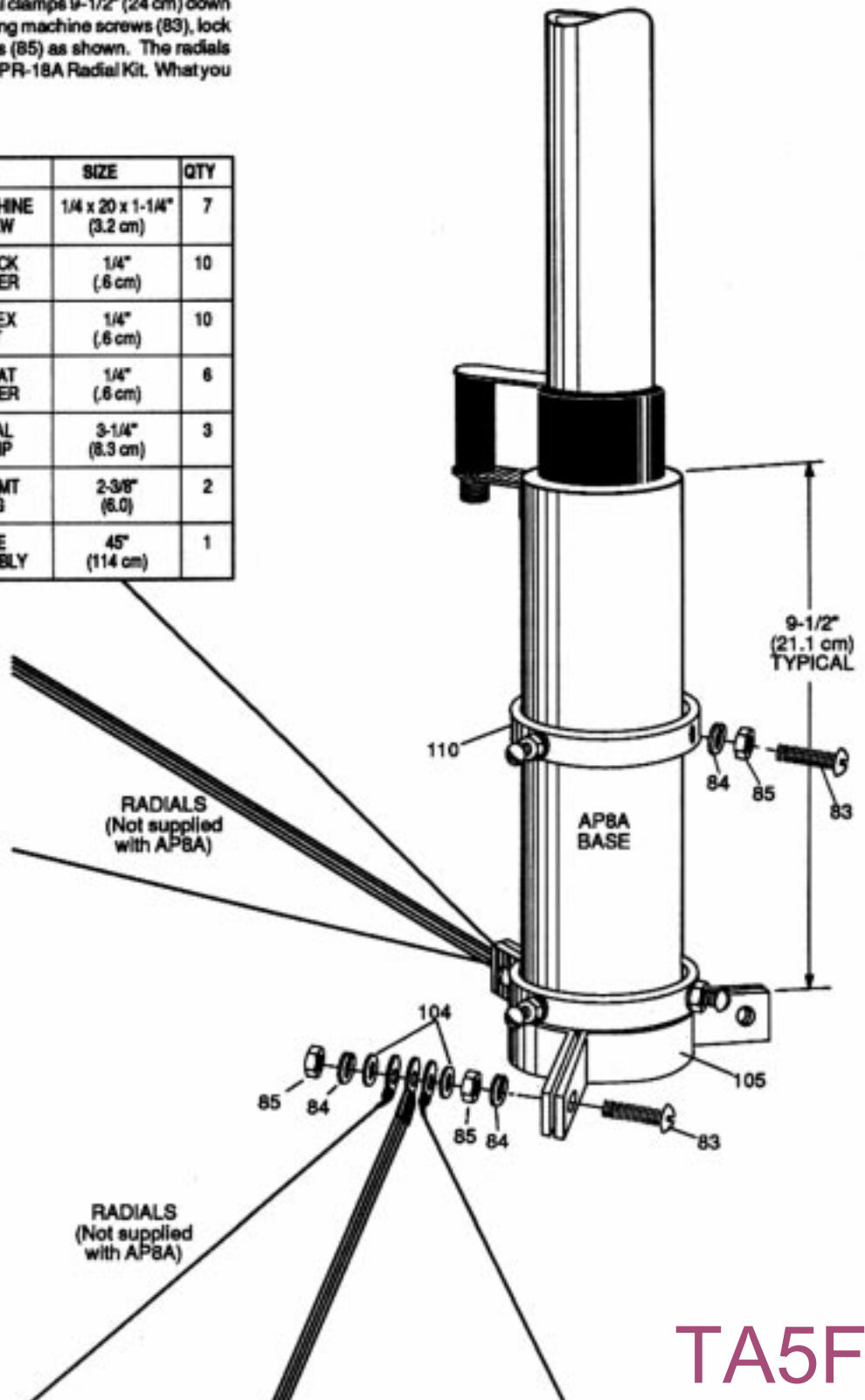













KEY	PN		DESC.	SIZE	QTY
83	010083		SS MACHINE SCREW	1/4 x 20 x 1-1/4" (3.2 cm)	7
84	010084		SS LOCK WASHER	1/4" (.6 cm)	10
85	010085		SS HEX NUT	1/4" (.6 cm)	10
104	010104		SS FLAT WASHER	1/4" (.6 cm)	6
105	200105		RADIAL CLAMP	3-1/4" (8.3 cm)	3
110	203110		MAST MT RING	2-3/8" (6.0)	2
VA	AP8AVA		BASE ASSEMBLY	45" (114 cm)	1



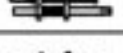
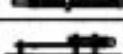

TA5FA

#2 - ASSEMBLE VERTICAL

Install worm clamp (412) on slotted end of base assembly (VA). Slide VB 4" (10.2 cm) into VA and secure clamp. Place a 412 hose clamp on the top of VB and insert the TV6 trap into VB. The arrows on the traps all point up. Choose your operating mode from the Antenna Length Chart on this page and find the length of your "A" dimension. Set this dimension now, referring to the figure 2 for the correct measuring reference points. Assemble the rest of the radiator using the same procedures making sure to alternate the traps from left side to right side. When the entire antenna is assembled, double-check all the measured settings and make sure that the hose clamps are secure.

KEY	PN		DESC.	SIZE	QTY
77	050077		PLASTIC CAP	3/8" (0.9 cm)	1
407	030407		WORM CLAMP	5/8" (1.6 cm)	1
409	030409		WORM CLAMP	3/4" (1.9 cm)	2
410	030410		WORM CLAMP	7/8" (2.2 cm)	3
411	030411		WORM CLAMP	1-1/4" (3.2 cm)	4
412	030412		WORM CLAMP	1-1/2" (3.8 cm)	2
VA	AP8AVA		BASE ASSEMBLY	45" (114 cm)	1
VB	AP8AVB		ALUMINUM TUBING	1-1/4" x 48 (3.2 x 122 cm)	1
VC	AP8AVC		ALUMINUM TUBING	1-1/8" x 5" (2.9 x 12.7 cm)	1
VD	AP8AVD		ALUMINUM TUBING	1-1/8" x 6-1/2" (2.9 x 16.5 cm)	1
VE	AP8AVE		ALUMINUM TUBING	1" x 26" (2.5 x 66 cm)	1
VF	AP8AVF		ALUMINUM TUBING	1/2" x 48" (1.3 x 122 cm)	1
VG	AP8AVG		ALUMINUM TUBING	3/8" x 48" (0.9 x 122 cm)	1
TV6	TV6		10/12M TRAP		1
TV7	TV7		15/17M TRAP		1
TV8	TV8		20M TRAP		1
TV9	TV9		30M TRAP		1
TV	TV		40M TRAP		1

ANTENNA LENGTH CHART							
KEY	CW 		CENTER 		PHONE 		BAND
	in	cm	in	cm	in	cm	
A	86	218.5	83	210.8	78-3/4	200	10/12 M
B	6	15.2	6	15.2	6	15.2	15/17 M
C	10	25.4	8-1/4	20.9	8-1/4	20.9	20 M
D	10-1/4	26.0	12	30.5	10-1/4	26.0	30 M
E	43	109.2	36	91.5	36	91.5	40 M
F1	93	263.2	75	190.5	60	152.4	80M
F2	89	226.1	71	180.3	56	142.2	80M
F3	84-1/2	214.6	67	170.2	52	132.1	80 M
F4	80	203.3	64	162.5	49	124.5	80 M

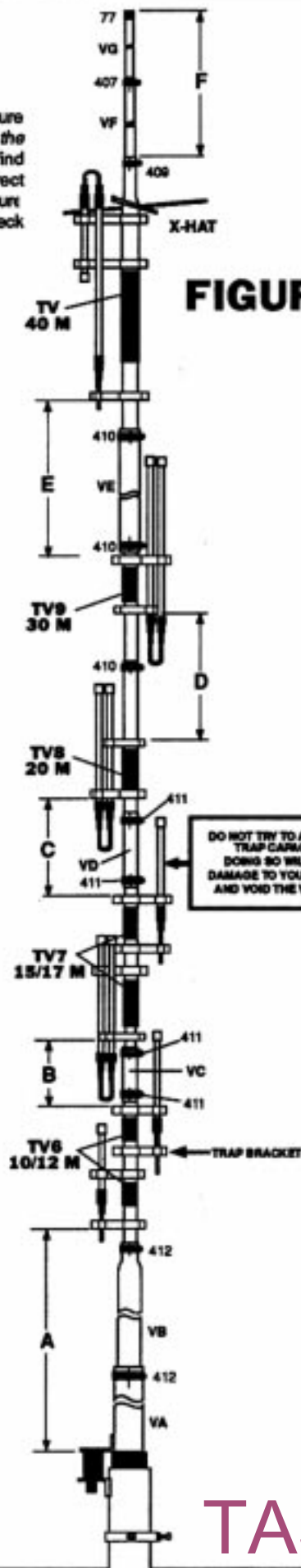





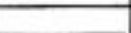

FIGURE 2

TA5FA

#3 - ASSEMBLE X-HAT

Assemble and attach the X-hat to the top of the TV trap (using the pre-drilled holes) as shown in figure 3.

KEY	PN		DESC.	SIZE	QTY
11	010011		HEX NUT	8-32	2
26	190026		FORMED BRACKET	7/8" (2.2 cm)	2
28	190028		ALUM. HALF WASHER	1" (2.54 cm)	2
41	011941		LOCK WASHER	#8	2
231	010231		MACHINE SCREW	8-32x1-3/4" (4.4 cm)	2
X-HR	AP8X-HR		X-HAT ROD	3/16" x 25" (5 x 65.5 cm)	2

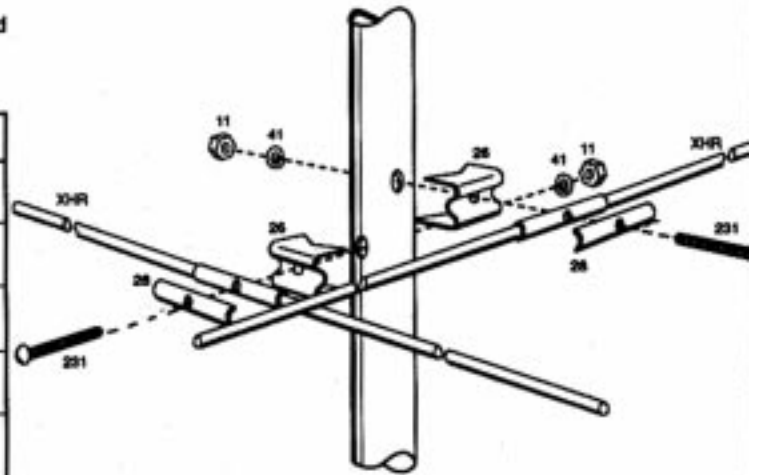



FIGURE 3

#4 - FEEDLINE

We have provided a weatherproof boot for the PL-259 connector on your feedline. Follow figure 4 to install it. Insert the antenna end of your coax through the small end of your connector boot. Many cables are very tight which results in an excellent weather seal. Attach a PL-259 to the end of your coax. Spread the silicone grease on the threads of the antenna connector. **SILICONE GREASE SHOULD NOT BE SPREAD ON THE CENTER PIN!** Apply the remaining silicone grease to the outside of the connector. Attach the connector to the antenna input connector and slip the boot over the connector until it touches the bracket. Return to the adjustment section on page 1.

KEY	PN		DESC.	SIZE	QTY
115	050115		CONNECTOR BOOT		1
116	240116		SILICONE PACKET		1

SILICONE
DO NOT COAT CENTER PIN WITH SILICONE!

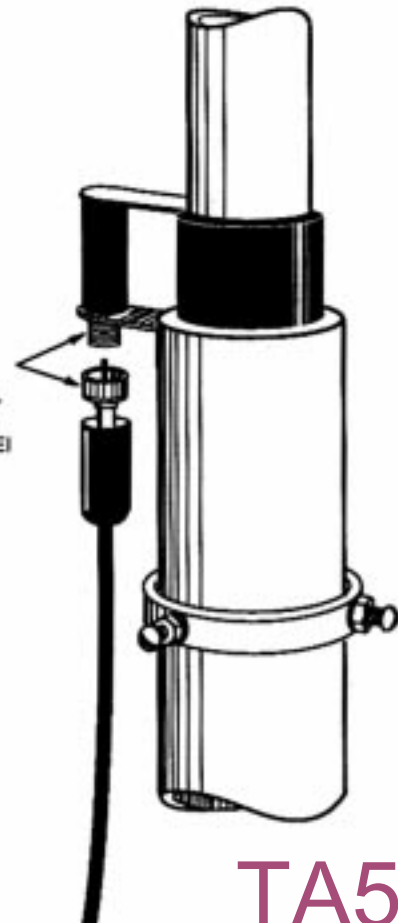

FIGURE 4

TA5FA

#5 - INSTALLATION

The Cushcraft APR18A Radial Kit is designed for use with the AP8A. If you build your own radial system, cut your radials using the appropriate radial length chart. You should use at least 3 radials per band. The more you have, the better your antenna will work. In many instances, ground mounted installations will only require radials for 80 and 40 meters in order to work on all bands. If your radials are too long for the area available, do not cut them. Form them as necessary to fit the space available, avoiding sharp bends.

FREQUENCY MHz	LENGTH ft-in (m)
3.500	70' 3" (21.43)
3.750	65' 7" (20.00)
4.000	61' 6" (18.75)
7.000	35' 2" (10.71)
7.150	34' 5" (10.49)
7.300	33' 8" (10.27)
10.125	24' 4" (7.41)
14.000	17' 7" (5.36)
14.175	17' 4" (5.29)
14.350	17' 2" (5.23)
18.118	13' 7" (4.14)
21.000	11' 8" (3.57)
21.225	11' 7" (3.53)
21.450	11' 6" (3.50)
24.940	9' 10" (3.01)
28.000	8' 9" (2.68)
28.500	8' 7" (2.63)
29.000	8' 6" (2.59)
29.500	8' 4" (2.54)

FIGURE 5

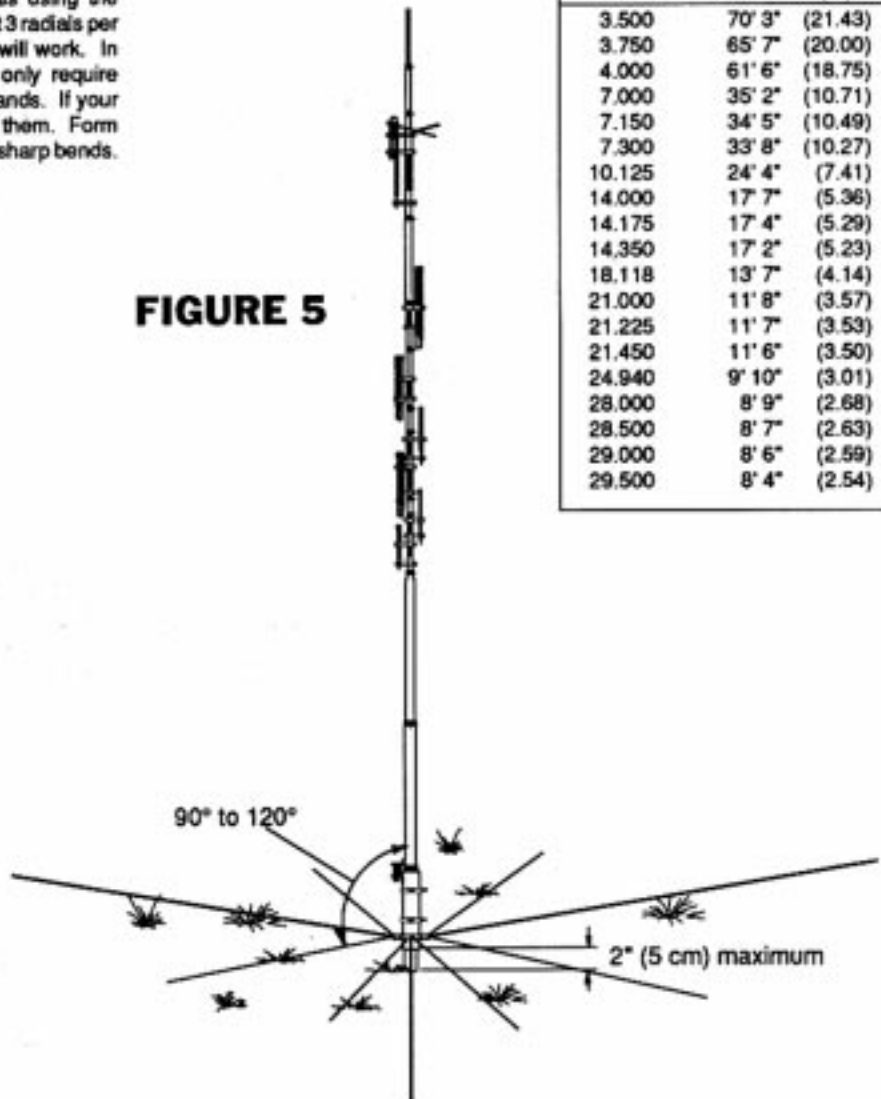
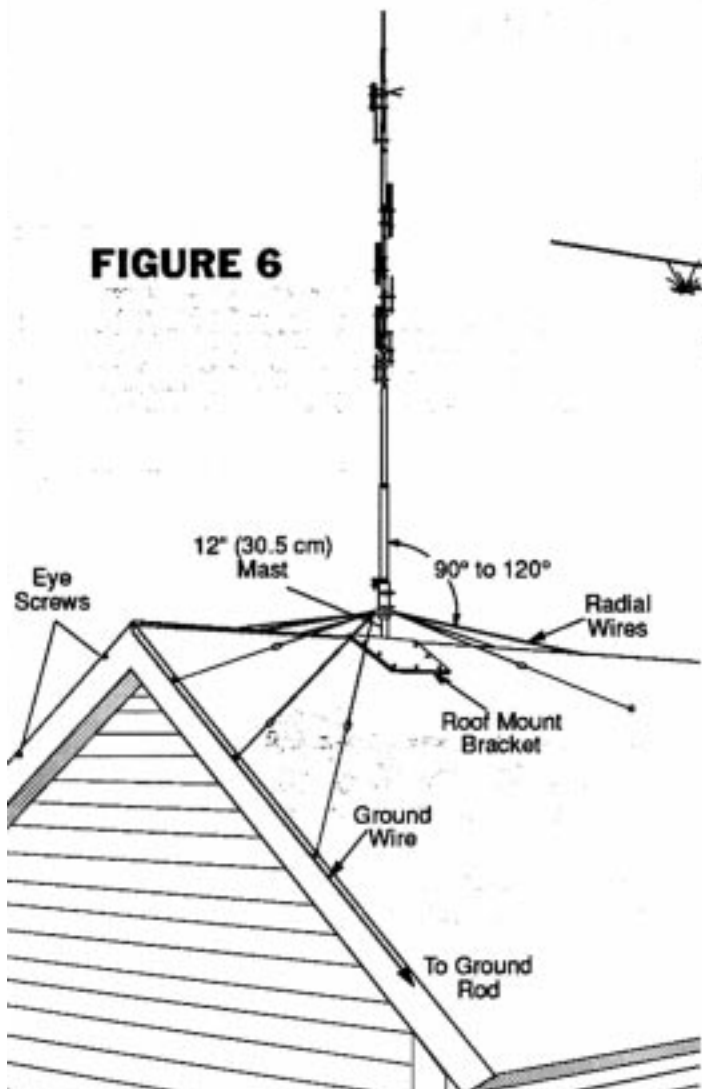

FIGURE 6



TA5FA

SPECIFICATIONS

Frequency, MHz	28, 24, 21, 18, 14, 10, 7, 3.5
Electrical Wavelength	1/4
VSWR 1.2:1 Typical	
2:1 Bandwidth	Full Band Except 40M-150 KHz & 80M-80 KHz
Power Rating, Watts PEP	2000
Radiation Angle, degrees	18
Frequency Selection	Automatic
Horizontal Radiation Pattern, degrees	360
Height, ft (m)	26 (7.92)
Mast Size Range, in (cm)	1.5-1.75 (3.8-4.4)
Wind Load, ft ² (m ²)	1.7 (.16)
Weight, lb (kg)	9.5 (4.3)
Radials Required	Normally
Radial Kit Available	Yes, APR18A

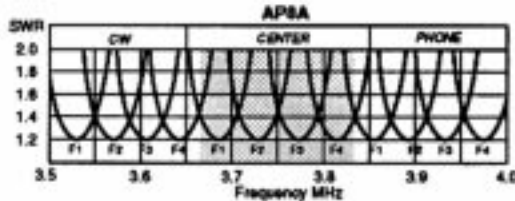

LIMITED WARRANTY

Cushcraft Corporation, P.O. Box 4680, Manchester, New Hampshire 03108, warrants to the original consumer purchaser for one year from date of purchase that each Cushcraft antenna is free of defects in material or workmanship. If, in the judgement of Cushcraft, any such antenna is defective, then Cushcraft Corporation will, at its option, repair or replace the antenna at its expense within thirty days of the date the antenna is returned (at purchaser's expense) to Cushcraft or one of its authorized representatives. This warranty is in lieu of all other expressed warranties, any implied warranty is limited in duration to one year. Cushcraft Corporation shall not be liable for any incidental or consequential damages which may result from a defect. Some states do not allow limitations on how long an implied warranty lasts or exclusions or limitations of incidental or consequential damages, so the above limitation and exclusion may not apply to you. This warranty gives you specific legal rights, and you may also have other rights which vary from state to state. This warranty does not extend to any products which have been subject to misuse, neglect, accident or improper installation. Any repairs or alterations outside of the Cushcraft factory will nullify this warranty.



48 PERIMETER ROAD, MANCHESTER, NH 03108
 603-627-7877 / TELEX 4949472 / FAX 603-627-1764

SPECIFICATIONS SUBJECT TO CHANGE WITHOUT NOTICE

TA5FA