

## Assembly and Installation Instructions

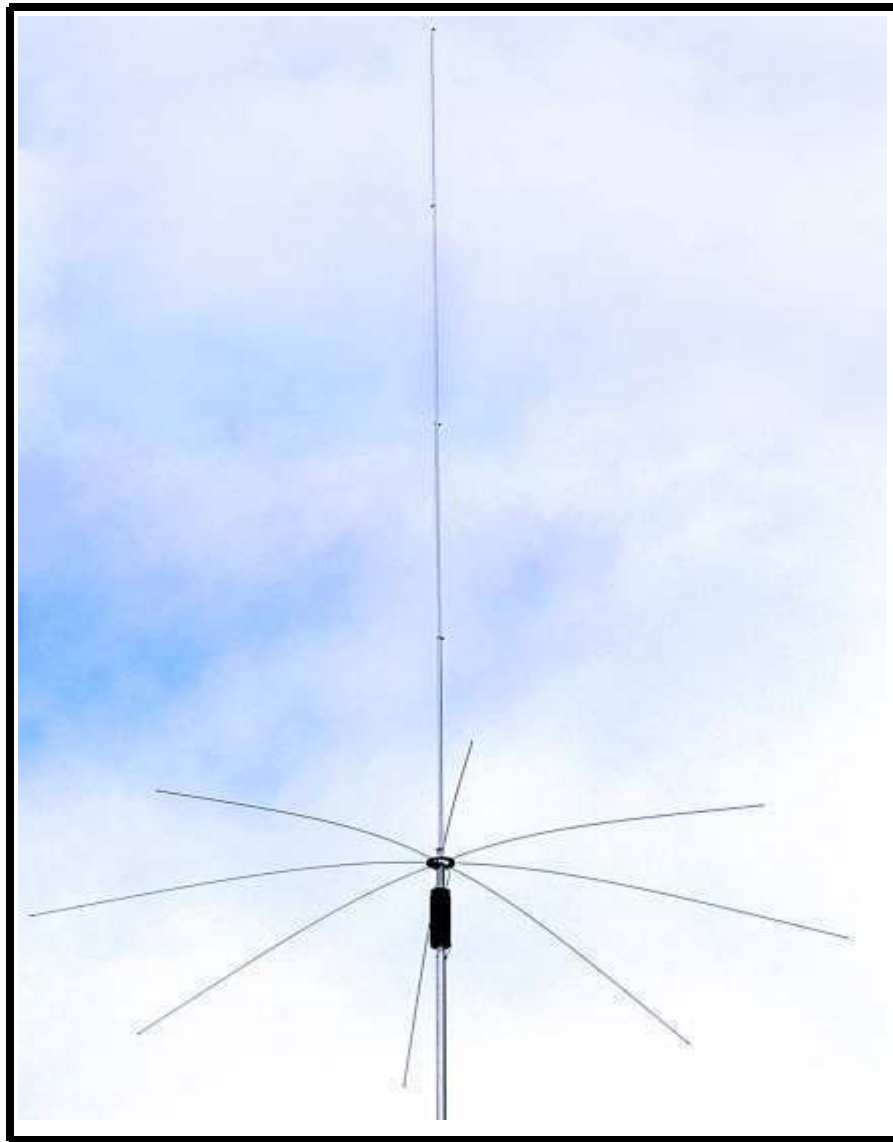

**Cushcraft MA160V Vertical DX Antenna**  
160-Meter Vertical Monopole Antenna



956895\_GF\_AB

**TA5FA**

**General Description:** The MA160V is a compact efficient vertical especially designed for working top-band DX from an average-size house lot. A low launch angle and deep overhead null combine to pull in distant stations while rejecting local QRM. The MA160V features a heavy-duty high-Q copper loading coil plus a wide 100-inch diameter stainless capacitive hat for high efficiency, resiliency and 1500-Watt PEP power handling. An adjustable stinger provides coverage on any 40-kHz segment across the 1.8 – 2.0 MHz band. Weighing only 12-pounds, the MA160V installs easily and blends in with backyard trees and vegetation. Each antenna comes with a 400-foot spool of ground-radial wire plus a Danscord™ insulated guying kit.

**Parts List:** Before assembling, read manual thoroughly and check contents against the parts list below:

| X                         | Quan. | Part #    | Description                                    |
|---------------------------|-------|-----------|--|
| <b>Hardware and Parts</b> |       |           |  |
| [ ]                       | 16    | 010009    | 5/8" x 8-32 screw                              |
| [ ]                       | 2     | 010123    | 1-1/2" x 8-32 screw                            |
| [ ]                       | 2     | 010231    | 1-3/4" x 8-32 screw                            |
| [ ]                       | 2     | 010120    | 2" x 8-32 screw                                |
| [ ]                       | 1     | 010232    | 2-1/2" x 8-32 screw                            |
| [ ]                       | 25    | 010011    | Hex nut, 8-32                                  |
| [ ]                       | 19    | 011941    | Split lock washer, #8                          |
| [ ]                       | 14    | 100449    | Star-locking solder lug                        |
| [ ]                       | 4     | 360941    | Alum flat washer, #10                          |
| [ ]                       | 2     | 320056    | Alum Spacer, 1/4" x 5/16"                      |
| [ ]                       | 2     | 105630    | 1/2" x 1/4" OD loading coil standoff spacer.   |
| [ ]                       | 2     | 194173    | Small 90-degree aluminum bracket               |
| [ ]                       | 7     | 030412    | Large worm clamp                               |
| [ ]                       | 3     | 030407    | Small worm clamp                               |
| [ ]                       | 1     | 902428    | Braid strap                                    |
| [ ]                       | 8     | 056249    | Vinyl radial-rod cap                           |
| [ ]                       | 1     | 055105    | 1/4" ID black vinyl tip cap                    |
| [ ]                       | 3     | 193631    | Aluminum guy-line bracket                      |
| [ ]                       | 3     | 024259    | Guy-line thimble                               |
| [ ]                       | 3     | 195179    | steel guy-line anchor stake                    |
| [ ]                       | 1     | MA160VGW  | 100-foot roll, Danscord-D30                    |
| [ ]                       | 1     | 156336    | 1/2" ID tuning stub bushing                    |
| [ ]                       | 1     | MA160VCA1 | 160-meter loading coil assembly                |
| [ ]                       | 8     | 221186    | Stainless steel radial-rod stock, 0.1" X 48"   |
| [ ]                       | 3     | 194174    | 8-hole radial ring                             |
| [ ]                       | 2     | 196242    | Upper radial ring support bracket              |
| [ ]                       | 1     | 096359    | Radial wire kit (400' spool, #18 solid enamel) |

**Tubes:**

|     |   |            |  |
|-----|---|------------|--|
| [ ] | 1 | 126854     | Fiberglass resonator support tube, 1" OD x 16"           |
| [ ] | 1 | 126241     | Fiberglass base insulator tube, 1.25" OD x 16"           |
| [ ] | 1 | MA8040VBAB | Aluminum base section, 12" x 1-3/8" OD (NS/2SH)          |
| [ ] | 1 | MA8040VBAT | Aluminum radiator section, 1-3/8" OD x 36" tube (2SH/4S) |
| [ ] | 2 | MA8040VBB  | Aluminum radiator splice, 1-1/4" OD x 12" tube (NS/NS)   |
| [ ] | 2 | MA8040VBC  | Aluminum radiator section, 1-3/8" OD x 72" tube (42/4S)  |
| [ ] | 1 | MA8040VBD  | Aluminum radiator section, 1-1/4" OD x 72" tube (NS/4S)  |
| [ ] | 1 | MA8040VBE  | Aluminum radiator section, 1-1/8" OD x 72" tube (NS/2SH) |
| [ ] | 1 | MA160VBI   | Aluminum resonator section, 1/2" OD x 36" tube (H/2S)    |
| [ ] | 1 | MA160VBJ   | Aluminum resonator section, 3/8" OD x 36" tube (NS/2S)   |
| [ ] | 1 | MA160VBK   | Aluminum resonator section, 1/4" OD x 41" aluminum rod   |

**Tube Identification Code:** Describes how tube ends are prepared to aid identification.

**NS** = no compression slots, **2S** = 2 compression slots, **4S** = 4 compression slots, **H** = screw hole.

Example: the MA8040VBAT is coded **2SH/4S**. Code means base end has 2 slots plus a screw hole and top end has 4 compression slots. Tubes with MA8040V part numbers are interchangeable with the MA160V.

## Assembly Instructions- MA160V

**Step 1: Using the items listed below, install aluminum tubes on base insulator.**

|   |            |   |
|---|------------|---|
| 1 | MA8040VBAB | 12" x 1-3/8" OD aluminum base section (NS/2SH)    |
| 1 | MA8040VBAT | 36" x 1-3/8" OD aluminum antenna section (2SH/4S) |
| 1 | 126241     | 16" x 1-1/4" OD fiberglass base insulator         |
| 2 | 010231     | 1-3/4" x 8-32 screw                               |
| 2 | 010011     | 8-32 nut  |
| 2 | 011941     | #8 lock washer                                    |

- [ ] Identify lower end of the base insulator (two thru-holes offset by 90°).
- [ ] Install 2-slot end of 12" base section over insulator and align screw holes.
- [ ] Insert 1-3/4" screw at **A**. Secure with lock washer and nut.
- [ ] Install 2-slot end of 36" radiator section over opposite end of the insulator and align screw hole.
- [ ] Insert a 1-3/4" screw at **B**. Secure with a lock washer and nut.

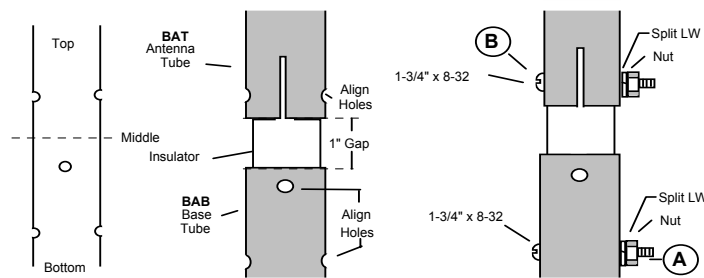

FIG-1: Base Insulator Assembly

**Step-2: Assemble and install ground-radial attachment ring on base assembly.**

|   |        |                                  |
|---|--------|----------------------------------|
| 1 | 010232 | 2-1/2" x 8-32 SS screw           |
| 8 | 010009 | 5/8" x 8-32 SS screw             |
| 9 | 011941 | #8 lock washer                   |
| 9 | 010011 | 8-32 nut                         |
| 2 | 360941 | #10 Flat aluminum spacer washer  |
| 2 | 320056 | 1/4" spacer                      |
| 1 | 194174 | 8-hole radial ring               |
| 2 | 194173 | Small 90-degree aluminum bracket |

- [ ] Find the 2-1/2" screw, two small 90° angle brackets, and two 1/4" spacers.
- [ ] Note that the angle brackets have *unequal sides*. Identify *long side* of each.
- [ ] On the 2-1/2" screw, install the bracket (long side), a #10 aluminum spacer washer, and a 1/4" spacer.
- [ ] Insert screw through base tube as shown at **A**.
- [ ] Install other 1/4" spacer, #10 spacer washer, and bracket (long side) on protruding end of screw.
- [ ] Position brackets as shown and secure firmly using a lock washer and nut.
- [ ] Insert two (2) 5/8" screws through angle brackets and place radial ring on top (**B**).
- [ ] Secure radial ring in place with lock washers and nuts (2 places)
- [ ] Install six 5/8" screws in open holes, secure with lock washers and nuts (**C**).

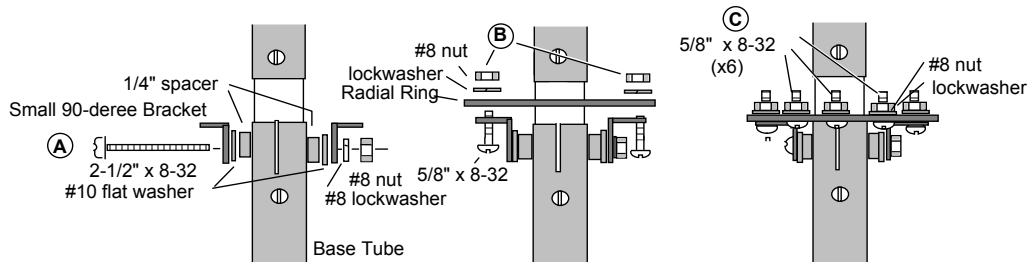

FIG-2: Ground Radial Ring Assembly

### Step-3: Assemble the capacitive-hat support ring.

|   |        |   |
|---|--------|---|
| 2 | 194174 | 8-hole radial ring  |
| 2 | 196242 | Upper radial-ring support bracket (do not confuse with set of 3 guy brackets) |
| 8 | 010009 | 5/8" x 8-32 screw   |
| 2 | 360941 | #10 aluminum spacer washer  |
| 8 | 011941 | #8 lock washer  |
| 8 | 010011 | 8-32 nut  |

- [ ] Locate the two radial rings and place together so cupped grooves oppose.
- [ ] Install two 5/8" screws from top, as shown.
- [ ] From bottom side, install a #10 spacer washer and a support bracket on each screw.
- [ ] Secure assembly using lock washers and nuts (finger-tighten only for now).
- [ ] Install six 5/8" screws in remaining holes, securing with lock washers and nuts.
- [ ] Set assembly aside for later installation on resonator assembly.

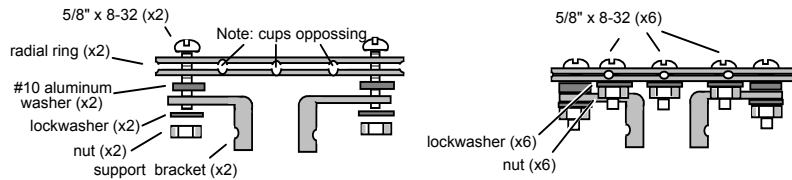

FIG-3: Assembly Detail, Capacitive Hat

### Step-4: Install the 160-meter loading coil on the insulated resonator tube.

|   |           |                                   |
|---|-----------|-----------------------------------|
| 1 | 126854    | Fiberglass resonator support tube |
| 1 | MA160VCA1 | 160-meter loading coil            |
| 2 | 105630    | Loading coil standoff spacer      |
| 2 | 010120    | 2" x 8-32 screw                   |
| 4 | 010011    | 8-32 nut                          |

- [ ] On the insulator tube, identify the two coil-mounting hole locations (middle holes at **A**, **B**).
- [ ] Install a 2" screw in each coil-mount hole and secure with a nut.
- [ ] Install a spacer on each of the two mounting studs.
- [ ] Find the loading coil and identify end with self-tapping screw securing the last turn (bottom of coil).
- [ ] Orienting as shown at **C**, slide coil over tube and drop onto mounting studs. Secure with nuts.

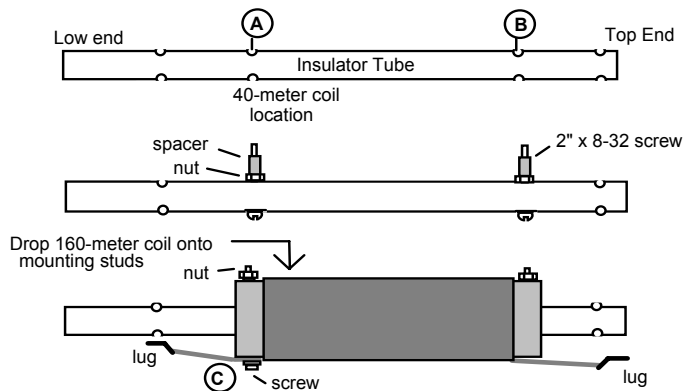

FIG-4: Mounting Loading Coil

**Step-5: Complete assembly of the top resonator section.**

|   |          |  |
|---|----------|--|
| 1 | -----    | Radial ring assembly (set aside from Step-3)     |
| 1 | MA160VBI | 1/2" OD x 35-7/8" resonator stub section (NS/2S) |
| 1 | MA160VBJ | 3/8" OD x 35-7/8" resonator stub section (NS/2S) |
| 1 | MA160VBK | 1/4" OD x 41" resonator stub section (solid rod) |
| 1 | 055105   | 1/4" vinyl end cap                               |
| 3 | 030407   | Small worm clamp                                 |
| 1 | 010123   | 1-1/2" x 8-32 screw                              |
| 1 | 010011   | 8-32 nut   |
| 1 | 902428   | Braid strap                                      |
| 1 | 156336   | 1/2" ID Resonator-stub bushing                   |

- [ ] Insert 1/2" tube **(BI)** into the 1/2" ID bushing and align screw holes (detail **A**).
- [ ] Install the bushing and tube inside fiberglass resonator tube. Align all screw holes **(B)**.
- [ ] Slide radial-ring assembly over outside of resonator tube, position with screw holes aligned **(C)**.
- [ ] Install 1-1/2" screw at **D** and capture coil-lead lug at bottom. Secure with nut, tighten firmly.
- [ ] Find braid strap and nip eye off one end, as shown at **(E)**.
- [ ] Using existing hardware on radial ring, attach braid strap at **(F)** and secure in place.
- [ ] Install small worm clamp on 1/2" tube **BI** and use to secure nipped end of braid.
- [ ] Install small worm clamp on top end of 1/2" tube **BI**, insert 3/8" tube **BJ** and secure **(G)**.
- [ ] Install small worm clamp on top end of 3/8" tube **BJ**, insert 1/4" rod **BK** and secure **(H)**.
- [ ] Slip 1/4" vinyl tip cap on end of 1/4" rod **BK** at **(I)**. Stub sections will be set to length later on.

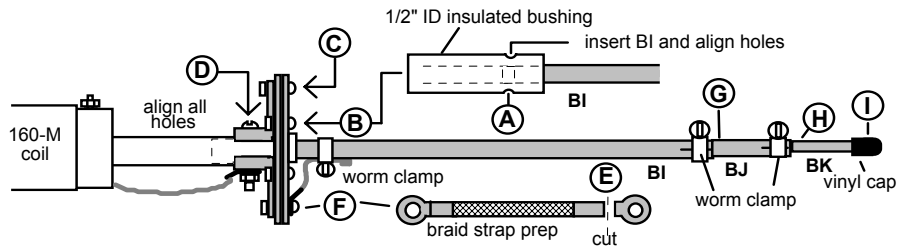

FIG-5: Stinger Assembly

**Step-6: Assemble the antenna radiator (see FIG-6).**

|   |           |   |
|---|-----------|---|
| 2 | MA8040VBB | Aluminum splice tube, 12" x 1-1/4" OD (NS/NS)         |
| 2 | MA8040VBC | Aluminum radiator section-2, 72" x 1-3/8" OD (4S/4S)  |
| 1 | MA8040VBD | Aluminum radiator section-3, 72" x 1-1/4" OD (NS/4S)  |
| 1 | MA8040VBE | Aluminum radiator section-4, 72" x 1-1/8" OD (NS/2SH) |
| 5 | 030412    | Large Worm clamp                                      |

- [ ] Find one 1-3/8"-OD radiator section **BC** and two 1-1/4"-OD splice tubes **BB**.
- [ ] Measure off 6" on both splice tubes **BB** and mark (locates center).
- [ ] On the 1-3/8" tube **BC**, insert a splice tube (**BB**) 6" *inside each end* and secure with worm clamps.
- [ ] Find the second 1-3/8"-OD radiator section **BC**. Splice to first section **BC** and secure with a worm clamp.
- [ ] Find the 1-1/4"-OD radiator section **BD**. Locate the un-slotted end, measure off 5-3/4" and mark.
- [ ] Insert **BD** 5-3/4" into the free end of **BC** and secure in place with a worm clamp.
- [ ] Find the 1-1/8" radiator section **BE**. Locate the un-slotted end, measure off 5-3/4" and mark.
- [ ] Insert **BE** 5-3/4" into **BD** and secure with a worm clamp.
- [ ] Adjust telescoped tubes **BC/BD** and **BD/BE**, as needed, to obtain a total length of 23' 6" (see **FIG-6**).

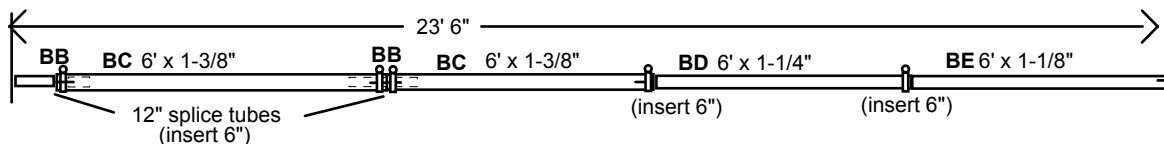

FIG-6: Radiator Assembly Diagram

**Step-7: Install the antenna guy supports.**

|   |          |  |
|---|----------|--|
| 1 | 030412   | Large worm clamp                         |
| 3 | 193631   | Guy bracket                              |
| 3 | 094259   | Guy rope thimble                         |
| 1 | MA160VGW | Guy line, coil 100' coil of Danscord-30D |

- [ ] Find a large worm clamp and install loosely on tube **BD** 3" below the junction with tube **BE**.
- [ ] Find the three (3) guy brackets and slide them under the worm clamp band as shown (**FIG-7A**).
- [ ] Position brackets around **BD** for equal spacing (120-degrees apart).
- [ ] Tighten worm clamp to secure guy brackets firmly in position.

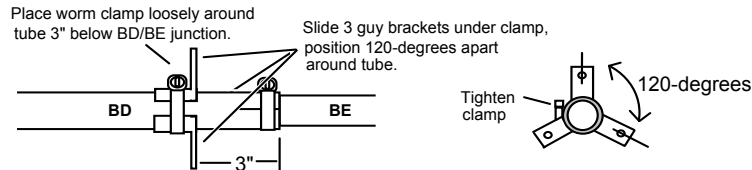

FIG-7A: Installation of Guy Brackets

- [ ] Find three (3) guy-line thimbles. Using a large flat-blade screwdriver, pry open ends (**FIG-7B**).
- [ ] Install a thimble on each of the three guy brackets. Re-close end to secure in place.
- [ ] Find the 100-foot coil of Danscord guy line. Uncoil and cut into three equal lengths (33' 4" each).
- [ ] Thread a line around each of the three thimbles, tying off as shown (use half hitches or a sailor's knot).
- [ ] Heat free end of each line with a match or small torch to prevent unraveling (do not touch until cool).
- [ ] Pull-test each line to ensure knot is secure.

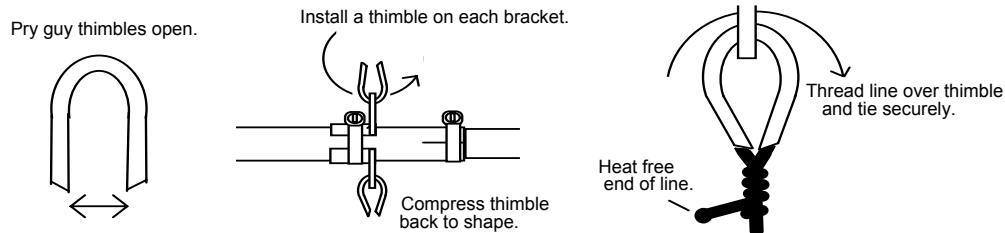

FIG-7B: Installing Thimbles and Guys

**Step-8: Install capacitive hat rods on resonator assembly.**

|   |        |                        |
|---|--------|------------------------|
| 8 | 221186 | Radial-rod, 0.1" x 48" |
| 8 | 056249 | Vinyl end cap          |

- [ ] Install a vinyl end cap on one end of each rod. Lubricate with soap--as needed--to insert.
- [ ] Loosen radial-ring hardware and install eight (8) rods, as shown (**FIG-8**).
- [ ] Tighten all hardware.

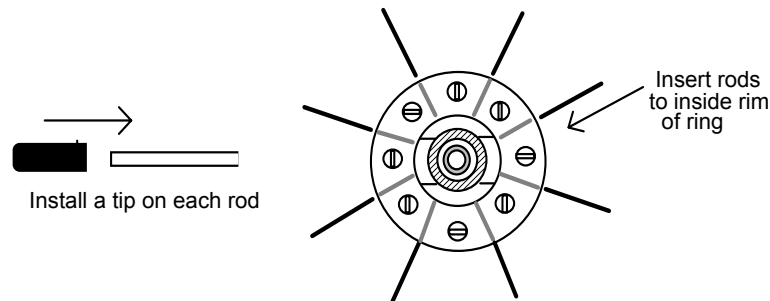

FIG-8: Radial Rod Installation

**Step-9: Construct a base support.**

When selecting a site, allow sufficient area to spread out radials and install guys. Confirm that, if toppled by accident, the antenna can fall in any direction without striking power wires. Also, ensure the top of the resonator will clear overhead branches when fully extended. The MA160V requires a stable ground support which must be constructed prior to raising the antenna. Any suitable post-style mount will work, but the antenna's aluminum base is especially designed to slip inside readily available 1-1/2" OD thin-wall steel galvanized conduit. This pipe can be purchased at most hardware stores. Drive into the ground for temporary set-ups, or set into a posthole and capture in concrete for a permanent installation (**FIG-9A, 9B**).

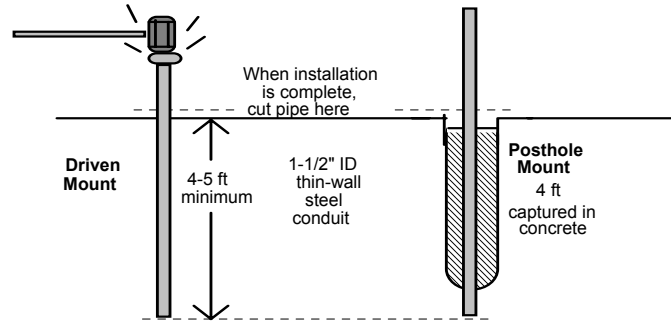

FIG-9A: Recommended Ground Supports

**Important Note:** Ensure inside of the conduit is free from concrete and other debris at least 10" below the top rim so the antenna base tube can seat full-length inside.

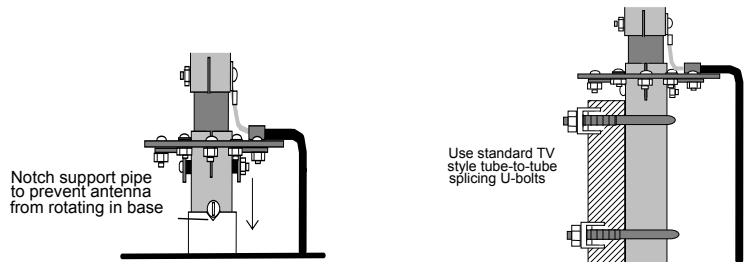

FIG-9B: Mounting Methods

**Step-10: Install resonator section on vertical radiator and pre-tune.**

- 1 010123 1-1/2" x 8-32 screw
- 1 010011 8-32 nut

- [ ] Slip fiberglass resonator tube inside the top of 1-1/8" radiator tube **BE** (**FIG-10**).
- [ ] Align the screw holes as shown.
- [ ] Using a 1-1/2" screw and 8-32 nut, secure resonator tube and coil wire in place. Tighten securely.

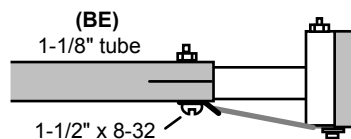

FIG-10: Resonator Installation Detail

- [ ] Loosen top-section worm clamps, set stinger length to desired band segment (ballpark adjustment):

**1.825 MHz = full extension    1.85 MHz = 88"    1.90 MHz = 72"    1.95 MHz = 56"    2.00 MHz = 42"**

### STEP-11: Install three guy-anchor stakes.

3 195179 Guy anchor stakes

- [ ] Using a compass and measuring tape, lay out three 15-foot guy-line paths spaced 120-degrees apart.
- [ ] At the far end of each path, drive a guy-line anchor stake--angling it away from the antenna as shown.

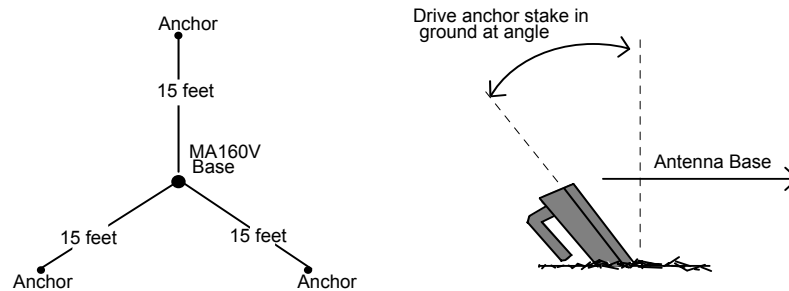

FIG-11: Guy-line Anchor Stake Installation

### Step 12: Install antenna on base section.

1 030412 Large Worm clamp

- [ ] Slip large worm clamp on radiator section **BAT**, securing temporarily below compression slots (**FIG-12A**).
- [ ] Untangle guy lines and spread out so they will drop freely to the ground when the antenna is raised.
- [ ] Raise vertical radiator with the bottom end **BB** butted into the ground next to the base.
- [ ] Steady the radiator in position next to the base until vertical and stable.
- [ ] Lift the radiator vertically and insert protruding splice **BB** tube into base section **BAT** (2-person job).
- [ ] Loosen and slide the worm clamp up into position over slots of **BAT** and tighten in place.
- [ ] Walk each guy line out to its anchor and tie in place as shown in **FIG-12B**.

**Important Warning: Never attempt to raise the MA160V without assistance. The un-guyed radiator is top-heavy and may become difficult to control without an extra pair of hands.**

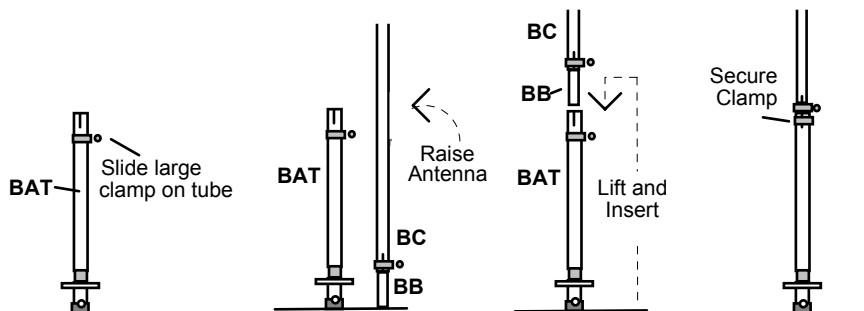

FIG-12A: Installing Antenna Radiator

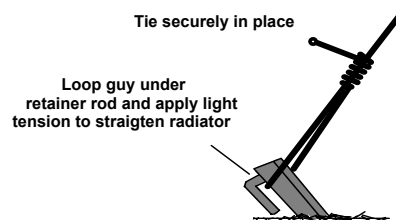

FIG-12B: Tying Off Guys to Anchor Stakes

TA5FA



### Step-13: Connect feedline to antenna base.

2      100449      Solder lug

Prepare coax, as shown in **FIG-13**. Attach center conductor to main radiator and shield to ground radial ring using solder lugs. For best weather protection, flood braid with a weather-resistant liquid sealant such as Liquid Tape™. This will prevent water from entering the coax and wicking along the shield. Coil several turns of coax next to the antenna base or install a choke-style current balun at the feed point (see **Appendix-1** for instructions). Feedline leading to station may be buried between radials.

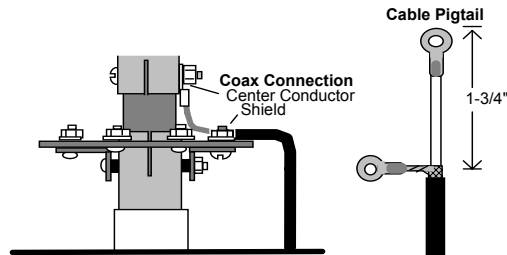

FIG-13: Feedline Connection

### Step-14: Install ground radials

**Basic System:** This set-up works especially well for installing the MA160V within the confines of a typical residential house lot (**FIG-14A**). You'll begin by installing 3 primary radials, then continue to add more—as needed—until achieving a feed resistance of approximately 50 Ohms (or minimum SWR). Radials need not be of equal length and may be arranged to fit the shape of your yard. The total number of wires needed depends on local soil conductivity and the cut lengths used. Where possible, bury each wire 2-4 inches below the surface to prevent breakage and to avoid creating a trip hazard for others. A turf cutter or edger may be used to open a narrow slit in the ground. Radials may be routed around trees, buildings and other landscaping features as needed. A symmetrical layout is best, but not essential. For best results, follow the installation procedure below:

- [ ] Cut a set of three primary radials to fit available space (20-50 feet long).
- [ ] Scrape off enamel and install a #8 lug on one end of each wire. Solder in place.
- [ ] Install the primary radial wires approximately 120-degrees apart and connect each to the radial ring.
- [ ] Connect a SWR analyzer to the coax feed and tune the frequency control to find minimum SWR.
- [ ] Prepare and add more radials (15-40 feet long), one at a time, while continuing to monitor SWR.
- [ ] Stop adding radials when SWR approximates 1:1.
- [ ] Retune the antenna's stinger section for best SWR on your frequency of choice.

**Notes:** Remember to retune the frequency control of the analyzer after adding each radial—the SWR dip should migrate down slightly in frequency as each new radial is added. Once the lowest SWR reading possible has been obtained, continuing to install radials will cause SWR to rise again as the feed resistance decreases below 50 Ohms. It may be possible to trim or add one or more short radial, as needed, to obtain flat 1:1 SWR. The lower the minimum SWR reading, the wider the usable bandwidth will be. Once the radial field is set in place, note that SWR may fluctuate slightly over time with changes in soil moisture, but you should be able to achieve low SWR in all parts of the band by changing only the resonator stinger setting. The MA-160V should also perform well over the radial system prescribed for the MA8040V.

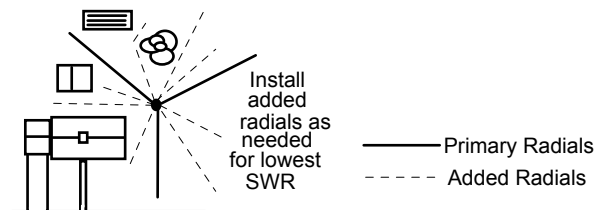

FIG-14A: Example of Basic Residential Radial Installation

**2. Enhanced System:** You may also install the MA160V over a more robust radial system (**FIG-14B**). Benefits include a somewhat lower take-off angle plus higher radiating efficiency because of reduced ground losses. In order to implement a larger system, you'll need more open space plus significantly more radial wire than the 400 feet provided with the antenna. You'll also need to install some type of matching network to compensate for the system's lower feedpoint resistance. The ARRL Antenna Book and many other publications offer detailed instructions describing radial field construction and vertical antenna matching techniques. Extra radial wire may come from any surplus source as long as it is jacketed or enameled and strong enough to avoid breakage. Several matching options are possible including a shunt inductor, fixed-ratio Ununn, transmission line transformer, or adjustable L-network. The best matching technique will depend on factors like the transformation ratio needed and the amount of power you intend to run.

Generally, for a loaded antenna like the MA160V, a dense ground system with a large number of shorter wires will perform better than a full-sized  $\frac{1}{4}$ -wave system with fewer radials. The layout described below should work well. For best results, install as described:

- [ ] Cut 16 primary radials of 50 to 60 feet in length.
  - [ ] Scrape or remove insulation at one end and install a #8 solder lug on each.
  - [ ] Lay these radials out in a symmetrical pattern around the base and connect each to the radial ring.
  - [ ] Check the feedpoint resistance with a handheld analyzer using the "vector impedance" function\*.
  - [ ] Continue adding radials, filling in between the primary set, while periodically checking resistance.
  - [ ] If using a fixed-ratio matching transformer, add radials until you reach a convenient transformation value.
  - [ ] If using an adjustable network, add radials until you reach the point of diminishing returns (64 max).
- \* See notes below

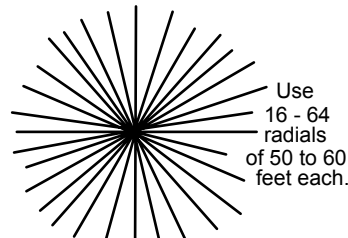

FIG-14B: Example of High-Efficiency Radial System

**Notes:** When monitoring feedpoint resistance, disconnect the station feedline and connect the analyzer directly to the antenna terminals through a short pigtail (making these measurements through a long feed will transform readings to erroneous values). Also, note that shunt-coil matching systems will introduce inductive reactance that lowers the system's resonant operating frequency. Readjustment of the stinger will be needed to compensate for this downward frequency shift.

**Housekeeping:** When the radial installation is complete, inspect the base area for looped or hanging wires that may pull loose or become broken at a later time. Trim or bury any excess (see **FIG-14C**). Also, confirm that all radial ring screws are fully tightened.

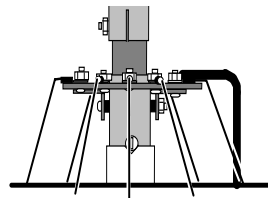
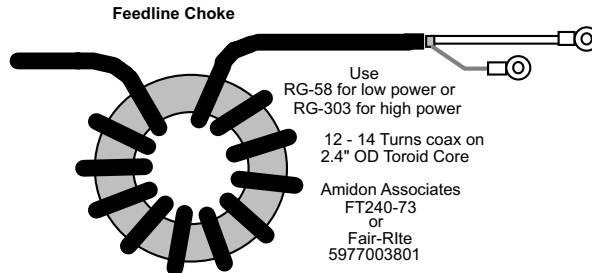

FIG-14C: Dress Radial Leads, Check Hardware

**Resonator Tuning:** The telescoping stinger above the capacitive hat was designed to provide tuning over the full 160 Meter band. However, tuning range may be impacted by external factors such as soil conductivity, radial field irregularities, and proximity to other antennas or metallic objects. In the event you experience difficulty tuning to the bottom of the band, attach a thin wire between the tips of two or three capacitive hat rods to extend tuning range. Conversely, you may remove a hat rod to extend coverage at the high end of the band.

## Appendix 1: How to make a Current-Choke Balun using a Toroid Form:

A current-choke style balun may be used to prevent the antenna's feedline from interacting with the antenna and radial system. Best SWR performance was obtained by installing a choke such as the one shown here at the antenna base.



### MA160V Specifications:

|                     |   |
|---------------------|---|
| Frequency Coverage: | 1.8 – 2.0 MHz   |
| Impedance:          | 50-Ohms   |
| SWR:                | 1.1:1 typical at resonance                                      |
| Bandwidth (2:1 SWR) | 40 kHz  |
| Height:             | 30-36 feet—height adjustable                                    |
| Weight:             | 12 lbs (5.44 kG)  |
| Gain:               | 0 dBi over ideal ground, -6 dBi minimal radials, average ground |
| Ground Radials:     | See installation instructions                                   |

#### LIMITED WARRANTY

CUSHCRAFT CORPORATION, P.O. BOX 4680, MANCHESTER, NEW HAMPSHIRE 03108, WARRANTS TO THE ORIGINAL CONSUMER PURCHASER FOR TWO YEARS FROM DATE OF PURCHASE THAT EACH CUSHCRAFT ANTENNA IS FREE OF DEFECTS IN MATERIAL OR WORKMANSHIP. IF, IN THE JUDGMENT OF CUSHCRAFT, ANY SUCH ANTENNA IS DEFECTIVE, THEN CUSHCRAFT CORPORATION WILL, AT ITS OPTION, REPAIR OR REPLACE THE ANTENNA AT ITS EXPENSE WITHIN THIRTY DAYS OF THE DATE THE ANTENNA IS RETURNED (AT PURCHASER'S EXPENSE) TO CUSHCRAFT OR ONE OF ITS AUTHORIZED REPRESENTATIVES. THIS WARRANTY IS IN LIEU OF ALL OTHER EXPRESSED WARRANTIES, ANY IMPLIED WARRANTY IS LIMITED IN DURATION TO ONE YEAR. CUSHCRAFT CORPORATION SHALL NOT BE LIABLE FOR ANY INCIDENTAL OR CONSEQUENTIAL DAMAGES WHICH MAY RESULT FROM A DEFECT. SOME STATES DO NOT ALLOW LIMITATIONS ON HOW LONG AN IMPLIED WARRANTY LASTS OR EXCLUSIONS OR LIMITATIONS OF INCIDENTAL OR CONSEQUENTIAL DAMAGES, SO THE ABOVE LIMITATION AND EXCLUSION MAY NOT APPLY TO YOU. THIS WARRANTY GIVES YOU SPECIFIC LEGAL RIGHTS, AND YOU MAY ALSO HAVE OTHER RIGHTS WHICH VARY FROM STATE TO STATE. THIS WARRANTY DOES NOT EXTEND TO ANY PRODUCTS WHICH HAVE BEEN SUBJECT TO MISUSE, NEGLIGENCE, ACCIDENT OR IMPROPER INSTALLATION, ANY REPAIRS OR ALTERATIONS OUTSIDE OF THE CUSHCRAFT CORPORATION FACTORY WILL NULLIFY THIS WARRANTY.

SPECIFICATIONS SUBJECT TO CHANGE WITHOUT NOTICE

#### WARRANTY AND LIABILITY

Cushcraft Corporation shall not be liable for any incidental or consequential damages which may result from a defect, or use, improper or otherwise or installation, improper or otherwise.  
Please contact your vendor for technical support and warranty service.



48 Perimeter Road  
Manchester, NH 03103  
603-627-7877  
FAX 603-627-1764

SPECIFICATIONS SUBJECT TO CHANGE WITHOUT NOTICE

# TA5FA