

TEN-3

**10 METER
3 ELEMENT YAGI**



951359 (4/89)

TA5FA

Your Cushcraft 10 meter beam is designed and manufactured to give top performance and trouble free service. The antenna will perform as specified if the instructions and suggestions are followed and care is used in assembly and installation. When checking the components received in your antenna package use the parts lists in each section. It is easiest to identify the various dimensions of tubing by separating them into groups of the same diameter and length. If you are unable to locate any tube or component, check the inside of all tubing. **IMPORTANT:** save the weight label from the outside of the carton. Each antenna is weighed at the factory to verify the parts count. If you claim a missing part, you will be asked for the weight verification label. There is a master parts list on page 3.

LOCATION

Location of the antenna is very important. Surrounding objects such as trees, power lines, other antennas, etc. will seriously reduce efficiency. To minimize the effects of surrounding objects, mount the antenna as high and in the clear as possible. If metal guy wires are used, they should be broken with strain insulators.

WARNING: THIS ANTENNA IS AN ELECTRICAL CONDUCTOR. CONTACT WITH POWER LINES CAN RESULT IN DEATH, OR SERIOUS INJURY. DO NOT INSTALL THIS ANTENNA WHERE THERE IS ANY POSSIBILITY OF CONTACT WITH OR HIGH VOLTAGE ARC-OVER FROM POWER CABLES OR SERVICE DROPS TO BUILDINGS. THE ANTENNA, SUPPORTING MAST AND/OR TOWER MUST NOT BE CLOSE TO ANY POWER LINES DURING INSTALLATION, REMOVAL OR IN THE EVENT PART OF THE SYSTEM SHOULD ACCIDENTALLY FALL. FOLLOW THE GUIDELINES FOR ANTENNA INSTALLATIONS RECOMMENDED BY THE U.S. CONSUMER PRODUCT SAFETY COMMISSION AND LISTED IN THE ENCLOSED PAMPHLET.

Plan your installation carefully. If you use volunteer helpers be sure that they are qualified to assist you. Make certain that everyone involved understands that you are the boss and that they must follow your instructions. If you have any doubts at all employ a professional antenna installation company to install your antenna.

MOUNTING

The mast mount bracket will accommodate up to a 1-7/8" OD (4.8 cm) mast. A 1 1/2" OD (3.8 cm) or larger heavy wall tubing mast should be used. A good heavy duty antenna rotator will provide the best service and longest life. Often it is desirable to mount several antennas on one mast. To keep possible interaction to a minimum, place your antennas as far apart as you can. If you plan to install the antenna in a salty or corrosive environment, you may want to consider coating it with a clear marine varnish or equivalent.

SYSTEM GROUNDING

Direct grounding of the antenna, mast and tower is very important. This serves as protection from lightning strikes and static buildup, and from high voltage which is present in the radio equipment connected to the antenna. A good electrical connection should be made to one or more ground rods (or other extensive ground system) directly at the base of the tower or mast, using at least 10AWG ground wire and non-corrosive hardware. For details and safety standards, consult the National Electrical Code. You should also use a coaxial lightning arrester. Cushcraft offers several different models, such as LAC-1, LAC-2 and the LAC-4 series.

TUNING PROCEDURE

If you wish to check the SWR before installation, please observe the following procedures. Temporarily mount the antenna with the boom vertical, reflector at least one foot (30 cm) off the ground on a non-metallic support (wooden box), to prevent detuning the antenna. Guy the top of the boom. Do not use line with wire in it (some clotheslines have a wire core). Keep other antennas, metal objects and guy lines clear of the antenna under test. Do not attempt to tune the Yagi near the ground with the boom parallel to the ground since ground effects will nullify any adjustment and degraded performance will result.



Run the coax cable from your transmitter to the area in which the antenna is going to be tested. The length of this cable or your feedline is not critical. Connect a good quality SWR bridge to the end of this cable. Connect a short length of cable [2 feet (61 cm) or less] from the SWR bridge to the antenna. Set the transmitter to your center operating frequency. When you read SWR, be sure you move far enough away from the antenna so that your body does not effect the reading.

Measure the SWR. If it is high, move the Reddi-Match clamp (584) by 1/4" (.6 cm) in one direction and check the SWR, if the SWR improved then continue moving the Reddi-Match clamp in the same direction. If the SWR deteriorated then move the Reddi-Match clamp in the opposite direction.

When no further improvement can be made you have matched your antenna to 50 Ohms. Then tighten all connections on the Reddi-Match assembly. Tape the feedline to the boom and mast.

MASTER PARTS LIST

KEY	PART #	DESCRIPTION	QTY	KEY	PART #	DESCRIPTION	QTY
1	020001	2-1/4" x 3" (5.7 x 7.6 cm) steel U-bolt	2	599	192599	Aluminum U-bolt bracket	3
5	020005	5/16" (.79 cm) steel lock washer	4	326		Danger label	1
6	020006	5/16" (.79 cm) steel hex nut	4	419	030419	3/4" (1.9 cm) steel hose clamp	6
9	010009	8-32 x 5/8" (1.6 cm) stainless steel round head slotted machine screw	2	584	202584	3/8" x 5/8" (.95 x 1.58 cm) Reddi-Match strap	1
10	010010	#8 stainless steel internal tooth lock washer	3	635	031635	5/8" (1.58 cm) steel hose clamp	6
11	010011	8-32 stainless steel hex nut	3	CB		Coaxial connector bracket assembly	1
13	050013	1-1/4" (3.18 cm) black plastic cap	2			Reddi-Match tube assembly	1
15	020015	1/4" (.63 cm) flat washer	4	BA		1-3/8" x 6" (3.49 x 15.2 cm) aluminum tubing slotted both ends	1
16	020016	1/4" (.63 cm) steel lock washer	10	BB		1-1/4" x 48" (3.18 x 121.9) aluminum tubing	2
17	020017	1/4" x 20 (.63 cm) steel hex nut	10	EA		3/4" x 48" (1.9 x 121.9 cm) aluminum tubing drilled for U-bolt and slotted both ends	3
53	050053	1/2" (1.27 cm) black plastic cap	6	EB		5/8" x 48" (1.58 x 121.9 cm) aluminum tubing slotted one end	6
70	190070	4" x 6" (10.16 x 15.24 cm) formed aluminum plate	1	EC		1/2" x 42" (1.27 x 106.7 cm) aluminum tubing	2
73	020073	1-3/4" x 3" (4.4 x 7.6 cm) steel U-bolt	5	ED		1/2" x 32" (1.27 x 81.3 cm) aluminum tubing	2
115	050115	Connector boot	1	EE		1/2" x 30" (1.27 x 76.2 cm) aluminum tubing	2
116	240116	Silicone Package	1				
118	010118	5/16" (.8 cm) stainless steel hex nut	8				

KEY	P/N	DISPLAY	DESC	SIZE	QTY
BA			ALUM TUBE	1-3/8" x 6" (3.49 x 15.2 cm)	1
BB			ALUM TUBE	1-1/4" x 48" (3.18 x 121.9 cm)	2
13	050013		PLASTIC CAP	1-1/4" (3.18 cm)	2

#1 - BOOM ASSEMBLY

Insert the BB and BC tubes into the BA tube 3" (7.6 cm). Push the end caps (13) onto each end of the boom.

FIGURE A

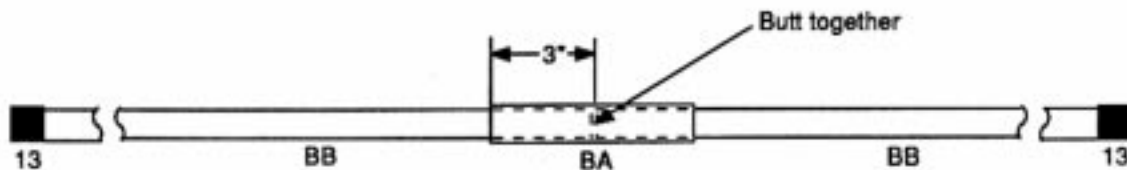

#2 - ELEMENT ASSEMBLY

Place a hose clamp (419) on the end of each EA tube. Insert the EB tubes 3" (7.6 cm) into each end of the EA tubes. Tighten the clamps securely. On the driven element, slide on the Reddi-Match strap (584) as far as it will go. Place a hose clamp (635) on the slotted end of each EB tube. Insert the EC, ED and EE tubes into the appropriate element sections according to Figure B below. Adjust the element tips to the dimensions listed in Chart A. Tighten all hose clamps. Install caps (53) on element tips.

FIGURE B

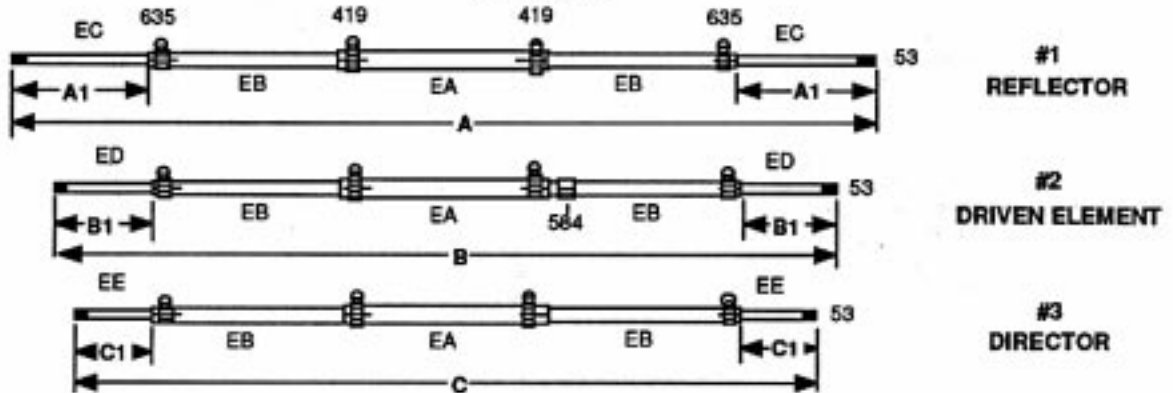

KEY	P/N	DISPLAY	DESC	SIZE	QTY	KEY	P/N	DISPLAY	DESC	SIZE	QTY
EA			ALUM TUBE	3/4" x 48" (1.9 x 121.9 cm)	3	EE			ALUM TUBE	1/2" x 30" (1.27 x 76.2 cm)	2
EB			ALUM TUBE	5/8" x 48" (1.58 x 121.9)	6	584	202584		REDDI-M STRAP	3/8 x 5/8" (.95 x 1.58 cm)	1
EC			ALUM TUBE	1/2" x 42" (1.27 x 106.7)	2	53	050053		PLASTIC CAP	1/2" (1.27 cm)	6
ED			ALUM TUBE	1/2" x 32" (1.27 x 81.3 cm)	2	635	031635		HOSE CLAMP	5/8" (1.58 cm)	6
						419	030419		HOSE CLAMP	3/4" (1.9 cm)	6

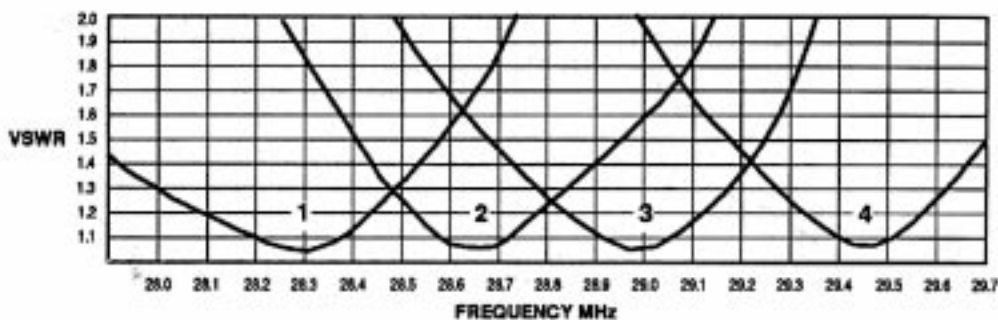

CHART A

FREQUENCY MHz	28.000 - 28.750		28.250 - 29.150		28.550 - 29.350		29.000 - 29.700	
	in.	cm	in.	cm	in.	cm	in.	cm
A	216	548.6	214	543.7	211-1/2	537.2	208	528.3
A1	39	99.1	38	96.5	36-3/4	93.3	35	88.9
B	196	497.8	194	492.8	192	487.7	188-1/2	478.8
B1	29	73.7	28	71.1	27	68.6	25-1/4	64.1
C	192	487.7	190	482.6	188	477.5	185	469.9
C1	27	68.6	26	73.7	25	63.5	23-1/2	59.6

#3 - ELEMENT MOUNTING

Mount the element/boom brackets as shown in figure C and E. Position the elements on the boom as shown in figure D. The longest element (reflector) is #1. Align the elements and tighten the U-bolts. Note that the driven element backing plate includes the connector bracket (CB) (figure E). This should be mounted with the connector pointing to the center of the boom to allow easy connection of the feedline.





KEY	P/N	DISPLAY	DESC	SIZE	QTY
17	020017		HEX NUT	1/4"-20 (.63 cm)	4
16	020016		LOCK WASHER	1/4" (.63 cm)	4
599	192599		U-BOLT BRACKET		2
73	020073		U-BOLT	1-3/4" x 3" (4.44 X 7.62 cm)	2

FIGURE C

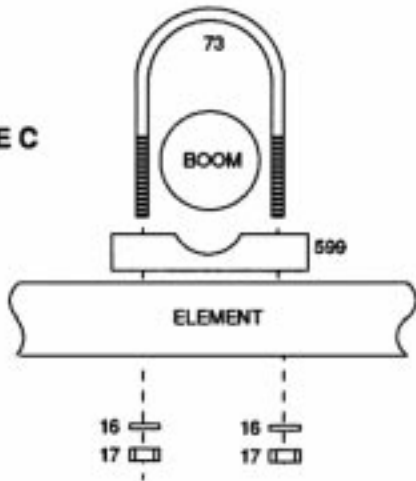
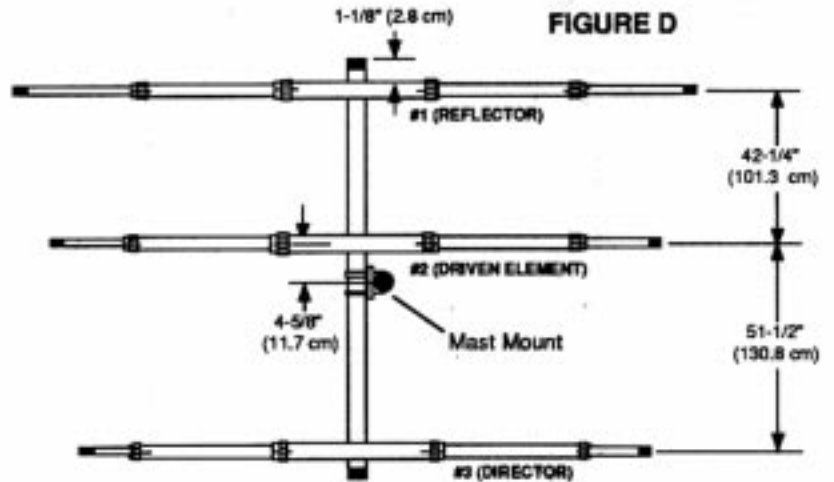

FIGURE D



#4 - REDDI MATCH ASSEMBLY

Mount the Reddi Match to the driven element #2 as shown in figure E.



















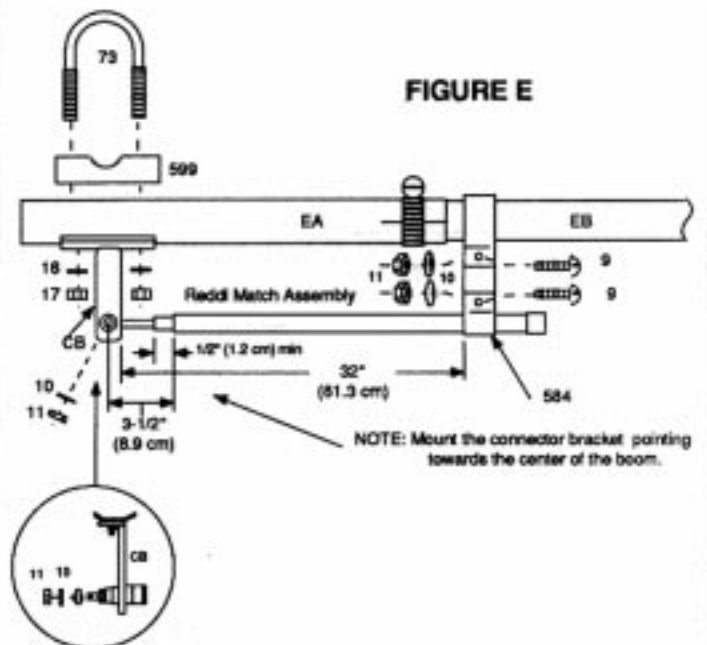

KEY	P/N	DISPLAY	DESC	SIZE	QTY
9	010009		SS MACHINE SCREW	8-32 x 5/8" (1.6 cm)	2
10	010010		SS LOCK WASHER	#8	3
11	010011		SS HEX NUT	8-32	3
584	202584		REDDI-M CLAMP	3/8 x 5/8" (.95 x 1.58 cm)	1
16	020016		LOCK WASHER	1/4" (.63 cm)	2
17	020017		HEX NUT	1/4"-20 (.63 cm)	2
599	192599		U-BOLT BRACKET		1
73	020073		U-BOLT	1-3/4" x 3" (4.44 x 7.62 cm)	1
CB			CONNECTOR BRACKET		1
REDDI MATCH			REDDI MATCH ASSEMBLY		1

FIGURE E





KEY	P/N	DISPLAY	DESC	SIZE	QTY
5	020005		LOCK WASHER	5/16" (.8 cm)	4
6	020006		HEX NUT	5/16" (.8 cm)	4
70	190070		ALUM PLATE	4" x 6" (10.2 x 15.2 cm)	1
326	290326		DANGER LABEL		1
73	020073		U-BOLT	1-3/4" x 3" (4.44 x 7.6 cm)	2
1	020001		U-BOLT	2-1/4" x 3" (5.7 X 7.6 cm)	2
15	020015		FLAT WASHER	1/4" (.63 cm)	4
16	020016		LOCK WASHER	1/4" (.63 cm)	4
17	020017		HEX NUT	1/4"-20 (.63 cm)	4

#5 - BOOM TO MAST ASSEMBLY

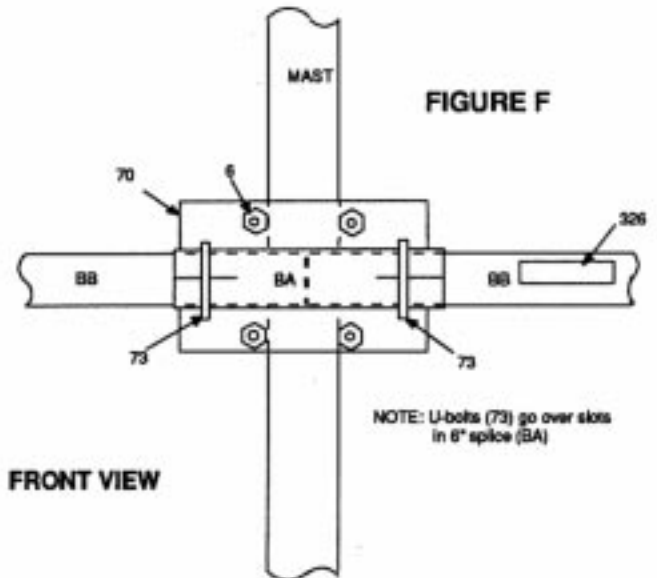
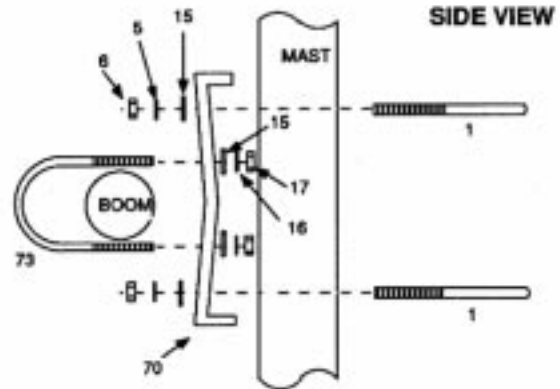
Assemble and mount the boom to mast bracket assembly at the balance point. Refer to figure D for the approximate balance point and figure F for assembly.



KEY	P/N	DISPLAY	DESC	SIZE	QTY
115	050115		CONN BOOT		1
116	240116		SILICONE PACKAGE		1

#6 - FEEDLINE ASSEMBLY

Before attaching the feedline permanently, tune the antenna as outlined on page 2. The antenna is designed for use with 50 Ohm coaxial cable terminated with a PL-259 connector. Any length of feedline can be used with your Yagi. The shortest length cable will have the least loss. A connector boot is included for use with your new antenna. See figure G. Slide the boot over the cable before attaching your PL-259. Coat only the outside connector threads and shell with silicone grease. Do not coat the center pin or receptacle. After the PL-259 is firmly screwed on to the antenna connector, slide the vinyl boot over the connector and against the mast bracket.

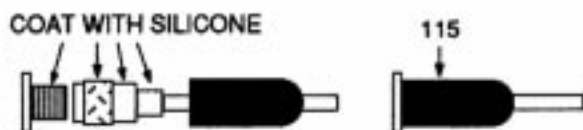

FIGURE G

SPECIFICATIONS

Forward Gain	8 dBd
Front to Back Ratio	>20 dBd
SWR Typical	< 1.5 : 1
Boom Length	8 ft. (2.44 m)
Longest Element	18 ft. (5.49 m)
Turning Radius	9 ft. 9-3/4 in. (2.99 m)
Wind Surface Area	2.24 ft sq. (.21 m sq.)
Weight	9.9 lb. (4.5 kg)

LIMITED WARRANTY

Cushcraft Corporation, P.O. Box 4680, Manchester, New Hampshire 03108, warrants to the original consumer purchaser for one year from date of purchase that each Cushcraft antenna is free of defects in material or workmanship. If, in the judgement of Cushcraft, any such antenna is defective, then Cushcraft Corporation will, at its option, repair or replace the antenna at its expense within thirty days of the date the antenna is returned (at purchasers expense) to Cushcraft or one of its authorized representatives. This warranty is in lieu of all other expressed warranties, any implied warranty is limited in duration to one year. Cushcraft Corporation shall not be liable for any incidental or consequential damages which may result from a defect. Some states do not allow limitations on how long an implied warranty lasts or exclusions or limitations of incidental or consequential damages, so the above limitation and exclusion may not apply to you. This warranty gives you specific legal rights, and you may also have other rights which vary from state to state. This warranty does not extend to any products which have been subject to misuse, neglect, accident or improper installation. Any repairs or alterations outside of the Cushcraft factory will nullify this warranty.



48 PERIMETER ROAD, MANCHESTER, NH 03108
603-627-7877 / TELEX 4949472 / FAX 603-627-1764

SPECIFICATIONS SUBJECT TO CHANGE WITHOUT NOTICE

TA5FA