

ASSEMBLY AND INSTALLATION

A50-3S

**3 ELEMENT
6 METER BEAM**



CUSHCRAFT
COMMUNICATIONS ANTENNAS

TA5FA
951364 (12/94)

WARNING

THIS ANTENNA IS AN ELECTRICAL CONDUCTOR. CONTACT WITH POWER LINES CAN RESULT IN DEATH, OR SERIOUS INJURY. DO NOT INSTALL THIS ANTENNA WHERE THERE IS ANY POSSIBILITY OF CONTACT WITH OR HIGH VOLTAGE ARC-OVER FROM POWER CABLES OR SERVICE DROPS TO BUILDINGS. THE ANTENNA, SUPPORTING MAST AND/OR TOWER MUST NOT BE CLOSE TO ANY POWER LINES DURING INSTALLATION, REMOVAL OR IN THE EVENT PART OF THE SYSTEM SHOULD ACCIDENTALLY FALL. FOLLOW THE GUIDELINES FOR ANTENNA INSTALLATIONS RECOMMENDED BY THE U.S. CONSUMER PRODUCT SAFETY COMMISSION AND LISTED IN THE ENCLOSED PAMPHLET.

Your Cushcraft 6 meter beam is designed and manufactured to give top performance and trouble free service. The antenna will perform as specified if the instructions and suggestions are followed and care is used in assembly and installation. When checking the components received in your antenna package use the parts lists in each section. It is easiest to identify the various dimensions of tubing by separating them into groups of the same diameter and length. If you are unable to locate any tube or component, check the inside of all tubing. **IMPORTANT:** save the weight label from the outside of the carton. Each antenna is weighed at the factory to verify the parts count. If you claim a missing part, you will be asked for the weight verification label. There is a master parts list on page 2.

LOCATION

Location of the antenna is very important. Surrounding objects such as trees, power lines, other antennas, etc. will seriously reduce efficiency. To minimize the effects of surrounding objects, mount the antenna as high and in the clear as possible. If metal guy wires are used, they should be broken with strain insulators. **YOU MUST INSURE THAT NEITHER PEOPLE NOR PETS CAN COME IN CONTACT WITH YOUR ANTENNA WHILE IT IS IN OPERATION. DEADLY VOLTAGES AND CURRENTS MAY EXIST. ALSO, SINCE THE EFFECTS OF EXPOSURE TO RF ARE NOT FULLY UNDERSTOOD, LONG TERM EXPOSURE TO INTENSE RF FIELDS IS NOT RECOMMENDED. THERE IS A WARNING STICKER WHICH MUST BE ATTACHED TO THE BOOM AS SHOWN IN FIGURE E.**

Plan your installation carefully. If you use volunteer helpers be sure that they are qualified to assist you. Make certain that everyone involved understands that you are in charge and that they must follow your instructions. If you have any doubts at all employ a professional antenna installation company to install your antenna.

MOUNTING

The mast mount bracket will accommodate up to a 2" OD (5.1 cm) mast. A 1-1/2" OD (3.8 cm) or larger heavy wall tubing mast should be used. A good heavy duty antenna rotator will provide the best service and longest life. Often it is desirable to mount several antennas on one mast. To keep possible interaction to a minimum, place your antennas as far apart as you can.

SYSTEM GROUNDING

Direct grounding of the antenna, mast and tower is very important. This serves as protection from lightning strikes and static buildup, and from high voltage which is present in the radio equipment connected to the antenna. A good electrical connection should be made to one or more ground rods (or other extensive ground system) directly at the base of the tower or mast, using at least #10AWG ground wire and non-corrosive hardware. For details and safety standards, consult the National Electrical Code. You should also use a coaxial lightning arrester. Cushcraft offers several different models, such as LAC-1, LAC-2 and the LAC-4 series.

ASSEMBLY

Assemble your antenna by following the directions and illustrations in steps 1 through 5. Vertical polarization is normally used FM. After the antenna is completely assembled, verify dimensions and element spacings for accuracy. Then, return to the section below for final tuning.

TUNING PROCEDURE

The A50-3S does not normally require tuning after assembly. However, if you wish to check the VSWR before installation, please observe the following procedures. To prevent detuning the antenna, it should be tuned in place or at least 20 feet (6.1 meters) above ground and clear of surrounding objects. Keep all metal obstructions such as guy wires and other antennas at least 20 feet (6.1 m) away since they will nullify any adjustment and degraded performance will result.

Run the coax cable from your transmitter to the area in which the antenna is going to be tested. The length of this cable or your feedline is not critical. Connect a good quality VSWR bridge to the end of this cable. Connect a short length of cable [10 ft (305 cm) or less] from the VSWR bridge to the antenna. Set the transmitter to your center operating frequency. When you read VSWR, be sure you move far enough away from the antenna so that your body does not effect the reading.

Measure the VSWR. If it is high, move the Reddi-Match clamp (69) by 1/4" (.6 cm) in one direction and check the VSWR. If the VSWR improved, then continue moving the Reddi-Match clamp in the same direction. If the VSWR deteriorated then move the Reddi-Match clamp in the opposite direction. Repeat this procedure until no further improvement can be made. You have matched your antenna to 50 Ohms. Then tighten all connections. Tape the feedline to the mast as shown in figure G.

TA5FA





MASTER PARTS LIST

KEY	P/N	DESCRIPTION	QUANTITY
9	010009	8-32 x 5/8" (1.59 cm) stainless steel machine screw	2
11	010011	8-32 stainless steel hex nut	3
13	050013	1-1/4" (3.17 cm) plastic cap	2
27	050027	5/8" (1.59 cm) plastic caps	6
32	190032	1-1/2" (3.8 cm) heavy duty U-bolt brackets	3
33	190033	1-1/2" (3.8 cm) U-bolt backing plate	2
69	200069	Formed aluminum tuning strap	1
70	190070	4" x 6" (10.2 x 15.2 cm) formed mast plate	1
84	010084	1/4" (.63 cm) stainless steel lock washer	6
85	010085	1/4" (.63 cm) stainless steel hex nut	6
115	050115	Connector boot	1
116	240116	Silicone package	1
118	010118	5/16" (.8 cm) stainless steel hex nut	8
119	010119	5/16" (.8 cm) stainless steel lock washers	8
326	290326	Danger label	1
402	010402	1-1/2" (3.8 cm) stainless steel U-bolt	3
403	010403	1-5/8" (4.13 cm) stainless steel U-bolt	2
404	010404	2-1/8" (5.4 cm) stainless steel U-bolt	2
409	030409	3/4" (1.9 cm) stainless steel worm clamps	6
412	030412	1-3/8" (3.49 cm) stainless steel worm clamps	2
941	011941	#8 stainless steel internal tooth lock washer	3
AA		1-3/8" x 8" (3.49 x 20.3 cm) aluminum tubing, slotted both ends	1
BB		1-1/4" x 42" (3.17 x 106.7 cm) aluminum tubing	1
CC		1-1/4" x 30" (3.17 x 76.2 cm) aluminum tubing	1
EA		3/4" x 48" (1.9 x 121.9 cm) aluminum tubing slotted both ends, drilled for U-bolt	3
EB		5/8" x 37-1/2" (1.6 x 95.2 cm) aluminum tubing	2
EC		5/8" x 34-1/4" (1.6 x 87.0 cm) aluminum tubing	2
ED		5/8" x 31-1/2" (1.6 x 80.0 cm) aluminum tubing	2
CB		Connector bracket	1
RM		Reddi Match tube	1

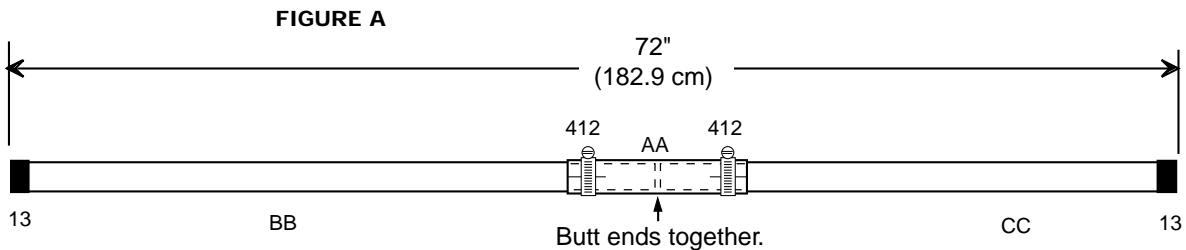
#1 - BOOM ASSEMBLY

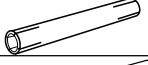
Place telescope clamps (412) over the slotted ends of tube AA. Slide BB and CC 3 inches (7.62 cm) into AA so that they butt in the middle. Tighten clamps and attach end caps (13).

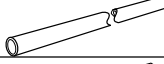

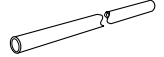
KEY	P/N	DISPLAY	DESC	SIZE	QTY	KEY	P/N	DISPLAY	DESC	SIZE	QTY
AA			ALUM TUBE	1-3/8" X 8" (3.5 x 20.3 cm)	1	13	050013		PLASTIC CAP	1-1/4" (3.2 cm)	2
BB			ALUM TUBING	1-1/4" x 42" (3.17 x 106.7 cm)	1	412	030412		SS WORM CLAMP	1-3/8" (3.5 cm)	2
CC			ALUM TUBE	1-1/4" x 30" (3.17 x 76.2 cm)	1						

TA5FA

#2 - ELEMENT ASSEMBLY & MOUNTING (For Vertical or Horizontal Polarization)

The elements are made up of one pre-drilled and slotted 3/4" (1.9 cm) O.D. center tube and two pre-cut 5/8" (1.59 cm) O.D. end tubes. Assemble the elements using Figure B for horizontal polarization or Figure B-2 for vertical polarization. Slide the tuning strap (69) on one of the EA tubes. This will be the driven element #2. Place telescope clamps (409) loosely on the slotted ends of all EA tubes. Note that the EC tubes must be used with the EA tube on which you placed the tuning strap (69). Attach caps (27) to the end of each element. Mount the elements to the boom (Figure C). Refer to figure D for mounting the driven element with the connector bracket. Mount the connector with the threads (socket) pointing to the mast mount. Adjust the antenna to your preferred portion of the 6 meter band using Table 1 if you've chosen horizontal polarization or Table 2 for vertical polarization. Tighten all connections.

FIGURE B (Horizontal Polarization)

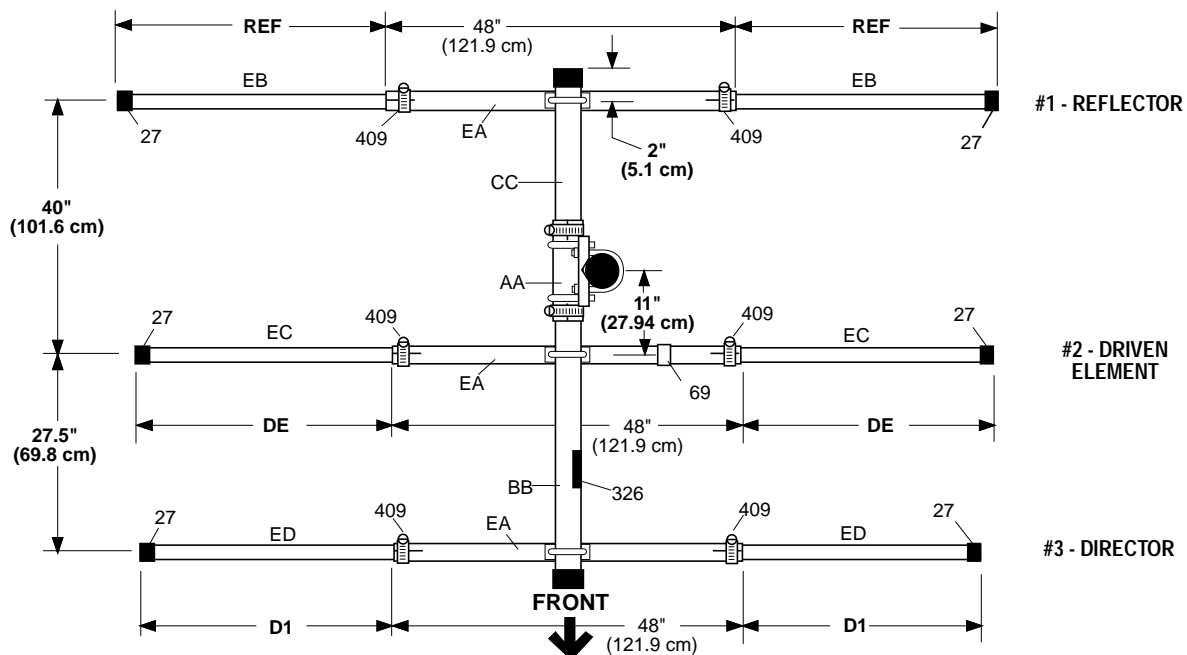

Table 1

Horizontal Polarization					
	50 MHz	51 MHz	52 MHz	53 MHz	54 MHz
REF in.	34-1/2	34-1/2	32-1/2	32-1/2	30-1/2
(cm)	(87.63)	(87.63)	(82.55)	(82.55)	(77.5)
DE in.	31-1/4	30-1/4	29-1/4	28-1/4	27-1/4
(cm)	(79.37)	(76.83)	(74.29)	(71.75)	(69.21)
D1 in.	28-1/2	26-1/2	26-1/2	26-1/2	24-1/2
(cm)	(72.39)	(67.31)	(67.31)	(67.31)	(62.23)
Set in.	17	15-5/8	15-3/8	15-1/4	15-1/4
(cm)	(43.18)	(39.69)	(39.05)	(38.73)	(38.73)
X in.	4-3/4	4-3/4	4-3/8	4-3/4	4-3/4
(cm)	(12.06)	(12.06)	(11.11)	(12.06)	(12.06)

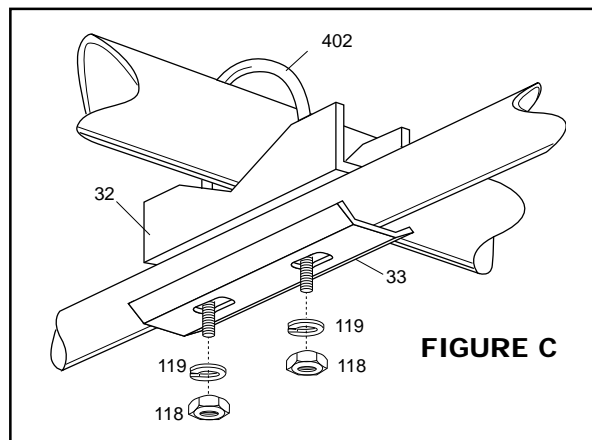
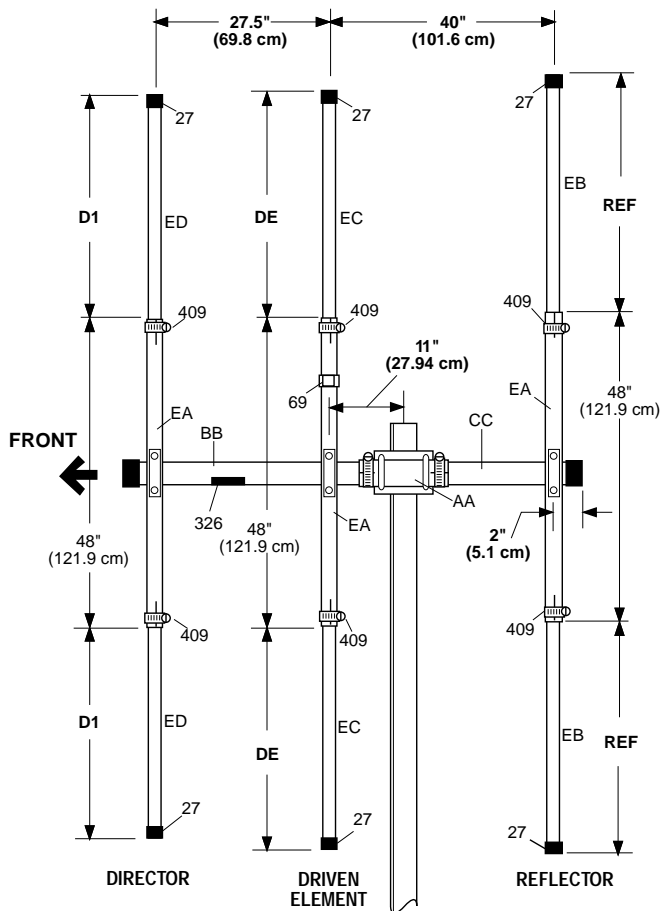

FIGURE C

FIGURE B-2
Vertical Polarization



KEY	P/N	DISPLAY	DESC	SIZE	QTY
EA			ALUM TUBING	3/4" x 48" (1.9 x 121.9 cm)	3
EB			ALUM TUBING	5/8" x 37-1/2" (1.6 x 95.2 cm)	2
EC			ALUM TUBING	5/8" x 34-1/4" (1.6 x 87.0 cm)	2
ED			ALUM TUBING	5/8" x 31-1/2" (1.6 x 80.0cm)	2
27	050027		PLASTIC CAP	5/8" (1.6 cm)	6
32	190032		U-BOLT BRACKET	1-1/2" (3.8 cm)	3
33	190033		BACKING PLATE	1-1/2" (3.8 cm)	2
69	200069		TUNING STRAP		1
84	010084		LOCK WASHER	1/4" (.63 cm)	4
85	010085		HEX NUT	1/4" (.63 cm)	4
402	010402		U-BOLT	1-1/2" (3.8 cm)	2
409	030409		SS WORM CLAMP	3/4" (1.9 cm)	6



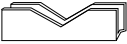



Table 2

Vertical Polarization

	50 MHz	51 MHz	52 MHz	53 MHz	54 MHz
REF in.	34-1/2	34-1/2	32-1/2	32-1/2	30-1/2
(cm)	(87.63)	(87.63)	(82.55)	(82.55)	(77.5)
DE in.	31-1/4	31-1/4	31-1/4	29-3/8	28-3/8
(cm)	(79.37)	(79.37)	(79.37)	(74.61)	(72.07)
D1 in.	28-1/2	28-1/2	26-1/2	26-1/2	24-1/2
(cm)	(72.39)	(72.39)	(67.31)	(67.31)	(62.23)
Set in.	17	16	17	17-1/2	17-1/2
(cm)	(43.18)	(40.64)	(43.18)	(44.45)	(44.45)
X in.	4	3	4-1/4	5-1/2	5
(cm)	(10.16)	(7.62)	(10.79)	(13.97)	(12.7)

#3 - REDDI MATCH ASSEMBLY

Slide the Reddi Match tube (RM) through the tuning strap (69). Connect the flattened rod to the screw on the connector (figure D). Slide the poly tube over the rod up to the flattened end. Adjust to the dimensions shown in Table 1 for horizontal polarization or Table 2 for vertical polarization. Tighten all connections.

KEY	P/N	DISPLAY	DESC	SIZE	QTY
9	010009		SS MACHINE SCREW	8-32 X 5/8" (1.59 cm)	2
941	011941		SS LOCK WASHER	#8	3
11	010011		SS HEX NUT	8-32	3
32	190032		U-BOLT BRACKET	1-1/2" (3.8 cm)	1
69	200069		TUNING STRAP		1
84	010084		SS LOCK WASHER	1/4" (.63 cm)	2
85	010085		SS HEX NUT	1/4" (.63 cm)	2







KEY	P/N	DISPLAY	DESC	SIZE	QTY
402	010402		U-BOLT	1-1/2" (3.8 cm)	1
CB			CONNECTOR BRACKET		1
RM			REDDI MATCH ASSEMBLY	17" (41.2 cm)	1

FIGURE D

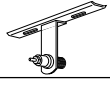
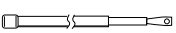
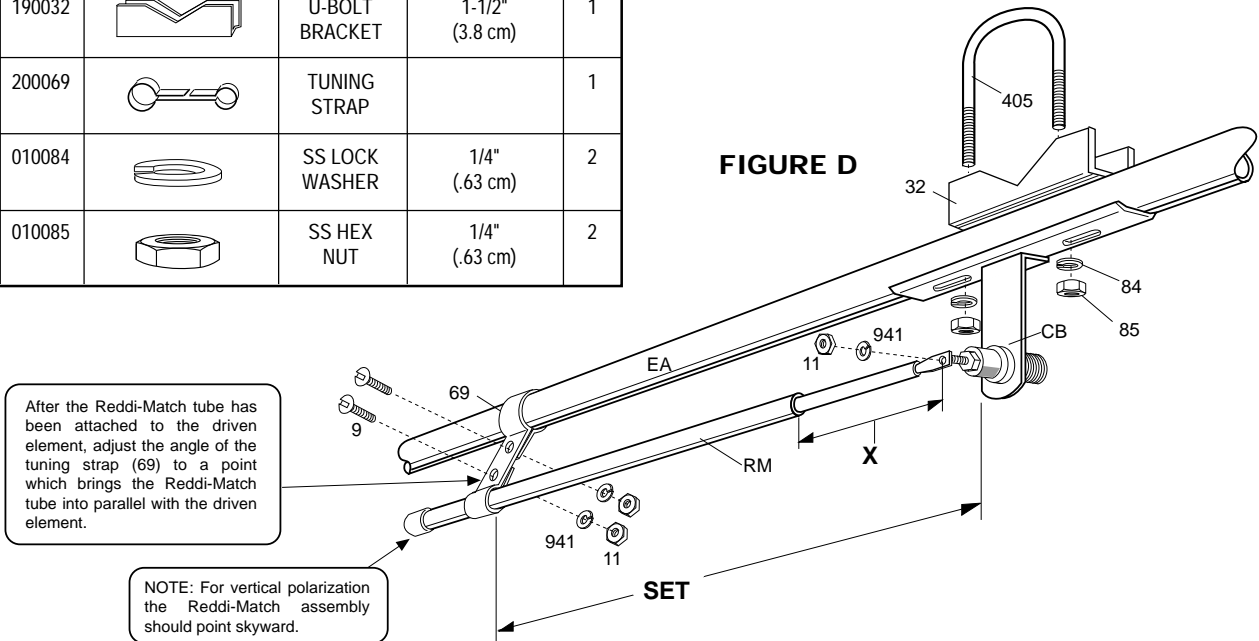

KEY	P/N	DISPLAY	DESC	SIZE	QTY
70	190070		MAST MT. PLATE	4" X 6" (10.16 x 15.2 cm)	1
118	010118		HEX NUT	5/16" (.8 cm)	8
119	010119		LOCK WASHER	5/16" (.8 cm)	8
326	290326		DANGER LABEL		1
403	010403		U-BOLT	1-5/8" (4.13 cm)	2
404	010404		U-BOLT	2-1/8" (5.4 cm)	2

#4 - BOOM TO MAST ASSEMBLY

Assemble and mount the mast bracket to the boom centered over the AA tube. Refer to figure E for assembly.

FIGURE E

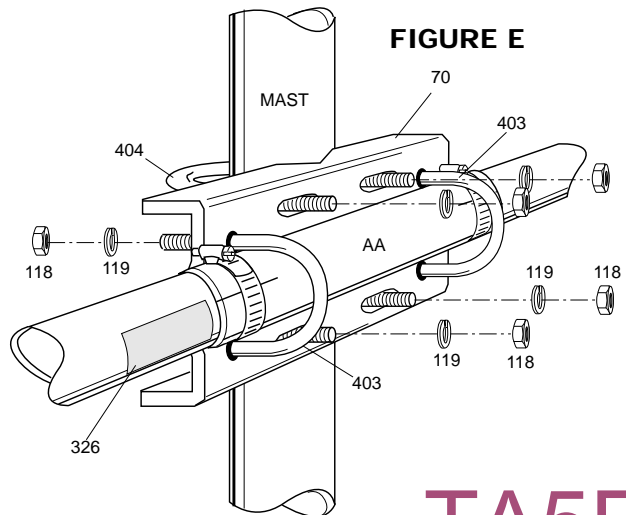

TA5FA

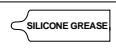
KEY	P/N	DISPLAY	DESC	SIZE	QTY
115	050115		CONNECTOR BOOT		1
116	240116		SILICONE PACKAGE		1

#5 - FEEDLINE ASSEMBLY

Before attaching the feedline permanently, tune the antenna as outlined on page 2. The antenna is designed for use with 50 Ohm coaxial cable terminated with a PL-259 connector. Any length of feedline can be used with your A50-3S. The shortest length of cable will have the least loss. A connector boot is included for use with your new antenna. (Figure F) Slide the boot over the cable before attaching your PL-259. Coat only the outside connector threads and shell with silicone grease. *Do not coat the center pin or receptacle.* After the PL-259 is firmly screwed on to the antenna connector, slide the vinyl boot over the connector and against the mast bracket. When taping the feedline to the mast it's a good idea to form a drip loop in the coax to help protect the connector from water damage (figure G).

FIGURE F



COAT WITH SILICONE GREASE
(DO NOT coat the center pin or socket!)

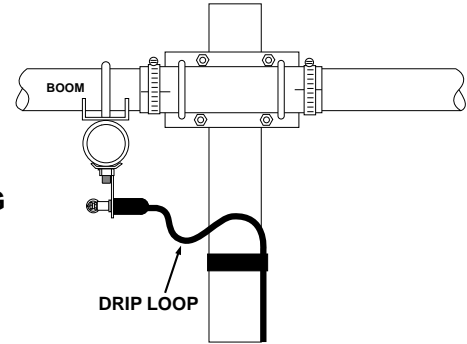

FIGURE G

SPECIFICATIONS

Frequency, MHz	50-54
Number Elements	3
Forward Gain	8 dBd
Front to Back Ratio	20 dB
SWR Typical	1.2:1
2:1 Bandwidth MHz	>1
Power, Watts PEP	1000
Boom Length	6 ft. (1.8 m)
Longest Element	117 in. (300 cm)
Turning Radius	6 ft. (1.8 m)
Mast Size Range	1.5-2 in. (3.8-5.1cm)
Wind Surface Area	1.80 ft ² . (0.17 m ²)
Weight	7 lb. (3.2 kg)

SPECIFICATIONS SUBJECT TO CHANGE WITHOUT NOTICE

LIMITED WARRANTY

Cushcraft Corporation, P.O. Box 4680, Manchester, New Hampshire 03108, warrants to the original consumer purchaser for one year from date of purchase that each Cushcraft antenna is free of defects in material or workmanship. If, in the judgement of Cushcraft, any such antenna is defective, then Cushcraft Corporation will, at its option, repair or replace the antenna at its expense within thirty days of the date the antenna is returned (at purchasers expense) to Cushcraft or one of its authorized representatives. This warranty is in lieu of all other expressed warranties, any implied warranty is limited in duration to one year. Cushcraft Corporation shall not be liable for any incidental or consequential damages which may result from a defect. Some states do not allow limitations on how long an implied warranty lasts or exclusions or limitations of incidental or consequential damages, so the above limitation and exclusion may not apply to you. This warranty gives you specific legal rights, and you may also have other rights which vary from state to state. This warranty does not extend to any products which have been subject to misuse, neglect, accident or improper installation. Any repairs or alterations outside of the Cushcraft factory will nullify this warranty.



CUSHCRAFT
COMMUNICATIONS ANTENNAS

48 PERIMETER ROAD, MANCHESTER, NH 03108 • 603-627-7877 / FAX 603-627-1764

TA5FA