

**ASSEMBLY AND INSTALLATION
INSTRUCTIONS**

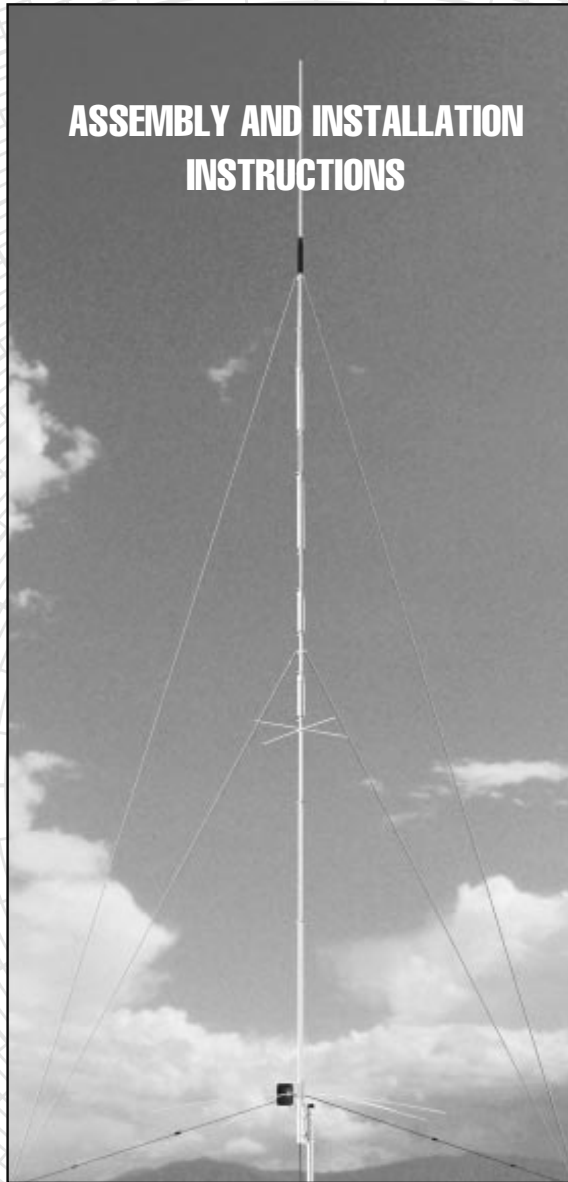

R7000+

R80 Add-On Kit for R7000

10, 12, 15, 17, 20, 30, 40, 80 Meters



CUSHCRAFT
COMMUNICATIONS ANTENNAS

951466 (1/2/96)
TA5FA

WARNING

THIS ANTENNA IS AN ELECTRICAL CONDUCTOR. CONTACT WITH POWER LINES CAN RESULT IN DEATH, OR SERIOUS INJURY. DO NOT INSTALL THIS ANTENNA WHERE THERE IS ANY POSSIBILITY OF CONTACT WITH HIGH VOLTAGE OR ARC-OVER FROM POWER CABLES OR SERVICE DROPS TO BUILDINGS. THE ANTENNA, SUPPORTING MAST AND/OR TOWER MUST NOT BE CLOSE TO ANY POWER LINES DURING INSTALLATION, REMOVAL OR IN THE EVENT PART OF THE SYSTEM SHOULD ACCIDENTALLY FALL. FOLLOW THE GUIDELINES FOR ANTENNA INSTALLATIONS RECOMMENDED BY THE U.S. CONSUMER PRODUCT SAFETY COMMISSION AND LISTED IN THE ENCLOSED PAMPHLET.

Your Cushcraft R7000+ vertical antenna is designed and manufactured to give trouble free service. This antenna will perform as specified if the instructions and suggestions in this manual are followed and care is used in the assembly and installation. When checking the components received in your antenna package use the parts listed beside each diagram. There is a master parts list on page 2. If you are unable to locate any tube or component, check the inside of all tubing. **IMPORTANT:** Save the weight label from the outside of the carton. Each antenna is weighed at the factory to verify the parts count. If you claim a missing part, you will be asked for the weight verification label.

PLANNING

Plan your installation carefully. If you use volunteer helpers be sure that they are qualified to assist you. Make certain that everyone involved understands that you are the boss and that they must follow your instructions. If you have any doubts at all, employ a professional antenna installation company to install your antenna.

LOCATION

Although the R7000+ will operate in almost any location, it will perform best if it is mounted vertically and located in the clear away from surrounding objects such as buildings, trees, power lines, towers, guy wires, antennas and metallic objects. The R7000+ should not be attached to a ground radial system. Failure to heed these points will possibly degrade performance, detune the antenna and increase VSWR.

EXTREME CARE MUST BE USED FOR YOUR SAFETY. YOU MUST INSURE THAT WHILE THE R7000+ IS IN OPERATION NEITHER PEOPLE OR PETS CAN COME IN CONTACT WITH ANY PORTION OF YOUR ANTENNA INCLUDING THE COUNTERPOISE RODS. DEADLY VOLTAGES AND CURRENTS MAY EXIST. ALSO, SINCE THE EFFECTS OF EXPOSURE TO RF ARE NOT FULLY UNDERSTOOD, LONG TERM EXPOSURE TO INTENSE RF FIELDS IS NOT RECOMMENDED.

MOUNTING

Your mast should be rigid and pointing straight up. Always use a mast at least 1-3/4 inches (4.4 cm) but not larger than 2-1/8 inches (5.4 cm) in diameter. If you guy the mast, use non-conducting guys.

GUYING

The R7000+ must be guyed at the two points shown in Figure E. Non conductive UV stable 400 lb. tensile strength rope is supplied for proper guying.

SYSTEM GROUNDING

Direct grounding of the antenna mast is very important. This serves as protection from lightning strikes and static buildup, and from high voltages which may be present in the equipment attached to the antenna. A good electrical connection should be made to one or more ground rods directly at the base of the antenna or mast using a least #10 AWG ground wire and non-corrosive hardware. For details and safety standards, consult the National Electrical Code. You should also use a coaxial lightning arrester. Cushcraft offers several different models, such as the LAC-1, LAC-2 or the LAC-4 series.

ASSEMBLY

Assemble your The R7000+ by following steps 1 through 3. After assembling the antenna, verify all dimensions in Chart 1 for accuracy. Then return to the adjustment section below for final tuning.

ADJUSTMENT

The dimensions in Chart 1 normally allow proper operation on all the bands. However, some variations may occur from one location to another. Adjustments must be made from the bottom of the antenna to the top. Adjusting the antenna from top to bottom will not work. This is because the settings at the top are severely affected by the adjustments at the bottom.

We suggest measuring the VSWR of your antenna by using the SWR meter in your transceiver. If your transceiver does not have one, use a good quality VSWR bridge for this application. Begin with 10 meters since this is at the bottom of the antenna. Set your transceiver at your favorite frequency on 10 meters. Key the rig and check your VSWR. The R7000+ is extremely broadbanded on 10 meters and seldom needs adjustment. If the VSWR is low enough (below 1.5:1) then move on to the 12 meter band. If the 10 meter VSWR is not low enough, adjust the antenna as follows: Check several frequencies on 10 meters to find the frequency of lowest VSWR. If the frequency of lowest VSWR is above your favorite frequency, lengthen dimension A (Figure A) by 1 inch (2.5 cm). This should lower the frequency of lowest VSWR by 50 to 100 KHz. If the frequency of lowest VSWR is below your desired frequency, shorten dimension A (Figure A) by 1 inch (2.5 cm). Check your desired 10 meter operating frequency again to see if the VSWR is less than 1.5:1. Repeat this procedure until the VSWR at your desired frequency is low enough. Adjusting Dimension A is also used to move the resonant frequency of 12m.

Continue this procedure by selecting your desired frequency on 15 meters and checking the VSWR there. Dimension B (Figure A) should be used to adjust the VSWR on 15 meters. *Remember to shorten this dimension to raise the frequency or lengthen it to lower the frequency.*

The balance of the antenna should be adjusted in a like manner. The dimensions and the bands that they effect are shown in Figure A. On 10 through 20 meters 1 inch (2.5 cm) of change in length will change the operating frequency by 50 to 100 KHz. On 30 and 40 meters the change will be 15 to 25 KHz per inch (5 to 10 KHz/cm). On 80 meters the change will be 7-10 KHz per inch (3 to 4 KHz/cm). When the antenna is completely adjusted, check all fasteners to be sure they are tight. Improving VSWR's that are less than 2:1 will not noticeably improve station performance.

TA5FA

R7000+

INSTALLATION

Following the guidelines in the location and adjustment sections above, place the antenna on its mast in its final operating location. If you plan to install the antenna in a salty or corrosive environment, you may want to consider coating it with a clear marine varnish or equivalent *after final assembly and adjustment has been completed*. Now connect your transceiver. If you have any difficulties, reread the information above and the helpful hints below.

HELPFUL HINTS

- Try to locate your R7000+ as far away from TV antennas and their feedlines as possible. This will help to avoid overloading your television with RF.
- The dimensions recommended in Chart 1 are based on mounting the R7000+ approximately 8 feet (2.4 meters) above the ground and 25 feet (7.5 meters) from surrounding objects. Antennas installed with less clearance may require additional adjustments.
- If you check the resistance across the coax connector on your R7000+ you will find a DC short. This is normal. It does not mean that the RF path is short circuited. It is approximately 50 Ohms at your operating frequencies.
- High VSWR is sometimes caused by poor contact between the matching network and the counterpoise rods. Make sure that corrosion has not formed on the jumper strap terminals. Check to insure the hardware is tight. Also, ensure hardware on matching network is secure.
- If your R7000+ is very close to your shack you may experience RF on the feedline. Try lengthening your feedline several feet, placing an RF ferrite bead on the coax, winding the feedline on a toroid or winding the coax in a 10 turn coil 8 inches (20 cm) in diameter.
- Long periods (2 minutes or longer) of key down operation, such as RTTY, at high power (over 1000 Watts) may damage your R7000+.

MASTER PARTS LIST

KEY	PART#	DESCRIPTION	QTY	KEY	PART#	DESCRIPTION	QTY
R80BH		5/8" x 6-1/2" (1.6 x 16.5 cm) aluminum tube	1	CT5		80 meter loading coil assembly	1
R80BI		5/8" x 7-3/4" (1.6 x 19.7 cm) aluminum tube	1				
R80BJ		1" x 12" (2.5 x 30.5 cm) aluminum tube slotted 2 ends	1	77	050077	3/8" (.9 cm) plastic cap	1
R80BK		7/8" x 18" (2.2 x 45.7 cm) alum tube slotted 2 ends	1	258	094258	Guy rope coil (250 feet)	1
R80BL		7/8" x 6" (2.2 x 15.2 cm) aluminum tube slotted 2 ends	1	259	094259	Guy rope thimble	6
R80BM		3/8" x 36" (.9 x 91.4 cm) aluminum tube slotted 1 end	1	407	030407	5/8" (1.6 cm) stainless steel worm clamp	2
R80BN		1/4" x 43-3/4" (.6 x 111.1 cm) aluminum rod	1	411	030411	1-1/4" (3.2 cm) stainless steel worm clamp	4
R80BO		3/8" x 15" (.9 x 38.1 cm) aluminum tube	1	631	193631	Guy bracket	6
				R80CW		Counterpoise wires with anti-resonators	3

TA5FA

#1 - ASSEMBLE RADIATOR

Lower your R7000 antenna or assemble it using the R7000 manual. Place it horizontally across supports so the counterpoise whips and capacity hat rods are not damaged.

Place 411 worm clamp on section BC loosely. Loosen worm clamps at points W,X and Y. Slide CT1 from tubing sections BC and BD1. Insert R80BH tube into bottom tube of CT1 until it stops against rivet inside CT1. Slide CT1 into tube BC of the R7000 until it stops against hardware for capacity hat rods. Tighten worm clamp. Verify that the length from top of base to bottom of CT1 equals the value of Dimension A in Chart 1. If you require more length, do not change the location of CT1. Lengthen exposed tubing sections of tube BB and BC.

Slide R80BI tube into top of CT1 until it stops against rivet inside of CT1. Remove both worm clamps (410) from tube BD1 and put aside for later.

Insert BD1 tube flush into R80BJ tube. Place two 411 worm clamps from R80 hardware kit on the R80BJ tube (one on each of the slotted ends). Slide R80BJ assembly two inches onto top end of CT1. Tighten worm clamp.

Slide CT2 / CT3 assembly into top of R80BJ assembly. Adjust the length between CT1 and CT2 to match value of Dimension B in Chart 1. Tighten worm clamp.

NOTE: The next 3 steps depend on whether you will be using CW, Center or SSB on 40 meters. Choose the appropriate section below.

40m SSB - Loosen worm clamps at points U & V. Remove and discard BD3 and BG tubes. Place 410 worm clamps on ends of R80BL. Place R80BL tube on top of CT3. Insert bottom of CT4 into R80BL. Adjust the distance between CT3 and CT4 to match value of Dimension E in Chart 1. Tighten worm clamps.

40M Center - Loosen worm clamp at point V. Remove and discard BG tube. Insert bottom of CT4 to match value of Dimension E in Chart 1. Tighten worm clamps.

40m CW - Loosen worm clamps at points U & V. Remove and discard BD3 and BG tubes. Place 410 worm clamps on ends of R80BK. Place R80BK tube on top of CT3. Insert bottom of CT4 to match value of Dimension E in Chart 1. Tighten worm clamps.

Place 411 worm clamp then 410 worm clamp (one of the clamps from point X or Y) on large slotted tube end of CT5. Leave 411 worm clamp loose for guy bracket attachment in Step #3. Insert bottom of CT5 onto top of CT4. Tighten worm clamp. Verify that the length between top of CT4 and bottom of CT5 equals Dimension F in Chart 1. Note: the next 2 steps depend on whether you will be using CW, Center or SSB on 80m. Choose appropriate section below.

NOTE: the next 2 steps depend on whether you will be using CW/Center or SSB on 80m.

80m SSB - Place 407 worm clamp on top of CT5. Adjust distance from top of R80BM to top of CT5 to match value of Dimension G in Chart 1. Tighten worm clamp. For lengths less than 13 inches, use R80BO tube. Place plastic cap (77) on top of 3/8" tube.

80m Center/ CW - Place 407 worm clamp on top of CT5. Insert R80BM 2 inches into CT5. Tighten worm clamp. Place 407 worm clamp on top of R80BM. Insert R80BN into R80BM. Adjust distance from top of R80BN to top of CT5 to match value of Dimension G in Chart 1. Tighten worm clamp.













KEY	P/N	DISPLAY	DESC	SIZE	QTY
77	050077		PLASTIC CAP	3/8" (9 cm)	1
407	030407		SS WORM CLAMP	5/8" (1.6 cm)	2
411	030411		SS WORM CLAMP	1-1/4" (3.2)	4
R80BH			ALUM TUBE	5/8" x 6-1/2" (1.6 x 16.5 cm)	1
R80BI			ALUM TUBE	5/8" x 7-3/4" (1.6 x 19.7 cm)	1
R80BJ			ALUM TUBE	1" x 12" (2.2 x 45.7 cm)	1
R80BK			ALUM TUBE	7/8" x 18" (2.2 X 45.7 cm)	1
R80BL			ALUM TUBE	7/8" x 6" (2.2 x 15.2 cm)	1
R80BM			ALUM TUBE	3/8" x 36" (0.9 x 91.4 cm)	1
R80BN			ALUM ROD	1/4" x 43-3/4" (0.6 x 111.1 cm)	1
R80BO			ALUM TUBE	3/8" x 15" (.9 x 38.1 cm)	1
CT4			40M TRAP		1
CT5			80M LOADING COIL		1

CHART 1

Dimension	Band	CW	Center	SSB
A	10 / 12m	129" (328 cm)	129" (328 cm)	129" (328 cm)
B	15 / 17m	16" (41 cm)	15" (38 cm)	14" (36 cm)
C	20 / 30m	17" (43 cm)	15" (38 cm)	14" (36 cm)
E	40m	22" (56 cm)	13" (33 cm)	8" (20 cm)
F	80m	2" (5 cm)	2" (5 cm)	2" (5 cm)
G	80m	See Below		

Frequency MHz	Dimension G
3.525	76" (193 cm)
3.600	64" (163 cm)
3.700	52" (132 cm)
3.800	40" (102 cm)
3.900	23" (58 cm)
3.975	8" (20 cm)*

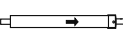
* Use R80BO tube

FIGURE A

The R7000+ is shown with the R80 kit in white and the original R7000 parts in gray.

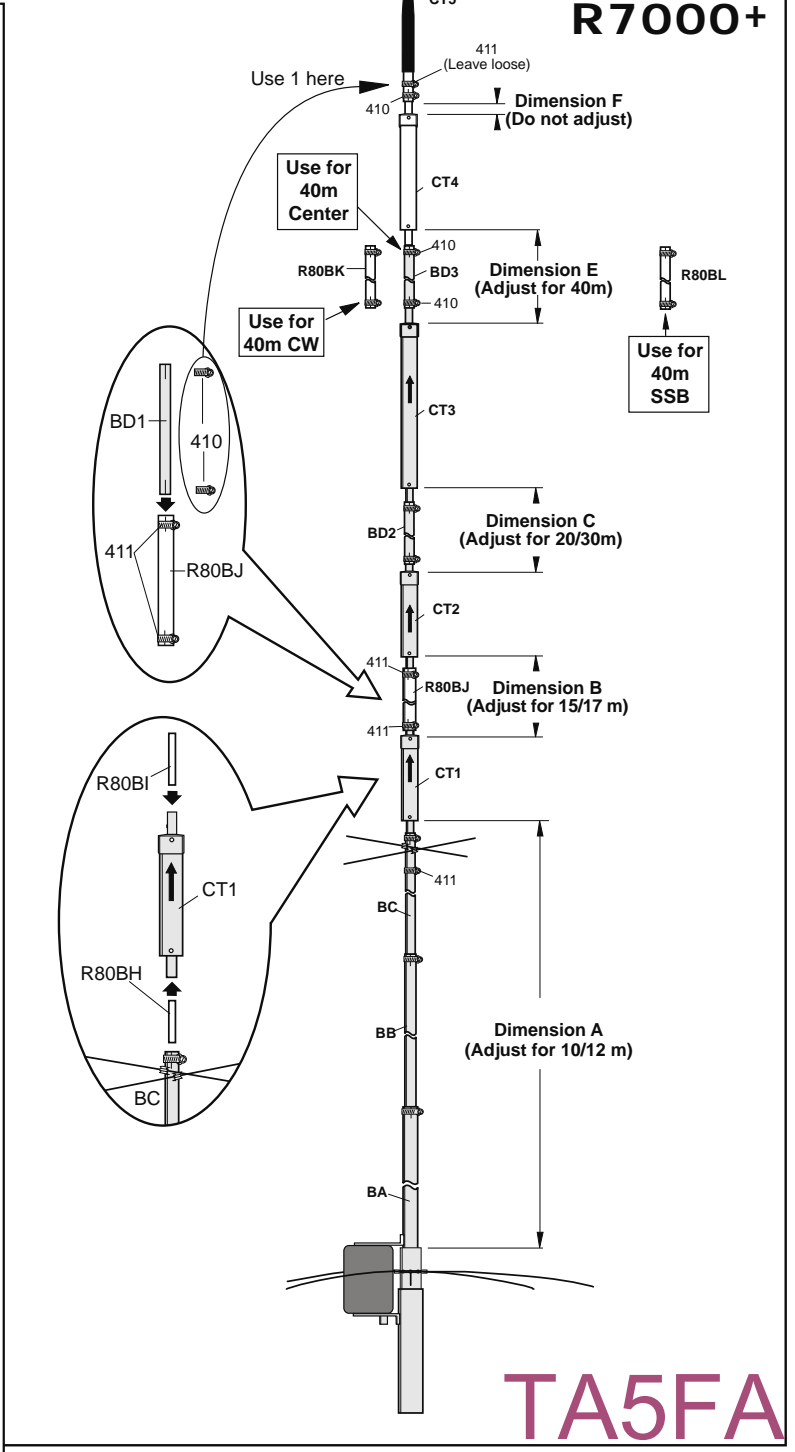
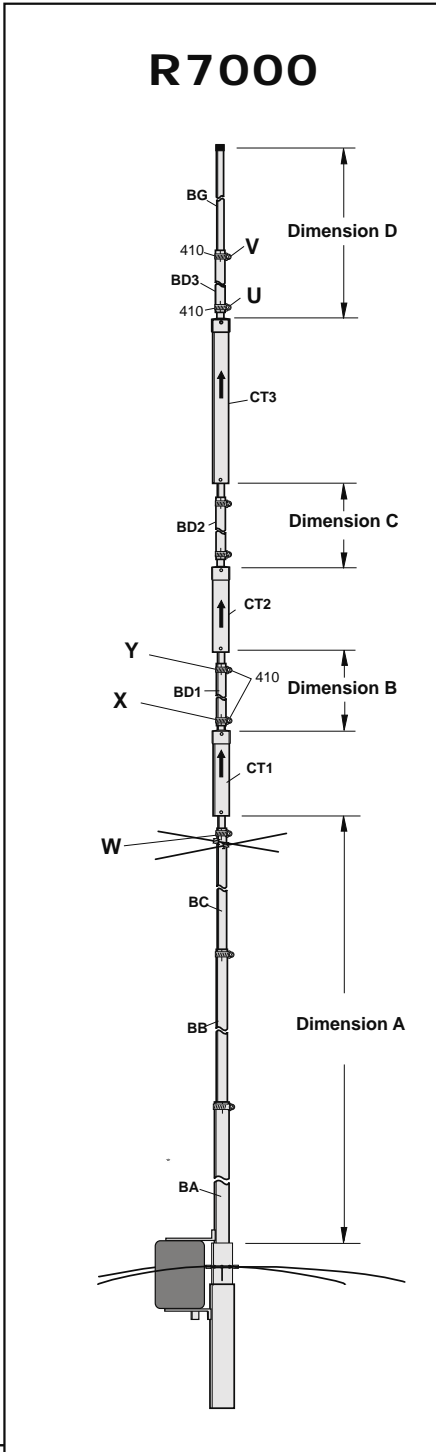

TA5FA

#2 - ATTACH COUNTERPOISE WIRES

There are three counterpoise wires for the R7000+. Each is twenty feet long (Figure C). The counterpoise wires provide a proper match for 80 meter operation on the R7000+. The anti-resonator in each counterpoise wire keeps the twenty foot length of wire from detuning the higher frequency bands.

The three counterpoise wires attach to the R7000 base with existing hardware (Figure B). Each counterpoise wire is tied off to one of your three guy points. Tie the wire and rope together in a knot. No insulator is required. Tape knot to prevent snagging. The counterpoise wires should hang at an angle between 60 and 90 degrees relative to the support mast (Figure D). The ends of each wire should be three or more feet above ground to minimize detuning. **Do not over tighten these wires. Do not use them as guy supports.**

FIGURE B

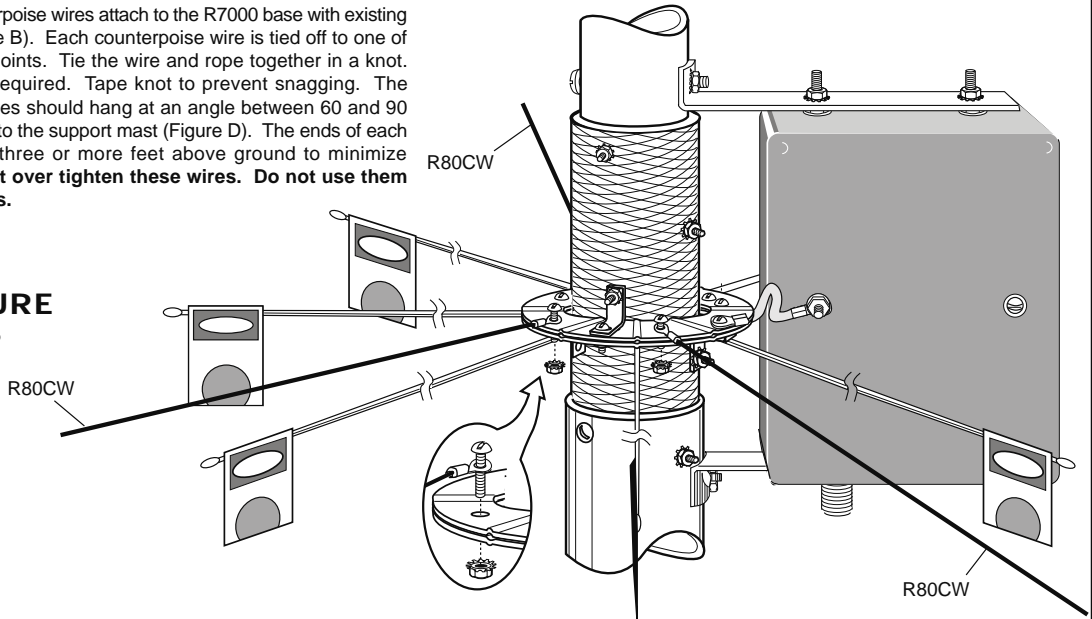

FIGURE C

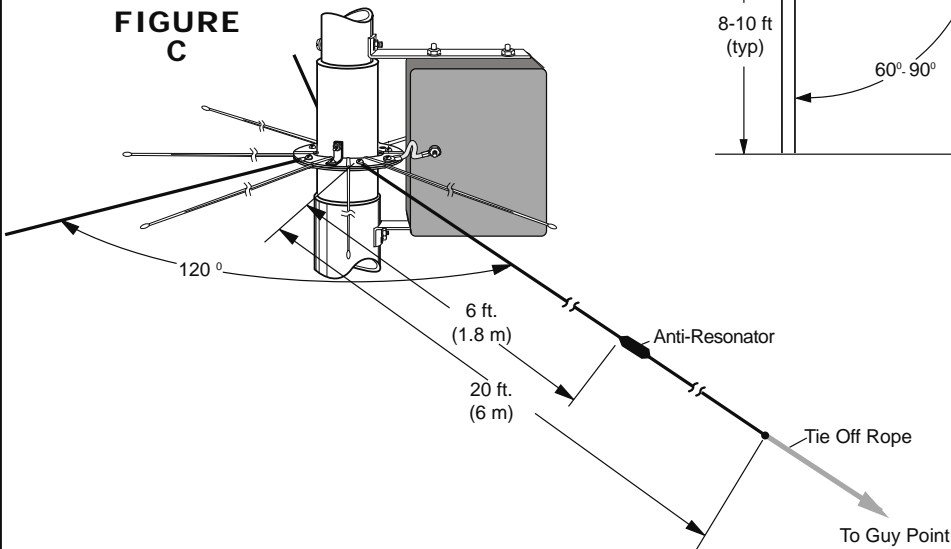
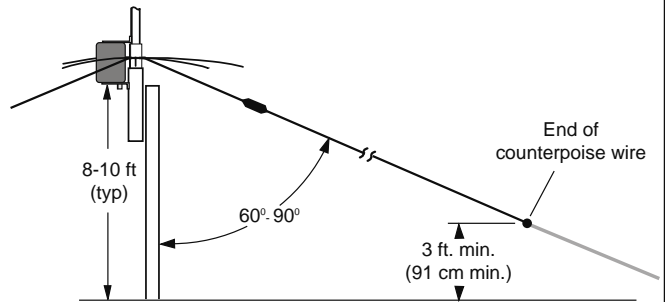

FIGURE D



TA5FA



#3 - ATTACHING GUY ROPES

The R7000+ requires guying at two points with a non-conductive material (Figure E). The R80 kit contains 250 feet of UV stable 400 lb. tensile strength guy rope. This is enough guy rope to secure an R7000+ mounted on an eight foot support mast on level ground. Extra rope can be used to tie off the counterpoise wires. If more guy rope is required, use a similar material with equivalent specifications.

Insert three 631 guy brackets into the 411 worm clamps already placed on the radiator in Step 1. Tighten the worm clamps. Attach the guy ropes to the guy brackets using a 259 thimble (Figure 2). The thimbles are provided to eliminate wear on the guy rope at this connection point. Use pliers to open the end of each thimble and insert the thimble into the hole on the guy bracket. Use pliers to close the opening in the thimble end. Tie the guy ropes securely and cover the knot with electrical tape to eliminate snagging during antenna raising.

Notes for raising the R7000+

- 1) Ensure your support mast is securely mounted. The base of the R7000+ must not be allowed to move.
- 2) Do not let the guy ropes snag during antenna raising.
- 3) Walk the antenna up and down slowly
- 4) The wind loading of the R7000+ is small. **Do not over tension the guy ropes.** Guy anchors must be securely installed and capable of properly supporting the antenna.
- 5) Double check antenna assembly before raising to minimize repeated raising and lowering.
- 6) Have sufficient help to perform installation.
- 7) Check guy ropes occasionally for tightness and wear. The guy rope should be replaced every three to five years depending on your environment. Do not use polypropylene rope.
- 8) Calculate guy rope lengths before installation using equation in Figure G. Add extra length for tying off.
- 9) Sear rope ends with open flame to prevent fraying.

KEY	P/N	DISPLAY	DESC	SIZE	QTY
258	094258		GUY ROPE COIL	250 ft	1
259	024259		GUY ROPE THIMBLE		6
631	193631		GUY ROPE BRACKET		6

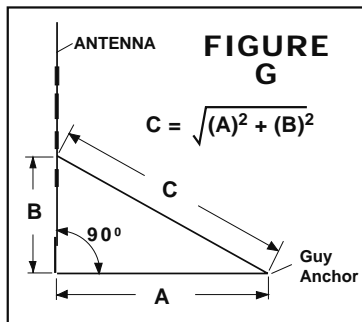
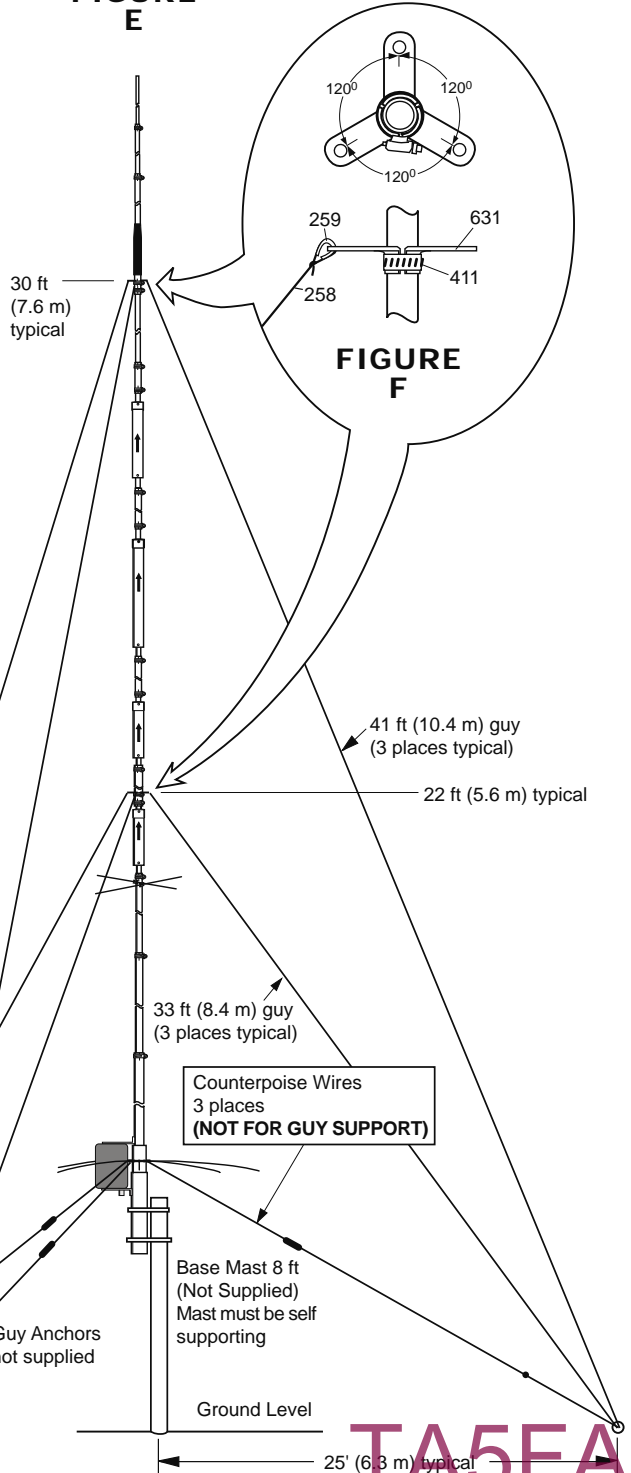

FIGURE E



TA5FA

SPECIFICATIONS

Frequency, meters	10,12,15,17,20,30,40,80
Gain, dBi	3
Wavelength each band	Half-wave
VSWR	1.2:1 typical
2:1 bandwidth, KHz	10m (1700) 12m (100) 15m (450) 17m (100) 20m (250) 30m (100) 40m (100) 80m (70)
Power Rating, Watts	1500
Radiation angle, deg.	16
Horizontal rad, deg.	360
Height, ft(m)	34.5 (10.5)
Mast size range, in (cm)	1-3/4 to 2-1/8 (4.4-5.4)
Wind load, ft ² (m ²)	2.5 (.23) antenna 1.5 (.13) guy ropes
Weight, lb. (kg)	24 (10.8)

LIMITED WARRANTY

Cushcraft Corporation, P.O. Box 4680, Manchester, New Hampshire 03108, warrants to the original purchaser for one year from date of purchase that each Cushcraft antenna is free of defects in material or workmanship. If, in the judgement of Cushcraft, any such antenna is defective, then Cushcraft Corporation will, at its option, repair or replace the antenna at its expense within thirty days of the date the antenna is returned (at purchasers expense) to Cushcraft or one of its authorized representatives. This warranty is in lieu of all other expressed warranties, any implied warranty is limited in duration to one year. Cushcraft Corporation shall not be liable for any incidental or consequential damages which may result from a defect. Some states do not allow limitations on how long an implied warranty lasts or exclusions or limitations of incidental or consequential damages, so the above limitation and exclusion may not apply to you. This warranty gives you specific legal rights, and you may also have other rights which vary from state to state. This warranty does not extend to any products which have been subject the misuse, neglect, accident or improper installation. Any repairs or alterations outside of the Cushcraft factory will nullify this warranty.



CUSHCRAFT
COMMUNICATIONS ANTENNAS

48 PERIMETER ROAD, MANCHESTER, NH 03108 USA
TELEPHONE: 603-627-7877 • FAX: 603-627-1764 • E-mail: techsup@cushcraft.com

SPECIFICATIONS SUBJECT TO CHANGE WITHOUT NOTICE

TA5FA