

# FUJIFILM

BL01257-202 **EN**

DIGITAL CAMERA

# FINEPIX XP30 Series

## Owner's Manual

Thank you for your purchase of this product. This manual describes how to use your FUJIFILM digital camera and the supplied software. Be sure that you have read and understood its contents and the warnings in "For Your Safety" (📖 ii) before using the camera.

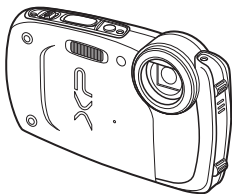

For information on related products, visit our website at [http://www.fujifilm.com/products/digital\\_cameras/index.html](http://www.fujifilm.com/products/digital_cameras/index.html)

**Before You Begin**

**First Steps**

**Basic Photography and Playback**

**More on Photography**

**More on Playback**

**Movies**

**Connections**

**Menus**

**Technical Notes**

**Troubleshooting**

**Appendix**

**Exif Print**

**SD<sup>TM</sup>  
XC**

**PictBridge**



# IMPORTANT SAFETY INSTRUCTIONS

- **Read Instructions:** All the safety and operating instructions should be read before the appliance is operated.
- **Retain Instructions:** The safety and operating instructions should be retained for future reference.
- **Heed Warnings:** All warnings on the appliance and in the operating instructions should be adhered to.
- **Follow Instructions:** All operating and use instructions should be followed.

### Installation

**Power Sources:** This video product should be operated only from the type of power source indicated on the marking label. If you are not sure of the type of power supply to your home, consult your appliance dealer or local power company. For video products intended to operate from battery power, or other sources, refer to the operating instructions.

**Grounding or Polarization:** This video product is equipped with a polarized alternating-current line plug (a plug having one blade wider than the other). This plug will fit into the power outlet only one way. This is a safety feature. If you are unable to insert the plug fully into the outlet, try reversing the plug. If the plug should still fail to fit, contact your electrician to replace your obsolete outlet. Do not defeat the safety purpose of the polarized plug.

**Alternate Warnings:** This video product is equipped with a three-wire grounding-type plug, a plug having a third (grounding) pin. This plug will only fit into a grounding-type power outlet. This is a safety feature. If you are unable to insert the plug into the outlet, contact your electrician to replace your obsolete outlet. Do not defeat the safety purpose of the grounding type plug.

**Overloading:** Do not overload wall outlets and extension cords as this can result in a risk of fire or electric shock.

**Ventilation:** Slots and openings in the cabinet are provided for ventilation, to ensure reliable operation of the video product and to protect it from overheating, and these openings must not be blocked or covered. The openings should never be blocked by placing the video product on a bed, sofa, rug, or other similar surface.

This video product should not be placed in a built-in installation such as a bookcase or rack unless proper ventilation is provided or the manufacturer's instructions have been adhered to. This video product should never be placed near or over a radiator or heat register.

**Attachments:** Do not use attachments not recommended by the video product manufacturer as they may cause hazards.

**Water and Moisture:** Do not use this video product near water—for example, near a bath tub, wash bowl, kitchen sink, or laundry tub, in a wet basement, or near a swimming pool, and the like (excluding waterproof products).

**Power-Cord Protection:** Power-supply cords should be routed so that they are not likely to be walked on or pinched by items placed upon or against them, paying particular attention to cords at plugs, convenience receptacles, and the point where they exit from the appliance.

**Accessories:** Do not place this video product on an unstable cart, stand, tripod, bracket, or table. The video product may fall, causing serious injury to a child or adult, and serious damage to the appliance. Use only with a cart, stand, tripod, bracket, or table recommended by the manufacturer, or sold with the video product. Any mounting of the appliance should follow the manufacturer's instructions, and should use a mounting accessory recommended by the manufacturer.

An appliance and cart combination should be moved with care. Quick stops, excessive force, and uneven surfaces may cause the appliance and cart combination to overturn.



**Antennas**

**Outdoor Antenna Grounding:** If an outside antenna or cable system is connected to the video product, be sure the antenna or cable system is grounded so as to provide some protection against voltage surges and built-up static charges. Section 810 of the National Electrical Code, ANSI/NFPA No. 70, provides information with respect to proper grounding of the mast and supporting structure, grounding of the lead-in wire to an antenna discharge unit, size of grounding conductors, location of antenna discharge unit, connection to grounding electrodes, and requirements for the grounding electrode.

*EXAMPLE OF ANTENNA GROUNDING AS PER NATIONAL ELECTRICAL CODE*

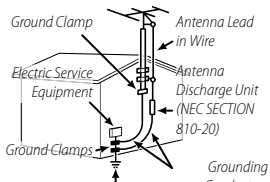

*Power Service Grounding Electrode System (NEC ART 250, PART H)*

*Grounding Conductors (NEC SECTION 810-21)*

**Power Lines:** An outside antenna system should not be located in the vicinity of overhead power lines or other electric light or power circuits, or where it can fall into such power lines or circuits. When installing an outside antenna system, extreme care should be taken to keep from touching such power lines or circuits as contact with them might be fatal.

**Use**

**Cleaning:** Unplug this video product from the wall outlet before cleaning. Do not use liquid cleaners or aerosol cleaners. Use a damp cloth for cleaning.

**Object and Liquid Entry:** Never push objects of any kind into this video product through openings as they may touch dangerous voltage points or short out parts that could result in a fire or electric shock. Never spill liquid of any kind on the video product (excluding waterproof products).

**Lightning:** For added protection for this video product receiver during a lightning storm, or when it is left unattended and unused for long periods of time, unplug it from the wall outlet and disconnect the antenna or cable system. This will prevent damage to the video product due to lightning and power-line surges.

**Service**

**Servicing:** Do not attempt to service this video product yourself as opening or removing covers may expose you to dangerous voltage or other hazards. Refer all servicing to qualified service personnel.

**Damage Requiring Service:** Unplug this video product from the wall outlet and refer servicing to qualified service personnel under the following conditions:

- When the power-supply cord or plug is damaged.
- If liquid has been spilled, or objects have fallen into the video product.
- If the video product has been exposed to rain or water (excluding waterproof products).
- If the video product has been dropped or the cabinet has been damaged.

If the video product does not operate normally follow the operating instructions. Adjust only those controls that are covered by the operating instructions as an improper adjustment of other controls may result in damage and will often require extensive work by a qualified technician to restore the video product to its normal operation.

When the video product exhibits a distinct change in performance—this indicates a need for service.

**Replacement Parts:** When replacement parts are required, be sure the service technician has used replacement parts specified by the manufacturer or have the same characteristics as the original part. Unauthorized substitutions may result in fire, electric shock or other hazards.

**Safety Check:** Upon completion of any service or repairs to this video product, ask the service technician to perform safety checks to determine that the video product is in proper operating condition.

**Be sure to read these notes before use**

**Safety Notes**

- Make sure that you use your camera correctly. Read these safety notes and your *Owner's Manual* carefully before use.
- After reading these safety notes, store them in a safe place.

**About the Icons**

The icons shown below are used in this document to indicate the severity of the injury or damage that can result if the information indicated by the icon is ignored and the product is used incorrectly as a result.



This icon indicates that death or serious injury can result if the information is ignored.



This icon indicates that personal injury or material damage can result if the information is ignored.

The icons shown below are used to indicate the nature of the instructions which are to be observed.



Triangular icons tell you that this information requires attention ("Important").



Circular icons with a diagonal bar tell you that the action indicated is prohibited ("Prohibited").



Filled circles with an exclamation mark indicate an action that must be performed ("Required").

**! WARNING**



***If a problem arises, turn the camera off, remove the battery, and disconnect and unplug the AC power adapter.*** Continued use of the camera when it is emitting smoke, is emitting any unusual odor, or is in any other abnormal state can cause a fire or electric shock. Contact your FUJIFILM dealer.



***Do not allow water or foreign objects to enter the camera.*** If water or foreign objects get inside the camera, turn the camera off, remove the battery, and disconnect and unplug the AC power adapter. Continued use of the camera can cause a fire or electric shock. Contact your FUJIFILM dealer.

**! WARNING**



***Do not use the camera in the bathroom or shower (excluding waterproof products).*** This can cause a fire or electric shock.



***Never attempt to change or take apart the camera (never open the case).*** Failure to observe this precaution can cause fire or electric shock.



***Should the case break open as the result of a fall or other accident, do not touch the exposed parts.*** Failure to observe this precaution could result in electric shock or in injury from touching the damaged parts. Remove the battery immediately, taking care to avoid injury or electric shock, and take the product to the point of purchase for consultation.



***Do not change, heat or unduly twist or pull the connection cord and do not place heavy objects on the connection cord.*** These actions could damage the cord and cause a fire or electric shock. If the cord is damaged, contact your FUJIFILM dealer.



***Do not place the camera on an unstable surface.*** This can cause the camera to fall or tip over and cause injury.



***Never attempt to take pictures while in motion.*** Do not use the camera while you are walking or driving a vehicle. This can result in you falling down or being involved in a traffic accident.



***Do not touch any metal parts of the camera during a thunderstorm.*** This can cause an electric shock due to induced current from the lightning discharge.



***Do not use the battery except as specified.*** Load the battery as shown by the indicator.



***Do not heat, change or take apart the battery. Do not drop or subject the battery to impacts. Do not store the battery with metallic products.*** Any of these actions can cause the battery to burst or leak and cause fire or injury as a result.



***Use only the battery or AC power adapters specified for use with this camera. Do not use voltages other than the power supply voltage shown.*** The use of other power sources can cause a fire.



***If the battery leaks and fluid gets in contact with your eyes, skin or clothing, flush the affected area with clean water and seek medical attention or call an emergency number right away.***

**⚠ WARNING**

**Do not use the charger to charge batteries other than those specified here.** The supplied battery charger is for use only with the type of battery supplied with the camera. Using the charger to charge conventional batteries or other types of rechargeable batteries can cause the battery to leak fluid, overheat or burst.



**When carrying the battery, install it in a digital camera or keep it in the hard case. When storing the battery, keep it in the hard case. When discarding, cover the battery terminals with insulation tape.** Contact with other metallic objects or batteries could cause the battery to ignite or burst.



**Keep memory cards out of the reach of small children.** Because memory cards are small, they can be swallowed by children. Be sure to store memory cards out of the reach of small children. If a child swallows a memory card, seek medical attention or call an emergency number.

**⚠ CAUTION**

**Do not use this camera in locations affected by oil fumes or steams.** This can cause a fire or electric shock.



**Do not use this camera in locations affected by humidity or dust (excluding waterproof products).** This can cause a fire or electric shock.



**Do not leave this camera in places subject to extremely high temperatures.** Do not leave the camera in locations such as a sealed vehicle or in direct sunlight. This can cause a fire.



**Keep out of the reach of small children.** This product could cause injury in the hands of a child.



**Do not place heavy objects on the camera.** This can cause the heavy object to tip over or fall and cause injury.



**Do not move the camera while the AC power adapter is still connected. Do not pull on the connection cord to disconnect the AC power adapter.** This can damage the power cord or cables and cause a fire or electric shock.



**Do not use the AC power adapter when the plug is damaged or the plug socket connection is loose.** This could cause a fire or electric shock.

**⚠ CAUTION**

**Do not cover or wrap the camera or the AC power adapter in a cloth or blanket.** This can cause heat to build up and distort the casing or cause a fire.



**When you are cleaning the camera or you do not plan to use the camera for an extended period, remove the battery and disconnect and unplug the AC power adapter.** Failure to do so can cause a fire or electric shock.



Unplug from power socket

**When charging ends, unplug the charger from the power socket.** Leaving the charger plugged into the power socket can cause a fire.



**Using a flash too close to a person's eyes may temporarily affect the eyesight.** Take particular care when photographing infants and young children.



**When a memory card is removed, the card could come out of the slot too quickly. Use your finger to hold it and gently release the card.** Injury could result to those struck by the ejected card.



**Request regular internal testing and cleaning for your camera.** Build-up of dust in your camera can cause a fire or electric shock. Contact your FUJIFILM dealer to request internal cleaning every two years. Please note that this service is not free of charge.

### The Battery and Power Supply

**Note:** Check the type of battery used in your camera and read the appropriate sections.

The following describes the proper use of batteries and how to prolong their life. Incorrect use can shorten battery life or cause leakage, overheating, fire, or explosion.

#### Li-ion Batteries

*Read this section if your camera uses a rechargeable Li-ion battery.*

The battery is not charged at shipment. Charge the battery before use. Keep the battery in its case when not in use.

#### Notes on the Battery

The battery gradually loses its charge when not in use. Charge the battery one or two days before use.

Battery life can be extended by turning the camera off when not in use.

Battery capacity decreases at low temperatures; a depleted battery may not function at when cold. Keep a fully charged spare battery in a warm place and exchange as necessary, or keep the battery in your pocket or other warm place and insert it in the camera only when shooting. Do not place the battery in direct contact with hand warmers or other heating devices.

#### Charging the Battery

Charge the battery in the supplied battery charger. Charging times will increase at ambient temperatures below +10°C (+50°F) or above +35°C (+95°F). Do not attempt to charge the battery at temperatures above 40°C (+104°F); at temperatures below 0°C (+32°F), the battery will not charge.

Do not attempt to recharge a fully charged battery. The battery does not however need to be fully discharged before charging.

The battery may be warm to the touch immediately after charging or use. This is normal.

#### Battery Life

At normal temperatures, the battery can be recharged about 300 times. A noticeable decrease in the length of time the battery will hold a charge indicates that it has reached the end of its service life and should be replaced.

#### Storage

Performance may be impaired if the battery is left unused for extended periods when fully charged. Run the battery flat before storing it.

If the camera will not be used for an extended period, remove the battery and store it in a dry place with an ambient temperature of from +15°C to +25°C (+59°F to +77°F). Do not store in locations exposed to extremes of temperature.

#### Cautions: Handling the Battery

- Do not transport or store with metal objects such as necklaces or hairpins.
- Do not expose to flame or heat.
- Do not disassemble or modify.
- Use with designated chargers only.
- Do not drop or subject to strong physical shocks.
- Do not expose to water.
- Keep the terminals clean.
- The battery and camera body may become warm to the touch after extended use. This is normal.

#### AA Alkaline/Rechargeable NiMH Batteries

*Read this section if your camera uses AA alkaline or rechargeable AA NiMH batteries.* Information on compatible battery types may be found elsewhere in the camera manual.

#### Cautions: Handling the Batteries

- Do not expose to water, flame, or heat, or store in warm or humid conditions.
- Do not transport or store with metal objects such as necklaces or hairpins.
- Do not disassemble or modify the batteries or battery casing.
- Do not subject to strong physical shocks.
- Do not use batteries that are leaking, deformed, or discolored.
- Keep out of reach of infants and small children.
- Insert in the correct orientation.

- Do not mix old and new batteries, batteries with different charge levels, or batteries of different types.
- If the camera will not be used for an extended period, remove the batteries. Note that the camera clock will be reset.
- The batteries may be warm to the touch immediately after use. Turn the camera off and allow the batteries to cool before handling.
- Battery capacity tends to decrease at low temperatures. Keep spare batteries in a pocket or other warm place and exchange as necessary. Cold batteries may recover some of their charge when warmed.
- Fingerprints and other stains on the battery terminals can impair battery performance. Thoroughly clean the terminals with a soft, dry cloth before inserting them in the camera.



If the batteries leak, clean the battery compartment thoroughly before inserting new batteries.



If fluid from the battery comes into contact with skin or clothing, flush the affected area with water. ***If fluid enters your eyes, immediately flush the affected area with water and seek medical attention. Do not rub your eyes. Failure to observe this precaution could result in permanent visual impairment.***

#### ■ NiMH Batteries

The capacity of Ni-MH batteries may be temporarily reduced when new, after long periods of disuse, or if they are repeatedly recharged before being fully discharged. This is normal and does not indicate a malfunction. Capacity can be increased by repeatedly discharging the batteries using the discharge option in the camera setup menu and recharging them using a battery charger.

ⓘ **CAUTION:** Do not use the discharge option with alkaline batteries.

The camera draws a small amount of current even when off. Ni-MH batteries that have been left in the camera for an extended period may be drawn down to the point that they no longer hold a charge. Battery performance may also drop if the batteries are run down in a device such as a flashlight. Use the discharge option in the camera setup menu to discharge Ni-MH batteries. Batteries that no longer hold a charge even after repeatedly being discharged and recharged have reached the end of their service life and must be replaced.

Ni-MH batteries can be recharged in a battery charger (sold separately). Batteries may become warm to the touch after charging. Refer to the instructions provided with the charger for more information. Use the charger with compatible batteries only.

Ni-MH batteries gradually lose their charge when not in use.

#### ■ Disposal

Dispose of used batteries in accord with local regulations.

#### AC Power Adapters (Available Separately)

*This section applies to all camera models.*

Use only FUJIFILM AC power adapters designated for use with this camera. Other adapters could damage the camera.

- The AC power adapter is for indoor use only.
- Be sure the DC plug is securely connected to the camera.
- Turn the camera off before disconnecting the adapter. Disconnect the adapter by the plug, not the cable.
- Do not use with other devices.
- Do not disassemble.
- Do not expose to high heat and humidity.
- Do not subject to strong physical shocks.
- The adapter may hum or become hot to the touch during use. This is normal.
- If the adapter causes radio interference, reorient or relocate the receiving antenna.

### Using the Camera

Do not aim the camera at extremely bright light sources, such as the sun in a cloudless sky. Failure to observe this precaution could damage the camera image sensor.

### Take Test Shots

Before taking photographs on important occasions (such as at weddings or before taking the camera on a trip), take a test shot and view the result in the LCD monitor to ensure that the camera is functioning normally. FUJIFILM Corporation can not accept liability for damages or lost profits incurred as a result of product malfunction.

### Notes on Copyright

Unless intended solely for personal use, images recorded using your digital camera system cannot be used in ways that infringe copyright laws without the consent of the owner. Note that some restrictions apply to the photographing of stage performances, entertainments, and exhibits, even when intended purely for personal use. Users are also asked to note that the transfer of memory cards containing images or data protected under copyright laws is only permissible within the restrictions imposed by those copyright laws.

### Handling

To ensure that images are recorded correctly, do not subject the camera to impact or physical shocks while images are being recorded.

### Liquid Crystal

In the event that the LCD monitor is damaged, care should be taken to avoid contact with liquid crystal. Take the urgent action indicated should any of the following situations arise:

- **If liquid crystal comes in contact with your skin**, clean the area with a cloth and then wash thoroughly with soap and running water.
- **If liquid crystal enters your eyes**, flush the affected eye with clean water for at least 15 minutes and then seek medical assistance.
- **If liquid crystal is swallowed**, rinse your mouth thoroughly with water. Drink large quantities of water and induce vomiting, then seek medical assistance.

Although the display is manufactured using extremely high-precision technology, it may contain pixels that are always lit or that do not light. This is not a malfunction, and images recorded with the product are unaffected.

### Trademark Information

**xD-Picture Card** and **.xP** are trademarks of FUJIFILM Corporation. The typefaces included herein are solely developed by Dyna-Comware Taiwan Inc. Macintosh, QuickTime, and Mac OS are trademarks of Apple Inc. in the U.S.A. and other countries. Windows 7, Windows Vista, and the Windows logo are trademarks of the Microsoft group of companies. Adobe and Adobe Reader are either trademarks or registered trademarks of Adobe Systems Incorporated in the U.S.A. and/or other countries. The SDHC and SDXC logos are trademarks of SD-3C, LLC. The HDMI logo is a trademark. YouTube is a trademark of Google Inc. All other trade names mentioned in this manual are the trademarks or registered trademarks of their respective owners.

### Electrical Interference

This camera may interfere with hospital or aviation equipment. Consult with hospital or airline staff before using the camera in a hospital or on an aircraft.

### Color Television Systems

NTSC (National Television System Committee) is a color television telecasting specification adopted mainly in the U.S.A., Canada, and Japan. PAL (Phases Alternation by Line) is a color television system adopted mainly in European countries and China.

### Exif Print (Exif Version 2.3)

Exif Print is a newly revised digital camera file format in which information stored with photographs is used for optimal color reproduction during printing.

### IMPORTANT NOTICE: Read Before Using the Software

Direct or indirect export, in whole or in part, of licensed software without the permission of the applicable governing bodies is prohibited.



**IMPORTANT:** Read this section before using the toponyms included in this product.

#### Toponym Data License Agreement

**Personal Use Only.** You agree to use this Data together with this digital camera for the solely personal, non-commercial purposes for which you were licensed, and not for service bureau, time-sharing or other similar purposes. Accordingly, but subject to the restrictions set forth in the following paragraphs, you may copy this Data only as necessary for your personal use to (i) view it, and (ii) save it, provided that you do not remove any copyright notices that appear and do not modify the Data in any way. You agree not to otherwise reproduce, copy, modify, decompile, disassemble or reverse engineer any portion of this Data, and may not transfer or distribute it in any form, for any purpose, except to the extent permitted by mandatory laws. Multi-disc sets may only be transferred or sold as a complete set as provided by FUJIFILM Corporation and not as a subset thereof.

**Restrictions.** Except where you have been specifically licensed to do so by FUJIFILM Corporation, and without limiting the preceding paragraph, you may not (a) use this Data with any products, systems, or applications installed or otherwise connected to or in communication with vehicles, capable of vehicle navigation, positioning, dispatch, real time route guidance, fleet management or similar applications; or (b) with or in communication with any positioning devices or any mobile or wireless-connected electronic or computer devices, including without limitation cellular phones, palmtop and handheld computers, pagers, and personal digital assistants or PDAs.

**Warning.** The Data may contain inaccurate or incomplete information due to the passage of time, changing circumstances, sources used and the nature of collecting comprehensive geographic data, any of which may lead to incorrect results.

**No Warranty.** This Data is provided to you "as is," and you agree to use it at your own risk. FUJIFILM Corporation and its licensors (and their licensors and suppliers) make no guarantees, representations or warranties of any kind, express or implied, arising by law or otherwise, including but not limited to, content, quality, accuracy, completeness, effectiveness, reliability, fitness for a particular purpose, usefulness, use or results to be obtained from this Data, or that the Data or server will be uninterrupted or error-free.

**Disclaimer of Warranty.** FUJIFILM Corporation AND ITS LICENSORS (INCLUDING THEIR LICENSORS AND SUPPLIERS) DISCLAIM ANY WARRANTIES, EXPRESS OR IMPLIED, OF QUALITY, PERFORMANCE, MERCHANTABILITY, FITNESS FOR A PARTICULAR PURPOSE OR NON-INFRINGEMENT. Some States, Territories and Countries do not allow certain warranty exclusions, so to that extent the above exclusion may not apply to you.

**Disclaimer of Liability.** FUJIFILM Corporation AND ITS LICENSORS (INCLUDING THEIR LICENSORS AND SUPPLIERS) SHALL NOT BE LIABLE TO YOU: IN RESPECT OF ANY CLAIM, DEMAND OR ACTION, IRRESPECTIVE OF THE NATURE OF THE CAUSE OF THE CLAIM, DEMAND OR ACTION ALLEGING ANY LOSS, INJURY OR DAMAGES, DIRECT OR INDIRECT, WHICH MAY RESULT FROM THE USE OR POSSESSION OF THE INFORMATION; OR FOR ANY LOSS OF PROFIT, REVENUE, CONTRACTS OR SAVINGS, OR ANY OTHER DIRECT, INDIRECT, INCIDENTAL, SPECIAL OR CONSEQUENTIAL DAMAGES ARISING OUT OF YOUR USE OF OR INABILITY TO USE THIS INFORMATION, ANY DEFECT IN THE INFORMATION, OR THE BREACH OF THESE TERMS OR CONDITIONS, WHETHER IN AN ACTION IN CONTRACT OR TORT OR BASED ON A WARRANTY, EVEN IF FUJIFILM Corporation OR ITS LICENSORS HAVE BEEN ADVISED OF THE POSSIBILITY OF SUCH DAMAGES. Some States, Territories and Countries do not allow certain liability exclusions or damages limitations, so to that extent the above may not apply to you.

**Export Control.** You agree not to export from anywhere any part of the Data provided to you or any direct product thereof except in compliance with, and with all licenses and approvals required under, applicable export laws, rules and regulations.

**Entire Agreement.** These terms and conditions constitute the entire agreement between FUJIFILM Corporation (and its licensors, including their licensors and suppliers) and you pertaining to the subject matter hereof, and supersedes in their entirety any and all written or oral agreements previously existing between us with respect to such subject matter.

**Goveming Law.** The above terms and conditions shall be governed by the laws of the State of Illinois, Netherlands, without giving effect to (i) its conflict of laws provisions, or (ii) the United Nations Convention for Contracts for the International Sale of Goods, which is explicitly excluded. You agree to submit to the jurisdiction of the State of Illinois, The Netherlands for any and all disputes, claims and actions arising from or in connection with the Data provided to you hereunder.

**Geodetics.** The geodetic system used by this device to record latitude and longitude is WGS 84.

**Copyright.** The map data included in this device are protected under copyright law and except for personal use may not be employed without the permission of the copyright holder.

**Navigation.** This device can not be used for purposes of navigation.

### Licensed Software Copyright Holders



© 2010 NAVTEQ All rights reserved.



This service uses POI (Points Of Interest) of ZENRIN CO., LTD. "POWERED BY ZENRIN" is a trademark of ZENRIN CO., LTD. © 2010 ZENRIN CO., LTD. All rights reserved.

© Her Majesty the Queen in Right of Canada, © Queen's Printer for Ontario, © Canada Post Corporation, GeoBase®, © Department of Natural Resources Canada, ZIP+4®, © United States Postal Service® 2010. the USPS®.

Australia	Copyright. Based on data provided under license from PSMA Australia Limited ( <a href="http://www.pasma.com.au">www.pasma.com.au</a> ).
Austria	"© Bundesamt für Eich- und Vermessungswesen"
Croatia, Cyprus, Estonia, Latvia, Lithuania, Moldova, Poland, Slovenia and/or Ukraine	"© EuroGeographics"
France	The following notice must appear on all copies of the Data, and may also appear on packaging: "source: © IGN France – BD TOPO®"
Germany	"Die Grundlagendaten wurden mit Genehmigung der zuständigen Behörden entnommen" or "Die Grundlagendaten wurden mit Genehmigung der zustaendigen Behoerden entnommen."
Great Britain	"Based upon Crown Copyright material"
Greece	"Copyright Geomatics Ltd."
Hungary	"Copyright © 2003; Top-Map Ltd."
Italy	"La Banca Dati Italiana è stata prodotta usando quale riferimento anche cartografia numerica ed al tratto prodotta e fornita dalla Regione Toscana."
Norway	"Copyright © 2000; Norwegian Mapping Authority"
Portugal	"Source: IgeoE – Portugal"
Spain	"Información geográfica propiedad del CNIG"
Sweden	"Based upon electronic data Ö National Land Survey Sweden."
Switzerland	"Topografische Grundlage: Ö Bundesamt für Landestopographie."

## About This Manual

Before using the camera, read this manual and the warnings in “For Your Safety” (📖 ii). For information on specific topics, consult the sources below.

### **Table of Contents** ..... 📖 xv

The “Table of Contents” gives an overview of the entire manual. The principal camera operations are listed here.

### **Troubleshooting** ..... 📖 93

Having a specific problem with the camera? Find the answer here.

### **Warning Messages and Displays** ..... 📖 99

Find out what’s behind that flashing icon or error message in the display.

### **Memory Cards**

Pictures can be stored in the camera’s internal memory or on optional SD, SDHC, and SDXC memory cards (📖 14), referred to in this manual as “memory cards.”

## Frequently-Used Buttons

### ■ Deleting Pictures

➔ To delete a picture, display it full frame and press the selector up (🗑️).



### ■ Taking Pictures During Playback

➔ To return instantly to shooting mode, press the shutter button halfway.



### ■ Turning the Camera on in Playback Mode

➔ When the camera is off, playback can be started by pressing the  button for about a second.



### ■ Silent Mode

➔ Press and hold the **DISP/BACK** button to disable camera lights and sounds.



## Product Features and Precautions for Use

---

### ■ Water, Dust, and Shock Resistance

- ① The camera complies with JIS Class 8 water resistance and JIS Class 6 (IP68) dust resistance standards, and has passed FUJIFILM drop tests (drop height: 1.5 m/4.9 ft.; impact surface: plywood, thickness 5 cm/2.0 in.) compliant with MIL-STD 810F Method 516.5: Shock. These results were obtained through in-house testing and are not a blanket guarantee of water resistance or invulnerability to damage or destruction. The accessories supplied with the camera are not water resistant.

### ■ Before Use

- ① The front surface of the camera lens is protected by a sheet of glass. Foreign matter on the glass will appear in photographs; keep the glass clean at all times.
- ① Be sure that the battery-chamber and connector covers are fully latched. The presence of water, mud, or sand in the camera could cause malfunction.
- ① Do not open or close the battery-chamber or connector cover with wet hands or near water, for example while on or by a body of water.
- ① Be sure the camera is completely dry before inserting or removing batteries or memory cards or connecting the USB or A/V cable.
- ① The camera does not float. Be sure to attach the strap and keep it around your wrist when using the camera.

### ■ During Use

- ① Restrict underwater use to depths of 5 m (16 ft.) or less and periods shorter than 120 minutes.
- ① Do not open or close the battery-chamber cover while under water.
- ① Do not use in hot springs or heated pools.
- ① Do not dive into water with the camera or otherwise subject it to excessive force.
- ① If the camera is left on the sand, its temperature may exceed operating limits and sand may get into the speaker or microphone.
- ① Sunscreen, suntan lotion, or other oily substances may discolor the camera body and should be removed with a damp cloth.
- ① The camera may lose water resistance if subjected to excessive force or vibration. Consult your retailer or a FUJIFILM-authorized repair technician.

### ■ After Use

- ① Remove any foreign matter from the water-resistant seal and adjacent surfaces. Foreign matter could damage the seal, lowering water resistance.
- ① After using the camera underwater or in locations where foreign matter might adhere to the camera body, rinse the camera under the tap or leave it in a basin of fresh water for two to three minutes.
- ① Liquid soaps, detergents, alcohol, and other cleansers may affect water resistance and should never be used.
- ① After use, remove water droplets and foreign matter with a dry cloth, firmly latch the battery-chamber cover, and soak the camera in fresh water for about ten minutes. Dry the camera thoroughly after removing it from the water.

### ■ Storage and Maintenance

- ① Do not store at temperatures below 0 °C (32 °F) or above 40 °C (104 °F).
- ① To ensure continued water resistance, it is recommended that you have the water-resistant seal replaced about once a year (a fee is charged for this service). Contact your retailer or a FUJIFILM-authorized repair technician for more information.

### ■ Cold Climates

- ① Battery performance drops at low temperatures, reducing the number of pictures that can be taken. Insulate the camera to keep it warm or place it in your clothing.
- ① Use an NP-45A battery.
- ① Display response may slow at low temperatures. This is not a malfunction.

# Table of Contents

For Your Safety .....	ii
IMPORTANT SAFETY INSTRUCTIONS .....	ii
Safety Notes .....	iv
About This Manual .....	xi
Frequently-Used Buttons .....	xii
Product Features and Precautions for Use .....	xiii

## Before You Begin

Symbols and Conventions .....	1
Supplied Accessories .....	1
Parts of the Camera .....	2
Camera Displays .....	4
Shooting .....	4
Playback .....	5







## First Steps















Charging the Battery .....	7
Inserting the Battery and a Memory Card .....	9
Compatible Memory Cards .....	14
Turning the Camera on and Off .....	16
Shooting Mode .....	16
Playback Mode .....	16
Basic Setup .....	18

## Basic Photography and Playback









































Taking Pictures in  (Scene Recognition) Mode .....	19
Viewing Pictures .....	23

## More on Photography

Shooting Mode .....	24
Choosing a Shooting Mode .....	24
Shooting Mode Options .....	25
 MOTION PANORAMA .....	27
Recording GPS Data with Pictures .....	29
 Intelligent Face Detection .....	32
Focus Lock .....	33
 Exposure Compensation .....	35
 Macro Mode (Close-ups) .....	36
 Using the Flash (Intelligent Flash) .....	37
 Using the Self-Timer .....	39

<b>More on Playback</b>		<b>Connections</b>	
Playback Options.....	40	Viewing Pictures on TV .....	51
★ Favorites: Rating Pictures .....	40	Printing Pictures via USB .....	52
Playback Zoom.....	41	Printing the DPOF Print Order.....	54
Multi-Frame Playback.....	42	<b>Viewing Pictures on a Computer</b> .....	56
 Deleting Pictures.....	43	Windows: Installing MyFinePix Studio .....	56
 Image Search.....	44	Macintosh: Installing FinePixViewer.....	58
 PhotoBook Assist.....	45	Connecting the Camera .....	60
Creating a PhotoBook.....	45	<b>Menus</b>	
Viewing Photobooks .....	46	<b>Using the Menus: Shooting Mode</b> .....	63
Editing and Deleting Photobooks.....	46	Using the Shooting Menu.....	63
Viewing Panoramas .....	47	Shooting Menu Options .....	63
<b>Movies</b>		 SHOOTING MODE.....	63
Recording Movies.....	48	 ISO .....	64
Viewing Movies .....	50	 IMAGE SIZE .....	65
		 IMAGE QUALITY .....	66
		 FINEPIX COLOR .....	66
		 WHITE BALANCE .....	67
		 CONTINUOUS .....	68
		 FACE DETECTION.....	68
		 AF MODE.....	69
		 MOVIE QUALITY .....	69
		 LED ILLUMINATOR.....	69



<b>Using the Menus: Playback Mode</b> .....	70	<b>The Setup Menu</b> .....	80
Using the Playback Menu .....	70	Using the Setup Menu .....	80
Playback Menu Options .....	70	Setup Menu Options .....	81
 PHOTOBOOK ASSIST .....	70	 DATE/TIME .....	81
 PHOTO NAVIGATION .....	71	 TIME DIFFERENCE .....	81
 IMAGE SEARCH .....	71	 言語 / LANG. ....	81
 ERASE .....	71	 SILENT MODE .....	81
 BLOG EDIT .....	72	 RESET .....	82
 MARK FOR UPLOAD TO .....	73	 FORMAT .....	82
 SLIDE SHOW .....	74	 LOCATION SEARCH .....	82
 RED EYE REMOVAL .....	75	 TRACKING DATA .....	83
 PROTECT .....	75	 LOCATION INFO .....	83
 CROP .....	76	 km/mile .....	83
 RESIZE .....	76	 IMAGE DISP. ....	84
 IMAGE ROTATE .....	77	 FRAME NO. ....	84
 COPY .....	77	 OPERATION VOL. ....	85
 TRANSITION .....	78	 SHUTTER VOLUME .....	85
 MOVIE TRIMMING .....	78	 SOUND .....	85
MOVIE JOIN .....	79	 PLAYBACK VOLUME .....	85
 PRINT ORDER (DPOF) .....	79	 LCD BRIGHTNESS .....	85
		 LCD MODE .....	86
		 AUTO POWER OFF .....	86
		 DUAL IS MODE .....	86
		 RED EYE REMOVAL .....	86
		 DIGITAL ZOOM .....	87
		 SAVE ORG IMAGE .....	87
		 GUIDANCE DISPLAY .....	87
		 VIDEO SYSTEM .....	88

<b>Technical Notes</b>		<b>Troubleshooting</b>	
<b>Optional Accessories</b> .....	89	<b>Problems and Solutions</b> .....	93
Accessories from FUJIFILM .....	90	<b>Warning Messages and Displays</b> .....	99
<b>Caring for the Camera</b> .....	91	<b>Appendix</b>	
Storage and Use .....	91	<b>Tips and Tricks</b> .....	103
Condensation .....	91	<b>Internal Memory/Memory Card Capacity</b> .....	106
Cleaning .....	92	<b>Specifications</b> .....	107
Traveling .....	92		

# Before You Begin

## Symbols and Conventions

The following symbols are used in this manual:

- ⓘ : This information should be read before use to ensure correct operation.
- ◆ : Additional information that may be helpful when using the camera.
- 📖 : Other pages in this manual on which related information may be found.

Menus and other text in the LCD monitor are shown in **bold**. In the illustrations in this manual, displays may be simplified for explanatory purposes.

## Supplied Accessories

The following items are included with the camera:

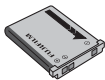

NP-45A rechargeable  
battery

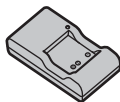

BC-45B battery charger

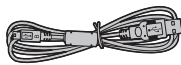

USB cable



CD-ROM (contains  
this manual)

- Strap
- User Guide

### Attaching the Strap

Attach the strap as shown.

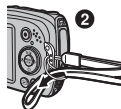
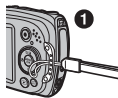

## Parts of the Camera

For more information, refer to the page listed to the right of each item.

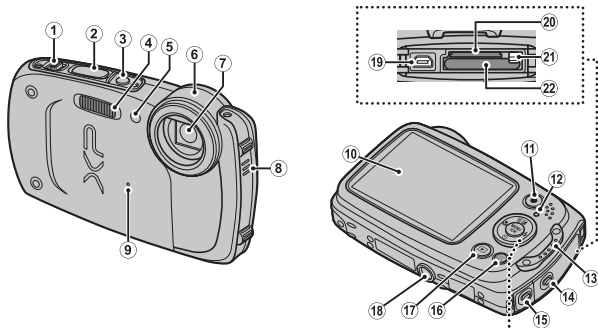

### Selector button

#### Move cursor up

 (exposure compensation) button ( 35)

 (delete) button ( xii)

#### Move cursor left

 (macro) button ( 36)

#### Move cursor down



 (self-timer) button ( 39)

MENU/OK button

#### Move cursor right

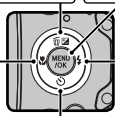
 (flash) button ( 37)



<b>1</b>	Zoom control .....	20, 41	<b>12</b>	Indicator lamp (see below)	
<b>2</b>	Shutter button .....	21	<b>13</b>	Strap eyelet .....	1
<b>3</b>	<b>ON/OFF</b> button .....	16	<b>14</b>	Battery-chamber cover latch .....	9, 12
<b>4</b>	Flash .....	37	<b>15</b>	Connector cover latch .....	51, 52, 60
<b>5</b>	Self-timer lamp .....	39	<b>16</b>	<b>DISP</b> (display)/ <b>BACK</b> button .....	6, 18
	LED illuminator .....	69		 (silent mode) button .....	xii
<b>6</b>	Built-in GPS antenna .....	29	<b>17</b>	 (playback) button .....	23
<b>7</b>	Lens/protective glass		<b>18</b>	Tripod mount	
<b>8</b>	Speaker .....	50	<b>19</b>	USB multi-connector .....	52, 60
<b>9</b>	Microphone .....	48	<b>20</b>	Memory card slot .....	11
<b>10</b>	LCD monitor .....	4	<b>21</b>	Battery latch .....	10, 13
<b>11</b>	 (movie recording) button .....	48	<b>22</b>	Battery chamber .....	9

\*Press and hold the **DISP/BACK** button until  is displayed.

## The Indicator Lamp

The indicator lamp shows camera status as follows:

Indicator lamp	Camera status
Glows green	Focus locked.
Blinks green	Blur, focus, or exposure warning. Picture can be taken.
Blinks green and orange	Recording pictures. Additional pictures can be taken.
Glows orange	Recording pictures. No additional pictures can be taken at this time.
Blinks orange	Flash charging; flash will not fire when picture is taken.
Blinks red	Lens or memory error.

## Camera Displays

The following types of indicator may be displayed during shooting and playback. Indicators vary with camera settings.

### Shooting

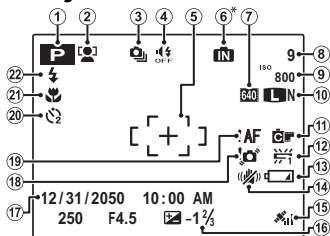

7	Movie quality.....	48
8	Number of available frames.....	106
9	Sensitivity.....	64
10	Image size and quality.....	65, 66
11	FINEPIX color .....	66
12	White balance.....	67
13	Battery level .....	5
14	Dual IS mode .....	86
15	GPS signal strength.....	29
16	Exposure compensation.....	35
17	Date and time .....	18
18	Blur warning .....	38, 99
19	Focus warning .....	21, 99
20	Self-timer indicator .....	39
21	Macro (close-up) mode.....	36
22	Flash mode .....	37

1	Shooting mode.....	24
2	Intelligent Face Detection indicator .....	32
3	Continuous shooting mode.....	68
4	Silent mode indicator .....	3, 81
5	Focus frame .....	33
6	Internal memory indicator*	

\* **IN**: indicates that no memory card is inserted and that pictures will be stored in the camera's internal memory (📖 11).

## Playback

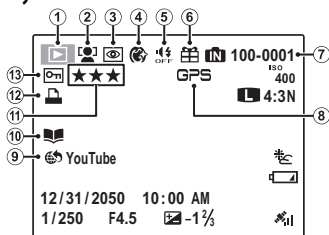

1	Playback mode indicator.....	23, 40
2	Intelligent Face Detection indicator .....	32, 75
3	Red-eye removal indicator .....	75
4	Portrait enhancer.....	25
5	Silent mode indicator .....	3, 81
6	Gift image.....	40
7	Frame number .....	84
8	GPS data .....	30
9	Mark for upload to .....	73
10	Photobook assist.....	45
11	Favorites .....	40
12	DPOF print indicator .....	54
13	Protected image .....	75

### Battery Level

Battery level is shown as follows:

Indicator	Description
(white)	Battery partially discharged.
(white)	Battery more than half discharged.
(red)	Low battery. Charge as soon as possible.
(blinks red)	Battery exhausted. Turn camera off and charge battery.

### **Hiding and Viewing Indicators**

Press **DISP/BACK** to cycle through shooting and playback indicators as follows:

- **Shooting:** Indicators displayed/indicators hidden/best framing
- **Playback:** Indicators displayed/indicators hidden/★ favorites



# First Steps

## Charging the Battery

The battery is not charged at shipment. Charge the battery before use.

### 1 Place the battery in the supplied battery charger.

Insert the battery in the orientation indicated by the  $\oplus$   $\text{Ⓜ}$   $\ominus$  labels.

The camera uses an NP-45A rechargeable battery.

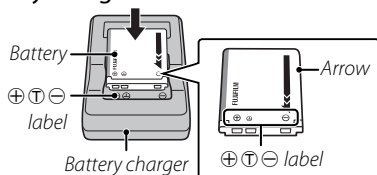

### 2 Plug the charger in.

Plug the charger into a power outlet. The charging indicator will light.

#### The Charging Indicator

The charging indicator shows battery charge status as follows:

Charging indicator	Battery status	Action
Off	Battery not inserted.	Insert the battery.
On (green)	Battery fully charged.	Remove the battery.
On (yellow)	Battery charging.	—
Blinks (yellow)	Battery fault.	Unplug the charger and remove the battery.

### **3 Charge the battery.**

Remove the battery when charging is complete. See the specifications (📖 111) for charging times (note that charging times increase at low temperatures).

- ⓘ Unplug the charger when it is not in use.

## Inserting the Battery and a Memory Card

Although the camera can store pictures in internal memory, optional SD, SDHC, and SDXC *memory cards* (sold separately) can be used to store additional pictures. After charging the battery, insert the battery and memory card as described below.

### 1 Open the battery-chamber cover.

Press the latch as shown.

- ❖ Be sure the camera is off before opening the battery-chamber cover.
- ① Do not open the battery-chamber cover when the camera is on. Failure to observe this precaution could result in damage to image files or memory cards.
- ① Do not use excessive force when handling the battery-chamber cover.
- ① Remove water droplets and other foreign matter with a dry cloth before opening the battery-chamber cover.

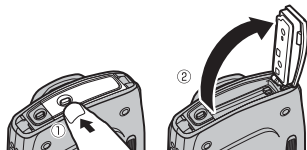

## 2 Insert the battery.

Insert the battery with the terminal first and in the orientation shown by the label inside the battery chamber, keeping the battery latch pressed to one side. Confirm that the battery is securely latched.

- ⓘ Insert the battery in the correct orientation. **Do NOT use force or attempt to insert the battery upside down or backwards.** The battery will slide in easily in the correct orientation.

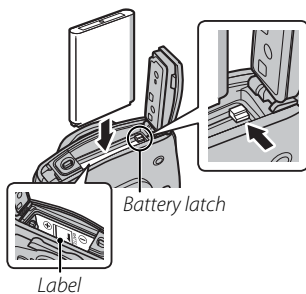

### 3 Insert the memory card.

Holding the memory card in the orientation shown at right, slide it in until it clicks into place at the back of the slot.

- ① Be sure card is in the correct orientation; do not insert at an angle or use force. If the memory card is not correctly inserted or no memory card is inserted,  will appear in the LCD monitor and internal memory will be used for recording and playback.
- ① SD/SDHC/SDXC memory cards can be locked, making it impossible to format the card or to record or delete images. Before inserting an SD/SDHC/SDXC memory card, slide the write-protect switch to the unlocked position.

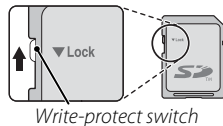
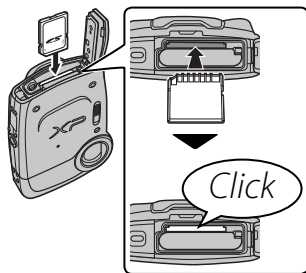

#### 4 Close the battery-chamber cover.

Before closing the cover, check to confirm that there is no dust, sand, or other foreign matter on the water-resistant seal or adjacent surfaces.



#### Confirming That the Cover Is Latched

- Confirm that the battery-chamber or connector cover does not protrude from the camera body.

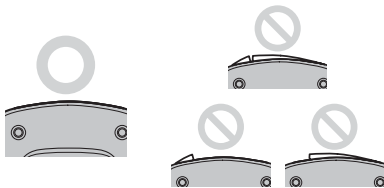

- The covers are latched when the latches are in the positions shown below at left.

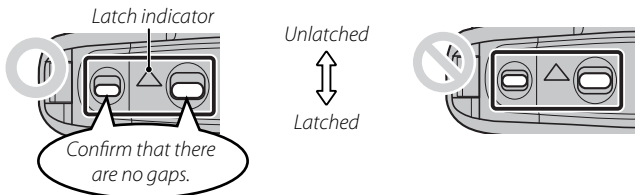

## Removing the Battery and Memory Card

Before removing the battery or memory card, **turn the camera off** and press the latch to open the battery-chamber cover.

To remove the battery, press the battery latch to the side, and slide the battery out of the camera as shown.

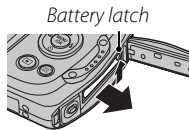

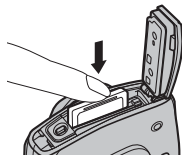

To remove the memory card, press it in and release it slowly. The card can then be removed by hand. When a memory card is removed, the card could come out of the slot too quickly. Use your finger to hold it and gently release the card.



## ■ Compatible Memory Cards

FUJIFILM and SanDisk SD, SDHC, and SDXC memory cards have been approved for use in the camera. A complete list of approved memory cards is available at [http://www.fujifilm.com/support/digital\\_cameras/compatibility/](http://www.fujifilm.com/support/digital_cameras/compatibility/). Operation is not guaranteed with other cards. The camera can not be used with *xD-Picture Cards* or MultiMediaCard (MMC) devices.

### ① Memory Cards

- **Do not turn the camera off or remove the memory card while the memory card is being formatted or data are being recorded to or deleted from the card.** Failure to observe this precaution could damage the card.
- Format SD/SDHC/SDXC memory cards before first use, and be sure to reformat all memory cards after using them in a computer or other device. For more information on formatting memory cards, see “ **FORMAT**” (📖 82).
- Memory cards are small and can be swallowed; keep out of reach of children. If a child swallows a memory card, seek medical assistance immediately.
- miniSD or microSD adapters that are larger or smaller than the standard dimensions of an SD/SDHC/SDXC card may not eject normally; if the card does not eject, take the camera to an authorized service representative. Do not forcibly remove the card.
- Do not affix labels to memory cards. Peeling labels can cause camera malfunction.
- Movie recording may be interrupted with some types of SD/SDHC/SDXC memory card. Use a **CLASS 4**  card or better when shooting HD movies.



- The data in internal memory may be erased or corrupted when the camera is repaired. Please note that the repairer will be able to view pictures in internal memory.
- Formatting a memory card or internal memory in the camera creates a folder in which pictures are stored. Do not rename or delete this folder or use a computer or other device to edit, delete, or rename image files. Always use the camera to delete pictures from memory cards and internal memory; before editing or renaming files, copy them to a computer and edit or rename the copies, not the originals.

### ① Batteries

- Remove dirt from the battery terminals with a clean, dry cloth. Failure to observe this precaution could prevent the battery from charging.
- Do not affix stickers or other objects to the battery. Failure to observe this precaution could make it impossible to remove the battery from the camera.
- Do not short the battery terminals. The battery could overheat.
- Read the cautions in “The Battery and Power Supply” (📖 vi).
- Use only battery chargers designated for use with the battery. Failure to observe this precaution could result in product malfunction.
- Do not remove the labels from the battery or attempt to split or peel the outer casing.
- The battery gradually loses its charge when not in use. Charge the battery one or two days before use.

## Turning the Camera on and Off

### ***Shooting Mode***

Press the **ON/OFF** button to turn the camera on.

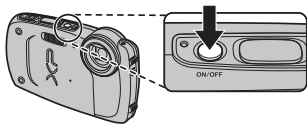

Press **ON/OFF** again to turn the camera off.

### ◆ **Switching to Playback Mode**

Press the **▶** button to start playback. Press the shutter button halfway to return to shooting mode.

### ***Playback Mode***

To turn the camera on and begin playback, press the **▶** button for about a second.

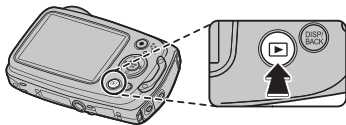



Press the **▶** button again or press the **ON/OFF** button to turn the camera off.

### ◆ **Switching to Shooting Mode**



To exit to shooting mode, press the shutter button halfway. Press the **▶** button to return to playback.

- ⓘ Fingerprints and other marks on the protective glass covering the lens can affect pictures. Keep the glass clean.
- ⓘ The **ON/OFF** button does not completely end the supply of power to the camera.

### 🔍 **Auto Power Off**

The camera will turn off automatically if no operations are performed for the length of time selected for  **AUTO POWER OFF** (📖 86). To turn the camera on, use the **ON/OFF** button or press the  button for about a second.

## Basic Setup

A language-selection dialog is displayed the first time the camera is turned on. Set up the camera as described below (you can reset the clock or change languages at any time using the  **DATE/TIME** or  **言語/LANG.** options in the setup menu; for information on displaying the setup menu, see page 81).

### 1 Highlight a language and press **MENU/OK**.

- ◆ Press **DISP/BACK** to skip the current step. Any steps you skip will be displayed the next time the camera is turned on.

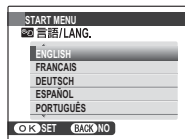

### 2 The date and time will be displayed. Press the selector left or right to highlight the year, month, day, hour, or minute and press up or down to change. To change the order in which the year, month, and day are displayed, highlight the date format and press the selector up or down. Press **MENU/OK** when settings are complete.

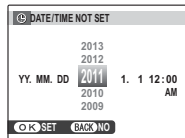

### ◆ The Camera Clock

If the battery is removed for an extended period, the camera clock will be reset and the language-selection dialog will be displayed when the camera is turned on.

# Basic Photography and Playback

## Taking Pictures in (Scene Recognition) Mode

This section describes how to take pictures in  (scene recognition) mode. The camera automatically analyzes the composition and adjusts settings appropriately.

### 1 Turn the camera on.

Press the **ON/OFF** button to turn the camera on.

 shooting indicators will be displayed.

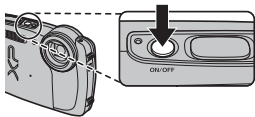







### The Icon

This icon indicates that the camera continuously searches for faces to select the appropriate scene, increasing the drain on the battery.



### The Scene Icon

The camera selects the scene according to shooting conditions and the type of subject:  PORTRAIT (portraits),  LANDSCAPE (landscapes),  NIGHT (poorly-lit landscapes),  MACRO (close ups),  NIGHT PORTRAIT (poorly-lit portraits),  BACKLIT PORTRAIT (backlit portraits),  AUTO (all other scenes)

## 2 Frame the picture.

Use the zoom control to frame the picture in the display.

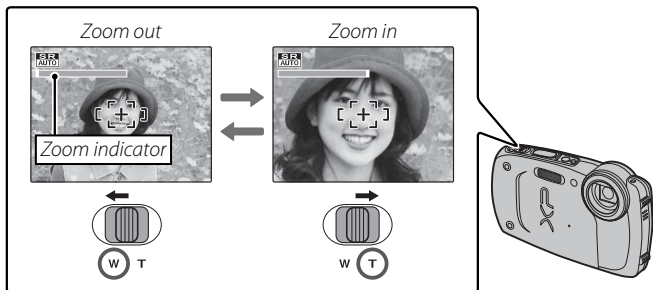

### **Holding the Camera**

Hold the camera steady with both hands and brace your elbows against your sides. Shaking or unsteady hands can blur your shots.



To prevent pictures that are out of focus or too dark (underexposed), keep your fingers and other objects away from the flash and from the protective glass covering the lens.

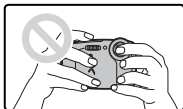

### 3 Focus.

Press the shutter button halfway to focus.

- ◆ The lens may make a noise when the camera focuses; this is normal.

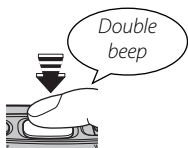

**If the camera is able to focus**, it will beep twice and the indicator lamp will glow green.

**If the camera is unable to focus**, the focus frame will turn red, **!AF** will be displayed, and the indicator lamp will blink green. Change the composition or use focus lock ( 33).

## 4 Shoot.

Smoothly press the shutter button the rest of the way down to take the picture.

- ◆ If the subject is poorly lit, the flash may fire when the picture is taken. For information on using the flash when lighting is poor, see “ Using the Flash (Intelligent Flash)” (📖 37).



### **The Shutter Button**

The shutter button has two positions. Pressing the shutter button halfway sets focus and exposure; to shoot, press the shutter button the rest of the way down.



## Viewing Pictures

Pictures can be viewed in the LCD monitor. When taking important photographs, take a test shot and check the results.

### 1 Press the button.

The most recent picture will be displayed.

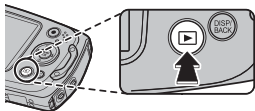

### 2 View additional pictures.

Press the selector right to view pictures in the order recorded, left to view pictures in reverse order.

Press the shutter button halfway to exit to shooting mode.

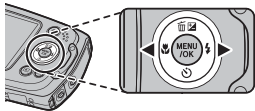

# More on Photography

## Shooting Mode

Choose a shooting mode according to the scene or type of subject.

### Choosing a Shooting Mode

1 Press **MENU/OK** to display the shooting menu.

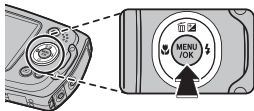

2 Highlight **SHOOTING MODE** and press the selector right to display shooting mode options.

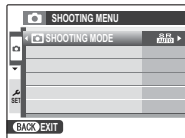



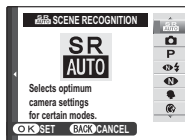

















3 Highlight the desired mode and press **MENU/OK**.



4 Press **DISP/BACK** to exit to shooting mode.



***Shooting Mode Options***

Mode	Description
 <b>SCENE RECOGNITION</b>	The camera automatically analyzes the composition and selects a scene according to shooting conditions and the type of subject.
 <b>AUTO</b>	Choose for crisp, clear snapshots. This mode is recommended in most situations.
<b>P PROGRAM AE</b>	The camera sets exposure automatically.
 <b>NATURAL &amp; </b>	The camera takes two shots: one without the flash and one with.
 <b>NATURAL LIGHT</b>	Capture natural lighting under low-light conditions.
 <b>PORTRAIT</b>	Choose for portraits.
 <b>PORTRAIT ENHANCER</b>	Choose for a smooth skin effect when shooting portraits.
 <b>LANDSCAPE</b>	Choose for daylight shots of buildings and landscapes.
 <b>MOTION PANORAMA</b>	Take up to three pictures and join them together to form a panorama.
 <b>SPORT</b>	Choose when photographing moving subjects.
 <b>NIGHT</b>	Choose this mode for poorly lit twilight or night scenes.
 <b>NIGHT (TRIPOD)</b>	Choose this mode for slow shutter speeds when shooting at night.
 <b>SUNSET</b>	Choose this mode to record the vivid colors in sunrises and sunsets.
 <b>SNOW</b>	Choose for crisp, clear shots that capture the brightness of scenes dominated by shining white snow.
 <b>BEACH</b>	Choose for crisp, clear shots that capture the brightness of sunlit beaches.

Mode	Description
 <b>UNDERWATER</b>	Choose for underwater photography.
 <b>UNDER WATER (WIDE)</b>	Choose for wide-angle underwater shots that include more of the background behind the main subject.
 <b>UNDER WATER (MACRO)</b>	Choose for underwater close-ups of small objects.
 <b>PARTY</b>	Capture indoor background lighting under low-light conditions.
 <b>FLOWER</b>	Choose for vivid close-ups of flowers.
 <b>TEXT</b>	Take clear pictures of text or drawings in print.

## ■ MOTION PANORAMA

In this mode, you can take up to three pictures and join them together to form a panorama. Use of a tripod is recommended to assist in composing overlapping shots.

- 1 Press the selector up to select a frame. Press the selector left or right to highlight a pan direction and press **MENU/OK**.
- 2 Take a photograph. Exposure and white balance for the panorama are set with the first shot.
- 3 Frame the next shot to overlap with the previous picture by superimposing  on  so that they form a solid circle (). The camera will release the shutter automatically.

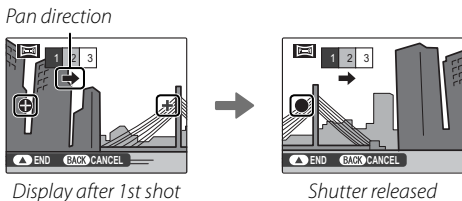

**4** Take the last shot as described in Step 3.

- ◆ To end shooting and create a panorama after the first or second shot, press the multi selector up after completing Step 2 or Step 3 and proceed to Step 5.

**5** Press **MENU/OK** to save the picture.

- ⓘ Panoramas are created from multiple frames. The camera may in some cases be unable to stitch the frames together perfectly.
- ⓘ The desired results may not be achieved with moving subjects, subjects close to the camera, unvarying subjects such as the sky or a field of grass, subjects that are in constant motion, such as waves and waterfalls, or subjects that undergo marked changes in brightness. Panoramas may be blurred if the subject is poorly lit.

**For Best Results**

For best results, be careful not to tilt the camera backward or forward or to either side and try not to move the camera while **+** and **+** are aligned to form a solid circle.

**Printing Panoramas**

Depending on the page size and the size of the panorama, panoramas may print with their edges cropped out or with wide margins at the top and bottom or at both sides.

## Recording GPS Data with Pictures

To record GPS data with new pictures, press **MENU/OK** and select one of the following options for **GPS LOCATION SEARCH** in the setup menu (📖 82).

- **📍 PERMANENTLY ON:** The camera continues to update GPS data even when turned off. The camera will be quicker to display GPS data when turned on, but the drain on the battery will increase.
- **📍 WHEN SWITCHED ON:** The camera updates GPS data only when on. The camera may need some time to acquire GPS data when turned on. This option is selected automatically at battery levels of  and below.

🔍 GPS works best outdoors under clear skies.

During shooting, GPS data are displayed in the monitor as shown at right. Signal strength is indicated by the number of bars; 📶 is displayed when the camera is searching for a signal and 📶 if no signal is detected. The current location is shown by a place name or (if no place name is available) by the longitude and latitude.



🔍 The display of GPS information can be turned off by selecting **OFF** for **GPS LOCATION INFO** (📖 83).

- ❗ Using GPS increases the drain on the battery, causing battery performance to drop at low temperatures.
- ❗ The receiver may have an error of a few hundred meters (yards).
- ❗ The camera may be unable to receive GPS data in some locations. If possible, choose an outdoor location with few obstructions when turning the camera on.
- ❗ The position recorded when a photo is taken may differ from the actual location if some time has passed since the camera was last able to update GPS data.
- ❗ Select **OFF** for **GPS LOCATION SEARCH** (📖 82) and **GPS TRACKING DATA** (📖 83) in the setup menu when in a hospital and before takeoff and landing if traveling by air.
- ❗ Place names are current as of the date on which the map database was created (📖 109) and will not be updated to reflect any changes after that date.
- ❗ Comprehensive place name data are unavailable in some countries and regions. If no name is available, the latitude and longitude will be displayed for a few seconds.

### 📍 Viewing GPS Data

During playback, pictures for which GPS data exist are indicated by a **GPS** icon. GPS data are shown for a few seconds each time the picture is displayed.





 **GPS**

The camera may be unable to receive GPS data if the antenna (📶 2) is obstructed or when underground, underwater, under a bridge or overpass, inside a vehicle, building, tunnel, or metal briefcase, between tall buildings, or in the vicinity of cell phones or other devices that broadcast in the 1.5 GHz band.

Obey all local regulations regarding the use of GPS devices. Note that the use of GPS devices is restricted in some countries, including the People's Republic of China. Before going abroad, consult with the embassy or a travel agent. The camera may display 📶 (no signal) in locations in which restrictions apply.

## Intelligent Face Detection

Intelligent Face Detection sets focus and exposure for human faces anywhere in the frame, preventing the camera from focusing on the background in group portraits. Choose for shots that emphasize portrait subjects.

To use Intelligent Face Detection, press **MENU/OK** to display the shooting menu and select **ON** for

**FACE DETECTION** (📖 68). Faces can be detected with the camera in vertical or horizontal orientation; if a face is detected, it will be indicated by a green border. If there is more than one face in the frame, the camera will select the face closest to the center; other faces are indicated by white borders.

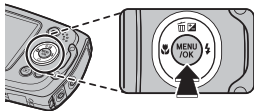

- ❗ In some modes, the camera may set exposure for the frame as a whole rather than the portrait subject.
- ❗ If the subject moves as the shutter button is pressed, their face may not be in the area indicated by the green border when the picture is taken.

## Focus Lock

To compose photographs with off-center subjects:

**1 Focus:** Position the subject in the focus frame (⌈⌊⌋⌋) and press the shutter button halfway to lock focus and exposure. Focus and exposure will remain locked while the shutter button is pressed halfway (AF/AE lock).

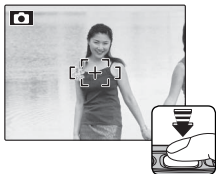

**2 Recompose:** Keep the button pressed halfway.



**3 Shoot:** Press the button all the way down.



### Autofocus

Although the camera boasts a high-precision autofocus system, it may be unable to focus on the subjects listed below. If the camera is unable to focus, focus on another subject at the same distance and use focus lock to recompose the photograph.

- Very shiny subjects such as mirrors or car bodies.
- Fast-moving subjects.
- Subjects photographed through a window or other reflective object.
- Dark subjects and subjects that absorb rather than reflect light, such as hair or fur.
- Insubstantial subjects, such as smoke or flame.
- Subjects that show little contrast with the background (for example, subjects in clothing that is the same color as the background).
- Subjects positioned in front of or behind a high-contrast object that is also in the focus frame (for example, a subject photographed against a backdrop of highly contrasting elements).

## Exposure Compensation

To adjust exposure compensation when photographing very bright, very dark, or high-contrast subjects, press the selector up () . Press the selector up or down to choose an exposure compensation value and then press **MENU/OK**.

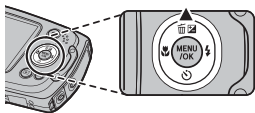

*Choose positive (+) values  
to increase exposure*





*Choose negative (-) values  
to reduce exposure*



- ❖ A  icon and exposure indicator are displayed at settings other than  $\pm 0$ . Exposure compensation is not reset when the camera is turned off; to restore normal exposure control, choose a value of  $\pm 0$ .
- ❖ Turn the flash off when using exposure compensation.
- ❖ Exposure compensation is available only when **P** (PROGRAM AE) is selected for shooting mode.

## Macro Mode (Close-ups)

For close-ups, press the selector left () and select . When macro mode is in effect, the camera focuses on subjects near the center of the frame. Use the zoom control to compose pictures ( 20).

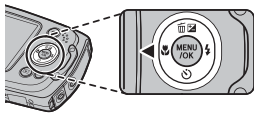

To exit macro mode, press the selector left () and select  OFF.

-  Use of a tripod is recommended to prevent blur caused by camera shake.

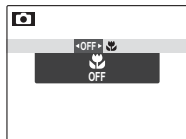



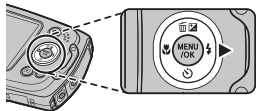

## ⚡ Using the Flash (Intelligent Flash)

When the flash is used, the camera's *Intelligent Flash* system instantly analyzes the scene based on such factors as the brightness of the subject, its position in the frame, and its distance from the camera. Flash output and sensitivity are adjusted to ensure that the main subject is correctly exposed while preserving the effects of ambient background lighting, even in dimly-lit indoor scenes. Use the flash when lighting is poor, for example when shooting at night or indoors under low light.





Press the selector right (⚡) and choose from the following flash modes:



Option	Description
<b>AUTO</b> /  (AUTO FLASH)	The flash fires when required. Recommended in most situations.
<b>⚡</b> /  (FORCED FLASH)	The flash fires whenever a picture is taken. Use for backlit subjects or for natural coloration when shooting in bright light.
<b>Ⓜ</b> (SUPPRESSED FLASH)	The flash does not fire even when the subject is poorly lit. Use of a tripod is recommended.
<b>S</b> /  (SLOW SYNCHRO)	Capture both the main subject and the background under low light (note that brightly lit scenes may be overexposed).

- ◆ If the flash will fire,  will be displayed when the shutter button is pressed halfway. At slow shutter speeds,  will appear in the display to warn that pictures may be blurred; use of a tripod is recommended.
- ◆ The flash may fire several times with each shot. Do not move the camera until shooting is complete.
- ◆ The flash may cause vignetting.

### Red-Eye Removal

When Intelligent Face Detection ( 32) and red-eye removal ( 75) are on, red-eye removal is available in auto ( RED EYE REDUCTION), flash on ( FORCED FLASH), and slow sync ( RED EYE & SLOW) modes. Red-eye removal minimizes “*red-eye*” caused when light from the flash is reflected from the subject’s retinas as shown in the illustration at right.





## ⏸ Using the Self-Timer

To use the self-timer, press the selector down (⏸) and choose from the following options:

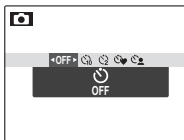
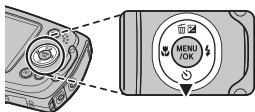

Option	Description
⏸ (OFF)	Self-timer off.
♥♥ (COUPLE TIMER)	The camera starts the timer when it detects two portrait subjects close together. Press the selector up to choose how close the subjects must be together before the timer starts (the more hearts, the closer the subjects must be together). ◆ To stop the timer before the picture is taken, press <b>DISP/BACK</b> .
👤 (GROUP TIMER)	The camera will start the timer when it detects the selected number of portrait subjects. Press the selector up to choose the number of subjects. ◆ To stop the timer before the picture is taken, press <b>DISP/BACK</b> .
🕒 (10 SEC)	The shutter is released ten seconds after the shutter button is pressed. Use for self-portraits. The self-timer lamp on the front of the camera blinks while the timer counts down.
🕒 (2 SEC)	The shutter is released two seconds after the shutter button is pressed. Use to reduce blur caused by the camera moving when the shutter-release button is pressed. The self-timer lamp will blink as the timer counts down.

## More on Playback

### Playback Options

To view the most recent picture in the LCD monitor, press the  button.

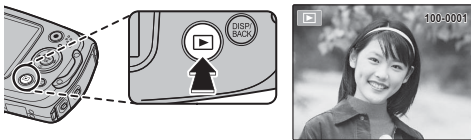

Press the selector right to view pictures in the order recorded, left to view pictures in reverse order. Keep the selector pressed to scroll rapidly to the desired frame.

- ◆ Pictures taken using other cameras are indicated by a  ("gift image") icon during playback.

### ★ Favorites: Rating Pictures

To rate the picture currently displayed in full-frame playback, press **DISP/BACK** and press the selector up and down to select from zero to five stars.

**Playback Zoom**

Select **T** to zoom in on pictures displayed in single-frame playback; select **W** to zoom out. When the picture is zoomed in, the selector can be used to view areas of the image not currently visible in the display.

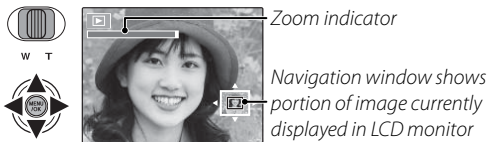

Press **DISP/BACK** to exit zoom.

- ◆ The maximum zoom ratio varies with image size. Playback zoom is not available with cropped or resized copies saved at a size of **640** or smaller.

**Multi-Frame Playback**

Selecting **W** when a picture is shown full-frame in the LCD monitor displays the current image with previous and following images in the background. Select **W** to increase the number of images displayed to two, nine, or one hundred, **T** to view fewer images.

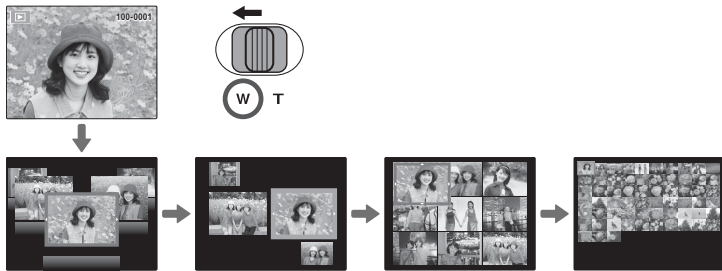

When two or more images are displayed, use the selector to highlight images and press **MENU/OK** to view the highlighted image full frame. In the nine- and hundred-frame displays, use the selector to view more pictures.

## Deleting Pictures

To delete individual pictures, multiple selected pictures, or all pictures, press **MENU/OK**, select  **ERASE** (📖 71), and choose from the options below. *Note that deleted pictures can not be recovered. Copy important pictures to a computer or other storage device before proceeding.*

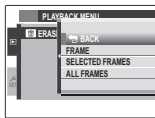









Option	Description
<b>FRAME</b>	Press the selector left or right to scroll through pictures and press <b>MENU/OK</b> to delete the current picture (a confirmation dialog is not displayed).
<b>SELECTED FRAMES</b>	Highlight pictures and press <b>MENU/OK</b> to select or deselect (pictures that are protected or in a print order are shown by  ). When the operation is complete, press <b>DISP/BACK</b> to display a confirmation dialog, then highlight <b>OK</b> and press <b>MENU/OK</b> to delete the selected pictures.
<b>ALL FRAMES</b>	A confirmation dialog will be displayed; highlight <b>OK</b> and press <b>MENU/OK</b> to delete all unprotected pictures (if a memory card is inserted, only the pictures on the memory card will be affected; the pictures in internal memory are only deleted if no memory card is inserted). Pressing <b>DISP/BACK</b> cancels deletion; note that any pictures deleted before the button was pressed can not be recovered.

- ❖ Protected pictures can not be deleted. Remove protection from any pictures you wish to delete (📖 75).
- ❖ If a message appears stating that the selected images are part of a DPOF print order, press **MENU/OK** to delete the pictures.

## Image Search

Search for pictures.



- 1 Select  **IMAGE SEARCH** in the playback menu ( 71), highlight one of the following search criteria, and press **MENU/OK**:
  - **BY DATE**: Search by date.
  - **BY GPS LOCATION NAME**: Search by location name (location names that do not begin with a letter from A to Z are listed in the search conditions under "#").
  - **BY FACE**: Search for faces from the face recognition database.
  - **BY ★ FAVORITES**: Search by rating.
  - **BY SCENE**: Search by scene.
  - **BY TYPE OF DATA**: Find all still pictures, all movies, or edited pictures.
  - **BY UPLOAD MARK**: Find all pictures selected for upload to a specified destination.
- 2 Select a search condition. Only pictures that match the search condition will be displayed. To delete or protect selected pictures or to view the search results in a slide show, press **MENU/OK** and choose  **ERASE** ( 43),  **PROTECT** ( 75), or  **SLIDE SHOW** ( 74).

## PhotoBook Assist

---

Create books from your favorite photos.

### ***Creating a PhotoBook***

- 1 Select **NEW BOOK** for  **PHOTOBOOK ASSIST** in the playback menu ( 70) and choose from the following options:
    - **SELECT FROM ALL:** Choose from all available pictures.
    - **SELECT BY IMAGE SEARCH:** Choose from pictures matching selected search conditions ( 44).
      - ◆ Neither photographs  or smaller nor movies can be selected for photobooks.
  - 2 Scroll through the images and press the selector up to select or deselect. To display the current image on the cover, press the selector down. Press **MENU/OK** to exit when the book is complete.
    - ◆ The first picture selected becomes the cover image. Press the selector down to select a different image for the cover.
  - 3 Select **COMPLETE PHOTOBOOK** (to select all photos or all photos matching the specified search conditions for the book, choose **SELECT ALL**). The new book will be added to the list in the photobook assist menu.
- ⓘ Books can contain up to 300 pictures.
- ⓘ Books that contain no photos are automatically deleted.

### **Viewing Photobooks**

Highlight a book in the photobook assist menu and press **MENU/OK** to display the book, then press the selector left or right to scroll through the pictures.

### **Editing and Deleting Photobooks**

Display the photobook and press **MENU/OK**. The following options will be displayed; select the desired option and follow the on-screen instructions.

- **EDIT:** Edit the book as described in “Creating a PhotoBook” (📖 45).
- **ERASE:** Delete the book.



#### **Photobooks**

Photobooks can be copied to a computer using the supplied MyFinePix Studio software.



## Viewing Panoramas

If you press the selector down when a panorama is displayed full frame, the camera will play back the picture from left to right. To pause playback, press the selector down; press the selector down again to resume. To exit to full-frame playback, press the selector up while panorama playback is in progress.

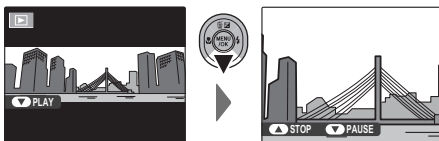

# Movies

## Recording Movies

Press **REC** to shoot a movie. During recording, **REC** and the time remaining will be displayed in the LCD monitor and sound will be recorded via the built-in microphone (be careful not to cover the microphone during recording).

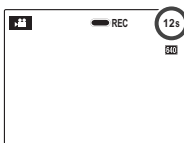
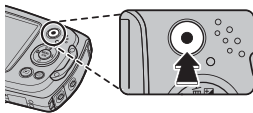

*Time available is displayed in monitor*

To end recording, press the **REC** button again. Recording ends automatically when the movie reaches maximum length or memory is full.

- Zoom can be adjusted while recording is in progress.
- Before recording, select a frame size using the **MOVIE QUALITY** option in the shooting menu. Select **HD 1280** (1280×720) for an aspect ratio of 16:9 (High Definition) or **640** (640×480) to record longer standard definition movies.
- Focus, exposure and white balance are adjusted automatically throughout recording. The color and brightness of the image may vary from that displayed before recording begins.
- Sounds made by the camera may be recorded.

- ❗ The indicator lamp lights while movies are being recorded. Do not open the battery chamber during shooting or while the indicator lamp is lit. Failure to observe this precaution could prevent the movie from being played back.
- ❗ Vertical or horizontal streaks may appear in movies containing very bright subjects. This is normal and does not indicate a malfunction.
- ❗ The temperature of the camera may rise if it is used to record movies for an extended period or if the ambient temperature is high. This is normal and does not indicate a malfunction.

## Viewing Movies

During playback, movies are displayed in the LCD monitor as shown at right. The following operations can be performed while a movie is displayed:

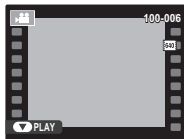

Option	Description
Start/pause playback	<b>Press the selector down</b> to start playback. Press again to pause.
End playback/delete	<b>Press the selector up</b> to end playback. If playback is not in progress, pressing the selector up will delete the movie.
Advance/rewind	<b>Press the selector right</b> to advance, <b>left</b> to rewind. If playback is paused, the movie will advance or rewind one frame each time the selector is pressed.
Adjust volume	<b>Press MENU/OK</b> to pause playback and display volume controls. Press the selector up or down to adjust the volume and press <b>MENU/OK</b> to exit. Volume can also be adjusted from the setup menu.

ⓘ Do not cover the speaker during playback.

# Connections

## Viewing Pictures on TV

Connect the camera to a TV to show pictures to a group.

- 1 Turn the camera off and connect an optional A/V cable as shown below.

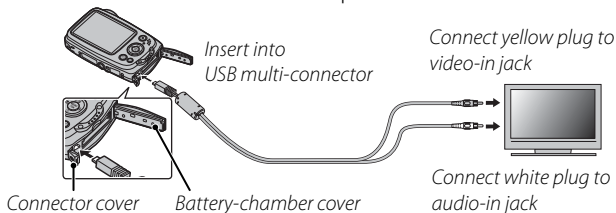

- ① When connecting cables, be sure the connectors are fully inserted.
  - ① Be sure the battery-chamber cover is open before attempting to open or close the connector cover.
  - ❖ Image quality may drop during movie playback.
  - ❖ Optional accessories (📖 89, 90) are required to view HD movies on a high-definition TV. The HDP-L1 HD player uses SDHC and SD memory cards.
- 2 Tune the television to the video input channel. See the documentation supplied with the television for details.
- 3 Press the  button for about a second to turn the camera on. The camera monitor turns off and pictures and movies are played back on the TV. Note that the camera volume controls have no effect on sounds played on the TV; use the television volume controls to adjust the volume.

## Printing Pictures via USB

If the printer supports PictBridge, the camera can be connected directly to the printer as shown below and pictures can be printed without first being copied to a computer. Note that depending on the printer, not all the functions described below may be supported.



**1** Connect the supplied USB cable as shown and turn the printer on.

- ⓘ Be sure the battery-chamber cover is open before attempting to open or close the connector cover.

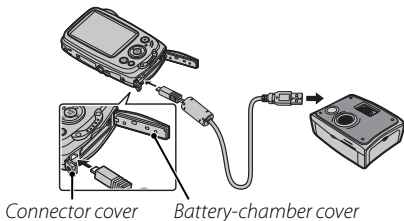

**2** Press the  button for about a second to turn the camera on.

**3** Press the selector left or right to display a picture you wish to print.

**4** Press the selector up or down to choose the number of copies (up to 99).

**5** Repeat steps 3–4 to select additional pictures. Press **MENU/OK** to display a confirmation dialog when settings are complete.

- 6 Press **MENU/OK** to start printing. Printing can be interrupted by pressing **DISP/BACK**, but note that some printers may not respond immediately. If the printer stops before printing is complete, turn the camera off and then on again.
  - 7 After confirming that **PRINTING** has cleared from the camera display, turn the camera off and disconnect the USB cable.
- ❖ Pictures can be printed from internal memory or a memory card that has been formatted in the camera.
  - ❖ If no pictures are selected, the camera will print one copy of the current picture.
  - ❖ Page size, print quality, and border selections are made using the printer.

#### **Printing the Date of Recording**

To print the date of recording on pictures, press **DISP/BACK** in the PictBridge display and select **PRINT WITH DATE**  in the PictBridge menu (to print pictures without the date of recording, select **PRINT WITHOUT DATE**).

### **Printing the DPOF Print Order**

The  **PRINT ORDER (DPOF)** option in the playback menu can be used to create a digital “print order” for PictBridge-compatible printers (📖 89) or devices that support DPOF.

#### **DPOF**

DPOF (Digital Print Order Format) is a standard that allows pictures to be printed from “print orders” stored in internal memory or on a memory card. The information in the order includes the pictures to be printed and the number of copies of each picture.



- 1 Select playback mode and press **MENU/OK** to display the playback menu.
- 2 Highlight  **PRINT ORDER (DPOF)** and press **MENU/OK**.
- 3 Highlight one of the following options and press **MENU/OK**:
  - **WITH DATE** : Print the date of recording on pictures.
  - **WITHOUT DATE**: Do not print the date of recording on pictures.

 Some printers do not support date printing. See the printer manual for details.
- 4 Press the selector left or right to display a picture you wish to add to or remove from the print order.



- 5 Press the selector up or down to choose the number of copies (up to 99). To remove a picture from the print order, press the selector down until the number of copies is zero.
- 6 Repeat Steps 4–5 to complete the print order and press **MENU/OK** when settings are complete.
- 7 A confirmation dialog will be displayed. Press **MENU/OK** to save the print order.
  - ◆ Remove the memory card to create or modify a print order for the pictures in internal memory.
  - ◆ Print orders can contain a maximum of 999 pictures.
  - ◆ If a memory card is inserted containing a print order created by another camera, a message will be displayed. Create a new print order as described above.

## Viewing Pictures on a Computer

The supplied software can be used to copy pictures to a computer, where they can be stored, viewed, organized, and printed. Before proceeding, install the software as described below. *Do not connect the camera to the computer until installation is complete.*

### ***Windows: Installing MyFinePix Studio***

**1** Confirm that the computer meets the following system requirements:

	Windows 7*	Windows Vista*	Windows XP*
<b>CPU</b>	3 GHz Pentium 4 or better		2 GHz Pentium 4 or better
<b>RAM</b>	1 GB or more		512 MB or more
<b>Free disk space</b>	15 GB or more		2 GB or more
<b>Video</b>	<ul style="list-style-type: none"><li>• 1024×768 pixels or more with 24-bit color or better</li><li>• A graphics processing unit (GPU) that supports DirectX 7 or later</li></ul>		
<b>Other</b>	<ul style="list-style-type: none"><li>• Built-in USB port recommended. Operation is not guaranteed with other USB ports.</li><li>• Internet connection (broadband recommended) required to install .NET Framework (if necessary), to use auto update feature, and when performing such tasks as sharing pictures on-line or via e-mail.</li></ul>		

\* Other versions of Windows are not supported. Only pre-installed operating systems are supported; operation is not guaranteed on home-built computers or computers that have been upgraded from earlier versions of Windows.

**2** Start the computer. Log in to an account with administrator privileges before proceeding.

- 3 Exit any applications that may be running and insert the installer CD in a CD-ROM drive.

#### **Windows 7/Windows Vista**

If an AutoPlay dialog is displayed, click **SETUP.EXE**. A “User Account Control” dialog will then be displayed; click **Yes** (Windows 7) or **Allow** (Windows Vista).

The installer will start automatically; click **Install MyFinePix Studio** and follow the on-screen instructions to install MyFinePix Studio.

#### **If the Installer Does Not Start Automatically**

If the installer does not start automatically, select **Computer** or **My Computer** from the Start menu, then double-click the **FINEPIX** CD icon to open the FINEPIX CD window and double-click **setup** or **SETUP.EXE**.

- 4 If prompted to install Windows Media Player, DirectX, or .NET Framework, follow the on-screen instructions to complete installation.
- 5 Remove the installer CD from the CD-ROM drive when installation is complete. Store the installer CD in a dry location out of direct sunlight in case you need to re-install the software.

Installation is now complete. Proceed to “Connecting the Camera” (📖 60).

**Macintosh: Installing FinePixViewer**

- 1 Confirm that the computer meets the following system requirements:

<b>CPU</b>	PowerPC or Intel
<b>OS</b>	Pre-installed copies of Mac OS X version 10.3.9–10.6 (visit <a href="http://www.fujifilm.com/support/digital_cameras/compatibility/">http://www.fujifilm.com/support/digital_cameras/compatibility/</a> for more information)
<b>RAM</b>	256 MB or more
<b>Free disk space</b>	A minimum of 200 MB required for installation with 400 MB available when FinePixViewer is running
<b>Video</b>	800 × 600 pixels or more with thousands of colors or better
<b>Other</b>	Built-in USB port recommended. Operation is not guaranteed with other USB ports.

- 2 After starting the computer and quitting any applications that may be running, insert the installer CD in a CD-ROM drive and double-click **Installer for Mac OS X**.
- 3 An installer dialog will be displayed; click **Installing FinePixViewer** to start installation. Enter an administrator name and password when prompted and click **OK**, then follow the on-screen instructions to install FinePixViewer. Click **Exit** to quit the installer when installation is complete.

**4** Remove the installer CD from the CD-ROM drive. Note that you may be unable to remove the CD if Safari is running; if necessary, quit Safari before removing the CD. Store the installer CD in a dry location out of direct sunlight in case you need to re-install the software.

**5 Mac OS X 10.5 or earlier:** Open the “Applications” folder, start Image Capture, and select **Preferences...** from the Image Capture application menu. The Image Capture preferences dialog will be displayed; choose **Other...** in the **When a camera is connected, open** menu, then select **FPVBridge** in the “Applications/FinePixViewer” folder and click **Open**. Quit Image Capture.

**Mac OS X 10.6:** Connect the camera and turn it on. Open the “Applications” folder and start Image Capture. The camera will be listed under **DEVICES**; select the camera and choose **FPVBridge** from the **Connecting this camera opens** menu and click **Choose**. Quit Image Capture.

Installation is now complete. Proceed to “Connecting the Camera” (📖 60).

## **Connecting the Camera**

**1** If the pictures you wish to copy are stored on a memory card, insert the card into the camera.

◆ Windows users may require the Windows CD when starting the software for the first time.

Ⓢ Loss of power during transfer could result in loss of data or damage to internal memory or the memory card. Charge the battery before connecting the camera.

**2** Turn the camera off and connect the supplied USB cable as shown, making sure the connectors are fully inserted. Connect the camera directly to the computer; do not use a USB hub or keyboard.

Ⓢ Be sure the battery-chamber cover is open before attempting to open or close the connector cover.

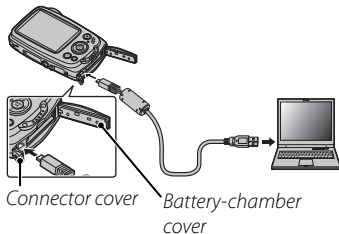

**3** Press the  button for about a second to turn the camera on. MyFinePix Studio or FinePixViewer will start automatically; follow the on-screen instructions to copy pictures to the computer. To exit without copying pictures, click **Cancel**.

◆ If the software does not start automatically, it may not be correctly installed. Disconnect the camera and reinstall the software.

For more information on using the supplied software, start the application and select the appropriate option from the **Help** menu.

- ① If a memory card containing a large number of images is inserted, there may be a delay before the software starts and you may be unable to import or save images. Use a memory card reader to transfer pictures.
- ① Make sure that the computer does not display a message stating that copying is in progress and that the indicator lamp is out before turning the camera off or disconnecting the USB cable (if the number of images copied is very large, the indicator lamp may remain lit after the message has cleared from the computer display). Failure to observe this precaution could result in loss of data or damage to internal memory or the memory card.
- ① Disconnect the camera before inserting or removing memory cards.
- ① In some cases, it may not be possible to access pictures saved to a network server using the supplied software in the same way as on a standalone computer.
- ① The user bears all applicable fees charged by the phone company or Internet service provider when using services that require an Internet connection.

### **Disconnecting the Camera**

After confirming that the indicator lamp is out, follow the on-screen instructions to turn the camera off and disconnect the USB cable.

### **Uninstalling the Supplied Software**

Only uninstall the supplied software when it is no longer required or before beginning reinstallation. After quitting the software and disconnecting the camera, drag the “FinePixViewer” folder from “Applications” into the Trash and select **Empty Trash** in the **Finder** menu (Macintosh), or open the control panel and use “Programs and Features” (Windows 7/Windows Vista) or “Add or Remove Programs” (Windows XP) to uninstall MyFinePix Studio. Under Windows, one or more confirmation dialogs may be displayed; read the contents carefully before clicking **OK**.



# Menus

## Using the Menus: Shooting Mode

### Using the Shooting Menu

To display the shooting menu, press **MENU/OK** in shooting mode. Highlight items and press the selector right to view options, then highlight an option and press **MENU/OK**. Press **DISP/BACK** to exit when settings are complete. The options available vary with the shooting mode selected.

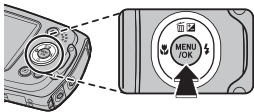

### Shooting Menu Options

#### SHOOTING MODE

(defaults to  AUTO)

Choose a shooting mode according to the type of subject ( 24).

**ISO ISO****(defaults to AUTO)**

Control the camera's sensitivity to light. Higher values can reduce blur; note, however, that mottling may appear in pictures taken at high sensitivities.



Option	Description
<b>AUTO</b>	Sensitivity is adjusted automatically in response to shooting conditions.
<b>3200/1600/800/400/ 200/100</b>	Sensitivity is set to the specified value, which is shown in the display.

## ◀ IMAGE SIZE

(defaults to **L** 4:3)

Choose the image size and aspect ratio at which pictures are recorded. Large pictures can be printed at large sizes with no drop in quality, while small pictures require less memory, allowing more pictures to be recorded.



### ● Size Versus Aspect Ratio

#### Size

Option	Prints at sizes up to
<b>L</b>	34×25 cm (13.5×10 in.)
<b>M</b>	24×18 cm (9.5×7 in.)
<b>S</b>	17×13 cm (7×5 in.)

#### Aspect ratio

**4:3:** Pictures have the same proportions as the camera display.

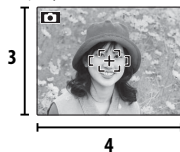

**16:9:** Suited for display on High Definition (HD) devices.

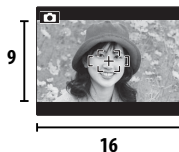





 **IMAGE QUALITY**(defaults to **N**)

Choose how much image files are compressed.

Option	Description
<b>FINE</b>	Low compression. Select for higher image quality.
<b>NORMAL</b>	High compression. Select this option to store more pictures.

 **FINEPIX COLOR**(defaults to )

Enhance contrast and color saturation or take pictures in black and white.

Option	Description
 <b>STANDARD</b>	Standard contrast and saturation. Recommended in most situations.
 <b>CHROME</b>	Vivid contrast and color. Choose for vivid shots of flowers or enhanced greens and blues in landscapes.
 <b>B&amp;W</b>	Take pictures in black and white.
 <b>SEPIA</b>	Take pictures in sepia.

- ◆ Settings other than  **STANDARD** are shown by an icon in the LCD monitor.
- ◆ Depending on the subject, the effects of  **CHROME** may not be visible in the LCD monitor.

**WB WHITE BALANCE****(defaults to AUTO)**

For natural colors, choose a setting that matches the light source.

Option	Description
<b>AUTO</b>	White balance adjusted automatically.
☀	For subjects in direct sunlight.
☁	For subjects in the shade.
☼	Use under "daylight" fluorescent lights.
☽	Use under "warm white" fluorescent lights.
☾	Use under "cool white" fluorescent lights.
💡	Use under incandescent lighting.

- ◆ Results vary with shooting conditions. Play pictures back after shooting to check colors in the LCD monitor.

### CONTINUOUS

(defaults to **OFF**)

Capture motion in a series of pictures.

Option	Description
 <b>ON</b>	The camera takes up to 3 pictures while the shutter button is pressed.
<b>OFF</b>	One photograph is taken each time the shutter button is pressed.



- ◆ Focus and exposure are determined by the first frame in each series.
- ◆ The flash turns off automatically. The previously selected flash mode is restored when **OFF** is selected for  **CONTINUOUS**.
- ◆ Frame rate varies with shutter speed.
- ◆ The number of pictures that can be recorded depends on the memory available.

### FACE DETECTION

Choose whether the camera automatically detects and sets focus and exposure for human portrait subjects ( 32).

**AF MODE**

This option controls how the camera selects the focus area. Regardless of the option selected, the camera will focus on the subject in the center of the LCD monitor when macro mode is on.

Option	Description
 <b>CENTER</b>	The camera focuses on the subject in the center of the frame.
 <b>TRACKING</b>	Position the subject in the center focus area and press the selector left. Focus will track the subject as it moves through the frame.

◆ Note that in  mode, the camera focuses continuously, increasing the drain on the battery, and that the sound of the camera focusing may be audible.

**MOVIE QUALITY**(defaults to )

Choose a frame size for movies ( 48).

**LED ILLUMINATOR**(defaults to **OFF**)

Choose whether the LED ( 2) lights to illuminate nearby subjects when lighting is poor.

Option	Description
<b>ON</b>	The LED lights during shooting.
<b>OFF</b>	LED off.

◆ The LED will not light when **ON** is selected for  **SILENT MODE** in the setup menu ( 81).

◆ Selecting **ON** increases the drain on the battery. Select **OFF** when the LED is not in use.

## Using the Menus: Playback Mode

---

### Using the Playback Menu

To display the playback menu, press **MENU/OK** in playback mode. Highlight items and press the selector right to view options, then highlight an option and press **MENU/OK**. Press **DISP/BACK** to exit when settings are complete.

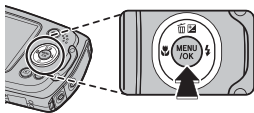

### Playback Menu Options

#### PHOTOBOOK ASSIST

Create books from your favorite photos (🗨 45).

---



**GPS PHOTO NAVIGATION**

To show the direction and distance from your present position to the location where a picture was taken:

- 1 Select an option other than **OFF** for **GPS LOCATION SEARCH** in the setup menu (☰ 82) and confirm that the camera is receiving GPS data (☰ 29).
- 2 Display a picture with a **GPS** icon.
- 3 Select **GPS PHOTO NAVIGATION** in the playback menu. The approximate direction and distance to the location where the picture was taken are displayed as shown, using the units selected for **GPS km/mile** in the setup menu (☰ 83). Distances over 1000 units are indicated by ">", those under 100 units by "<".

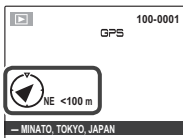

- ◆ Photo navigation ends when the next picture is displayed.

**IMAGE SEARCH**

Search for pictures (☰ 44).

**ERASE**

Delete all or selected pictures (☰ 43).

**Blog EDIT**

Create a retouched copy of the current picture.

- 1 Display the desired picture.
- 2 Select **Blog EDIT** in the playback menu and choose from the following options:

Option	Description
<b>CROP</b>	Crop the copy.
<b>ASPECT RATIO</b>	Choose the aspect ratio.
<b>BRIGHTNESS</b>	Adjust brightness.
<b>CONTRAST</b>	Adjust contrast.
<b>COLOR</b>	Choose positive values for “warmer” colors, negative values for “cooler” colors.
<b>SEPIA</b>	Convert the copy to sepia or black and white.
<b>FACE MOSAIC</b>	If the original was taken with Intelligent Face Detection, a mosaic effect can be applied to up to four faces. If Intelligent Face Detection was off or no faces were detected, the mosaic effect will be applied to the center of the image.

- 3 Press **MENU/OK** to create a retouched copy (in some cases, additional options will be displayed; adjust settings as desired and press **MENU/OK** to save the copy).



- ◆ Retouched copies can not be further retouched, cropped, or rotated.
- ◆ Retouched copies are 640 × 480 pixels in size.

## MARK FOR UPLOAD TO

Select pictures for upload to YouTube or Facebook using MyFinePix Studio (Windows only).

### ■ Selecting Pictures for Upload

- 1 Select **YouTube** to choose movies for upload to YouTube, **FACEBOOK** to choose photos and movies for upload to Facebook.
- 2 Press the selector left or right to display pictures and press **MENU/OK** to select or deselect. Press **DISP/BACK** to exit when all the desired pictures are selected.

- ◆ Only movies can be selected for upload to YouTube.
- ◆ During playback, selected pictures are indicated by  **YouTube** or  **FACEBOOK** icons.

### ■ RESET ALL: Deselecting All Pictures

Choose **RESET ALL** to deselect all pictures. If the number of pictures affected is very large, a message will be displayed while the operation is in progress. Press **DISP/BACK** to exit before the operation is complete.

### ■ Uploading Pictures (Windows Only)

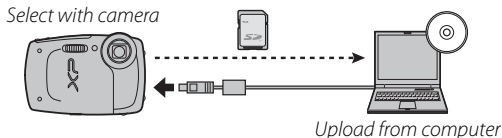

Selected pictures can be uploaded using the **YouTube/Facebook Upload** option in MyFinePix Studio.



For information on installing MyFinePix Studio and connecting the camera to a computer, see "Viewing Pictures on a Computer" (📖 56).

 **SLIDE SHOW**

View pictures in an automated slide show. Choose the type of show and press **MENU/OK** to start. Press **DISP/BACK** at any time during the show to view on-screen help. The show can be ended at any time by pressing **MENU/OK**.



Option	Description
<b>NORMAL</b>	Press selector left or right to go back or skip ahead one frame. Select <b>FADE-IN</b>
<b>FADE-IN</b>	for fade transitions between frames.
<b>NORMAL</b> 	As above, except that camera automatically zooms in on faces selected with
<b>FADE-IN</b> 	Intelligent Face detection.
<b>MULTIPLE</b>	Display several pictures at once.
<b>SCRAP BOOK VIEW</b>	Display multiple pictures in random positions and sizes.
<b>SELECT BGM</b>	Choose background music.

 The camera will not turn off automatically while a slide show is in progress.

**RED EYE REMOVAL**

If the current picture is marked with a  icon to indicate that it was taken with Intelligent Face Detection, this option can be used to remove red-eye. The camera will analyze the image; if red-eye is detected, the image will be processed to create a copy with reduced red-eye.

- 1 Display the desired picture.
- 2 Select  **RED EYE REMOVAL** in the playback menu.
- 3 Press **MENU/OK**.

- ◆ Red eye may not be removed if the camera is unable to detect a face or the face is in profile. Results may differ depending on the scene. Red eye can not be removed from pictures that have already been processed using red-eye removal or pictures created with other devices.
- ◆ The amount of time needed to process the image varies with the number of faces detected.
- ◆ Copies created with  **RED EYE REMOVAL** are indicated by a  icon during playback.

**PROTECT**



Protect pictures from accidental deletion.

- 1 Select  **PROTECT** in the playback menu.
- 2 Highlight one of the following options and press **MENU/OK**:
  - **FRAME**: Protect selected pictures. Press the selector left or right to view pictures and press **MENU/OK** to select or deselect. Press **DISP/BACK** when the operation is complete.
  - **SET ALL**: Protect all pictures.
  - **RESET ALL**: Remove protection from all pictures.

- ① Protected pictures will be deleted when the memory card or internal memory is formatted (see 54).

### CROP

Create a cropped copy of the current picture.

- 1 Display the desired picture.
  - 2 Select  **CROP** in the playback menu.
  - 3 Use the zoom control to zoom in and out and use the selector to scroll the picture until the desired portion is displayed.
  - 4 Press **MENU/OK** to display a confirmation dialog.
  - 5 Press **MENU/OK** again to save the cropped copy to a separate file.
- ◆ Larger crops produce larger copies; all copies have an aspect ratio of 4:3. If the size of the final copy will be , **YES** will be displayed in yellow.

### RESIZE

Create a small copy of the current picture.

- 1 Display the desired picture.
  - 2 Select  **RESIZE** in the playback menu.
  - 3 Highlight a size and press **MENU/OK** to display a confirmation dialog.
  - 4 Press **MENU/OK** to save the resized copy to a separate file.
- ◆ The sizes available vary with the size of the original image.
-

**IMAGE ROTATE**

Rotate pictures taken in tall orientation so that they are displayed in tall orientation in the LCD monitor.

- 1 Display the desired picture.
  - 2 Select **IMAGE ROTATE** in the playback menu.
  - 3 Press the selector down to rotate the picture 90° clockwise, up to rotate it 90° counterclockwise.
  - 4 Press **MENU/OK**. The picture automatically be displayed in the selected orientation whenever it is played back on the camera.
- ◆ Protected pictures can not be rotated. Remove protection before rotating pictures (📖 75).
  - ◆ The camera may not be able to rotate pictures created with other devices.

**COPY COPY**

Copy pictures from internal memory to a memory card.

- 1 Select **COPY COPY** in the playback menu.
  - 2 Highlight one of the following options and press the selector right:
    - **INTERNAL MEMORY → SD CARD**: Copy pictures from internal memory to a memory card.
    - **SD CARD → INTERNAL MEMORY**: Copy pictures from a memory card to internal memory.
  - 3 Highlight one of the following options and press **MENU/OK**:
    - **FRAME**: Copy selected pictures. Press the selector left or right to view pictures and press **MENU/OK** to copy the current picture.
    - **ALL FRAMES**: Copy all pictures.
- ◆ Copying ends when the destination is full.
  - ◆ DPOF print information is not copied (📖 54).

**TRANSITION**(defaults to **OFF**)

Choose the transition between images during playback.

Option	Description
<b>WIPE</b>	Choose for a wipe transition between images.
<b>SLIDE-IN</b>	Images slide into the display.
<b>FADE-IN</b>	The next image fades in as the previous image fades out.
<b>OFF</b>	No transition between frames.

**MOVIE TRIMMING**

Remove opening or ending footage to create an edited copy of the current movie.

- 1 Display the desired movie.
- 2 Select **MOVIE TRIMMING** in the playback menu. To remove footage from the start of the copy, proceed to Step 3; otherwise, proceed to Step 4.
- 3 Press the selector down to begin playback and press it down again when the new opening frame is reached.
- 4 Press **MENU/OK**. To remove footage from the end of the copy, proceed to Step 5; otherwise, proceed to Step 6 (to exit without creating an edited copy, press **DISP/BACK**).
- 5 Press the selector down to begin playback and press it down again when the new closing frame is reached.
- 6 Press **MENU/OK** to save the copy.



**MOVIE JOIN**

Add existing footage to the end of the current movie to create an edited copy.

- 1 Display the desired movie.
  - 2 Select **MOVIE JOIN** in the playback menu.
  - 3 Press the selector left or right to highlight a movie.
  - 4 Press **MENU/OK** to add the highlighted footage to the end of the current movie and save the resulting copy, or press **DISP/BACK** to exit without creating a copy.
- ◆ Both movies must have been recorded at the same frame size and frame rate and have a combined file size of no more than 2 GB.

 **PRINT ORDER (DPOF)**

Select pictures for printing on DPOF- and PictBridge-compatible devices (📖 52).

# The Setup Menu

## Using the Setup Menu

### 1 Display the setup menu.

1.1 Press **MENU/OK** to display the menu for the current mode.

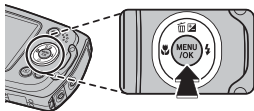

1.2 Press the selector left to highlight the tab for the current menu.

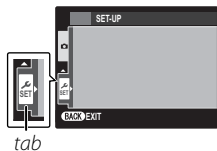

1.3 Press the selector down to highlight **SET**.

1.4 Press the selector right to place the cursor in the setup menu.

### 2 Adjust settings.

Highlight items and press the selector right to view options, then highlight an option and press **MENU/OK**. Press **DISP/BACK** to exit when settings are complete.

**Setup Menu Options****🕒 DATE/TIME**

Set the camera clock (🗨️ 18).

**🕒 TIME DIFFERENCE**

(defaults to 🏠)

Switch the camera clock instantly from your home time zone to the local time at your destination when traveling. To specify the difference between local time and your home time zone:

- 1 Highlight **↔ LOCAL** and press the selector right.
- 2 Use the selector to choose the time difference between local time and your home time zone in increments of 15 minutes.
- 3 Press **MENU/OK**.

To switch between local time and your home time zone, highlight **↔ LOCAL** or **🏠 HOME** and press **MENU/OK**.

Option	Description
🏠 HOME	Switch to the time currently selected for <b>🕒 DATE/TIME</b> (see above).
↔ LOCAL	Switch to local time. If this option is selected, <b>↔</b> and the time and date will be displayed in yellow for three seconds each time the camera is turned on.

**🗨️ 言語/LANG.**(defaults to **ENGLISH**)

Choose a language (🗨️ 109).

**🔇 SILENT MODE**(defaults to **OFF**)

Select **ON** to disable the speaker, flash, and LED illuminator in situations in which camera sounds or lights may be unwelcome (note that the flash will still fire in **🔊** mode).

### **RESET**

Reset all settings except  **DATE/TIME**,  **TIME DIFFERENCE**, and  **VIDEO SYSTEM** to default values.

**1** Highlight  **RESET** and press the selector right to display a confirmation dialog.

**2** Highlight **OK** and press **MENU/OK**.

### **FORMAT**



If a memory card is inserted in the camera, this option will format the memory card. If no memory card is inserted, this option will format internal memory. Select **OK** to begin formatting.

- ⓘ All data—including protected pictures—will be deleted from the memory card or internal memory. Be sure important files have been copied to a computer or other storage device.
- ⓘ Do not open the battery cover during formatting.

### **LOCATION SEARCH**

(defaults to **OFF**)

Turn the GPS receiver on or off ( 29).

Option	Description
 <b>PERMANENTLY ON</b>	The camera updates GPS data even when off.
 <b>WHEN SWITCHED ON</b>	The camera updates GPS data while on.
<b>OFF</b>	GPS receiver off.

**GPS TRACKING DATA**(defaults to **OFF**)

Select **ON** to record GPS data to a log file on the memory card (📖 29; be sure the clock is set to the correct time and date as described on page 18). A new log file is created when **ON** is selected and once every 24 hours thereafter. Note that the camera will continue to update GPS data even when off, increasing the drain on the battery. Choose **OFF** to disable GPS tracking.

- ⓘ GPS logs can be viewed in MyFinePix Studio.
- ⓘ See “GPS” (📖 31) for information on using GPS.
- ⓘ The indicator lamp glows orange during recording GPS data even when the camera is turned off while **ON** is selected. Select **OFF** before removing the battery or memory card. Failure to observe this precaution could damage the card.
- ⓘ Signal strength will be displayed in yellow and GPS data will not be logged if the battery is low (🔋 or less), no memory card is inserted, or the memory card has less than 32 MB free. To resume the log, select **ON** after inserting a charged battery or a memory card with more than 32 MB free.
- ⓘ GPS tracking may be interrupted during movie recording and playback.

**GPS LOCATION INFO**(defaults to **ON**)

Select **ON** to display GPS data.

**GPS km/mile**

Choose the units used for GPS information from **km (m)** (kilometers and meters), **mi (ft)** (miles and feet), or **mi (yd)** (miles and yards).

**IMAGE DISP.** (defaults to **1.5 SEC**)

Choose how long pictures are displayed in the LCD monitor after shooting.

Option	Description
<b>3 SEC</b>	Pictures are displayed for three seconds ( <b>3 SEC</b> ) or 1.5 seconds ( <b>1.5 SEC</b> ).
<b>1.5 SEC</b>	Colors may differ slightly from those in the final image.
<b>ZOOM (CONTINUOUS)</b>	Pictures are displayed until the <b>MENU/OK</b> button is pressed.
<b>OFF</b>	Pictures are not displayed after shooting.

◆ **OFF** has no effect in continuous shooting mode.

**FRAME NO.** (defaults to **CONT.**)

New pictures are stored in image files named using a four-digit file number assigned by adding one to the last file number used. The file number is displayed during playback as shown at right. **FRAME NO.** controls whether file numbering is reset to 0001 when a new memory card is inserted or the current memory card or internal memory is formatted.

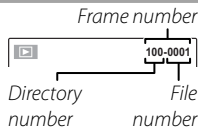

Option	Description
<b>CONTINUOUS</b>	Numbering continues from the last file number used or the first available file number, whichever is higher. Choose this option to reduce the number of pictures with duplicate file names.
<b>RENEW</b>	Numbering is reset to 0001 after formatting or when a new memory card is inserted.

- ◆ If the frame number reaches 999-9999, the shutter release will be disabled (📖 101).
- ◆ Selecting **RESET** (📖 82) sets **FRAME NO.** to **CONTINUOUS** but does not reset the file number.
- ◆ Frame numbers for pictures taken with other cameras may differ.

**OPERATION VOL.** (defaults to )

Adjust the volume of the sounds produced when camera controls are operated. Choose **OFF** (mute) to disable control sounds.

**SHUTTER VOLUME** (defaults to )

Adjust the volume of the sounds produced when the shutter is released. Choose **OFF** (mute) to disable the shutter sound.

**SOUND** (defaults to )

Choose the sounds used for the shutter, at startup, and for camera controls.

**PLAYBACK VOLUME** (defaults to **7**)

Adjust the volume for movie playback.



**LCD BRIGHTNESS** (defaults to **AUTO**)

Control the brightness of the display.

Option	Description
<b>AUTO</b>	Display brightness is automatically adjusted during shooting in response to ambient lighting conditions. Brightness is not adjusted during playback.
<b>MANUAL</b>	Press the selector up or down to adjust brightness and then press <b>MENU/OK</b> . Choose from values between -5 and +5.

### LCD MODE (defaults to ON)



Choose whether the display automatically dims to save power in shooting mode. This option does not take effect during playback.

Option	Description
 POWER SAVE ON	The display dims to save power if no operations are performed for a few seconds. Normal brightness can be restored by pressing the shutter button halfway.
 POWER SAVE OFF	Automatic dimming off.

### AUTO POWER OFF (defaults to 2 MIN)

Choose the length of time before the camera turns off automatically when no operations are performed. Shorter times increase battery life; if **OFF** is selected, the camera must be turned off manually. Note that in some situations the camera turns off automatically even when **OFF** is selected.

### DUAL IS MODE (defaults to 1)

Choose whether image stabilization is performed at all times when the camera is in shooting mode ( **CONTINUOUS**), or only when the shutter button is pressed halfway ( **SHOOTING ONLY**). Choose **OFF** to turn image stabilization off when using a tripod.

### RED EYE REMOVAL (defaults to ON)

Choose **ON** to remove red-eye effects caused by the flash when shooting with Intelligent Face Detection.

-  Red-eye reduction is performed only when a face is detected.



**Q DIGITAL ZOOM**(defaults to **OFF**)

If **ON** is selected, selecting **T** at the maximum optical zoom position will trigger digital zoom, further magnifying the image.

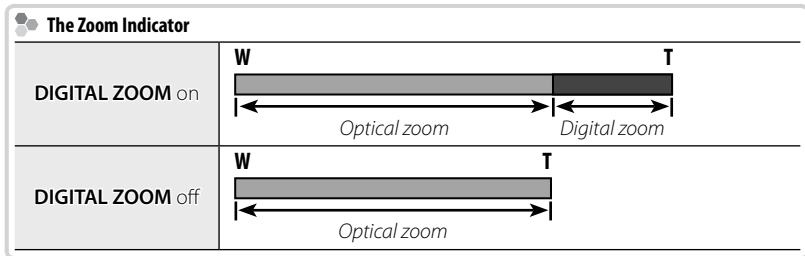

ⓘ Digital zoom produces lower quality images than optical zoom.

**SAVE ORG IMAGE**(defaults to **OFF**)

Select **ON** to save unprocessed copies of pictures taken with red-eye removal.

**F GUIDANCE DISPLAY**(defaults to **ON**)

Choose whether to display tool tips.

### VIDEO SYSTEM

(defaults to **NTSC**)

Choose a video mode for connection to a TV. SECAM is not supported.

<b>Option</b>	<b>Description</b>
<b>NTSC</b>	Select this mode for connection to video devices in North America, the Caribbean, parts of Latin America, and some East Asian countries.
<b>PAL</b>	Select this mode for connection to video devices in the United Kingdom and much of Europe, Australia, New Zealand, and parts of Asia and Africa.

# Technical Notes

## Optional Accessories

The camera supports a wide range of accessories from FUJIFILM and other manufacturers.

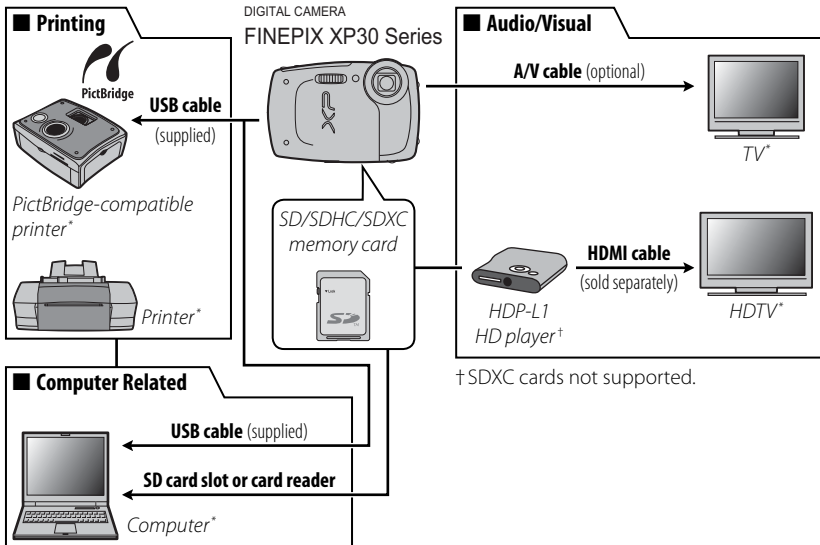



\* Available separately.

† SDXC cards not supported.

**Accessories from FUJIFILM**

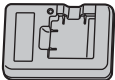
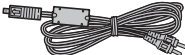
The following optional accessories are available from FUJIFILM. For the latest information on the accessories available in your region, check with your local FUJIFILM representative or visit [http://www.fujifilm.com/products/digital\\_cameras/index.html](http://www.fujifilm.com/products/digital_cameras/index.html).

<b>Rechargeable Li-ion batteries</b>	<b>NP-45A:</b> Additional large-capacity NP-45A rechargeable batteries can be purchased as required.	
<b>Battery chargers</b>	<b>BC-45W:</b> Replacement battery chargers can be purchased as required. The BC-45W charges an NP-45A battery in about 120 minutes at +20 °C (+68 °F).	
<b>A/V cable</b>	<b>AV-C1:</b> Use for viewing pictures on TV.	
<b>HD players</b>	<b>HDP-L1</b> (requires HDMI cable, available from third-party suppliers): Connect to a High Definition (HD) TV to view photographs and movies from SD/SDHC memory cards.	

## Caring for the Camera

---

To ensure continued enjoyment of the product, observe the following precautions.

### ***Storage and Use***

If the camera will not be used for an extended period, remove the battery and memory card. Do not store or use the camera in locations that are:

- exposed to rain, steam, or smoke
- very humid or extremely dusty
- exposed to direct sunlight or very high temperatures, such as in a closed vehicle on a sunny day
- extremely cold
- subject to strong vibration
- exposed to strong magnetic fields, such as near a broadcasting antenna, power line, radar emitter, motor, transformer, or magnet
- in contact with volatile chemicals such as pesticides
- next to rubber or vinyl products

### ■ **Condensation**

Sudden increases in temperature, such as occur when entering a heated building on a cold day, can cause condensation inside the camera. If this occurs, turn the camera off and wait an hour before turning it on again. If condensation forms on the memory card, remove the card and wait for the condensation to dissipate.

### **Cleaning**

Use a blower to remove dust from the protective glass covering the lens and LCD monitor, then gently wipe with a soft, dry cloth. Any remaining stains can be removed by wiping gently with a piece of FUJIFILM lens-cleaning paper to which a small amount of lens-cleaning fluid has been applied. Care should be taken to avoid scratching the protective glass or LCD monitor. The camera body can be cleaned with a soft, dry cloth. Do not use alcohol, thinner, or other volatile chemicals.

### **Traveling**

Keep the camera in your carry-on baggage. Checked baggage may suffer violent shocks that could damage the camera.

# Troubleshooting

## Problems and Solutions

### Water in the Camera

Problem	Solution
Water in the camera	The battery-chamber cover was not fully closed before the camera was immersed, or was opened under water: Take the camera to a FUJIFILM-authorized service technician for repairs. Do not turn the camera on.

### Power and Battery

Problem	Solution
The camera does not turn on.	<ul style="list-style-type: none"><li>• <b>The battery is exhausted:</b> Charge the battery or insert a fully-charged spare battery (📖 7).</li><li>• <b>The battery is inserted incorrectly:</b> Reinsert in the correct orientation (📖 10).</li><li>• <b>The battery-chamber cover is not latched:</b> Latch the battery-chamber cover (📖 10).</li></ul>
The battery runs down quickly.	<ul style="list-style-type: none"><li>• <b>The battery is cold:</b> Warm the battery by placing it in a pocket or other warm place and reinsert it in the camera immediately before taking a picture.</li><li>• <b>There is dirt on the battery terminals:</b> Clean the terminals with a soft, dry cloth.</li><li>• <b>📷 is selected for shooting mode:</b> Select 📷 mode to reduce the drain on the battery (📖 24).</li><li>• <b>🔍 TRACKING is selected for 📷 AF MODE:</b> Select a different AF mode (📖 69).</li><li>• <b>The battery has been charged many times:</b> The battery has reached the end of its charging life. Purchase a new battery.</li><li>• <b>📶 PERMANENTLY ON is selected for 📶 LOCATION SEARCH:</b> Select 📶 WHEN SWITCHED ON or OFF (📖 82).</li><li>• <b>📶 TRACKING DATA is on:</b> Turn 📶 TRACKING DATA off (📖 83).</li></ul>

Problem	Solution
The camera turns off suddenly.	Charge the battery or insert a fully-charged spare battery (📖 7).
Charging does not start.	Reinsert the battery in the correct orientation and make sure that the charger is plugged in (📖 7).
Charging is slow.	Charge the battery at room temperature (📖 vi).
The charging lamp lights, but the battery does not charge.	<ul style="list-style-type: none"> <li>• <b>There is dirt on the battery terminals:</b> Clean the terminals with a soft, dry cloth.</li> <li>• <b>The battery has been charged many times:</b> The battery has reached the end of its charging life. Purchase a new battery. If the battery still fails to charge, contact your FUJIFILM dealer.</li> </ul>

### Menus and Displays



Problem	Solution
Menus and displays are not in English.	Select <b>ENGLISH</b> for  言語/LANG. (📖 18, 81).

### Shooting

Problem	Solution
No picture is taken when the shutter button is pressed.	<ul style="list-style-type: none"> <li>• <b>Memory is full:</b> Insert a new memory card or delete pictures (📖 11, 43).</li> <li>• <b>Memory is not formatted:</b> Format the memory card or internal memory (📖 82).</li> <li>• <b>There is dirt on the memory card contacts:</b> Clean the contacts with a soft, dry cloth.</li> <li>• <b>The memory card is damaged:</b> Insert a new memory card (📖 11).</li> <li>• <b>The battery is exhausted:</b> Charge the battery or insert a fully-charged spare battery (📖 7).</li> <li>• <b>The camera has turned off automatically:</b> Turn the camera on (📖 16).</li> <li>• <b>The indicator lamp was orange when you attempted to record a panorama:</b> Wait until the indicator lamps turns off (📖 3).</li> </ul>



Problem	Solution
The LCD monitor goes dark after shooting.	The LCD monitor may darken while the flash charges. Wait for the flash to charge (📖 37).
The camera does not focus.	<ul style="list-style-type: none"> <li>• <b>The subject is close to the camera:</b> Select macro mode (📖 36).</li> <li>• <b>The subject is far away from the camera:</b> Cancel macro mode (📖 36).</li> <li>• <b>The subject is not suited to autofocus:</b> Use focus lock (📖 33).</li> </ul>
Macro mode is not available	Choose a different shooting mode (📖 24).
GPS	The camera is slow to acquire GPS data: Some time may be needed to acquire GPS data immediately after the camera or 📶 LOCATION SEARCH is turned on or if the camera has been unable to acquire GPS data for an extended period.
Intelligent Face Detection is not available.	Choose a different shooting mode (📖 24).
No face is detected.	<ul style="list-style-type: none"> <li>• <b>The subject's face is obscured by sunglasses, a hat, long hair, or other objects:</b> Remove the obstructions.</li> <li>• <b>The subject's face occupies only a small area of the frame:</b> Change the composition so that the subject's face occupies a larger area of the frame (📖 33).</li> <li>• <b>The subject's head is tilted or horizontal:</b> Ask the subject to hold their head straight.</li> <li>• <b>The camera is tilted:</b> Keep the camera level (📖 20).</li> <li>• <b>The subject's face is poorly lit:</b> Shoot in bright light.</li> </ul>
Wrong subject is selected.	The selected subject is closer to the center of the frame than the main subject. Recompose the picture or turn face detection off and frame the picture using focus lock (📖 33).



Problem	Solution
The flash does not fire.	<ul style="list-style-type: none"> <li>• <b>The flash is not available in the current shooting mode:</b> Choose a different shooting mode (📖 24).</li> <li>• <b>The battery is exhausted:</b> Charge the battery or insert a fully-charged spare battery (📖 7).</li> <li>• <b>The camera is in continuous mode:</b> Select <b>OFF</b> for  <b>CONTINUOUS</b> (📖 68).</li> <li>• <b>The camera is in silent mode:</b> Turn silent mode off (📖 81).</li> <li>• <b>The flash is off (🔇):</b> Choose a different flash mode (📖 37).</li> </ul>
Some flash modes are not available.	<ul style="list-style-type: none"> <li>• <b>The desired flash mode is not available in the current shooting mode:</b> Choose a different shooting mode (📖 24).</li> <li>• <b>The camera is in silent mode:</b> Turn silent mode off (📖 81).</li> </ul>
The flash does not fully light the subject.	<ul style="list-style-type: none"> <li>• <b>The subject is not in range of the flash:</b> Position the subject in range of the flash (📖 109).</li> <li>• <b>The flash window is obstructed:</b> Hold the camera correctly (📖 20).</li> </ul>
Pictures are blurred.	<ul style="list-style-type: none"> <li>• <b>The protective glass covering the lens is dirty:</b> Clean the glass (📖 92).</li> <li>• <b>The protective glass covering the lens is blocked:</b> Keep objects away from the lens (📖 20).</li> <li>• <b>!AF is displayed during shooting and the focus frame is displayed in red:</b> Check focus before shooting (📖 99).</li> <li>•  <b>is displayed during shooting:</b> Use the flash or a tripod (📖 38).</li> </ul>
Pictures are mottled.	This is normal when slow shutter speeds are selected at high temperatures and does not indicate a malfunction.
Vertical lines appear in pictures.	The camera has been used continuously at high temperatures. Turn the camera off and wait for it to cool down.

Problem	Solution
"Smear" in the form of vertical purple or white lines appears in the display.	Vertical purple or white lines may appear after the camera has been used continuously at high temperatures or when a very bright object is in the frame; this phenomenon is common to all CCD image sensors and does not indicate a malfunction. These lines are recorded in movies but do not appear in photographs. Avoid framing bright objects when filming movies.
Sounds made by the camera are recorded with movies.	Do not adjust zoom during shooting.

## Playback





Problem	Solution
Pictures are grainy.	The pictures were taken with a different make or model of camera.
Playback zoom is unavailable.	The current picture is a resized copy with a size of <b>640</b> .
No sound in movie playback.	<ul style="list-style-type: none"> <li>• <b>Playback volume is too low:</b> Adjust playback volume (📖 85).</li> <li>• <b>The microphone was obstructed:</b> Hold the camera correctly during recording (📖 20, 48).</li> <li>• <b>The speaker is obstructed:</b> Hold the camera correctly during playback (📖 50).</li> </ul>
Selected pictures are not deleted.	Some of the pictures selected for deletion are protected. Remove protection using the device with which it was originally applied (📖 75).
File numbering is unexpectedly reset.	The battery-chamber cover was opened while the camera was on. Turn the camera off before opening the battery-chamber cover (📖 16).



## Connections/Miscellaneous













Problem	Solution
No picture or sound.	<ul style="list-style-type: none"> <li>• <b>The camera is not properly connected:</b> Connect the camera properly (📖 51).</li> <li>• <b>An A/V cable was connected during movie playback:</b> Connect the camera once movie playback has ended.</li> <li>• <b>Input on the television is set to “TV”:</b> Set input to “VIDEO”.</li> <li>• <b>The camera is not set to the correct video standard:</b> Match the camera  VIDEO SYSTEM setting to the TV (📖 88).</li> <li>• <b>The volume on the TV is too low:</b> Adjust the volume.</li> </ul>
No color	Match the camera  VIDEO SYSTEM setting to the TV (📖 88).
The computer does not recognize the camera.	Be sure the camera and computer are correctly connected (📖 60).
Pictures can not be printed.	<ul style="list-style-type: none"> <li>• <b>The camera is not properly connected:</b> Connect the camera correctly (📖 52).</li> <li>• <b>The printer is off:</b> Turn the printer on.</li> </ul>
Only one copy is printed/ the date is not printed.	The printer is not PictBridge compatible.
The camera is unre- sponsive.	<ul style="list-style-type: none"> <li>• <b>Temporary camera malfunction:</b> Remove and reinsert the battery (📖 9).</li> <li>• <b>The battery is exhausted:</b> Charge the battery (📖 7) or insert a fully-charged spare battery (📖 9).</li> </ul>
The camera does not function as expected.	Remove and reinsert the battery (📖 9). If the problem persists, contact your FUJIFILM dealer.
No sound.	Turn silent mode off (📖 81).





## Warning Messages and Displays

The following warnings are displayed in the LCD monitor:

Warning	Description
 (red)	Low battery. Charge the battery (📖 7) or insert a fully-charged spare battery (📖 9).
 (blinks red)	Battery exhausted. Charge the battery (📖 7) or insert a fully-charged spare battery (📖 9).
	Slow shutter speed. Pictures may be blurred; use the flash or a tripod.
<b>!AF</b> (displayed in red with red focus frame)	The camera can not focus. Try one of the following solutions: <ul style="list-style-type: none"><li>• Use focus lock to focus on another subject at the same distance, then recompose the picture (📖 33).</li><li>• Use macro mode to focus when taking close-ups (📖 36).</li></ul>
<b>!AE</b> Aperture or shutter speed displayed in red	The subject is too bright or too dark and the picture will be over- or under-exposed. If the subject is dark, use the flash (📖 37).
<b>FOCUS ERROR</b> TURN OFF THE CAMERA AND TURN ON AGAIN	Camera malfunction. Turn the camera off and then on again, taking care not to touch the lens. If the message persists, contact a FUJIFILM dealer.
<b>CARD NOT INITIALIZED</b>	<ul style="list-style-type: none"><li>• <b>The memory card or internal memory is not formatted or the memory card was formatted in a computer or other device:</b> Format the memory card or internal memory using the  <b>FORMAT</b> option in the camera setup menu (📖 82).</li><li>• <b>The memory card contacts require cleaning:</b> Clean the contacts with a soft, dry cloth. If the message is repeated, format the card (📖 82). If the message persists, replace the card.</li><li>• <b>Camera malfunction:</b> Contact a FUJIFILM dealer.</li></ul>
<b>PROTECTED CARD</b>	The memory card is locked. Unlock the card (📖 11).
<b>BUSY</b>	The memory card is incorrectly formatted. Use the camera to format the card (📖 82).

Warning	Description
CARD ERROR	The memory card is not formatted for use in the camera. Format the card (📖 82).
	The memory card contacts require cleaning or the memory card is damaged. Clean the contacts with a soft, dry cloth. If the message is repeated, format the card (📖 82). If the message persists, replace the card.
	Incompatible memory card. Use a compatible card (📖 14).
	Camera malfunction. Contact a FUJIFILM dealer.
 MEMORY FULL	The memory card or internal memory is full and pictures can not be recorded or copied. Delete pictures or insert a memory card with more free space.
 MEMORY FULL	
INTERNAL MEMORY IS FULL	
INSERT A NEW CARD	
WRITE ERROR	<ul style="list-style-type: none"> <li>• <b>Memory card error or connection error:</b> Reinsert the card or turn the camera off and then on again. If the message persists, contact a FUJIFILM dealer.</li> <li>• <b>Not enough memory remaining to record additional pictures:</b> Delete pictures or insert a memory card with more free space.</li> <li>• <b>The memory card or internal memory is not formatted:</b> Format the memory card or internal memory (📖 82).</li> </ul>
READ ERROR	<ul style="list-style-type: none"> <li>• <b>The file is corrupt or was not created with the camera:</b> The file can not be viewed.</li> <li>• <b>The memory card contacts require cleaning:</b> Clean the contacts with a soft, dry cloth. If the message is repeated, format the card (📖 82). If the message persists, replace the card.</li> <li>• <b>Camera malfunction:</b> Contact a FUJIFILM dealer.</li> </ul>

Warning	Description
FRAME NO. FULL	The camera has run out of frame numbers (current frame number is 999-9999). Format the memory card and select <b>RENEW</b> for  <b>FRAME NO.</b> in the setup menu. Take a picture to reset frame numbering to 100-0001, then select <b>CONTINUOUS</b> for  <b>FRAME NO</b> (  84).
PRESS AND HOLD THE DISP BUTTON TO DEACTIVATE SILENT MODE	An attempt was made to choose a flash mode or adjust the volume with the camera in silent mode. Exit silent mode before choosing a flash mode or adjusting the volume (  81).
TOO MANY FRAMES	A search has returned more than 5,000 results, or more than 999 frames were selected for deletion. Perform a different search or select fewer pictures.
PROTECTED FRAME	An attempt was made to delete a protected picture. Remove protection and try again (  75).
 CAN NOT CROP	 pictures can not be cropped.
CAN NOT CROP	The picture is damaged or was not created with the camera.
 CANNOT EXECUTE	
 CANNOT EXECUTE	An attempt was made to create a resized copy at a size equal to or larger than the original.
 CANNOT EXECUTE	Choose a smaller size.
CAN NOT ROTATE	An attempt was made to rotate a picture that can not be rotated.
 CAN NOT ROTATE	Movies can not be rotated.
CANNOT EXECUTE	Retouch and red-eye removal are not available with movies, pictures taken with other cameras,
 CANNOT EXECUTE	or pictures that can not be played back.

Warning	Description
NO CARD	No memory card inserted when  COPY is selected in the playback menu. Insert a memory card.
 NO IMAGE  NO IMAGE	The source selected for  COPY contains no images. Select a different source.
DPOF FILE ERROR	The DPOF print order on the current memory card contains more than 999 images. Copy the pictures to internal memory and create a new print order.
CAN NOT SET DPOF	The picture can not be printed using DPOF.
 CAN NOT SET DPOF	Movies can not be printed using DPOF.
COMMUNICATION ERROR	A connection error occurred while pictures were being printed or copied to a computer or other device. Confirm that the device is turned on and that the USB cable is connected.
PRINTER ERROR	Printer out of paper or ink, or other printer error. Check printer (see printer manual for details). To resume printing, turn the printer off and then turn it back on.
PRINTER ERROR RESUME?	Printer out of paper or ink, or other printer error. Check printer (see printer manual for details). If printing does not resume automatically, press <b>MENU/OK</b> to resume.
CANNOT BE PRINTED	An attempt was made to print a movie, a picture not created with the camera, or a picture in a format not supported by the printer. Movies and some pictures created with other devices can not be printed; if the picture is a still picture created with the camera, check the printer manual to confirm that the printer supports the JFIF-JPEG or Exif-JPEG format. If it does not, the pictures can not be printed.



# Appendix

## Tips and Tricks

The following tips and tricks will help you get the most from your camera.



### Battery Performance

Choose the following settings for improved battery performance:

- **FACE DETECTION** (📖 68): **OFF**
- **AF MODE** (📖 69): **CENTER**
- **LED ILLUMINATOR** (📖 69): **OFF**
- **LOCATION SEARCH** (📖 83): **OFF**
- **TRACKING DATA** (📖 83): **OFF**
- **LCD MODE** (📖 86): **POWER SAVE ON**
- **DUAL IS MODE** (📖 86): **OFF**



### The Self-timer

- **To prevent blur** caused by the camera moving when the shutter button is pressed, use the two-second timer.
- **To take a group portrait that includes the photographer**, use the group timer. The timer will not start until the person who has pressed the shutter button appears in the frame.





## Intelligent Face Detection

When **ON** is selected for  **FACE DETECTION** (📖 68), you can:

### Shooting

- **Zoom in on faces** when **ZOOM (CONTINUOUS)** is selected for  **IMAGE DISP.** (📖 84).







### Playback

- **Remove red-eye** by selecting **ON** for  **RED EYE REMOVAL** (📖 86).
- **Zoom in on faces** during slide shows (📖 74) or by pressing the selector down during playback.
- **Search for faces** using  **IMAGE SEARCH** (📖 44).
- **Crop** the background from portraits using  **CROP** (📖 76).

### Printing

- **Print** one copy for each person in the photo.

 **Pro Tips**

- To photograph the same scene both with and without the flash, select  **NATURAL** &  for  **SHOOTING MODE** (📖 24). Use multi-frame playback (📖 42) to compare the two shots.
- To photograph subjects that are in motion, select  **TRACKING** for  **AF MODE** (📖 69).
- To photograph poorly-lit subjects close to the camera, select **ON** for  **LED ILLUMINATOR** (📖 69).
- To fine-tune brightness of a photograph, select **P PROGRAM AE** (📖 24) for  **SHOOTING MODE**, choose an appropriate white balance option (📖 67), and adjust exposure compensation (📖 35).

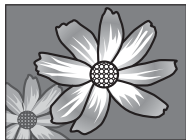
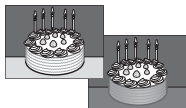

## Internal Memory/Memory Card Capacity

The following table shows the recording time or number of pictures available at different image sizes. All figures are approximate; file size varies with the scene recorded, producing wide variations in the number of files that can be stored. The number of exposures or length remaining may not diminish at an even rate. A limited number of test pictures can be taken when no memory card is inserted.

Medium ☐		Internal memory (approx. 10 MB)		2 GB		4 GB		8 GB	
		FINE	NORMAL	FINE	NORMAL	FINE	NORMAL	FINE	NORMAL
Photographs	<b>L</b> 4:3	1	2	320	550	640	1100	1290	2210
	<b>L</b> 16:9	2	3	410	780	830	1570	1680	3160
	<b>M</b> 4:3	3	5	630	1100	1260	2200	2540	4420
	<b>M</b> 16:9	3	7	820	1540	1640	3090	3290	6200
	<b>S</b> 4:3	6	11	1420	2350	2860	4710	5740	9450
	<b>S</b> 16:9	9	13	2070	2830	4150	5680	8330	11400
Movies*	<b>HD</b> 1280 <sup>†</sup>	1 sec.		11 min.		24 min.		48 min.	
	<b>640</b>	6 sec.		28 min.		58 min.		116 min.	



\* Individual movie files can not exceed 2 GB in size.

† Use a CLASS 4 card or better when shooting HD movies.

# Specifications

System	
<b>Model</b>	Digital Camera FinePix XP30 Series
<b>Effective pixels</b>	14.2 million
<b>CCD</b>	½ <sub>23</sub> -in. square pixel CCD with primary color filter
<b>Storage media</b>	• Internal memory (approx. 10 MB) • SD/SDHC/SDXC memory cards
<b>File system</b>	Compliant with Design Rule for Camera File System (DCF), Exif 2.3, and Digital Print Order Format (DPOF)
<b>File format</b>	• <b>Still pictures:</b> Exif 2.3 JPEG (compressed) • <b>Movies:</b> AVI-format Motion JPEG
<b>Image size (pixels)</b>	• <b>L 4:3:</b> 4,320 × 3,240 • <b>L 16:9:</b> 4,320 × 2,432 • <b>M 4:3:</b> 3,072 × 2,304 • <b>M 16:9:</b> 3,072 × 1,728 • <b>S 4:3:</b> 2,048 × 1,536 • <b>S 16:9:</b> 1,920 × 1,080
<b>Lens</b>	Fujinon 5 × optical zoom lens, F3.9 (wide angle) – F4.9 (telephoto)
<b>Focal length</b>	f=5.0 mm–25.0 mm (35-mm format equivalent: 28 mm–140 mm)
<b>Digital zoom</b>	• <b>4:3:</b> Approx. 6.8 × (up to 34 × when combined with optical zoom) • <b>16:9:</b> Approx. 5.1 × (up to 25 × when combined with optical zoom)
<b>Aperture</b>	F3.9/F6.2 (wide angle), F4.9/F8.0 (telephoto)
<b>Focus range</b> (distance from front of lens)	Approx. 60 cm (2.0 ft.)–infinity (wide angle); 1.0 m (3.3 ft.)–infinity (telephoto) • <b>Macro:</b> approx. 9 cm–80 cm/3.5 in.–2.6 ft. (wide angle); 40 cm–80 cm/1.3 ft.–2.6 ft. (telephoto)

System	
<b>Sensitivity</b>	Standard output sensitivity equivalent to ISO 100, 200, 400, 800, 1600, 3200; AUTO
<b>Metering</b>	256-segment through-the-lens (TTL)
<b>Exposure control</b>	Programmed AE
<b>Exposure compensation</b>	-2 EV – +2 EV in increments of 1/3 EV
<b>Image stabilization</b>	Optical stabilization
<b>Shutter speed</b> (combined mechanical and electronic shutter)	<ul style="list-style-type: none"><li>• <b>AUTO mode:</b> 1/4 s–1/2,000 s</li><li>• <b>Other modes:</b> 4 s–1/2,000 s</li></ul>
<b>Continuous</b>	Up to 0.8 fps, max. 3 frames
<b>Focus</b>	<ul style="list-style-type: none"><li>• <b>Mode:</b> Single AF</li><li>• <b>Focus-area selection:</b> CENTER, TRACKING</li><li>• <b>Autofocus system:</b> Contrast-detect TTL AF</li></ul>
<b>White balance</b>	Automatic scene detection; six manual preset modes for direct sunlight, shade, daylight fluorescent, warm white fluorescent, cool white fluorescent, and incandescent

System	
<b>Self-timer</b>	Off, 2 sec., 10 sec.,  (COUPLE TIMER),  (GROUP TIMER)
<b>Flash</b>	Auto flash; effective range when sensitivity is set to <b>AUTO</b> is approx. 70 cm–3.1 m/2.3 ft.–10.2 ft. (wide angle), 70 cm–2.7 m/2.3 ft.–8.9 ft. (telephoto); effective range in macro mode is approx. 30 cm–80 cm/1.0 ft.–2.6 ft.
<b>Flash mode</b>	Auto, fill flash, off, slow sync (red-eye removal off); auto with red-eye removal, fill flash with red-eye removal, off, slow sync with red-eye removal (red-eye removal on)
<b>LCD monitor</b>	2.7-in., 230 k-dot color LCD monitor; frame coverage approx. 96 %
<b>Movies</b>	Frame size <b>HD 1280</b> (1,280 × 720) or <b>640</b> (640 × 480); 30 fps; monaural sound
<b>Languages</b>	Arabic, Bulgarian, Simplified Chinese, Traditional Chinese, Czech, Danish, Dutch, English, Farsi, Finnish, French, German, Greek, Hebrew, Hungarian, Indonesian, Italian, Japanese, Kazakh, Korean, Latvian, Lithuanian, Norwegian, Polish, Portuguese, Romanian, Russian, Serbian, Slovak, Spanish, Swedish, Thai, Turkish, Ukrainian, Vietnamese
<b>Date map database was created</b>	October 2010
Input/output terminals	
<b>A/V OUT</b> (audio/video output)	NTSC or PAL output with monaural sound
<b>Digital input/output</b>	USB 2.0 High-Speed; shares A/V OUT connector, MTP/PTP

**Power supply/other****Power supply** NP-45A rechargeable battery**Battery life** (approximate number of frames that can be taken with a fully-charged battery)

Battery type	Approximate number of frames
NP-45A (type supplied with camera)	200

CIPA standard, measured in  (auto) mode using battery supplied with camera and SD memory card.

**Note:** Number of shots that can be taken with battery varies with battery charge level and will decline at low temperatures.

**Camera dimensions**  
(W × H × D) 99.2 mm × 67.7 mm × 23.1 mm/3.9 in. × 2.7 in. × 0.9 in., excluding projections

**Camera weight** Approx. 148 g/5.2 oz., excluding battery, accessories, and memory card

**Shooting weight** Approx. 165 g/5.8 oz., including battery and memory card

**Operating conditions**

- **Temperature:** -10 °C – +40 °C/+14 °F – +104 °F
- **Humidity:** 10% – 80% (no condensation)



**NP-45A rechargeable battery**

<b>Nominal voltage</b>	DC 3.7V
<b>Nominal capacity</b>	720 mAh
<b>Operating temperature</b>	0 °C – +40 °C/+32 °F – +104 °F
<b>Dimensions (W × H × D)</b>	31.0 mm × 39.6 mm × 6.0 mm/1.2 in. × 1.6 in. × 0.2 in.
<b>Weight</b>	Approx. 15.5 g/0.5 oz.

**BC-45B battery charger**

<b>Rated input</b>	100V–240 V AC, 50/60 Hz
<b>Input capacity</b>	6.0 V (100 V/240 VA)
<b>Rated output</b>	4.2 V DC, 550 mA
<b>Supported batteries</b>	NP-45A rechargeable batteries
<b>Charging time</b>	Approx. 120 minutes (+20 °C/+68 °F)
<b>Operating temperature</b>	0 °C – +40 °C/+32 °F – +104 °F
<b>Dimensions (W × H × D)</b>	46 mm × 91 mm × 23 mm/1.8 in. × 3.6 in. × 0.9 in., excluding projections
<b>Weight</b>	Approx. 65 g/2.3 oz., excluding battery

Weight and dimensions vary with the country or region of sale.

### ■ Notices

- Specifications subject to change without notice. FUJIFILM shall not be held liable for damages resulting from errors in this manual.
- Although the LCD monitor is manufactured using advanced high-precision technology, small bright points and anomalous colors may appear, particularly in the vicinity of text. This is normal for this type of LCD monitor and does not indicate a malfunction; images recorded with the camera are unaffected.
- Digital cameras may malfunction when exposed to strong radio interference (e.g., electric fields, static electricity, or line noise).
- Due to the type of lens used, some distortion may occur at the periphery of images. This is normal.



# FUJIFILM

---

**FUJIFILM Corporation**

7-3, AKASAKA 9-CHOME, MINATO-KU, TOKYO 107-0052, JAPAN

[http://www.fujifilm.com/products/digital\\_cameras/index.html](http://www.fujifilm.com/products/digital_cameras/index.html)



# Restrictions on Camera Settings

Option		Shooting Mode																				
		SR AUTO	📷	P	🔍	🚫	🗣️	🔄	📐	📄	🏃	🌙	🌡️	📷	📷	📷	📷	📷	📷	📷	TEXT	👤
📷	STOP	✓	✓	✓	✓	✓	✓	✓	✓	✓	✓	✓	✓	✓	✓	✓	✓	✓	✓	✓	✓	
	CF		✓	✓	✓	✓																
	BF	✓	✓	✓	✓	✓	✓	✓	✓	✓	✓	✓	✓	✓	✓	✓	✓	✓	✓	✓	✓	✓
	📷	✓	✓	✓	✓	✓	✓	✓	✓	✓	✓	✓	✓	✓	✓	✓	✓	✓	✓	✓	✓	✓
WB			✓						✓													
📷	ON	✓	✓	✓		✓	✓	✓	✓		✓	✓	✓	✓	✓	✓	✓	✓	✓	✓	✓	✓
	OFF	✓	✓	✓		✓	✓	✓	✓		✓	✓	✓	✓	✓	✓	✓	✓	✓	✓	✓	✓
📷	ON	✓	✓	✓	✓	✓	✓	✓			✓	✓	✓	✓	✓					✓		
	OFF	✓ <sup>1</sup>	✓	✓	✓	✓	✓	✓	✓ <sup>1</sup>	✓ <sup>1</sup>	✓ <sup>1</sup>	✓	✓	✓	✓	✓	✓ <sup>1</sup>	✓ <sup>1</sup>	✓ <sup>1</sup>	✓	✓ <sup>1</sup>	✓ <sup>1</sup>
📷	📷		✓	✓	✓ <sup>1</sup>	✓ <sup>1</sup>	✓ <sup>1</sup>	✓ <sup>1</sup>	✓ <sup>1</sup>	✓ <sup>1</sup>	✓ <sup>1</sup>	✓ <sup>1</sup>	✓ <sup>1</sup>	✓ <sup>1</sup>	✓ <sup>1</sup>	✓ <sup>1</sup>	✓ <sup>1</sup>	✓ <sup>1</sup>	✓ <sup>1</sup>	✓ <sup>1</sup>	✓ <sup>1</sup>	✓ <sup>1</sup>
	📷		✓	✓																		
📷	HD 1280																					✓
	640																					✓
📷		✓	✓	✓	✓	✓	✓	✓	✓	✓	✓	✓	✓	✓	✓	✓	✓	✓	✓	✓	✓	✓
📷	👤1	✓	✓	✓	✓	✓	✓	✓	✓	✓	✓	✓	✓	✓	✓	✓	✓	✓	✓	✓	✓	✓
	👤2	✓	✓	✓	✓	✓	✓	✓	✓	✓	✓	✓	✓	✓	✓	✓	✓	✓	✓	✓	✓	✓
	OFF	✓	✓	✓	✓	✓	✓	✓	✓	✓	✓	✓	✓	✓	✓	✓	✓	✓	✓	✓	✓	✓
📷		✓ <sup>2</sup>	✓	✓	✓	✓	✓	✓		✓	✓	✓	✓	✓	✓	✓	✓	✓	✓	✓	✓	
📷		✓	✓	✓	✓	✓	✓	✓	✓	✓	✓	✓	✓	✓	✓	✓	✓	✓	✓	✓	✓	✓
📷		✓	✓	✓	✓		✓				✓	✓	✓	✓	✓	✓	✓	✓	✓			
📷		✓	✓	✓	✓	✓	✓	✓	✓	✓	✓	✓	✓	✓	✓	✓	✓	✓	✓	✓	✓	✓
📷		✓	✓	✓	✓	✓	✓	✓	✓	✓	✓	✓	✓	✓	✓	✓	✓	✓	✓	✓	✓	✓

1 Automatically optimized for selected shooting mode.

2 OFF only.