

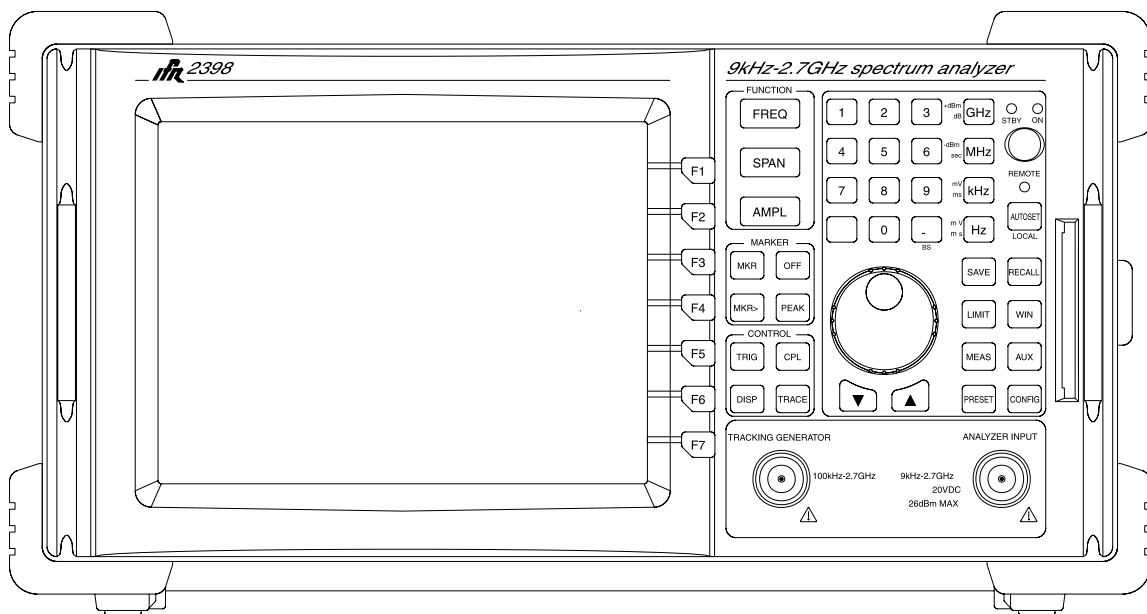

Spectrum Analyzer

2398



Operation Manual

2398
Spectrum Analyzer
Operation Manual

Vol.1

**Read this manual before using the equipment.
Keep this manual with the equipment.**

 **IFR Americas, Inc.**

Safety Symbols

Where these symbols or indications appear on the instrument or in this manual, they have the following meanings.



WARNING. *Risk of hazard which may cause injury to human body or danger to life. If a WARNING appears on the instrument, and in this manual, do not proceed until its suitable conditions are understood and met.*

CAUTION. *Risk of hazard which caused fire or serious damage to the instrument or other equipment. Do not proceed until its suitable conditions are met.*

GROUND. *Ground terminal to chassis(earth).*

For Safety

.....

WARNING 

.....



1. **ALWAYS** refer to the operation manual when working near locations at which the alert mark shown on the left is attached. If the operation, etc., is performed without heeding the advice in the operation manual, there is a risk of personal injury. In addition, the equipment performance may be reduced. Moreover, this alert mark is sometimes used with other marks and descriptions indicating other dangers.

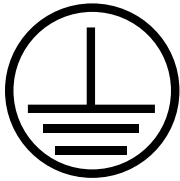

2. When supplying power to this equipment, connect the accessory 3- pin power cord to a 3- pin grounded power outlet. If a grounded 3- pin outlet is not available, use a conversion adapter and ground the green wire, or connect the frame ground on the rear panel of the equipment to ground. If power is supplied without grounding the equipment, there is a risk of receiving a severe or fatal electric shock and equipment damage.

Repair



3. This equipment cannot be repaired by the user. **DO NOT** attempt to open the cabinet or to disassemble internal parts. Only IFR trained service personnel or staff from your sales representative with a knowledge of electrical fire and shock hazards should service this equipment. There are high- voltage parts in this equipment presenting a risk of severe injury or fatal electric shock to untrained personnel. In addition, there is a risk of damage to precision parts.

Falling Over

4. This equipment should be used in the correct position, If the cabinet is turned on its side, etc., it will be unstable and may be damaged if it falls over as a result of receiving a slight mechanical shock.
-

For Safety

CAUTION 

Changing Fuse

CAUTION 

1. Before changing the fuses, ALWAYS remove the power cord from the power- outlet and replace the blown fuses. ALWAYS use new fuses of the type and rating specified on the fuse marking on the rear panel cabinet.

T3.15A indicates a time- lag fuse.

There is risk of receiving a fatal electric shock if the fuses are replaced with the power cord connected.

Cleaning

2. Keep the power supply and cooling fan free of dust.
 - Clean the power inlet regularly. If dust accumulates around the power pins, there is a risk of fire.
 - Keep the cooling fan clean so that the ventilation holes are not obstructed. If the ventilation is obstructed, the cabinet may overheat and catch fire.

Check Terminal



3.
 - Maximum DC voltage ratings :
RF Input 20VDC
TG Output 0VDC
 - Maximum AC power ratings :
RF Input +26dBm
 - NEVER input a signal power $>+26\text{dBm}$ or $>\pm 20\text{VDC}$ the to RF Input connector.
 - Excessive power may damage the internal circuits.

For Safety

CAUTION 



Replacing Memory
Back-Up Battery

4. The power for memory back- up is supplied by a **Primary Lithium Battery**. This battery should only be replaced by a battery of the same type(SANYO;CR12600SE- FT3); since replacement can only be made by IFR, contact the nearest IFR representative when replacement is required.

Note : The battery life is about 7years. Early battery replacement is recommended.

CAUTION 

Do not throw the battery away but dispose of it according to your country's requirements.

Storage
Medium

5. This equipment stores data and programs using PCMCIA Type I Memory Card.

Data and programs may be lost due to improper use or failure. IFR therefore recommends that you back- up the memory.

IFR CANNOT COMPENSATE FOR ANY MEMORY LOSS.

Please pay careful attention to the following points.

- Do not remove the memory card from equipment being accessed.
- Isolate the card from static electricity.
- The back- up battery in the SRAM memory card has a limited life; replace the battery periodically.

For Safety

CAUTION 

6. **Use Proper Power Source** : Do not operate this product from a power source that applies more than the voltage specified.

Product Damage
Precaution

Provide Proper Ventilation : To prevent product overheating, provide proper ventilation.

Do Not Operate With Suspected Failures : If you suspect there is damage to this product, have it inspected by qualified service personnel.

Do Not Attempt To Operate If Protection May Be Impaired : If the instrument appears damaged or operates abnormally, protection may be impaired. Do not attempt to operate the instrument under these conditions. Refer all questions of proper instrument operation to qualified service personnel.

7. **Object and Liquid Entry** : Never push objects of any kind into instrument through openings as they may touch dangerous voltage points or short out parts that could result in a fire or electric shock. Never spill liquid of any kind on the instrument . Do not use this instrument near water- for example, near a bath tub wash bowl, kitchen sink, or laundry tub, in a wet basement, or near a swimming pool, and the like. Keep the instrument away from damp air, water and dust. Unexpected trouble may be caused when the instrument is placed in a damp or dusty place.

Place-related
Warning



Flammable and Explosive Substance : Avoid using this instrument where there are gases, and where there are flammable and explosive substances in the immediate vicinity.

Unstable Location : Do not place this instrument on an unstable cart, stand, tripod, bracket, or table. The instrument may fall, causing serious injury to a person, and serious damage to the instrument. Do not place or use the instrument in a place subject to vibration.

IFR Warranty

IFR will repair this equipment free of charge if a malfunction occurs within 1 year after shipment due to a manufacturing fault, provided that this warranty is rendered void under any or all of the following conditions.

- **The fault is outside the scope of the warranty conditions described in the operation manual.**
- **The fault is due to misoperation, misuse, or unauthorized modification or repair of the equipment the customer.**
- **The fault is due to severe usage clearly exceeding normal usage.**
- **The fault is due to improper or insufficient maintenance by the customer.**
- **The fault is due to natural disaster including fire, flooding and earthquake, etc.**
- **The fault is due to use of non specified peripheral equipment, peripheral parts, consumables. etc.**
- **The fault is due to use of non specified power supply or in a non- specified installation location.**

In addition, this warranty is valid only for the original equipment purchaser. It is not transferable if the equipment is resold.

IFR will not accept liability for equipment faults due to unforeseen and unusual circumstances, nor for faults due to mishandling by the customer.

IFR Contact

If this equipment develops a fault, contact office of IFR at the address in the operation manual, or your nearest sales or service office.

Front Panel Power Switch

If the equipment is in the standby state, the front power switch of this equipment turns on the power when it is pressed.

If the switch is pressed continuously for one second in the power on state, the equipment enters the standby state to prevent malfunction caused by accidental touching.

In the power on state, if the power plug is removed from the outlet, then reinserted, the power will not be turned on. Also, if the line is disconnected due to momentary power supply interruption or power failure, the power will not be turned on even when power is restored.

This is because this equipment enters the standby state and prevents incorrect data from being acquired when the line has to be disconnected and reconnected.

For example, if the sweep time is 1,000 seconds and data acquisition requires a long time, momentary power supply interruption(power failure)might occur during measurement and the line could be recovered automatically to power on. In such a case, the equipment may mistake incorrect data for correct data without recognizing the momentary power supply interruption.

If this equipment enters the standby state due to momentary power supply interruption or power failure, check the state of the measuring system and press the front power switch to restore power to this equipment.

Further, if this equipment is built into a system and the system power has to be disconnected then reconnected, the power for this equipment must also be restored by pressing the front power switch.

DETECTION MODE

This instrument is a spectrum analyzer which uses a digital storage system. The spectrum analyzer makes level measurements in frequency steps obtained by dividing the frequency span by the number of measurement data points(500). Because of this operation it is desired to use the following detector modes associated with the appropriate measurements.

Measurement	Detector mode
○ Normal signal	POS PEAK
○ Random noise	SAMPLE OR AVERAGE
○ Pulsed noise	NORMAL
○ Occupied frequency bandwidth	SAMPLE
(for analog communication systems)	
○ Occupied frequency bandwidth	POS PEAK or SAMPLE
(for digital communication systems)	

When a detection mode is specified as one of the measurement methods, make the measurement in the specified detection mode.

ABOUT THIS MANUAL

(1) Composition of 2398 Manuals

The 2398 Spectrum Analyzer manuals of the standard type are composed of the following two documents.

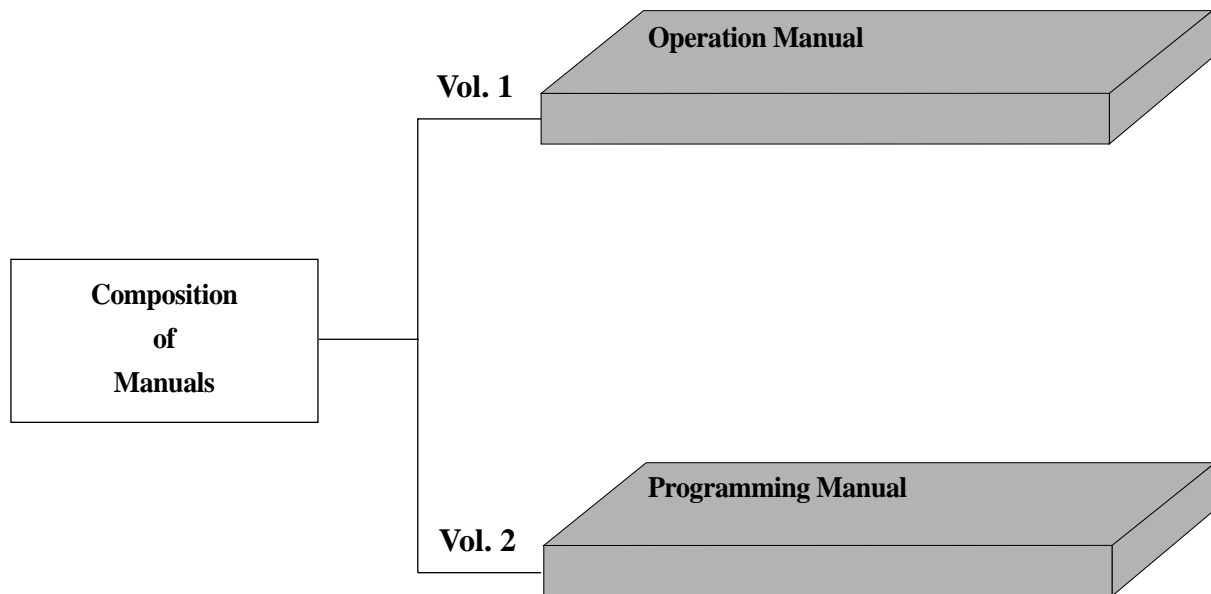

Operation Manual : Provides information on the 2398 outline, preparation before use, panel description, operation procedure, soft- key menu and performance tests.

Programming Manual : Provides information on RS- 232C remote control, GPIB remote control and sample programs.

TABLE OF CONTENTS

For Safety	2
ABOUT THIS MANUAL	11
SECTION 1 GENERAL	1-1
Composition of Manual	1- 3
Product Outline	1- 4
2398 Standard Configurations	1- 5
Specifications	1- 6
SECTION 2 PREPARATIONS BEFORE USE	2-1
Installation Site Environment Conditions	2- 3
Locations to be avoided	2- 3
Fan clearance	2- 3
Safety Measures	2- 4
Power on	2- 4
Input level to RF Input	2- 5
Preparations before Power- on	2-6
Protective grounding	2- 7
Replacing fuse	2- 8
Precaution for Handling Memory Card(option)	2-10
AC/DC power and rechargeable battery pack(option)	2-11
Replacement of fuse for DC power(option)	2-12
How to contact DC Battery pack(option)	2-13
SECTION 3 PANEL DESCRIPTION	3-1
Product Specification	3- 3
Table of I/O Connectors	3- 5
IEEE- 488 GPIB Connector	3- 6
RS- 232C Connector	3- 7
Printer Connector	3- 8
DC Input Connector	3- 9
SECTION 4 SOFT-KEY MENU	4-1
Menu Tree	4- 3

FREQ,SPAN,AMPL	4- 4
MKR, OFF, MKR>, PEAK	4- 5
TRACE, CPL	4- 6
TRIG, DISP	4- 7
SAVE, RECALL	4- 8
CONFIG	4- 9
MEAS	4- 10
AUX, LIMIT, WIN, AUTOSET	4- 11
PRESET	4- 12
SECTION 5 OPERATING PROCEDURES	5-1
FREQ/SPAN FUNCTIONS	5- 3
Center - Span Data Entry	5- 4
Start - Stop Freq. Data Entry	5- 6
Setting CF Step Size	5- 8
Setting Full Span	5- 9
Setting Zero Span	5- 10
Return to the Previous Span	5- 10
Zoom In/Zoom Out	5- 11
AMPLITUDE FUNCTIONS	5- 12
Selecting Log/Linear Detector Mode	5- 12
Setting Amplitude Units	5- 12
Setting Reference Level	5- 13
Setting Amplitude Scale	5- 13
Reference Level Offset	5- 13
Setting Input Attenuation	5- 14
MARK FUNCTIONS	5- 15
Changing Marker Position	5- 15
Normal Marker	5- 16
Delta Marker	5- 17
Marker Off	5- 17
PEAK SEARCH FUNCTIONS	5- 18
Peak Search	5- 18
Next Peak Search	5- 19
Peak Left Search/Peak Right Search	5- 20
Marker Track	5- 20
Marker Noise	5- 21
SETTING PARAMETERS USING MARKER VALUES	5- 22
Setting Parameters Using Marker Values	5- 22
MKR- >CF STEP/MKR DELTA- >CF STEP	5- 22
ΔMKR- >SPAN	5- 22

MKR ZOOM IN/ZOOM OUT	5- 23
AUTOSET	5- 24
TRACE FUNCTIONS	5- 25
Select Trace	5- 26
CLR & WRT A[B]	5- 26
MAX HOLD A[B]	5- 26
VIEW A[B]	5- 26
BLANK A[B]	5- 26
Computation	5- 27
Detection Mode	5- 28
Averaging Function	5- 30
DISPLAY FUNCTIONS	5- 31
Display Line	5- 31
Threshold Line	5- 32
Screen Title	5- 33
Contrast	5- 33
GRAT [ON/OFF]	5- 34
ANNOT [ON/OFF]	5- 34
INVERSE [ON/OFF]	5- 34
TRIGGER FUNCTIONS	5- 35
Continuous Sweep Mode	5- 35
Single Sweep Mode	5- 35
Triggered Mode	5- 36
Trigger Source	5- 36
Trigger Filter	5- 36
Trigger Level	5- 36
Line Trigger	5- 37
External Trigger	5- 37
Trigger Delay	5- 37
COUPLED FUNCTIONS	5- 38
All Auto Function	5- 38
RBW and Sweep Time	5- 39
Video Bandwidth(VBW)	5- 40
Input Attenuator	5- 41
CONFIGURATIONS	5- 42
Hard Copy	5- 42
Print Type	5- 42
RS- 232C Configuration	5- 43

GPIB Address	5- 43
Clock Set	5- 43
10M REF [INT/EXT]	5- 44
BEEP [ON/OFF]	5- 44
Version Information	5- 44
PCMCIA MEMORY CARD FUNCTION (option)	5- 45
SAVE AND RECALL FUNCTIONS	5- 46
Internal Register	5- 46
Save Parameters and Waveform	5- 47
Recall Parameters and Waveform	5- 48
MEASUREMENT FUNCTIONS	5- 50
X dB Down Measurement	5- 51
Occupied Power Bandwidth Measurement	5- 52
Marker Counter	5- 53
QP EMC Measurement (option)	5- 53
Channel Power	5- 54
Adjacent Channel Power	5- 55
DEMODULATION AND AUDIO FUNCTIONS	5- 56
AM Demodulation	5- 57
FM Demodulation	5- 57
Audio Monitor	5- 57
TRACKING GENERATOR(option)	5- 58
LIMIT LINE FUNCTIONS	5- 59
WINDOW FUNCTIONS	5- 61
PRESET FUNCTIONS	5- 63
Preset	5- 63
Last State	5- 64
All Cal.	5- 64
Cal. Mode	5- 64
Cal. Signal	5- 64
Auto Cal. [ON/OFF]	5- 64
SECTION 6 PERFORMANCE TESTS	6-1
Requirement for Performance Tests	6- 3
Instruments Required for Performance Tests	6- 4
Performance Tests	6- 6
Reference oscillator frequency stability	6- 6
Center frequency readout accuracy	6- 8
Frequency span readout accuracy	6- 11
Resolution bandwidth(RBW)and selectivity, switching error	6- 14
Sideband noise	6- 20

Frequency measurement accuracy.....	6- 22
Amplitude display linearity	6- 24
Frequency response	6- 30
Reference level accuracy	6- 32
Average noise level	6- 35
Second harmonic distortion	6- 37
Input attenuator switching error	6- 39
Residual FM	6- 41
3rd Order Intermodulation	6- 43
Spurious Response	6- 46
Local Oscillator Emission	6- 48
Input VSWR	6- 50
SECTION 7 STORAGE AND TRANSPORTATION	7-1
Cleaning Cabinet	7- 3
Storage Precautions	7- 4
Precautions before storage.....	7- 4
Recommended storage precautions.....	7- 4
Repacking and Transportation	7- 5
Repacking	7- 5
Transportation	7- 5
Service	7- 6

<BLANK>

SECTION 1

GENERAL

This section outlines the 2398 Spectrum Analyzer and explains the composition of this manual, the configuration of the 2398 with the standard accessories, the options, the optional accessories, peripherals for expanding the 2398 capabilities, and the 2398 specifications.

TABLE OF CONTENTS

Composition of Operation Manual	1- 3
Product Outline	1- 4
2398 standard Configurations	1- 5
The 2398 may be special ordered	1- 5
With any of the following options	
Accessories for 2398	1- 5
Specifications	1- 6

<BLANK>

Composition of Operation Manual

This Manual is composed of 7 sections. The profile of each section is shown below.

Section composition	Explanation
SECTION 1 GENERAL	Product outline, standard configuration, options, applicable parts, peripheral devices, and specifications
SECTION 2 PREPARATIONS BEFORE USE	Operations to be accomplished before applying power
SECTION 3 PANEL DESCRIPTION	Description of the front and rear panels
SECTION 4 SOFT- KEY MENU	Description of the soft- key menu
SECTION 5 OPERATING PROCEDURES	Operation procedures for operation guide
SECTION 6 PERFORMANCE TESTS	Tests used for checking performance
SECTION 7 STORAGE AND TRANSPORTATION	Cautions on storage and transportation

SECTION 1 GENERAL

Product Outline

The 2398 (henceforth called “this unit”) is a portable type monochrome LCD spectrum analyzer suited for signal analysis of radio equipment where the efficiency of frequency usage is increased and equipment is increasingly speeded and digitized.

The 2398 adopts the synthesizer local system and can cover all frequencies from 9kHz to 2.7GHz Excellent in basic performance such as distortion, frequency/level accuracy, and easily operable, by following the display of the soft- key menu screen.

Excellent cost performance with rich options to cope with various applications.

Equipped with high accuracy calibration signals and an attenuator, it can accurately calibrate switching errors of LOG/LIN scales, resolution bandwidth, reference level, etc.

Since frequency response data is corrected by built in calibration data, allowing high-accuracy level measurement for a wide range.

As the switching of waveforms between frequency domain and time domain can be done by a touch and two waveforms are simultaneously displayed, signal analysis of both domains can be done efficiently.

This unit provides the MEASURE function which can perform measurement of various applications without requiring the intervention of external controllers. Therefore, the performance evaluation of radio equipment can be easily done in terms of frequency, noise, occupied frequency bandwidth, etc.

■ Application

This unit is useful for the production, building and maintenance of electronic equipment and devices for the following.

- AM/FM radio equipment
- Digital cellular telephone/cordless telephone
- Satellite broadcasting, CATV and TV equipment
- Small capacity microwave equipment

2398 Standard Configurations

2398	9kHz To 2.7 GHz SPECTRUM Analyzer
2398- 1	2398, w/0.1 PPM HSTB, QUASI- PEAK DETECT., FILTERS, IEEE- 488(GPIB),PCMCIA CARD SLOT
2398- 2	2398- 1 w/TRACKING GENERATOR
2398- 3	2398- 1 with AC- DC POWER SUPPLY
2398- 4	2398- 1 w/TRACKING GEN., AC/DC POWER SUPPLY

The 2398 may be special ordered with any of the following options

AC2565	Option 1 TRACKING GENERATOR
AC2566	Option 2 HIGH STABILITY TIME BASE(HSTB)
AC2567	Option 3 QUASI- PEAK DETECTOR
AC2568	Option 4 AC/DC POWER SUPPLY
AC2570	Option 5 PCMCIA CARD INTERFACE

Accessories for 2398

AC0100	Near Field Probe Set
AC2388	1 GHz Active Probe
AC2600	Maintenance Manual
AC2602	Connector and Cable Assembly Kit
AC2603	Battery Pack (must be used with AC/DC Power Supply)
AC4101T	Return Loss Bridge
AC4250	BNC to Type "N" Adapter (75 ohm to 50 ohm)
AC5008	DC Block
AC7800	Type "F" to type "N" Adapter (75 ohm to 50 ohm)
AC8700	UHF Antenna

Specifications

NOTE : A fifteen minute warm up time shall apply.

1.0 FREQUENCY

1.1 Frequency range	9.0 kHz to 2.7 GHz
1.2 Tuning Resolution	1 Hz Minimum
1.3 Frequency Span Width	100 Hz/div to 270 MHz/div in 1, 2, 5 step selections(auto selected) plus ZERO Span, and FULL SPAN (9kHz to 2.7GHz). Manual selection of start, stop, and span.
1.4 Span Accuracy	±3% of the indicated Span Width
1.5 Readout Accuracy	Span Accuracy + Frequency Standard Accuracy + 50% of RBW
1.6 Frequency Counter	
1.6.1 Resolution	1 kHz, 100 Hz, 10 Hz, 1 Hz(user selectable)
1.6.2 Accuracy	±(Reference frequency error × marker frequency accuracy + counter resolution +/- 1 count)
1.6.3 Sensitivity	≤ - 70 dBm (50 kHz to 2.7 GHz)
1.7 Stability	
1.7.1 Residual FM	<100 Hz _{p-p} in 200ms @1 kHz RBW, 1 kHz VBW, (P- P in 20 ms)
1.7.2 Noise Sidbands	- 90 dBc/Hz @10 kHz offset

2.0 AMPLITUDE

2.1 Measurement Range	+20 to - 105 dBm
2.2 Average Displayed Noise Level:	50 kHz to 100 kHz ≤ - 80dBm 100 kHz to 1 MHz ≤ - 100dBm 1 MHz to 2.7 GHz ≤ - 105dBm (300 Hz RBW, 10 Hz Video Filter)
2.3 1dB Compression Point	- 10 dBm 100 kHz to 2.7 GHz (0 dB attenuation)
2.4 Displayed Range	80 dB in 10 dB/div log scale. 40 dB in 5 dB/div log scale. 16 dB in 2 dB/div log scale. 8 dB in 1 dB/div log scale. 8 divisions with linear amplitude scale.
2.5 Amplitude Units	
2.5.1 Log Scale Mode	dBmV or dBm units.
2.5.2 Linear Scale Mode	V(uV,mV,etc.), or dBV(dBmV only)
2.5.2 Quasi Peak Enabled	dBuV, dBmV, or dBm only

2.6 Display Linearity	5 or 10 dB/div, ± 0.15 dB/dB, $\leq \pm 1.5$ dB over 8 divisions 1 or 2 dB/div, ± 0.5 dB over 8 divisions Linear, $\pm 10\%$ of Reference Level over 8 divisions
2.7 Frequency Response	- 3.0~+1 dB, 9 kHz to 10 MHz ± 1.5 dB, 10MHz to 2.7 GHz (10 dB RF attenuation)
2.8 Attenuator	0 to 50 dB, Selected manually or automatically coupled to reference level. 2.8.1 Range 2.8.2 Resolution 10 dB steps. 2.8.3 Accuracy 50 kHz to 2.7GHz, ± 0.5 dB/step up to 1dB maximum.
2.9 Reference Level	+/- 1.5 dB (50 kHz to 2.7GHz) 2.9.1 Accuracy 2.9.2 Range - 110 dBm to +30 dBm with 300Hz filter using 1 dB/div scale. 2.9.3 Resolution 0.1 dB step minimum
2.10 Residual Spurious	$\leq - 85$ dBm (input terminated, 0 dB attenuation)
2.11 Harmonic Distortion	$\leq - 60$ dBc, - 40 dBm input, 0 dB Input attenuation.
2.12 Intermodulation Distortion (3rd order) 0 dB attenuation	$\leq - 70$ dBc, 100 MHz to 2.7 GHz, - 30 dBm input $\leq - 60$ dBc, 1 MHz to 100 MHz, - 30 dBm input
2.13 Other Input Related Spurious	$\leq - 60$ dBc, 10 MHz to 2.7 GHz, - 30 dBm input
2.14 Resolution Bandwidth	2.14.1 Selections 300 Hz, 1 kHz, 3 kHz, 10 kHz, 30 kHz, 100 kHz, 300 kHz 1 MHz, and 3 MHz 2.14.2 Accuracy $\leq \pm 20\%$ 2.14.3 Selectivity 60dB/3dB ratio < 15:1 60dB/6dB ratio < 12:1; 9 kHz & 120 kHz (Quasi Peak Option)
2.14.4 Switching Error	± 1.0 dB (3 kHz Reference RBW)
2.15 Video Bandwidth Selection	10 Hz to 1 MHz in 1- 3- 10 steps plus None.

3.0 SWEEP

3.1 Rate	50 ms to 1000 sec in 1- 2- 5 sequence 5 ms to 20 sec (ZERO SPAN)
3.1.1 Sweep Rate Accuracy	20%, <100 msec 10%, for all other sweep rates
3.2 Trigger	
3.2.1 Source	External(rear), Line, Video
3.2.2 Mode	Freerun, Single
3.2.3 Coupling	DC
3.2.4 Bandwidth	Selectable : Flat, 5 Hz HPF, or 100kHz LPF (- 3dB Nominal, measured at External Input)
3.2.5 Ext Rear Level	TTL Level
3.2.6 Delay	+/- one sweep time

4.0 DISPLAY

4.1 Type	(7.4") Monochrome STN LCD
4.2 Digital Resolution	640 H X 480 V active display area
4.3 Marker Modes	Peak Search, Peak Track, Delta Marker, 1/Delta Marker Marker Track ; Marker to Center, Marker to Reference (2 markers maximum)

5.0 MEMORY

5.1 Trace Storage	20 stored traces including user defined traces and test limits
5.2 Setup Storage	10 operational states
5.3 Display Traces at One Time	2 Traces

6.0 INPUTS

6.1 RF Input	
6.1.1 Connector	Type N Female, 50 ohm nominal
6.1.2 VSWR	150 kHz to 2.7 GHz, VSWR<1.5:1. (with 10 dB Input attenuation)
6.1.3 Max. Input Level	20 Vdc, +26 dBm (with 30 dB Input attenuation)
6.1.4 LO Emission	≤- 70 dBm with 10 dB attenuation)

7.0 OUTPUTS

7.1 IF Output	10.7 MHz, Nominal
7.2 Video Output	0 to 5V DC

8.0 FREQUENCY STANDARD

	<u>STANDARD</u>	<u>HIGH STABILITY OPTION</u>
8.1 Temperature Stability	±2 ppm	±0.1 ppm
8.2 Aging	±1 ppm/year	±0.1 ppm/year

9.0 EXTERNAL REFERENCE**9.1 Connector**

Switchable between Internal/External

9.2 Input Level

BNC female connector

9.3 Output Level

- 5 dBm to +15 dBm

10 MHz @ +5 dBm nominal

10.0 IEEE- 488(GPIB) INTERFACE**10.1 Conforms to**

IEEE- Standard 488- 1987

10.2 Implemented Substes

SH1, AH1, T6, L4, SR1, RL1, PP0, DC1, C0, LE0, TEO

11.0 RS- 232C INTERFACE**11.1 Type**

Null Modem (Duplex Virtual Hardware Handshaking)

11.2 Baud Rate

600 bps, 1200 bps, 2400 bps, 4800 bps, 9600 bps, 19.2 kbps

11.3 Parity Check

Odd, Even or None.

11.4 Data Length

7 bits, 8 bits

11.5 Stop Bit

1 bit, 2 bit

12.0 PRINTER**12.1 Driver**

PCL3

12.2 Connection

Standard 25 pin female D- Sub Parallel Printer

13.0 QUASI PEAK DETECTOR (option)

SELECTED BANDWIDTH	RECOMMENDED FREQUENCY RANGE	CHARGE TIME (ms)	DISCHARGE TIME (ms)	DISPLAY TIME (ms)
9 kHz	150 kHz to 30 MHz	1 ± 20%	160 ± 20%	160 ± 20%
120 kHz	30 MHz to 1GHz	1 ± 20%	550 ± 20%	100 ± 20%

14.0 GENERAL CHARACTERISTICS**14.1 Dimensions**

13.75"(350 mm) wide (including handle)

7.15"(185mm) high

14.75"(381mm) deep

14.2 Weight

18.0 lb (8.2 Kg) without options

14.3 Warm- up Time

15 minutes for specified accuracy

14.4 Power Requirements(standard)**14.4.1 Source Voltage and Frequency** 100- 240 VAC at 50/60Hz**14.4.2 Power Consumption** 60 Watts maximum (without options)

14.5 Power Requirements(Optional AC/DC power supply:AC2568)



- 14.5.1 Source Voltage and Frequency 100- 240 VAC at 50/60Hz
13- 21VDC (Use only AC 2603 battery)
- 14.5.2 Battery(With AC 2603) 14.4 Volt nominal
- 14.5.3 Power Consumption 80 Watts maximum

14.6 Fuse Requirements

- 14.6.1 F1 and F2
 - 14.6.1.1 100 to 120 VAC 3.15 A, 250 V, Type T
 - 14.6.1.2 220 to 240 VAC 3.15 A, 250 V, Type T
 - 14.6.1.3 13- 21 VDC 7A, Type S(Optional AC/DC Power Supply)

14.7 Environmental Range

- 14.7.1 Use Indoor
- 14.7.2 Operating Temperature 0 to 40 °C
- 14.7.3 Storage Temperature - 20 to 70 °C
- 14.7.4 Temperature/Humidity Meets MIL- T- 28800E for Type 2, Class 5, non-condensing(85% operating, 90% storage)
- 14.7.5 Vibration Meets MIL- T- 28800E for Type 2, Class 5
- 14.7.6 Altitude Operation up to 3,000 meters
Non- operational up to 40,000 feet

14.8 Product Safety Complies with EN61010- 1

- 14.8.1 Supplemental Environmental Conditions
 - 14.8.1.1 Mains Supply Voltage Fluctuations:
 $\leq \pm 10\%$ of the nominal voltage
 - 14.8.1.2 Transient Overvoltages:According to Installation Category II
 - 14.8.1.3 Pollution Degree: 2

14.9 RF Emissions and Immunity

- 14.9.1 RF Emissions Complies with EN 55011 : 1991, Class A
- 14.9.2 RF Immunity Complies with EN 50082- 1 : 1997

SECTION 2

PREPARATIONS BEFORE USE

This section explains the preparations and safety procedures that should be performed before using the 2398 Spectrum Analyzer. The safety procedures are to prevent the risk of injury to the operator and damage to the equipment.

Ensure that you understand the contents of the pre- operation preparations before using the 2398.

For connecting the GPIB cable and setting the GPIB address, see the remote control operation in Volume 2.

TABLE OF CONTENTS

Installation Site and Environmental Conditions	2- 3
Locations to be avoided	2- 3
Fan clearance	2- 3
Safety Measures	2- 4
Power on	2- 4
Input level to RF Input	2- 5
Preparations before Power on	2- 6
Protective grounding	2- 7
Replacing fuse	2- 8
Precaution for handling memory card (option)	2- 10
AC/DC power and rechargeable battery pack (option)	2- 11
Replacement of fuse for DC power (option)	2- 12
How to contact DC Battery pack(option)	2- 13

⟨BLANK⟩

SECTION 2 PREPARATIONS BEFORE USE

Installation Site and Environmental Conditions

Locations to be avoided

The 2398 operates normally at temperatures from 0 to 40 °C. However, for best performance, the following situations should be avoided.

- Where there is severe vibration.
- Where the humidity is high.
- Where the equipment will be exposed to direct sunlight.
- Where the equipment will be exposed to active gases.

In addition to meeting the above conditions, to ensure long term trouble free operation, the equipment should be used at room temperature and in a location where the power supply voltage does not fluctuate greatly.

CAUTION

If the 2398 is used at normal temperatures after it has been used or stored for a long time at low temperatures, there is a risk of short circuiting caused by condensation. To prevent this risk, do not turn the 2398 on until it has been allowed to dry out sufficiently.

Fan clearance

To suppress any internal temperature increase, the 2398 has a fan on the rear panel. As shown in the diagram below, leave a gap of at least 10cm between the rear panel and wall, nearby equipment or obstructions so that fan ventilation is not blocked.

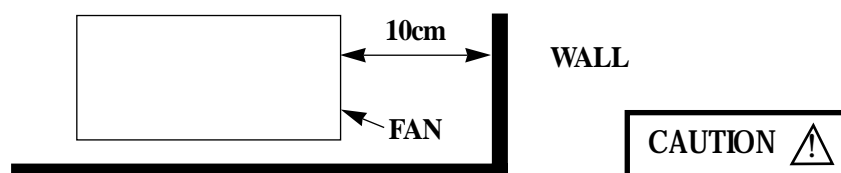

Safety Measures

This paragraph explains the safety procedures which should be followed under all circumstances to prevent the risk of an accidental electric shock, damage to the equipment or a major operation interruption.

Power on

WARNING 

- **Before power on** **The 2398 must be connected to protective ground. If the power is switched on without taking this precaution, there is a risk of receiving an accidental electric shock. In addition, it is essential to check the power source voltage. If an abnormal voltage that exceeds the specified value is input , there is accidental risk of damage to the 2398and fire.**
- **During power on** **To maintain the 2398, sometimes it is necessary to make internal checks and adjustments with the covers removed while power is supplied. Request service by a IFR trained service personnel who received the required training.**

In the following, special notes on safety procedures are extracted from sections other than section 2.

To prevent accidents, read this section together with the related sections before beginning operation.

Input Level to RF Input

Frequency range : 9kHz to 2.7GHz

Measurement level : The maximum signal level which can be applied to the Type N RF input connector is +26 dBm.



WARNING

The RF Input circuit is not protected against excessive power.

If a signal exceeding +26dBm is applied, the input attenuator and input mixer will be damaged.

 **is a warning mark to prevent such damage.**

Preparations before Power on

The 2398 operates normally when it is connected to an 100VAC to 240VAC (automatic voltage selected automatically) 47 to 63Hz AC power supply. To prevent the following, take the necessary procedures described on the following pages before power is supplied.

- Accidental electric shock.
- Damage caused by abnormal voltage.
- Ground current problems.

To protect the operator, the following WARNING and CAUTION notices are attached to the rear panel of the 2398.

WARNING

**TO AVOID ELECTRIC SHOCK,
THE PROTECTIVE GROUNDING CONDUCTOR
MUST BE CONNECTED TO GROUND.
DO NOT REMOVE COVERS.
REFER SERVICING TO QUALIFIED PERSONNEL.**

CAUTION

**FOR CONTINUED FIRE PROTECTION
REPLACE ONLY WITH SPECIFIED
TYPE AND RATED FUSE.**

WARNING

Disassembly, adjustment, maintenance, or other access inside this instrument is to be performed qualified personnel only. Maintenance of this instrument should be performed only by IFR trained service personnel who are familiar with the risk involved of fire and electric shock. Potentially lethal voltages existing inside this instrument, if contacted accidentally, may result in personal injury or death, or in the possibility of damage to precision components.

Always follow the instructions on the following pages.

Protective Grounding

Grounding with frame ground (FG) terminal

When there is no grounded AC power- supply outlet, the protective frame- ground (FG) terminal on the rear panel must be connected directly to ground potential.

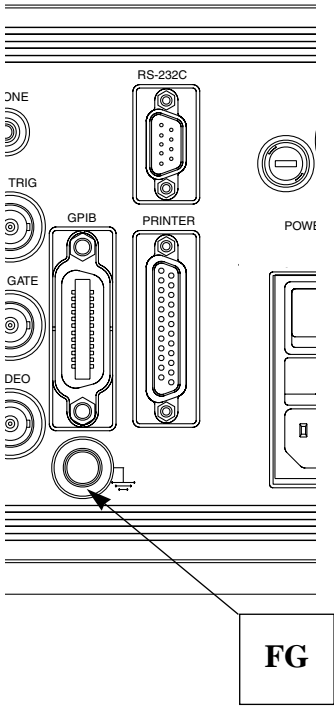

WARNING ⚠

If power is applied without protective grounding, there is a risk of accidental electric shock. The protective frame ground (FG) terminal on the rear panel, or the ground pin of the supplied power cord must be connected to ground potential before power is supplied to the 2398

Replacing fuse

WARNING 

- If the fuses are replaced while power is supplied, there is a serious risk of electric shock. Before replacing the fuses, set the power switch to OFF and remove the power cord from the power outlet.
- If power is supplied without protective grounding, there is a risk of accidental electric shock. In addition, if the AC power supply voltage is excessive, there is a risk of the internal circuits of the 2398 being damaged by the abnormal voltage. Before supplying power again after changing the fuses, check that the protective grounding described previously is still connected, and check that the AC power supply voltage is suitable. Then, set the power switch to ON.

CAUTION 

When there are no supplied spare fuses, the replacement fuses must have the same voltage and current rating as specified.

- If the replacement fuses are not of the same type, they may not fit correctly, there may be a faulty connection, or the time taken for the fuses to blow may be too long.
- If the voltage and current rating of the fuses is incorrect, the fuses may not blow causing damage to the equipment.

The fuses are inserted in the fuse holder and must be replaced if they blow. If the fuses must be replaced, locate and remedy the cause before replacing the blown fuses. The 2398, with standard accessories, has two spare T3.15A fuses.

After performing the safety procedures described on the preceding page, replace the fuses according to the following procedure.

CAUTION 

Step	Procedure
1	Set the front panel [Power] switch to STBY and the rear panel [Line]switch to OFF. Then, remove the power cord from the power- supply outlet.
2	Pull out the fuse holder at the rear panel with pressing the fuse holder hook.
3	Remove the fuse from the fuse cap and replace it with a spare fuse. (The direction does not matter.)
4	Put the fuse cap with fuse into the fuse holder and insert it by pushing inward.

Precaution for handling memory card(option)

When a new memory card is used to save any file, format it beforehand to MS- DOS.

When saving data to a memory card; confirm that the write- protect switch of the card is set to the NOT PROTECTED side, and then install it in the 2398.

- Installing Memory Card

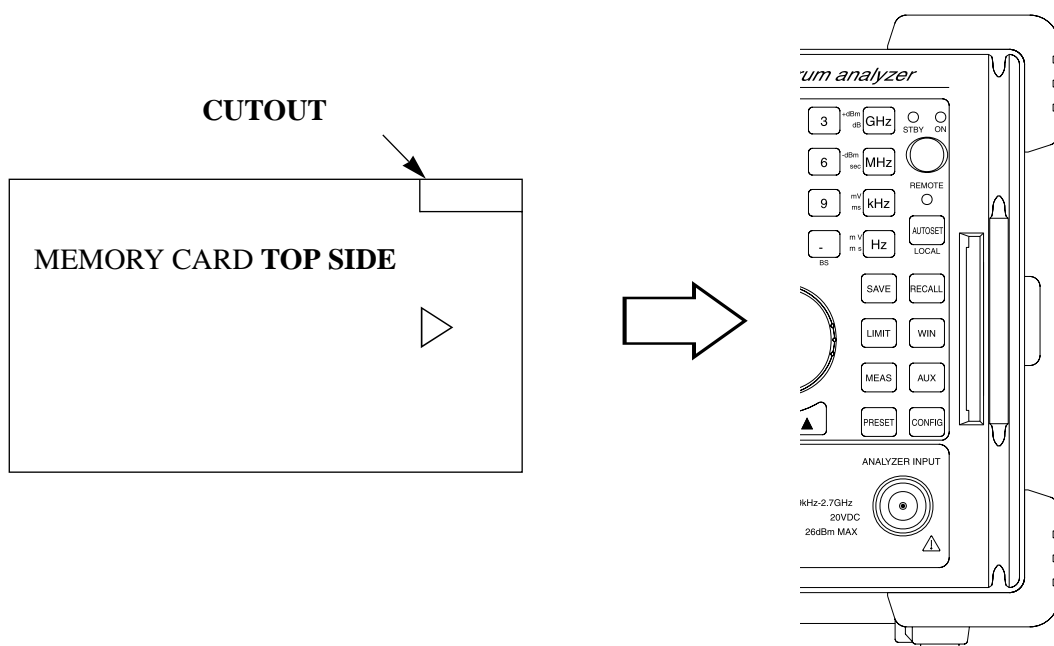

Install the memory card to the 2398, with the cutout of the card at the position as shown above.

- Removing Memory Card

Extract Card to remove the memory card.

- Replacing Battery of Memory Card

Each memory card has a battery. When the battery life ends, the saved data is erased.

Replace the battery before the life end. (For the battery life and replacement method, see the operation manual of the card.)

AC/DC Power and Rechargeable Battery Pack(option)

If the AC/DC power supply and rechargeable battery pack is installed in the system, either AC or DC power can operate the system.

The AC power is a 100VAC to 240Vac and 47 to 63Hz.

The DC power range is 13V dc to 21V DC.

The nominal power of the rechargeable battery pack is 14.4 VDC, 7AH. (Ni- Cd Battery)

A sufficiently charged battery pack will operate the system about 1 hour.

To prevent abnormal operation, use the following procedure.

When the AC power and DC power is input to system simultaneously,

AC power is used to operate the system.

When the AC power is off, DC power is used to operate the system.

The optional AC/DC power supply has a battery charging circuit for the rechargeable battery pack while the rechargeable battery pack is connected to the DC power inlet.

When the equipment do not use, the batterg pack should be disconnected from the equipment to protect the discharging of the battery pack.

WARNING

When the AC power is on, recharging voltage is applied to the DC power connector.
DC power supply output can only be used for the rechargeable battery pack. (AC2603)
DO NOT use the power supply for any other purpose.

Replacement of fuse for DC power(option)

The DC power fuse is 7A, 250V Type T fuse.

If the fuse must be replaced, locate and remedy the cause before replacing the blown fuse.

Replace the fuse according to the following procedure.



Step	Procedure
1	Set the front panel [Power] switch to STBY and the rear panel [Line]switch to OFF. Then, remove the power cord from the power supply outlet.
2	Turn the fuse holder cap at the rear panel.
3	Remove the fuse from the fuse cap and replace it with a spare fuse. (The direction does not matter.)
4	Push the fuse cap with fuse into the fuse holder and insert it by turning clockwise.

How to connect DC Battery pack(option)

CAUTION 

1. The AC2603 is meant for use only with the 2398. Do not use with any other DC power supply or battery.
2. Turn the main switch off before connecting or removing the battery pack.
3. If not using the battery pack, disconnect it from the system.



<STEP 1> Open the box



<STEP 2> Connect the battery cable to the AC2603



<STEP 3> Insert the battery into the soft carrying case as indicated above.



<STEP 4> Connect the other side of the battery cable to the DC power jack in the rear panel as indicated above.

SECTION 3 PANEL DESCRIPTION

In this section the front and rear panels are described.

TABLE OF CONTENTS

Panel Description	3- 3
Table of I/O Connectors	3- 5
IEEE- 488 GPIB Connector	3- 6
RS- 232C Connector	3- 7
Printer Connector	3- 8
DC Input Connector	3- 9

SECTION 3 PANEL DESCRIPTION

⟨BLANK⟩

SECTION 3 PANEL DESCRIPTION

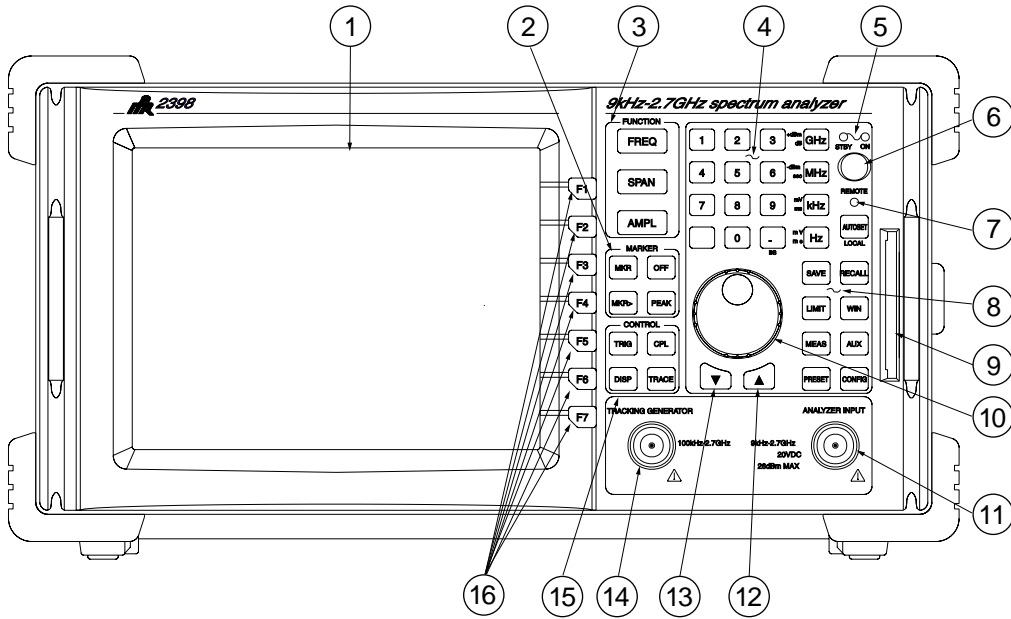

Figure 1 Front Panel Controls, Connectors and Indicators

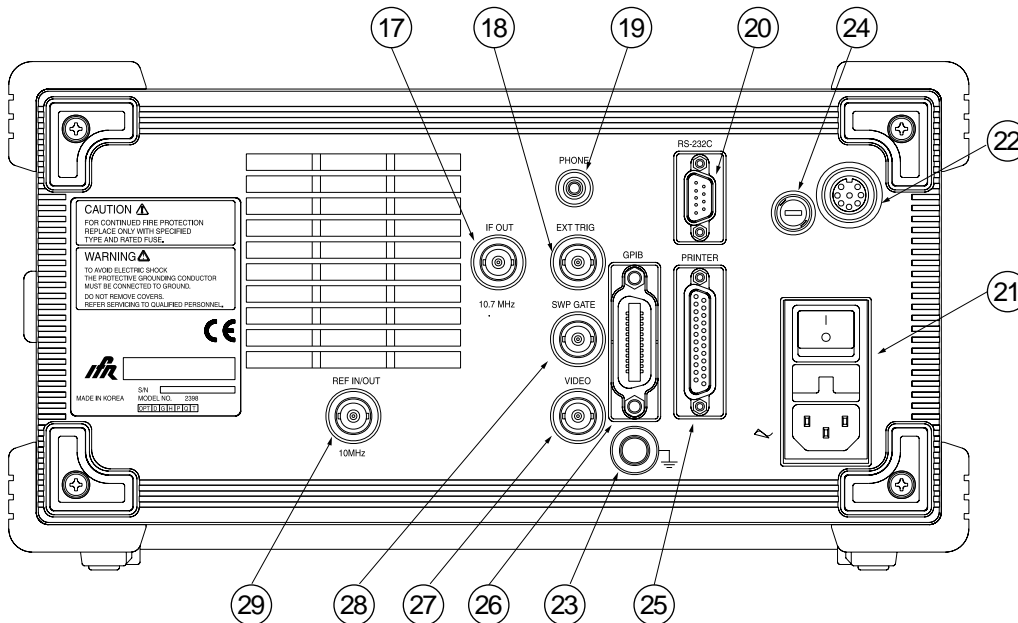

Figure 2 Rear Panel Controls, Connectors and Indicators

Controls, Connectors and Indicators Location List :

LOCATION	ITEM
1	LCD Display
2	Marker Function Keys
3	Frequency & Amplitude Function Keys
4	Data Entry Keys
5	Power ON & Standby Indicators
6	Power ON/OFF Control
7	Remote Control Operation Indicator
8	General Function Keys
9	PCMCIA Connector Slot
10	Data Spinner Control
11	Spectrum Analyzer Input Connector
12	Increase Key
13	Decrease Key
14	Optional Tracking Generator Output connector
15	Control Function Keys
16	Soft Function Keys
17	IF Output Connector
18	External Trigger Input Connector
19	External Earphone Connector
20	RS232 Connector
21	AC Input Connector and Fuse
22	DC Input Connector
23	Chassis Ground Connector
24	DC Fuse
25	Printer Connector
26	IEEE- 488 GPIB Connector
27	External Video Connector
28	External Sweep Gate Connector
29	10 MHz Referenc Input/Output Connector

TABLE OF I/O CONNECTORS

CONNECTOR	TYPE	IN/OUT	SIGNAL
AC Input	IEC 320 Socket	Input	AC Power
Analyzer Input	Type N Female	Input	RF
Optional Tracking Generator Output	Type N Female	Output	RF
External Trigger Input	BNC Female	Input	
External Sweep Gate Output	BNC Female	Output	
External Video output	BNC Female	Output	
External Reference Oscillator IN/OUT	BNC Female	Input/ Output	IN: 10MHz OUT: 10MHz
IF Output	BNC Female	Output	10.7 MHz
IEEE- 488 GPIB	24- Pin Champ	IN/OUT	See Pin- Out (Table 2)
PRINTER	25- Pin, D-sub Female	Output	Screen Print Data See Pin- Out (Table 4)
RS- 232C	9- Pin, D-sub male	IN/OUT	See Pin- Out (Table 3)

Table 1 I/O Connectors

IEEE-488 GPIB CONNECTOR

The IEEE- 488 GPIB Connector complies with ANSI/IEEE Standard 488.2- 1987.

PIN NUMBER	SIGNAL	PIN NUMBER	SIGNAL
1	DIO 1	13	DIO 5
2	DIO 2	14	DIO 6
3	DIO 3	15	DIO 7
4	DIO 4	16	DIO 8
5	EQI	17	REN
6	DAV	18	Ground
7	NRFD	19	Ground
8	NDAC	20	Ground
9	IFC	21	Ground
10	SRQ	22	Ground
11	ATN	23	Ground
12	Ground	24	Ground

Table 2 Pin-Out for IEEE-488 GPIB Connector

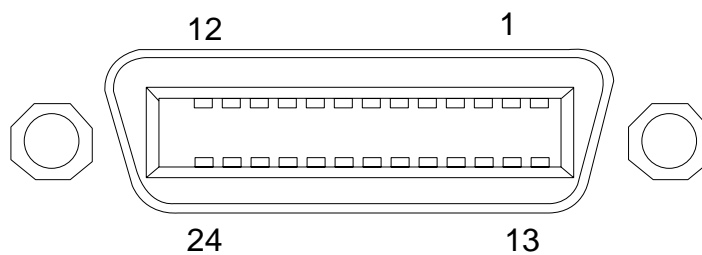

Figure 3 IEEE-488 GPIB Connector

RS-232C CONNECTOR

PIN NUMBER	SIGNAL
1	DCD
2	RXD
3	TXD
4	DTR
5	Ground
6	DSR
7	RTS
8	CTS
9	RI(NC)

Table 3 Pin-Out for RS-232C Connector

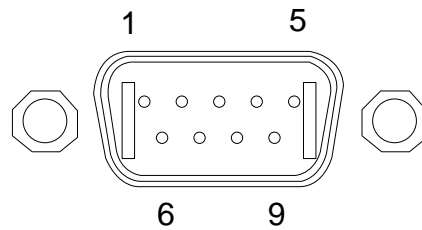

Figure 4 RS-232C Connector

PRINTER CONNECTOR

PIN NUMBER	SIGNAL
1	$\overline{\text{STB}}$
2	PD0
3	PD1
4	PD2
5	PD3
6	PD4
7	PD5
8	PD6
9	PD7
10	$\overline{\text{ACK}}$
11	BUSY
12	PE
13	SLCT
14	$\overline{\text{AFD}}$
15	$\overline{\text{ERROR}}$
16	INIT
17	$\overline{\text{SLIN}}$
18	Ground
19	Ground
20	Ground
21	Ground
22	Ground
23	Ground
24	Ground
25	Ground

Table 4 Pin-Out for PRINTER Connector

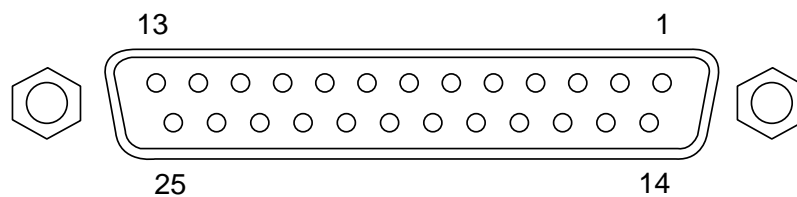

Figure 5 PRINTER Connector

DC INPUT CONNECTOR

PIN NUMBER	SIGNAL
1	LED- Anode
2	Battery+
3	Battery+
4	Battery+
5	Battery-
6	Battery-
7	LED- Cathode
8	Battery-

Table 5 Pin-Out for DC Input Connector

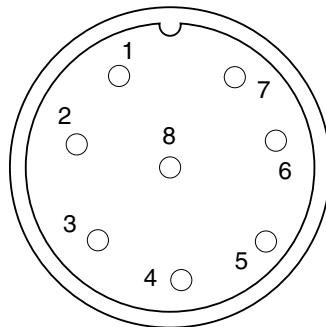

Figure 6 DC Input Connector(Front view)

⟨BLANK⟩

SECTION 4

MENU TREE

TABLE OF CONTENTS

Menu Tree	4- 3
FREQ, SPAN, AMPL	4- 4
MKR, OFF, MKR>, PEAK	4- 5
TRACE, CPL	4- 6
TRIG, DISP	4- 7
SAVE, RECALL	4- 8
CONFIG	4- 9
MEAS	4- 10
AUX, LIMIT, WIN, AUTOSET	4- 11
PRESET	4- 12

⟨BLANK⟩

SECTION 4 MENU TREE

In this section, soft menu functions and its system hierarchy are described using a menu tree. Matters to be noted about the tree are shown below.

- (1) Panel key indicates a hard key on the panel
- (2) SOFT MENU 1 keys are displayed on the screen when the panel key is pressed. SOFT MENU 2 indicates another menu below the SOFT MENU 1.
- (3) When the return key is pressed for SOFT MENU 2 keys, the SOFT MENU 1 is returned.

Menu Tree

Panel Key	Soft Menu 1	Soft Menu 2														
FREQ	<table border="1"> <tr><td>CENTER</td></tr> <tr><td>START</td></tr> <tr><td>STOP</td></tr> <tr><td>CF STEP [AUTO/MNL]</td></tr> <tr><td> </td></tr> <tr><td> </td></tr> <tr><td> </td></tr> </table>	CENTER	START	STOP	CF STEP [AUTO/MNL]											
CENTER																
START																
STOP																
CF STEP [AUTO/MNL]																
SPAN	<table border="1"> <tr><td>SPAN WIDTH</td></tr> <tr><td>FULL SPAN</td></tr> <tr><td>ZERO SPAN</td></tr> <tr><td>LAST SPAN</td></tr> <tr><td>ZOOM IN</td></tr> <tr><td>ZOOM OUT</td></tr> <tr><td> </td></tr> </table>	SPAN WIDTH	FULL SPAN	ZERO SPAN	LAST SPAN	ZOOM IN	ZOOM OUT									
SPAN WIDTH																
FULL SPAN																
ZERO SPAN																
LAST SPAN																
ZOOM IN																
ZOOM OUT																
AMPL	<table border="1"> <tr><td>REF LEVEL</td></tr> <tr><td>ATTEN[AUTO/MNL]</td></tr> <tr><td>LOG</td></tr> <tr><td>LINEAR</td></tr> <tr><td>SCALE..</td></tr> <tr><td>UNIT..</td></tr> <tr><td>REF LVL OFFSET</td></tr> </table>	REF LEVEL	ATTEN[AUTO/MNL]	LOG	LINEAR	SCALE..	UNIT..	REF LVL OFFSET	<table border="1"> <tr><td>10dB/DIV</td></tr> <tr><td>5dB/DIV</td></tr> <tr><td>2dB/DIV</td></tr> <tr><td>1dB/DIV</td></tr> <tr><td>RETURN</td></tr> <tr><td> </td></tr> <tr><td> </td></tr> </table>	10dB/DIV	5dB/DIV	2dB/DIV	1dB/DIV	RETURN		
REF LEVEL																
ATTEN[AUTO/MNL]																
LOG																
LINEAR																
SCALE..																
UNIT..																
REF LVL OFFSET																
10dB/DIV																
5dB/DIV																
2dB/DIV																
1dB/DIV																
RETURN																
		<table border="1"> <tr><td>dBm</td></tr> <tr><td>dBmV</td></tr> <tr><td>dBuV</td></tr> <tr><td>VOLTS</td></tr> <tr><td>WATTS</td></tr> <tr><td>RETURN</td></tr> <tr><td> </td></tr> </table>	dBm	dBmV	dBuV	VOLTS	WATTS	RETURN								
dBm																
dBmV																
dBuV																
VOLTS																
WATTS																
RETURN																

Panel Key	Soft Menu 1	Soft Menu 2							
MKR	<table border="1"> <tr><td>MARKER NORMAL</td></tr> <tr><td>MARKER Δ DELTA</td></tr> <tr><td>MARKER 1/ Δ</td></tr> <tr><td>PEAK SEARCH</td></tr> <tr><td> </td></tr> <tr><td> </td></tr> <tr><td> </td></tr> </table>	MARKER NORMAL	MARKER Δ DELTA	MARKER 1/ Δ	PEAK SEARCH				
MARKER NORMAL									
MARKER Δ DELTA									
MARKER 1/ Δ									
PEAK SEARCH									
OFF	[BLANK]								
MKR >	<table border="1"> <tr><td>MKR \Rightarrow CF</td></tr> <tr><td>MKR \Rightarrow REF LVL</td></tr> <tr><td>MKR \Rightarrow CF STEP</td></tr> <tr><td>MKR ZOOM IN</td></tr> <tr><td>MKR ZOOM OUT</td></tr> <tr><td> </td></tr> <tr><td> </td></tr> </table>	MKR \Rightarrow CF	MKR \Rightarrow REF LVL	MKR \Rightarrow CF STEP	MKR ZOOM IN	MKR ZOOM OUT			* Normal marker status
MKR \Rightarrow CF									
MKR \Rightarrow REF LVL									
MKR \Rightarrow CF STEP									
MKR ZOOM IN									
MKR ZOOM OUT									
	<table border="1"> <tr><td>ΔMKR \Rightarrow CF</td></tr> <tr><td>ΔMKR \Rightarrow CF STEP</td></tr> <tr><td>ΔMKR \Rightarrow SPAN</td></tr> <tr><td>MKR ZOOM IN</td></tr> <tr><td>MKR ZOOM OUT</td></tr> <tr><td> </td></tr> <tr><td> </td></tr> </table>	Δ MKR \Rightarrow CF	Δ MKR \Rightarrow CF STEP	Δ MKR \Rightarrow SPAN	MKR ZOOM IN	MKR ZOOM OUT			* Delta marker status
Δ MKR \Rightarrow CF									
Δ MKR \Rightarrow CF STEP									
Δ MKR \Rightarrow SPAN									
MKR ZOOM IN									
MKR ZOOM OUT									
PEAK	<table border="1"> <tr><td>MKR \Rightarrow CF</td></tr> <tr><td>MKR \Rightarrow REF LVL</td></tr> <tr><td>NEXT PEAK</td></tr> <tr><td>PEAK LEFT</td></tr> <tr><td>PEAK RIGHT</td></tr> <tr><td>MKR TRK[ON/OFF]</td></tr> <tr><td>MKR NOISE[ON/OFF]</td></tr> </table>	MKR \Rightarrow CF	MKR \Rightarrow REF LVL	NEXT PEAK	PEAK LEFT	PEAK RIGHT	MKR TRK[ON/OFF]	MKR NOISE[ON/OFF]	
MKR \Rightarrow CF									
MKR \Rightarrow REF LVL									
NEXT PEAK									
PEAK LEFT									
PEAK RIGHT									
MKR TRK[ON/OFF]									
MKR NOISE[ON/OFF]									

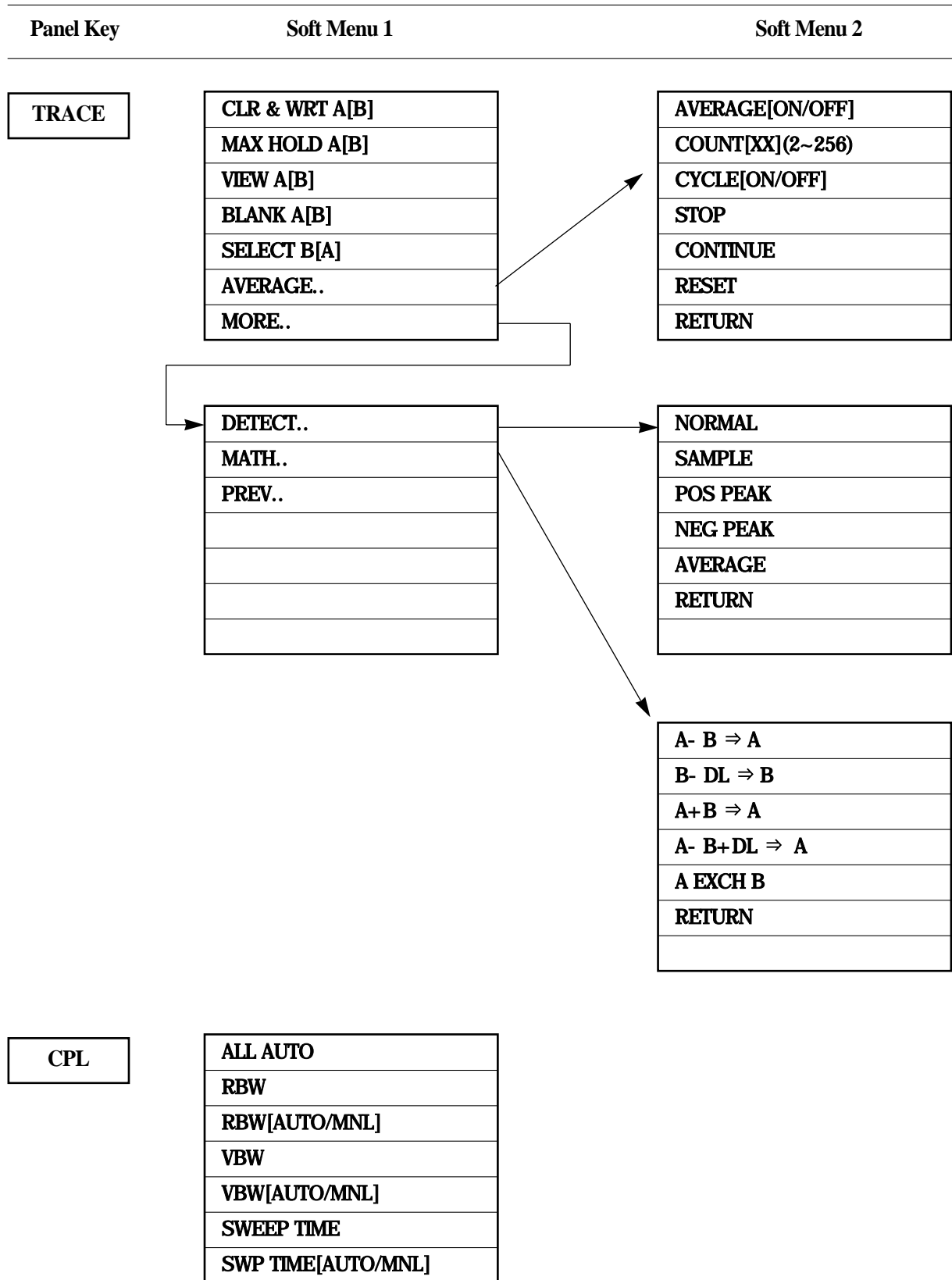

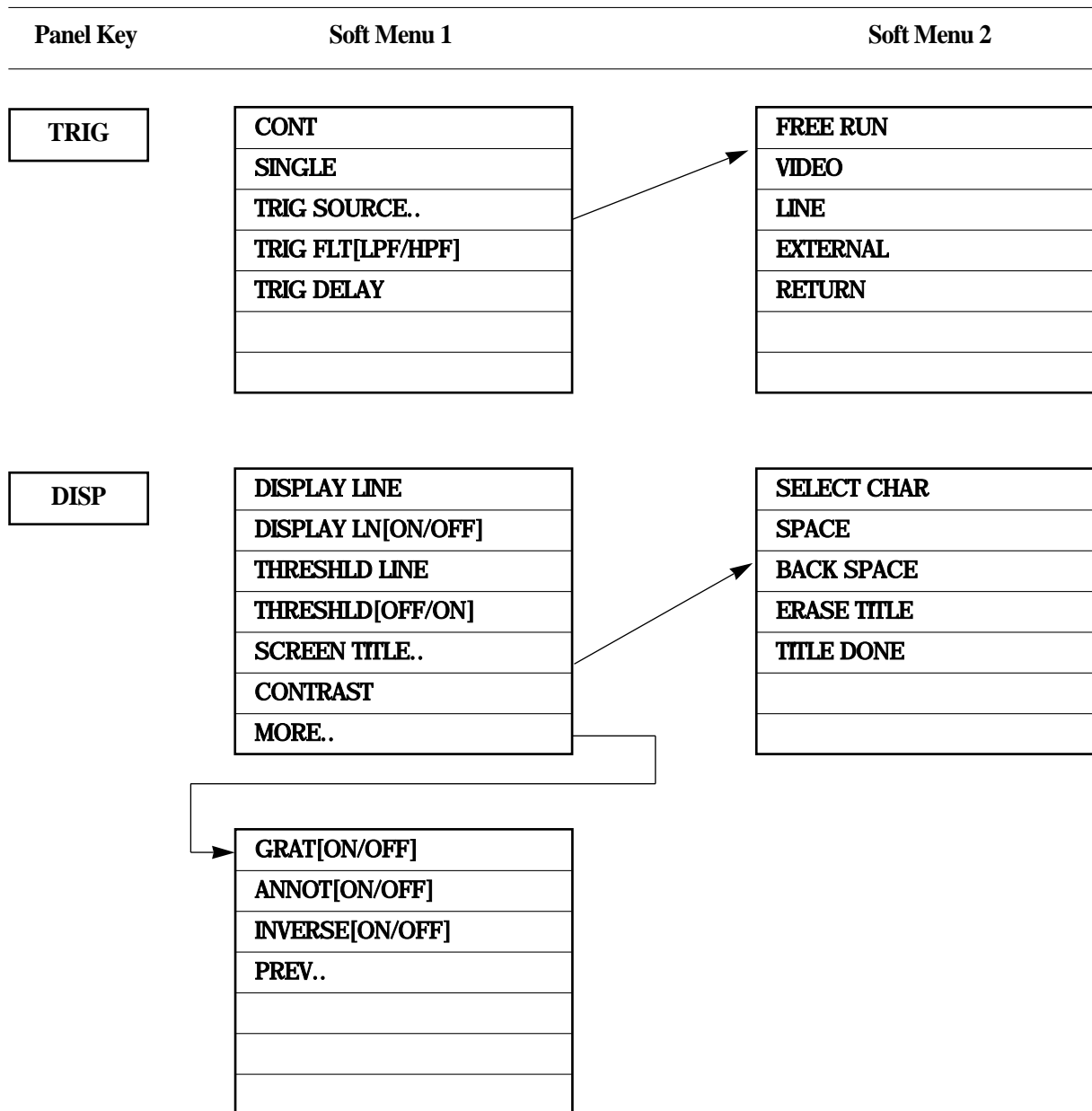

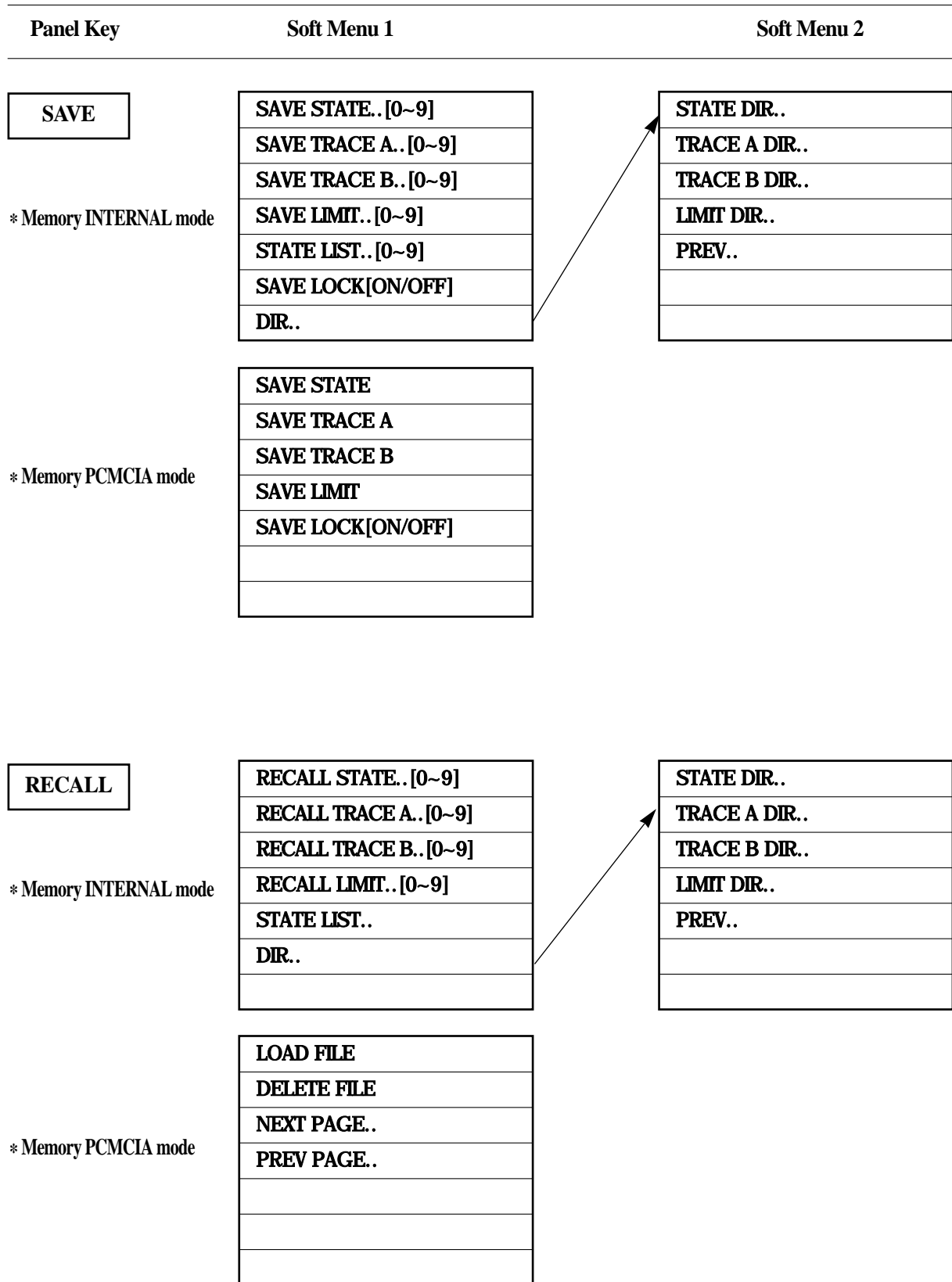

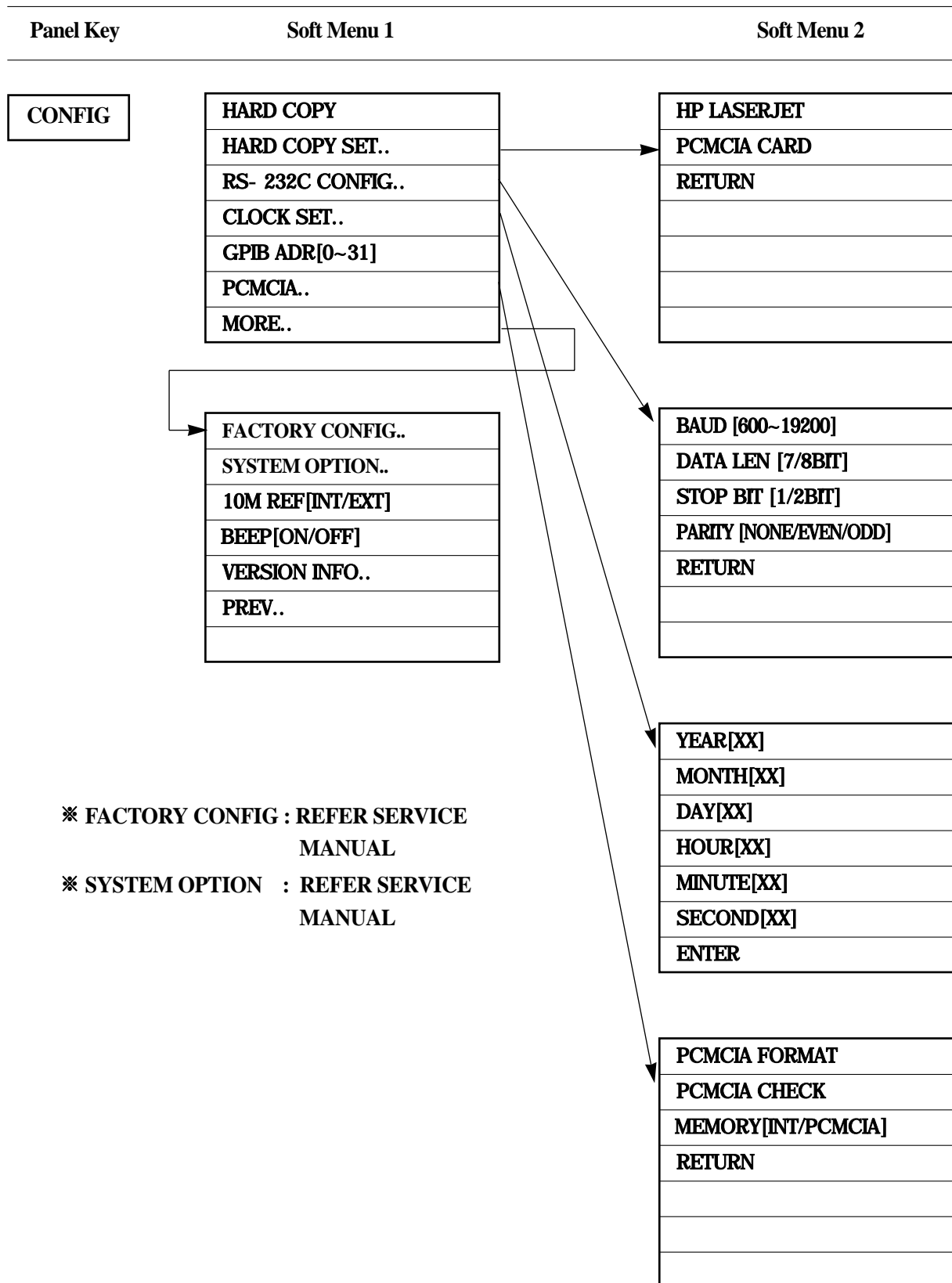

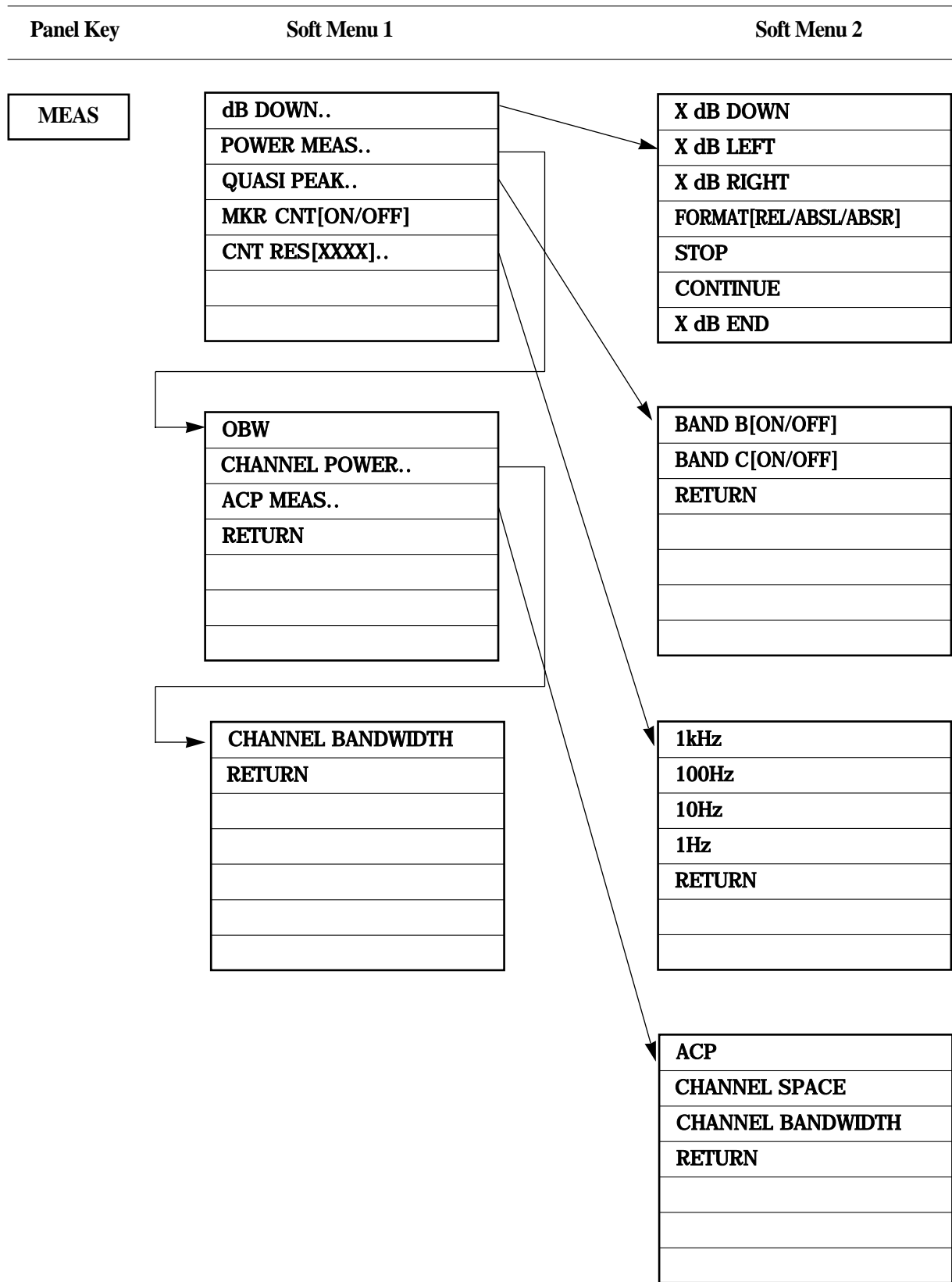

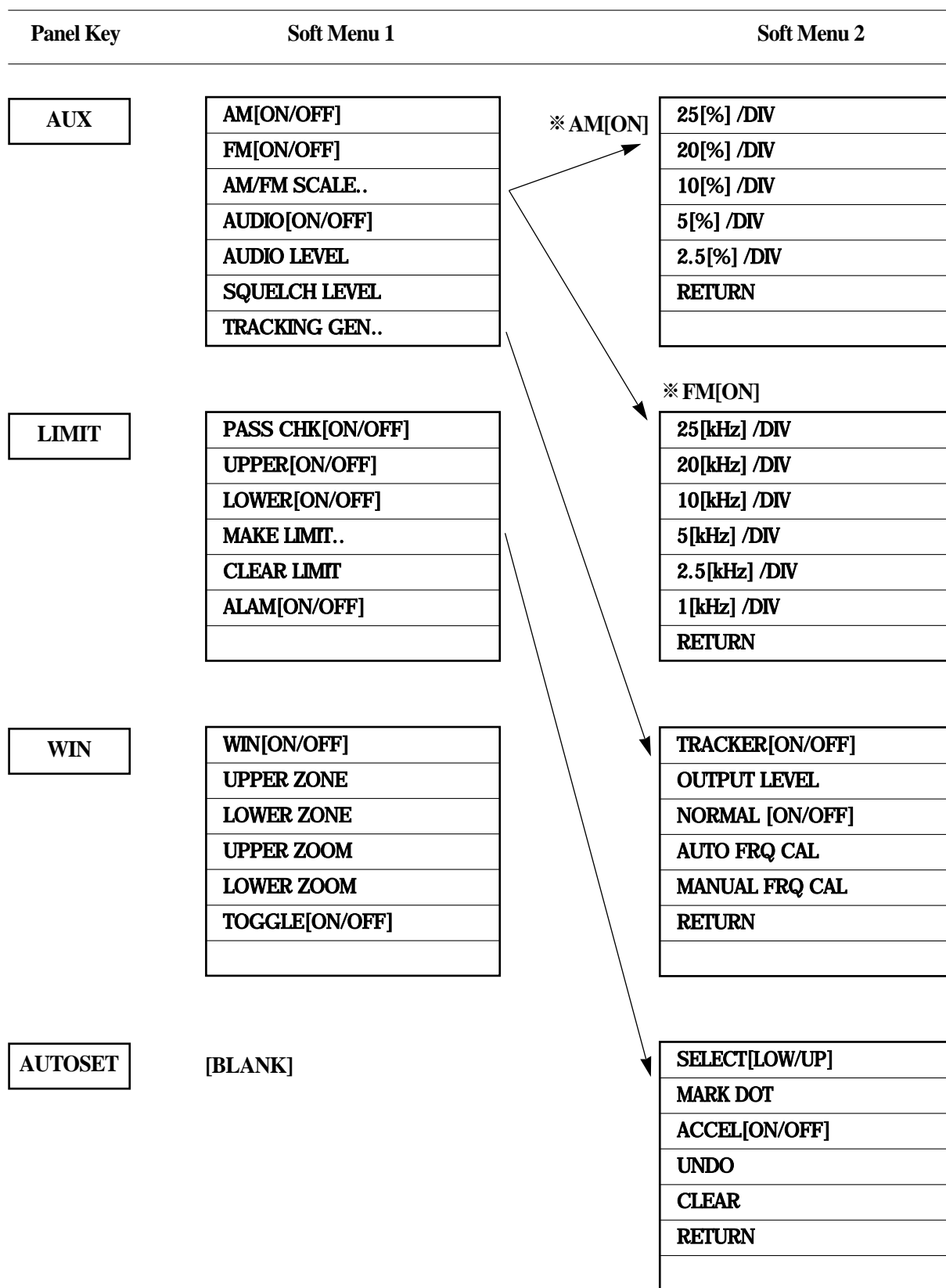

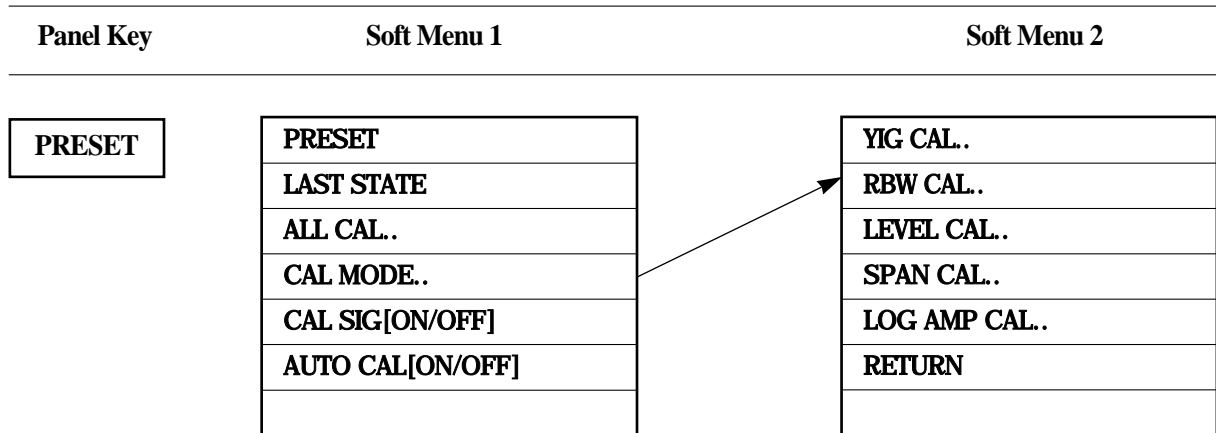

SECTION 5

OPERATING PROCEDURES

TABLE OF CONTENTS

FREQ/SPAN FUNCTIONS	5- 3
Center - Span Data Entry	5- 4
Start- Stop Freq Data Entry	5- 6
Setting CF Step Size	5- 8
Setting Full Span	5- 9
Setting Zero Span	5- 10
Return to the Previous Span	5- 11
Zoom In/Zoom Out	5- 11
AMPLITUDE FUNCTIONS	5- 12
Selecting Log/Linear Detector Mode	5- 12
Setting Amplitude Units	5- 12
Setting Reference Level	5- 13
Setting Amplitude Scale	5- 13
Reference Level Offset	5- 13
Setting Input Attenuation	5- 14
MARK FUNCTIONS	5- 15
Changing Marker Position	5- 15
Normal Marker	5- 16
Delta Marker	5- 17
Marker Off	5- 17
PEAK SEARCH FUNCTIONS	5- 18
Peak Search	5- 18
Next Peak Search	5- 19
Peak Left Search/Peak Right Search	5- 20
Marker Track	5- 20
Marker Noise	5- 21
SETTING PARAMETERS USING MARKER VALUES	5- 22
Setting Parameters Using Marker Values	5- 22
MKR- >CF STEP/MKR DELTA- >CF STEP	5- 22
Δ/MKR- >SPAN	5- 22
MKR ZOOM IN/ZOOM OUT	5- 23
AUTOSET	5- 24
TRACE FUNCTIONS	5- 25
Select Trace	5- 26
CLR & WRT A[B]	5- 26
MAX HOLD A[B]	5- 26
VIEW A[B]	5- 26
BLANK A[B]	5- 26
Computation	5- 27
Detection Mode	5- 28
Averaging Function	5- 30
DISPLAY FUNCTIONS	5- 31
Display Line	5- 31
Threshold Line	5- 32
Screen Title	5- 33
Contrast	5- 33
GRAT [ON/OFF]	5- 34

ANNOT [ON/OFF]	5- 34
INVERSE [ON/OFF]	5- 34
TRIGGER FUNCTIONS	5- 35
Continuous Sweep Mode	5- 35
Single Sweep Mode	5- 35
Triggered Mode	5- 36
Trigger Source	5- 36
Trigger Filter	5- 36
Trigger Level	5- 36
Line Trigger	5- 37
External Trigger	5- 37
Trigger Delay	5- 37
COUPLED FUNCTIONS	5- 38
All Auto Function	5- 38
RBW and Sweep Time	5- 39
Video Bandwidth(VBW)	5- 40
Input Attenuator	5- 41
CONFIGURATIONS	5- 42
Hard Copy	5- 42
Print Type	5- 42
RS- 232C Configuration	5- 43
GPIB Address	5- 43
Clock Set	5- 43
10M REF [INT/EXT]	5- 44
BEEP [ON/OFF]	5- 44
Version Information	5- 44
PCMCIA MEMORY CARD FUNCTIONS (option)	5- 45
SAVE AND RECALL FUNCTIONS	5- 46
Internal Register	5- 46
Save Parameters and Waveform	5- 47
Recall Parameters and Waveform	5- 48
MEASUREMENT FUNCTIONS	5- 50
X dB Down Measurement	5- 51
Occupied Power Bandwidth Measurement	5- 52
Marker Counter	5- 53
QP EMC Measurement (option)	5- 53
Channel Power	5- 54
Adjacent Channel Power(ACP)	5- 55
DEMODULATION AND AUDIO FUNCTIONS	5- 56
AM Demodulation	5- 57
FM Demodulation	5- 57
Audio Monitor	5- 57
TRACKING GENERATOR (option)	5- 58
LIMIT LINE FUNCTIONS	5- 59
WINDOW FUNCTIONS	5- 61
PRESET FUNCTIONS	5- 63
Preset	5- 63
Last State	5- 64
All Cal.	5- 64
Cal. Mode	5- 64
Cal. Signal	5- 64
Auto Cal. [ON/OFF]	5- 64

SECTION 5 OPERATING PROCEDURES

FREQ/SPAN FUNCTIONS

The observation frequency of the 2398 is set in either of two modes.

- Center - Span Mode.
- Start - Stop Mode.

The upper and lower limits are 0 Hz and 2.7GHz, respectively.

The FREQ key is used as the header key for setting the frequency.

The SPAN key is used as the header key for setting the frequency span.

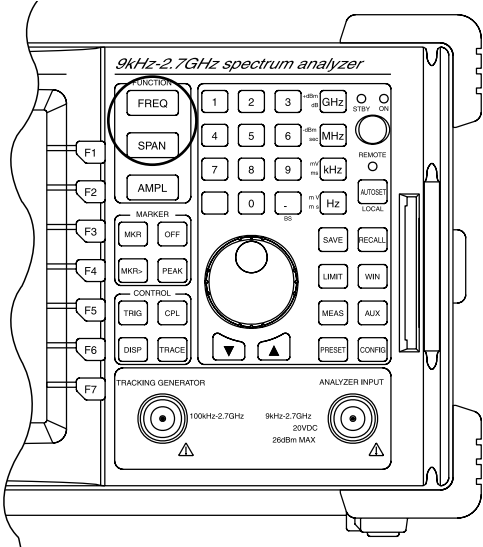

Center - Span Data Entry

1) Setting the center frequency

To set the center frequency, perform the following key operations:

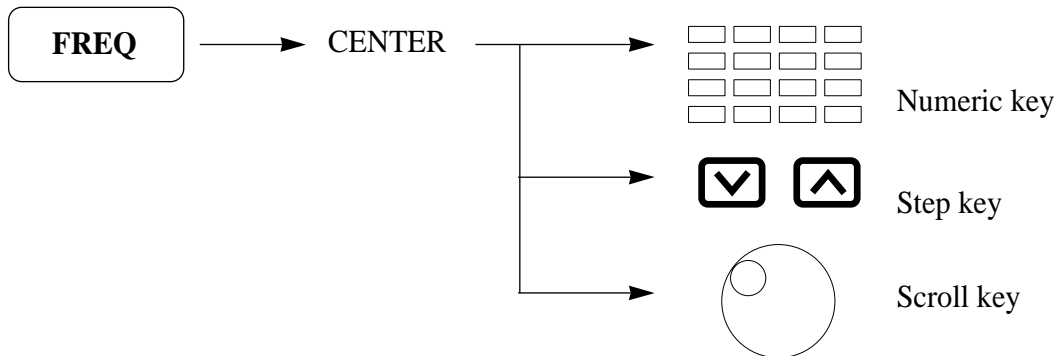

The step up down key step size is 1/10 of current frequency span.

The scroll key step size is 1/500 of the current frequency span.

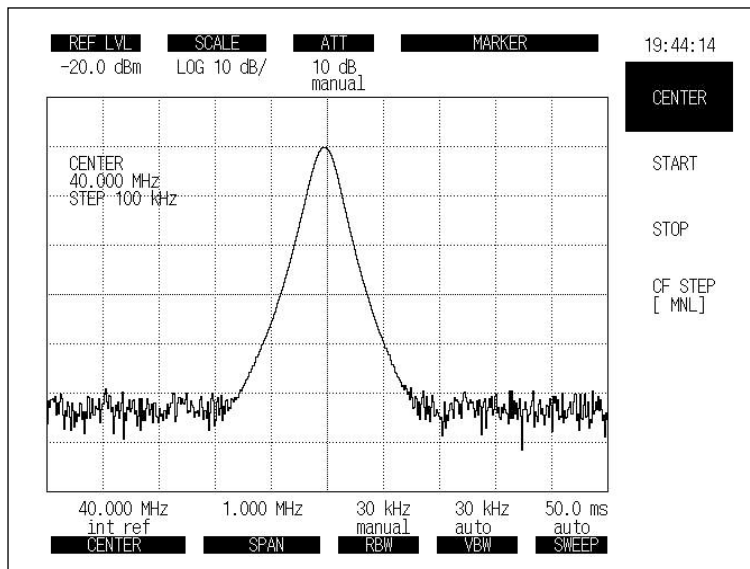
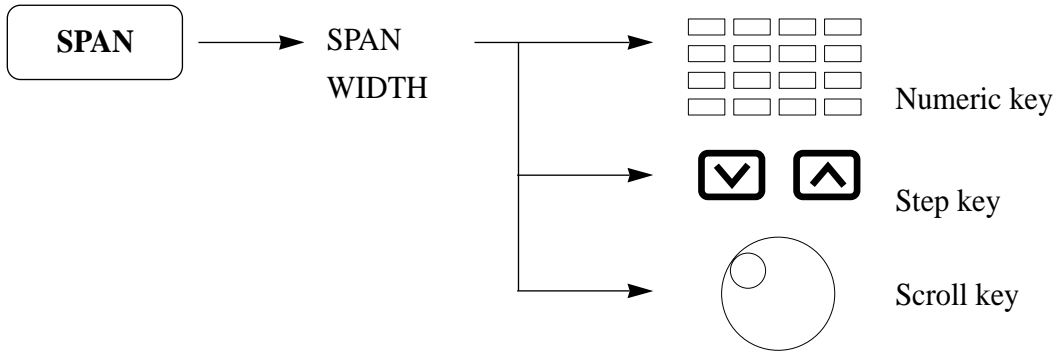

Fig 5-1. Center Frequency

(2) Setting the frequency span

To set the frequency span, perform the following key operations:



Changes in a 1, 2, 5 step sequence; 1k, 2k, 5k,, 100k, 200k, 500k,,
 The scroll key step size is 1/500 of the current frequency span.

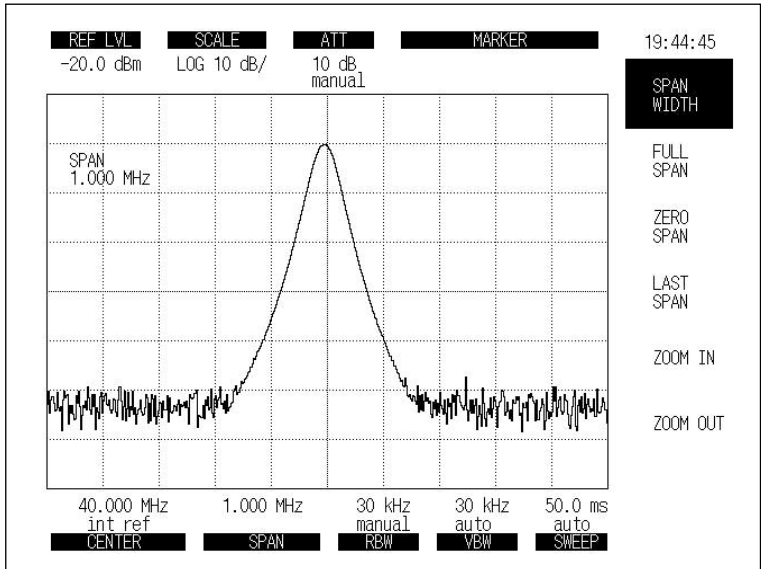
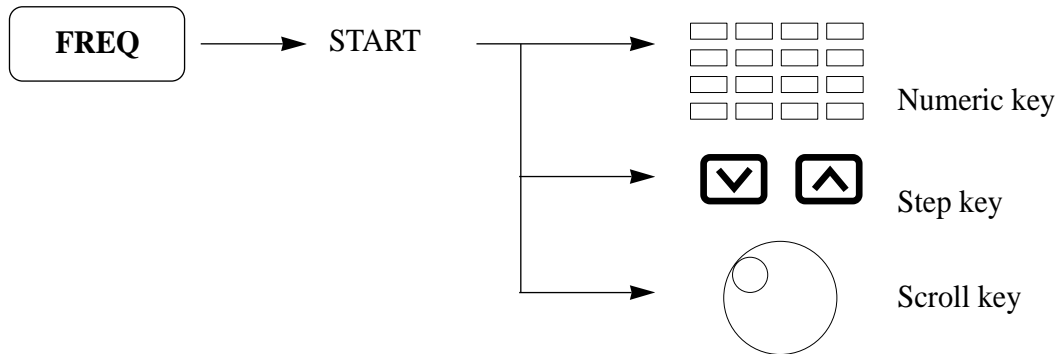

Fig 5-2. Span Width

Start - Stop Freq Data Entry

1) Setting the start frequency

To set the start frequency, perform the following key operations:



The step up down key step size is 1/10 of the current frequency span.

The scroll key step size is 1/500 of the current frequency span.

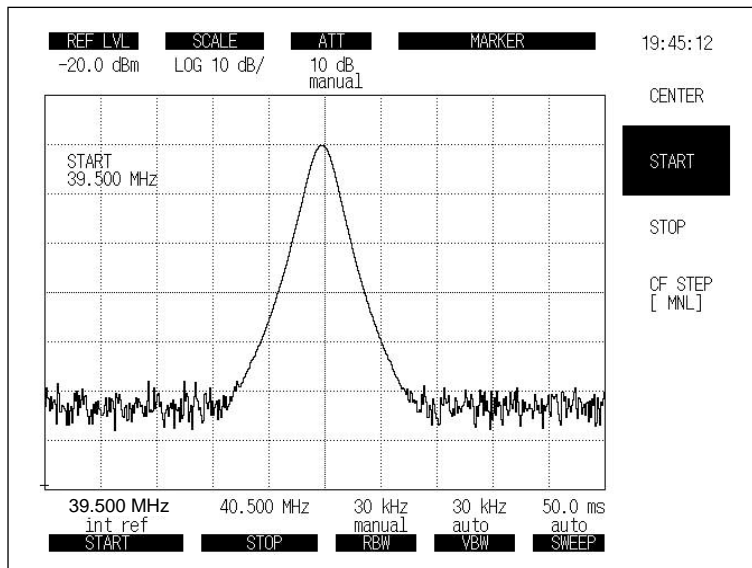
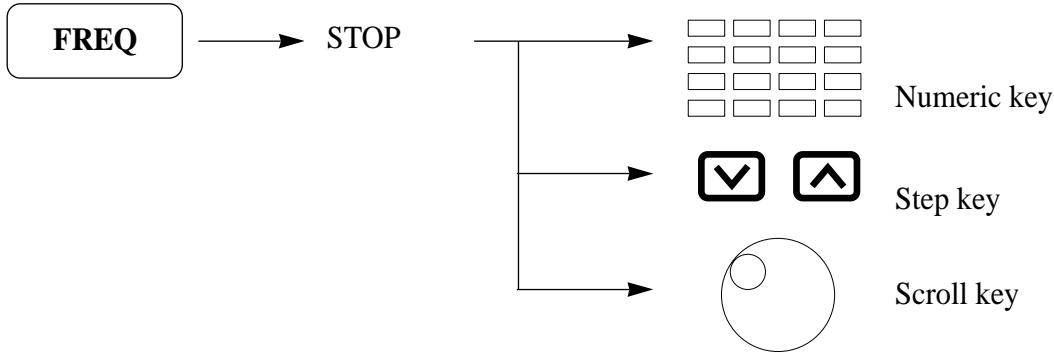

Fig 5-3. Start Frequency

(2) Setting the stop frequency

To set the stop frequency, perform the following key operations:



The step up down key step size is 1/10 of the current frequency span.

The scroll key step size is 1/500 of the current frequency span.

Notes : Because the step up and down keys are used for the center frequency, the start and stop frequencies are also changed.

The start and stop frequency may also vary depending on the values of the frequency span setting resolution.

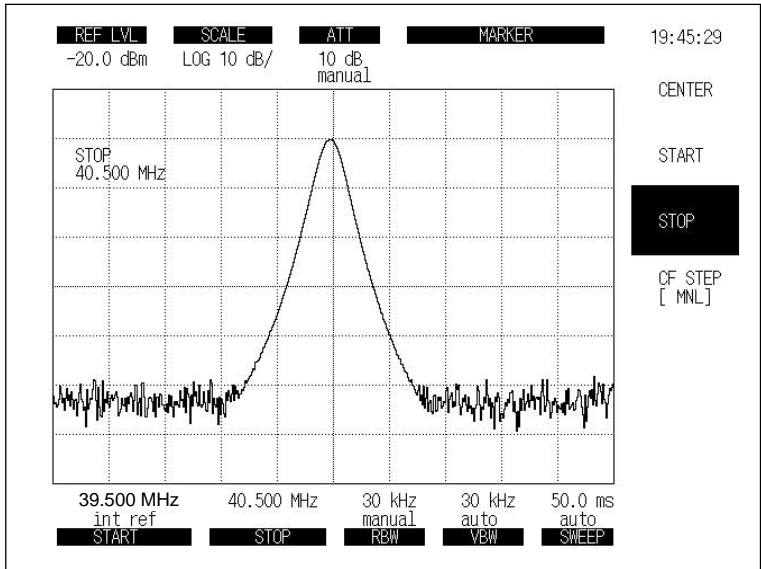
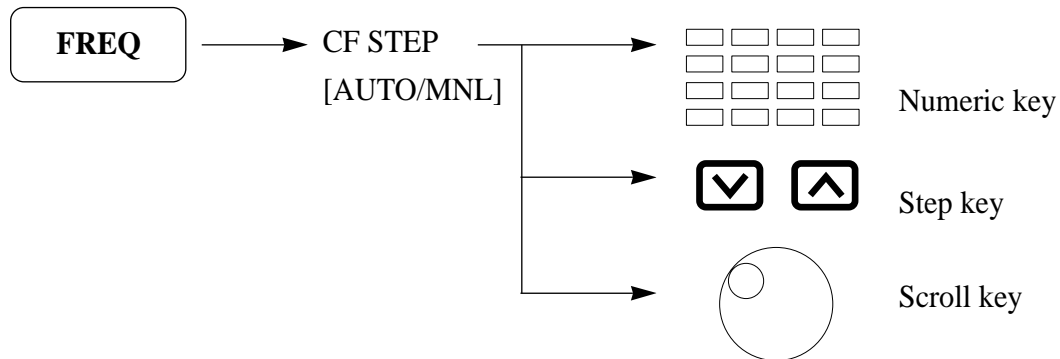

Fig 5-4. Stop Frequency

Setting CF Step Size

To use the step up and down keys to change the step size of the center frequency, identify the step size as following:



The **CF STEP** mode is changed from **AUTO** to **MNL** mode by pressing **CF STEP** soft key. In **CF STEP MNL (manual)** mode, the step size can be set by the numeric keys. If **CF STEP [AUTO/MNL]** “**AUTO**” is selected, the **CF Step** size will be selected by 1 /10 of the current span.

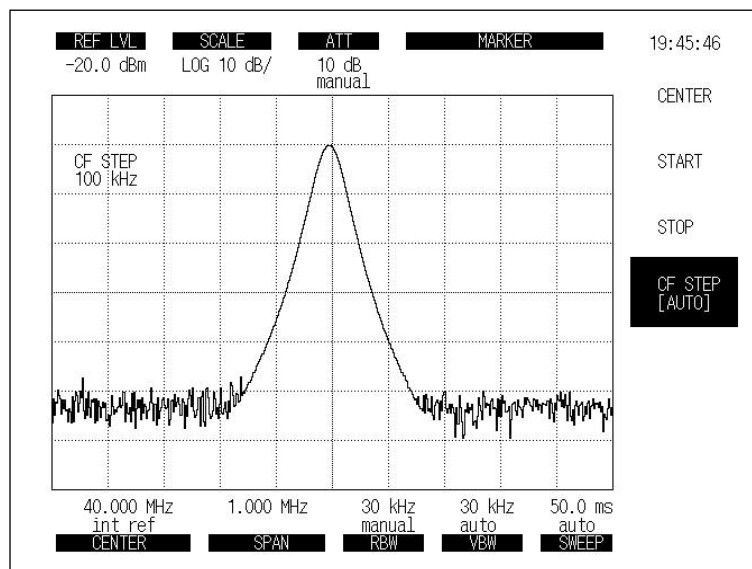

Fig 5-5. CF STEP

Setting Full Span

To set full span and leave the other parameters, perform the following key operations:

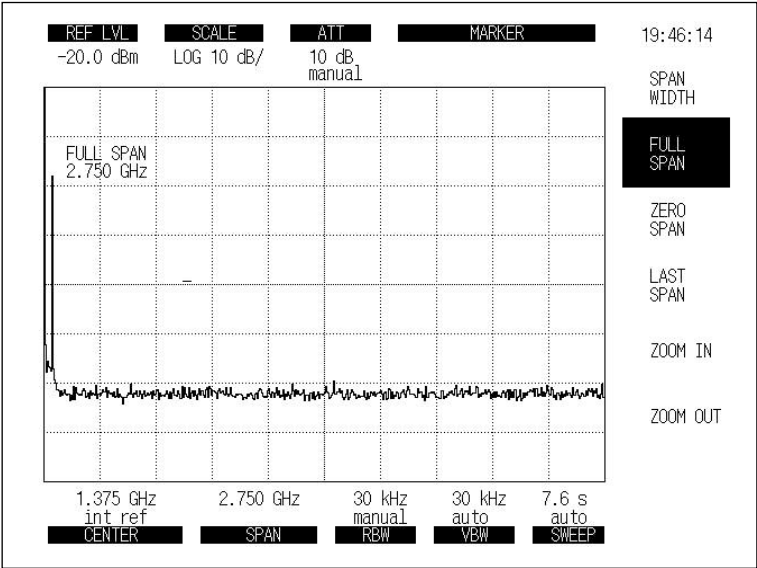
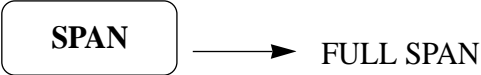

Fig 5-6. Full Span

Setting Zero Span

The 2398 Spectrum Analyzer can operate as a selective level meter in which the horizontal axis is graduated as a time axis by setting the frequency span to 0 Hz.

The rising and falling edges of signal burst wave can also be observed and measured.

Performing any of the following key operations allows the 2398 to operate in the zero span mode.

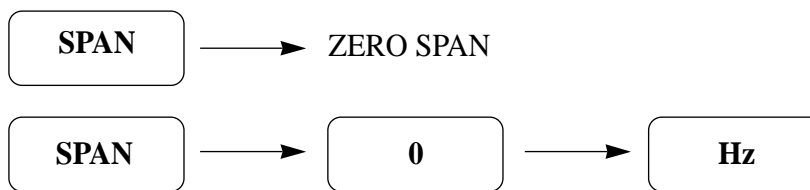

In the frequency and time domain, RBW, VBW, Sweep time and other coupling functions can be set to different values.

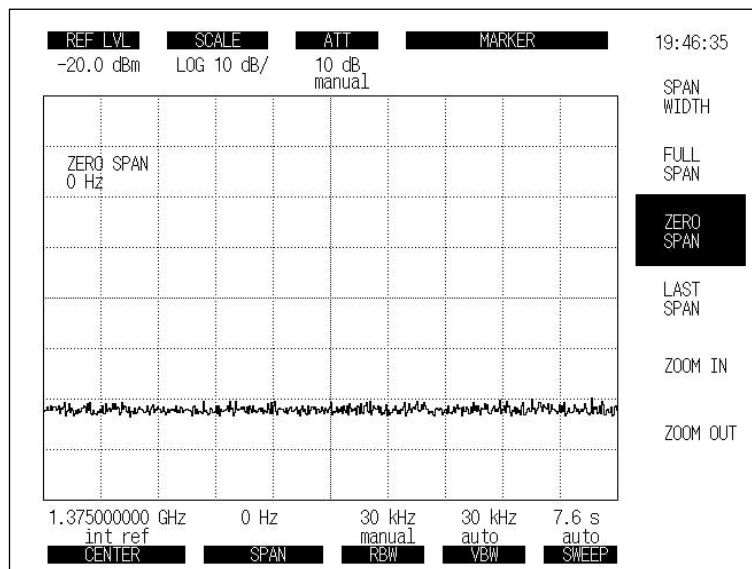
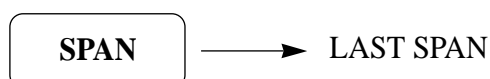

Fig 5-7. Zero Span

Return to the previous span

The previous span is returned by the following key operation.



Zoom In/Zoom Out

The ZOOM IN function changes the span from the current span to 1/2 of the current span. The ZOOM OUT function changes the span from the current span to 2 times the current span. The center frequency is not changed.

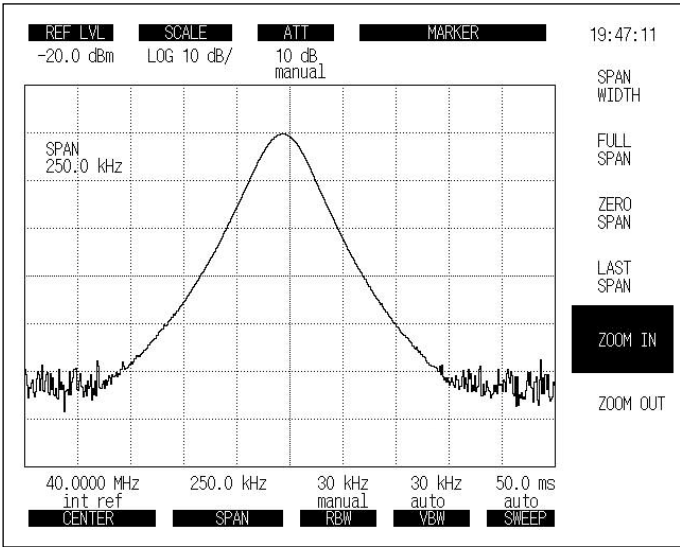
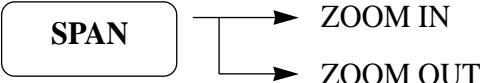

Fig 5-8. Zoom In

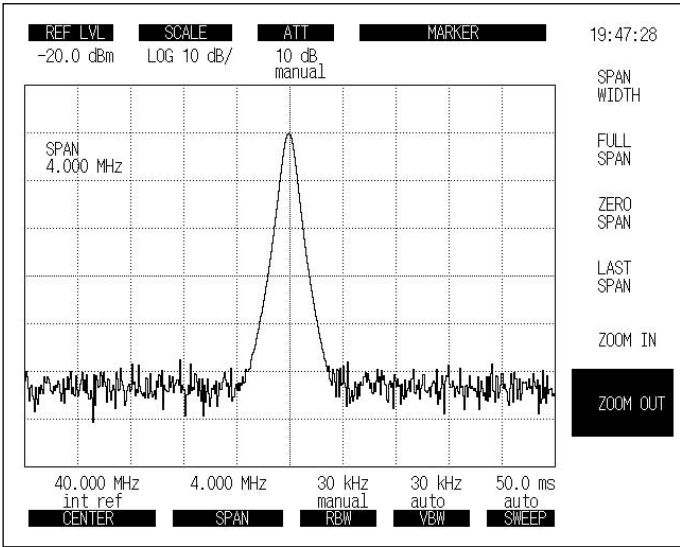
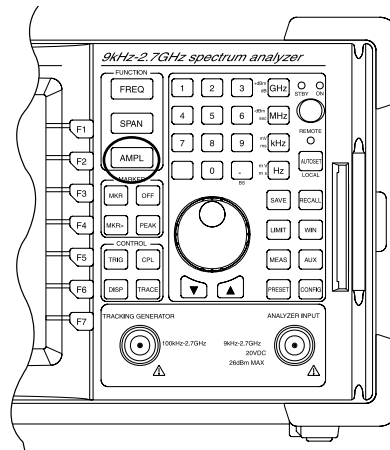

Fig 5-9. Zoom Out

AMPLITUDE FUNCTIONS

The AMPL key is used as the header key for setting the amplitude.



Selecting Log/Linear Detector Mode

To set the amplitude scale to log scale or linear scale, perform the following key operations:

(1) Setting log detector



(2) Setting linear detector

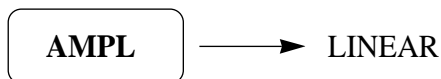

The reference level remains constant, independent of switching between log and linear.

Setting Amplitude Units

In log scale, the 2398 provide the five types of reference level units: dBm, dBmV, dBuV, VOLTS, WATTS.

To select one of the reference level units, perform the following key operations.

The reference level unit used for the linear scale is only in Volts.

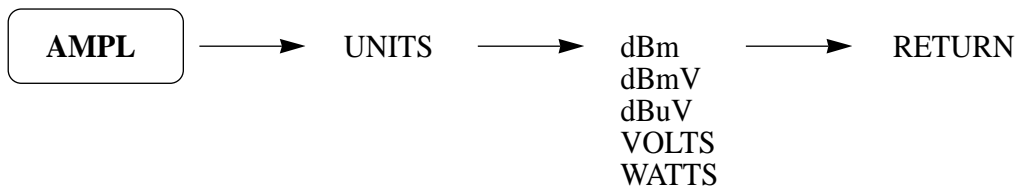

Setting Reference Level

Set the reference level (top graticule) by performing the following key operations:

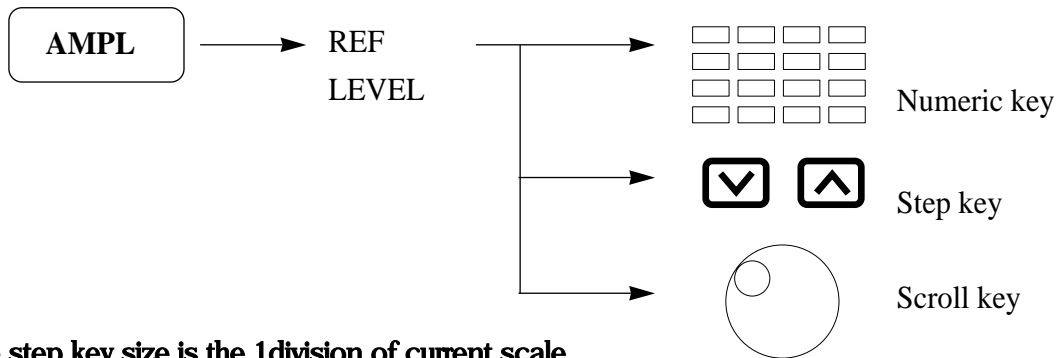

The step key size is the 1 division of current scale.

The scroll key step size is 0.1 dB.

Setting Amplitude Scale

In log scale, the 2398 provides the four scales: 10 dB/, 5 dB/, 2dB/, 1dB/.

In linear scale, the 2398 uses the Full Scale.

To select one of the scales, perform the following key operations:

- Log Detector Mode

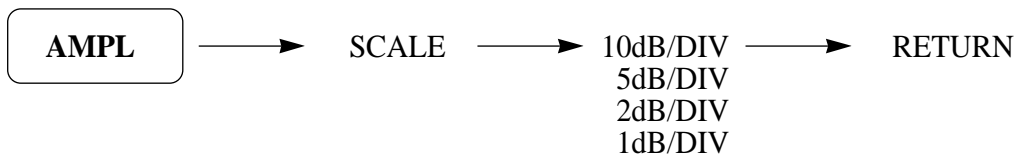

Reference level offset

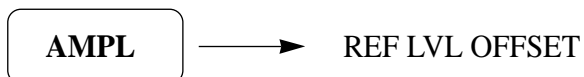

Reference level offset function adds an offset value to amplitude readouts (e.g., reference level and marker amplitude). This function can be useful to account for gains or losses in device connected to the spectrum analyzer. Input range of offset is - 10 dB ~ +10 dB and then only dB units are valid. When offset value is other than 0 dB, "R" is displayed on the left edge of the screen.

Setting Input Attenuation

Perform the following key operation to set the input attenuator level.

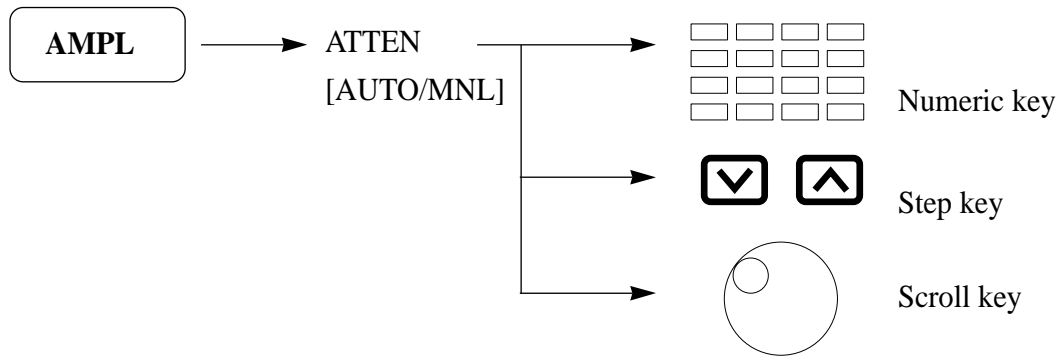

The ATTEN mode [AUTO or MNL] is changed by pressing the ATTEN key.

In ATTEN MNL(manual) mode, the step size can set by the numeric keys, step key and scroll key.

If ATTEN "AUTO" is selected, the input attenuator will be coupled by the current reference level automatically.

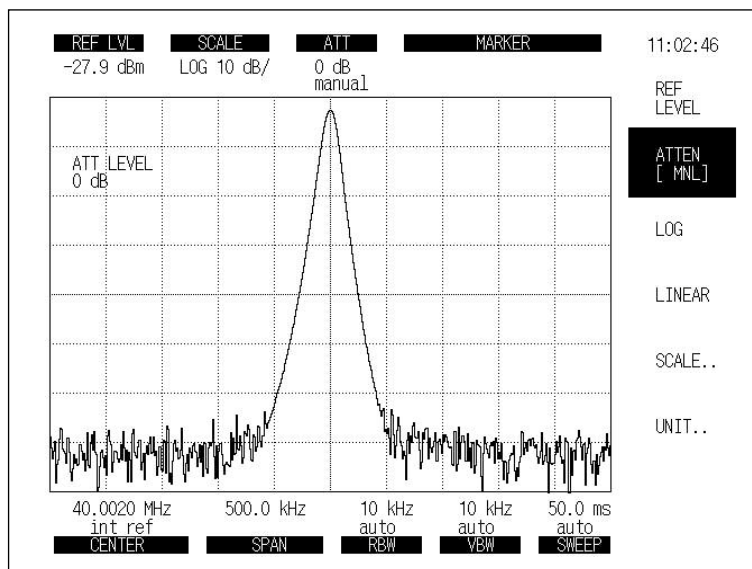
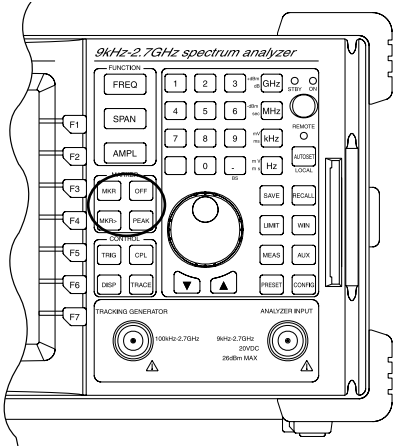

Fig 5-10. Amplitude Function

MARKER FUNCTIONS

The inner key section is used as the header keys for setting the marker functions.
The MKR key is used as the header key to display markers. The OFF key turns the Marker OFF.



Changing Marker Position

Use the step up down key to move the active marker position in 1 division steps.
When the up step key is pressed, the marker position is moved to the right direction.
The down step key direction is left.
The scroll key step size is 1/500 of the horizontal line.

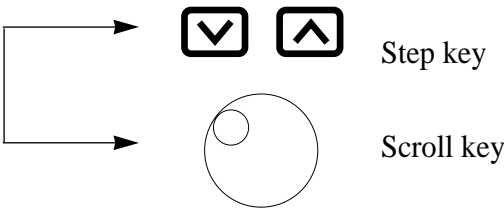

Normal Marker

A single marker is indicated by \diamond on the waveform. The frequency and level at that point are displayed digitally.

The normal marker is initially set to ON. When the current state is another marker mode, or when the normal marker is set to OFF, perform the following key operations to set the normal marker ON.

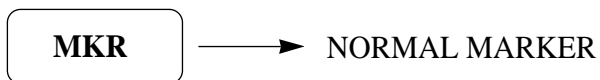

The normal marker displays the absolute amplitude level.

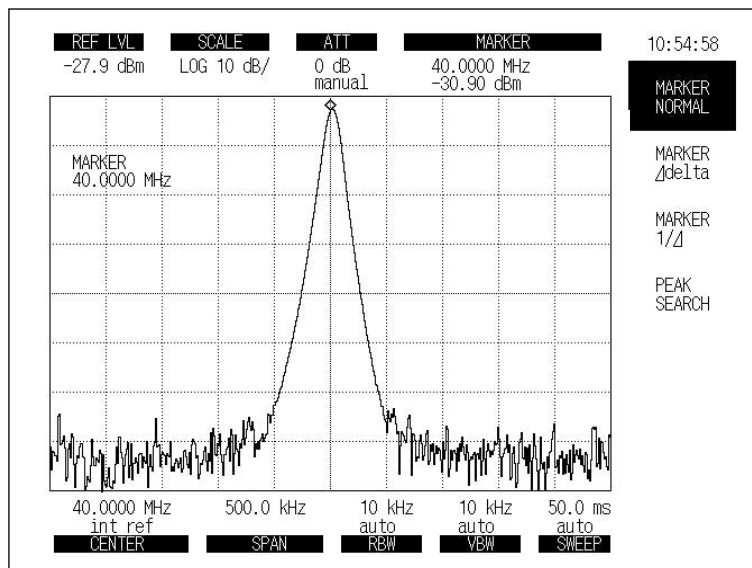

Fig 5-11. Normal Marker

Delta MARKER

The current marker position, when the delta marker is set to ON, is fixed as the reference marker (reference point). Then, as the current marker is moved, the reference marker and the current marker frequency(time) and level differences are displayed digitally as delta marker values.

In the delta marker mode, the reference marker is indicated by ▽.

To set the delta marker to ON, perform the following key operation:

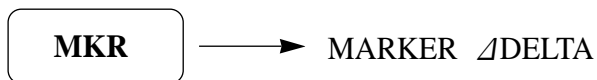

Press the DELTA MARKER key in the delta marker mode. The reference marker moves to the current marker position and switches to the delta marker mode with that as the reference point.

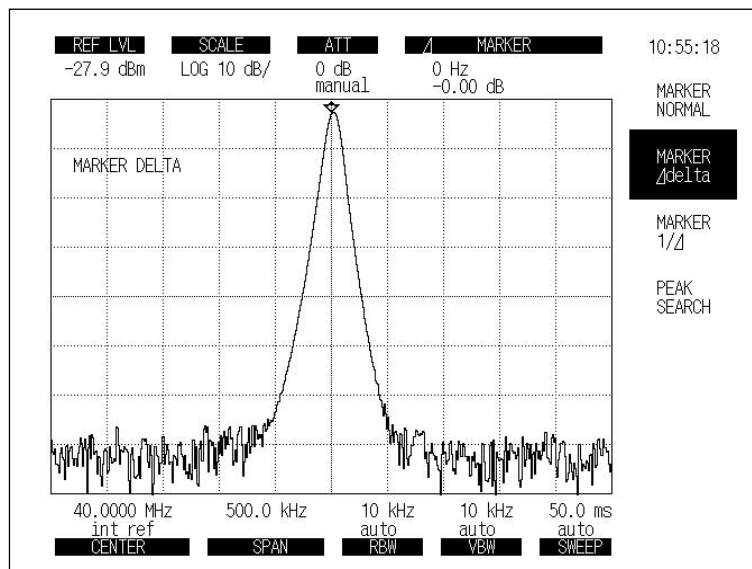

Fig 5-12. Delta Marker

Marker off

The markers are turned off and the softmenu disappears from the screen by the following key operation:



Peak Search Functions

The 2398 has the following four marker search functions :

- Peak Search
- Next Peak Search
- Next Right Peak Search
- Next Left Peak Search

Peak Search

Peak Search detects the maximum level point from the entire trace in which a marker is displayed and moves the marker to that point.

Execute peak search by performing the following key operations:

PEAK

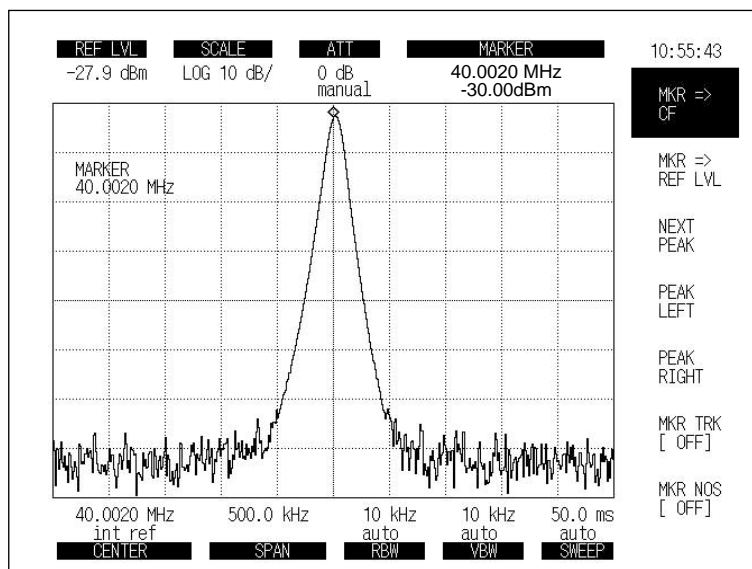
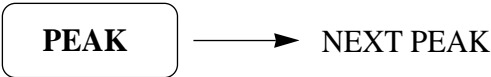

Fig 5-13. Peak Search

Next Peak Search

Next Peak search detects the next largest peak relative to the current marker level and moves the marker to that point. (When there are two or more with same level on the screen, the left most peak is detected.)

Execute Next Peak search by performing the following key operations:



The next largest peak can be detected and the marker can be moved to each of those peaks by executing Next Peak Search consecutively.

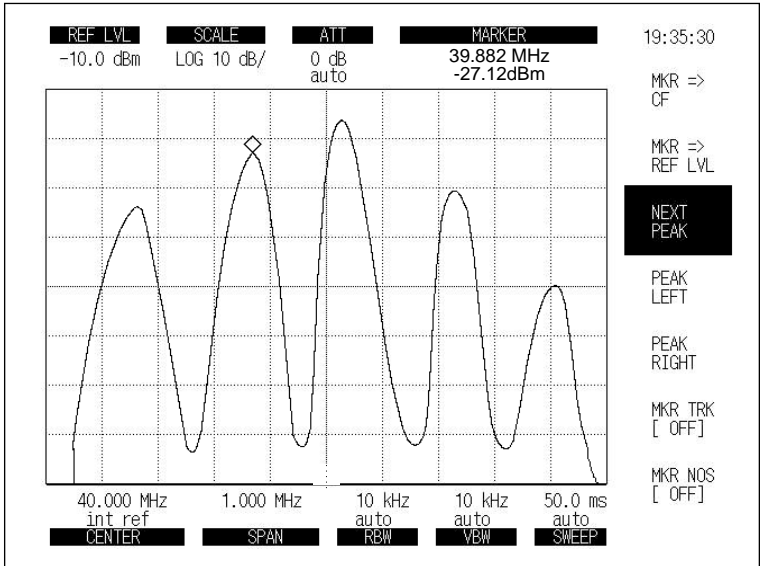
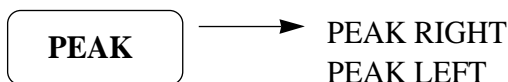

Fig 5-14. Next Peak Search

Peak Left Search/Peak Right Search

PEAK LEFT Search and **PEAK RIGHT** Search detect the adjacent peak level to the right or left of the current marker and move the marker to that point.

To execute **PEAK LEFT** Search and **PEAK RIGHT** Search, perform the following key operations:



The adjacent peak level to the right or left can be detected and the marker moved to that peak by executing **PEAK LEFT** or **PEAK RIGHT** consecutively.

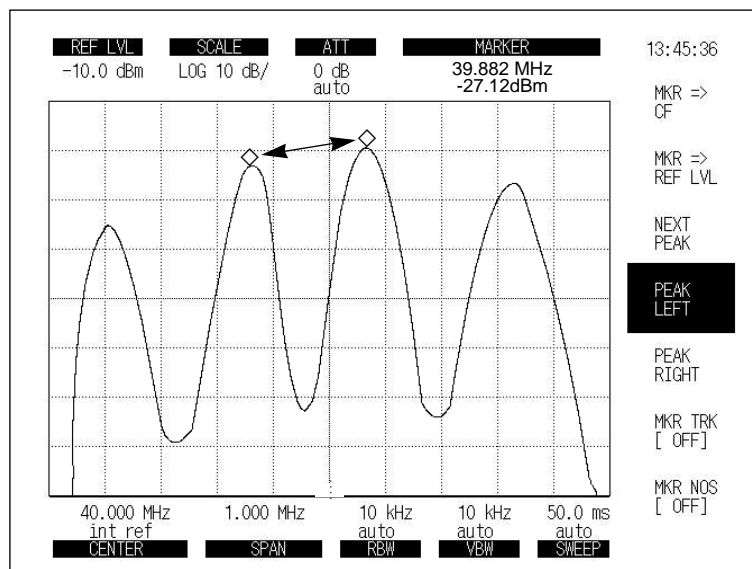
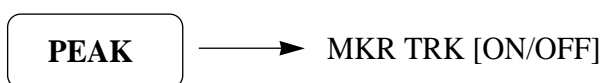

Fig 5-15. Next Peak Search [Left/Right]

Marker Track

When the **Marker Track** is set to **ON**, the maximum level point of the waveform is always moved to the center position of the horizontal axis.

To use **Marker Track**, perform the following key operations:



The **Marker Track** is changed by key pressing the softkey.

Marker Noise

When the Marker Noise is set to ON, the noise power at the current marker point of the waveform is displayed.

The noise power is calculated using the equivalent noise bandwidth of current RBW.

The detection mode is changed to SAMPLE mode.

To use Marker Noise, perform the following key operations:

- 1) Set the delta marker at carrier signal.
- 2) Set the normal marker at noise level of the offset frequency.

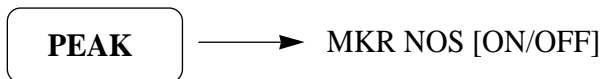

The Marker Noise is changed by pressing the soft key.

SETTING PARAMETERS USING MARKER VALUES

The marker value can be set as the parameter value of the observation frequency, reference level, and so on.

This facilitates the observation of the desired waveform.

To set parameters using the marker value, the following settings are possible:

- MKR - > CF : Sets the marker value to the center frequency.
- MKR - > REF LVL : Sets the marker value to the reference level.
- MKR - > CF STEP : Sets the marker value to the center frequency step size.
- Δ MKR - > CF : Sets the delta marker value to the center frequency value.
- Δ MKR - > CF STEP : Sets the delta marker value to the center frequency step size.
- Δ MKR - > SPAN : Sets the delta marker value to the span.

In time domain, only MKR- >REF LVL is valid.

Setting Parameters Using Marker Values

Sets the current marker frequency or level to the center frequency or the reference level.

To execute the MARKER Shift, perform the following key operations:

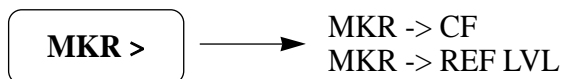

MKR -> CF STEP/MKR DELTA -> CF STEP

Sets the marker frequency to the center frequency step size (resolution determined by up down keys).

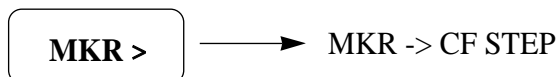

Although this action does not cause any change to appear on the screen, when the center frequency is changed with up down keys, the center frequency is changed with the marker frequency as the step size.

This facilitates observation of harmonics.

Δ MKR -> SPAN

In the delta marker mode, this operation sets the delta marker mode reference marker frequency and current marker frequency to the start frequency and stop frequency, respectively.

MKR ZOOM IN / ZOOM OUT

This function is useable when, the current marker frequency is set to the center frequency.

The MKR ZOOM IN function is to change the current span to half the current span.

The MKR ZOOM OUT function changes the current span to two times the current span.

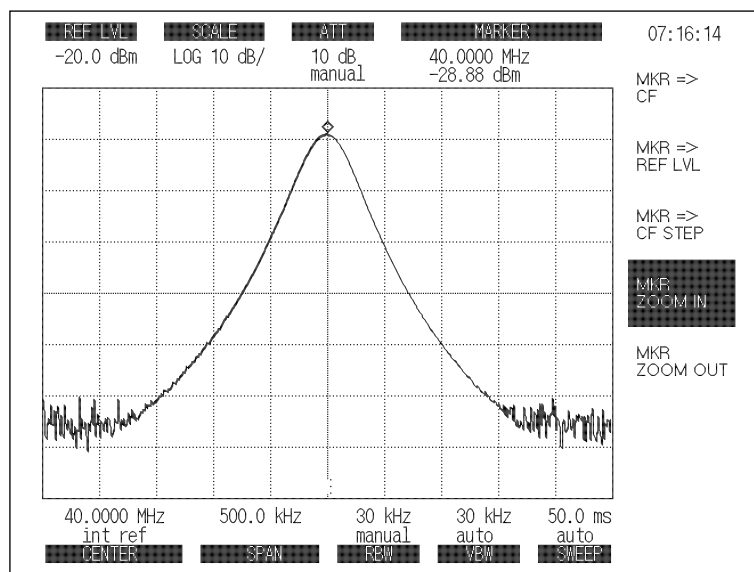

Fig 5-16. Marker Zoom In

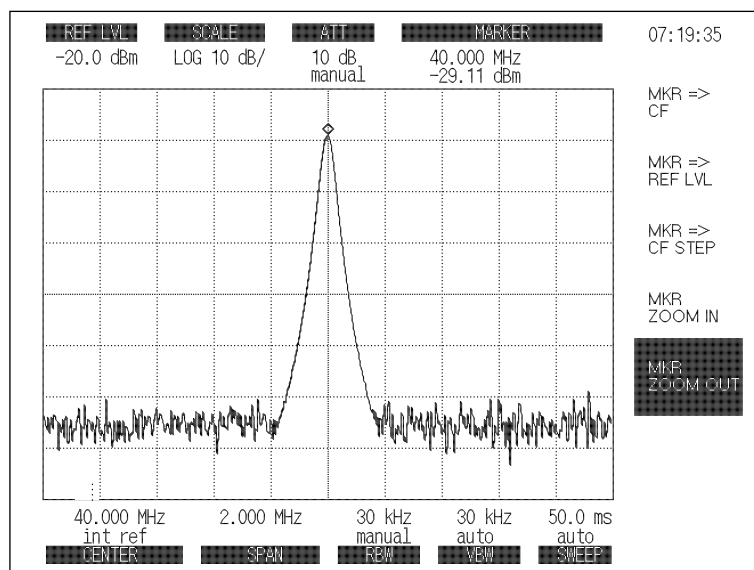

Fig 5-17. Marker Zoom Out

AUTOSET

Pressing the AUTOSET key detects the maximum peak signal and sets that signal frequency and level to the center frequency and reference level.

This key can be used for changing from the remote mode to local mode when the remote LED is lit.

AUTOSET

- Notes :
1. When executing the AUTOSET function, the search frequency range is from 6MHz to 2.7GHz.
 2. All coupled parameters, RBW, VBW, SWEEP TIME, ATT are set automatically.
 3. Normal Marker appears on the screen.
 4. After conclusion of the AUTOSET function, the frequency span is 1 MHz.

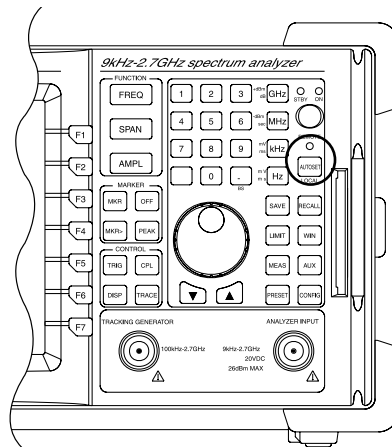

TRACE FUNCTIONS

The TRACE key is the header key for the trace function.

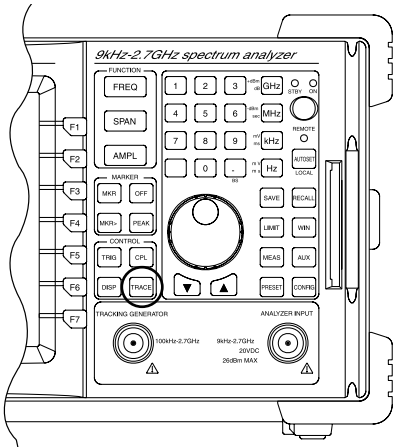

When the TRACE key is pressed, the following soft menu is displayed on the screen.

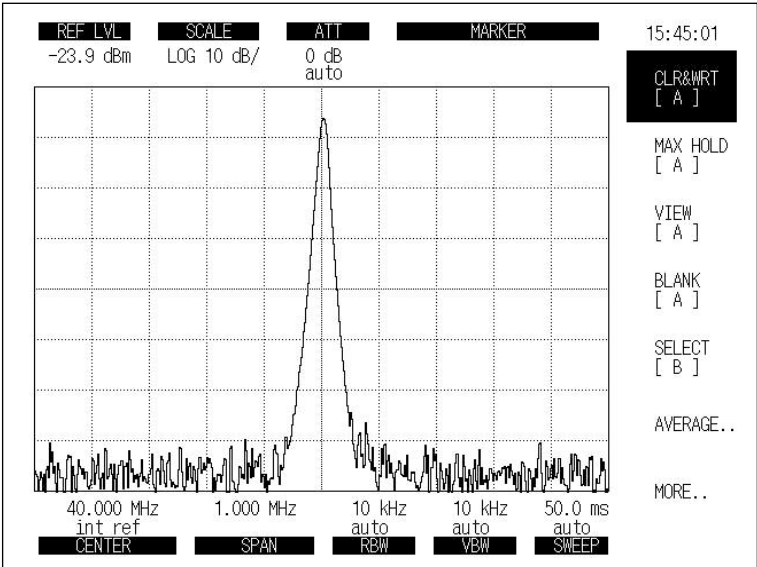
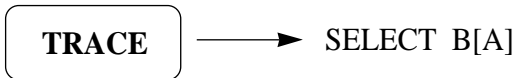

Fig 5-18. Trace Function

Select Trace

The analyzer provides two Trace Memories, A and B.

The active trace memory is selected by the following key operations:

**CLR & WRT A[B]**

The current trace memory is A[B]. The data will be cleared and written by the new data at the trace memory by pressing the key.

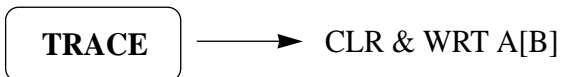
**MAX HOLD A[B]**

On each sweep, the new data for each horizontal point is compared with previous data.

The unit stores and displays the level with the larger value.

Thus the display accumulates the maximum values for each point.

When this key is pressed again, the MAX HOLD function restarts again.

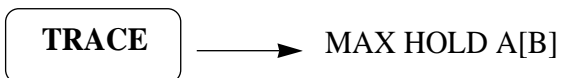
**VIEW A[B]**

When this key is pressed, the A[B] Trace leaves the normal write mode.

The unit stops the LCD writing operation and displays the contents of the A[B] memory.

To return to the normal write mode, push CLR&WRT again.

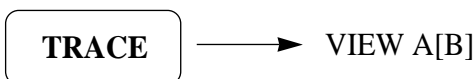
**BLANK A[B]**

When this key is pressed, trace data is erased from the screen, but the contents of the memory still remain.

The trace can be redisplayed by selecting VIEW function.

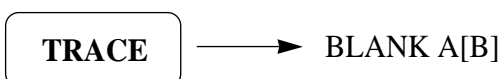

Computation

To use the trace computation, perform the following key operation:
Display the computation and moving soft menu.

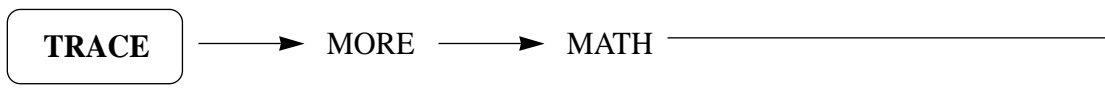

- ➔ **A- B- >A** : The result A memory contents become the difference between the original A memory, or the sweep data, and the B memory. That is, if Trace A is in the VIEW or BLANK mode, the difference is taken between the A and B memories, and the result stored in A. But if Trace A is in the CLR&WRT mode, the current sweep result has B memory data subtracted from it, and is stored in A.
- ➔ **B- DL- >B** : When Trace A is in the VIEW or BLANK mode, it subtracts the Display Line from the B memory data, and saves the result in B. But when Trace B is in the CLR&WRT mode, it subtracts the Display Line from the current sweep result, and saves the result in B.
- ➔ **A+B- >A** : Adds Trace A and Trace B, displays the result as Trace A.
- ➔ **A- B+DL- >A** : Turns on the mode that subtracts Trace B from Trace A, adds the Display Line and displays it on Trace A.
- ➔ **A EXCH B** : Exchanges the contents of Trace A memory and Trace B memory.
- ➔ **RETURN** : Returns to the previous menu.

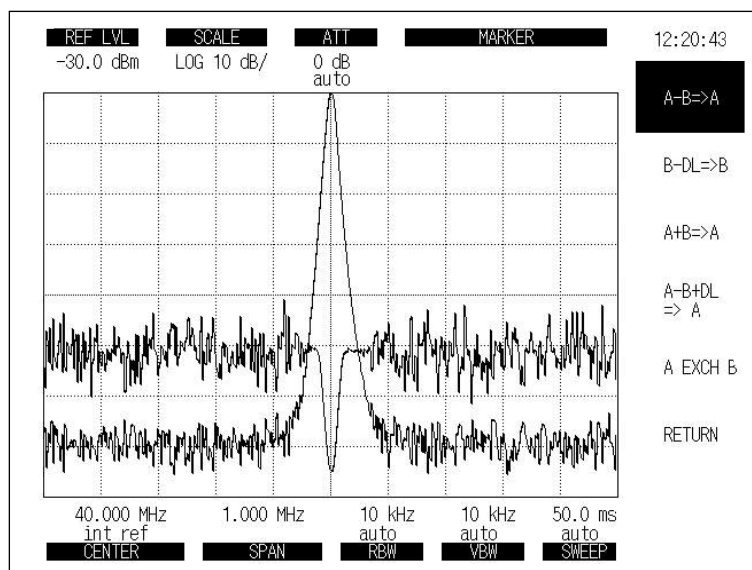

Fig 5-19. Trace Computation

Detection Mode

The 2398 provides the following five detection modes.

- NORMAL
- SAMPLE
- POS PEAK
- NEG PEAK
- AVERAGE

Select the detection mode by performing the following key operation :

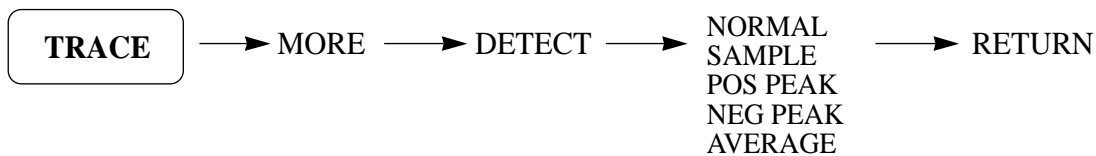

The 2398 uses the oversampling method to acquire video data.

This method does not lose valid data in case the RBW is less than the frequency cell. The NORMAL detection mode is similar to the POS PEAK/NEG PEAK Detection mode.

The odd number horizontal line displays the maximum value among oversampling data for 1 display point.

The even number horizontal line displays the minimum value among oversampling data for 1 display point.

But in case the NORMAL detection mode, the signal do not miss because the even number of the horizontal line is changed from the minimum detection mode to the maximum detection mode.

The SAMPLE detection mode stores the instantaneous signal level at each sample point to the trace memory.

The SAMPLE detection mode is primarily used for noise level measurement, and time domain measurement.

The POS PEAK detection mode compare the maximum level point present between the current display point and next display point, then stores the maximum value in the trace memory corresponding to the current display point.

The NEG PEAK detection mode compares the minimum level point present between the current display point and next display point, then stores the minimum value in the trace memory corresponding to the current display point.

The NEG PEAK detection mode is often used to measure the lower envelope side of a modulated waveform.

The AVERAGE detection mode is used to reduce the random noise level without reducing the video filter or using the trace average function. This allows averaged displays with faster sweep rates.

The AVERAGE detection mode stores the average data between POS Peak and NEG Peak for each data cell.

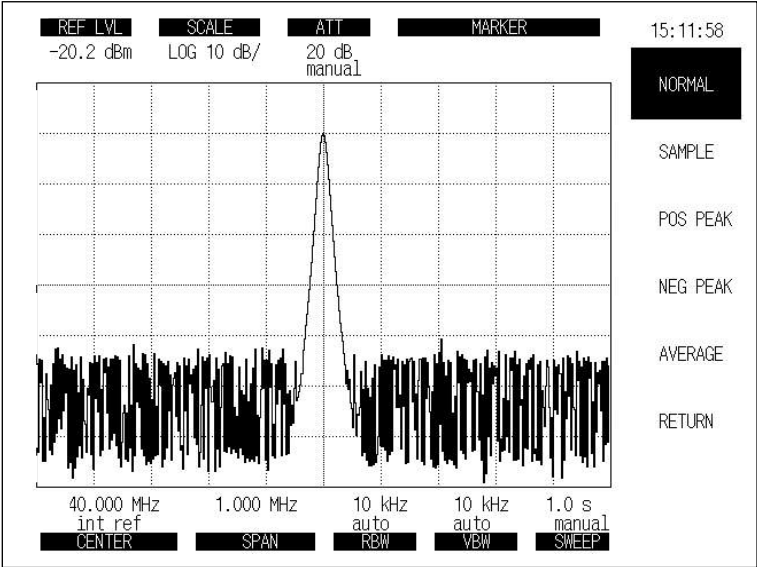
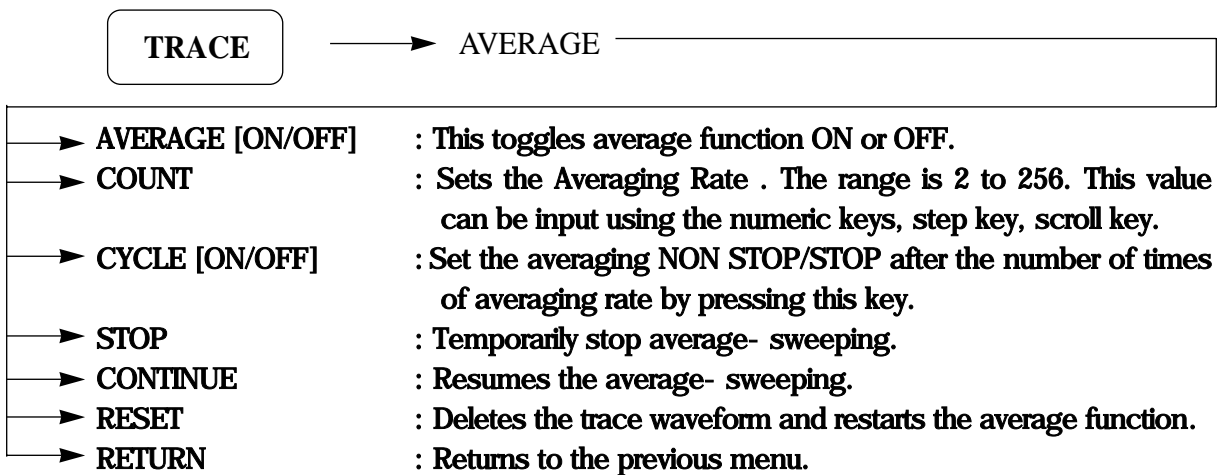

Fig 5-20. Detection Mode

Averaging Function

The digital averaging function calculates the average data at each vertical axis point for each sweep and displays the results.

The averaging function improves the S/N ration depending on the averaging rate and the number of sweep repetitions. To use the averaging function, perform the following key operations:



Notes regarding the use of the Averaging Function.

To specify the average count, input the number of samples using numeric key and unit key.

The default average value is 8.

Averaging by video filter has the disadvantage that the sweep time becomes longer when the video bandwidth is narrowed to improve the averaging effect.

On the other hand, digital video averaging smoothes the trace display by averaging the digital data after analog to digital conversion at each sweep, without narrowing the video bandwidth(VBW). Since the video bandwidth(VBW) gets comparatively wider and the time required for each sweep can be shortened, the entire spectrum image can be verified quickly and a repetitive sweep can be stopped when the required smoothing has been obtained.

The problem of averaging with the video filter is that the time required for smoothing each sweep becomes longer and it takes a long time to verify the entire spectrum image.

DISPLAY FUNCTIONS

The 2398 provides functions related to the screen display, such as Display line, Threshold line, Screen Title, contrast control and so on.

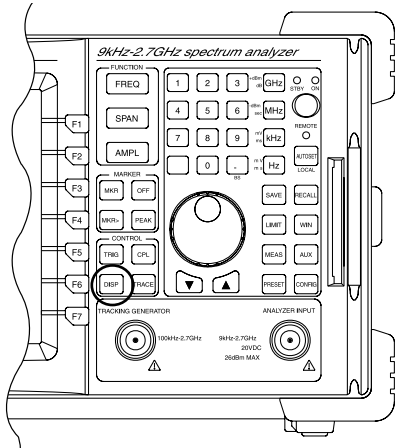

Display Line

The Display Line is a horizontal cursor line that runs across the screen for making level comparisons. It can be set between the reference level and the lowest level with the numeric key or step key or scroll key. In the OFF setting, the display line disappears from the screen.

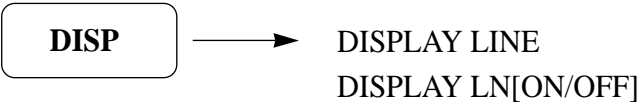

The step size of the step up down key is 1 division of the vertical range. The step size of the scroll key is 0.1 dB.

Threshold line

The Threshold Line is a horizontal line such that the waveform is displayed above the threshold line. It can be set between the reference level and the lowest level with the numeric keys or step keys or scroll key. In the OFF setting, the threshold line disappears from the screen.

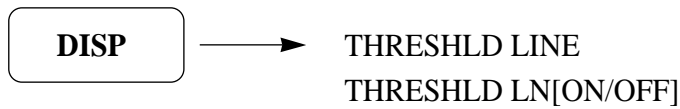

The step size of the step up down keys is 1 division of the vertical range.
The step size of the scroll key is 0.1 dB.

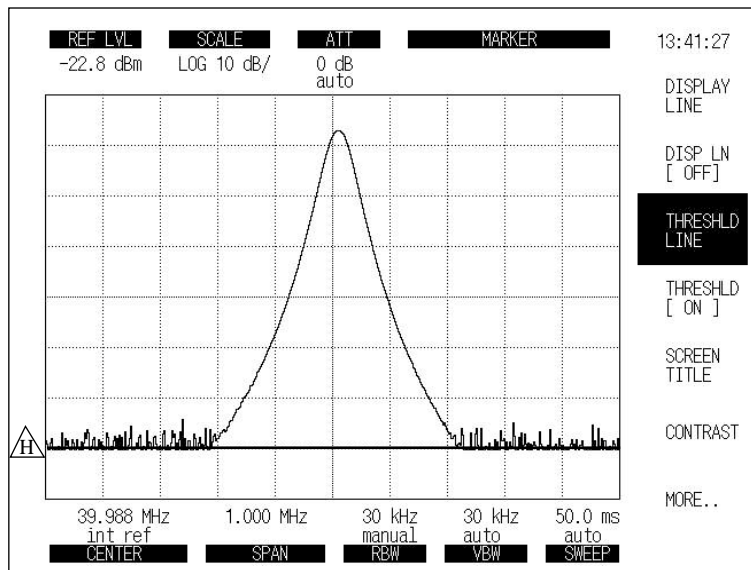
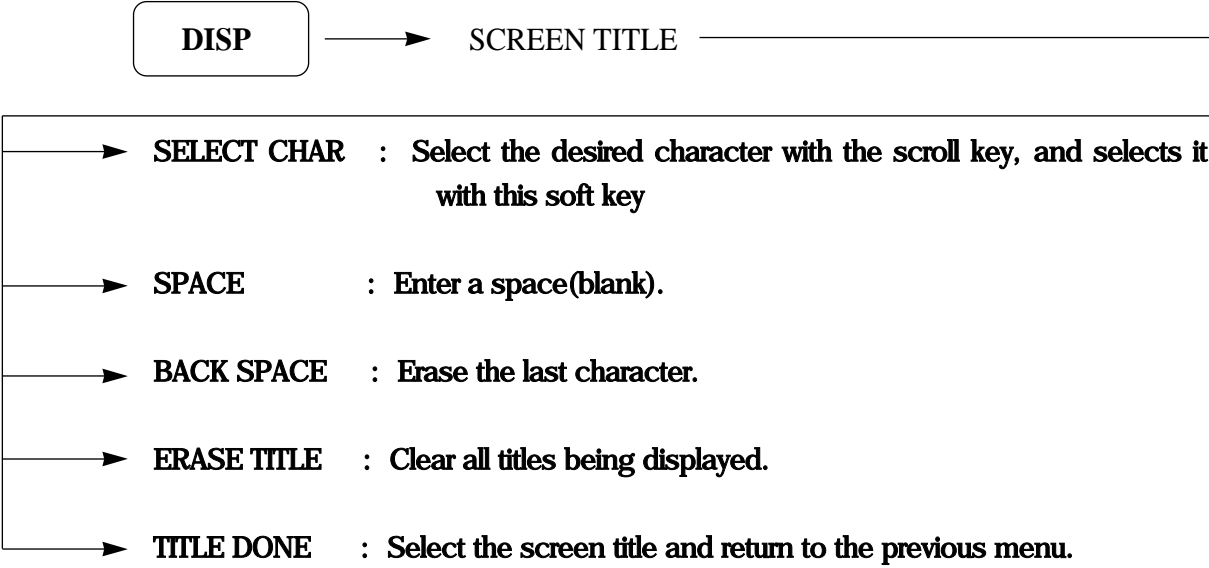

Fig 5-21. Display Function

Screen Title

A title of display spectrum or waveform can be labeled with this function.
The input screen title can be used for a printer and memory function.
To make the screen title, perform the following key operations:
When SCREEN TITLE softkey is pressed, characters are displayed.



Contrast

To change the LCD contrast level, perform the following key operations:

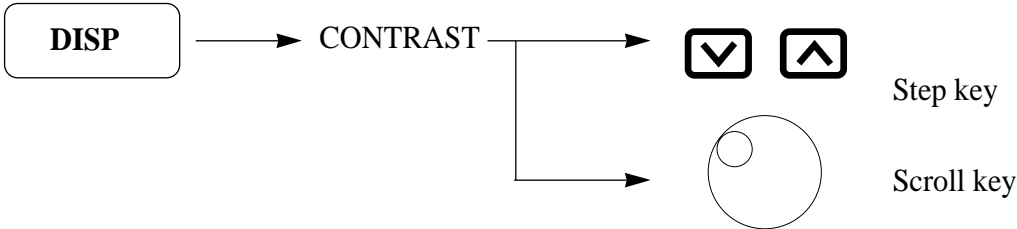

To decrease the LCD contrast level, press the step down key or turn the scroll key counterclockwise.
To increase the LCD contrast level, press the step up key or turn the scroll key clockwise.

GRAT [ON / OFF]

This key toggles the graticule ON or OFF.

To delete the graticule on the screen, perform the following key operations:



ANNOT[ON / OFF]

This key annotation toggles ON or OFF.

To delete the annotations on the screen, perform the following key operations:

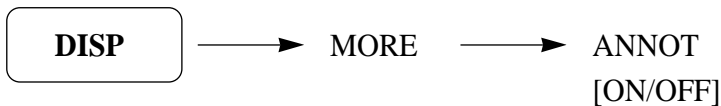

Annotations are identified below:

T : Triggered Mode

S : Single Sweep Mode

INVERSE [ON/OFF]

This key toggles video inversion ON or OFF.

To invert the background color and the trace waveform , press the following key operations:



TRIGGER FUNCTIONS

The TRIG key is the header key for using the trigger function.

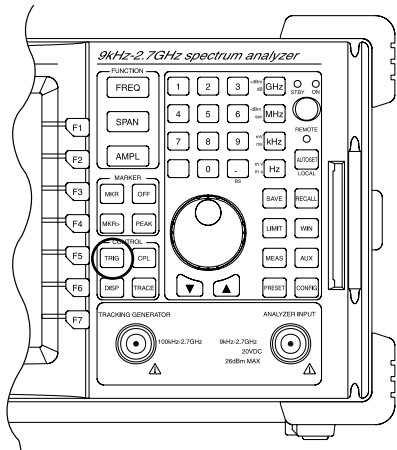

Continuous Sweep Mode

When the trigger mode is set to FREE RUN, the sweep is executed continuously. When the trigger mode is set to Triggered (Trigger source is not FREE RUN), the sweep is executed each time the trigger conditions are met.

To set the continuous sweep mode, press the following keys:

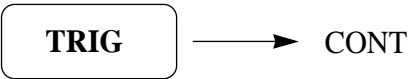

Single Sweep Mode

When the trigger mode is set to FREE RUN, the sweep is executed once immediately after the SINGLE key is pressed. When the trigger mode is set to Triggered (Trigger source is not FREE RUN), the sweep is executed only once when the trigger conditions are met.

To set the single sweep mode, press the following keys:



Triggered Mode

The 2398 trigger mode can be divided into FREE RUN and TRIGGER.

In the Triggered mode, VIDEO, LINE or EXTERNAL can be selected as the trigger source.

Trigger Source

To select the TRIGGER SOURCE, perform the following key operations:

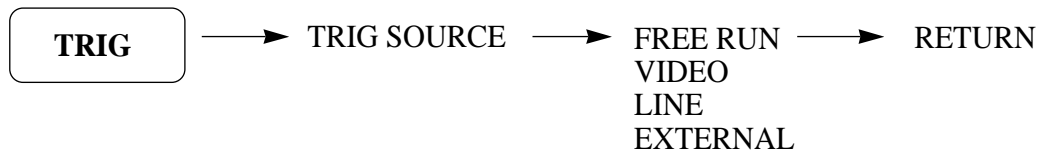

Trigger Filter

The 2398 trigger circuit has two trigger filters : High Pass Filter and Low Pass Filter.

The default setting is Low Pass Filter.

- LPF cutoff frequency : 100kHz
- HPF cutoff frequency : 5 Hz

The TRIGGER FILTER mode may be changed by pressing the softkey.

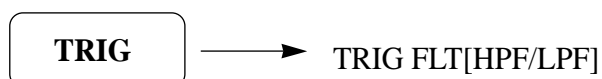

Trigger Level

When the VIDEO(ZERO SPAN) Trigger source is selected, the sweep is started in synchronization with the positive leading edge of the detected waveform that is greater than trigger level.

To select trigger level, perform the following key operations.



The trigger level is controlled by the step up- down key, and the scroll key.

The trigger level is indicated by displaying the trigger level line on the screen.

Line Trigger

This function starts sweep in synchronization with AC power line frequency. Line trigger is conveniently used to observe power line- related waveforms. With the line trigger function, the trigger level and trigger filter are not active.

External Trigger

This function starts sweep in synchronization with the external trigger source. Sweep is started in synchronization with the positive leading edge of the signal waveform input to the EXT TRIG input connector on the rear panel. Trigger execution requires TTL input signals.

Trigger Delay

When the trigger mode is set to Triggered mode (Trigger source is selected as VIDEO, EXT or LINE only) the trigger point is usually positioned at the left end of the screen. However, this means that it is not possible to see the waveform before the trigger point and the waveform beyond the right end of the screen. With the 2398, a waveform before(or after the end of the display) the trigger point can be displayed by changing the delay time. NOTE : TRIGGER DELAY WORKS IN 0- SPAN MODE ONLY. To set the delay time, perform the following key operations:

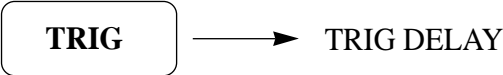

The delay time is set using numeric keys, the scroll key and the step up down key in zero span mode. A minus value of delay time means the Pre- Trigger mode is used. A plus value of the delay time means the Post- Trigger mode is used.

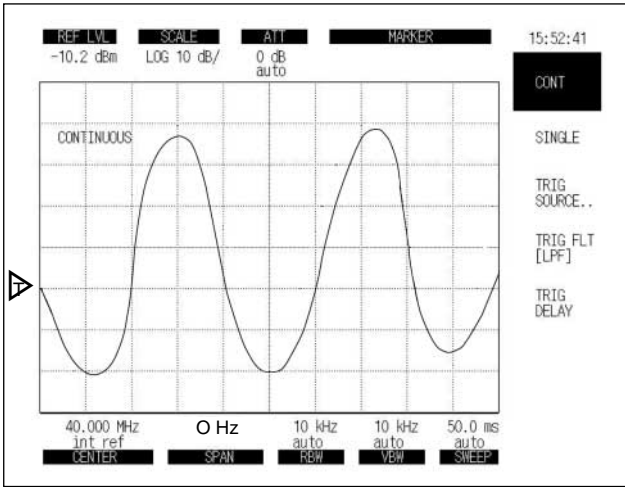
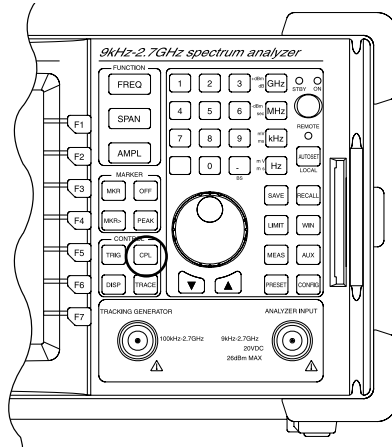

Fig 5-22. Trigger Function

COUPLED FUNCTIONS

The four functions of RBW, VBW, Sweep Time and Input Attenuation are initially set to AUTO so the 2398 can automatically select the optimum setting. There are two hard keys related to the Coupled function : CPL and AMPL.



All Auto Function

The coupled function has two modes. One is the Auto mode, the other one is the Manual mode. In order to operate the Auto Mode, perform the following key operations.

CPL → ALL AUTO

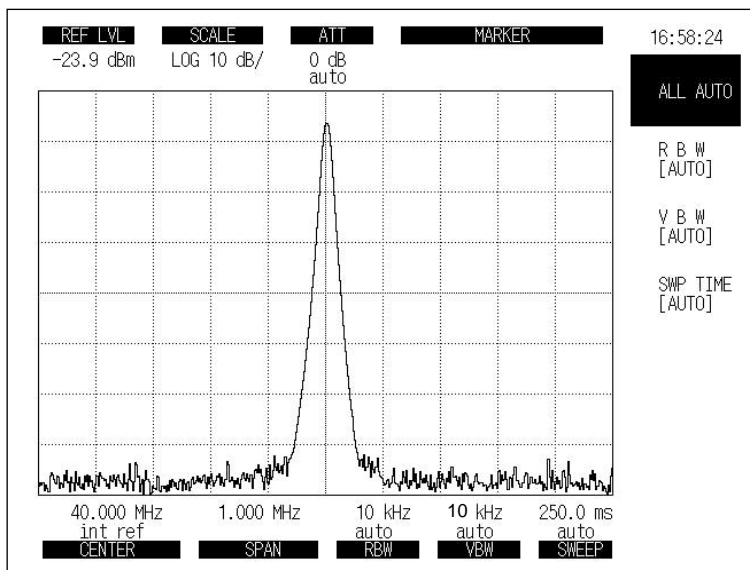

Fig 5-23. Couple Function

RBW and Sweep Time

(1) Auto Mode

The RBW, Sweep Time, and VBW parameters are set to Auto so that even if the frequency span is varied, the respective parameters are automatically set to the optimum values so frequency and level measurement errors do not occur.

The following shows the Auto Sweep Time Range:

- Lower limit range : 50msec
- Upper limit range : 1000sec

The following table shows the RBW,VBW, and sweep time for various span ranges.

Frequency Span	RBW	VBW	SWEEP TIME
1kHz to 9.9kHz	300Hz	300Hz	The sweep time is calculated using the Span, RBW,VBW values to obtain the lowest sweep time while maintaing accuracy.
10kHz to 99.9kHz	1kHz	1kHz	
100kHz to 299.9kHz	3kHz	3kHz	
300kHz to 999kHz	10kHz	10kHz	
1MHz to 1.99MHz	10kHz	10kHz	
2MHz to 4.99MHz	30kHz	30kHz	
5MHz to 5.99MHz	30kHz	30kHz	
6MHz to 19.99MHz	100kHz	100kHz	
20MHz to 59.9MHz	300kHz	300kHz1	
60MHz to 199.9MHz	1MHz	MHz	
200MHz to more	3MHz	1MHz	

(2) Manual Mode

In order to select the manual mode of operation for RBW and/or sweep time, perform the following key operations:

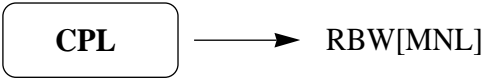

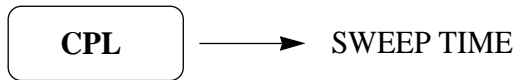
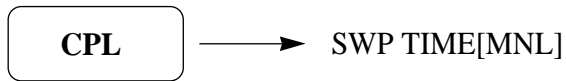

Video Bandwidth(VBW)

To set the VBW, perform the following key operations:



(1) Auto Mode

When VBW is set to AUTO, the VBW is set according to the RBW value.

(2) Manual Mode

When wanting to average the noise by making the VBW narrow without regard to RBW set value, or when wanting to make the VBW wide to observe the waveform of signals modulated at a high frequency, use MANUAL setting.

The VBW value can be manually set to one of the following values.

[10Hz, 30Hz, 100Hz, 300Hz, 1kHz, 3kHz, 10kHz, 30kHz, 100kHz, 300kHz, 1MHz, NONE]

Note: When $VBW \geq RBW$ is set, noise is not averaged and the sweep speed is increased.

Input Attenuator

To set the input attenuator, perform the following key operations:

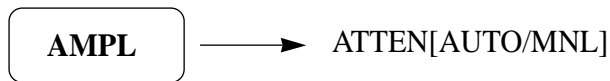

1) Auto Mode

While Auto is selected, the input attenuator is Automatically set to optimum value according to the reference level.

Reference Level Range	Attenuation Auto
+ 30dBm to + 20.1dBm	50
+ 20dBm to + 10.1dBm	40
+ 10dBm to 0.1dBm	30
0dBm to - 9.9dBm	20
- 10.0dBm to - 19.9dBm	10
- 20dBm to - 110dBm	0

(2) Manual Setting

When a signal is input with the same level as the reference level, the input attenuator value in the AUTO mode is controlled so that high accuracy measurements can be made without being influenced by gain compression and the noise level can be reduced.

However, when you want to measure a low level signal by raising the sensitivity, set the input attenuator manually as shown in the table below:

Reference Level Range	Attenuation Manual Level
+ 30dBm to - 60dBm	50
+ 30dBm to - 70dBm	40
+ 20dBm to - 80dBm	30
+ 10dBm to - 90dBm	20
0dBm to - 100dBm	10
- 10dBm to - 110dBm	0

A small input attenuator value can be used when the RF input level is - 10dBm or less.

CONFIGURATION

The system parameters of the 2398 can be set depending on the user objective. The CONFIG hard key is the header key related to set system configuration.

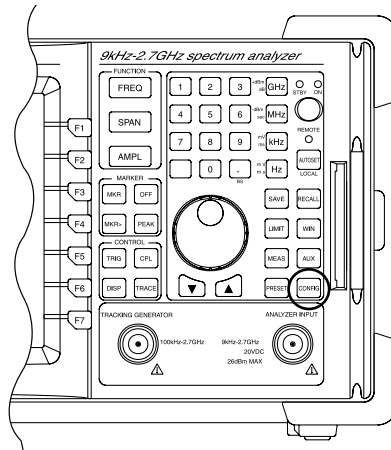

Hard Copy

This key is used for hard copy using the printer. In order to print the current display, perform the following key operations.

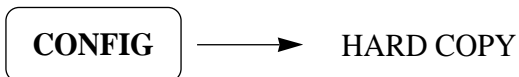

Printer type

The 2398 supports the following.

- HP Laser Jet Printer
- PCMCIA(BMP FILE SAVE) - OPTION

To select the printer, perform the following key operations:



RS-232C Configuration

The system can be remotely controlled using an RS- 232C interface.

To set up RS- 232C protocol, perform the following key operations:

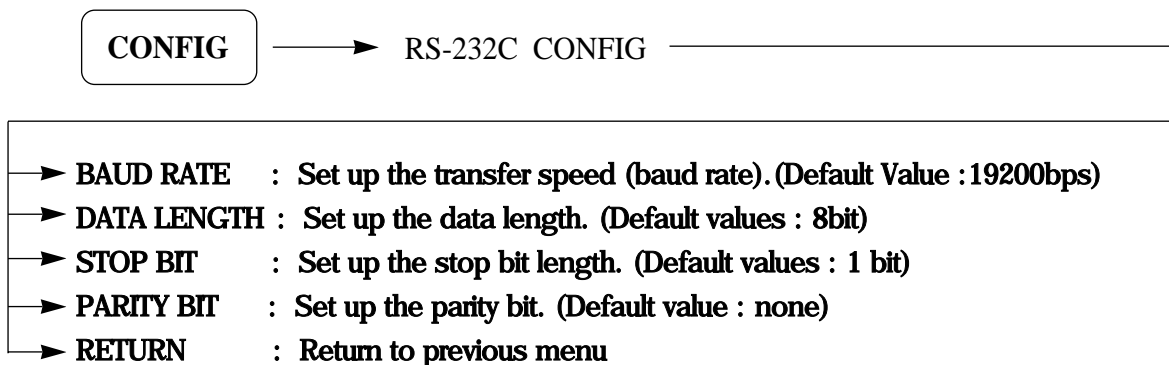

GPIB Address

To set up GIPB configuration, perform the following key operations:

The GPIB address set up can be done using the step key or the scroll key.

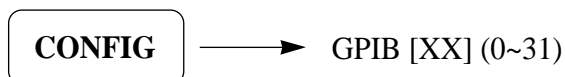

Clock Set

Set the date and time by performing the following key operations:

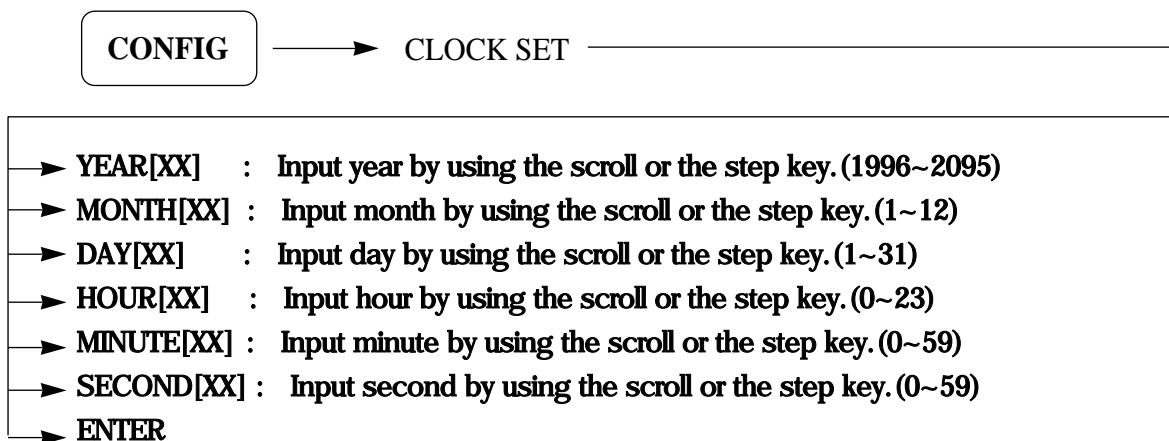

10M REF [INT / EXT]

The system reference oscillator(10MHz) is selected by this key.
This key toggles between INT or EXT Status.

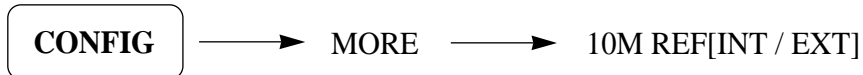

When INT is selected, the internal reference oscillator is selected.
When EXT is selected, the frequency accuracy is defined by the external reference oscillator connected to the 10MHz reference frequency signal input terminal of the analyzer rear panel.

BEEP [ON / OFF]

Menu beep sound is selected by this key.
This key toggles ON or OFF status.



Version information

When this key(F5) is pressed, display software information.

PCMCIA Memory Card Function (option)

The PCMCIA memory card option is selected.
Memory cards are used for backing up the current setup/configuration , waveform data, and mask data bitmap(BMP) files.

Memory Card Requirements:

- 1) Corresponds to the PCMCIA Release 2.0 Type I
- 2) The following memory types only are available:
 SRAM type.
- 3) Format type:
 MS- DOS Format.
- 4) Memory size:
 64kB, 128kB, 256kB, 512kB, 1MB, 2MB.

Memory Card Initialization

New or unused memory cards should always be initialized before use.

- (1) Turn the write protect off of the card to be initialized.
 Caution : If a memory card containing data is reinitialized all data will be destroyed.
- (2) Insert the memory card.
- (3) Perform the following key operations for memory card initialization:

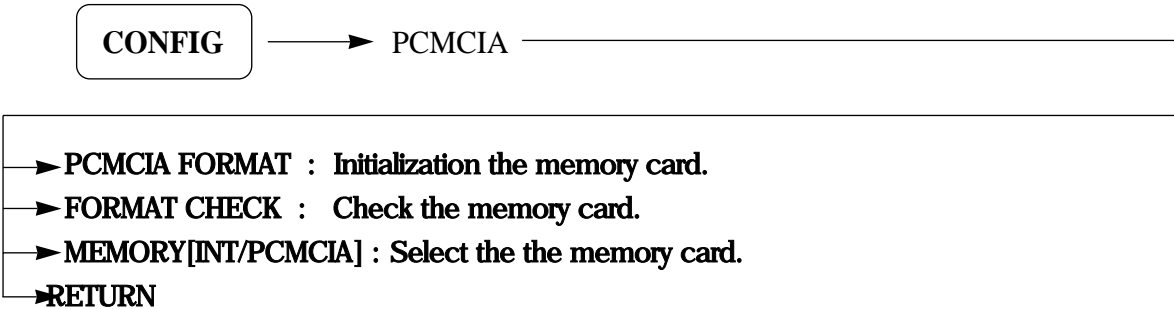

SAVE AND RECALL FUNCTIONS

The 2398 can save the setup conditions (Parameters) and waveform data(Trace) to an internal register or memory card(option). This data can be recalled and used.

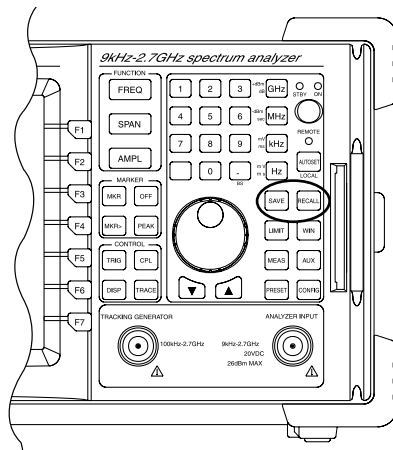

Internal Register

The internal register uses RAM with battery back- up in the 2398

The internal registers can save the following data and waveform:

- A. Unit Setting conditions : 10ea
- B. Trace A waveform : 10ea
- C. Trace B waveform : 10ea
- D. Limit Line : 10ea

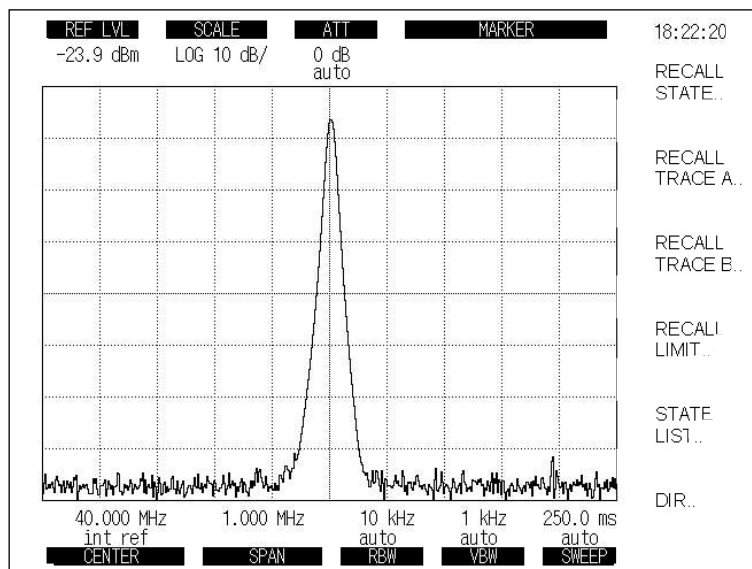
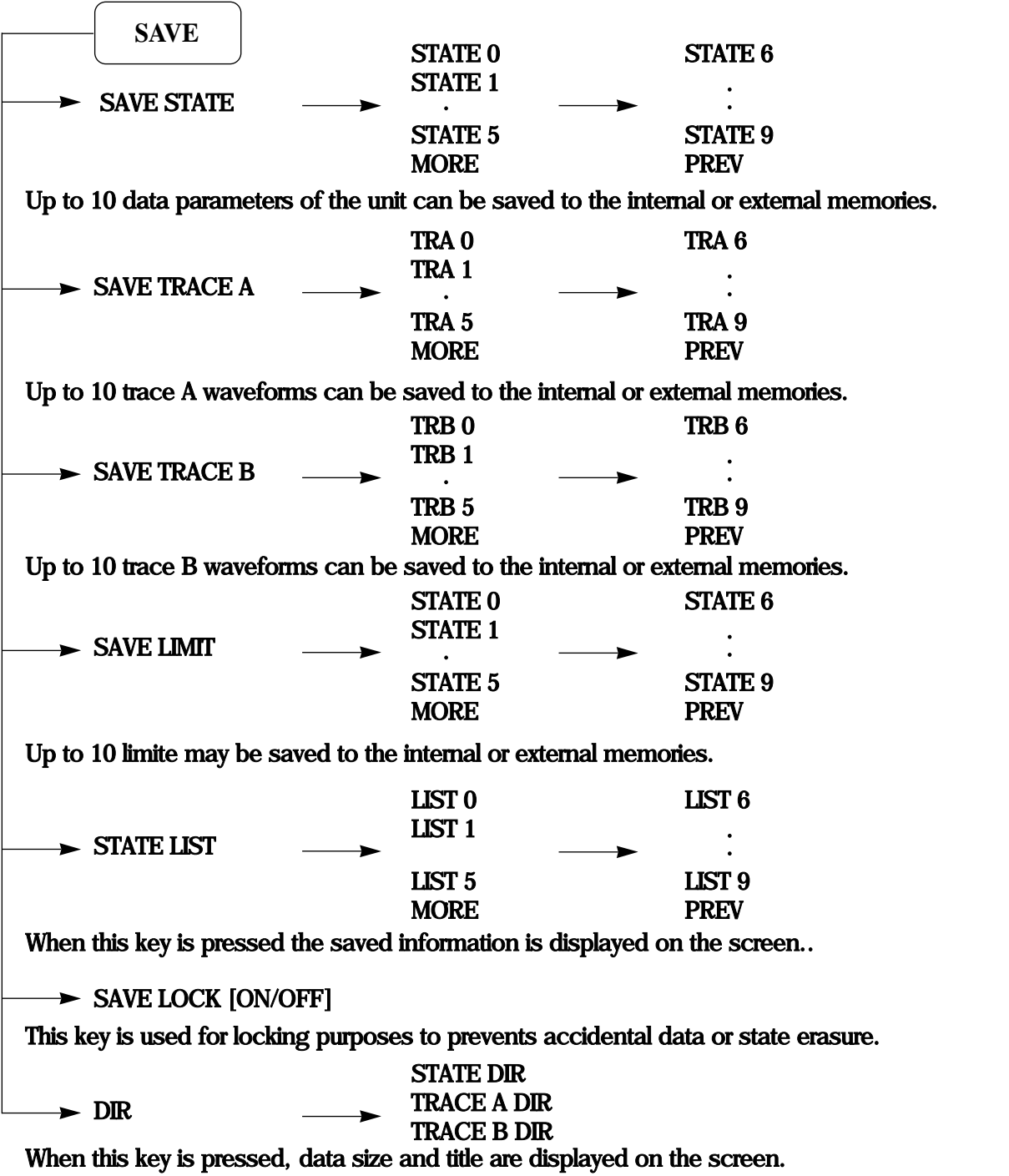

Fig 5-24. Save Function

Save Parameters and Waveform

The SAVE key is the header key for saving parameters and waveforms. To save the current parameters, waveform data and title to the internal register or memory card, perform the following key operations:



Recall Parameters and Waveform

To recall stored parameters, waveforms, and title from the internal register or memory card, perform the following key operations.

The RECALL key is the header key for recalling parameters and waveforms.

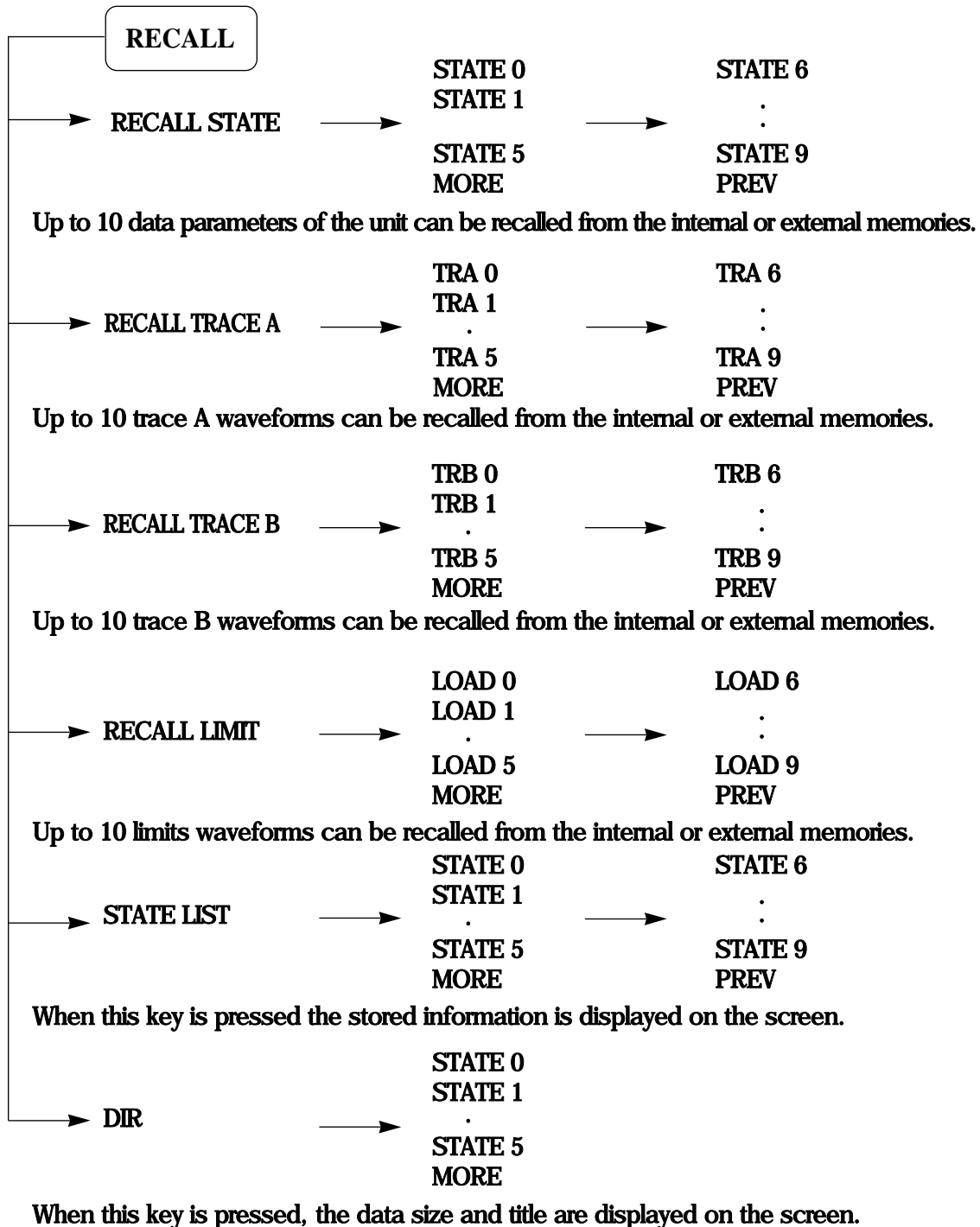

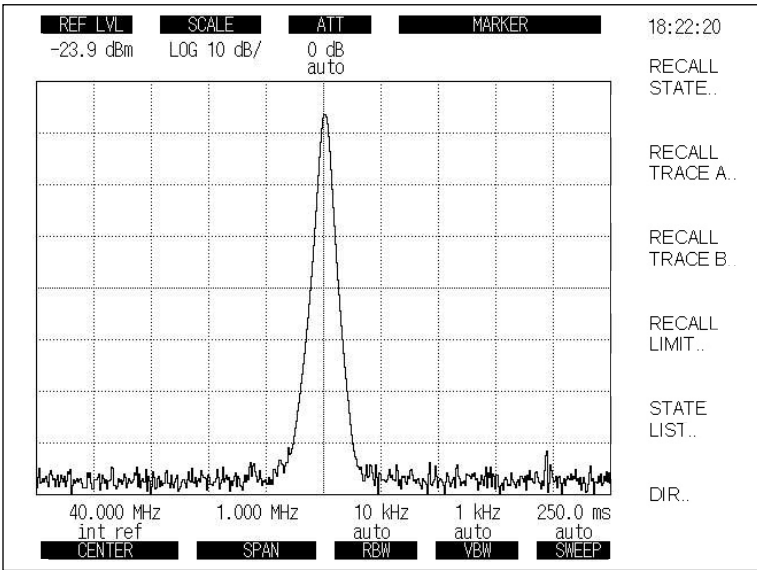

Fig 5-25. Recall Function

MEASUREMENT FUNCTIONS

The 2398 provides the following 4 measurement functions:

- X dB Down measurement
- Occupied bandwidth measurement
- Marker Frequency Counter
- EMC measurement (option)

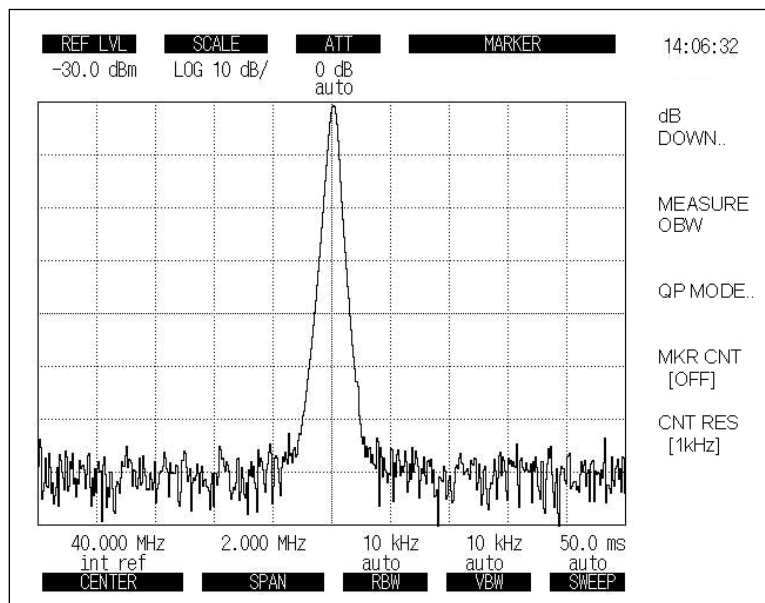
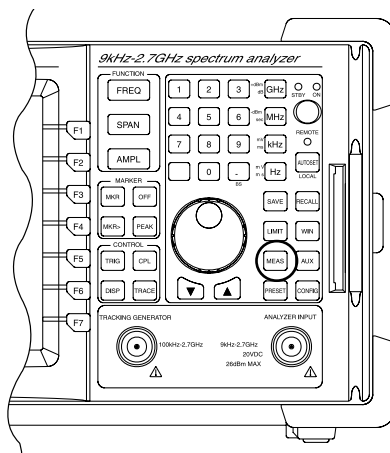

Fig 5-26. Measurement Function

X dB Down Measurement

The X dB Down function displays the difference in frequency (and level) between a reference marker and another marker that is X dB down (or up) from the reference.

The relative dB range that can be specified for X from the screen dynamic range is selected using the step key or scroll key. The default value is 3 dB.

To use the X dB Down measurement function, perform the following key operations:

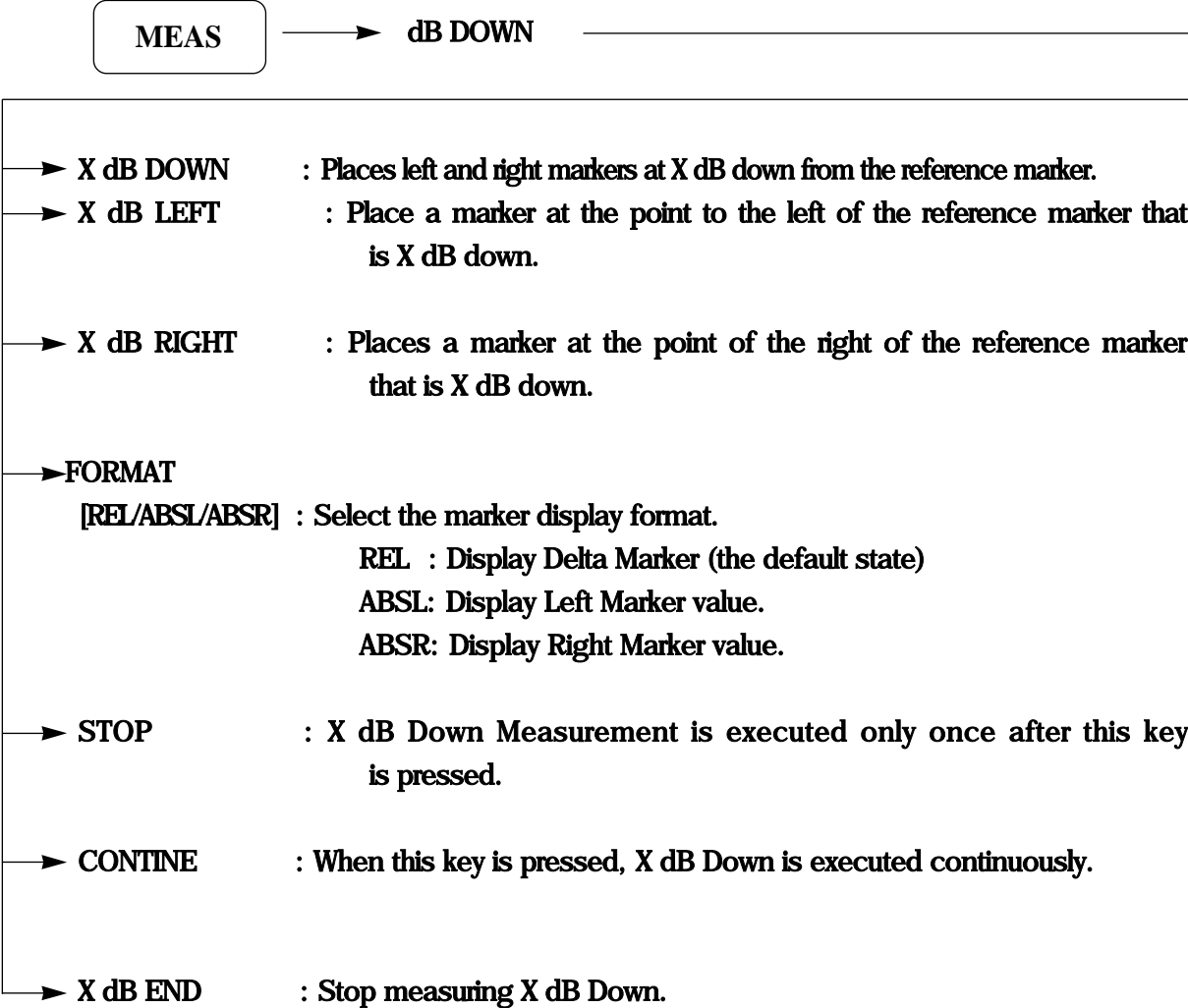

Occupied power Bandwidth measurement

Locate the occupied bandwidth of the signal being displayed on the screen.

The results are shown in the marker display area for the occupied bandwidth(OBW), the occupied band carrier frequency(Fc), and the band center frequency.

The 2398 has an OBW function that can be calculated from the measurement data displayed on the screen. It works by finding the frequency band that contains a specified percentage of the total power. The default value is 10%, and measurement range between 10% and 99.8% can be specified.

OBW Measurement Procedure

- (1) Set the center frequency & normal marker to the known carrier frequency and set the frequency span resolution bandwidth (RBW), and sweep time to AUTO.
- (2) Set the detection mode to SAMPLE detector.
- (3) Calculate the Occupied Bandwidth by performing the following key operations:

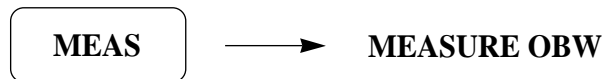

When the calculation is complete, the occupied bandwidth (Fc is actually the occupied band center frequency) appear at the left of the display. “x” markers are set at both side of the occupied band to indicate the band endpoint frequencies.

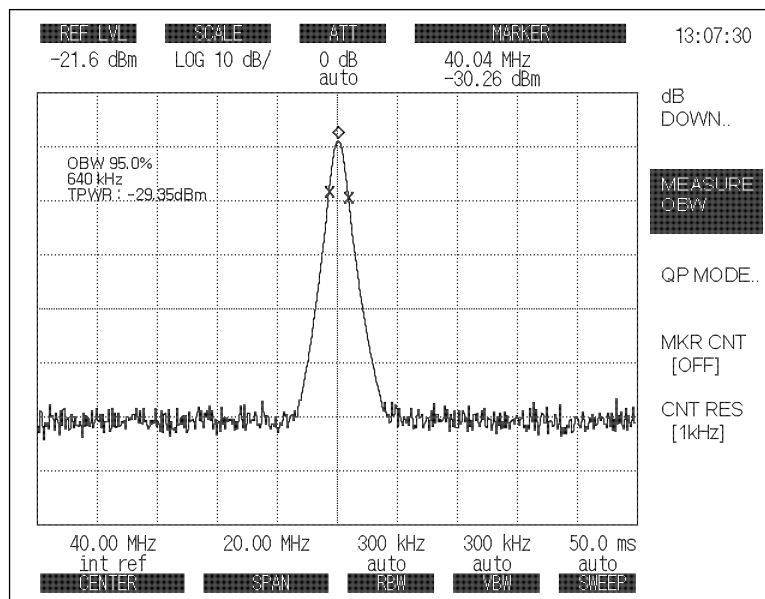
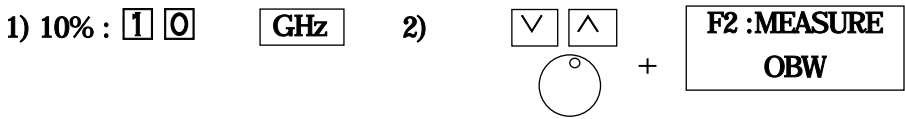

Fig 5-27. OBW Function

- (4) To change the ratio between the power contained in the occupied and the total power first find the OBW, then use the numeric keys to set a new percentage. The band markers will be adjusted automatically.
- (5) On the screen, TPWR is Total Power.

Change Value



Marker Counter

To use the marker counter function, perform the following key operations. When the marker counter function is selected, the waveform update rate is slow because the count gate is needed for count resolution and accuracy.

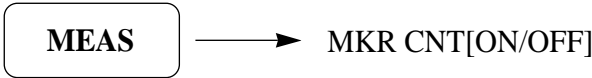

The COUNT mode is toggled ON or OFF by pressing this key. Perform the following key operations to select counter resolution.

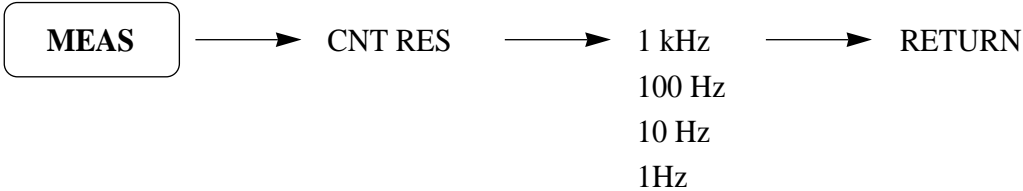

QP EMC Measurement (option)

Set the Quasi- peak detection mode as required by the CISPR specification for ElectroMagnetic Compliance.

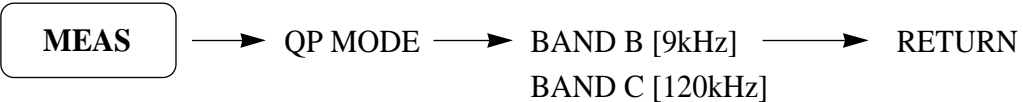

To use Quasi Peak Detection Mode, perform the following key operations: When the QP detection mode is selected, the scale of the analyzer is set to 5dB/DIV, and the VBW is set to OFF automatically.

Channel Power

Channel Power measures power in a given channel bandwidth. Channel bandwidth is determined using the center frequency in the screen.

Channel Power Measuring

- (1) When channel bandwidth key[F1] is pressed, calculates channel power with the current channel bandwidth at the end of the current sweep.
- (2) When channel bandwidth is changed using step key, knob or numeric key, calculates channel power with the new channel bandwidth at the end of the current sweep.
- (3) When calculates channel power, SAMPLE detection is used.

Set up condition to measure channel power

- (1) center frequency : center frequency of channel
- (2) RBW : $RBW < 0.025 \times \text{Channel Bandwidth}$
- (3) VBW : $10 \times RBW$
- (4) Sweep time : AUTO
- (5) SPAN : $SPAN = 2 \times \text{Channel Bandwidth}$
- (6) Detect mode : SAMPLE
- (7) Scale : log mode

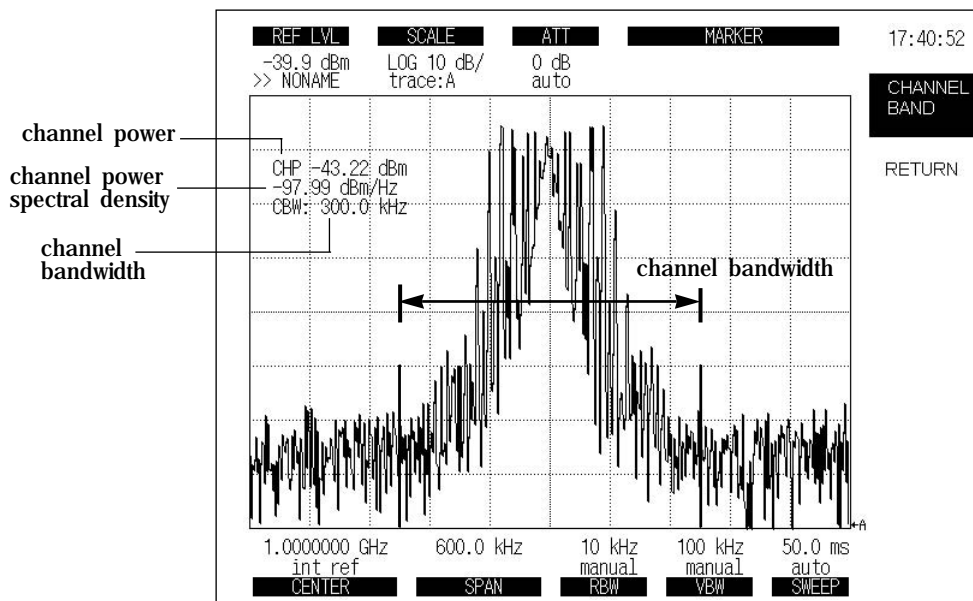

Fig. 5-28. Channel Power Function

ACP(Adjacent Channel Power)

ACP(Adjacent Channel Power) measures the channel interference with channels(lower band channel & upper band channel) in multi- channel communication systems.

For measuring ACP, channel bandwidth & spacing is determined using the center frequency in the screen.

ACP Measurement

- (1) When the ACP key[F1] is pressed, calculates ACP with the current channel bandwidth & spacing at the end of the current sweep.
- (2) When calculates ACP, SAMPLE detection mode is used.

Set up condition to measure ACP

- (1) center frequency : center frequency of carrier channel
- (2) RBW : $RBW < 0.025 \times \text{Channel Bandwidth}$
- (3) VBW : $10 \times RBW$
- (4) Sweep time : AUTO
- (5) SPAN : $SPAN > 2 \times \text{Channel Spacing} + \text{Channel Bandwidth}$
- (6) Scale : log mode

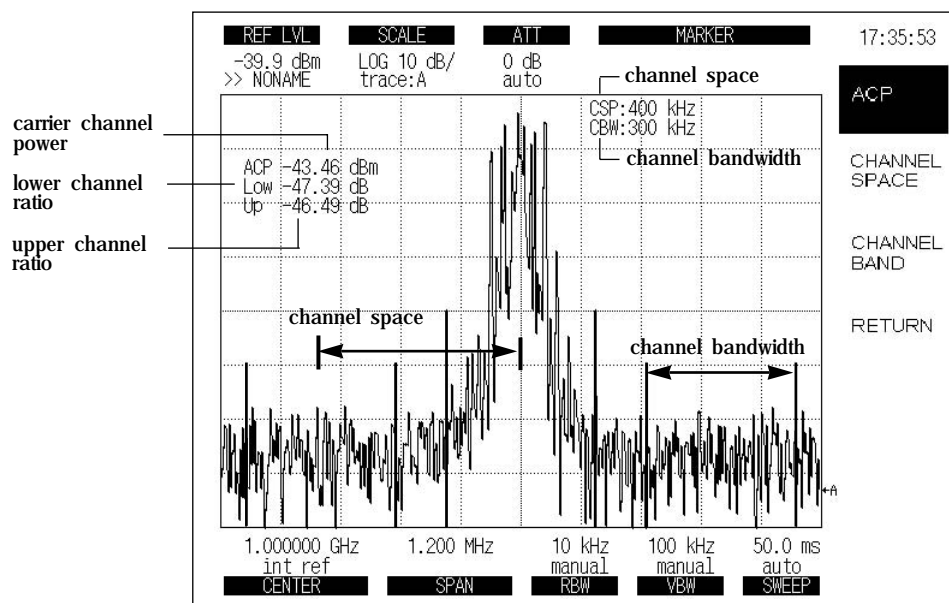

Fig. 5-29. ACP Function

DEMODULATION AND AUDIO FUNCTIONS

The 2398 provides analog demodulation and audio monitor functions.

- AM Demodulation
- FM Demodulation
- Audio ON/OFF, Audio level control, Squelch function
- Tracking Generator ON/OFF, Output level control

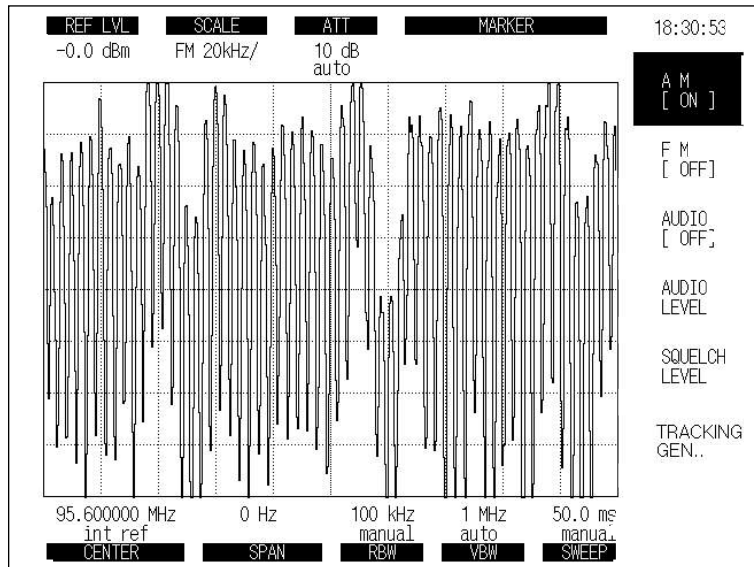
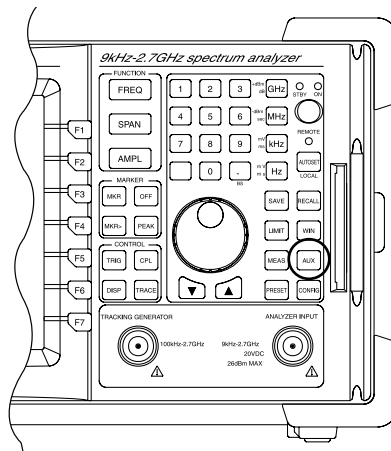

Fig 5-30. AUX Function

AM Demodulation

The AM demodulation function displays the amplitude demodulated waveform.

By pressing this key, the horizontal axis changes to the time axis.

The carrier frequency is the center frequency.

To use AM demodulation function, perform the following key operations:

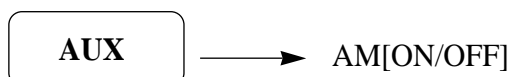

This key toggles AM demodulation ON and OFF.

In AM scale, the 2398 provides the five scales: 25[%]/DIV, 20[%]/DIV, 10[%]/DIV, 5[%]/DIV, 2.5[%]/DIV.

To select ON of the scale, perform the following key operations:

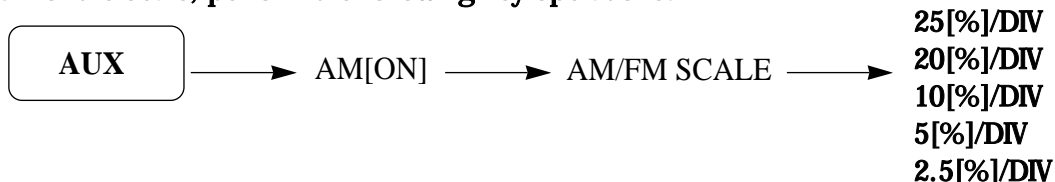

FM Demodulation

The FM demodulation function displays the frequency demodulated waveform.

By pressing this key, the horizontal axis changes to the time axis.

The carrier frequency is the center frequency.

To use FM demodulation function, perform the following key operations:

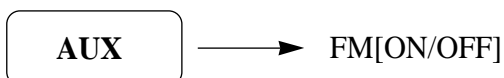

This key toggles FM demodulation ON and OFF.

In FM scale, the 2398 provides the six scales: 25[kHz]/DIV, 20[kHz]/DIV, 10[kHz]/DIV, 5[kHz]/DIV, 2.5[kHz]/DIV, 1[kHz]/DIV.

To select ON of the scale, perform the following key operations:

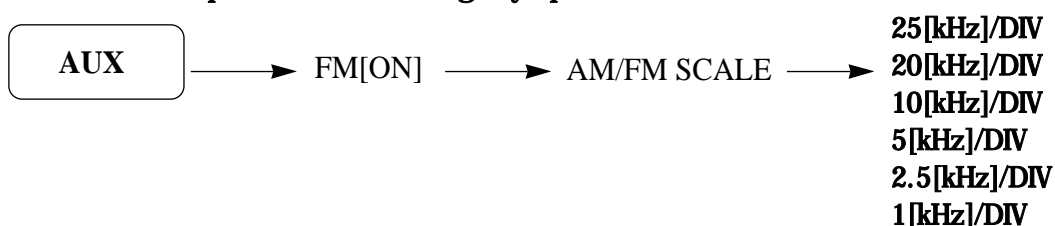

Audio Monitor

The 2398 has an internal speaker and phone jack at the rear panel.

The AUDIO ON/OFF is used to turn ON the internal speaker.

The AUDIO LEVEL is used to control the audio level which can be adjusted by the step UP/DOWN key or scroll key. The audio level has 8 steps(0~7). The default value is 3.

The SQUELCH key is used for the squelch function. It has 256 levels which can be adjusted by step UP/DOWN key and scroll key. The default value is 127.

TRACKING GENERATOR(option)

The 2398 has an optional Tracking Generator.

To set up the Tracking Generator. perform the following key operation:

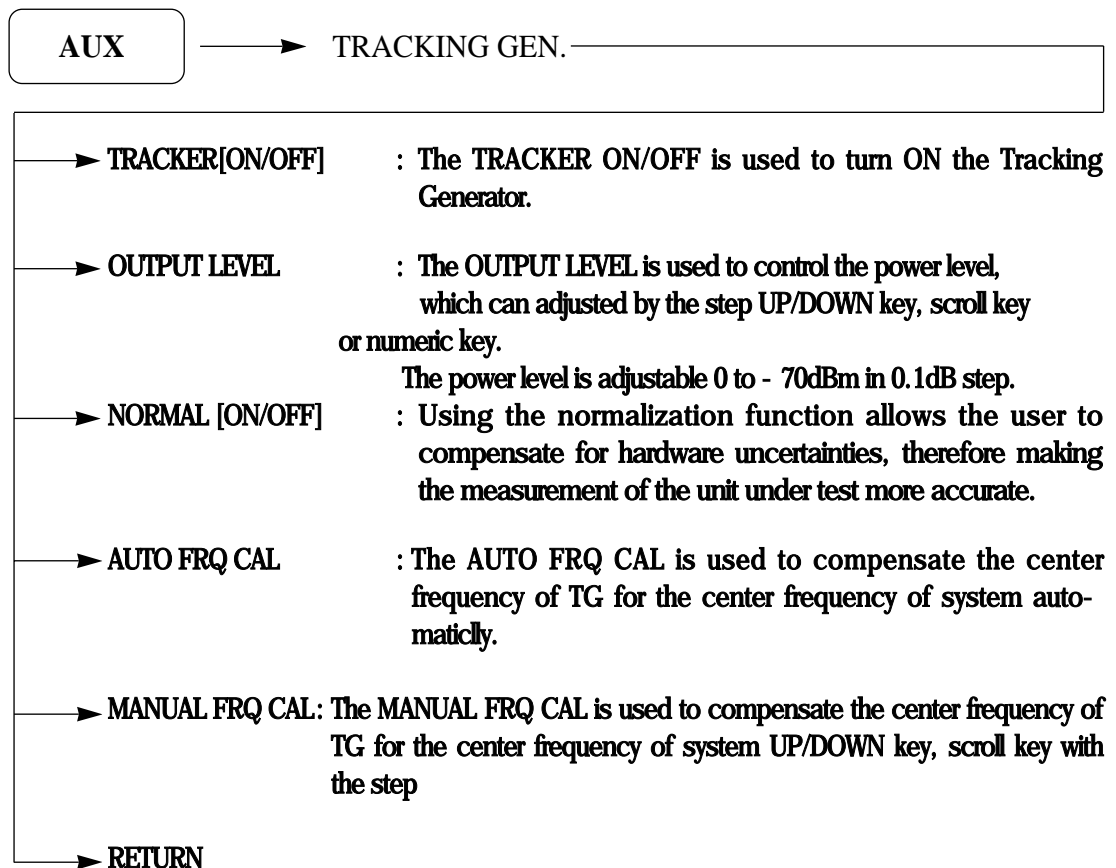

LIMIT LINE FUNCTIONS

The LIMIT key is the header key for using the limit line function

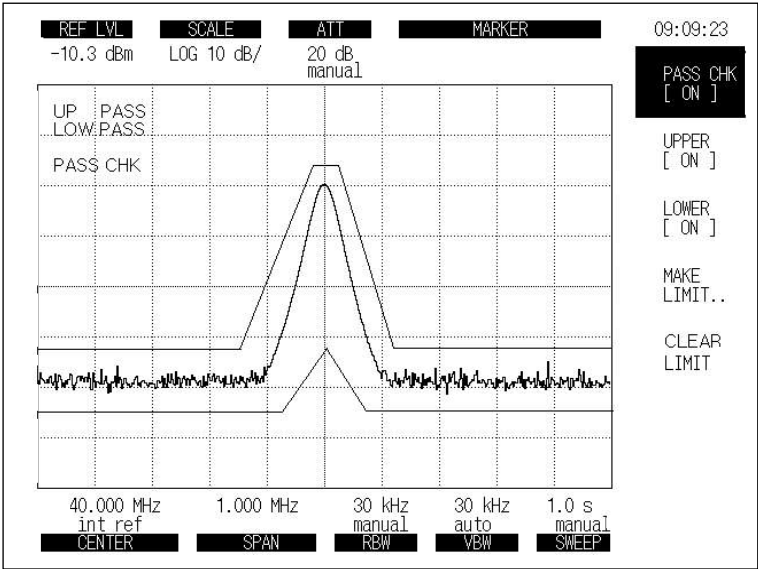
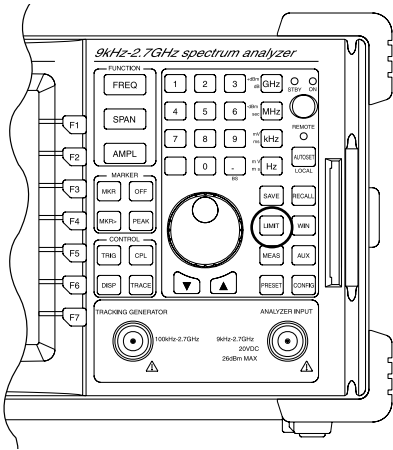

Fig 5-31. Limit Line Function

The **LIMIT LINE FUNCTION** displays two lines which can be set to show permissible upper and lower bounds on the spectral waveform.

Comparison of measured data with the limit lines is very easy.

To make the upper or lower mask table, perform the following key operations:

When the **UPPER** Limit line is selected, the limit line cursor(◇)is displayed on the left most top of the display line.

In **LOWER** limit line, the cursor is displayed on the left most bottom of the display line.

The **UP/DOWN** step is used to move the limit line cursor in the amplitude axis(Y position).

The **SCROLL** key is used to move the limit line cursor in the frequency axis(X position).

To define a limit line, perform the following operations :

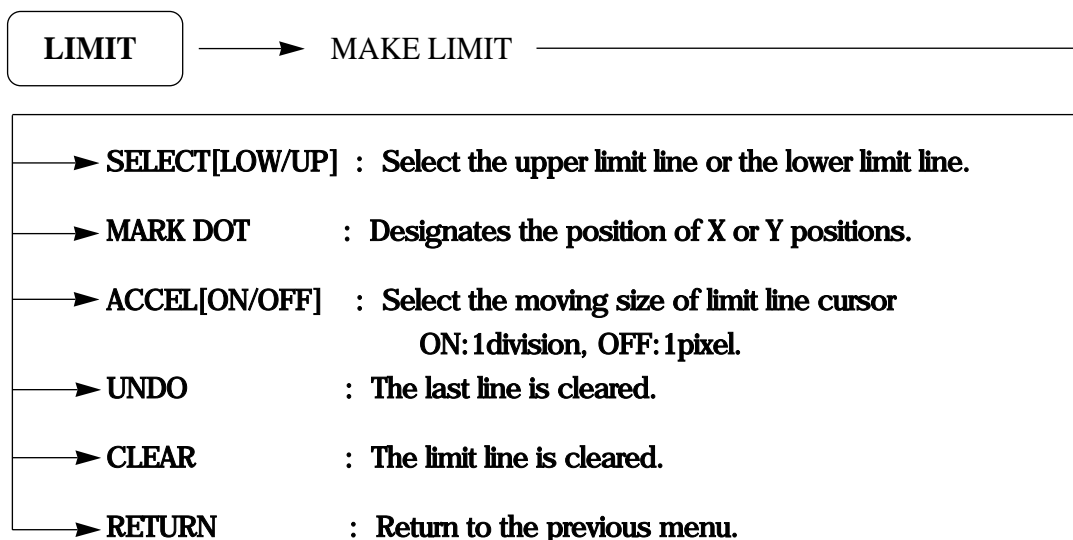

Set the **PASS/FAIL** mode using this key.

When the spectral waveform is within the upper limit line and lower limit, **PASS** is displayed on the screen. If not, **FAIL** is displayed on the screen.

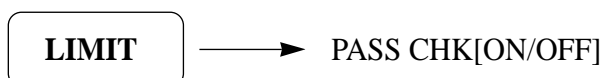

When **ON** is selected, the upper limit line is checked.

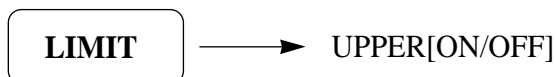

When **ON** is selected, the lower limit line is checked.

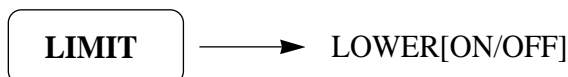

When **ON** is selected, beep if pass- check fails.

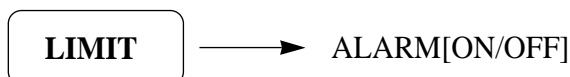

WINDOW FUNCTIONS

The WIN key is the header key for using the window function.

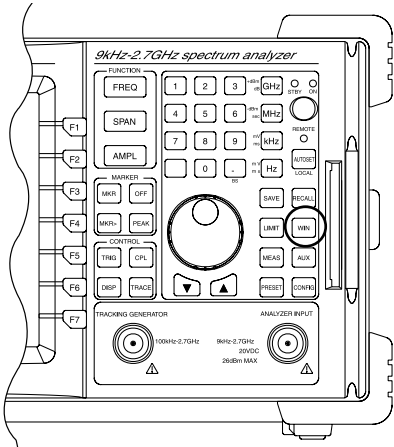

When the WINDOW function is ON, the screen is divided into two sections as shown below:

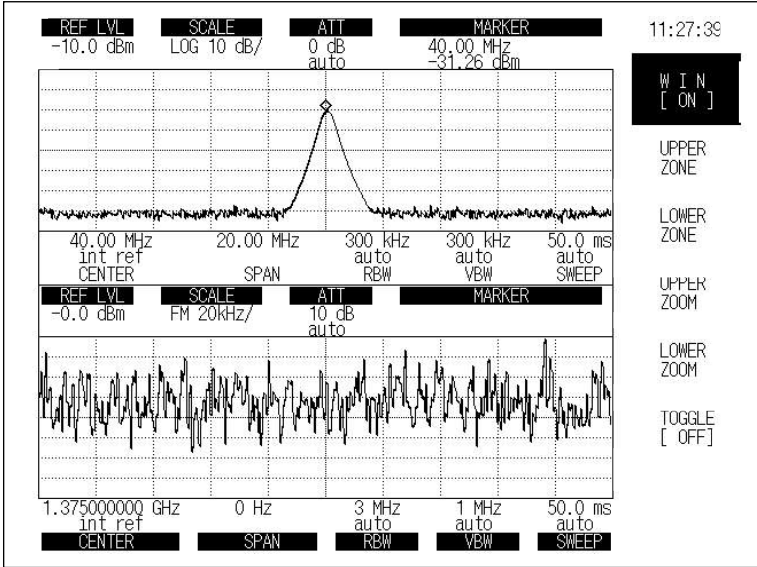
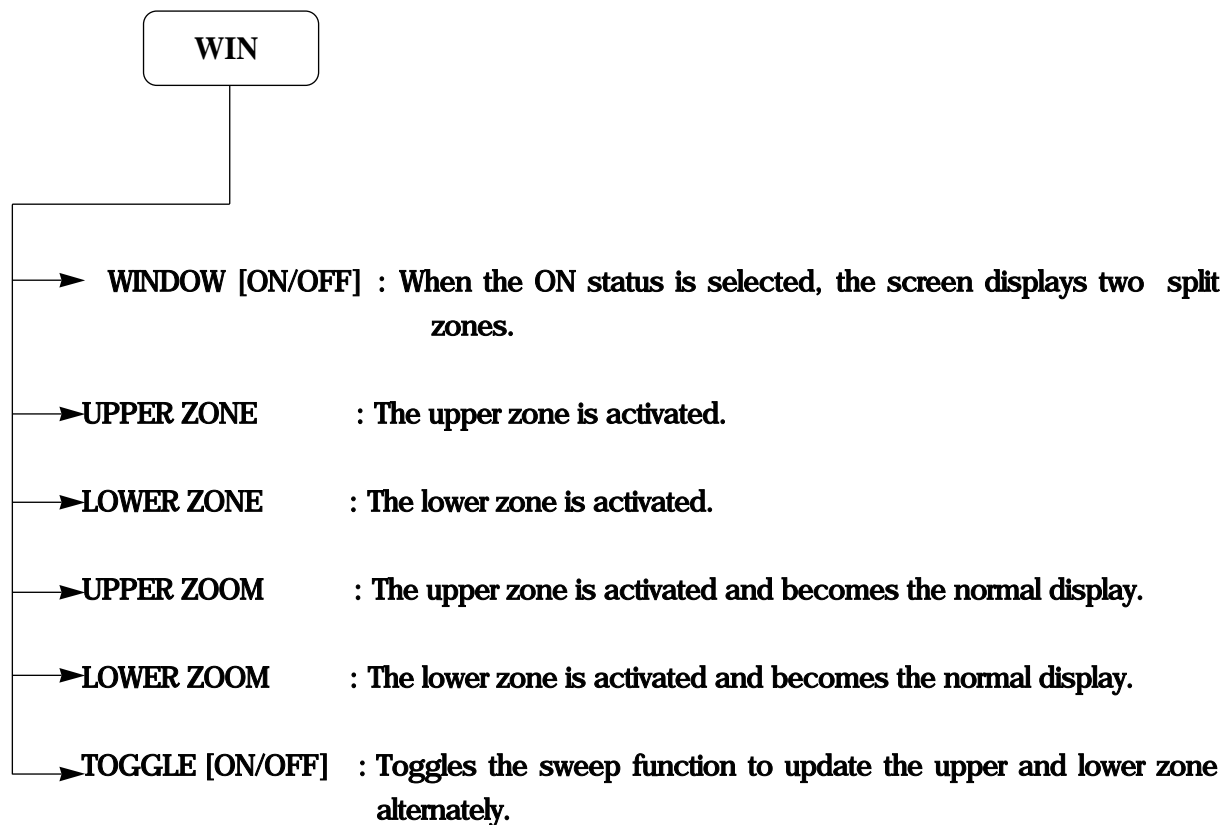

Fig 5-32 Window Function

The WINDOW function splits the display into two display zones (upper display area, lower display area).

To use the window function, perform the following operations.



PRESET FUNCTION

The preset key is the header key for the preset and calibration functions.

When the PRESET key is pressed, the following soft menus are displayed.

- PRESET
- LAST STATE
- ALL CAL
- CAL MODE
- CAL SIG[ON/OFF]
- AUTO CAL[ON/OFF]

PRESET

Pushing the preset key returns all of the analyzer parameters to the following values.

Factory Initial Set up

Center Frequency	: 1.375GHz
Frequency Span	: 2.75GHz
Reference Level	: 0 dBm
Detector	: LOG
Scale	: 10 dB/DIV
Sweep Time	: 50 msec, AUTO mode
RBW	: 3MHz, AUTO mode
VBW	: 1MHz, AUTO mode
ATTEN	: 10 dB, AUTO mode
Trigger	: Free Run
Marker	: OFF
Display Line	: OFF
Threshold Line	: OFF
Trace Detector Mode	: POS PEAK
Contrast	: 60%

LAST STATE

Pressing the LAST STATE key returns all of the analyzer parameters back to the last state values.

ALL CAL

Pressing the ALL CAL key does a self calibration routine for the system.

CAL Mode

When the CAL MODE is pressed, a soft menu related to the calibration routines are displayed. Each calibration menu does the hardware compensation routine to verify the unit operates precisely regardless of any hardware drift.

- YIG CAL : Recalibrates the YIG tuning curve values.
- RBW CAL : Compensates the RBW center frequency for drift and gain error and calculates new correction factors.
- LEVEL CAL : Compensates gain error to temperature calculates new correction factors.
- SPAN CAL : Compensates the SPAN attenuator error and the sweep gain and calculates new correction factors.
- LOG AMP CAL : Compensates the logarithmic amplifier for drift and calculates a new correction factors.

CAL SIGNAL

When the CAL SIGNAL is on, the calibration signal is displayed.

The calibration signal is 40MHz, - 30dBm.

This function is very useful for system self check.

AUTO CAL[ON/OFF]

When the AUTO CAL is on, the calibration routine automatically operates when a temperature calibration is required.

This function does not operate when the AUTO CAL is off.

SECTION 6

PERFORMANCE TESTS

In this section, measuring instruments along with setup and operation procedures necessary for conducting performance tests described.

TABLE OF CONTENTS

Requirement for Performance Tests	6 - 3
Instruments Required for Performance Test	6 - 4
Performance Test	6 - 6
Reference oscillator frequency stability	6 - 6
Center frequency readout accuracy	6 - 8
Frequency span readout accuracy	6 - 11
Resolution bandwidth (RBW) and selectivity and switching error	6 - 14
Sideband Noise(Phase noise)	6 - 20
Frequency measurement accuracy	6 - 22
Amplitude display linearity	6 - 24
Frequency response	6 - 30
Reference level accuracy	6 - 32
Average noise level	6 - 35
Second harmonic distortion	6 - 37
Input attenuator switching error	6 - 39
Residual FM	6 - 41
3rd Order Intermodulation	6 - 43
Spurious Response	6 - 46
Local oscillator Emission	6 - 48
Input VSWR	6 - 50

⟨BLANK⟩

6.1 Requirement for Performance Tests

Performance tests are used as preventive maintenance to prevent degradation of the 2398 performance before it occurs. Use the performance tests whenever necessary such as at acceptance and periodic inspection to verify performance after repair.

- Reference oscillator frequency stability
- Center frequency readout accuracy
- Frequency span readout accuracy
- Resolution bandwidth and selectivity and switching error
- Sideband noise(phase noise)
- Frequency measurement accuracy
- Amplitude display linearity
- Frequency response
- Reference level accuracy
- Average noise level
- Second harmonic distortion
- Input attenuator switching error
- Residual FM
- 3rd Order Intermodulation
- Spurious Response
- Local oscillator Emission
- Input VSWR

Execute the performance tests at regular intervals as preventive maintenance for important evaluation items. We recommend that the performance be inspected regularly once or twice a year. If the specifications are not met at the performance tests, please contact IFR Americas.

6.2 Instruments Required for Performance Test

Instruments Required for Performance Test (1/2)

Recommended instrument name (Model name)	Required Performance		Test Item
	Item	Specification	
Synthesized Signal Generator (MG3633A) (HP 8648C)	Frequency Range Resolution Output Level Range Output Level resolution SSB Phase noise Second Harmonic Amplitude modulation External reference input	10 kHz ~ 2.7 GHz 1 Hz - 20 dBm ~ 0 dBm 0.1 dB ≤ 130 dBc/Hz (at 10 kHz offset) ≤ 30 dBc 0 % ~ 100 % 0.1 ~ 400 Hz 10 MHz	Frequency- span readout accuracy Resolution Bandwidth , selectivity Sideband noise Amplitude display linearity Reference level accuracy Second harmonic distortion Resolution bandwidth switching error Input Attenuator switching error
Attenuator (Attenuator 1=HP8494 Attenuator 2=HP8496)	Frequency Range Attenuation Repeatability Frequency Range Attenuation Repeatability	DC ~ 26.5 GHz 0 ~ 11 dB (1 step) ≤ 0.01 dB (≤ 0.05 dB , 18 ~ 26.5 GHz) DC ~ 26.5 GHz 0 ~ 110 dB (10 step) ≤ 0.01 dB (≤ 0.05 dB , 18 ~ 26.5 GHz)	Amplitude display linearity Input attenuator switching error
Power Meter (HP 437B)	Frequency range Measure Range Power resolution	100 kHz ~ 110 GHz - 70 dBm ~ 44 dBm 0.001 dB	Frequency response Reference level accuracy Input attenuator switching error
Power sensor (HP8481A)	Frequency range VSWR(max) Power range	10 MHz ~ 18 GHz 1.4 (10 MHz ~ 30 MHz) 1.18(30 MHz ~ 50 MHz) 1.1(50 MHz ~ 2 GHz) 1.18(2 GHz ~ 12.4 GHz) 1.28(12.4 GHz ~ 18 GHz) - 30 dBm ~ +20 dBm	Frequency response Reference level accuracy Input attenuator switching error

Instruments Required for Performance Test (2/2)

Recommended instrument name (Model name)	Required Performance		Test Item
	Item	Specification	
Power sensor (HP8481D)	Frequency range	10 MHz ~ 18 GHz	Frequency response Reference level accuracy Input attenuator switching error
	VSWR (max)	1.4 (10 MHz ~ 30 MHz) 1.15(30 MHz ~ 4 GHz) 1.2 (4 GHz ~ 10 GHz) 1. 3(10 GHz ~ 15 GHz) 2. 35(15 GHz ~ 18 GHz)	
	Power range	- 70 dBm ~ - 20 dBm	
Power Combiner (HP11636A)	Frequency range	DC ~ 18 GHz	Frequency response Frequency measurement accuracy
	Input/Output	50 Ω	
	Impedance	Reference level accuracy	
50 Ω terminator (HP 909F)	Frequency Range	DC ~ 6 GHz (~ 18 GHz)	Average noise level
	VSWR	1.005 (DC ~ 5 GHz) 1.01 (5 ~ 6 GHz) 1.15 (6 ~ 18 GHz)	
Frequency Counter (HP 5350B)	Frequency range	10 Hz ~ 20 GHz	Reference oscillator frequency stability
	Resolution		
	1 Hz ~ 1 MHz	10 MHz ~ 20 GHz	
	1 Hz	10 MHz ~ 80 MHz	
	0.1Hz	1 MHz ~ 10 MHz	
	0.01 Hz	100 kHz ~ 1 MHz	
	0.001 Hz	10 Hz ~ 100 kHz	
	Input level(max)	+7 dBm (N- type) +10 dBm (BNC- type)[50 Ω] 1 Vrms (BNC- type)[1M Ω]	
	Damage level	+25 dBm (N- type) 250 V(dc~ 5 kHz) 5.5 Vrms (+28 dBm)	

Extracts part of performance which can cover the measurement range of the test item.

6.3 Performance Test

For test item other than oscillator frequency stability, warming- up the equipment for at least thirty minutes and test the performance after the 2398 stabilizes completely. Also, begin measurements after taking the warm- up time of the calibration instrument into full consideration. In addition, the test should be conducted at room temperature, little AC power supply voltage fluctuation, and should be free of noise, vibration, dust, humidity, etc.

6.3.1 Reference oscillator frequency stability

Frequency stability is tested by measuring the 10MHz reference oscillator. Stability is determined by measuring frequency variation at ambient temperatures of 0 °C and 40 °C.

6.3.1.1 Specification

■ Reference Oscillator

- Frequency : 10 MHz
- Aging rate : $\leq 1 \times 10^{-6}$ / year
After 24 hour warm- up at $25 \text{ }^{\circ}\text{C} \pm 5 \text{ }^{\circ}\text{C}$
- Temperature stability : $\leq 2 \times 10^{-6}$ at 0 and $40 \text{ }^{\circ}\text{C}$ referred to the frequency measured at $25 \text{ }^{\circ}\text{C}$

6.3.1.2 Test Instruments

- Frequency counter (HP5350B)

6.3.1.3 Setup

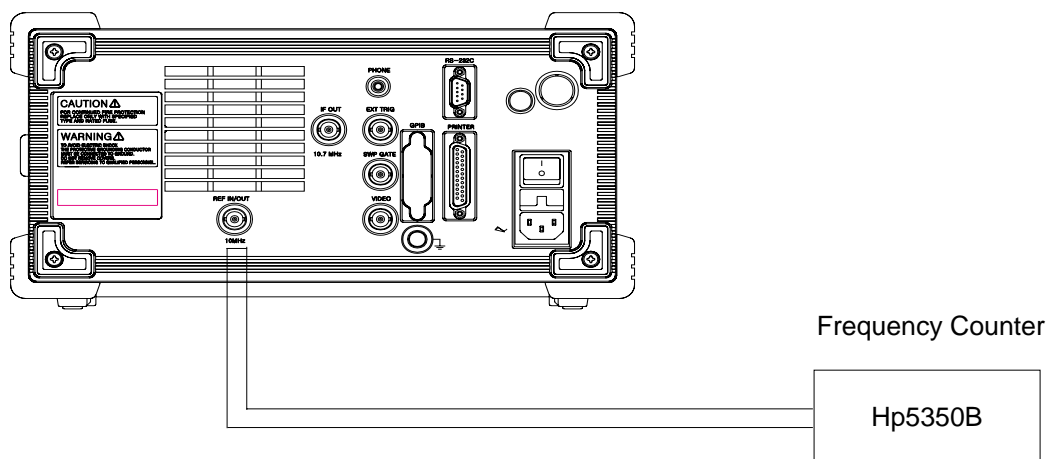

<Reference Oscillator Frequency Stability Test>

6.3.1.4 Procedure**6.3.1.4.1 Temperature stability**

Test condition : Test this performance in a vibration free variable temperature chamber

Step	Procedure
1.	Set up the 2398 in a constant- temperature chamber at 25 °C.
2.	Set the LINE and Power switches on the 2398 to ON and wait until the 2398 internal temperature stabilizes. (approx. 1.5 hours after the chamber temperature stabilizes).
3.	When the internal temperature stabilizes, measure the frequency by using the counter with 0.1Hz resolution
4.	Change the chamber temperature to 40 °C.
5.	When the chamber temperature and the 2398 internal temperature restabilizes, measure the frequency by using the counter.
6.	Calculate the stability by using the following equation.

$$\text{Frequency stability} = \frac{(\text{counter reading at } 40\text{ }^{\circ}\text{C}) - (\text{counter reading at } 25\text{ }^{\circ}\text{C})}{(\text{counter reading at } 25\text{ }^{\circ}\text{C})}$$

6.3.2 Center frequency readout accuracy

Add the known frequency which serves as the center frequency reference to the 2398 as shown in the figure below and set CF (same value as the known reference frequency) and SPAN. At this time, check that the difference between the reading of the marker reading of the marker readout frequency (thick arrow in the figure) of the center frequency peak point, and the CF set value is $\leq \pm (\text{span} \times \text{span accuracy} + 0.5 \times \text{RBW})$. As shown in the figure, the Synthesized Signal Generator uses the signal source phaselocked with the same accuracy as the 10MHz reference oscillator of the 2398.

6.3.2.1 Specification

- Center frequency accuracy : $\pm (\text{Indicated frequency} \times \text{reference frequency accuracy} + \text{span} \times \text{span accuracy} + 0.5 \times \text{RBW})$; after calibration

6.3.2.2 Test Instruments

- Synthesized Signal Generator : MG3633A [Anritsu]
- Frequency counter : HP5350B
- Power combiner : HP11636A
- RF Cable 1,2,3 : N [male] ~ N[male]
- Adapter : N [female] ~ N[female]
- BNC Cable : BNC[male] ~ BNC[male]

6.3.2.3 Setup

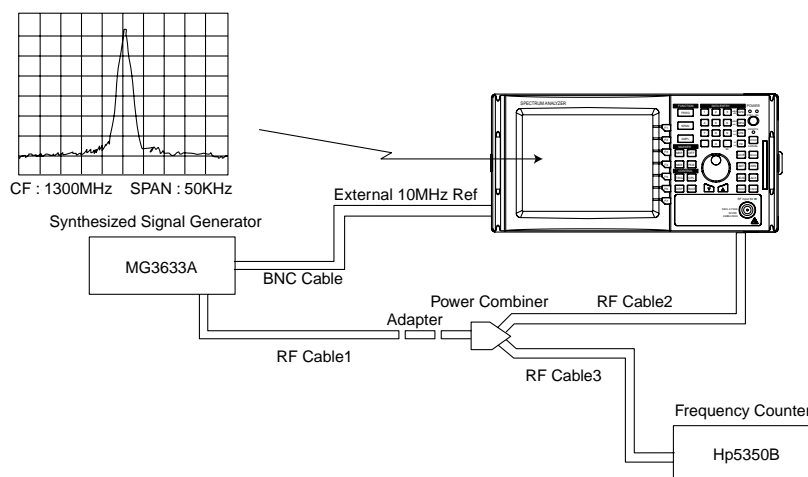

<Center frequency readout accuracy>

6.3.2.4 Procedure

Step	Procedure
------	-----------

1. Set the power supply switch on the 2398 rear panel to ON and then the power switch on the 2398 front panel to ON.
2. Press the 2398 [PRESET] key.
3. Press [PRESET] softkey and then [ALL CAL] softkey.
4. Set the signal generator output frequency equal to the center frequency (1300 MHz) in the following table :

Frequency	: 1300 MHz
-----------	------------

Power	: - 10 dBm
-------	------------

5. Set the 2398 to the center frequency in the table and the attenuator to 10 dB.
6. Set the 2398 as follows:

center frequency	: 1300 MHz
------------------	------------

Reference level	: 0 dBm
-----------------	---------

Couple	: All Auto
--------	------------

Span	: 50 kHz
------	----------

7. Using the marker function, read the marker frequency and check that the value is within the range between the maximum and minimum values shown in the following table.
8. Repeat steps 4 to 7 for other combination of the center frequency and span according to the combination shown in the following table.
9. Calculate the Center Frequency accuracy by using the following equation.

Center frequency accuracy : $\pm (\text{Measured frequency} \times \text{Reference Oscillator accuracy} + \text{Span} \times \text{Span accuracy} + 0.5 \times \text{RBW})$

※ Reference Oscillator accuracy : 2 ppm

Span accuracy : 3 %

SECTION 6 PERFORMANCE TESTS

Test Instrument frequency (MG3633A)	2398		Measured frequency (MHz)			
	Span	Center Frequency	Minimum	Measured	Maximum	Accuracy
Frequency : 1300 MHz Output Power Level : - 10 dBm	50 kHz	1300 MHz	1299.9935		1300.0066	
	200kHz		1299.9890		1300.1107	
	1 MHz		1299.9650		1300.0351	
	2 MHz		1299.9350		1300.0651	
	5 MHz		1299.8449		1300.1551	
	10 MHz		1299.6949		1300.3051	
	20 MHz		1299.3949		1300.6051	
	50 MHz		1298.4949		1301.5050	
	100 MHz		1296.9949		1303.0050	
500 MHz	1284.9949		1315.0050			

6.3.3 Frequency span readout accuracy

Using the setup shown in the figure below, set the frequencies corresponding the 1st and 9th division from the left side of the screen scale with the Signal Generator. The frequency difference between the peak levels at the 1st and 9th divisions is equal to the frequency span $\times 0.8$.

6.3.3.1 Specification

- Frequency span accuracy : $\pm 3.0\%$

6.3.3.2 Test Instruments

- Synthesized Signal Generator : MG3633A [Anritsu]
- Frequency counter : HP5350B
- Power combiner : HP11636A
- RF Cable 1,2,3 : N [male] ~ N[male]
- Adapter : N [female] ~ N[female]
- BNC Cable : BNC[male] ~ BNC [male]

6.3.3.3 Setup

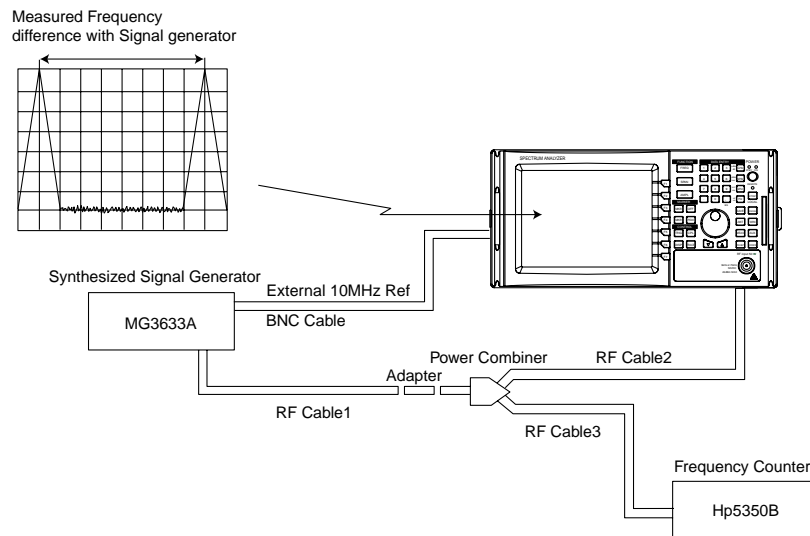

<Frequency Span Readout Accuracy>

6. 3.3.4 Procedure

Step	Procedure
1.	Set the power supply switching on the 2398 rear panel to ON and then the power switch ON the 2398 front panel to ON.
2.	Press the 2398 [PRESET] key.
3.	Press [PRESET] softkey and then [ALL CAL] softkey.
4.	Set the signal generator output frequency equal to the center frequency in the following table.

Frequency : 1300 MHz

Power : - 10 dBm

5. Set the 2398 to the center frequency in the table and the attenuator to 10dB.

Center frequency : 1300 MHz

Span : 50 kHz

Reference level : 0 dBm

Couple : All Auto

6. Set control of 2398 as follows:
7. Adjust the MG3633A output frequency to set the signal peak at the 1st division from the left end of the screen scale . Record the frequency of f1 .
8. After setting the MG3633A output frequency to the f2 frequency adjust it to set the signal peak at the 9th division . Record the frequency of f2 .
9. Calculate $(f2 - f1)/(span \times 0.8)$ and check that the value is within the specified range shown in the table on the next page.
10. Repeat steps 5 through 10 for each frequency span with 1300 MHz center frequency range between the maximum and minimum values shown in the following table .
11. Calculate the Frequency Span accuracy by using the following equation :

$$\text{frequency span accuracy} = \frac{[\text{frequency}(f2) - \text{frequency}(f1)] \times 100}{(\text{Span} \times 0.8)}$$

2398		Signal Generator(MHz)		Specification			
Center Frequency	Span	f 2	f 1	Minimum span	Maximum span	Accuracy	
1300 MHz	50 kHz			8.5 kHz	51.5 kHz		
	200kHz			194 kHz	206 kHz		
	1 MHz			970 kHz	1.3 MHz		
	2 MHz			1.94 MHz	2.06 MHz		
	5 MHz			4.85 MHz	5.15 MHz		
10 MHz		9.7 MHz	10.3 MHz				
	20 MHz		19.4 MHz	20.6 MHz			
50 MHz			48.5 MHz	51.5 MHz			
	100 MHz			97 MHz	103 MHz		
	200 MHz			194 MHz	206 MHz		
	500 MHz				485 MHz	515 MHz	
	1000 MHz			970 MHz	1030 MHz		
	2000 MHz				1940 MHz	2060 MHz	

6.3.4 Resolution bandwidth (RBW) and selectivity and switching error

★ RBW accuracy and selectivity

When there are two input signals with a frequency difference corresponding to the 3dB bandwidth(of IF final stage) the signals can be resolved as two waveforms. This is called resolution bandwidth.

The selectivity is defined by the ratio of the filter width, in Hz, at the - 60dB point, to the filter width, in Hz, at the - 3dB point, as shown in the formula below.

To test the resolution bandwidth and selectivity, first measure the resolution bandwidth(3dB bandwidth), then the 60dB bandwidth and calculate the 60dB/3dB bandwidth ratio.

★ RBW switching error

The switching error is defined as the shift in amplitude when the RBW filter is switched .

6.3.4.1 Specification

- Accuracy : $\leq \pm 20\%$ at 3 dB (300 Hz , 1 kHz , 3 kHz , 10 kHz ,
30 kHz, 100 kHz, 300kHz, 1MHz, 3 MHz)
 $\leq \pm 20\%$ at 6 dB (9 kHz , 120 kHz)

- Selectivity (60 dB/3dB Bandwidth) : $\leq 15 : 1$
(1 kHz , 3 kHz , 10 kHz , 30 kHz, 100 kHz, 300 kHz, 1MHz, 3 MHz)
(60 dB/6dB Bandwidth) : $\leq 12 : 1$
(9 kHz , 120 kHz)

- Switching error : $\leq \pm 1.0$ dB

6.3.4.2 Test Instruments

- Synthesized Signal Generator : MG3633A [Anritsu]

6.3.4.3 Setup

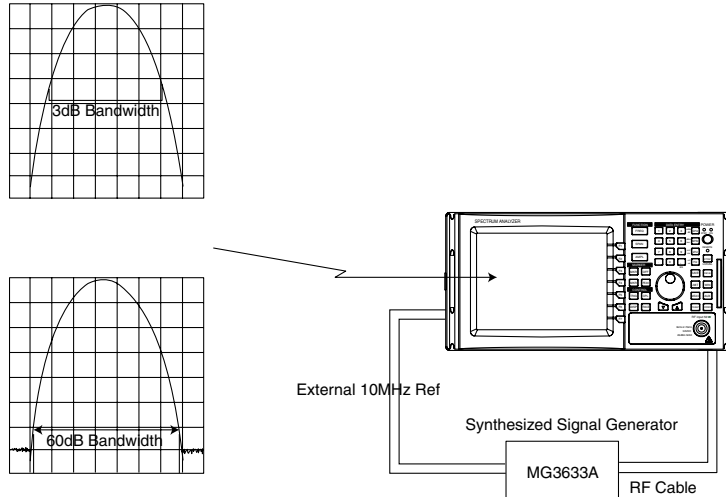

<Resolution Bandwidth and Selectivity and Error>

6.3.4.4 Procedure

6.3.4.4.1 RBW Accuracy

Step	Procedure
------	-----------

1. Press [PRESET] key .
2. Press [ALL CAL] softkey.
3. Set up the 2398 as shown below:

center frequency : 100 MHz

Span : 10 MHz

Reference level : - 10 dBm

ATT : Auto

RBW : 3 MHz

Scale : 1 dB/Div

Sweep time : Auto

4. Set the Synthesized signal generator (MG3633A) as shown below:

Frequency : 100 MHz

Power : - 15 dB

5. Press [PEAK] [MKR - >REF] key and match the peak of the signal trace to the top line [REF LEVEL] on the screen .
6. Press [TRIG] [SINGLE]softkey to execute a single sweep, then check that the single sweep has been completed.
7. Press [MEAS] [dB DOWN - > X dB DOWN] softkey and set it to 3 dB or 6 dB
8. Press [TRIG] [CONT] softkey.
9. Change RBW filter and measure.
10. Repeat step 5 to 9 for the frequencies other then the resolution bandwidth 3MHz and frequency span 10MHz according to the combinations of resolution bandwidth and frequency span shown in the follow table.
11. Calculate RBW filter accuracy :

$$\text{Accuracy} = \frac{(\text{RBW} - \text{Measured Value})}{\text{RBW}}$$

2398		Marker \sphericalangle 3dB bandwidth			Accuracy	Remark
RBW	Span	Minimum	Measure	Maximum		
300 Hz	10 kHz	240 Hz		360 Hz		(6 dB BW)
1 kHz	50 kHz	800 Hz		1.2 kHz		
3 kHz	50 kHz	2.4 kHz		3.6 kHz		
9 kHz	50 kHz	7.2 kHz		10.8 kHz		
10 kHz	50 kHz	8.0 kHz		12.0 kHz		
30 kHz	50 kHz	24 kHz		36 kHz		
100kHz	200 kHz	80 kHz		120 kHz		(6 dB BW)
120kHz	300 kHz	96 kHz		144 kHz		
300kHz	500 kHz	240 kHz		360 kHz		
1 MHz	5 MHz	800 kHz		1.2 MHz		
3 MHz	10 MHz	2.4 MHz		.6 MHz		

6.3.4.4.2 RBW Selectivity

Step	Procedure														
1.	Press [PRESET] key.														
2.	Press [ALL CAL] softkey.														
3.	Set the 2398 as shown below: <table border="1" style="margin-left: 40px;"> <tr> <td>Center frequency</td> <td>: 100 MHz</td> </tr> <tr> <td>Span</td> <td>: 100 MHz</td> </tr> <tr> <td>Reference level</td> <td>: - 10 dBm</td> </tr> <tr> <td>ATT</td> <td>: Auto</td> </tr> <tr> <td>RBW</td> <td>: 3 MHz</td> </tr> <tr> <td>Scale</td> <td>: 10 dB/Div</td> </tr> <tr> <td>Sweep time</td> <td>: Auto</td> </tr> </table>	Center frequency	: 100 MHz	Span	: 100 MHz	Reference level	: - 10 dBm	ATT	: Auto	RBW	: 3 MHz	Scale	: 10 dB/Div	Sweep time	: Auto
Center frequency	: 100 MHz														
Span	: 100 MHz														
Reference level	: - 10 dBm														
ATT	: Auto														
RBW	: 3 MHz														
Scale	: 10 dB/Div														
Sweep time	: Auto														
4.	Set the Synthesized signal generator (MG3633A) as shown below. <table border="1" style="margin-left: 40px;"> <tr> <td>Frequency</td> <td>: 100 MHz</td> </tr> <tr> <td>Power</td> <td>: - 10 dBm</td> </tr> </table>	Frequency	: 100 MHz	Power	: - 10 dBm										
Frequency	: 100 MHz														
Power	: - 10 dBm														
5.	Press [PEAK] [MKR - >REF] key and match the peak of the signal trace to the stop line [REF LEVEL] on the screen .														
6.	Press [TRIG] [SINGLE] key to execute a single sweep, then check that the single sweep has been completed.														
7.	Press [MEAS] [dB DOWN - > X dB DOWN] key and set it to 60 dB.														
8.	Press [TRIG] [CONT] key . Change the RBW filter and measure.														
9.	Repeat steps 5 to 8 for the other resolution bandwidth filters and frequency spans according to the combinations of resolution bandwidth and frequency span shown in the follow table.														
10.	For 3 dB bandwidth , used the value table (item 6.3.4.4.1).														
11.	Calculate RBW Selectivity :														

$$\text{Selectivity} = \frac{60 \text{ dB Bandwidth}}{3 \text{ dB Bandwidth (or 6 dB Bandwidth)}}$$

2398		VBW	3dB BW	60dB BW	Selectivity	remark
RBW	Span					
300 Hz	10 kHz	10 Hz			(6dB BW)	
1 kHz	50 kHz	100 Hz				
3 kHz	100 kHz	100 Hz				
9 kHz	200 kHz	100 Hz				
10 kHz	200 kHz	100 Hz				
30 kHz	1 MHz	100 Hz				
100kHz	10 MHz	100 Hz				
120kHz	10 MHz	100 Hz			(6dB BW)	
300kHz	20 MHz	100 Hz				
1 MHz	50 MHz	100 Hz				
3 MHz	100 MHz	100 Hz				

6.3.4.4.3 RBW Switching error

Step	Procedure
------	-----------

1. Press [PRESET] key.
2. Press [ALL CAL] softkey.
3. Set up the 2398 as shown below:

Center frequency : 100 MHz

Span : 20 kHz

Reference level : - 10 dBm

ATT : Auto

RBW : 30 kHz

Scale : 10 dB/Div

Sweep time : Auto

4. Set the Synthesized signal generator (MG3633A) as shown below:

Frequency : 100 MHz

Power : - 15 dBm

5. Press [PEAK] [MKR - >CF] key and [MKR- >REF] to move the signal peak to the center and the top of the screen.
6. Press [MRK] [MARKER DELTA] key that in order to set to the marker to Δ marker.
7. Set RBW and SPAN as shown in the table and measure the amplitude deviation (error) of each RBW by following step 8 and 9 below.
8. Press [PEAK] key to conduct peak search and move the current marker to the peak point of the signal spectrum
9. Read the Δ marker level value.

RBW	frequency span	Deviation (error)	Remark
1 kHz	10 kHz	0.0	(Reference)
3 kHz	20 kHz		
9 kHz	50 kHz		
10 kHz	50 kHz		
30 kHz	150 kHz		
100 kHz	500 kHz		
120 kHz	500 kHz		
300 kHz	1.5 MHz		
1 MHz	5 MHz		
3 MHz	15 MHz		

6.3.5 Sideband Noise (Phase noise)

Sideband noise is the measure of the noise present on the local oscillator signal measured at an offset from the carrier frequency. It is important to use a signal source with 10dB or better sideband noise performance than spectrum analyzer.

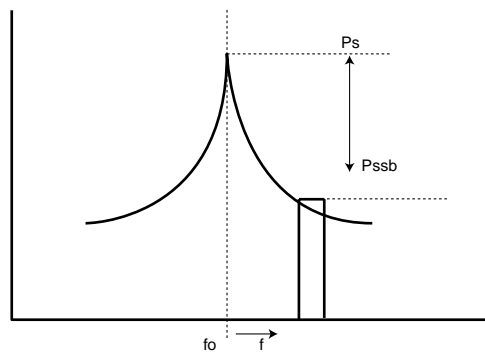

6.3.5.1 Specification

- sideband noise (phase noise) : $\leq -90 \text{ dBc} / \text{Hz}$ (10 kHz at offset frequency)

6.3.5.2 Test Instruments

- Synthesized signal generator

6.3.5.3 Setup

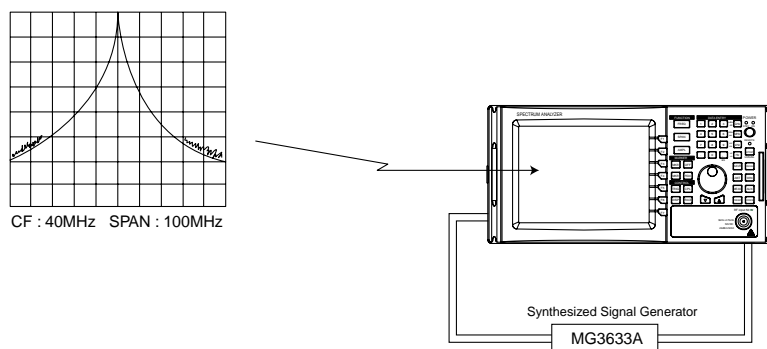

<Sideband Noiser>

6.3.5.4 Procedure

Step	Procedure
------	-----------

1. Press [PRESET] key.
2. Press [ALL CAL] softkey.
3. Set up the 2398 as shown below:

Center frequency	: 2700 MHz
Span	: 100 kHz
Reference level	: 0 dBm
ATT	: Auto
RBW	: 1 kHz
VBW	: 30 Hz
Scale	: 10 dB/div
Sweep time	: Auto

4. Press [PEAK] [MKR - >CF] key and [MKR- >REF] to move the signal spectrum peak to the center and the top of the screen.
5. Press [TRIG] [SINGLE] key to execute a single sweep, then check that the single sweep has been completed.
6. Press the [MKR] [MARKER DELTA] that in order to set to the marker to Δ marker.
7. Set the Δ marker to frequency of 10 kHz and read marker value (amplitude).
8. Calculate Sideband noise.

$$\text{Sideband noise} = \text{Measured Value}(\Delta\text{marker value}) - 10\log(\text{RBW}/1\text{Hz})$$

Example :

Offset frequency	Measured value	Sideband Noise
10 kHz	- 65dBc	- 95dBc/Hz

6.3.6 Frequency measurement accuracy

To measure frequency counter accuracy set the signal generator and marker point to a position at least 20 dB higher than the noise (or adjacent interference signal) to operate the built- in counter and test the frequency measurement accuracy using the Frequency Counter COUNT ON mode.

6.3.6.1 Specification

- Accuracy : $\leq (\text{Readout frequency} \times \text{reference oscillator accuracy} \pm (1 \text{ LSB}))$
- Resolution : 1Hz, 10Hz, 100Hz, 1kHz
- Sensitivity : - 70 dBm min
- ※ reference oscillator accuracy : $\leq \pm 5\text{ppm}$

6.3.6.2 Test Instruments

- Synthesized signal generator : MG3633A or equivalent
- Frequency counter : HP5350B
- Power Splitter : HP11636A
- RF cable 1,2,3 : N [male] ~ N [male]
- BNC cable : BNC[male] ~ BNC[male]

6.3.6.3 Setup

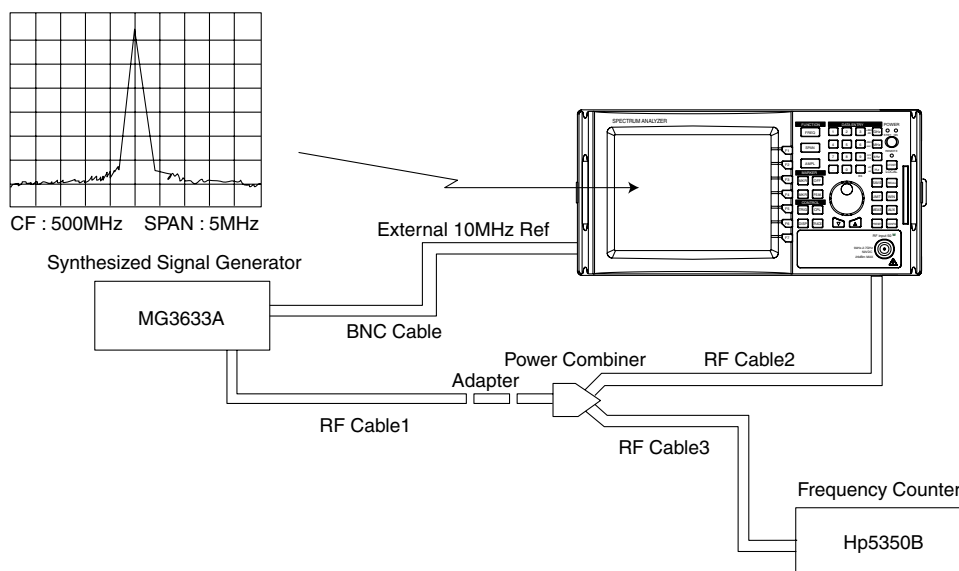

<Frequency Measurement Accuracy>

6.3.6.4 Procedure

Step	Procedure
------	-----------

1. Press [PRESET] key.
2. Press [ALL CAL] softkey.
3. Set up the 2398 as shown below :

Center frequency	:	100 MHz
------------------	---	---------

Span	:	5 MHz
------	---	-------

Couple	:	All Auto
--------	---	----------

4. Set the Synthesized signal generator as shown below :

Frequency	:	100 MHz
-----------	---	---------

Power	:	- 10 dBm
-------	---	----------

5. Press [MKR - > PEAK SEARCH] key and then set to Frequency Counter ON [MEAS - > MKR COUNT [ON]] .
6. Press marker resolution [MEAS - > MKR RESOL - > 1 Hz] key Then press [RETURN] key.
7. Change the counter resolution to 10 Hz and confirm that the frequency reading is $100 \text{ MHz} \pm 10 \text{ Hz}$ or less.
8. Change the counter resolution to 100 Hz and confirm that the frequency reading is $100 \text{ MHz} \pm 100 \text{ Hz}$ or less.
9. Change the counter resolution to 1 kHz and confirm that the frequency reading is $100 \text{ MHz} \pm 1 \text{ kHz}$ or less.
10. Change the amplitude of the signal generator - 70dBm and confirm that the frequency reading is still accurate.

Signal generator frequency	2398		Measured Frequency		Standard Accuracy
	CF	Resolution	Marker Frequency	Measured Accuracy	
100 MHz	100 MHz	1 Hz 10 Hz 100 Hz 1000 Hz			$\leq (\text{Readout Frequency} \times \text{Reference Oscillator Accuracy} \pm 1 \text{ LSB})$
100MHz- 70dBm	100MHz	1000Hz			

6.3.7 Amplitude display linearity

This test determines the error per vertical graduation for the LOG display and LINEAR display .

Apply the correct level signal to the RF Input via an external attenuator and measure the error from the attenuation of the attenuator and the Δ marker reading at the trace waveform peak.

6.3.7.1 Specification

- Amplitude display linearity : After automatic calibration

LOG : $\leq \pm 1.5$ dB for 10 dB / div over 8 divisions (RBW ≤ 3 kHz)

$\leq \pm 1.5$ dB for 5 dB / div over 8 divisions (RBW ≤ 3 kHz)

$\leq \pm 0.5$ dB for 1 or 2 dB / div over 8 divisions (RBW ≤ 3 kHz)

LINEAR : $\leq \pm 10$ % of Ref Level over 8 divisions

6.3.7.2 Test Instruments

- Synthesized Signal generator : MG3633A
- Attenuator : HP 8494 , HP 8496
- RF cable 1,2,3 : N [male] ~ N[male]
- Power meter : HP437B
- Power splitter

6.3.7.3 Setup

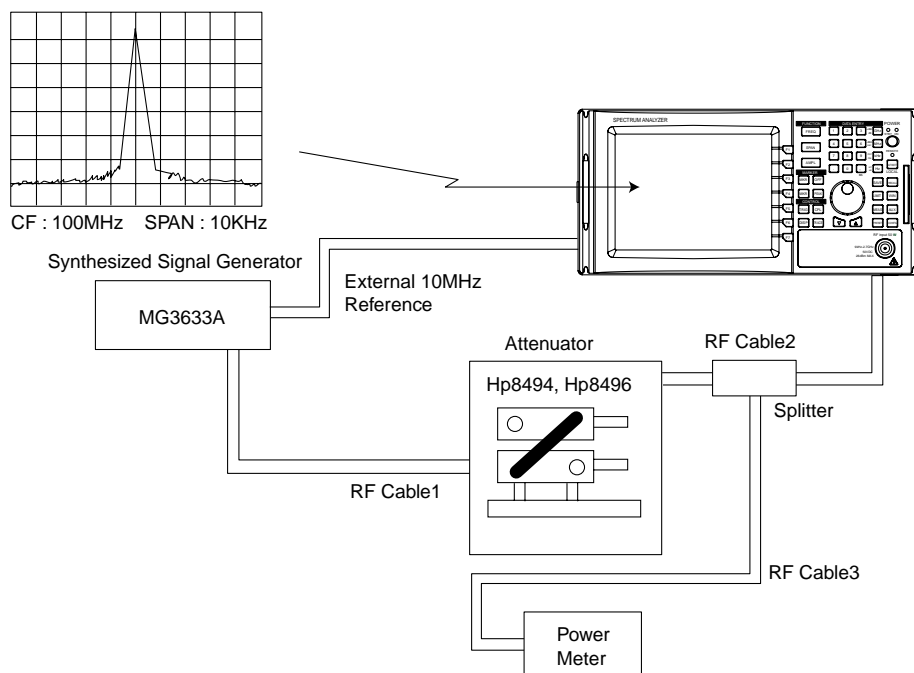

<Amplitude display linearity>

6.3.7.4 Procedure

6.3.7.4.1 LOG Linearity [10 dB / div , 5 dB / div , 2 dB / div , 1 dB / div]

Step	Procedure
------	-----------

1. Press [PRESET] key.
2. Preset [ALL CAL] softkey.
3. Set up the 2398 as shown below :

Center frequency	: 100 MHz
Reference level	10 kHz
Span	: 0 dBm
ATT	: 10 dB
RBW	: 1 kHz
VBW	: 10 Hz
Scale	: 10 dB/div

4. Set the Synthesized signal generator (MG3633A) as shown below :

Frequency	: 100 MHz
Power	: +6 dBm

5. Press [AMPL] [LOG] key and then the [SCALE- >10dB/div] key to set the display in the Log state.
6. Press [PEAK] [MKR - > CF]key and then the Peak [MKR- >REF] key to set the waveform peak to the center of the screen.
Adjust Signal generator as required to confirm that power meter measures 0 dBm.
7. Press [MKR] [MARKER DELTA] key and increase Attenuator in 10dB steps [HP8494,HP8496] reading Δ marker level .
8. Calculate Log Linearity [10 dB/div].
Amplitude display linearity error = Attenuator value (dB) + Δ marker level
9. Repeat Log Linearity [5 dB/div , 2 dB/div, 1 dB/div] steps 5 than 8.

Log Display Linearity [10 dB/DIV]

Test Instrument Attenuator	∠ Marker	Error	Remark
Setting (dB)	Value (dB)		
0	0	0	reference
10			
20			
30			
40			
50			
60			
70			
80			

Log Display Linearity [5 dB/DIV]

Test Instrument Attenuator	∠ Marker	Error	Remark
Setting (dB)	Value (dB)		
0	0	0	reference
5			
10			
15			
20			
25			
30			
35			
40			

Log Display Linearity [2 dB/DIV]

Test Instrument Attenuator	∠ Marker	Error	Remark
Setting (dB)	Value (dB)		
0	0	0	reference
2			
4			
6			
8			
10			
12			
14			
16			

Log Display Linearity [1 dB/DIV]

Test Instrument Attenuator	∠ Marker	Error	Remark
Setting (dB)	Value (dB)		
0	0	0	reference
1			
2			
3			
4			
5			
6			
7			
8			

6.3.7.4.2 LINEAR Linearity [Full scale]

Step	Procedure
-------------	------------------

1. Press [PRESET] key.
2. Press [ALL CAL] softkey.
3. Set up the 2398 as shown below :

Center frequency	: 100 MHz
Reference level	: 0 dBm
Span	: 10 kHz
Attenuator	: 10 dBm
RBW	: 1 kHz
VBW	: 10 Hz
Scale	: 10 dB/div

4. Set the Synthesized signal generator (MG3633A) as shown below :

Frequency	: 100 MHz
Power	: 0 dBm

5. Press [AMPL] [LINEAR] key and then the [AMPL] [UNIT- > VOLT] key to set the display in the linear state.
6. Press [PEAK] [MKR - > CF] key and then the [PEAK] [MKR- >REF] key to set the spectrum waveform peak to the center of the screen.
7. Press[MKR][MARKER DELTA] key and increase Attenuator [HP8494,HP8496] (6 dB) reading Δ marker level.
8. Calculate LINEAR Linearity (Full scale).

Amplitude display linearity error = Attenuator value (dB) + Δ marker level

LINEAR display Linearity (full scale)

ATT Setting (dB)	Value (dB)	Error	Remark
0	0	0	reference
6			
12			
18			
24			
30			
36			

6.3.8 Frequency response

Generally, when one or more signals with a different frequency but the same amplitude are applied to the unit, the spectrum analyzer displays the same amplitude for each signal on the screen.

6.3.8.1 Specification

- Frequency response : - 3dB << +1dB(9kHz ~ 10MHz)
 $\leq \pm 1.5\text{dB}$ (10MHz ~ 2.7 GHz) [@att = 10dB]

6.3.8.2 Test Instruments

- Synthesized signal generator : MG3633A
- Power Meter : HP437B
- Power Sensor : HP8481A
- Power splitter : HP11636A
- Adapter : N[female] ~ N [female]
- RF cable 1,2,3 : N[male] ~ N[male]

6.3.8.2 Setup

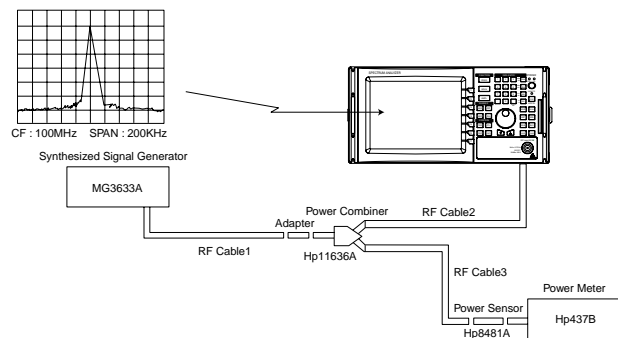

<Frequency Response>

6.3.8.4 Procedure

6.3.8.4.1 Power meter calibration and measurement procedure

Step	Procedure
1.	Connect the Power Meter [HP437B] to Power sensor [HP8481A].
2.	Connect the Power sensor to Power Meter input port.
3.	Push Power REF button of Power Meter and then display value 0 dBm.
4.	If display value is not 0 dBm , turn Cal ADJ.
5.	Connect the test equipment as shown above.
6.	Adjust Signal generator output level set to - 10 dBm. Set up the synthesized signal generator as shown below:

Frequency : 100 MHz
Power : - 10 dBm

7. Read the power meter display and adjust signal generator output level to - 10dBm.
8. Press [PRESET] key .
9. Press [ALL CAL] softkey.
10. Set up the 2398 as shown below :

Center frequency : 100 MHz
Reference level : - 10 dBm
Span : 200kHz
Couple : All Auto

11. Press [PEAK] [MKR - > CF] key to set the waveform peak to the center of the screen.
12. Change Signal generator output frequency and adjust the signal generator to maintain the level on the power meter.
13. Calculate Frequency response.

$$\text{Error} = \text{Power meter value} - \text{display Marker peak value}$$

Signal Generator Frequency	Power Meter (dBm)	Marker peak value(dBm)	Error	Remark
100 MHz				
300 MHz				
500 MHz				
1000 MHz				
1500 MHz				
2000 MHz				

6.3.9 Reference level accuracy

Here the absolute amplitude level at only 100MHz is tested. Confirm the level accuracy with a signal from the Signal Generator, calibrated by a standard power meter.

6.3.9.1 Specification

- Reference level accuracy :

$$\leq \pm 1.5\text{dB} \text{ (- 100 dBm ~ + 30 dBm, 10dB/div)}$$

6.3.9.2 Test Instruments

- Synthesized signal generato : MG3633A
- Power Meter : HP437B
- Power Sensor : HP8481A HP8481D
- Step Attenuator : HP8496B , HP8494B
- RF cable 1,2,3 : N[male] ~ N[male]
- RF splitter

6.3.9.3 Setup

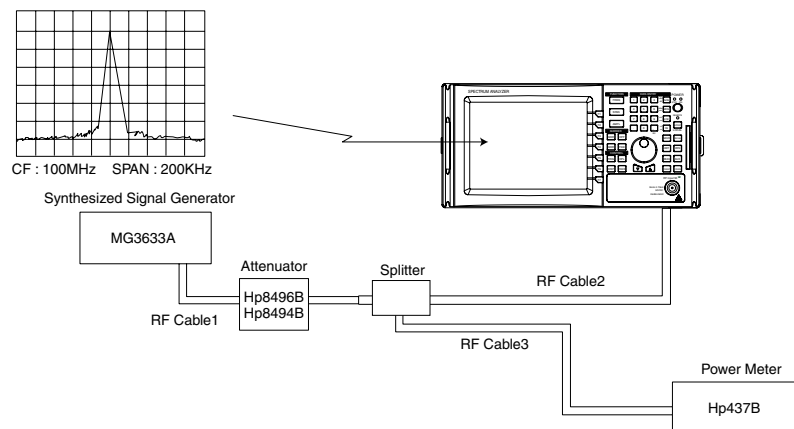

<Reference level Accuracy>

6.3.9.4 Procedure

6.3.9.4.1 Power meter calibration and Reference Calibration

Step	Procedure
------	-----------

1. Connect the Power Meter [HP437B] to Power sensor [HP8481A].
2. Connect the Power sensor to Power Meter input port.
3. Push Power REF button of Power Meter and then display value 0 dBm.
4. If displayed value is not 0 dBm , turn Cal ADJ.
5. Set up the test equipment as shown above.
6. Adjust Signal generator output level to + 10 dBm.

Frequency	:	100 MHz
-----------	---	---------

Power	:	+ 10 dBm
-------	---	----------

7. Press [PRESET] key.
8. Press [ALL CAL] softkey.
9. Set the 2398 as shown below :

Center frequency	:	100 MHz
------------------	---	---------

Reference level	:	0 dBm
-----------------	---	-------

Span	:	50kHz
------	---	-------

RBW	:	3kHz
-----	---	------

VBW	:	10kHz
-----	---	-------

ATT	:	Auto
-----	---	------

10. Adjust Signal generator output level so that the Reference level in the table below is indicated on the power meter until the power meter locks the sensitivity (then just use the 10dB steps of the attenuator).
11. Press [PEAK][MKR - > CF] key to set the spectrum waveform peak to the center of the screen.
Press [MKR- REF LVL].
12. Read the marker level.
13. Calculate Reference level accuracy:
Reference level accuracy = Marker level value - Power meter reference value.

SECTION 6 PERFORMANCE TESTS

Reference level(dBm)	Marker level value (dBm)	Step Attenuator value (dB)	Error
0			
- 10			
- 20			
- 30			
- 40			
- 50			
- 60			
- 70			
- 80			

6.3.10 Average noise level

The internal noise of the spectrum analyzer is measured with this test.

6.3.10.1 Specification

○ Average noise level :

≤ - 80 dBm (frequency range : 50 kHz ~ 100 kHz)

≤ - 100 dBm (frequency range : 100 kHz ~ 1 MHz)

≤ - 105 dBm (frequency range : 1 MHz ~ 2.7 GHz)

6.3.10.2 Test Instruments

○ 50Ω terminator : HP 909F

6.3.10.3 Setup

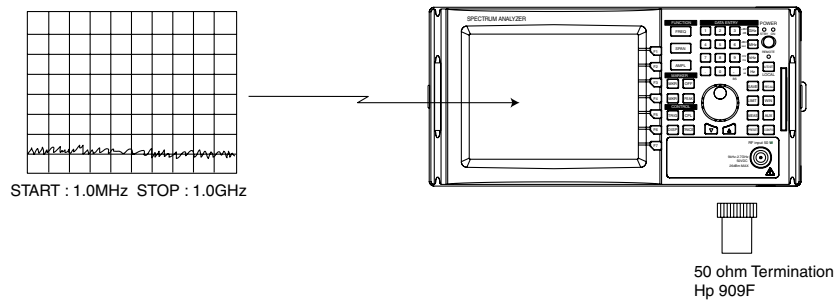

<Average Noise level>

6.3.10.4 Procedure

Step	Procedure
------	-----------

1. Press [PRESET] key.
2. Press [ALL CAL] softkey.
3. Set the 2398 as shown below :

Center frequency	: 10 kHz
Span	: 20 kHz
Reference level	: - 40 dBm
ATT	: 0 dB
RBW	: 300 Hz

VBW : 10 Hz
Detector mode : Negative detect

4. Terminate the RF Input with a 50 Ω terminator.
5. Press [PEAK] [MKR - \rightarrow CF] key to set the spectrum waveform peak to the center of the screen.
6. Change the 2398 as shown below.
7. Press [TRACE] [MORE - \rightarrow AVERAGE - \rightarrow AVERAGE ON - \rightarrow COUNT [16]] key.
8. Press [TRACE] [MORE - \rightarrow AVERAGING - \rightarrow CONTINUE] key to start the averaging and wait until the 16 sweeps has been completed.
9. Press [PEAK] key to execute peak search . At this point read the level value at the marker.

C enter Frequency	Span	Average noise level	Remark
10 kHz	20kHz		
100 kHz			
1 MHz			
2.7GHz			

6.3.11 Second harmonic distortion

The main point of the test is to apply a signal (with harmonic distortion that is lower than the 2398 internal harmonic distortion [at least 20dB below]) to the 2398 and measure the level difference between the fundamental signal and the second harmonic.

A low- distortion signal source can be obtained by a applying signal to the 2398 after passing the signal through a low- pass filter(LPF)

6.3.11.1 Specification

- Second harmonic distortion : $\leq -60\text{dBc}$ @ Input level : - 40 dBm

6.3.11.2 Test Instruments

- Synthesized Signal generator : MG3633A
- RF cable 1,2,3 : N[male] ~ N[male]
- LPF : With attenuation of 70dB or more at twice the fundamental frequencies
- RF splitter
- RF power meter

6.3.11.3 Setup

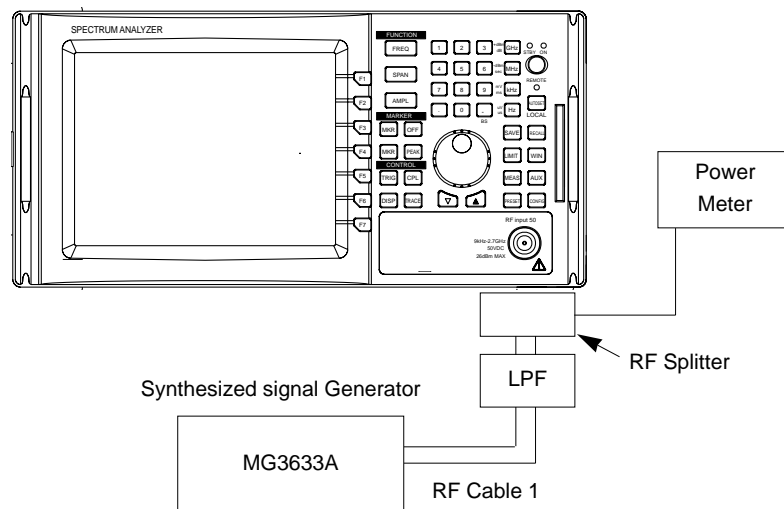

<Second Harmonic Distortion>

6.3.11.4 Procedure

Step	Procedure
------	-----------

1. Press [PRESET] key.
2. Press [ALL CAL] softkey.
3. Set up the 2398 as shown below :

Center frequency	:	95 MHz
Span	:	50 kHz
Reference level	:	- 40 dBm
ATT	:	0 dB
RBW	:	300 Hz
VBW	:	30 Hz
Sweep time	:	Auto

4. Synthesized signal generator as shown below :

Frequency	:	95 MHz
Power	:	- 40 dBm

5. Adjust the signal generator level that the signal measured is - 40dBm on the 2398.
6. Set the Center Frequency to twice the fundamental frequency to display the second harmonic on the screen .
7. Press [PEAK][MKR- > CF] key and calculate the difference from - 40dBm.

Signal generator		Second harmoinc		
Output power	Frequency	marker level	dBc	Frequency
- 40 dBm	95 MHz			190 MHz
	245 MHz			490 MHz
	495 MHz			990 MHz
	995 MHz			1990 MHz

Example : - 40dBm 95MHz - 105dBm 65dBc 190MHz

6.3.12 Input attenuator switching error

This test measures the switching error when the amount of attenuation in the RF input section is switched.

6.3.12.1 Specification

- Input attenuator switching error : ± 0.5 dB (9kHz ~2.7 GHz, total = ± 1 dB maximum)

6.3.12.2 Test Instruments

- Synthesized signal generator : MG3633A
- Step Attenuator : HP8496B , HP8494B
- Power Meter : HP437B
- Power Sensor : HP8481A , HP8481D
- RF Cable 1,2 : N [male] ~ N[male]
- RF Splitter

6.3.12.3 Setup

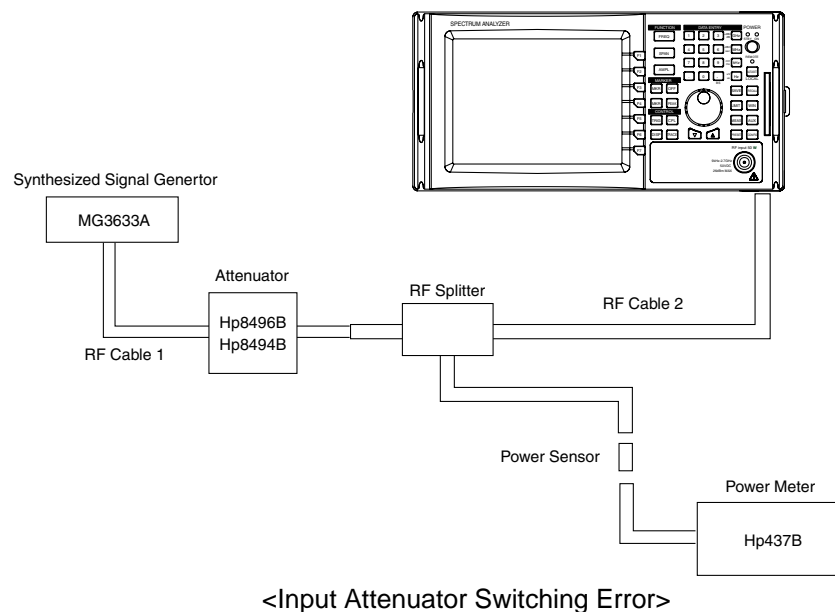

6.3.12.4 Procedure

6.3.12.4.1 Power meter calibration and Signal generator Calibration

Step

Procedure

1. Connect the Power Meter [HP437B] to Power sensor [HP8481A].
2. Connect the Power sensor to Power Meter input port.
3. Push Power REF button of Power Meter and then display value 0 dBm.
4. If display value is not 0 dBm , turn Cal ADJ.

Step	Procedure
------	-----------

1. Press [PRESET] key.
2. Press [ALL CAL].
3. Set the 2398 as shown below :

Center frequency	:	100 MHz
Span	:	100 kHz
Reference level	:	- 50 dBm
RBW	:	3 kHz
VBW	:	30 Hz
Sweep time	:	Auto

4. Set the Signal generator MG3633A as show below:

Frequency	:	100 MHz
Power	:	0 dBm

5. Set the amount of attenuation of the attenuator HP8496B to 0 dB.
6. Adjust the signal generator output level so that the indicated value of the power meter is - 10 dBm.
7. Set the 2398 attenuation to 0 dB .
8. Press [PEAK] key to set the signal peak to the center of the screen.
Read the marker value. Add (or subtract) the difference between the power meter and the 2398 to all amounts in the table(calibration factor).
9. Calculate Input Attenuator switching error.
Error = Marker Level value - Reference value
10. Change the attenuator to other values in the table and repeat steps 7- 9.

2398		Marker level	Error
Reference	ATT		
- 60 dBm	50		
- 50 dBm	40		
- 40 dBm	30		
- 30 dBm	20		
- 20 dBm	10		
- 10 dBm	0		

6.3.13 Residual FM

6.3.13.1 Specification : ≤ 100 Hz(p- p) in 50 ms @ RBW : 1 kHz , VBW : 1 kHz

6.3.13.2 Test Instruments

- Modulation Analyzer : HP8901B
- BNC Cable : BNC[male] ~ BNC[male]

6.3.13.3 Setup

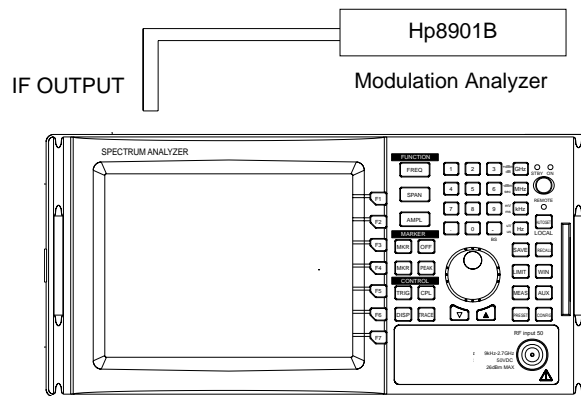

<Residual FM>

6.3.13.4 Procedure

Step	Procedure																		
1.	Press [Preset] key .																		
2.	Press [ALL CAL] softkey.																		
3.	Set the 2398 as shown below :																		
	<table><tr><td>Center frequency</td><td>:</td><td>40 MHz</td></tr><tr><td>Reference level</td><td>:</td><td>- 10 dBm</td></tr><tr><td>Span</td><td>:</td><td>10 kHz</td></tr><tr><td>RBW</td><td>:</td><td>1 kHz</td></tr><tr><td>VBW</td><td>:</td><td>1 kHz</td></tr><tr><td>Sweep time</td><td>:</td><td>Auto</td></tr></table>	Center frequency	:	40 MHz	Reference level	:	- 10 dBm	Span	:	10 kHz	RBW	:	1 kHz	VBW	:	1 kHz	Sweep time	:	Auto
Center frequency	:	40 MHz																	
Reference level	:	- 10 dBm																	
Span	:	10 kHz																	
RBW	:	1 kHz																	
VBW	:	1 kHz																	
Sweep time	:	Auto																	
4.	Set the internal calibration Signal [40MHz] ON.																		
5.	Press [MKR] [MRK - > CF] key to center to the spectrum waveform display on top line of the screen.																		
6.	Press [SPAN] [ZERO SPAN].																		
7.	Connect Modulation Analyzer to Rear Panel IF output and measure frequency modulation.																		

6.3.14 3rd Order Intermodulation

Two signal generator provide the signals required for measuring third order intermodulation.

It is difficult when the input level is - 30dBm because the intermodulation signal is very close in level to the noise.

6.3.14.1 Specification : $\leq - 70 \text{ dBc}$ @ Input : - 30 dBm , Input Att : 10 dB

6.3.14.2 Test Instruments :

- Synthesized Signal Generator 1,2 : MG3633A
- Step Attenuator : HP8494B,HP8496B
- Power Meter : HP437B
- Power Sensor : HP8481A
- Power Combiner : HP11636A
- RF Cable 1,2,3,4 : N [male] ~ N[male]
- RF Cable 5,6,7 : BNC [male] ~ BNC [male]
- Adapter : T- BNC [female]

6.3.14.3 Setup

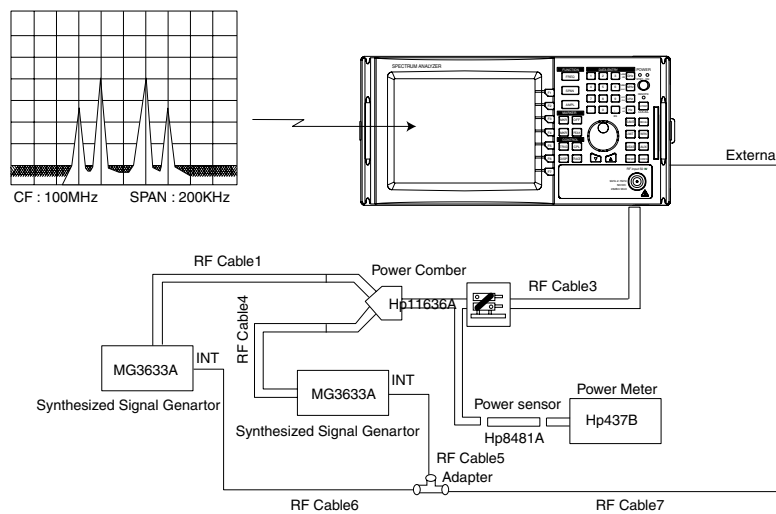

<3rd Order intermodulation>

6.3.14.4 Procedure

6.3.14.4.1 Power meter calibration

Step	Procedure
1.	Connect the Power Meter [HP437B] to Power sensor [HP8481A].
2.	Connect the Power sensor to Power Meter input port.
3.	Push Power REF button of Power Meter and then display value 0 dBm.
4.	If display value is not 0 dBm , turn Cal ADJ.
5.	Set up synthesized signal generators as shown on previous page. Synthesized signal generator 1 Frequency : 1100.050 MHz Power : - 20 dBm Synthesized signal generator 2 Frequency : 1100.000 MHz Power : - 20 dBm

6.3.14.4.2 Measurement of 3rd Order Intermodulation

Step	Procedure																					
1.	Press [PRESET] key .																					
2.	Press [ALL CAL] softkey.																					
3.	Set the 2398 as shown below :																					
	<table><tbody><tr><td>Center frequency</td><td>:</td><td>1100.025 MHz</td></tr><tr><td>Reference level</td><td>:</td><td>- 10 dBm</td></tr><tr><td>Span</td><td>:</td><td>500 kHz</td></tr><tr><td>ATT</td><td>:</td><td>0 dBm</td></tr><tr><td>RBW</td><td>:</td><td>Auto</td></tr><tr><td>VBW</td><td>:</td><td>Auto</td></tr><tr><td>Sweep Time</td><td>:</td><td>Auto</td></tr></tbody></table>	Center frequency	:	1100.025 MHz	Reference level	:	- 10 dBm	Span	:	500 kHz	ATT	:	0 dBm	RBW	:	Auto	VBW	:	Auto	Sweep Time	:	Auto
Center frequency	:	1100.025 MHz																				
Reference level	:	- 10 dBm																				
Span	:	500 kHz																				
ATT	:	0 dBm																				
RBW	:	Auto																				
VBW	:	Auto																				
Sweep Time	:	Auto																				

4. Turn generator #2 RF off. Adjust signal generator #1 level so that power meter reads - 20dBm.
5. Turn generator #1 RF off and generator #2 on.
6. Adjust signal generator #2 level so that power meter reads - 20dBm.
7. Turn RF on for both signal generator.
8. Press [PEAK] [PEAK] key to set the normal marker to one at the two signals at - 20dBm.
9. Press [\sphericalangle marker] key.
10. Move normal marker to peak of the intermodulation product signal.
11. To calculate the intermodulation performance and the \sphericalangle marker value plus 20dB.
12. Example \sphericalangle marker = 60dB.
Intermodulation performance = $60 + 20 = 80$ dB.

6.3.15 Spurious Response

This test measures spurious frequency levels in the 2398.

The RF Input is terminated and 0 dB Input attenuation is selected.

6.3.15.1 Specification : ≤ -85 dBm @ Input Terminated , Input Att : 0 dB

6.3.15.2 Test Instruments

○ 50 ohm Termination : HP 909A

6.3.15.3 Setup

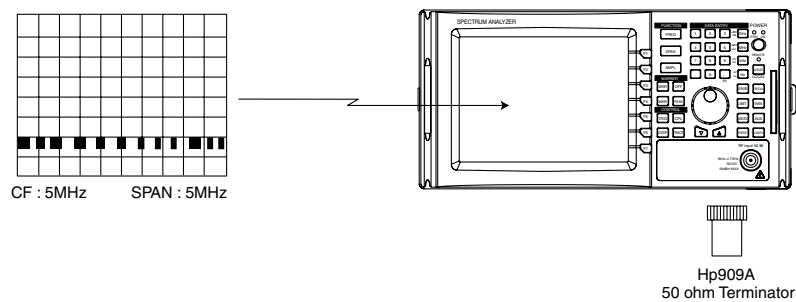

<Residual Response>

6.3.15.4 Procedure

Step	Procedure
------	-----------

1. Press [PRESET] key.
2. Press [ALL CAL] softkey.
3. Set up the 2398 as shown below :

Center frequency	: 1300 MHz
Span	: full
Reference level	: - 40 dBm
ATT	: 0 dB
RBW	: 1 kHz
VBW	: 1 kHz
Sweep Time	: Auto
Detector Mode	: POS Peak

4. Press [DISP] [DISPLAY LN (ON) => DISPLAY LINE] key and rotate knob to - 85 dBm .
5. Press [TRIG] [SINGLE] key . Wait for completion of the sweep
6. Any residual responses must be below the display line .
7. Press [MKR] [PEAK SEARCH] key and record marker amplitude.

Marker Amplitude (dBm)	2398 Specification (dBm)

6.3.16 Local Oscillator Emission

This test measures, the Local Emission power from the input of spectrum analyzer.
 This is measure of how well the local oscillator is isolated from the RF input connector.

6.3.16.1 Specification : ≤ -70 dBm @ Input Att : 10 dB

6.3.16.2 Test Instruments

- Spectrum Analyzer : IFR2390
- RF Cable : N [male] ~ N [male]

6.3.16.3 Setup

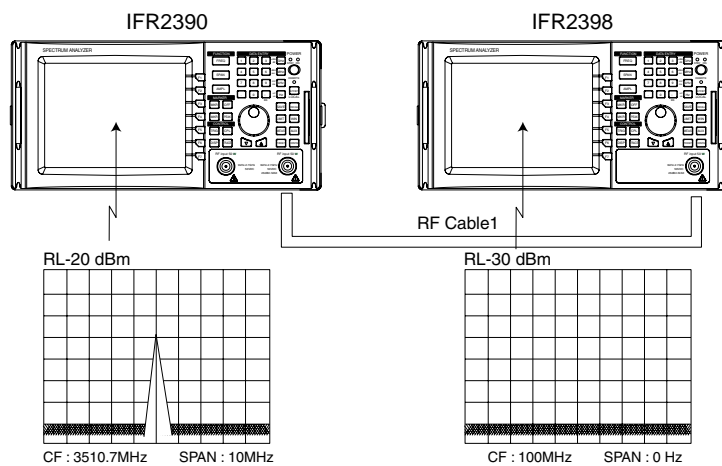

6.3.16.4 Procedure

<LO Emission>

1. Press [PRESET] key.
2. Press [ALL CAL] softkey.
3. Set up the 2398 as shown below

Center frequency	:	100 MHz
Span	:	Zero Span
Reference level	:	- 30 dBm
ATT	:	0 dB

4. Set the IFR2390 as shown below :

Center frequency : 3410.7 MHz + Center Frequency of 2398

Span : 100 kHz

Reference level : - 150 dBm

RBW : 3 kHz

VBW : 1 kHz

5. Read the power level of IFR2390 and record.

6. Press [FREQ] [CENTER] key to change 2398 center frequency.

The IFR2390 must also change the center frequency .

7. Repeat step 5 through 6.

2398 Center frequency	Measured Power (dBm)	2398 Specification
100 MHz		$\leq - 70$ dBm
500 MHz		
1000 MHz		
1500 MHz		
2000 MHz		
2500 MHz		

6.3.17 Input VSWR

This test verifies the Input VSWR of the spectrum analyzer .

6.3.17.1 Specification : $\leq 1.5 : 1$ @ input Att : 10 dB 150kHz ~ 2.7GHz

6.3.17.2 Test Instruments

- Network Analyzer 1 : HP 8720D
* frequency Range : 50 MHz ~ 20 GHz
- Network Analyzer 2 : HP 8751A
* frequency Range : 5 Hz ~ 500 MHz
(S- parameter [HP87511A] : 100 kHz ~ 500 MHz)
- Calibration Cable : HP 85131- 60012 [3.5 mm flexible]
HP 85131- 60013 [3.5 mm flexible]
- Calibration Kit : HP85052B [3.5 mm Calibration Kit]
HP 85032B [Type N Calibration Kit]
- Adapter : SMA [female] ~ N [male]

6.3.17.3 Setup

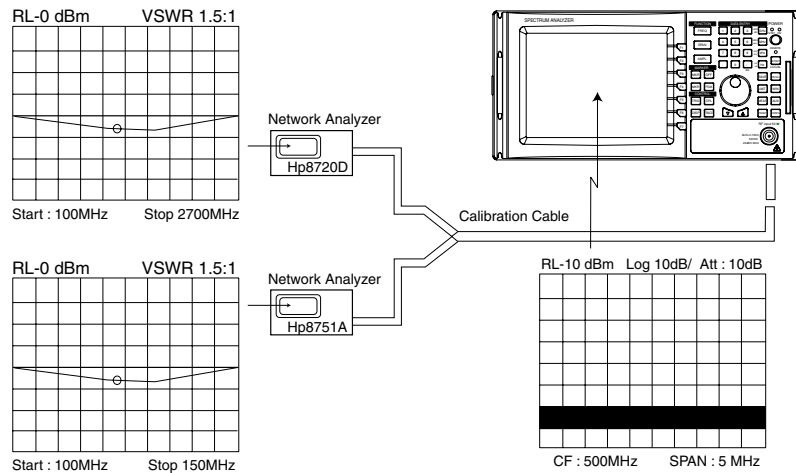

<Input VSWR>

6.3.17.4 Procedure

1. Follow the Network Analyzer calibration procedure.
2. Preset [PRESET] key on 2398

2398 Specification	Measured Value
$\leq 1.5 : 1$	

SECTION 7

STORAGE AND TRANSPORTATION

This section describes the long term storage, repacking and transportation of the 2398 as well as the regular care procedures and the timing.

TABLE OF CONTENTS

Cleaning Cabinet	7- 3
Storage Precautions	7- 4
Precautions before storage	7- 4
Recommended storage precautions	7- 4
Repacking and Transportation	7- 5
Repacking	7- 5
Transportation	7- 5
Service	7- 6

⟨BLANK⟩

SECTION 7 STORAGE AND TRANSPORTATION

Cleaning Cabinet

Always turn the 2398 POWER switch OFF and disconnect the power plug from the AC power inlet before cleaning the cabinet.

To clean the external cabinet :

- Use a soft, dry cloth for wiping off.
- Use a cloth moistened with diluted neutral cleaning liquid if the instrument is very dirty or before long term storage.
After insuring that the cabinet has been thoroughly dried, use a soft, dry cloth for wiping off.
- If loose screws are found, tighten them with the appropriate tools.

CAUTION 

Never use benzene, thinner, or alcohol to clean the external cabinet : it may damage the coating, or cause deformation or discoloration.

Storage Precautions

This paragraph describes the precautions to take for long term storage of the 2398 SPECTRUM ANALYZER.

Precautions before storage

- (1) Before storage, wipe dust, finger marks, and other dirt off of the 2398.
- (2) Avoid storing the 2398 where :
 - 1) It may be exposed to direct sunlight or high dust levels.
 - 2) It may be exposed to high humidity.
 - 3) It may be exposed to active gases.
 - 4) It may be exposed to extreme temperatures ($> 50^{\circ}\text{C}$) or high humidity($\geq 90\%$).

Recommended storage precautions

The recommended storage conditions are as follows :

- o Temperature 0 to 30°C
- o Humidity 40% to 80%
- o Stable temperature and humidity over 24- hour period.

Repacking and Transportation

The following precautions should be taken if the 2398 must be returned to IFR for servicing.

Repacking

Use the original packing materials. If the 2398 is packed in other materials, observe the following packing procedure:

- (1) Wrap the 2398 in a plastic sheet or similar material.
- (2) Use a corrugated paper, wooden box, or aluminum case which allows shock- absorbent material to be inserted on all sides of the equipment.
- (3) Use enough shock- absorbent material to protect the 2398 from shock during transportation and to prevent it from moving in the container.
- (4) Secure the container with packing straps, adhesive tape or bands.

Transportation

Do not subject the 2398 to severe vibration during transport. It should be transported under the recommended storage conditions.

Service

If the 2398 is damaged or does not operate as specified, contact your nearest IFR dealer or business office for repair. When you request repair, provide the following information:

- (a) Model name and serial number on rear panel.**
- (b) Fault description.**
- (c) Name of a personnel- in- charge and address for contact when fault confirmed or at completion of repair.**

IFR AMERICAS
10200 West York Street
Wichita, KS 67215
Phone : 316-522-4981
FAX : 316-524-2623

Email : @ifrsys.com
Web site : www.ifrinternational.com

IFR LIMITED
Longacres House
Norton Green Road
Stevenage, Herts
England SG1 2BA
Phone : 44 (0) 1438 742200
FAX : 44 (0) 1438 742010

Email : @ifrinternational.co.uk
Web site : www.ifrinternational.com

 **IFR Americas, Inc.**