

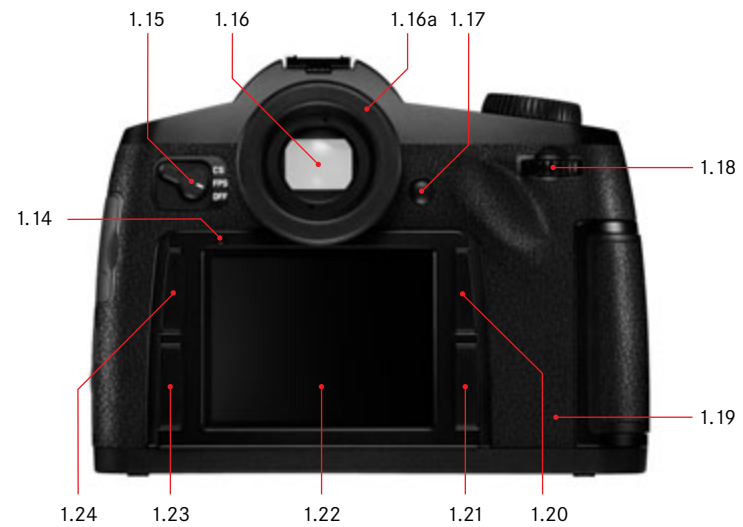

LEICA S2

Instructions

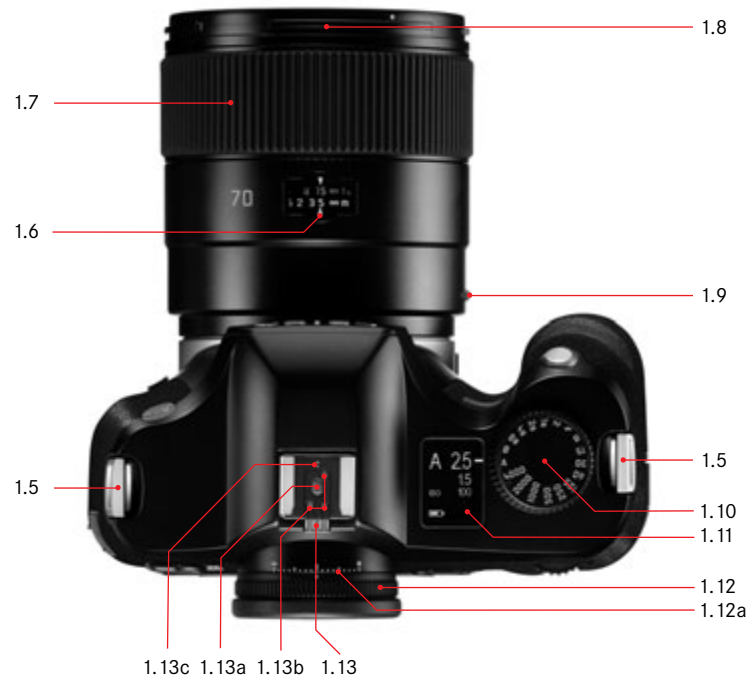



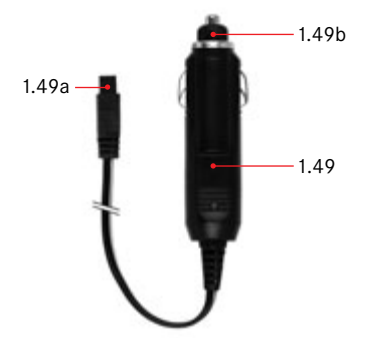
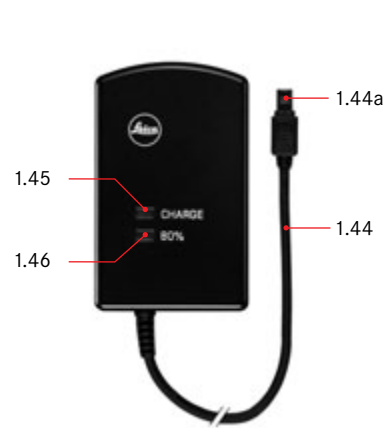
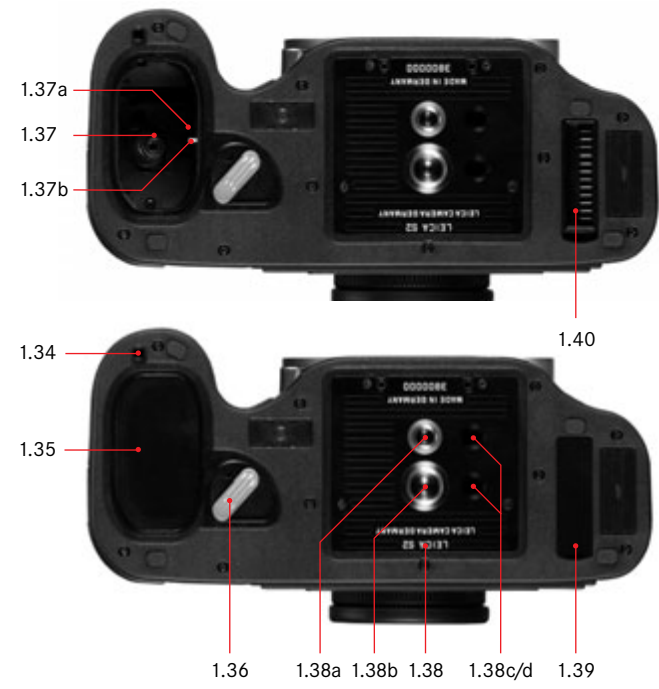



LEICA S2

Instructions

This is a Class B product based on the standard of the Voluntary Control Council for Interference from Information Technology Equipment (VCCI). If this is used near a radio or television receiver in a domestic environment, it may cause radio interference. Install and use the equipment according to the instruction manual.

FCC Note: (U.S. only)

This equipment has been tested and found to comply with the limits for a Class B digital device, pursuant to Part 15 of the FCC Rules. These limits are designed to provide reasonable protection against harmful interference in a residential installation. This equipment generates, uses, and can radiate radio frequency energy and, if not installed and used in accordance with the instructions, may cause harmful interference to radio communications. However, there is no guarantee that interference will not occur in a particular installation. If this equipment does cause harmful interference to radio or television reception, which can be determined by turning the equipment off and on, the user is encouraged to try to correct the interference by one or more of the following measures:

- Reorient or relocate the receiving antenna.
- Increase the separation between the equipment and receiver.
- Connect the equipment into an outlet on a circuit different from that to which the receiver is connected.
- Consult the dealer or an experienced radio/TV technician for help.

FCC Caution:

To assure continued compliance, follow the attached installation instructions and use only shielded interface cables with ferrite core when connecting to computer or peripheral devices. Any changes or modifications not expressly approved by the party responsible for compliance could void the user's authority to operate this equipment.

Trade Name: LEICA
Model No.: LEICA S2
Responsible party/
Support contact: Leica Camera Inc.
1 Pearl Count, Unit A
Allendale, New Jersey 07401
Tel.: +1 201 995 0051 232
Fax: +1 201 995 1684
e-mail: olesin@aol.com

This device complies with Part 15 of the FCC Rules. Operation is subject to the following two conditions:
(1) This device may not cause harmful interference, and (2) this device must accept any interference received, including interference that may cause undesired operation.

This Class B digital apparatus complies with Canadian ICES-003

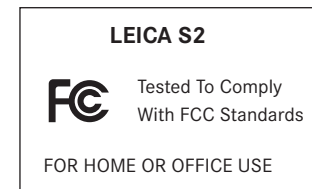

Foreword

Dear Customer,

Leica would like to thank you for purchasing the LEICA S2 and congratulate you on your choice. With this unique digital SLR camera, you have made an excellent selection. We wish you a great deal of pleasure and success using your new LEICA S2. In order to make best use of all the opportunities offered by this high performance camera, we recommend that you first read these instructions.

This manual has been printed on 100% chlorine free bleached paper. The complex manufacturing process eases the burden on the water system and thus helps to protect our environment.

Contents



**FIRMWARE
UPDATE**

Notice: Wherever you see this sign, it indicates improvements to the camera's functions. In order to access the respective detailed descriptions, just click on the sign.

Foreword	3
Warning messages.....	6
CE notice	6
Legal notes	6
Disposal of electrical and electronic equipment	6
Scope of delivery	7
Designation of parts	8
Displays	
In the viewfinder	9
In the top panel display	10
In the monitor.....	11
Menu items.....	13
Preparations	
Attaching the carrying strap	14
Charging the battery.....	14
Inserting / removing the battery to/from the camera.....	17
Charge level displays	17
Inserting and removing the memory cards	17
Changing the focusing screen.....	19
Leica S lenses	20
Attaching and removing the lens	20
Eyepiece adjustment.....	21
Turning the camera on and off	
Automatic power off.....	21
Menu control / Settings	
Menu control	22
Navigating in the menu /	
Setting the functions	22
Quick access to menu functions.....	25

Presets

Basic settings for the camera	
Menu language	26
Date and time	26
Automatic power off	26
Button acknowledgement and signal tones	27
Monitor and top panel display	27
Basic picture settings	
File format / Compression rate	28
White balance	29
Automatic and fixed settings	29
Direct setting of color temperature.....	29
Manual setting by metering	29
ISO sensitivity.....	30
Image properties	
(contrast, sharpness, color saturation)	31
Working color space.....	31
Storage of picture data / memory card management.....	31

Picture mode

Shutter release button.....	32
Serial exposures	32
Setting the focus	33
Manual focus setting - MF	33
Automatic focus setting	
AFs	33
AFc	33
Exposure metering	
Exposure metering methods	34
Spot metering	34
Center-weighted metering.....	34
Multiple field metering	34
Metering memory lock.....	34
Exposure compensation	35
Bracketing	35
Values above and below the metering range.....	36

Exposure control

Manual shutter speed and aperture setting /	
Selecting the exposure mode	37
Shutter speed dial	37
Click wheel	37
Exposure modes	
Programmed automatic exposure mode	38
Program shift	38
Aperture priority	38
Shutter priority.....	39
Manual aperture and shutter speed setting	39
The B (Bulb) setting.....	39
Taking photographs with the self-times	40
Mirror pre-release.....	40
Depth of field preview button and depth of field	41

Additional functions

User / application specific profiles.....	41
Resetting all custom settings	41
Folder management.....	42
Formatting the memory card(s)	42

Flash photography

General information on flash exposure	
metering and control	43
Compatible flash units.....	43
Flash sync speed	43
Selecting the sync speed /	
the sync speed range.....	43
Selecting the firing moment.....	44
Attaching the flash unit.....	44
Settings for camera-controlled automatic flash mode	44
TTL flash mode.	44
High Speed Synchronisation.....	44
Strobe flash mode with system compatible flash units.....	45
Flash displays in the viewfinder with system compatible	
flash units.....	45
Flash with flash unit automatic mode	45
Manual flash with constant flash output.....	45
Flash using the X contact	45
Flash using the flash connection socket.....	45

Preview mode

Selecting record and review modes.....	46
Review for unlimited time	46
Automatic review of the last picture - Auto Review	46
Normal review 4.1	47
INFO -review 4.2.....	47
The histogram.....	47
Picture data review 4.3.....	47
Viewing other pictures / „Scrolling“ in the memory.....	48
Image Review- Zoom	48
Selecting the amount of zoom	48
Simultaneously viewing several smaller pictures	49
Selecting one of the smaller pictures	49
Switching to the other memory card	49
Protecting pictures / Clearing delete protection	50
Deleting pictures.....	51

Additional functions

Transferring data to a computer	52
via USB connection	52
Connecting and transferring data	
using the PTP protocol	52
Connecting and transferring data	
with the camera as an external drive	53
Connecting and transferring data using card readers	53
Data structure on the memory card	53
Adobe® Photoshop® Lightroom®	53
LEICA Image Shuttle.....	53
Installing firmware updates	54
HDMI slide show	54

Miscellaneous

System accessories	
Interchangeable lenses.....	55
Filters	55
Auswechselbare Einstellscheiben	55
Flash units	55
Handgrip S2.....	55
S Pro battery charger.....	55
Remote release cable S	55
Connection cords	55
Spare parts.....	55
Maintenance tips for your LEICA S2 and lenses	
Precautions and care instructions	56
General precautions	56
Sensor	56
Condensation	57
Care instructions	57
For the camera	57
For lenses	57
For the battery	57
For the charger	57
For memory cards.....	57
Cleaning the sensor	58
Storage	59
Index	60
Technical Data	62
Leica Academy	64
Leica on the Internet	64
Leica information service	64
Leica customer service.....	64

Warning messages

- Modern electronic components react sensitively to electrostatic discharge. As people can easily pick up charges of tens of thousands of volts, by walking on synthetic carpets for example, a discharge can occur when you touch your LEICA S2, particularly if it is placed on a conductive surface. If only the camera housing is affected, this discharge is harmless to the electronics. However, despite built-in safety circuits, the outer contacts, such as those on the base of the camera, should not be touched if at all possible for safety reasons.
- For any cleaning of the contacts, do not use an optical microfiber cloth (synthetic); use a cotton or linen cloth instead. Before touching the contacts, you can make sure you discharge any electrostatic charge by deliberately touching a heating or water pipe (conductive, earthed material). You can also avoid soiling and oxidization of the contacts by storing your LEICA S2 in a dry place with the lens or bayonet cover fitted.
- You should exclusively use the recommended accessories to prevent faults, short circuits or electric shock.
- The LEICA S2 is protected against splashed water and dust. However, it should not be continuously exposed to rain and should never be submerged in water.
- Do not attempt to remove parts of the body (covers); specialist repairs can be carried out only at authorized service centers.

The CE identification of our products documents adherence to the fundamental requirements of the valid EU guidelines.

Legal notes

- Please ensure that you observe copyright laws. The recording and publication of pre-recorded media such as tapes, CDs, or other published or broadcast material may contravene copyright laws.
- This also applies to all of the software supplied.
- The SD, HDMI, CF and USB logos are registered trademarks.
- Other names, company or product names referred to in this manual are trademarks or registered trademarks of the relevant companies.



Disposal of electrical and electronic equipment

(Applies within the EC, and for other European countries with segregated waste collection systems)

This device contains electrical and/or electronic components and should therefore not be disposed of in general household waste! Instead it should be disposed of at a recycling collection point provided by the local authority. This costs you nothing. If the device itself contains replaceable (rechargeable) batteries, these must be removed first and, if necessary, also be disposed of in line with the relevant regulations. Your local authority or waste disposal authority, or the store where you bought this device, can provide you with further information on this issue.

Scope of delivery

Before using your LEICA S2 for the first time, please check that the accessories supplied are complete.

- A. Battery
- B. Charger
- C. Power plug
- D. USB connecting cord
- E. Carrying strap
- F. Bayonet cap
- G. Eyepiece protective cover

Designation of parts

Front view

- 1.1 Shutter release button
- 1.2 Self-timer LED / Sensor for white balance
- 1.3 Depth of Field Preview button
- 1.4 Bayonet with
 - a. Contact strip
 - b. Index point for attaching the lens
 - c. Unlocking button

Top view

- 1.5 Carrying strap clip
- 1.6 Window for distance scale
- 1.7 Distance setting ring
- 1.8 Bayonet for lens hood
- 1.9 Red alignment button for changing lens
- 1.10 Shutter speed click wheel with additional indented positions for
 - A (shutter priority)
 - B (long-time exposures)
- 1.11 Top panel display
- 1.12 Diopter setting dial with
 - a. Scale
- 1.13 Flash unit shoe with
 - a. Center (flash) and
 - b. Control contacts
 - c. Hole for retaining pin

Rear view

- 1.14 Brightness sensor
- 1.15 Main switch with indented positions
 - a. **OFF** Camera turned off
 - b. **FPS** Focal plane shutter in camera activated
 - c. **CS** Central shutter in lens activated
- 1.16 Viewfinder with
 - a. Setting-ring
 - b. Eyecup
- 1.17 Autofocus and exposure metering memory button
- 1.18 Click wheel
- 1.19 LED indicating picture mode / recording data to card
- 1.20 Menu control button
- 1.21 Menu control button
- 1.22 Monitor
- 1.23 Menu control button
- 1.24 Menu control button

View from right

- 1.25 Door (closed)
Door open (detail):
- 1.26 CF card slot with
 - a. Eject button
- 1.27 SD card slot

View from left

- 1.28- Covers (closed)
- 1.29 Covers open (detail):
- 1.30 Flash connector socket.
- 1.31 HDMI socket
- 1.32 Remote control socket
- 1.33 Data output socket

Bottom view

- 1.34 Hole for portrait format handle guide pin
- 1.35 Battery
- 1.36 Battery release lever
- Detail:
- 1.37 Battery bay (battery removed) with
 - a. Contacts
 - b. Guide-rail
- 1.38 Tripod mounting with
 - a. 1/4" thread
 - b. 8/8" thread
 - c.-d. Holes for alignment
- 1.39 Cover (closed)
Cover removed (detail):
- 1.40 Contact strip for Battery Grip S

Battery

- 1.41 Guide groove
- 1.42 Contacts
- 1.43 Socket for charging plug

Charger

- 1.44 Fixed battery connecting cord with
 - a. 3-pin connector
- 1.45 Green (**CHARGE**)
LED indicating charging in progress
- 1.46 Orange (**80%**) LED indicating charge level
- 1.47 2-pin socket for car charging cord
- 1.48 interchangeable mains plugs (EU/UK/AUS) with
 - a. Release button
 - b. US mains pins (interchangeable connectors removed, US pins extended)
- 1.49 Car charging cord with
 - a. 2-pin connector for charger, and
 - b. Plug for cigarette lighter

Displays

2. In the viewfinder

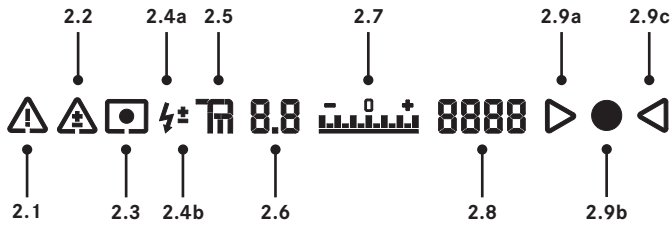

- 2.1 Indication of warning message on the monitor
- 2.2 Exposure compensation indicator
- 2.3 Metering method symbol
(not displayed for metering memory lock)
 - a. = Multiple field metering
 - b. = Center-weighted metering
 - c. = Spot metering
- 2.4 Flash displays
 - a. Flashing = Flash charging, flash not ready; Lit = Flash ready
 - b. Lit = Flash exposure compensation set
- 2.5 Exposure mode
 - a. **P** = Automatic program mode
 - b. **A** = Aperture priority
 - c. **T** = Shutter speed priority
 - d. **m** = Manual shutter speed and exposure setting
- 2.6 Aperture, manually set value for **m** and **A**, automatically controlled value for **T** and **P**; displayed in half steps
- 2.7 Light balance (small/large markings: $\frac{1}{2}$ EV/1 EV-step each) for indicating
 - a. Manual exposure compensation
 - b. Variation between current metered and stored value (with metering memory lock in automatic exposure modes **A**, **P**, **T**)
- 2.8 Shutter speed / exposure time
 - a. Manually set value for **m** and **T**, automatically controlled value for **A** and **P**; displayed in half steps, or
 - b. **H** (high) or **L** (low) for over or under exposure modes **A**, **P**, **T** and due to flash light, or **L** if below metering range.
 - c. **bulb** B-setting for long-time exposures
- 2.9 Focus displays
 - a. Only appears in manual mode or with manual override of AF: Continuously lit if setting is too long
 - b. In manual mode: Continuously lit if setting is correct, flashes if correct setting is not possible, In **AFc**: Continuously lit if setting is correct, goes out if focusing procedure is restarted,
 - c. Only appears in manual mode or with manual override of AF: Continuously lit if setting is too short



Note:

The viewfinder LCD is always lit up when the power is turned on (see "Turning the camera on / Activating the electronics / exposure metering system, p. 21). The brightness of this illumination is automatically adjusted to the external lighting conditions to give optimum readability.

Displays

3. In the top panel display

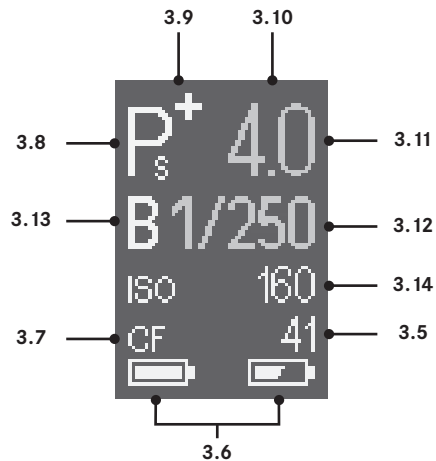
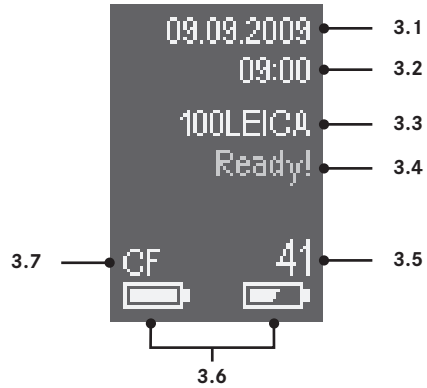

Start screen

(appears for 4s after turning on the camera, can be switched to the standard screen at any time by tapping the shutter release button)

- 3.1 Date
- 3.2 Time
- 3.3 Folder name
- 3.4 Camera ready
- 3.5 Picture number or warning message (see 3.7)
- 3.6 Battery capacity (left for camera battery, right for hand grip battery if attached)
- 3.7 Memory card used, or warning messages (red):
No card = No memory card inserted,
Full = Selected memory card full,
Error = Card error

Standard screen

(white displays: manually set, yellow displays: set with click wheel, green displays: set automatically)

- 3.8 Exposure mode
- 3.9 a. +/- Exposure compensation set
b. +/-0/- Progression of automatic bracketing:
Overexposed / correctly exposed / underexposed shot produced
- 3.10 Program shift set
- 3.11 Aperture
- 3.12 Shutter speed
- 3.13 Long time exposure
- 3.14 Sensitivity
- 3.5 Picture number or warning message* (see 3.7)
- 3.6 Battery capacity (left for camera battery, right for hand grip battery if attached)
- 3.7 Memory card used, or warning messages (red):
No card = No memory card inserted
Full = Selected memory card full
Error = Card error

Displays

4. In the monitor

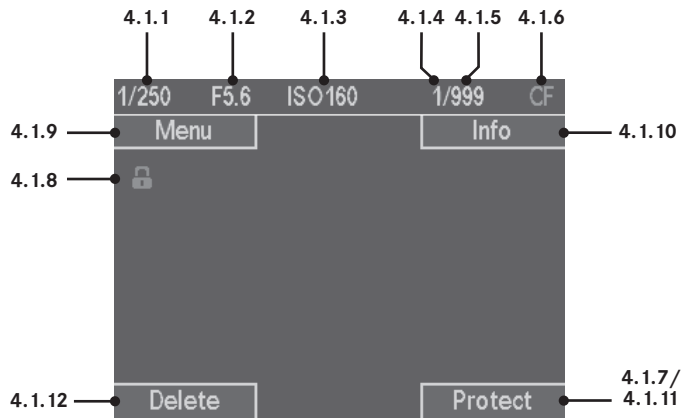

4.1 Normal play mode

(pictures(s) fill the entire monitor area)

- 4.1.1 Shutter speed
- 4.1.2 Aperture
- 4.1.3 Sensitivity
- 4.1.4 Number of picture(s) shown
- 4.1.5 Total number of pictures on selected memory card
- 4.1.6 Selected memory card
- 4.1.7  Size and position of section (PLAY only; does not appear if 4.18-4.1.11 are shown)
- 4.1.8 Symbol for protected pictures (only appears for delete or protection operations)
- 4.1.9- Indication of functions of buttons 1.20/.21/.23/.24
- 4.1.12 (only appear after pressing one of the 4 buttons; go out again after 5s))

4.2 Additional information for INFO review

(reduced picture)

- 4.2.1 Histogram
- 4.2.2 Function of button 1.20
- 4.2.3 Symbol for protected pictures (only appears for delete or protection operations)
- 4.2.4 Symbol for HDMI slideshow (only appears for selected pictures)
- 4.2.5 Date
- 4.2.6 Time
- 4.2.7 Exposure metering method
- 4.2.8 Exposure compensation
- 4.2.9 Focal length
- 4.2.10 Flash exposure compensation
- 4.2.11 White balance
- 4.2.12 Resolution
- 4.2.13 Compression / file format
- 4.2.14 User profile number
- 4.2.15 Size and position of section (PLAY only)
- 4.2.16 Folder number / file name

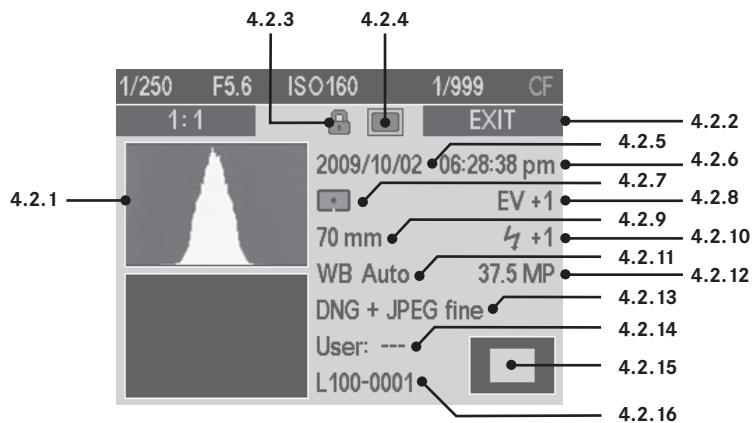

Displays

4. In the monitor (cont.)

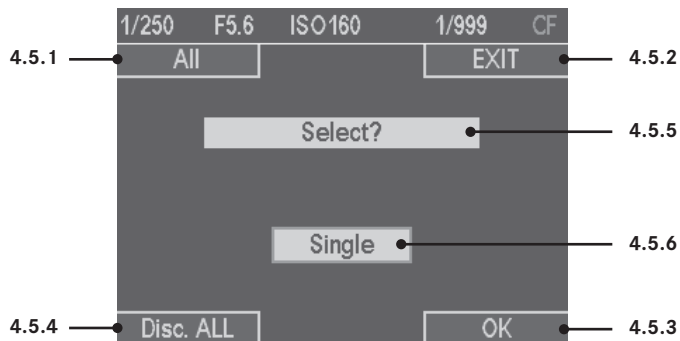
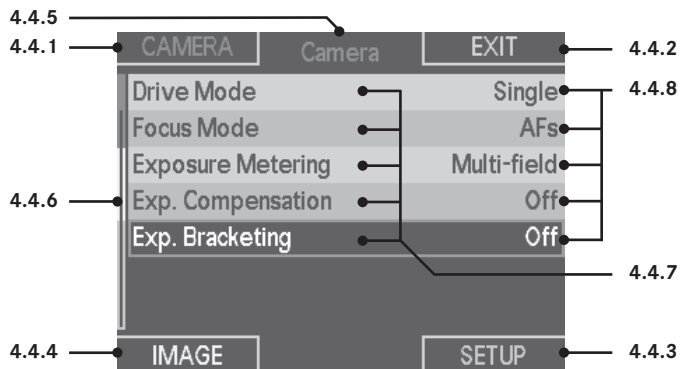
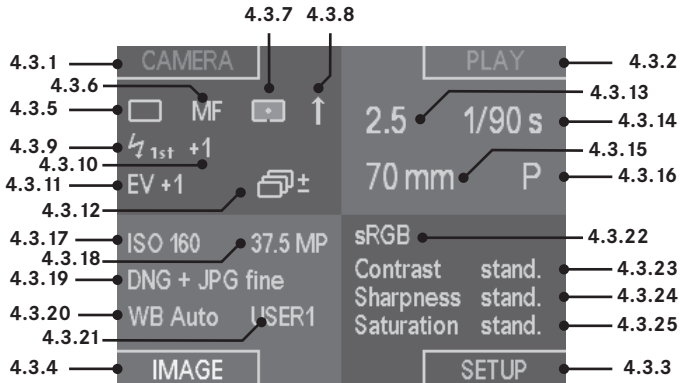

4.3 Image data review

4.3.1- Functions of buttons 1.20/.21/.23/.24
4.3.4

Top left quadrant, settings in **CAMERA** menu

4.3.5 Picture sequence
4.3.6 Focus setting
4.3.7 Exposure metering method
4.3.8 Mirror pre-release
4.3.9 Flash synchronization
4.3.10 Flash exposure compensation
4.3.11 Exposure compensation
4.3.12 Bracketing

Top right quadrant, picture settings

4.3.13 Aperture
4.3.14 Shutter speed
4.3.15 Focal length
4.3.16 Exposure mode

Bottom left quadrant, settings in **IMAGE** menu

4.3.17 Sensitivity
4.3.18 Resolution
4.3.19 File format / Compression
4.3.20 White balance
4.3.21 User profile

Bottom right quadrant, settings in **IMAGE** menu

(no displays if only **DNG** set
[see p. 28])
4.3.22 Color space
4.3.23 Contrast
4.3.24 Sharpness
4.3.25 Saturation

4.4 Menu control

4.4.1- Functions of buttons 1.20/.21/.23/.24
4.4.4

4.4.5 Current menu sections displayed
4.4.6 Scroll bar indicating current menu screen displayed
4.4.7 Menu functions
4.4.8 Current settings for menu functions

4.5 HDMI picture selection / Protecting / Deleting

4.5.1- Function of buttons
4.5.4 1.20/.21/.23/.24
4.5.5 Selected function
4.5.6 Picture(s) to be selected

Menu items



CAMERA menu

Page 1	5.1	Drive mode	Single picture/picture series/self timer
	5.2	Focus Mode	AFs / AFc / MF
	5.3	Exposure Metering	
	5.4	Exposure Compensation	
	5.5	Exposure Bracketing	Automatic bracketing
Page 2	5.6	Auto Slow Synch	Limits the shutter speeds used
	5.7	Flash Synch Mode	Start or end of exposure
	5.8	Mirror up Mode	

IMAGE menu

 FIRMWARE UPDATE	Page 3	5.9	ISO	sensitivity
		5.10	File Format	File format / compression rate
		5.11	White Balance	
		5.12	Colour Management	Working color space
		5.13	User Profile	User-specific profile
Page 4	5.14	Contrast	Picture contrast	
	5.15	Sharpness	Picture sharpness	
	5.16	Saturation	Picture saturation	

SETUP menu

 FIRMWARE UPDATE	Page 5	5.17	Data Storage	Selection of how data is stored on the memory cards or on an external memory
		5.18	Image Numbering	
		5.19	Format	Format the memory card(s)
		5.20	USB Mode	Identifies the camera as an ext. drive or based on the PTP protocol
		5.21	Sensor-Cleaning	Open shutter for cleaning the sensor
  FIRMWARE UPDATE	Page 6	5.22	Reset	Simultaneously resets all settings (to original factory settings)
		5.23	Auto review	Automatic review of the last picture taken
		5.24	Histogram	Graphic indicating distribution of brightness
		5.25	Monitor/Display	Monitor and top panel display Settings
		5.26	Auto Power Off	
	5.27	Acoustic Signal	Acknowledgement tones / Signal for memory card capacity limit	
Page 7	5.28	HDMI	Settings for playing the slide show	
	5.29	Custom Functions	Assignment of functions for buttons 1.21, 1.23, 1.24	
	5.30	AE/AF-Lock	Assignment of memory functions to shutter release button and/or button 1.17	
	5.31	Zoom Lock	Retain zoomed view when scrolling	
	5.32	Date		
	5.33	Time		
	5.34	Language	Language	
	5.35	Firmware	Firmware version (info only, cannot be adjusted)	

Preparations

Attaching the carrying strap

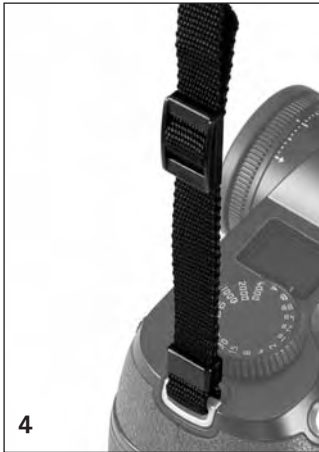

Charging the battery

The LEICA S2 is supplied with the required power by a lithium ion battery (A).

Attention:

- Only the battery type specified and described in this manual, and/or battery types specified and described by Leica Camera AG, may be used in this camera.
- This battery may only be used in the units for which it is designed and may only be charged exactly as described below.
- Using this battery contrary to the instructions and using non-specified battery types can under certain circumstances result in an explosion.
- The batteries may not be exposed to sunlight, heat, humidity or moisture for long periods. Likewise, the battery may not be placed in a microwave oven or a high-pressure container to prevent a risk of fire or explosion.
- Never throw batteries into a fire as this can cause them to explode!
- Humid or wet batteries may not be charged or used in the camera under any circumstances.
- Always ensure that the battery contacts are clean and freely accessible. Whilst lithium ion batteries are proof against short circuits, they should still be protected against contact with metal objects such as paper clips or jewelry. A short-circuited battery can get very hot and cause severe burns.
- If a battery is dropped, check the casing and the contacts immediately for any damage. Using a damaged battery can damage the camera.

- In case of noise, discoloration, deformation, overheating of leaking fluid, the battery must be removed from the camera or charger immediately and replaced. Continued use of the battery carries a risk of overheating, resulting in fire and/or explosion.
- In case of leaking fluid or a smell of burning, keep the battery away from sources of heat. Leaked fluid can catch fire.
- Only the charger specified and described in this manual, or other chargers specified and described by Leica Camera AG, may be used. The use of other chargers not approved by Leica Camera AG can cause damage to the batteries and, in extreme cases, to serious or life-threatening injuries.
- The charger supplied should be used exclusively for charging this battery type. Do not attempt to use it for other purposes.
- Ensure that the mains outlet used is freely accessible.
- The battery and charger may not be opened. Repairs may only be carried out by authorized workshops.
- Ensure that children cannot access the batteries. Swallowing batteries can cause asphyxiation.

First aid:

- If battery fluid comes into contact with the eyes, there is a risk of blinding. Rinse out the eyes thoroughly with clean water immediately. Do not rub the eyes. Seek medical attention immediately.
- If leaked fluid gets onto the skin or clothing, there is a risk of injury. Wash the affected areas with clean water. There is no need to seek medical attention.

Notes:

- The battery can only be charged outside the camera.
- Batteries should be charged before the camera is used for the first time.
- The battery must have a temperature of 0°-35°C to be charged (otherwise the charger will not turn on, or will turn off again).
- Lithium ion batteries can be charged at any time, regardless of their current charge level. If a battery is only partly discharged when charging starts, it is charged to full capacity more quickly.
- Lithium ion batteries should only be stored when partially charged, i.e. not when fully discharged or fully charged (see p. 17). For very long storage periods, they should be charged for around 15 minutes twice a year to prevent total discharge.
- The batteries and the charger heat up during the charging process. This is normal and not a malfunction.
- A new battery only reaches its full capacity after it has been fully charged and – by use in the camera - discharged again 2 or 3 times. This discharge procedure should be repeated around every 25 cycles.
- Rechargeable lithium ion batteries generate power through internal chemical reactions. These reactions are also influenced by the external temperature and humidity. To ensure a maximum service life of the battery, it should not be exposed to constant extremes (high or low) of temperature (e.g. in a parked car in the summer or winter).

- Even when used under optimum conditions, every battery has a limited service life! After several hundred charging cycles, this becomes noticeable as the operating times get significantly shorter.
- Defective batteries should be disposed of according to the respective instructions (see p. 6/57) at a collection point to ensure proper recycling.
- The replaceable battery provides power to a back-up battery that is permanently fitted in the camera. This back-up battery retains the set date and time for up to 3 months. If this back-up battery becomes discharged it must be recharged by inserting a charged, main battery. Once the replaceable battery has been inserted, the full capacity of the back-up battery is recovered after about 60 hours. This process does not require the camera to be turned on. However, you will have to set the date and time again in this situation.
- Remove the battery if you will not be using the camera for a long period of time. When doing so, turn the camera off using the main switch first (see p. 21). Otherwise, after several weeks the battery could become totally discharged, i.e. the voltage is sharply reduced as the camera still consumes a small amount of current (for saving your settings) even when it is turned off.



Preparing the charger If using the charger outside the USA



1. Insert the appropriate plug for the local mains supply into the charger (B). This is done by simultaneously
 - a. pushing the release button (1.48a) upwards, and
 - b. sliding the plug (1.48) upwards from its normal position.
2. It can then be completely detached upwards.
3. The appropriate plug type is then pushed into the charger from above until it engages.

If using the charger in the USA



1. Disconnect the factory fitted mains plug from the charger (B). This is done by simultaneously
 - a. pushing the release button (1.48a) upwards, and
 - b. sliding the plug (1.48) upwards from its normal position.
2. You can then extend the two pins for the US plug (1.49b), which are pushed down in the normal position.

Note:

The charger automatically switches to the prevailing mains voltage.

Connecting the charger



1. Connect the charger (B), i.e. plug its connector (1.44a) into the socket on the battery (1.43) and connect the power cord (1.48 / 1.48b) to an outlet.
 - The green LED marked **CHARGE** (1.46) starts flashing to confirm that charging is in progress. As soon as the battery has charged to at least 4/5 of its capacity, the orange LED marked with **80%** (1.46) also lights up. When the battery is fully charged, i.e. 100 % capacity reached (after approx. 3 1/2 hours), the green **CHARGE**-LED changes from flashing to continuously lit.

Notes:

- The 80% LED lights up after about 2 hours due to the charging characteristics. Therefore, if you do not need the full capacity, the camera is always ready to use again in a relatively short time.
 - If the green **CHARGE**-LED is continuously lit, this indicates that the charger has automatically switched to trickle charging.
2. The charger should then be disconnected from the power cord. However, there is no risk of overcharging.

Inserting / removing the battery to / from the camera

Inserting the battery

1. Set the main switch (1.15) to **OFF**.
2. Slide the battery (C) as far as possible into the battery bay, contacts first and with the positioning groove (1.40) pointing towards the center of the camera. It automatically engages in this position.



Removing the battery

1. Set the main switch (1.15) to **OFF**.
2. Turn the release lever 1.36 clockwise as far as it will go.
A spring in the battery compartment then pushes the battery out by approximately 1 cm.

Note:

The locking mechanism has a catch to prevent the battery from accidentally falling out, even if the camera is held upright.

3. Press the battery back in by around 1 mm to release the lock, and
4. Remove it from the bay or, if the camera is held upright, allow it to fall out.

Charge level displays (3.2)

The charge level of the battery is indicated in eight stages in the top panel display (1.11).

	= approx. 100%,	White
	= approx. 90%,	White
	= approx. 75%,	White
	= approx. 50%,	White
	= approx. 25%,	White
	= approx. 10%,	White
	= approx. 5%,	Red
	= approx. 3%,	Flashing red, replacement or recharging necessary

Inserting and removing the memory cards

The LEICA S2 enables you to use 2 card types simultaneously to store your picture data, and has card slots for SD/SDHC (Secure Digital) and CF (Compact Flash) cards. SD/SDHC cards have a write-protection switch that can be used to prevent unintentional storage and deletion of pictures. This switch takes the form of a slider on the non-beveled side of the card; in the lower position, marked LOCK, the data on the card is protected.

Note:

Do not touch the memory card contacts.

Inserting

1. Set the main switch (1.15) to **OFF**.
2. Open the door (1.25) on the right-hand side of the camera by sliding it slightly backwards in the direction of the arrow and then opening it to the right.





3. Insert the memory card (s) you want to use as follows:
 - a. Slide CF cards into the slot 1.26 with the contacts pointing towards the camera and the side with the label pointing forwards.

Important:

Do not exert force! This could damage the contacts in the card slot.

- b. SD/SDHC cards with the contacts pointing to the rear and the beveled corner pointing up in slot 1.27. Slide them all the way into the slot against the spring resistance until you hear them click into place.

4. Close the door again, by pressing it down and sliding it forward until it locks into place.

Removing

1. Set the main switch (1.15) to **OFF**.
2. Open the door (1.25) on the right-hand side of the camera by sliding it slightly backwards in the direction of the arrow and then opening it to the right.

CF cards

3. Press the eject button (1.26a) in to eject the card part of the way out of the slot, allowing you to
4. completely remove it.

SD/SDHC cards

3. Press the card slightly back into the slot to eject it a little way out of the slot and allowing you to
4. completely remove it.
5. Close the door again, by pressing it down and sliding it forwards until it locks into place.

Displays

In the event of errors involving memory cards, the camera displays show various messages.

Notes:

- If the memory cards cannot be inserted, check that they are aligned correctly.
- The range of memory cards available is constantly changing; some cards may result in malfunctions when used in the LEICA S2.
- Do not remove a memory card or the battery while the red LED (1.19) at the bottom right of the monitor (1.22) is flashing to indicate picture recording and/or data being saved to the card(s). Otherwise the not yet (completely) saved picture data may be lost.
- The LEICA S2 provides various options for saving picture data. More information on this topic can be found under „Saving picture data / memory card management“ on p. 31.
- As electromagnetic fields, electrostatic charges, and defects on the camera or the card(s) can lead to damage or loss of the data on the memory card(s), we recommend that you also transfer the data to a computer and save it there (see p. 52).
- For the same reason, it is recommended that cards are always stored in an anti-static case.

Changing the focusing screen

The LEICA S2 allows you to change the focusing screen for optimum adaptation to the relevant subjects and situations (see also "System accessories / Exchangeable focusing screens", p. 55). The camera is supplied with a uniform ground glass screen as standard.

The interchangeable focusing screens are supplied separately in a container with tweezers and a dust brush. To change the screens,

1. detach the lens (see p. 20), and



2. remove the screen mount A from its engaged position by pressing the clip B with the tip of the tweezers. The mount C then clicks downwards with the focusing screen.



3. Then pick up the focusing screen C by the small stud with the tweezers, tilt slightly upwards and remove.
4. The screen is then temporarily placed in the side compartment of the container.
5. Pick up the new screen to be inserted by its stud with the tweezers,
6. insert it in the mount, and
7. push the mount up with the tip of the tweezers until it clicks into place.

Important:

Follow these instructions exactly when changing the focusing screen. Take the utmost care to protect the sensitive surfaces of the focusing screens from scratches.

Leica S lenses

Leica S lenses all have characteristic external features:

- Their distance setting ring (1.7) works differently depending on which focus mode is set:
 - In manual mode (**MF**, see p. 13/22/33) the distance is set as normal, by turning the ring - in this case, it is mechanically coupled to the optical construction from the outset.
 - In autofocus mode (**AFs/AFc**, see p. 13/22/33) it is initially uncoupled - so that holding the lens with the ring does not prevent the motorized adjustment. However, you can override the automatic setting at any time, i.e. set the distance manually in AF mode, in which case turning the ring immediately couples it to the optical system.
- Their distance scale is on the inside and the set distance can be read through a window (1.6).
- They do not have an aperture setting-ring. The aperture is set using the click wheel (1.18, see p. 37) on the camera housing.

Attaching and removing the lens

All lenses and accessories with a Leica S bayonet can be attached to the LEICA S2.



Leica S lenses are attached as follows:

1. Position the red dot on the lens mount opposite the bayonet release button (1.3b) on the camera housing.
2. In this position, insert the lens.
3. Turn the lens as far as possible to the right, and you will hear and feel it click into place.



To remove the lens

1. Press the release button,
2. unlock the lens by turning it slightly to the left, and
3. pull it straight out.

Hinweise:

- To protect against ingress of dust etc. into the interior of the camera, and particularly to keep the sensor surface free of dust as far as possible, it is important always to have a lens or a cover fitted to the camera body.
- For the same reason, when changing lenses work without delay and in an environment that is as dust-free as possible.

Eyepiece adjustment

The eyepiece (1.16) can therefore be adjusted by ± 2 diopters, so that it is exactly set to match your eye. While looking at the viewfinder image, turn the knurled setting ring (1.16a) until the markings for the spot-metering field are sharp.

Note:

If you are not looking through the viewfinder, e.g. for pictures on a tripod, we recommend attaching the eyepiece cover (G). This prevents any unwanted influences on the exposure metering. The cover can be stored on the carrying strap for easy access.

Turning the camera on and off

The LEICA S2 is turned on and off using the main switch (1.15). This takes the form of a lever with three indented positions:



a. OFF – Camera turned off

b. FPS – Camera turned on, focal plane shutter in body activated

The shutter speed is controlled manually or automatically using the focal plane shutter in the camera. All speeds are available (see also „Shutter speed dial“, p. 37).

c. CS – Camera turned on, central shutter in lens is activated

The shutter speed is controlled manually or automatically using the central shutter in the lens. Speeds of between $8^{-1}/_{500}$ s are available (see also „Shutter speed dial“, p. 37).

Note:

If a lens with no central shutter is attached, the camera operates with the focal plane shutter even when set to CS.

After turning on, i.e. selecting either the FPS or CS function, the LED (1.19) lights up until the camera is ready (2 s) and the displays in the viewfinder (1.16/2) and in the top panel display (1.11/3) appear (see p. 9/10).

Notes:

- Even if the main switch is not set to OFF, the camera is automatically turned off if automatic power off has been set in the menu (**Auto Power Off**, 5.26, see p. 22/26), and none of the functions are used during this time.
- Turning off the camera not only cancels functions currently running, i.e. bracketing (see p. 35) and self-timer mode (see p. 40), it also deactivates them in the menu.

Menu control/ Settings

Menu control

Most of the modes and settings on the LEICA S2 are operated using menus. Navigating and making settings throughout the menu is extremely quick and easy

1. The menu items are divided into logical functional groups that are accessed directly.
2. Only a few controls are used.
3. Only a few operations are required in each case.
4. Each of three specified menu functions can also be called up directly.

Calling up the menu

To call up the menu control and directly access the individual screens, you use three (1.21, 1.23, 1.24) of the four buttons located to the left and right of the monitor (1.22).

Note:

The four buttons - 1.20, 1.21, 1.23, 1.24 - are so-called "soft keys", which means they have additional functions outside of menu control, e.g. when reviewing pictures in the monitor.

Settings in the menu

All settings for the menu items are made using a single control - the click wheel (1.18).

Exiting the menu

You can exit the menu in various ways:

- To switch to picture mode:
Tap the shutter release button (1.1)
- To switch to image data review mode (4.3, see also p. 12):
Briefly press button 1.20 in the menu - in this case it is labeled **BACK**.
- To switch to play mode:
Briefly press button 1.20 while reviewing the picture data - in this case it is labeled **PLAY**.

Menu function groups

The single menu on the LEICA S2 is divided into 3 function groups marked in different colors (see also p. 13):

CAMERA (blue)

IMAGE (yellow)

SETUP (green)

The function groups are made up of 2 or 3 screens depending on their scope. On each screen, the menu items appear on the left on the individual lines, with the corresponding settings alongside them on the right.

Navigating in the menu / Setting the functions

1. Call up the menu by briefly pressing any of the three buttons 1.21, 1.23 or 1.24 two or three times.
 - If the monitor was previously inactive (dark), the first time you press the button the image data review screen appears, and the functions of the adjacent buttons are specified in the 4 fields 4.3.1 - 4.3.4: 1.24 - **CAMERA**, 1.20 - **PLAY**, 1.23 - **IMAGE**, 1.21 - **SETUP**. For clarity, the three buttons 1.24, 1.23 and 1.21 are marked in the same colors as the corresponding sections of the menu.



- Turning the click wheel (1.18) selects the individual menu items - turning to the right moves down and to the left moves up. All menu items form a continuous loop, i.e. they can all be reached without the division into the three function groups and in either direction.

The actual settings are made exclusively by using the click wheel:

- Press the click wheel inward to call up a list of options for the relevant function.



- The submenu appears, containing a list of the options or values that can be set for the relevant function. The currently active option / value always has a black background and a red border. In some submenus, additional elements appear to ensure clarity, e.g. a scale with marking arrows.

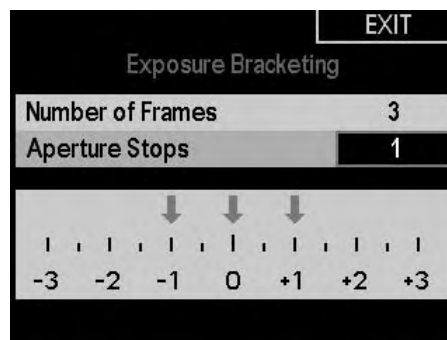

- Turn the click wheel to select the required option / value and/or press it inwards again to confirm the set option / value.

Note:

When the button (1.20) is labeled **BACK** you can return to the menu at any time – without applying the changes made in the submenu up to that point.

Many of the menu items in the **IMAGE** and **SETUP** function groups contain options or sub-items that are set using further submenu levels. This is also done as described under 5 and 6 listed above.

The corresponding explanations, along with further details about these functions, can be found in the relevant sections.

Quick access to menu functions

For quick operation, you can use the buttons 1.24, 1.23 and 1.21 to directly call up three of the most important or frequently used menu functions.

To do this, first specify which menu function you want to access using each individual button.

Setting the Custom functions / Assigning the “Soft” buttons

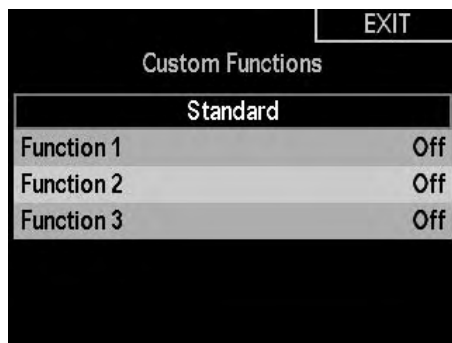

1. In the **SETUP** section of the menu (see p. 13/22), select **Custom Functions** (5.29), and

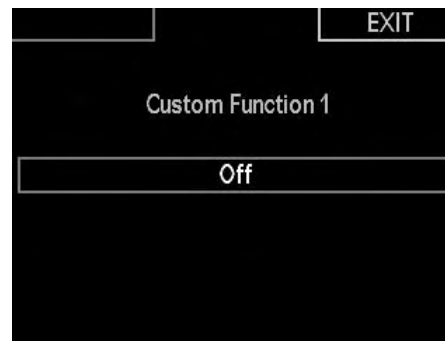

2. in the submenu, select the relevant button - **FUNCTION 1** (= 1.24), **FUNCTION 2** (= 1.23) or **FUNCTION 3** (= 1.21).
 - A list containing the menu functions 5.1-5.13 then appears.

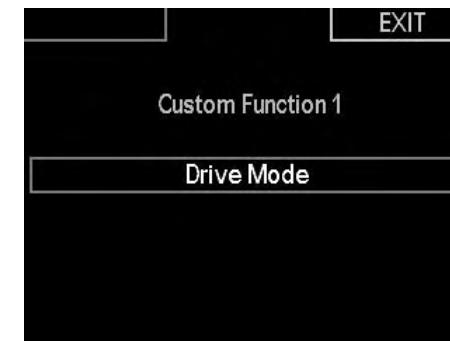

3. Select the function you want to be able to call up directly using the button selected in the previous step. The other two buttons are assigned in the same way.

Calling up the selected menu functions

You can then call up the relevant menu functions directly at any time by pressing and holding (≥ 1 s) the buttons 1.24, 1.23 and 1.21, and you can then make further settings.

Note:

As supplied, the buttons are assigned as follows for quick access:

- Button 1.24: **ISO** (5.9)
- Button 1.23: **White Balance** (5.11)
- Button 1.21: **Exposure Compensation** (5.4)

Presets

Basic settings for the camera

Menu language

By factory default, the language used for menu control is English, i.e. all menu items initially appear with their English names. German, French, Italian, Spanish, Russian, Japanese, Traditional and Simplified Chinese can all be selected as alternative menu languages.

Setting the function

1. In the **SETUP** section of the menu (s. S. 13/22), select **Language** (5.34)
2. Then choose the desired language in the relevant submenu.
 - Apart from a few exceptions (button names, short designations), all the linguistic information changes.

Date and time

The date and time are each set using separate menu items.

Date

There are 3 variations available for the sequence of the date.

Setting

1. In the **SETUP** section of the menu (see p. 13/22), select **Date** (5.32)
2. Call up the submenu. It consists of the 2 items **Setting** and **Format**.
3. Select **Setting**.
 - A further submenu entitled **Date Setting** appears, containing groups of figures for the year and day, as well as the names of the months. The currently active group, i.e. the one that can be set is identified by a red border.
4. Turn the click wheel (1. 16) to set the figures or the months and press to switch between the three groups.
5. After setting all 3 groups, confirm and save by pressing the click wheel.
 - The list of menu items appears again.
6. To change the display format, select **Date**, again
7. This time select **Format** in the submenu.
 - The three available sequences appear - **Day/Month/Year**, **Month/Day/Year**, and **Year/Month/Day**.
8. The preferred option is set and confirmed as described in points 3 and 4.

Time

The time can either be shown in 24-hour or 12-hour format.

Setting

The settings for the two groups of figures and the display format are set in the **Time** menu item (5.33) using the **Setting** and **Format**, options, as described for **Date** in the previous section.

Note:

Even when no battery is inserted or the battery is exhausted, the date and time settings are maintained for approximately 3 months by a built-in back-up battery (see also „Charge level displays“, p. 17). After that time the date and time must be set again as described above.

Automatic power off

This function turns the LEICA S2 off automatically after a pre-set time. This is equivalent to setting the main switch to **OFF** (1. 14a, see p. 21).

Setting the function

1. In the **SETUP** section of the menu (see p. 13/22), select **Auto Power Off** (5.26).
2. Set the desired function and duration.

Note:

Even if the camera is in standby mode, i.e. the displays have gone out after 12s, or the active **Auto Power Off** function has turned it off, it can be restarted at any time by pressing the shutter release button (1. 1).

Signal tones

On the LEICA S2, you can decide whether you want messages or autofocus mode (see p. 33) to be acknowledged by acoustic signals - two volume levels are available - or whether you prefer the camera to operate largely silently.

A beep is used as an acknowledgement, and can be activated individually in autofocus mode to confirm that the setting has been made and to indicate a message.

Note:

By factory default, the signal tones are deactivated.

Setting the functions

1. In the **SETUP** section of the menu (see p. 13/22), select **Acoustic Signal** (5.27)
2. Call up the submenu. It consists of the 3 items **Volume**, **AF-Confirmation** and **Warnings**.
3. Select **Volume**,
 - A further submenu appears containing the 2 alternatives **High** and **Low**.
4. Choose the desired function from this submenu.
 - After confirmation, the initial monitor screen appears again.
5. In the other two submenus, choose whether or not you want to activate the tones for the respective functions.

Selecting On

For **AF-Confirmation** a signal sounds as soon as the focus is set correctly, either automatically or manually, i.e. in conjunction with the indicator 2.9b lighting up in the viewfinder (see p. 9).

For **Warnings** a signal sounds for all messages and warnings that appear in the monitor (1.22), and when the self timer function is used (see p. 40).

Selecting Off for Warnings

Even if you select **Off**, an acoustic warning signal will sound in two situations:

- if the door (1.25) of the memory card slot is opened while transferring data (see p. 17)
- if the shutter will close again at the end of the sensor cleaning process (see p. 58)

Monitor and top panel display

The LEICA S2 has two displays

- A colored OLED (organic light emitting diode) display (1.11), and

- A large 3" liquid crystal color monitor (1.22).

- The top panel displays shows (see „Displays / In the top panel display“, p. 10) the most important basic information about the status of the memory card(s) and the battery, as well as for exposure control. The monitor is primarily used for viewing pictures recorded on the memory card(s) and reproduces the entire field of the picture plus the selected data and information (see „Displays / In the monitor“, p. 9). It can also be used to either

- Display more image data in addition to the picture (see „Displaying the picture data“ on this page) and a histogram (see „Histogram“, p. 47),

or

- A comprehensive list of the most important picture parameters currently set (see „Displays/In the monitor/4.3 Picture data review“, p. 12).

On the LEICA S2-P version, the monitor is protected by an exceptionally hard, and therefore scratch-resistant, sapphire glass cover.

Note:

A monitor image is only available in play mode (see p. 46). If the **Auto review** function is active (see p. 12) it is automatically turned on.

Both displays can be adapted to the relevant situation, i.e. the prevailing lighting conditions. The top panel display has adjustable brightness, while the monitor also has backlighting. The brightness of the monitor is automatically adjusted depending on the external brightness. This is done by the sensor 1.14.

Setting the functions

1. In the **SETUP** section of the menu (see p. 13/22), select **Monitor/Display** (5.27)
2. In the first submenu choose whether you want to set the monitor – **Back Plane**, or the top panel display – **Top Cover**,

To set the monitor:

3. In the second submenu, choose whether you want to set the **Brightness** or **Backlight** and
4. finally set the desired level in the relevant submenu. Three levels are available for the **Brightness**, while for **Backlight** there are five plus an additional automatic setting.

To set the top panel display:

3. In the second submenu, select **Top Cover**, and finally
4. set the desired level.

Basic picture settings

File format / Compression rate

Two file formats are available for recording the picture data -

DNG and **JPEG**. You can select, whether your picture data

a. is to be saved in only one of these formats,

OR

b. Simultaneously in both (i.e. two files are always created for each picture),

AND

c. in the case of **JPEG** format, which of two compression rates - **JPEG fine** or **JPEG standard** - you want to use.

Setting the function

1. In the **IMAGE** section of the menu (see p. 13/22), select

File Format (5.10), and









2. Select the required format(s) or combination and the compression rate in the submenu.

Notes:

- The resolution is always 37.5 MP, regardless of the formats/compression rates used.
- The standardized DNG (Digital Negative) format is used for storage of completely unprocessed raw picture data.
- A high compression rate such as for **JPEG standard** can result in very fine structures in the subject being lost or incorrectly reproduced (artifacts; e.g. „stepped“ diagonal edges).
- The remaining number of pictures shown in the monitor does not necessarily change after every picture. This depends on the subject; with JPEG files very fine structures result in higher quantities of data, homogeneous surfaces in lower quantities. The details in the table are based on an average file size for the set resolution. The file sizes are often smaller, depending on the picture content and the compression rate, which means that the remaining memory capacity is then greater than previously calculated and displayed.



White balance

- **Auto** – For automatic control, which provides neutral results in most situations,
- Seven fixed presets for the most frequent light sources,
 -  e.g. for outdoor pictures in sunshine,
 -  e.g. for outdoor pictures in cloudy conditions,
 -  e.g. for outdoor pictures with the main subject in shadow,
 -  e.g. for indoor pictures with (prevailing) incandescent light
 -  e.g. for indoor pictures with (prevailing) light from fluorescent tubes with warm light color
 -  e.g. for indoor pictures with (prevailing) light from fluorescent tubes with cool light color
 -  e.g. for pictures with (prevailing) electronic flash illumination
-  **Manual Metering** – For manual setting by metering and
- **Color Temperature**¹ – For a directly adjustable color temperature value.

Note:

When using the LEICA SF58 or electronic flash units that meet the technical requirements of System Camera Adaption (SCA) for the System 3000 and have an SCA-3502 adapter (version 5 onwards), the white balance can be set to **Auto** to achieve correct color reproduction.

However, if other flash units are used, which are not specially designed for the LEICA S2, the  setting should be used.

¹ All color temperatures are specified in Kelvin.

Setting the function

For automatic or fixed settings

1. In the **IMAGE** section of the menu (see p. 13/22), select (5.11), and
2. in the associated submenu the desired function.

For direct setting of color temperature

You can directly set values between 2000 and 13100 (K1) (from 2000 to 5000K in increments of 100, from 5000 to 8000K in increments of 200 and from 8000 to 13,100K in increments of 300). This provides you with a broad scope, covering almost all color temperatures that can occur in practice and within which you can adapt the color reproduction very sensitively to the existing light color and/or your personal preferences.

1. In the **IMAGE** section of the menu (see p. 13/22), select **White Balance** (5.11)
2. in the subsequent submenu select the **Color Temperature** option, and
 - A further submenu entitled **White Balance Kelvin Setting** appears, containing the value to be set, which is indicated by a red border.
3. then the desired value.

For manual setting by metering

1. In the **IMAGE** section of the menu (see p. 13/22), select **White Balance** (5.11), and
2. in the subsequent submenu select the **Manual Metering** option.
3. Press the click wheel (1.17).
The message **Attention Aim the camera at a white surface and press the shutter release button** appears in the monitor.
4. The actual setting is made by subsequently taking a picture in which you must aim at a white or neutral gray surface in the center of the picture.
 - The picture you have just taken will appear in the monitor instead of the menu and will contain the message **White balance set**.
However, if the exposure is found to be insufficient, an error message appears. In such cases, repeat step 2 with the correct exposure setting.

A value set in this way remains stored and will be used for all pictures until it is superseded either by a newly metered value, or you use one of the other white balance settings.



ISO sensitivity

The ISO setting on the LEICA S2 allows the shutter speed/aperture value to be adjusted to meet the requirements of the relevant situation, in six steps.

The **Pull 80** setting has an equivalent brightness to an ISO sensitivity of ISO 80. However, pictures taken with this setting have a lower contrast range. When using this sensitivity setting, it is important to make sure that important parts of the image are not overexposed.

As well as the fixed settings, the LEICA S2 also features the **Auto** function¹, in which the camera automatically adjusts the sensitivity to the ambient brightness.

However, it is still possible to specify priorities when using this function. This enables you to limit the range of sensitivities used and also to set the shutter speed above which the automatic increase in sensitivity is activated.

Setting the function

1. In the **IMAGE** section of the menu (see p. 13/22), select **ISO** (5.9), and
2. call up the submenu. It contains the available ISO values and the **Auto** option.

To set the sensitivity manually

3. 1. Select the desired value.

To set the sensitivity automatically

3. Select **Auto**.
 - A further submenu appears containing three options - **OK**, set **Maximum ISO** and **Set Maximum Exposure Time**.

To use unrestricted automatic setting

4. Select **OK** in this submenu.

The automatic setting uses all sensitivities except **PULL 80**, , and shutter speeds between $1/2$ s und $1/500$ s.

To restrict the automatic setting range

4. Select **Set Maximum ISO** and/or **Set Maximum Exposure Time** in this submenu. Selecting **Set Maximum ISO** displays a list of available values, while **Set Maximum Exposure Time** opens a further submenu containing the **1/f** and **Manual Setting** options.

5. In the **Maximum ISO einstellen** list, select the maximum sensitivity to be used and thus the range within which you want the automatic setting to work, or
5. in the **Set Maximum Exposure Time** submenu, select either **1/f** if you want to leave it to the camera to ensure shutter speeds that will prevent blurring, or **Manual Setting**. With **1/f** the camera only switches to a higher sensitivity if a lower brightness would cause the shutter speed to fall below the **1/f** threshold, e.g. at speeds of slower than $1/60$ s with a 70mm lens.
6. In the **Manual Setting** list, select the slowest shutter speed you want to set (**1/2s - 1/500s**; in whole steps).

¹ This function is not available when using flash units.

Image properties/Contrast, sharpness, color saturation

All three image properties can be adjusted – independently – to three different levels using the menu control, so that you can set the optimum values for any situation, i.e. the prevailing lighting conditions. In the case of **Color Saturation**, **Black/White** can also be selected as a fourth option.

Note:

If the file format **DNG** is specified, these settings have no effect as in this case the image data is always saved in its original form (changes must be made later on the computer).

Setting the functions

1. In the **IMAGE** section of the menu (see p. 13/22), select **Contrast** (5.14), **Sharpness** (5.15), or **Saturation** (5.16), and
2. select the desired level (**Low**, **Standard**, **High**) in the relevant submenu.



Working color space

The LEICA S2 permits allows you to set one of three color spaces - **sRGB**, **Adobe RGB** or **ECI RGB**.

Setting the function

1. In the **IMAGE** section of the menu (see p. 13/22), select **Color Management** (5.13), and
2. in the associated submenu select the desired function.

Storage of picture data / memory card management

If two memory cards are inserted (see p. 17), on the LEICA S2 you have the option of selecting,

- whether the picture data is to be stored on one of the two cards first until its full capacity is reached and then on the other card - **Sequential**, or
- always to both cards simultaneously - **Parallel**, or
- whether the picture data is to be transferred directly to a computer connected by a cable - **External**.

Setting the function

1. In the **SETUP** section of the menu (see p. 13/22), select **Data Storage** (5.17), and
2. in the associated submenu select the desired function.

Note:

If you have set **Parallel** and both file formats (see p. 28), the DNG data is generally written to the CF card and the JPEG data to the SD/SDHC card.

Record mode

Shutter release button

The LEICA S2 has a three-stage shutter release button (1.1):

1. A brief tap activates the distance and exposure metering systems, as well as the displays in the viewfinder and the top panel. If the shutter release button is held at this pressure point, the metering systems and displays remain active. When you let go of the shutter release button, the metering system and the displays remain activated for around a further 12s.

Notes:

- If play mode was previously set (see p. 46), when you tap the shutter release button the camera reverts to record mode, if it was previously in standby mode (see p. 26), it is reactivated, i.e. metering systems and displays are turned on.
- The shutter release button remains blocked
 - if the internal buffer memory is (temporarily) full, e.g. after a series of up to 10 pictures,
 - if the memory card(s) inserted is/are full and the internal buffer memory is (temporarily) full, or
 - if no memory card is inserted and the internal buffer memory is full.

2. Pressing the shutter release button to the first pressure point and holding it in this position stores the metered exposure value in , and modes (see p. 38/39). When using autofocus in **AFs** - sharpness priority - mode (see p. 33) this simultaneously stores the focus setting.

After the shutter release button has been let go, new measurements can be carried out.

Note:

You can also use the menu to set button 1.17 to store the metered exposure value and/or the automatic focus setting (see p. 35).

3. Pressing further releases the shutter or starts any preselected self-timer delay time (see p. 40).

Serial exposures

You can use the LEICA D-LUX S2 to take single pictures and also to produce sequences of pictures.

Einstellen und Anwenden der Funktion

1. In the **CAMERA** section of the menu (see p. 13/22), select **Drive Mode** (5.1) And
2. then select **Continuous** in the submenu.
3. The subsequent functioning is determined by how you operate the shutter release button:
 - A series of pictures is taken for as long as you hold down the shutter release (provided that the memory card has sufficient capacity).
 - If you press the shutter release button briefly, the camera continues to take single pictures.

Note:

Regardless of how many pictures have been taken in a series, both play modes (see p. 24) initially show the last picture in the series or the last picture in the series saved on the currently active card (see p. 31), if not all of the pictures in the series have been transferred from the internal camera memory to the relevant card yet.

Details of how to select other pictures in the series, as well as further review options, can be found in the sections under „Review mode“ starting on p. 46.

Setting the focus

With all S lenses, the LEICA S2 allows you to choose between manual or automatic focusing. The autofocus system determines the distance to the parts of the subject in the center of the image field, which is marked by the cross-hair mark on the focusing screen.

Regardless of the mode, the display (2.9) in the viewfinder shows the relevant setting:

- The left triangle indicates that the set distance is too long (only appears in manual mode or with manual override of autofocus)
- The center dot indicates a correct setting, or that the system cannot determine a distance
- The right triangle indicates that the set distance is too short (only appears in manual mode or with manual override of autofocus)

Further details of the displays can be found on p. 9.

Note:

The metering system works passively based on contrasts, i.e. differences between light/dark in the part of the subject you aim at. Thus, it depends on the subject having a certain minimum brightness.

Setting the mode

1. In the **CAMERA** section of the menu (see p. 13/22), select **Focus Mode** (5.2) and
2. in the associated submenu, select the desired option.

Manual focus setting – MF

Turn the distance setting ring (1.9) on the lens until your subject or the most important part of the subject is shown sharply in the viewfinder on the focusing screen.

The LEICA S2 is supplied with a uniform ground glass screen as standard, which can be used to reliably focus on parts of the subject across the entire image field. It is suitable for most photographic applications and subjects and is particularly effective when using longer focal lengths and in the macro range.

Other focusing screens are available as accessories (see p. 55), providing optimum settings for different applications. These are easy to exchange.

Note:

If **MF** is set and the **AE-/AF-Lock** function (see p. 34) simultaneously set to **AF-L** in the menu, button 1.17 can be used to activate the **AFc** autofocus mode at any time.

Automatic focus setting

Two autofocus modes are available. In both of them, the setting procedure is started by tapping (1st pressure point, see p. 32) the shutter release button (1.1).

AFs(single) = Sharpness priority

The part of the subject you aim at is focused.

- The procedure is then ended, even if the shutter release button is held at the 1st pressure point.
- The setting is stored for as long as the shutter release button is held at the 2nd pressure point.
- Before the focus is set, the shutter cannot be released even by pressing the shutter release button all the way down.

AFc(continuous) = Shutter release priority

The parts of the subject you aim at are focused.

- The procedure is continued for as long as the shutter release button is held at the 1st or 2nd pressure point. During this time, the setting is corrected whenever the metering system detects other objects at other distances, or the distance from the camera to the part of the subject you are aiming at changes.
- It is not possible to store a setting.
- Even if none of the subject is in focus, you can release the shutter at any time.

Note:

As well as the shutter release button, you can also use button 1.17 to store an AF setting (see p. 35).

Exposure metering

Exposure metering methods

The LEICA S2 provides three different exposure metering methods:

Setting the function

1. In the **CAMERA** section of the menu (see p. 13/22), select **Exposure Metering** (5.3) and
2. in the associated submenu, select the desired option.

Spot metering - ¹

For spot metering, only the metered value from the center field is used.

Center-weighted metering - ¹

Center-weighted metering uses all metered values but they are weighted differently than with multiple field metering.

This metering method takes account of the entire image field, although the parts of the subject situated in the center have more influence on the exposure value calculation than the areas at the margins.

Multiple field metering - ¹

This metering method is based on recording five metered values. One value is determined in a field in the center of the image, the other four in the surrounding fields. An algorithm is used to calculate these five measured values according to the situation.

Metering memory lock

The LEICA S2 records

- different parts of the subject during exposure metering, depending on the metering method, and weights them differently,
- only part of the subject with autofocus metering (see p. 33).

The values are initially always stored using the shutter release button (1.1, see p. 32). Depending on the setting in the menu, you can use button 1.17 to either

- retain one of the (stored) settings even if you let go of the shutter release button, e.g. to store different exposure and/or focus settings by pressing to the pressure point again, or
- store the setting not stored with the shutter release button.

In contrast to the shutter release button, button 1.17 stores the relevant settings not just for one picture but also for as long as it is held down, i.e. possibly for several pictures.

The **AE-/AF-Lock (Automatic Exposure / AutoFocus)** option in the menu is used to select the assignment of the functions.

Storing with the shutter release button

1. Aim the circle in the viewfinder at the area to be metered.
2. Press the shutter release button (1.1) to the 2nd pressure point. As long as the button remains depressed, the value is stored.
3. In the automatic exposure modes , and (see p. 38/39) the light balance appears (2.7b) and shows the variation from the stored measured value. If the aperture or shutter speed is changed during this time, the other value adjusts accordingly and is displayed.
4. While keeping the shutter release button at the pressure point, compose the final picture detail and
5. Then release the shutter.

The storage is cancelled when the shutter release button is let go from the pressure point.

¹Symbols only appear in the viewfinder (see p. 9)

Storing with button 1.17

Setting the function

4. In the **SETUP** section of the menu (see p. 13/22), select **AE-/AF-Lock** (5.30), and
5. then select one of the following options in the submenu:

- **AF-L** (AF Lock)

The shutter release button stores the exposure and autofocus setting. Holding down button 1.17 maintains storage of the autofocus setting even if you let go of the shutter release button. Special case: If the camera is set to this function and manual focusing (see p. 33), autofocus works in release priority mode (see p. 33) as long as the button is held down.

- **AE-L** (AE Lock)

The shutter release button stores the exposure and autofocus setting. Holding down button 1.17 maintains storage of the exposure setting even if you let go of the shutter release.

- **AF-L + AE-L**

The settings stored using the shutter release button for the relevant picture are retained for as long as the button is held down. Special case: If the camera is set to this function and manual focusing (see p. 33), autofocus works in release priority mode (see p. 33) as long as the button is held down.

Exposure compensation

Entering and cancelling an exposure compensation

1. In the **CAMERA** section of the menu (see p. 13/22), select

Exposure Compensation (5.4).

- A scale with a red arrow above it appears in the monitor. If this arrow is pointing to a value of 0, this means that the function is deactivated.

2. Turn the click wheel (1.18) to set the desired value in the submenu.

- A set compensation is indicated by **EV±X¹** in the initial menu list.

The viewfinder shows

- the corresponding warning symbol (2.2).

The top panel display shows

- + or - (3.9a), depending on the compensation direction

Note:

Once set, a compensation value is retained even if the camera is turned off.

Important:

An exposure compensation value set on the camera influences only metering of the available light, i.e. not the flash light (for more details on flash photography, refer to the sections starting on p. 43).



Bracketing

The following are available:

- 4 graduations: 0,5EV, 1EV, 2EV and 3EV
- 2 numbers of pictures: 3 or 5

Setting the function

1. In the **CAMERA** section of the menu (see p. 13/22), select

Exposure Bracketing (5.5).

- The submenu appears in the monitor and contains two options – Number of Frames and Aperture Stops – with a scale below them. The setting for Number of Frames is marked as ready for editing. If exposure compensation is set at the same time, this is indicated by a corresponding value below the scale.

2. For **Number of Frames** turn the click wheel (1.18) to select whether you want to produce a bracketing series and the number of pictures.

- The corresponding number of red arrows appears above the scale. They specify the relevant exposure values.

Note:

If an exposure compensation is set at the same time, the zero exposure, i.e. the starting point of the bracketing series, corresponds to the compensated exposure value in , and exposure modes (see p. 38/39).



¹ Example, either plus or minus, „X“ stands for the relevant value

3. Confirm the setting by pressing the click wheel.

- The setting for **Interval** is marked as ready for editing. The corresponding number of red arrows appears above the scale. They specify the relevant exposure values.

4. Set the desired graduation by turning the click wheel (20).

- The arrows change their positions according to the set graduation.

Notes:

- If the bracketing exceeds the range of ± 3 EV due to the combination of number of pictures and graduation, the scale division changes from ± 3 EV to ± 6 EV. The arrows move accordingly.
- Note that both settings have to be made and confirmed, otherwise the function will not be active.

5. Confirm the setting by pressing the click wheel.

- A set bracketing series is indicated by **XEV /X¹** in the initial menu list.

The viewfinder shows

- the corresponding warning symbol (2.2).
- the changing displays for shutter speed (2.8) and aperture (2.6) depending on the graduations

The top panel display shows

- next to the exposure mode **+** before over exposed pictures (3.8), **0** before the uncorrected picture, and **–** before under exposed pictures
- the display for a bracketing series (3.9b)

Notes:

- Depending on the exposure mode (see „Exposure control“ section on p. 37) the exposure graduations are produced by changing the shutter speeds and/or apertures.
- The sequence of the exposures is: overexposure, correct exposure, underexposure.
- When using automatic bracketing, all **AUTO ISO** settings (see p. 30) are preset:
 - The sensitivity automatically determined by the camera for the uncorrected picture is also used for all other pictures in a series, i.e. this ISO value is not changed during a series.
 - The settings in the **AUTO ISO** submenus have no effect, i.e. the camera's full shutter speed range is available.
- Depending on the initial exposure setting, the working range for automatic bracketing may be limited.
- Regardless of this, the specified number of pictures is always taken, which may mean that several pictures in a series have the same exposure at the end of the working range.
- The function remains active until it is deactivated in the menu or the camera is turned off.

Values above and below the metering range

If the camera's metering range is not reached, accurate exposure metering is not possible. Any values that are then shown in the viewfinder can lead to incorrect exposure results. For this reason, if the metering range is not reached, (2.8b) always appears in the viewfinder.

¹ Example, first „X“ stands for the graduation, the second for the number of pictures

Exposure control

Setting the shutter speed and aperture / Selecting the exposure mode

On the LEICA S2, setting both

- shutter speed and aperture values using manual pre-selection,
 - as well as the 3 automatic exposure modes
- is done with only 2 controls, the shutter speed setting dial (1. 10) and the click wheel (1. 18).

Both the viewfinder (1. 16/2) and the top panel display (1. 11/3) show the relevant settings and the selected modes (refer to the corresponding explanations and descriptions on p. 9 and 10).

Shutter speed dial

This dial (1. 10) is used to manually set the shutter speed in (manual shutter speed and aperture setting) and (shutter speed priority) modes.

The following speed ranges are available depending on the shutter used:

- With the focal plane shutter in the camera – main switch 1. 15 to **FPS** (see p. 21) – from 8 s to $1/4000$ s
- With the integrated central shutter in some Leica S lenses – main switch 1. 15 to **CS** (see p. 21) – from 8 s to $1/500$ s. If slower shutter speeds are set, the camera automatically switches to the focal plane shutter. By contrast, faster shutter speeds are not possible as long as the main switch is set to **CS**.
- In both cases, half steps can also be set.

For automatic and continuous control of the shutter speed by the camera - in (automatic program) and (aperture priority) modes – the position must be selected.

Long-time exposures up to a maximum of 32 s are made using the **B** (bulb) setting. When using flash units that do not conform to the system, the setting for the shortest flash sync speed ($= 1/125$ s) is recommended.

The click wheel

Turning the click wheel (1. 18) manually sets the aperture in and modes. Half steps are also available.

Pressing the click wheel switches between manual aperture setting and automatic control by the camera in and modes.

The table illustrates the functional relationships of the two controls.



Shutter speed dial	Click wheel	
	Press	Turn
Set to a speed from 8 s to $1/4000$ s	Switches between and modes	<ul style="list-style-type: none"> - In mode: Changes the set aperture value - In mode: No function
Set to A	Switches between and modes	<ul style="list-style-type: none"> - In mode: Changes the set aperture value - In mode: „Shifts“ the specified shutter speed and aperture values (see p. 38)

Exposure modes

The LEICA S2 provides you with a choice of four exposure modes.

Programmed automatic exposure

Setting the mode

1. Set the shutter speed dial (1.10) to **A**.
2. Press the click wheel (1.18) to set automatic exposure control, i.e. in this case automatic program mode.

The shutter speed and aperture are then generated automatically according to the available light and continuously between 32 s and $1/4000$ s, or $1/500$ s when using the central shutter in some Leica S lenses and between fully open and minimum aperture for the relevant lens.

Viewfinder and top panel display show

- **P** (2.5.a/3.8) for the selected exposure mode, and
- the automatically controlled aperture (2.6/3.11) and shutter speed values (2.8a/3.12).

Notes:

- If the automatic sensitivity setting (see p. 30) is activated at the same time, even with a fully open aperture the shutter speed will only be extended over $1/f_{\text{focal length}}$ if the maximum set sensitivity is reached.
- With very little light or extreme brightness, the available speed/aperture range may no longer be sufficient. In this case, (2.8b) appears in the viewfinder for underexposure (possibly accompanied by a warning that the metering range has not been reached, see "Working below the metering range", p. 36), or (2.8) appears for overexposure.



Program shift

The program shift function on the LEICA S2 enables you to change the shutter speed/aperture combination set by the automatic program, while the overall exposure, i.e. the brightness of the image, remains unchanged.

Setting the function

Turn the click wheel (1.18)

- to the right for larger apertures (lower values) or faster shutter speeds
- to the left for smaller apertures (higher values) or slower shutter speeds.

Viewfinder and top panel display show

- **P** (2.5.a/3.8) for the selected exposure mode,
- **S** (3.10) in the top panel display to indicate the use of the shift function, and the automatically controlled aperture (2.6/3.11) and shutter speed values (2.8a/3.12), which change inversely.

Note:

Shift settings are retained

- after taking a picture beyond the exposure metering system's 12 s retention time (see p. 32),
- but not when you switch to a different exposure mode (**A**, **T**, **m**)
- when you turn the camera off and back on (including **Auto Power Off**).

This means that in these cases when you use the automatic program mode again the camera initially always specifies the default shutter speed and aperture setting.

Aperture priority - A



Setting the mode

1. Set the shutter speed dial (1.10) to **A**.
 2. Press the click wheel (1.18) to set manual aperture control.
 3. Turn the click wheel (1.18) to set the required aperture.
- The shutter speed is then generated automatically based on the available light and continuously between 32 s and $1/4000$ s, or $1/500$ s when using the central shutter in some Leica S lenses.

Viewfinder and top panel display show

- **A** (aperture priority) for the selected exposure mode (2.5.b/3.8),
- the manually set aperture value (2.6/3.11), and
- the automatically set shutter speed (2.8a/3.12)

Notes:

- If automatic sensitivity setting is activated at the same time (see p. 30), the control range for aperture priority is extended.
- With extreme brightness or in conditions of very poor light, or appears in the viewfinder (2.8b). Set a different aperture value if possible. may also appear to warn you that you are below the metering range (see p. 36). It is then no longer possible to correctly meter the exposure.

Shutter speed priority - T

Setting the mode

1. Set the shutter speed dial (1.10) to the required value.
2. If necessary, press the click wheel (1.18) to set automatic aperture control, i.e. in this case shutter speed priority mode.

The lens aperture is then controlled automatically based on the available light and continuously between a fully open and minimum aperture for the relevant lens.

Viewfinder and top panel display show

- **T** (speed priority) for the selected exposure mode (2.5.c/3.8),
- the automatically set aperture value (2.6/3.11), and
- the manually set shutter speed value (2.8a/3.12)

Notes:

- If automatic sensitivity setting is activated at the same time (see p. 30), the control range for shutter speed priority is extended. Any maximum shutter speed set as part of the automatic sensitivity setting does not override this.
- With very little light or extreme brightness, the available aperture range of the lens you are using may no longer be sufficient for the selected shutter speed. Set a different shutter speed if possible. However, a correct exposure is normally still used in such cases, by automatic setting of the appropriate shutter speed, i.e. by “overriding” your manual selection. may also appear to warn you that you are below the metering range (see p. 36). It is then no longer possible to correctly meter the exposure.

Manual aperture and shutter speed setting - m



Setting the mode

1. Set the shutter speed dial (1.10) to the required value.
2. Press the click wheel (1.18) to set the aperture to manual control.
3. Turn the click wheel to set the required aperture.

Viewfinder and top panel display show

- **m** for the selected exposure mode (2.5.d/3.8),
- the manually set aperture (2.6/3.11) and shutter speed values (2.8a/3.12), and
- a light balance (2.7), which assists in adjusting the exposure.

The light balance shows the deviation of the set shutter-speed/aperture combination from the metered exposure value. The display clearly shows the range ± 3 EV in $1/2$ EV steps. Larger deviations are shown with flashing of the outer markings on the light balance scale. To achieve the correct exposure according to the result of the exposure metering, the aperture and/or shutter speed should be adjusted until the zero marking lights up on the light balance.

Note:

If automatic sensitivity setting is activated at the same time (see p. 30), the last manually set sensitivity is used. Any maximum shutter speed set as part of the automatic sensitivity setting has no effect.

The B setting

The **B** (bulb) setting keeps the shutter open as long as the shutter release button remains pressed (maximum 32s).

In conjunction with the self-timer, an additional T function is also available: If you set **B** and activate the self-timer by pressing the shutter release button (see also p. 40), the shutter opens automatically after the selected delay time. It then remains open until you press the shutter release button a second time – you do not need to hold the button down. This enables you to largely prevent any blurring, even with long exposures, by pressing the shutter release button. The exposure meter remains off in both cases.

The viewfinder shows

- (2.8c) instead of a shutter speed

The top panel display shows

- **B** (3.13), and
- after opening the shutter, the elapsed exposure time in seconds (3.12)

Notes:

- Long exposure times can be associated with very heavy picture noise. To reduce this annoying phenomenon, after pictures with slow shutter speeds the LEICA S2 automatically takes a second „black picture“ (taken with the shutter closed). The noise present in this parallel picture is then digitally “subtracted” from the data set for the real picture.
- This doubling of the „exposure“ time can be significant in particular at longer exposures and must be considered. During this time the camera should not be switched off.
- For shutter speeds of $>1/2$ s the message **Noise Reduction** appears in the monitor.
- Long time exposures using the **B** setting are produced using only the focal plane shutter inside the camera, even if the main switch (1.15) is set to **CS** (see p. 21).



Taking photographs with the self-timer

You can use the LEICA S2's self-timer function to take pictures with a delay of either 2 or 12 s.

Setting / using the function

1. In the **CAMERA** section of the menu (see p. 13/22), select **Drive Mode** (5.1) and
2. select the required delay time in the associated submenu.
3. To start the process, press the shutter release button all the way down (see also "Shutter release button", p. 32).

Note:

During the countdown, you can restart the delay time, i.e. extend it, by pressing the shutter release again.

Process

With 2 s delay time:

Exposure metering is carried out first, in autofocus mode the focus is set and the mirror flips up. The delay time then begins.

With 12 s delay time:

The delay time begins immediately after the shutter release button is pressed and the mirror flips up 2 s before the picture is taken.

Displays

The elapsed delay time is displayed:

- the monitor (1.22) displays **Releasing in 12s** and the time remaining until the picture is taken counts down.
- the LED on the front of the camera (1.2) – for the first 10 s with a 12 s delay time - flashing, otherwise continuously lit.

Cancelling the function

A self-timer delay time in progress can be cancelled by

- turning off the camera, i.e. turning the main switch (1.15) to the **OFF** position,
- during the first 10 s of a 12 s self-timer delay time by pressing button 1.20 – in this case labeled **CANCEL**.

If you no longer want to use the self-timer, it must be deactivated in the menu. Turning off the camera also deactivates the function.

Note:

If the self-timer function is set and mirror pre-release is activated at the same time, the shutter movement occurs after the selected delay time, i.e. without the need to press the shutter release button again.

Mirror pre-release

To eliminate the remaining minimal effects of mirror movement and closing of the lens aperture, the LEICA S2 includes the option of using mirror pre-release.

Setting / using the function

1. In the **CAMERA** section of the menu (see p. 13/22), select **Mirror Up Mode** (5.8) and
2. then select **ON** or **OFF** in the submenu.
3. Press the shutter release button all the way down, i.e. to the third pressure point (see also „Shutter release“, p. 32) to flip up the mirror.
4. Press the shutter release button all the way down again to take the picture.

Process

The first time the shutter release button is pressed, exposure metering and (in autofocus mode) focusing are first carried out, then the mirror flips up and the aperture closes to the appropriate value.

The shutter does not move and thus the actual picture is not taken until the shutter release button is pressed again. After the exposure, the mirror moves back down into place and the aperture opens again in the normal way.

Cancelling the function

The mirror pre-release process can be canceled without taking a picture after pressing the shutter release button for the first time.

This is done by turning off the camera at the main switch, i.e. turning the main switch (1.15) to the **OFF** position – the mirror then flips back down again. If mirror pre-release is set, the function remains active even after turning the camera off and back on, i.e. if you want to take the next picture without mirror pre-release, the function must be set to **OFF** in the menu.

Notes:

- The picture must be taken within 2 min of pressing the shutter release for the first time. If not, the mirror flips back down automatically to preserve the battery capacity (without the shutter opening first).
- While the mirror is flipped up, the 2 min dwell time can be restarted at any time by tapping the shutter release.
- If mirror pre-release and the self-timer function are activated at the same time, the shutter movement occurs after the selected delay time, i.e. without the need to press the shutter release again.

Depth of field preview button and depth of field

You can use the depth of field preview button (1.4) on the LEICA S2 to close the open lens aperture for every exposure mode to the set or automatically determined aperture value. The correct values remain displayed in the monitor and the top panel display. However, the exposure meter is turned off.

Prerequisites for stopping down:

1. The exposure meter has been turned on with the shutter release button (see p. 32), and
2. the shutter release button is no longer pressed.

The shutter release button is blocked when the depth of field preview button is pressed.



Additional functions

User / application specific profiles

On the LEICA S2, any combination of menu settings can be permanently stored, e.g. so that they can be retrieved quickly and easily at any time for recurring situations / subjects. A total of four memory slots are available for these combinations, as well as a factory default setting that can be retrieved at any time and cannot be changed. You can change the names of the saved profiles. Profiles set on the camera can be transferred onto one of the memory cards, for example for use in other camera units, while profiles stored on a card can be transferred onto the camera.

Saving settings / Creating a profile

1. Set the desired functions in the menu.
2. In the **IMAGE** section of the menu (see p. 13/22), select **User Profile** (5.13),
3. then select **Save As Profile** in the submenu, and
4. in the associated sub-menu select the desired memory slot.

Selecting a Profile

1. In the **IMAGE** section of the menu (see p. 13/22), select **User Profile** (5.13).
 - If user profiles are stored, the profile name appears in black, while free memory slots are green.
2. Select the required profile in the submenu, either one of the saved profiles, or **Default Profile**.

Note:

If you change one of the settings for the profile currently in use – appears instead of the name of the profile you were previously using in the initial menu list .

Renaming profiles

1. In the **IMAGE** section of the menu (see p. 13/22), select **User Profile** (5.13),
2. then select **Administrative Profiles** in the submenu, and
3. select **Rename Profiles** in the submenu.
 - The profile name and number appear, with the number marked as ready for editing.
4. First select the profile to be renamed using the click wheel (1.18), then change the numbers or letters in the name by turning the wheel and select the other positions by pressing the wheel.
 - The characters available for the four characters in the name are upper case letters from „A“ to „Z“, figures from „0“ to „9“ and a space „_“; they are arranged in this order in an endless loop.

Transferring profiles from / to a card

1. In the **IMAGE** section of the menu (see p. 13/22), select **User Profile** (5.13),
2. then select **Administrative Profiles**, in the submenu, and
3. select **Import profiles From Card** or **Export Profiles To Card** in the submenu
 - A confirmation prompt appears in the monitor.
4. Confirm that you really want to import or export the profile(s) using the click wheel (1.18).

Note:

When exporting, all profile slots are transferred to the card, i.e. including any empty profiles. As a result, when importing profiles any existing profiles in the camera will be overwritten, i.e. deleted.

Resetting all custom settings

This function allows you to reset all custom settings previously made in the menu at once and restore the factory default settings.

Setting the function

1. In the **SETUP** section of the menu (see p. 13/22), select **Reset** (5.22) and
2. select **No** or **YES** in the submenu.

Note:

This reset also affects any individual profiles defined and saved using **Save As Profile** (see previous section).

Folder management

The image data on the memory cards is stored in folders, which are created automatically. The folder names always consist of eight characters - three figures and five letters. In the factory default setting, the first folder is named „100LEICA“, the second „101LEICA“, etc. As a result, the camera can create a maximum of 999 folders. The LEICA S2 allows you to create new folders at any time and to specify their name yourself. You can also change the file names.

Creating new folders / Setting names / Resetting picture numbers

1. In the **SETUP** section of the menu (see p. 13/22), select **Image Numbering** (5. 18), and
2. select **New Folder** in the submenu.
 - The folder name appears (initially always „XXX1LEICA“). The first of the five characters is marked as ready for editing. Positions 4-8 can be changed.

Notes:

- The next free number is always created as the folder number.
- All numbers up to „999“ are available. If the number capacity has been used up, a corresponding warning message appears.



3. Turn the click wheel (1. 18) to change the numbers and/or letters and press to select the other positions.
 - The characters available are upper case letters from „A“ to „Z“, figures from „0“ to „9“ and a space „_“; they are arranged in this order in an endless loop. After confirming the settings by pressing button 1.21, labeled **OK** in this case, or after setting last position by pressing the click wheel, a further submenu appears with the query **Reset File Numbering?**.
4. Select **YES** or **NO**.
 - After you confirm your selection by pressing the click wheel, the original menu list appears.

Changing file names

1. In the **SETUP** section of the menu (see p. 13/22), select **Image Numbering** (5. 18), and
2. select **Change Filename** in the submenu.
 - The file name appears. The character at the first position (initially always „LXXXXXX1“) is marked as ready for editing. Positions 1-4 can be changed.
3. Turn the click wheel (1. 18) to change the numbers and/or letters and press to select the other positions. The characters available are upper case letters from „A“ to „Z“, figures from „0“ to „9“ and a space „_“; they are arranged in this order in an endless loop.
4. Confirm your settings by pressing the click wheel.
 - The original menu list appears.

Formatting the memory card(s)

It is not normally necessary to format (initialize) memory cards that have already been used. However, if a card that has yet to be formatted is inserted for the first time, it must be formatted.

Important:

Simple formatting does not cause the data on the card to be irretrievably lost. Only the directory is deleted, which means that the existing files are no longer directly accessible. The data can be accessed again using appropriate software. Only the data that is then overwritten by saving new data is actually permanently deleted.

Notes:

- Do not turn the camera off while memory cards are being formatted.
- If the memory card has been formatted in another device, such as a computer, you should reformat it in the LEICA S2.
- If a memory card cannot be formatted, you should ask your dealer or the Leica Information Service (address, see p. 64) for advice.
- Even protected pictures (see previous section) are deleted when formatting the memory card.

Setting the function

1. In the **SETUP** section of the menu (see p. 13/22), select **Format** (5. 19), and
2. in the subsequent submenu select which of the two cards you want to format, or both.
 - To safeguard against unintentional settings, a corresponding confirmation prompt appears in the monitor.
3. Press the click wheel (1. 18) to confirm that you really want to format the memory card(s).

¹ The „X“ characters are placeholders.

Flash photography

General information on flash exposure metering and control

The LEICA S2 determines the required flash power by firing one or more ranging flashes in quick succession, fractions of a second before taking the actual picture. Immediately after this, at the start of exposure, the main flash is fired.

All factors that influence the exposure (such as picture filter and changes to the aperture setting, distance, reflective surfaces, etc.) are automatically taken into account.

Compatible flash units

All flash units and studio flash systems that comply with the currently valid ISO standard 10330 and the older DIN 190141 (positive polarity at X contact) can be connected to the LEICA S2.

Studio flash systems and other flash units with flash cable and standard flash plug can be connected via the flash connection socket (1.30).

The following flash units allow all of the functions described in this manual to be used when attached to the LEICA S2:

- The LEICA SF 58 system flash unit (order no. 14 488). With a maximum guide number of 190 (ft, in 105mm setting), an automatically controlled zoom reflector, an optional second reflector and many other functions, it is both powerful and versatile. Thanks to its permanently attached flash foot with associated additional control and signal contacts, which are used to automatically transfer a range of data and settings, it is very easy to use.
- Flash units which satisfy the technical requirements for System Camera Adaption (SCA) System 3000, are fitted with the SCA-3502-M5 adaptor^{2,3}, allow guide number control and are HSS compatible (see p. 44). Other commercially available flash attachments with standard flash foot^{4,5} and positive center contact, and which are fired by the center contact (X-contact, 1.30a), can also be used (without TTL flash control). We recommend the use of modern thyristor-controlled electronic flash units.

²When using the SCA-3502 adapter (version 5 onwards) the white balance (see p. 29) can be set to **Auto** for correct color reproduction.

³The use of flash systems from other camera manufacturers and SCA adapters for other camera systems is not recommended as their differing contact positions and assignments can result in malfunctions or even damage to the camera.

⁴If flash units not specially designed for the LEICA S2 are used, the white balance on the camera should be manually set to if required.

⁵The aperture specified on the lens and the sensitivity may need to be entered manually on the flash unit.

Flash sync speed

The flash sync speed of the LEICA S2 is $1/125$ s for conventional flash equipment with focal plane shutter, or $1/500$ s with central shutter. With system compatible, HSS compatible (see p. 44) flash units, all faster shutter speeds can also be used.

Studio flash systems in particular often have luminosity times that are considerably longer than the specified sync speeds. In order to take full advantage of the light quantity provided by these flash units, slower shutter speeds are recommended.

Selecting the sync speed / the sync speed range

The LEICA S2 allows you to subtly adjust the shutter speed used for flash photography in conjunction with speed priority and automatic program exposure modes to the lighting conditions for the relevant subject or to suit your picture composition ideas. You can choose between one automatic and several manual settings to do this.

Setting the function

1. In the **CAMERA** section of the menu (see p. 13/22), select **Auto Slow Synch.** (5.6), and
2. select the automatic lens-specific setting – **1/f** (focal length), or whether you want to specify a particular shutter speed yourself – **Manual Setting** – in the submenu.
3. In the **Manual Setting** submenu, set the range of shutter speeds permitted by specifying the fastest speed permitted.

Notes:

- **1/f** results in the slowest shutter speeds based on the rule of thumb for blur-free pictures taken from the hand, e.g. $1/60$ s with the Summarit-S 70mm f/2.5 ASPH. However, in the **Auto Slow Synch** menu it is limited to $1/125$ s even if the focal length used is longer.
- The setting field in the **Manual Setting** submenu initially contains the „default setting“ of **1/f**.

¹If, for example, you want to connect a studio flash system to the LEICA S2 that does not comply with the ISO standard, contact Leica Camera AG's customer service department (for address see p. 64) or the customer service department of a Leica agent.

Selecting the firing moment

The LEICA S2 allows you to choose between the conventional flash firing moment at the beginning of the exposure and synchronization with the end of the exposure, i.e. immediately before the 2nd shutter curtain begins to close the image aperture again.

The function is available with all flash units, including non-system compatible units, regardless of whether they are mounted in the flash shoe or connected by a cord, and with all camera and flash unit settings. The displays are identical in both cases.

Setting the function

1. In the CAMERA section of the menu (see p. 13/22), select **Flash Synch Mode** (5.7), and
2. select your preferred option in the submenu.

Attaching the flash unit

When attaching a flash unit to the LEICA S2 flash shoe (1.20), you should ensure that the foot of the flash unit is fully inserted and the clamping nut (if fitted) is tightened to prevent it accidentally falling out. This is particularly important for flash units with additional control and signal contacts, because any change to its position in the flash shoe can break the necessary contacts, leading to malfunctions.

Note:

Before attaching the flash, the camera and the flash unit must be turned off.

Settings for camera-controlled automatic flash mode

Once the flash unit used has been turned on and set to the appropriate mode for TTL operation (e.g. „TTL-HSS“ on the LEICA SF 58), the following actions are necessary on the LEICA S2

1. Before taking each picture with flash, first perform exposure metering by gently pressing the shutter release button so that the display in the viewfinder changes to the shutter speed values or the light balance. If this stage is missed out by fully depressing the shutter release button in one quick movement, the flash unit may not fire.
2. Set the preferred exposure mode or the required shutter speed and/or aperture. The shortest firing moment must be taken into account as this determines whether a "normal" flash is fired or an HSS flash.

TTL flash mode.

Fully automatic, i.e. camera controlled, TTL flash operation is available with the LEICA S2 when using system-compatible flash units (see p. 43), and in all of the camera's exposure modes.

Automatic fill-flash is also provided. This means that in order to ensure a balanced relationship between flash and available light at all times, the flash power is reduced by up to $1\frac{2}{3}$ EV as ambient brightness increases (fill-in flash). However, if the available brightness requires a faster shutter speed than the set firing moment ($\frac{1}{125}$ s for focal plane shutter, $\frac{1}{500}$ s for lenses with central shutter) or it is set manually, the camera will automatically switch a system-compatible flash unit to linear flash mode (HSS, see next section).

In addition, the LEICA S2 transfers the set sensitivity and aperture to the flash unit. Provided it has the right displays, the flash unit can then automatically adjust its specified range accordingly.

Notes:

- The following sections describe only those settings and functions available on the LEICA S2 and system compatible flash units.
- An exposure compensation set on the camera (see p. 35) only influences the measurement of available light. If you want to simultaneously use compensation of the TTL flash exposure measurement in flash mode – in parallel or in the opposite direction, you must make this additional setting (on the flash unit).
- The HSS flash method means that flashes are emitted in rapid succession throughout the entire shutter movement. As a result, the available energy must be split, resulting in a shorter range.
- More details of flash use, particularly for other flash units not specially designed for the LEICA S2, and for different flash unit operating modes can be found in the respective user guides.

High Speed Synchronization

Fully automatic, i.e. camera controlled, flash operation is available with the LEICA S2 when using system-compatible flash units (see p. 43), with all shutter speeds and in all of the camera's exposure modes. It is automatically activated by the camera if the selected or calculated shutter speed is shorter than the sync speed, i.e. $\leq \frac{1}{180}$ s for the focal plane shutter. If the flash unit is set correctly, this change does not require any further actions by the photographer.

Strobe flash mode with system compatible flash units

This flash method, in which several flashes are emitted in succession during an exposure, is possible in all of the camera's exposure modes.

In **P** and **A** modes, the camera automatically sets the necessary shutter speed for the selected flash number and frequency. If the required shutter speed results in overexposure due to the available light, this is indicated by the light balance (2.7).

In **M** and **T** an excessively fast shutter speed is indicated by the time display flashing (2.8/3.12) in the viewfinder and in the top panel display.

In such cases, exposure compensation can be carried out by changing the number of flashes, and/or the flash frequency and/or the aperture and/or the shutter speed (with **M** and **T**). For a successful strobe photograph, for example when several phases of one sequence of movement are recorded on one picture, the operating range of the flash unit, the number of flashes, the distance and of course the aperture are of crucial importance. You can find information about this in the instructions for your flash unit.

The flash lighting displays in the viewfinder with system compatible flash units

A flash symbol (2.4a) appears in the viewfinder display on the LEICA S2 as confirmation and to indicate different operating statuses.

- does not appear despite the flash unit being switched on and ready for use:
In such cases the LEICA S2 will not fire the flash unit even though it is switched on and ready for use. (e.g. because the incorrect mode is set on the flash unit)
- flashes before the picture is taken:
The flash unit is not yet ready for use
- is lit up before the picture is taken:
The flash unit is ready for use
- remains continuously lit after releasing the shutter:
The flash is ready to use again. If a flash exposure compensation is set on the flash unit, + or – (2.4b) also appears in the viewfinder as an additional indication

Flash with flash unit automatic mode

When using system-compatible flash units in automatic mode, the quantity of light reflected by the subject is metered and evaluated by an integrated sensor in the flash unit rather than by the camera. The exposure modes generally function in the same way as without flash. If the flash sync speed is not reached in **P** or **A**, or a shutter speed faster than the sync speed is set in **T** or **M**, the flash is suppressed.

As **P**, **A**, and **T** modes deliver a normally exposed photograph using the ambient light, the flash power should be reduced, i.e. a flash exposure compensation of e.g. -1 EV to -2 EV should be set. On system-compatible flash units, the aperture set on the lens is transmitted to the flash unit and automatically used as a basis for the automatic control. Metering takes account of the sensitivity set on the camera and any exposure compensation set for the ambient light (camera) and the flash (flash unit).

Manual flash with constant flash power

If the flash unit is used at full power or a fixed partial power (if available on the flash unit) in manual flash mode, the amount of flash light emitted is not controlled. The exposure modes on the camera essentially function in the same way as without flash. If the flash sync speed is not reached in **P** or **A** modes, or a shutter speed faster than the sync speed is set in **T** or **M** modes, the flash is suppressed.

The aperture to be set is derived from the flash power, the sensitivity and the distance to the subject or vice versa, the partial flash power to be set is derived from the aperture, the sensitivity, the focal length and the distance to the subject (see flash unit instructions).

Flash using the X contact

When you connect a non-system compatible flash unit using the accessory shoe, no information is transferred. Because the camera „cannot recognize“ the flash unit, it behaves in the same way as if no flash unit were connected. The shutter speed should be manually set to match the flash sync speed $1/125$ s, or $1/500$ s with central shutter (see p. 21) or to slower speeds; there is no automatic adjustment. The flash ready and control displays are inactive.

If the flash unit is suitable, the light can be controlled using the automatic control, i.e. the sensor on the flash unit, or manually by selecting the appropriate partial light power level (see flash unit instructions).

Flash using the flash connection socket

Flash units and large studio flash systems can be connected to the flash connection socket with a standard flash connector. Because the camera „cannot recognize“ a flash unit connected in this way, it behaves in the same way as if no flash unit were connected. The shutter speed should be manually set to match the flash sync speed $1/125$ s, or $1/500$ s with central shutter (see p. 21) or to slower speeds; there is no automatic adjustment. The flash ready and control displays are inactive.

Review mode

Selecting record and review modes

After turning on, the LEICA S2 is always in record mode, i.e. the monitor (1.22) remains dark – once it is ready to use (see p. 21).

To review the pictures, you can choose between two modes:

- **PLAY** Review for an unlimited time
- **Auto Review.** Brief review after taking the picture

Review for unlimited time - **PLAY**

Setting the function

Select normal review mode by briefly pressing button 1.20, regardless of whether this is done

- from record mode, i.e. with the monitor turned off, or

- from image data review (4.3, see p. 47), or

- from

. mode.

- The last picture taken appears in the monitor along with the corresponding displays 4.1.1 – 4.1.7 (see p. 11). However, if the memory card inserted does not contain any image files, the following message appears when you switch to play mode: **No Image To Display**

Automatic review of last picture

In **Auto Review** mode, each picture is shown in the monitor (1.22) immediately after it has been taken.

The function allows you to

- select the time for which the picture is displayed, and
- review the image data with and without histogram (see p. 47).

Setting the function

1. In the **SETUP** section of the menu (see p. 13/22), select **Auto Review** (5.23),
2. first select **Duration** in the submenu, and
3. select the required function or time in the next submenu: (**Off, 1 Second, 3 Seconds, 5 Seconds, Hold**).
4. To choose whether you want the picture to appear with or without a histogram (see also p. 47), return to the first submenu,
5. select **Histogram**,
6. and set the preferred option (**On, Off**).

Notes:

- From **Auto Review.** mode, you can switch back to **PLAY** mode (see above) at any time.
- Even pictures that have not yet been transferred from the camera's buffer memory onto a card - the LED 1.19 is still flashing - can be viewed immediately. By contrast, the pictures on the cards cannot be accessed while data transfer is still in progress.
- The LEICA S2 stores pictures in line with the DCF standards (Design Rule for Camera File System).
- The LEICA S2 can only review image data taken with cameras of this type.
- If you simultaneously save the image data in **JPEG** and **DNG** format (see p. 31), the image displayed is always based on the **JPEG** file.
- If using the serial exposure function (see p. 32) or automatic bracketing (see p. 35) both record modes will display the last picture in the series first. For details of how to select the other pictures in the series, see p. 48.

Normal review 4.1



- To ensure that the pictures can be viewed properly in the monitor, normal review only shows
 - the information in the header (4.1.1 -4.1.6), and
 - the field for specifying the amount of zoom in the bottom right (4.17), which represents the approximate position and size of the section displayed.

INFO-review 4.2

Instead of the full-screen image in normal review, the **INFO** review allows you to display a range of additional image data along with a histogram (see below) and a smaller picture.

Note:

You can use menu control to select different histogram variations (see next section).

Calling up the function

1. Press any of the 4 buttons 1.20, 1.21, 1.23, or 1.24.
 - The image field shows-for 5s - the 4 fields 4.1.9 - **MENU**, 4.1.10 - **INFO**, 4.1.11 - **PROTECT** and 4.1.12 - **DELETE** for the button functions valid in this situation.
2. Press the **INFO** button.
 - The additional information 4.2.1 -4.2.14 appears in the image field (see p. 11).

The histogram

The LEICA S2 allows you to choose between four histogram variations: Based on either the overall brightness or separately for the three primary colors red/green/blue, optionally with or without identification of the areas in the picture where no image appears (clipping), because they are too bright (red) or too dark (blue).

Setting the function

1. In the **SETUP** section of the menu (see p. 13/22), select **Histogram** (5.24), and
2. select the desired function in the submenu: **Standard without clipping**, **Standard with clipping**, **RGB without clipping**, or **RGB with clipping**.

Note:

- The histogram display always refers to the section of the picture displayed at that time.
- The histogram is not available when simultaneously viewing several smaller pictures (see p. 49).



Image data review 4.3

This view lists the settings used to produce the image previously shown.

Calling up the function

1. In normal review mode (4.1) press any of the 4 buttons 1.20, 1.21, 1.23, or 1.24.
 - The image field shows-for 5s - the 4 fields 4.1.9 - **MENU**, 4.1.10 - **INFO**, 4.1.11 - **PROTECT** and 4.1.12 - **DELETE** for the button functions valid in this situation.
2. Press the **MENU** button.
 - The image field shows the additional information 4.3.5 - 4.3.25 (see p. 12), and the button functions valid in this situation in the 4 fields 4.3.1 - **CAMERA**, 4.3.2 - **BACK**, 4.3.3 - **SETUP** and 4.3.4 - **PICTURE**.

Viewing other pictures / „Scrolling“ in the memory



1. In normal review mode (see above) press the click wheel (1.18).
 - The rectangle showing the zoom level and position (4.17) disappears.
2. You can then turn the click wheel to select the other pictures. Turning to the left takes you to the pictures with lower numbers, turning to the right to those with higher numbers. After the highest and lowest numbers, the series of pictures begins again in an endless loop, which means you can reach all pictures in either direction
 - The picture and file numbers in the monitor change accordingly.



Image review, zoom in



- In normal review mode (see above), turning the click wheel (1.18) to the right zooms in on a central section of the picture. The more you turn the ring, the greater the enlargement and the smaller the section area. The maximum enlargement is 1 pixel on the monitor corresponding to 1 pixel in the picture.
- The rectangle inside the frame (4.1.7) in the bottom right corner of the monitor indicates approximately the enlargement of the section shown.

Selecting the amount of zoom in

1. When zoomed in (see above), press the click wheel (1.18).
 - The frame indicating the zoom amount and position (4.1.7) includes an additional red horizontal double arrow to indicate the direction of movement of the zoomed section. A vertical double arrow also appears in the field next to button 1.24 to indicate the button function.

Notes:

- From an enlarged view, you can only select other pictures if the **Zoom Lock** function is activated (see below).
- This function is also available in **INFO** review mode (4.2, see p. 47).

Horizontal movement



2. You can turn the click wheel to move the zoomed area to the left or the right.
 - The rectangle moves in the frame (4.1.7) in the direction you turn the wheel.

Vertical movement

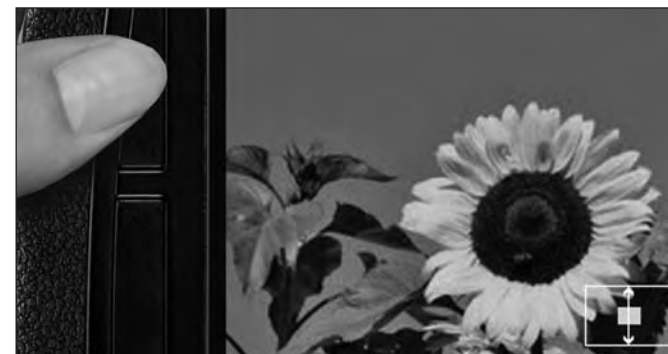

2. Press and hold button 1.24.
 - The red double arrow in the frame 4.17 moves to the vertical position and the field with the white double arrow disappears.
3. Turning the click wheel moves the zoomed area up or down.
 - The rectangle moves in the frame (4.1.7) according to the direction you turn the wheel, left = up, right = down.

Retaining the zoom when „scrolling“

When the **Zoom Lock** function is activated, the set zoom is retained when you view other pictures.

Setting the function

1. In the **SETUP** section of the menu (see p. 13/22), select **Zoom Lock** (5.31), and
2. select the desired function in the submenu.
3. In normal review mode (4.1) and with an enlarged picture, press any of the 4 buttons 1.20, 1.21, 1.23, or 1.24.
 - The image field shows-for 5s- the 4 fields 4.1.9 – **1:1**, 4.1.10 – **INFO**, 4.1.11 – **PROTECT** and 4.1.12 – **DELETE** for the button functions valid in this situation.
4. Press and hold button 4.1.9 to select other pictures by turning the click wheel (1.18) while retaining the enlargement and the zoom.

Note:

This function is also available in **INFO** review mode (4.2, see p. 47).

Simultaneously viewing several smaller pictures

Turning the click wheel (1.18) to the left

- reduces the size of enlarged pictures, and turning beyond a **1:1** representation
- allows simultaneous viewing of 4 or 9 pictures.
 - The green frame indicates a single picture when viewing 4 or 9 (the one previously shown at full size), all 9 pictures if you continue turning to the left.

Selecting one of the smaller pictures

1. Press the click wheel (1.18) to activate the selection function.
 - The frame color changes from green to red.
2. You can select the other pictures by turning the click wheel.
 - If the frame is around one picture, the red frame moves from picture to picture a line at a time in an endless loop and if it is around 9 pictures, it moves to the next group of 9, one block at a time.
3. To deactivate the selection function, press the click wheel again.
 - The frame color changes back to green.
4. Turning the click wheel to the right again allows you to re-enlarge the framed picture (see above „Image review zoom in“).

Switching to the other memory card

1. Turn the click wheel (1.18) to the left beyond the display of 9 pictures.
 - The selection menu with representations of the two cards appears in the monitor. A green frame indicates the currently active card.
2. To activate the selection function, press the click wheel.
 - The frame color changes from green to red.
3. You can switch from one card to the other by turning the click wheel again.
 - The red frame moves between the cards.
4. To deactivate the selection function and activate the framed card, press the click wheel again.
 - The frame color changes back to green.

Protecting pictures / Clearing delete protection

1. In normal review mode (4.1) press any of the 4 buttons 1.20, 1.21, 1.23, or 1.24.

- The image field shows - for 5s - the 4 fields 4.1.9 - MENU, 4.1.10 - INFO, 4.1.11 - PROTECT and 4.1.12 - DELETE for the button functions valid in this situation.



2. Press the Protect button.

- The image field shows
 - the 4 fields 4.5.1 - All/Single, 4.5.2 - BACK, 4.5.3 - OK and 4.5.4 - Cancel ALL for the button functions valid in this situation
 - the 2 fields 4.5.5 - Protect? and 4.5.6 - Single/All for the currently active functions, and
 - if applicable the symbol (4.5.7) for a protected picture. In such cases, the entry in field 4.5.5 changes to Cancel protection? and in field 4.5.4 to Protect ALL



3. Use button 1.24 to select whether you want to protect only the picture shown or all pictures, or whether you want to cancel the existing protection for only the picture shown or for all pictures.
- The entries in field's 4.5.1 and 4.5.6 change.

Notes:

- If protection or canceling protection for single pictures is active, other pictures can be called up by turning the click wheel (1.18).
 - The BACK button takes you back to step 2.
 - You can use button 1.23 to switch directly to the menu for canceling protection or to return from that menu.
4. Press the OK button to execute the protection process or to cancel the protection.
- The symbol (4.5.7) for a protected picture appears in the monitor or disappears.

Deleting pictures

1. In normal review mode (4.1) press any of the 4 buttons 1.20, 1.21, 1.23, or 1.24.
 - The image field shows-for 5s - the 4 fields 4.1.9 – MENU, 4.1.10 – INFO, 4.1.11 – PROTECT and 4.1.12 – DELETE for the button functions valid in this situation.
2. Press the Delete button.
 - The image field shows
 - the 4 fields 4.5.1 - All/Single, 4.5.2 - BACK, 4.5.3 – Protect and 4.5.4 – OK for the button functions valid in this situation.
 - the 2 fields 4.5.5 - Delete? and 4.5.6 - Single/All for the currently active functions, and
 - if applicable the symbol (4.5.7) for a protected picture. In such cases, the OK button is not available and the font color changes from white to gray to indicate this.
3. Use button 1.24 to select whether you want to delete only the picture shown or all pictures,
 - The entries in fields 4.5.1 and 4.5.6 change.

Notes:

- If deletion of single pictures is active, other pictures can be called up by turning the click wheel (1.18).
- You can use button 1.23 to switch directly to the menu for protecting pictures (see previous section).
- The BACK button takes you back to step 2.
- Protected pictures are not deleted. After deleting, the last (highest number) of the remaining pictures appears.

To delete only one picture



4. Press the OK button to execute the delete process.
 - The next picture not deleted appears in the monitor. If this was the only picture, you will see the message: **No Image To Display**

To delete all pictures



4. Press the OK button.
 - The following query appears in the monitor: **Delete ALL pictures?**
- Note:**
The BACK button takes you back to step 2.
5. Press the OK button to confirm and execute the delete process.
 - The monitor shows the message: **No Image To Display**

Note:

Protected pictures are not deleted. After deleting, the last (highest number) of the remaining pictures appears.

Additional functions

Transferring data to a computer

The LEICA S2 is compatible with the following operating systems: Microsoft®: Windows® XP / Vista®

Apple® Macintosh®: Mac® OS X (10.5)

The LEICA S2 is equipped with a USB 2.0 interface for transferring data to a computer. This allows fast data transfer to computers with the same kind of interface. The computer used must either have a USB port (for direct connection to the LEICA S2) or a card reader for CF or SD/SDHC cards.

Note:

Connecting two or more devices to a computer or connecting using a USB hub or extension cables can result in malfunctions.

Via USB connection

The LEICA S2 allows data to be transferred via a USB cable using two different standards. It thus takes account of the fact that some programs for transferring picture data require a connection complying with the PTP protocol. In addition, it is always possible to operate the camera as an external drive („bulk storage“).

Setting the function

1. In the **SETUP** section of the menu (see p. 13/22), select **USB Mode** (5.20), and
2. in the subsequent submenu select **PTP** or **Mass Storage**.

Connecting and transferring data using the PTP protocol

If the LEICA S2 is set to **PTP** and is detected by the connected computer, proceed as follows:

Note:

When transferring data using the PTP standard, all pictures on the memory card used are displayed on the computer, provided storage of the image data is set to **Sequential** or **Parallel** (see p. 31). By contrast, if **External** is set, no data is transferred.

With Windows® XP / Vista®

3. Use the USB cable supplied (D) to connect the data output socket (1.32) on the LEICA S2 to a free USB port on the computer. To do this, first open the cover (1.29) over the socket on the camera to the front.

With Windows® XP

After connecting, a message appears on the desktop to confirm that the LEICA S2 has been detected as new hardware (1st connection only!).

4. Double-click on the message (not required after the 1st connection). A pull-down menu entitled „S2 Digital Camera“ opens for the data transfer wizard.
5. Click on „OK“ and follow the subsequent instructions in the wizard to copy the pictures to a folder of your choice and access them in the normal way.

With Windows® Vista®

After connection, a message about installation of the device driver software appears above the taskbar. At the same time „USB Connection“ appears on the camera display. Successful installation is confirmed by another message. The „Automatic Review“ menu opens with various device options.

4. You can use the Windows wizard to „Import Images“ or „Open Device to View Files“ in the normal way, to
5. access the card directory structure using Windows Explorer.

With Mac® OS X (10.5)

1. Use the USB cable supplied (D) to connect the data output socket (1.32) on the LEICA S2 to a free USB port on the computer. To do this, first open the cover (1.29) over the socket on the camera to the front. Once the camera has been successfully connected to the computer, USB Connexion appears on the camera display.
2. Now open the „Finder“ on the computer.
3. In the left window, click on “Programs” in the “Locations” category.
4. Now select the „Digital Images“ program in the right window. The program opens and the name „S2 Digital Camera“ appears in the program title bar.
5. The pictures can now be saved on the computer using the „Load“ button.

Connecting and transferring data with the camera as an external drive (Mass Storage)

With Windows® operating systems:

If the LEICA S2 is connected to the computer using the USB cable, the operating system detects it as an external drive and assigns it a drive letter. Use Windows® Explorer to transfer/save the image data to your computer.

With Mac® operating systems:

If the LEICA S2 is connected to the computer using the USB cable, the memory card used appears as a storage medium on the desktop. Use the Finder to transfer/save the image data to your computer.

Note:

As long as this function is active, all other camera functions are blocked.

Important:

- Only use the USB cable (D) supplied.
- While data is being transferred from the LEICA S2 to the computer, the connection may not under any circumstances be broken by removing the USB cable, as otherwise the computer and/or the LEICA S2 can crash and may cause irreparable damage to the memory card.

While data is being transferred from the LEICA S2 to the computer, the camera may not be turned off or turn itself off due to a lack of battery capacity, as otherwise the computer can crash. For the same reason the battery must never be removed from the camera whilst the connection is active. If the battery capacity is about to run out during data transfer, stop the data transfer, turn off the LEICA S2 (see p. 21) and charge the battery (see p. 14).

Connecting and transferring data using card readers

The image files can also be transferred to other computers using a standard card reader for CF or SD/SDHC memory cards. Card readers with a USB interface are available for computers with a USB interface. If your computer is equipped with a PCMCIA slot (common on portable models), plug-in cards with a PCMCIA connection are available as an alternative. These devices, and further information about them, are available from a computer accessory dealer.

Data structure on the memory card

When the data stored on a card is transferred to a computer, the following folder structure is used:

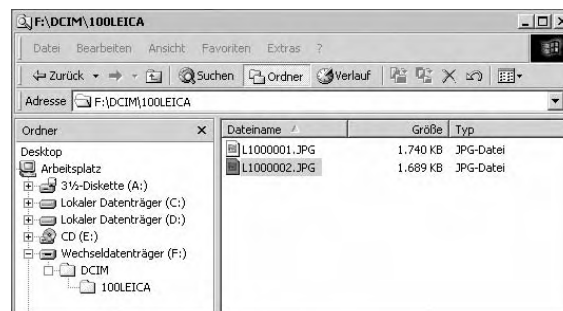

Up to 9999 pictures can be stored in the folders 100LEICA-, 101LEICA-, etc.

Adobe® Photoshop® Lightroom®

If you have selected the standardized and future-proof DNG (Digital Negative) format, you require highly specialized software to convert the saved raw data into optimum quality, for example the professional Adobe® Photoshop® Lightroom®. It provides quality-optimized algorithms for digital color processing, delivering exceptionally low noise photographs with incredible resolution.

During editing, you have the option of adjusting parameters such as white balance, noise reduction, gradation, sharpness etc. to achieve an optimum image quality.

Adobe® Photoshop® Lightroom® is available as a free download when you register your LEICA S2 on the Leica Camera AG homepage. Further details can be found on the registration card in the camera packaging.

LEICA Image Shuttle

The exclusive LEICA Image Shuttle software enables you to remotely control the camera from a computer and to directly store the image data on the computer's hard drive for „tethered shooting“. All of the key camera functions can be controlled. This convenient solution provides ideal support in the studio and on location.

LEICA Image Shuttle is available as a free download when you register your LEICA S2 on the Leica Camera AG homepage. Further details can be found on the registration card in the camera packaging.

System requirements

Microsoft® Windows® XP Professional or Home Edition with Service Pack 2 / Vista; Mac OS X 10.5.6 or later
On some Windows versions, it is possible that the operating system will issue a warning about a missing Windows signature. Ignore this message and continue with the installation.

Installing firmware updates

Leica is constantly working on developing and optimizing its products. As digital cameras have many functions that are controlled electronically, some of these improvements and enhancements to the functions can be installed on the camera at a later date.

To do this, Leica provides firmware updates at irregular intervals, which you can easily download from our homepage to your camera yourself:

1. Format a memory card in your LEICA S2.
2. Turn off the camera and insert the card into an SD/SDHC card reader - either integrated or connected to your computer. (A reader is required for Firmware updates).
3. Download the Firmware file from the Leica S2 site using the „UPDATES“ link.
4. Save the file s2-X_xxx.upd at the top level of the card's folder structure. X_xxx stands for the relevant version.
5. Remove the card properly from your card reader, insert the card into the camera and close the door. Turn on the camera using the main switch.
6. Confirm the prompt that appears in the monitor as to whether you want to update the Firmware on the camera to version X.xxx.

The update process takes around 180 s. You will then be prompted to restart the camera using the main switch.

7. 1.Turn the camera off and back on again.

Note:

If the battery does not have sufficient charge, you will see a corresponding warning message.

HDMI slide show

With the LEICA S2 you can view the saved pictures at any size and in excellent quality via an HDMI cable connection using external playback equipment.

Setting the function

1. In the **SETUP** section of the menu (see p. 13/22), select **HDMI** (5.28),
2. first select Resolution in the submenu, and
3. select the required format or the automatic setting.

Note:

For optimum playback quality, you should select **1080p**.

4. In the first submenu select **Slideshow**.
5. Then select Select Images in the next submenu that appears.
 - The image field shows
 - the 4 fields 4.5.1 - **All**, 4.5.2 - **BACK**, 4.5.3 - **Select ALL** and 4.5.4 - **OK** for the button functions valid in this situation
 - the 2 fields 4.5.5 - **Remove?** and 4.5.6 - **Single** for the currently active functions, and
 - if applicable the symbol (4.5.7) for a picture already selected.

To select only one picture

6. Press the **OK** button.
 - The symbol 4.5.7 appears in the monitor.

To select all pictures

6. Press button 1.24, and
 - The entries in fields 4.5.1 and 4.5.6 change.
7. Confirm your selection with the **OK** button.
 - The LED 1.19 flashes during the processing time and the symbol 4.5.7 then appears in the monitor.

Notes:

The **BACK** button takes you back to step 4.

To undo a selection

6. Press button 4.5.3
 - The entries in fields 4.5.5 and 4.5.3 change.
7. The subsequent procedure is exactly the same as that described above for selecting pictures.
 - The symbol 4.5.7 disappears from the relevant pictures.
8. In the first submenu select **Duration**, and
9. select the required time, or **Manual** if you want to change pictures yourself.
10. Finally, to start the slideshow select **Start Show** in the first submenu.
 - **END** appears in field 4.5.3, **BACK** in field 4.5.3, **NEXT** in field 4.5.4, along with an indication that the slideshow is running.
11. Other pictures can be selected
 - using the **BACK** and **NEXT** buttons,
 - or using the click wheel (1.18) just as when viewing pictures on the monitor.

Note:

Even if the pictures are set to change automatically after a specified time, you can call up the previous/next picture manually at any time.

12. The slideshow can be stopped at any time by pressing the **END** button.

Notes:

- If the **Auto Power Off** function is activated (see p. 26), a slideshow in progress is stopped after the set time.
- During a slideshow, you can take a new picture at any time by fully pressing the shutter release button to the 3rd pressure point (see p. 32).

Miscellaneous

System accessories

Interchangeable lenses

The range of interchangeable lenses in the Leica S system includes focal lengths from wide angle to telephoto, including a macro lens for close-up pictures, a zoom lens and a T(ilt) and S(hift) model for preventing falling lines or to precisely specify the depth of field progression. Many models are available with or without an integral central shutter - for flash pictures with sync speeds of up to $\frac{1}{500}$ s. All Leica S lenses offer high speeds relative to the picture format and always deliver outstanding imaging results.

Filters

UVa filters and polarization filters are available for Leica S lenses fitted with standard filter threads.

Interchangeable focusing screens

There are three focusing screens for the LEICA S2:

- Uniform ground-glass screen (standard, included with camera, order no. 16 000)
- Uniform ground-glass screen with grid divisions (order no. 16 002, also has markings for creating slides for TV reproduction).
- The focusing screen with order no. 16,001 has a split-image and micro-prism ring in addition to the ground glass surface. The focusing screens are supplied separately in a container with tweezers and a dust brush.

Flash units

With a maximum guide number of 190 (ft. in 105mm setting), an automatically controlled zoom reflector, an optional second reflector and many other functions, the LEICA SF 58 system flash unit is both powerful and versatile. Thanks to its permanently attached flash foot with additional control and signal contacts, which are used to automatically transfer a range of data and settings, it is very easy to use. (Order no. 14 488)

The LEICA SF 24D system flash unit is exceptionally compact. Like the LEICA SF 58, it has a permanently attached flash foot with all contacts and is also very easy to operate. (Order no. 14 444)

Hand grip S2

Thanks to its shape and conveniently positioned controls, the S2 hand grip makes it much easier to take portrait format pictures. In addition, it allows a supplementary battery to be used to extend the capacity, i.e. the operating time / number of pictures. It is quick and easy to attach using a tripod screw. (Order no. 16 003)

S Pro battery charger

With the S Pro battery charger you can significantly increase and ensure the availability of your Leica S system, particularly when used for long periods: It can charge two batteries simultaneously. (Order no. 16 011)

Remote release cable S

The electric remote release cable S is ideal if you require the maximum possible freedom from blurring. (Order no. 16 012)

HDMI cable

The HDMI cable allows exceptionally fast transfer of picture data to playback or storage equipment with corresponding HDMI sockets. Length = 1.5m (Order no. 14 491 / 14 492 [JP/TW])

Spare parts

Order no.

Camera bayonet cap.....	16 021
Carrying strap	16 006
Standard focusing screen.....	16 000
Viewfinder cover	16 015
Lithium ion battery	14 429
Battery charger S (with integrated US mains pins plus EU, UK and AUS power plugs and car charging cord)	16 009

Precautions and care instructions

General precautions

- Do not use the LEICA S2 in the immediate vicinity of devices with powerful magnetic, electrostatic or electromagnetic fields (e.g. induction ovens, microwave ovens, television sets or computer monitors, video game consoles, cell phones, radio equipment).
- If you place the LEICA S2 on or very close to a television set, its magnetic field could interfere with picture recordings.
- The same applies for use in the vicinity of cell phones.
- Strong magnetic fields, e.g. from speakers or large electric motors, can damage the stored data or the pictures.
- If due to the effects of electromagnetic fields the LEICA S2 malfunctions, remove the battery and then switch the camera on again after replacing the battery. Do not use the LEICA S2 in the immediate vicinity of radio transmitters or high-voltage power lines.
- Their magnetic fields can also interfere with picture recordings. Protect the LEICA S2 from contact with insect sprays and other aggressive chemicals. Petroleum spirit, thinner and alcohol may not be used for cleaning.
- Certain chemicals and liquids can damage the LEICA S2 body or the surface finish.
- As rubber and plastics sometimes emit aggressive chemicals, they should not remain in contact with the LEICA S2 for extended periods.

- The LEICA S2 has a range of design features that provide a certain amount of protection against moisture and dust. Nevertheless, you should ensure that neither water nor sand and dust can get into the camera body, e.g. when it is snowing or raining and on the beach.
- and dust can damage the camera and the memory card. Take particular care when changing lenses and when inserting and removing the cards.
- If moisture does get in, it can cause malfunctions and even permanent damage to the LEICA S2 and the memory cards.
- If saltwater spray gets onto the LEICA S2, wet a soft cloth with tap water, wring it out thoroughly and wipe the camera with it. Then wipe down thoroughly with a dry cloth.

Monitor and top panel display

- If the LEICA S2 is exposed to significant temperature fluctuations, condensation can form on the displays. Wipe them carefully with a soft dry cloth.
- If the LEICA S2 is very cold when it is turned on, the displays may at first appear darker than usual. As soon as the camera warms up, they will regain their normal brightness. The monitor is manufactured using a high-precision process. This ensures that, of the total of around 460,000 pixels, more than 99.995% work correctly and only 0.005% remain dark or are always light. However, this is not a malfunction and it does not impair the reproduction of the picture.

Sensor

Cosmic radiation (e.g. on flights) can cause pixel defects.

Condensation

If condensation has formed on or in the LEICA S2, you should turn it off and leave it to stand at room temperature for around an hour. Once the camera temperature has adjusted to room temperature, the condensation will disappear by itself.

Care instructions

As any soiling also represents a growth medium for microorganisms, you should take care to keep the equipment clean.

For the camera

- Only clean the LEICA S2 with a soft, dry cloth. Stubborn dirt should first of all be covered with a well-thinned cleaning agent and then wiped off with a dry cloth.
- To remove stains and fingerprints, the camera and lens should be wiped with a clean lint-free cloth. Tougher dirt in hard to reach corners of the camera body can be removed with a small brush. Be careful not to damage the shutter blades and mirror surface, for instance with the shaft of the brush.
- All mechanically operated bearings and sliding surfaces on your LEICA S2 are lubricated. Please remember this if you will not be using the camera for a long period of time. To prevent the lubrication points becoming gummed up, the camera shutter should be released a number of times every three months. It is also recommended that you repeatedly move and use all other controls.

For lenses

- Normally, a soft hairbrush is sufficient to remove dust from the outer lens elements. However, in case of more stubborn dirt, they can be carefully cleaned with a very clean, soft cloth that is completely free of foreign matter, using circular motions from the inside to the outside. We recommend micro-fiber cloths (available from photographic and optical specialists) that are stored in a protective container and can be washed at temperatures of up to 40°C (without fabric softener, never iron!). Cloths for cleaning glasses, which are impregnated with chemicals, should not be used as they can damage the lens glass.
- For optimum front lens protection in unfavorable photographic conditions (e.g. sand, salt water spray), use transparent UVa filters. However, you should bear in mind that, like all filters, they can cause unwanted reflections in certain backlight situations and with high contrasts. The generally recommended lens hood also protects the lens from unintentional fingerprints and the rain.

For the battery

Rechargeable lithium ion batteries generate power through internal chemical reactions. These reactions are also influenced by the external temperature and humidity. Very high or low temperatures reduce the life of the battery.

- Always remove the battery if you will not be using the LEICA S2 for a long period of time. Otherwise, after several weeks the battery could become totally discharged, i.e. the voltage is significantly reduced, as the LEICA S2 uses a low no-load current (to save the date and time) even when it is turned off.
- Lithium ion batteries should only be stored in a partially charged condition, i.e. not completely discharged or fully charged (indicated in the top panel display (1.11)), For very long storage periods, they should be charged for around 15 minutes twice a year to prevent total discharge.

- Always ensure that the battery contacts are clean and freely accessible. While lithium ion batteries are proof against short circuits, they should still be protected against contact with metal objects such as paper clips or jewelry. A short-circuited battery can get very hot and cause severe burns.
- If a battery is dropped, check the casing and the contacts immediately for any damage. Using a damaged battery can damage the LEICA S2.
- Batteries have only a limited service life.
- Take damaged batteries to a collection point to ensure correct recycling.
- Never throw batteries into a fire as this can cause them to explode.

For the charger

- If the charger is used in the vicinity of radio receivers, it can interfere with the reception; make sure there is a distance of at least 1m between the devices.
- When the charger is in use, it can make a noise (buzzing) – this is quite normal and is not a malfunction.
- When it is not in use, disconnect the charger from the mains as otherwise it uses a certain (very small) amount of power even when no battery is inserted in it.
- Always keep the charger contacts clean, and never short-circuit them.

For memory cards

- While a picture is being stored or the memory card is being read, it may not be removed, nor may the LEICA S2 be turned off or exposed to vibrations.
- For safety, memory cards should only ever be stored in the antistatic cover supplied.
- Do not store memory cards where they will be exposed to high temperatures, direct sunlight, magnetic fields or static discharge.
- Do not drop or bend memory cards as this can damage it and result in loss of the stored data.
- Always remove the memory cards if you will not be using the LEICA S2 for a long period of time.

- Do not touch the connections on the memory card and keep them free of dirt, dust and moisture.
- It is recommended that memory cards be reformatted from time to time, as fragmentation occurs when deleting, which can block some of the memory capacity.

Cleaning the sensor

If any dust or dirt particles should adhere to the sensor cover glass, depending on the size of the particles this can be identified by dark spots or marks on the pictures. The LEICA S2 can be sent to Leica AG's Customer Service department for the sensor to be cleaned at a cost (address: see p. 64) - this cleaning is not included in the warranty. You can also perform the cleaning yourself, using the **Sensor Cleaning** function in the menu. This allows access to the sensor by keeping the shutter open.

Notes:

- Generally: To protect against ingress of dust etc. into the interior of the camera, it is important always to have a lens or a cover fitted to the LEICA S2.
- For the same reason, when changing lenses work without delay and in an environment that is as dust-free as possible.
- As plastic parts can easily pick up a static charge and then attract more dust, individual lens caps and covers should only be stored for short periods in pockets in clothing.

Setting the function

1. In the **SETUP** section of the menu (see p. 13/22), select **Sensor Cleaning**(5.21). The respective sub-menu appears.
2. Providing the battery has sufficient capacity, i.e. at least 60%, confirm the function in the submenu. The message **Please switch off camera after inspection** appears

Note:

However, if the battery capacity is lower, the warning message **Attention - Battery too low for sensor cleaning** appears instead to indicate that the function is not available, i.e. **Yes** cannot be selected

3. Press the shutter release button (1.19). The shutter opens and remains open.
4. Perform the cleaning. Make sure you follow the instructions under „Notes“.
- 5 After cleaning, turning the camera off closes the shutter again. The message **Attention- Please stop sensor cleaning immediately** appears

Notes:

- As far as possible, both inspection and cleaning of the sensor should be performed in a dust-free environment to prevent further soiling.
- An 8x or 10x magnifying glass is very useful for the inspection and after cleaning.
- Lightly adhering dust can be blown off the sensor cover glass using clean and, if necessary ionized gases such as air or nitrogen. It makes sense to use a (rubber) bellows with no brush for this purpose. Special, low pressure cleaning sprays such as „Tetenal Antidust Professional“ can also be used in line with their specified usage.
- If the particles cannot be removed from the sensor in this way, please refer the matter to your Leica Information Service (address: see p. 64).

- If the battery capacity falls to less than 40% while the shutter is open, a warning message **Attention Battery low Please switch off camera** will appear on the monitor. At the same time a sustained beep tone will sound, which continues until the camera is switched off. Turning the camera off will cause the shutter to be closed again. Be absolutely sure in this case that the shutter window is clear, i.e. that no object can obstruct the closing movement of the shutter, otherwise damage may occur!

Important:

- Leica Camera AG accepts no liability for damage caused by the user when cleaning the sensor.
- Do not attempt to blow dust particles off the sensor cover glass using your mouth; even tiny droplets of saliva can cause marks that are difficult to remove.
- Compressed air cleaners with high gas pressure may not be used as they can also cause damage.
- Take care to avoid touching the sensor surface with any hard objects during inspection and cleaning.

Storage

- If you will not be using the LEICA S2 for an extended period, we recommend that you
 - a. turn it off (see p. 21),
 - b. remove the memory cards (see p. 17), and
 - c. remove the battery (see p. 17), (after a maximum of 3 months, the set time and date will be lost, see p. 26).
- A lens works like a magnifying glass if bright sunlight shines on the front of the camera. The camera must therefore never be set aside in strong sunlight without protection. Use the lens cap and keep the camera in the shade (or immediately put it away in the case) help to prevent damage to the interior of the camera.
- You should preferably store the LEICA S2 in a closed and padded container so that nothing can damage it and it is protected from dust.
- Store the LEICA S2 in a dry, adequately ventilated place, where neither high temperatures nor high humidity will occur. When used in humid conditions, the LEICA S2 should be completely cleared of all moisture before being stored away.
- Photo cases that became wet during use should be emptied to prevent damage to your equipment caused by moisture and any leather-tanning residue released.
- To prevent fungal growth during use in hot, humid tropical climates, the camera equipment should be exposed to the sun and air as much as possible. Storage in airtight containers or cases is recommended only if a desiccant such as silica gel is placed in the container.
- To prevent the formation of fungus, do not store the LEICA S2 in a leather case for extended periods of time.
- Note the serial numbers of your LEICA S2 and lenses, as these are extremely important in case of loss.

Accessories.....	55	DNG	28/62
Connection cords	55	Enlarge, see play mode and viewing pictures	48
Flash units	55	Exposure control / Exposure metering	37/34
Filters	55	Bracketing	35/36
Hand grip S2	55	Exposure compensation	35
Interchangeable lenses	55	Metering methods.....	34
Remote release cord S	55	Center-weighted metering.....	34
S Pro battery charger	55	Multiple field metering	34
Aperture, etting.....	20/37	Spot metering	34
Aperture priority.....	38	Metering memory lock	34
Autofocus.....	33	Modes	
Sharpness priority (AFs).....	33	Aperture priority.....	38
Shutter release priority (AFc)	33	Long time exposure.....	39
Battery	14	Manual setting	39
Charge level displays.....	17	Programmed automatic exposure mode	38
Charging	16	Program shift.....	38
Insertion / removal	17	Shutter speed priority.....	38
Care instructions.....	56/57	Values above and below the metering range	36
Carrying strap.....	14	Filters	55
Color saturation, see Picture properties	31	Firmware downloads	54
Color space.....	31	Flash operation.....	43
Compression rate	28	Attaching a flash unit	44
Contrast, see image	31	Automatic computer mode.....	45
Data structure on the memory card.....	53	Flash connection socket	45
Date	26	Flash exposure compensation.....	62
Deleting pictures		General.....	43
all pictures on the memory cards	51	High speed sync (HSS)	44
single pictures	51	Manual flash with constant flash power.....	45
Depth of field preview button.....	41	Ready and control displays.....	45
Depth of field	41	Strobe flash mode.....	45
Designation of parts	8	Synchronization	43
Displays		Sync speed / Sync speed range	43
in the monitor	11	TTL flash mode.....	44
in the top panel display.....	10	X contact	45
in the viewfinder.....	9	Flash units.....	43
Distance setting	33	File format / Compression.....	28
Depth of field.....	41	Focusing.....	33
Metering field	33	Autofocus	33
Range finder	33	Manual setting.....	33
Setting ring	33		

Focusing screens.....	55	Review mode	46	USB connection.....	52
Changing	19	Enlarging	48	Viewfinder	
Formatting the memory card	42	Four / nine single pictures simultaneously	49	Displays	9
HDMI	54/55	Scrolling	48	Setting the eyepiece	21
Histogram	47	Selecting the memory card	49	Viewing pictures	
HSS flash mode , see under Flash mode	44	Single pictures	47	with the Auto Review function (automatic review)	46
Image frequency.....	32	Zoom in.....	48	with the PLAY function	46
Image properties (contrast, sharpness, color saturation).....	31	Scope of delivery	7	Volume, setting acknowledgement (response) tones	27
Info service, Leica	64	Self-timer	40	Warning messages.....	6
Interchangeable lenses	20/55	Sensitivity	30	White balance.....	29
Internet / Leica homepage.....	64	Sensor Cleaning	58	Automatic	29
ISO sensitivity.....	30	Series exposures	32	Fixed settings	29
Lenses, Leica S.....	20	Sharpness / Image properties	31	Manual	29
Attaching and removing	20	Shutter, see Shutter release and Technical Data.....	62	Metered.....	29
Main switch.....	21	Focal plane shutter	21/21	Zoom, Selection of, see Review mode	48
Memory cards	17/31	Central shutter	21/21		
Inserting and removing.....	17	Shutter release button, see Shutter and Technical data	32		
Saving image data.....	52	Shutter speed, setting	37		
Selecting the memory card	31/49	Shutter speed priority	38		
Menu control	22	Shutter speed setting dial	37		
Menu items.....	13	Sounds (acknowledge (response) tones).....	27		
Menu language	26	Spare parts.....	55		
Mirror pre-release.....	40	Storing the LEICA S2.....	58		
Monitor.....	27/11	Switch off, automatic.....	26		
Setting the brightness / illumination	27	Technical Data	62		
Noise reduction	39	Time and date.....	26		
Parts, designation.....	8	Top panel display	27		
Programmed automatic exposure mode	38	Setting the brightness.....	27		
Protecting pictures / Clearing delete protection	50	Transferring data to a computer	52		
Raw data / DNG	28	Card reader.....	53		
Record and review modes	46	Mass storage	53		
Repairs / Leica Customer Service.....	64	PTP.....	52		
Resetting all custom menu settings	41	Turning on / off.....	21		
Resolution.....	28/62	Automatic power off.....	26		

Technical Data

Camera type Digital SLR

Lens connection Leica S bayonet

Lens system Leica S lenses

Picture format 30 x 45 mm

Image sensor Low Noise CCD sensor with 6 µm pixel spacing

Resolution 7500 x 5000 (37,5 MP)

Dynamic range 12 stops

Color depth 16 bit per pixel

Low pass filter None, detection and suppression of moiré by digital signal processing

Data formats DNG™ (raw data), either uncompressed or slightly compressed (by non-linear reduction of color depth), 2 JPEG compression levels

File size DNG™/ JPEG 37.5MP: approx. 2-16MB

Buffer memory 1GB / 8 pictures in series

Color spaces Adobe® RGB, sRGB, ECI RGB

White balance Automatic, manual, 7 presets, color temperature entry

Storage medium CF cards up to 64 GB, SD cards up to 2 GB, SDHC cards up to 32 GB

Menu languages German, English, French, Spanish, Italian, Japanese, Traditional Chinese, Simplified Chinese, Russian

Compatibility Windows® XP / Vista®; Mac® OS X (10.5)

Exposure control

Exposure metering Open aperture metering through the lens (TTL)

Metering methods Spot (3.5%), center-weighted, multiple field metering (5 fields)

Metering memory lock Pressing shutter release to pressure point, permanent storage with button 1.17, indicated by disappearance of relevant metering method symbol in viewfinder

Exposure compensation ± 3 EV (exposure values), adjustable in half steps

Automatic bracketing Choice of 3 or 5 pictures, choice of 1/2 EV, 1 EV, 2 EV, 3 EV variation between individual pictures, different exposures achieved by adjustment of aperture and/or shutter speed depending on selected mode

Metering range (at f/2.5 and ISO 160) Spot metering: from 0.5 cd/m² to 125,000 cd/m², i.e. from EV+2.7 to EV 20 or from 1s at f/2.5 to 1/4000 s at f/16, center-weighted and multiple field metering: from 0.18 cd/m² to 125.000 cd/m², i.e. from EV+1.7 to EV 20 or from 2 s at f/2.5 to 1/4000 s at f/16, warning message in viewfinder if above or below metering range

Measuring cell for available light (continuous light measurement) Multiple field photo diode

Sensitivity range Choice of **ISO 160, ISO 320, ISO 640, ISO 1250**, automatic setting or **Pull 80** (ISO 80, limited contrast range)

Exposure modes Choice of automatic program with shift function, aperture priority, shutter speed priority, manual setting

Flash exposure control

Flash unit connection Via accessory shoe with center and control contacts or standard flash connection socket

Synchronization Flash sync speed: X = 1/125 s, or 1/500 s for lenses with central shutter, slower shutter speeds available, choice of 1st or 2nd shutter curtain; flash also possible with faster shutter speeds (1/180 s – 1/4000 s) with appropriate flash units (**HSS mode**) and SCA 3502 M5 adapter

Flash measurement cell Multiple field photo diode.

Flash exposure metering / control (with LEICA SF 58, or system compatible flash unit with SCA 3502-M5 adapter) Control with TTL pre-flash metering, computer - i.e. flash unit - controlled with automatic transfer and incorporation of sensitivity and set/controlled lens aperture, all exposure modes available, automatic adjustment of flash light component to available light

High speed mode (with LEICA SF58 or system compatible flash unit with SCA 3502-M5 adapter, Linear flash mode with TTL pre-flash metering and automatic TTL-HSS control) For flash photography with shutter speeds faster than the sync speed, e.g. 1/125 s with focal plane shutter, emission of several flashes in rapid succession approximates the effect of a constant light source, thus uniformly illuminating the entire image field during the shutter movement, automatic switching to TTL linear flash mode (with TTL-HSS flash mode on flash unit) if sync speed not reached

Strobe flash mode (multiple flashes fired during a picture) Automatic adjustment of shutter speed in **P** and **A** exposure modes and with system compatible flash units with appropriate features

Flash exposure compensation On LEICA SF 58, ± 3 EV adjustable in 1/3 EV steps.

Displays in flash mode Readiness status: Flashing or constant illumination of flash symbol in viewfinder

Adjustment of flash reflector Automatic adjustment of flash output angle to focal length used with Leica SF58 or system compatible flash units with motorized zoom reflector and SCA 3502-M5 adapter

Focusing

Focus detection Using passive phase detection method

Sensor / Metering field Central cross sensor, defined by cross hairs on ground glass screen

Modes Choice of **S**(ingle) = sharpness priority, **C**(ontinuous) = shutter release priority, **M**(anual), manual override of automatic setting possible at any time

Metering memory lock Pressing shutter release to pressure point, permanent storage with button 1.17

Drive In lenses

Displays see p. 9/33

Viewfinder system

Prism Built-in penta prism

Eyepiece High-eyepoint viewfinder. Diopter compensation of approx. ± 2 dpt. can be set on the viewfinder. Additional corrective lenses from -3 to $+1$ dpt. available.

Focusing screens Interchangeable, 3 models available: Ground glass screen with cross hairs, universal screen (ground glass screen with micro-prism ring and wedge, standard equipment), ground glass screen with grid division.

Viewfinder field Approx. 29×43 mm, corresponding to 92.4% of image area (96.7% vertical \times 95.5% horizontal).

Magnification 0.86 \times with 70 mm lens set to infinity and 0 dpt.

Displays

Viewfinder LCD line below viewfinder image, illuminated, for displays see p. 9.

Top panel Colored, self-illuminating OLED (Organic Light Emitting Diode), for displays see p. 10.

On rear panel 3" monitor (color TFT LCD) with 16x106 colors and 460,000 pixels, for displays see p. 11.

Shutter and shutter release

Shutter Selectable with main switch, in camera: Microprocessor-controlled metal blade focal plane shutter with vertical movement, in CS lenses with appropriate features: Central shutter

Shutter speeds Manual setting (in **T** and **m** modes): 8 s to $1/4000$ s in half steps ($8^{-1}/500$ s with central shutter), **B** for long-time exposures up to maximum 32 s, flash synchronization up to $1/125$ s Automatic setting (in **P** and **A** modes): continuous from 32s to $1/8000$ s ($8^{-1}/500$ s with central shutter). HSS flash possible with all faster shutter speeds than $1/125$ s (with LEICA SF58 and HSS compatible SCA 3002 standard flash units and SCA 3502 M5 adapter)

Series exposures Approx. 1.5 images/s, approx. 10 pictures in series

Shutter release Three positions: Exposure metering on – Metering memory lock – Shutter release

Self-timer Delay time either 2 or 12 s, indicated by flashing LED on front of camera and corresponding display in monitor

Pivoting mirror Translucent

Mirror pre-release Using the shutter release button, without releasing the shutter the pivoting mirror can be flipped up and the aperture of the lens used closed to the set value, shutter is released by pressing shutter release button again

Turning camera on/off With main switch on rear left of camera top panel, optional automatic switch-off after around 2/5/10 minutes

Power supply 1 lithium ion battery, rated voltage 7.4 V, capacity 2150 mAh, capacity indicated in top panel display, when shutter held open (for sensor cleaning) additional acoustic warning if capacity low.

Charger Inputs: 100-240 V AC, 50/60 Hz, automatic switching, or 12/24 V DC; Output: 4.2 V DC, 800 mA.

Camera housing

Material Die-cast magnesium all-metal body, non-slip plastic finish, top panel and base magnesium, black lacquered.

Tripod thread A $1/4$ ($1/4$ ") DIN and A $3/8$ ($3/8$ ") DIN (steel inserts) each with locking mechanism complying with DIN 4503, in tripod plate, central under lens axis

Operating conditions 0 to $+45^{\circ}\text{C}$, 15% – 80% humidity

Interfaces Standard flash connection socket, HDMI socket, stable 4pin LEMO socket for remote control accessories, stable 5pin LEMO socket for data output (USB 2.0 standard), contact strip for portrait format grip

Dimensions (Width \times Depth \times Height) Approx. $160 \times 80 \times 120$ mm

Weight Approx. 1410 g (with battery)

Scope of delivery: Battery charger S (with integrated US mains pins plus EU, UK and AUS power plugs and car charging cord), car charging cord, lithium ion battery, USB cord, carrying strap, bayonet cap, eyepiece cover

Subject to changes to design, manufacture and range.

Leica Academy

As well as outstanding high-performance products for taking, reproducing and viewing photographs, for many years we have also been offering the special services of the Leica Akademie, with practical seminars and training courses, which are intended to share our knowledge about the world of photography, projection and magnification with both beginners and advanced photographic enthusiasts.

The contents of the courses, which are run by a trained team of experts in the modern, well-equipped training suite at our Solms factory and in the nearby Gut Altenberg, vary from general photography to areas of special interest and offer a range of suggestions, information and advice for your own work.

More detailed information and the current Leica Academy brochure are available from:

Leica Camera AG
Leica Akademie
Oskar-Barnack-Str. 11
D-35606 Solms
Phone: +49 (0) 6442-208-421
Fax: +49 (0) 6442-208-425
la@leica-camera.com

Leica on the Internet

Current information about products, news, events and the Leica company is available on our homepage on the Internet at:

<http://www.leica-camera.us>
<http://www.leica-camera.co.uk>

Leica information service

The Leica information service can provide you with an answer to any technical questions relating to the Leica range either in writing, on the telephone or by e-mail.

Leica Camera AG
Informations Service
Postfach 1180
D-35599 Solms
Phone: +49 (0) 6442-208-111
Fax: +49 (0) 6442-208-339
info@leica-camera.com

Leica customer service

Leica AG's Customer Service center, or the repair service of the Leica national offices (see the Warranty Card for an address list), is available to assist you in maintaining your Leica equipment or in case of damage.

Please contact your nearest authorised Leica dealer.

Leica Camera AG
Customer Service
Solms Gewerbepark 8
D-35606 Solms
Phone: +49 (0) 6442-208-189
Fax: +49 (0) 6442-208-339
customer.service@leica-camera.com



my point of view

Leica Camera AG / Oskar-Barnack-Str. 11 / D-35606 Solms
www.leica-camera.com / info@leica-camera.com
Telefon +49 (0) 64 42-208-0 / Telefax +49 (0) 64 42-208-333

LEICA S2 – Firmware Update 1.0.0.16

Update Characteristics

Model, designation Leica S2

Update version 1.0.0.16

File name/-size FW_S2_1_0_0_16.S2 7.48 MB

Update date 2010/22/04

Download location <https://owners.leica-camera.com>

Improvements

Version 1.0.0.16

Description of Changes

1. Consistent, continuous image numbering
2. Correction of an error when using memory cards not formatted in the camera
3. Improvement of data transfer speed for computer-tethered photography
4. Simplified image review operation
5. Improved monitor image quality
6. Increased functional reliability when changing exposure modes
7. Correction of an error when using LEICA Image Shuttle software
8. Optimization of JPEG image quality
9. Additional functions:
 - 9.1. Additional white balance preset HMI
 - 9.2. Additional viewfinder information: exposure compensation
 - 9.3. Custom settings for depth of field preview button
 - 9.4. Selectable top panel standby time
 - 9.5. keylock (click wheel and shutter speed dial)
 - 9.6. Extended quick access options
10. Improved lens performance
11. Automatic detection of interchangeable focusing screen types

See appendix for detailed descriptions

Important:

When updating firmware, you should never:

- turn off the camera
- remove the battery
- remove the lens
- remove the memory card.

FAILURE TO COMPLY WITH THIS MAY LEAD TO SEVERE DAMAGE TO YOUR CAMERA!

Should the functionality of your camera be impaired following a firmware update, please contact your Leica dealer or your nearest Leica Customer Service partner.

Instructions for the installation of firmware

Step 1:

Check the version of the firmware currently installed

Leica recommends updating your camera firmware when the installed version is an earlier version than the current update.

1. Turn the camera on.
2. Press the menu control button marked “SETUP” (1.21) and select the menu item “FIRMWARE” (5.35) with the click wheel (1.18)
3. Press the click wheel. The current firmware versions for the camera and lens are displayed.
4. After firmware installation, the camera firmware version should be displayed as follows:

Camera S2

Version number 1.0.0.16

Step 2: Downloading the latest firmware

1. Download and save the file FW_S2_1_0_0_16.S2 7.48 to your computer/desktop.
2. Check the file size. Repeat the download if the size is different from the file size indicated above.

Step 3:
Copy the firmware to a CF or SD memory card

Preparing the card (formatting):

1. Format the memory card in the camera. Information on formatting memory cards can be found on page 42 of the camera instructions.

Important:

All data on memory cards, including protected files, are deleted when formatting and cannot be recovered without the use of special software.

2. Insert the formatted memory card into the appropriate card slot of your PC. Should your PC not have an appropriate slot, please use an external card reader.
3. Copy the file FW_S2_1_0_0_16.S2 into the root directory of your memory card (* 1).

Step 4:
Installing your firmware update

1. Remove the card according to the instructions for your card reader, insert the card into the camera and close the cover.
2. Press and hold the AF/AE memory button (1.17) on the back of the camera, and turn the camera on. The update procedure will begin within a few seconds. You may now release the AF/AE memory button. Update progress is displayed in graphic form on the monitor and takes about 60 seconds.
3. When installation has been successfully completed, the camera may be turned off. The new firmware is active and its version can be checked in the menu (refer to Step 1) when you turn your camera on again.

Please note:

If the battery does not have sufficient charge, you will see a corresponding warning message on the camera monitor.

(* 1) Root directory = the top level of your card's file directory

Detailed description of the changes

1. Consistent, continuous image numbering

The camera automatically numbers new images sequentially. The numbering sequence is continued when a new or formatted memory card is inserted into the camera (following on from the highest previous image number). If the memory card already contains an image with a higher number, the numbering continues from this number on. If the current folder on the card contains the image number “9999,” a new folder is created and numbering begins again from “0001”. On reaching folder number “999” with an image number of “9999,” a warning is displayed on the monitor and numbering must be reset.

RESET resets the numbering memory and the sequence begins again with “0001.”

2. Correction of an error when using memory cards not formatted in the camera

Memory cards formatted with a computer or other devices must be reformatted in the camera before they can be used. If this is not the case, a new folder will be created.

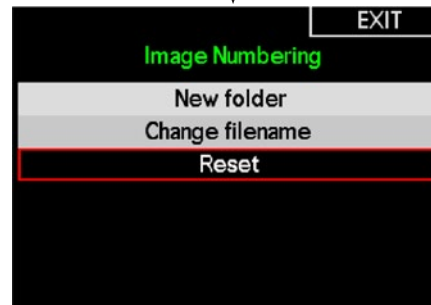
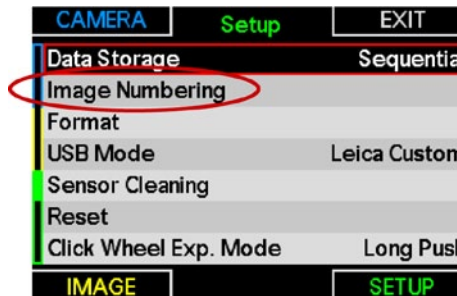

3. Improvement of data transfer speed for computer-tethered photography

The speed of the saving and transfer procedure for tethered photography has been increased.

4. Simplified image review operation

A short press of button 1.20 (upper right-hand button next to monitor) calls up normal review mode. You can begin to scroll through the images with the click wheel as soon as an image is displayed on the monitor. Press the click wheel to enter the zoom mode (enlarged image segment).

5. Improved image review quality

The image review quality in the monitor has been improved.

Normal review mode



Press the
click wheel

Zoom mode



6. Increased functional reliability when changing exposure modes

The exposure modes (program, shutter priority, aperture priority, and manual modes) can be selected by a combination of rotating the shutter speed dial and pressing the click wheel (please refer to the camera instructions, pages 38–39). The operational mode of the click wheel can be adjusted in the camera menu to prevent accidental changing of the exposure mode.

The following settings are available:

- _ Change exposure mode with a short press of the click wheel
- _ Change exposure mode with a long press of the click wheel

7. Correction of an error when using LEICA Image Shuttle software

Exposure settings (shutter speed or aperture), set in LEICA Image Shuttle software are no longer reset by pressing the shutter release button. If the shutter speed has been set in LEICA Image Shuttle, or is different from the speed on the shutter dial, it is displayed in blue on the top panel display.

As soon as the shutter speed, aperture, or other settings are altered with the camera control elements, these new settings have priority!

8. Optimization of JPEG image quality

Internal JPEG image processing has been optimized with regard to detail, sharpness, and noise characteristics.

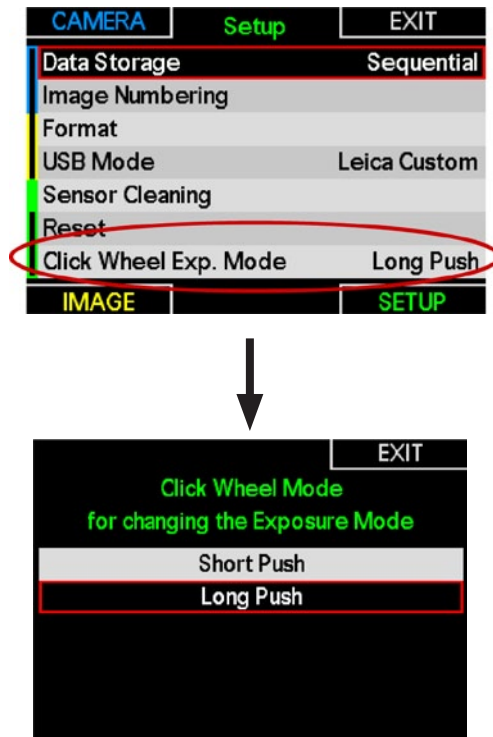

9. Additional functions

The camera now has the following additional functions:

9.1 Additional white balance preset HMI

(Hydrargym Medium Arc Length Iodide) The additional white balance preset, HMI, has been added.

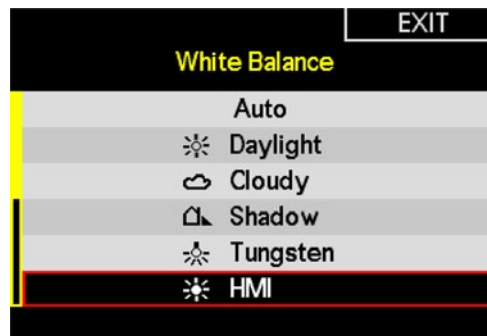

9.2 Additional viewfinder information: exposure compensation

Exposure compensation values are now indicated in the viewfinder's light balance.

Example: Exposure compensation +1.5 EV



9.3 Custom settings for depth of field preview button

For particularly fast handling, the functions of the buttons 1.21, 1.23, 1.24, and 1.3 can be customized to provide immediate access to your most important or frequently needed menu functions.

To do so, the buttons are first customized by defining which of the menus' functional groups should be called up with the quick access function. From now on, the function of the **depth of field preview button** 1.3 can also be customized as desired.

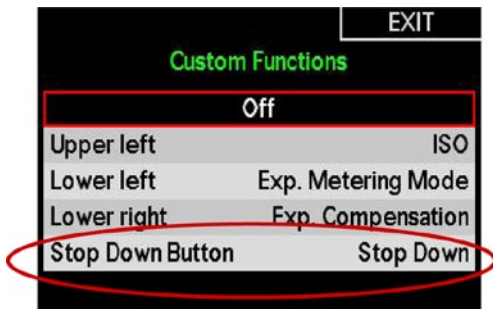

9.4 Selectable top panel standby time

The standby time of the top panel display can now be selected in the menu.

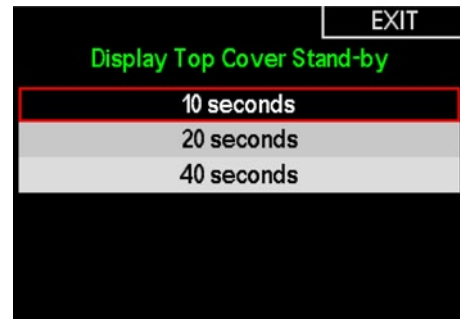
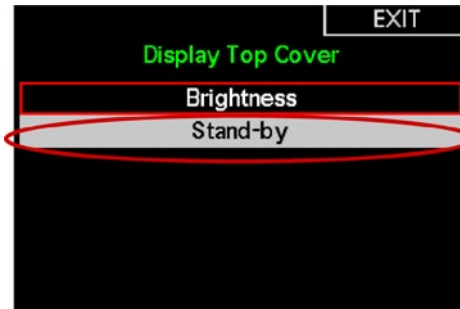

9.5 Control element lock

A new function has been implemented with which the control elements for exposure setting (shutter speed dial and click wheel) can be locked to prevent accidental changes. The control element lock can be activated and deactivated in the menu or defined as a quick access option (please refer to 9.6).

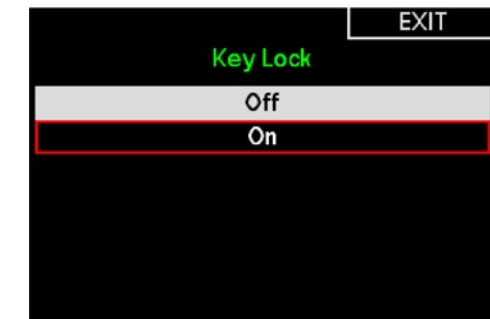
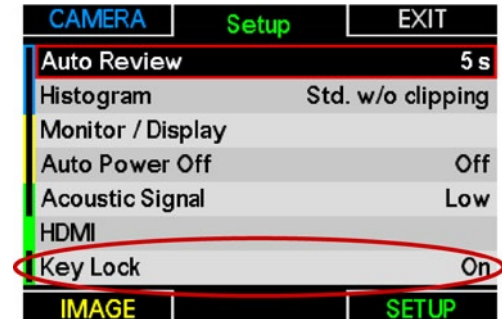

9.6 Extended custom functions

For particularly fast handling, the functions of the buttons 1.21, 1.23, 1.24, and 1.3 can be customized to provide immediate access to your most important or frequently needed menu functions.

To do so, the buttons are first customized by defining which of the menus' functional groups should be called up with the quick access function. Immediate access is activated by a long press on the respective button.

The following functions have been added to the user-defined button programming options:

- _ formatting (formatting memory cards)
- _ control element lock

10. Improved lens performance

Lens performance has been improved further.

11. Automatic detection of interchangeable focusing screen types

Interchangeable focusing screen types (e.g. ground glass with grid) are detected automatically.

More information about "interchangeable focusing screens" can be found on page 19 of the camera instructions.

LEICA S2 - Firmware Update 1.0.0.17

Update Characteristics

Model, designation Leica S2

Update version 1.0.0.17

File name/size FW_S2_1_0_0_17.S2 / 7,9 MB

Update date 2010/16/9

Download location <https://owners.leica-camera.com>

Improvements

Version FW S2 1.0.0.17

Description of Changes

Support of the new Leica lens: Leica Apo-Macro-Summarit-S 1:2,5/120mm ASPH.

Important:

When updating firmware, you should never:

- turn off the camera
- remove the battery
- remove the lens
- remove the memory card.
- attach the Leica Multifunction Handgrip S

**FAILURE TO COMPLY WITH THIS MAY LEAD TO SEVERE
DAMAGE TO YOUR CAMERA!**

Should the functionality of your camera be impaired following a firmware update, please contact your Leica dealer or your nearest Leica Customer Service partner.

LEICA S2 - Firmware Update 1.0.0.24

Update Characteristics

Model, designation Leica S2

Update version 1.0.0.24

File name/size FW_S2_1_0_0_24.S2 / 7,48 MB

Update date 2010/17/12

Download location <https://owners.leica-camera.com>

Improvements

Version FW S2 1.0.0.24

Description of Changes

1. Extending the memory card compatibility 64GB (UDMA6)
2. Lossless DNG Compression
3. Clipping Definition
4. Improvement in histogram for automatic picture preview
5. Extension of exposure time to 125s
6. Shutter speed pre-selection in BULB mode
7. Extension of setting options for AF/AE lock button
8. Optimization of AF performance – dynamic AF metering field width

See appendix for detailed descriptions

Important:

When updating firmware, you should never:

- turn off the camera
- remove the battery
- remove the lens
- remove the memory card.

**FAILURE TO COMPLY WITH THIS MAY LEAD TO SEVERE
DAMAGE TO YOUR CAMERA!**

Should the functionality of your camera be impaired following a firmware update, please contact your Leica dealer or your nearest Leica Customer Service partner.

S2 Firmware Update 1.0.0.24

Detailed description of changes

1. Extending the memory card compatibility

The memory card compatibility has been extended to 64GB (UDMA6).

2. Lossless DNG compression

DNG (digital negative) can now be compressed lossless in line with the DNG standard.

Compressed DNG has the following advantages:

- Reduction in file size from approx. 75MB → approx. 40MB (depending on image content)
- More images in a sequence; around 14 images in a sequence (depending on image content)
- Faster storage and transfer process for tethered shooting

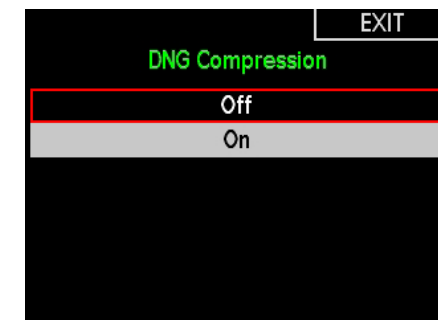
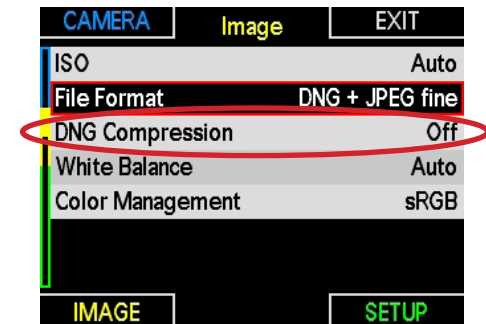

3. Clipping Definition

The light and shade warning can now be defined. This provides direct control in terms of the pre-printing stage settings

4. Improvement in histogram for automatic picture review

The histogram display for automatic picture review has been enlarged to improve legibility.

5. Extension of exposure time to 125s

Long-time exposure - the maximum exposure time has been extended from 32s to 125s.

The longest available exposure time depends in the ISO setting:

ISO pull80	→	125s
ISO 160	→	125s
ISO 320	→	60s
ISO 640	→	32s
ISO 1250	→	32s

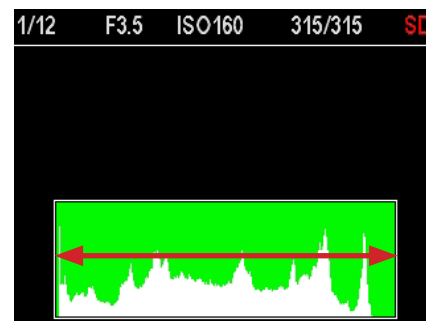
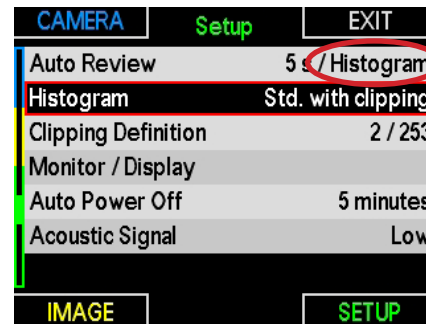
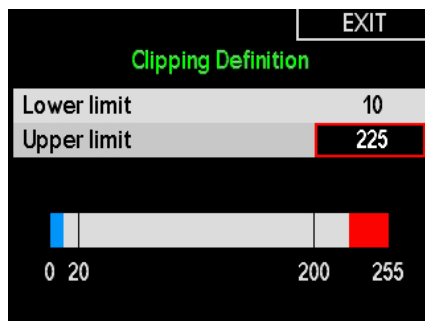
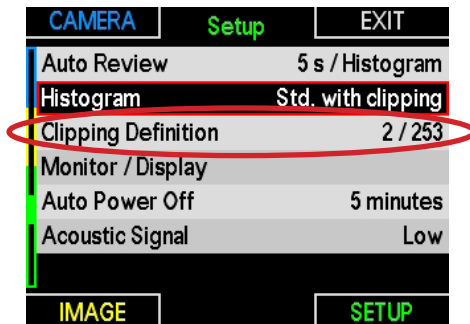

6. Shutter speed pre-selection in BULB mode

In BULB exposure mode (B), the extended menu can be called up by pressing the click wheel. The difference exposure times can be directly preselected by turning the click wheel. The click wheel has to be pressed again to confirm the selection. The set exposure time then appears in the OLED display.

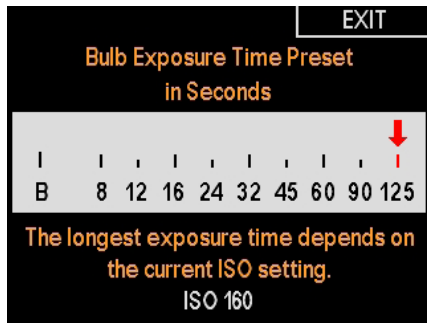

7. Extension of setting options for AF/AE lock button

The functioning of the AF/AE lock button (1.17) can now be changed.

First of all, it differentiates between autofocus (AF) and manual focus (MF).

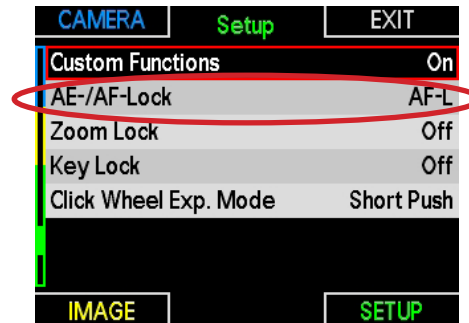

MF mode

In MF mode, the AF/AE lock button can be assigned the following functions:

- AFs on - Single autofocus
- AFs on / AE-L - Single autofocus and exposure value lock
- AFc on - Continuous autofocus
- AFc on / AE-L - Continuous autofocus and exposure value lock
- AE-L - Exposure value lock

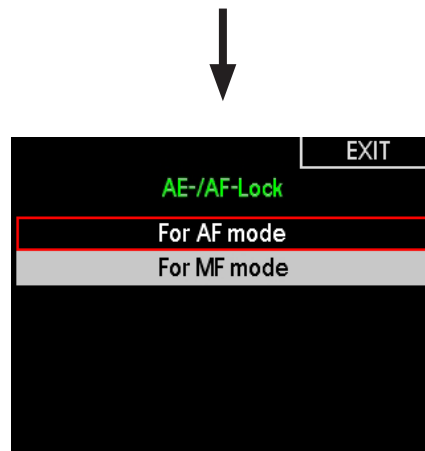

AF mode

In AF mode, the AF/AE lock button can be assigned the following functions:

- AF-L - Autofocus lock (AFs / AFc)
- AE-L - Exposure value lock
- AF-L on / AE-L - Autofocus (AFs / AFc) and exposure value lock

8. Optimization of AF performance - dynamic AF metering field width

We have been able to further increase the metering accuracy of the autofocus function. In particular, very small image details can now be focused better. The metering point is located at the center of the viewfinder cross.

LEICA S2 - Firmware Update 1.0.1.8

Update Characteristics

Model, designation Leica S2

Update version 1.0.1.8

File name/size FW_S2_1_0_1_8.S2 / 7,48 MB

Update date 2011/28/07

Download location <https://owners.leica-camera.com>

Improvements

Version FW S2 1.0.1.8

Description of Changes

1. Automatic Bracketing Function
2. Custom Function: additional button customizable

See appendix for detailed descriptions

Important:

When updating firmware, you should never:

- turn off the camera
- remove the battery
- remove the lens
- remove the memory card.
- attach the Leica Multifunction Handgrip S

**FAILURE TO COMPLY WITH THIS MAY LEAD TO SEVERE
DAMAGE TO YOUR CAMERA!**

**Should the functionality of your camera be impaired
following a firmware update, please contact your Leica
dealer or your nearest Leica Customer Service partner.**

Detailed description of changes

1. Automatic Bracketing Function

now you can choose whether you make all bracketing exposures by pressing the shutter release button only once or the traditional way by taking picture by picture. This feature is very helpful if you use the pictures for HDR processing afterwards.

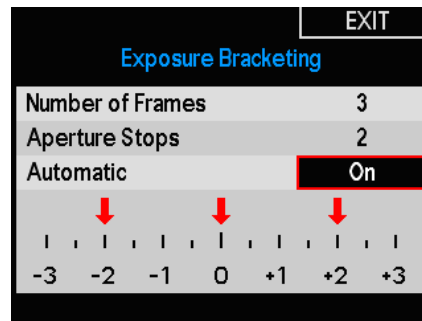

2. Custom Functions

Now an additional button (upper right side) is ready to custom function. This features a quick access to settings and gives the photographers the opportunity to customize the Leica S2 to their needs and demands.

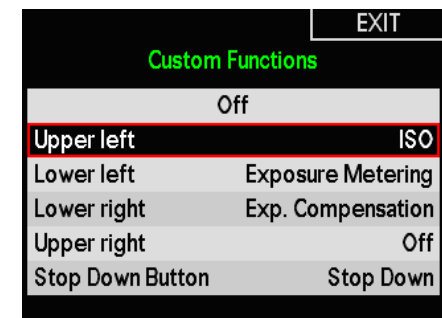

LEICA S2 - Firmware Update 1.0.2.0

Update Characteristics

Model, designation Leica S2

Update version 1.0.2.0

File name/size FW_S2_1_0_2_0.S2 / 7,9 MB

Update date 2011/20/12

Download location <https://owners.leica-camera.com>

Improvements

Version FW S2 1.0.2.0

Description of Changes

Support of the new Leica lens: LEICA ELMARIT-S 2.8/30mm ASPH.

Important:

When updating firmware, you should never:

- turn off the camera
- remove the battery
- remove the lens
- remove the memory card.
- attach the Leica Multifunction Handgrip S

**FAILURE TO COMPLY WITH THIS MAY LEAD TO SEVERE
DAMAGE TO YOUR CAMERA!**

Should the functionality of your camera be impaired following a firmware update, please contact your Leica dealer or your nearest Leica Customer Service partner.

LEICA S2 - Firmware Update 1.0.3.3

Update Characteristics

Model, designation Leica S2

Update version 1.0.3.3

File name/size FW_S2_1_0_3_3.S2 / 7.5 MB

Update date 2012/10/5

Download location <https://owners.leica-camera.com>

Improvements

Version FW S2 1.0.3.3

Description of Changes

- Support of the new Hasselblad lens adapter Leica S-Adapter H –full functionality (order no. 16030)
- Improvement of flash synchronization with $\frac{1}{125}$ s focal plane shutter

Important:

When updating firmware, you should never:

- turn off the camera
- remove the battery
- remove the lens
- remove the memory card.
- attach the Leica Multifunction Handgrip S

**FAILURE TO COMPLY WITH THIS MAY LEAD TO SEVERE
DAMAGE TO YOUR CAMERA!**

Should the functionality of your camera be impaired following a firmware update, please contact your Leica dealer or your nearest Leica Customer Service partner.