

OLYMPUS OM-G, OM-20

Similar models: OM-10 (OM-1 and OM-2 are mechanically similar)

Batteries: 2 each S-76
(positive ground)

Fig. 1—top cover removed

Fig. 2—bottom cover removed

Fig. 3—top view, wind side

Fig. 4—top view, rewind side

Fig. 5—front view, mirror box removed

Fig. 6—auto board

Fig. 7—mirror box, wind side

Fig. 8—mirror box, rewind side

Fig. 9—front-plate assembly, front view with f-value ring removed

Fig. 10—mirror box removed from front plate, wind side

Fig. 11—camera body, top view with flex circuit removed

Fig. 12—shutter block, front view

Fig. 13—shutter block, back view (charged)

Fig. 14—test circuit for flash changeover

Fig. 15—pictorial, flex circuit

Fig. 16—pictorial, auto board

Fig. 17—schematic

ADJUSTMENT LOCATIONS:

LED readout, low light
LED readout, high light
Auto speeds
MD switch
Mirror lock-up voltage

A
B
C
D
E*

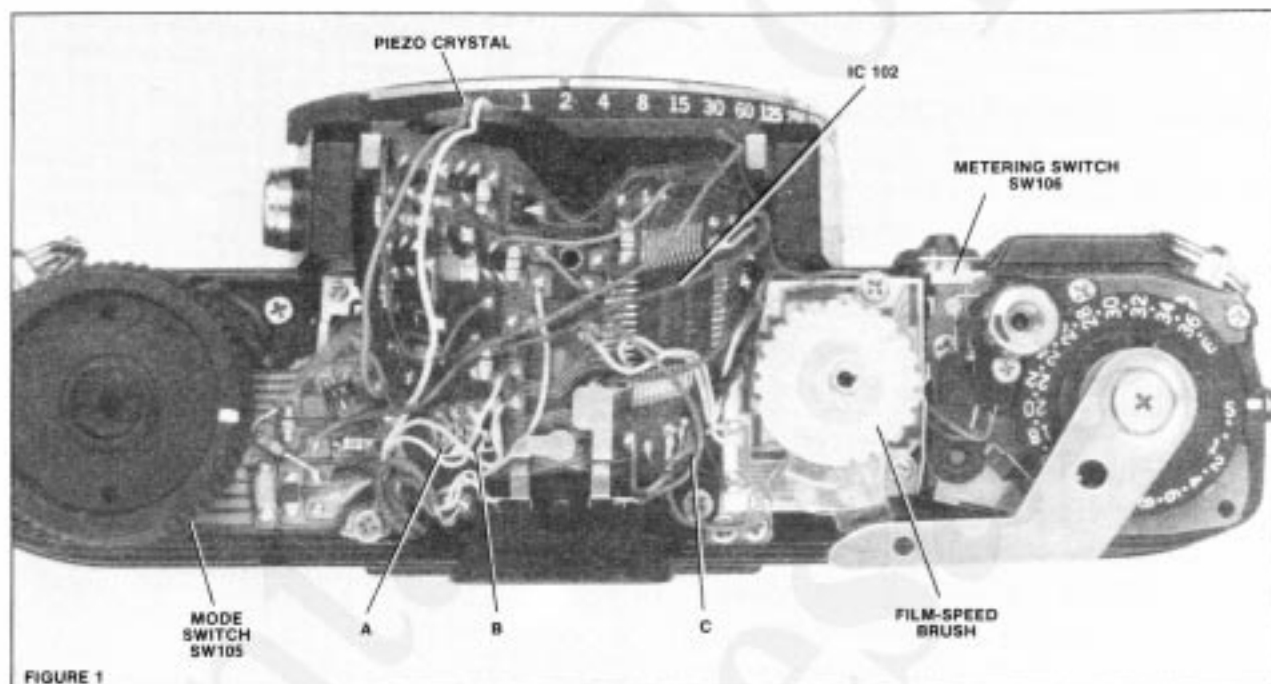

FIGURE 1

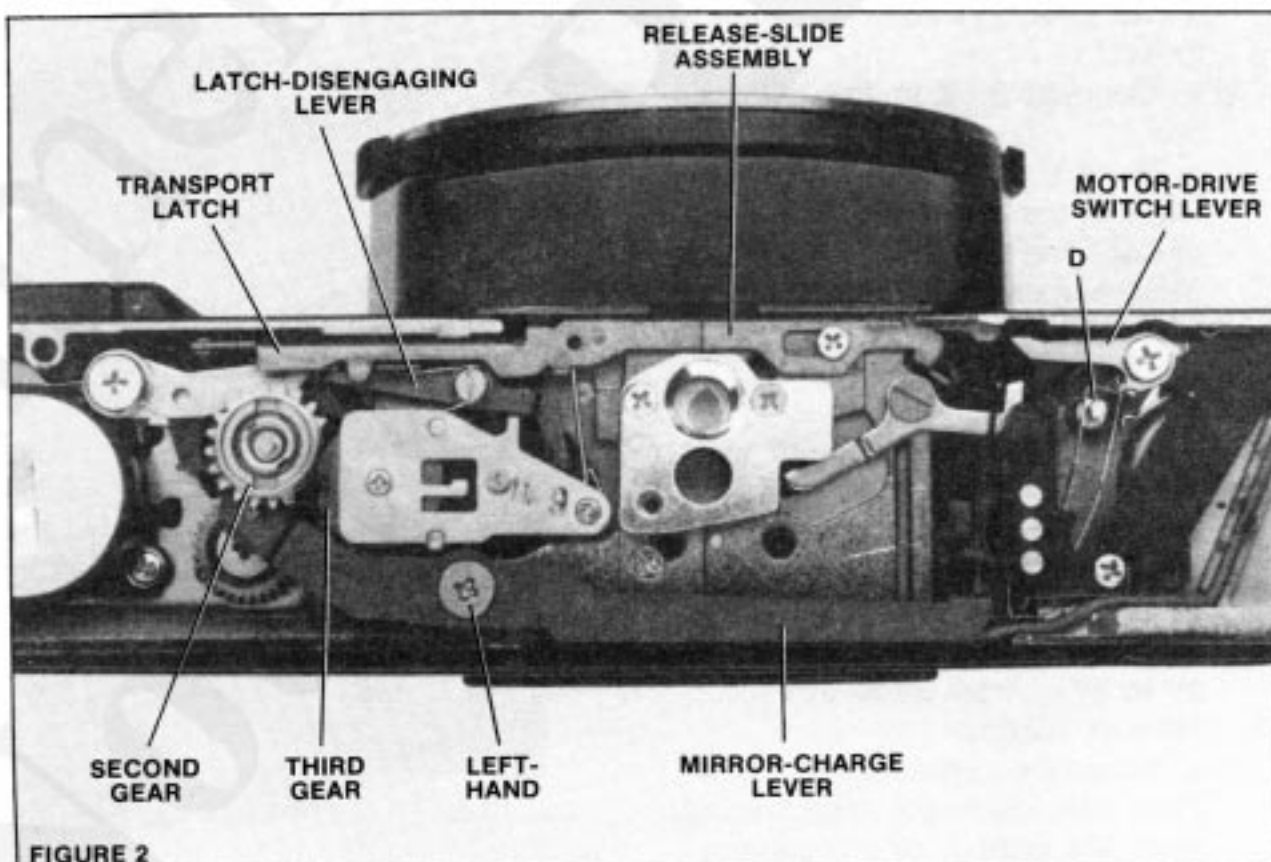

FIGURE 2

Offset F*
Travel time, first curtain G**
Travel time, second curtain H**
Trigger switch (fast speeds) I*
Mechanical speed J*
Fine position, first curtain K
Fine position, second curtain L
*reach after removing cover plate over auto board (bottom of mirror box)
**travel-time adjustments can be made either from the top or the bottom of the camera

ADJUSTMENT VALUE:

Curtain-travel time: 11.5ms (32mm distance)
Flange-focal distance: 46.2 + 0, - 0.2mm (flange to pressure-plate rails)
Mirror lock-up voltage: 1.95 — 2.10V (with a lower applied voltage, the mirror should lock up)
Battery-test voltage: 1.95 — 2.12V (with a lower applied voltage, the battery-test LED should not turn on)

K-factor: 1.3

Flash changeover: With 60 — 150 microamps applied between the green-wire hot-shoe contact (negative) and ground, Fig. 14, the flash LED at the top of the display should turn on. At auto, the shutter should deliver the flash speed (around 24ms).

Mini speed: 0.7 — 2.0ms (lens removed, auto, high light level)

ADJUSTMENT PROCEDURES:

1. Lock Voltage.
 - a. Turn the wiper of resistor E, Fig. 6, counterwise to the end of the resistance band.
 - b. apply 2.05V to the battery box.
 - c. Cock and release the shutter. The mirror should lock up.
 - d. Turn the wiper of resistor E clockwise until the mirror releases.
 - e. Check by setting the power supply to 2V. The mirror should lock up. When you increase the applied voltage to 2.10V, the mirror should release.
2. Offset.
 - a. Connect 3.1V to the battery box.
 - b. Short together the two black wires of the main switch.
 - c. Cock the shutter. Short across the two black wires of the auto film-speed resistor at the film-speed circuit board, Fig. 4.
 - e. Measure between ground and the black wire of the shutter magnet (at the auto board, Fig. 16). You should measure either 0V or 3V. Adjust resistor F until the voltage just switches (from 0V to 3V or from 3V to 0V).
3. Manual Speeds.
 - a. Adjust the curtain-travel times (you can reach the adjustments from the bottom of the camera after removing the motor-drive switch assembly).
 - b. Adjust 1/1000 with the trigger switch. Either turn the eccentric of the trigger-switch lever or bend the trigger switch.
 - c. Check the other manual speeds.
4. Auto Exposure.

Note: When checking auto exposures, hold down the film-speed brush assembly. If the film-speed brush lifts from the film-speed resistor, the shutter will hang open at auto.

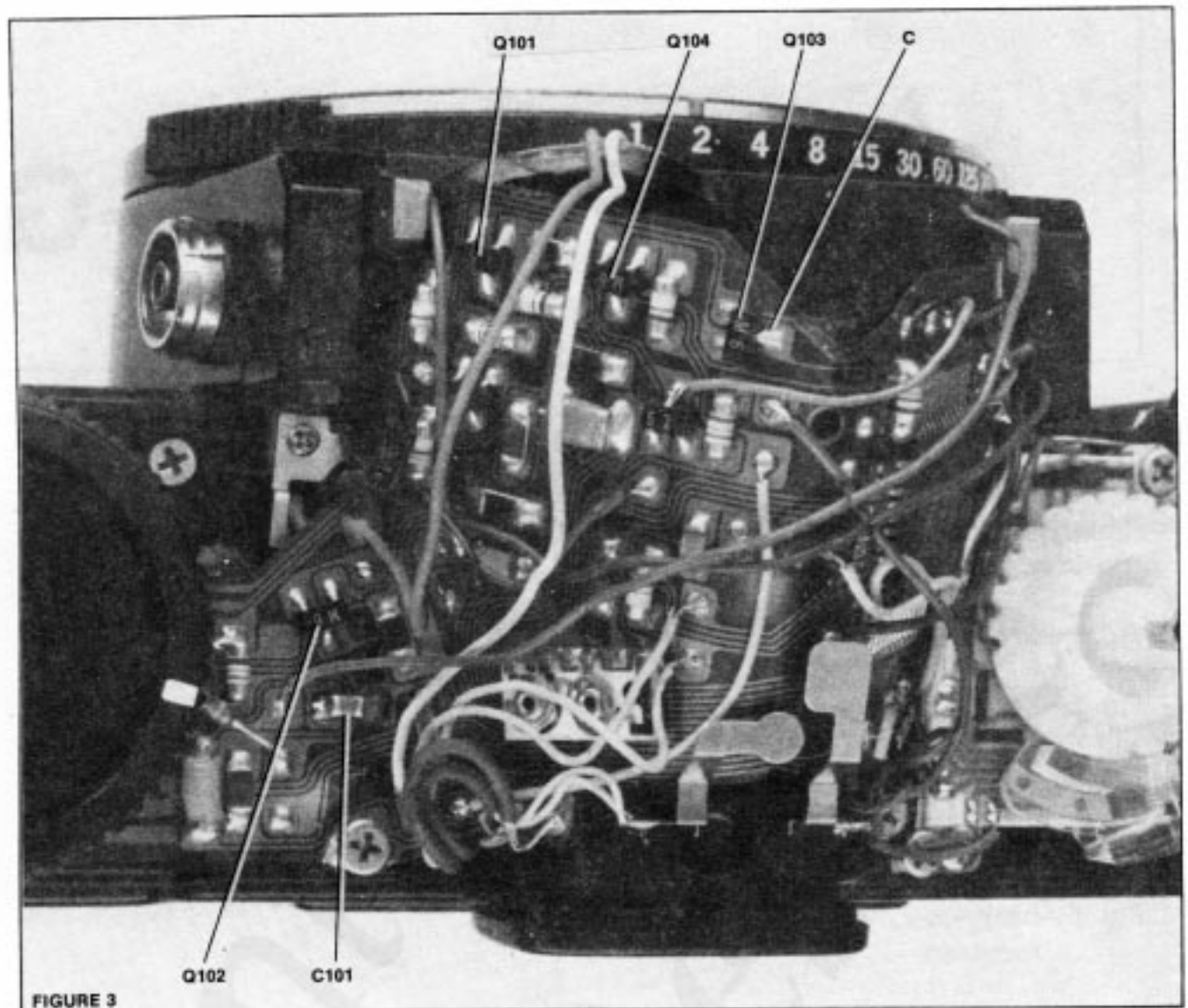
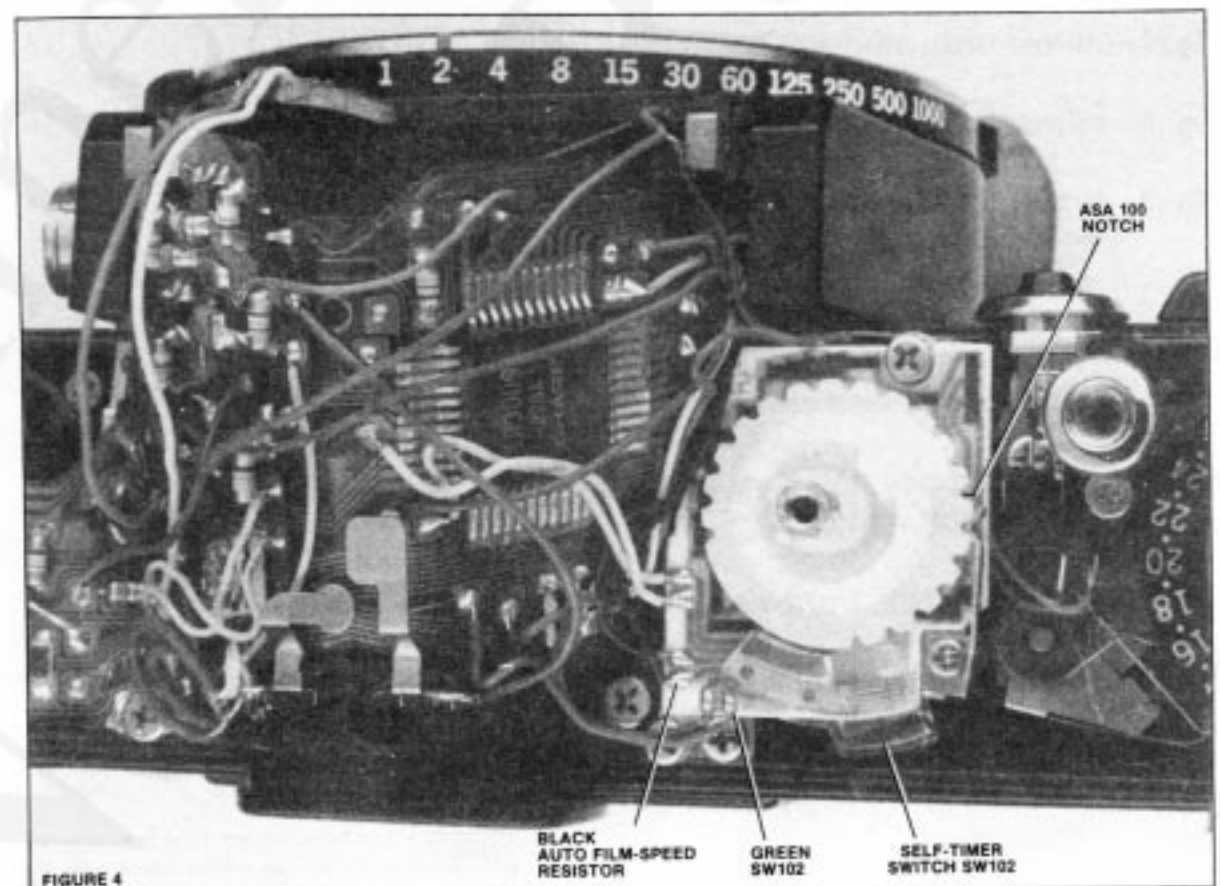

FIGURE 3



a. Set ASA 100 (the film-speed detent in the ASA 100 notch, Fig. 4).

b. Adjust resistor C at EV 11 or EV 12 for a 0 EV error.

Note: The front surface of the probe should be 18% neutral gray to simulate the film.

5. Meter Readout.

a. Adjust resistor B at a high light level for the proper shutter-speed reading. Olympus

recommends setting ASA 200, f/5.6, and BV 14. Adjust for a reading of 1000.

b. Adjust resistor A at a low light level for the proper shutter-speed reading. Olympus recommends setting ASA 200, f/5.6, and BV 8. Adjust for a reading of 15.

c. Work back and forth between the two adjustments until the readings are correct at all light levels.

1. With the shutter block removed, Fig. 12, you can time the curtains — lift the winding rollers to disengage them from the winding gears.
2. Check the timing of the second curtain with the shutter held open. Cock the shutter by rotating the first-curtain winding roller, Fig. 12. Then hold the armature of the shutter magnet against the magnet core and disengage the release lever, Fig. 12. The edge of the second-curtain bar should align with the vertical edge of the aperture mask, Fig. 13.
3. Check the timing of the first curtain with both curtains in the cocked position, Fig. 13. The first-curtain bar should nearly overlap the second-curtain bar. The distance from the lead edge of the first-curtain bar should be 0.05 — 0.4mm from the curtain-side edge of the second curtain bar as shown in Fig. 13. To adjust, lift the first-curtain winding roller away from the curtain gears. Then rotate the winding roller to change the gear timing.
4. The adjustment bars on the winding rollers, Fig. 12, allow for fine adjustments on the curtain positions. Make the rough adjustments with the gear timing. Then make the fine adjustments by loosening the screws and sliding the adjustment bars.

OPERATING INSTRUCTIONS:

1. The LED display turns on and remains on for around 90 seconds when you depress the release button part way — unless the mode switch is in the off position. With the mode switch in the off position, the LED display won't turn on. But the camera still delivers auto operation (auto shutter speeds).
2. With the mode switch in the manual position, the manual LED turns on in the finder display. The camera then delivers the shutter speed selected on the shutter-speed ring.
3. At the self-timer setting, the mirror moves around 1/3 the way up and then locks for the self-timer delay of around 12 seconds. The piezo beeps and

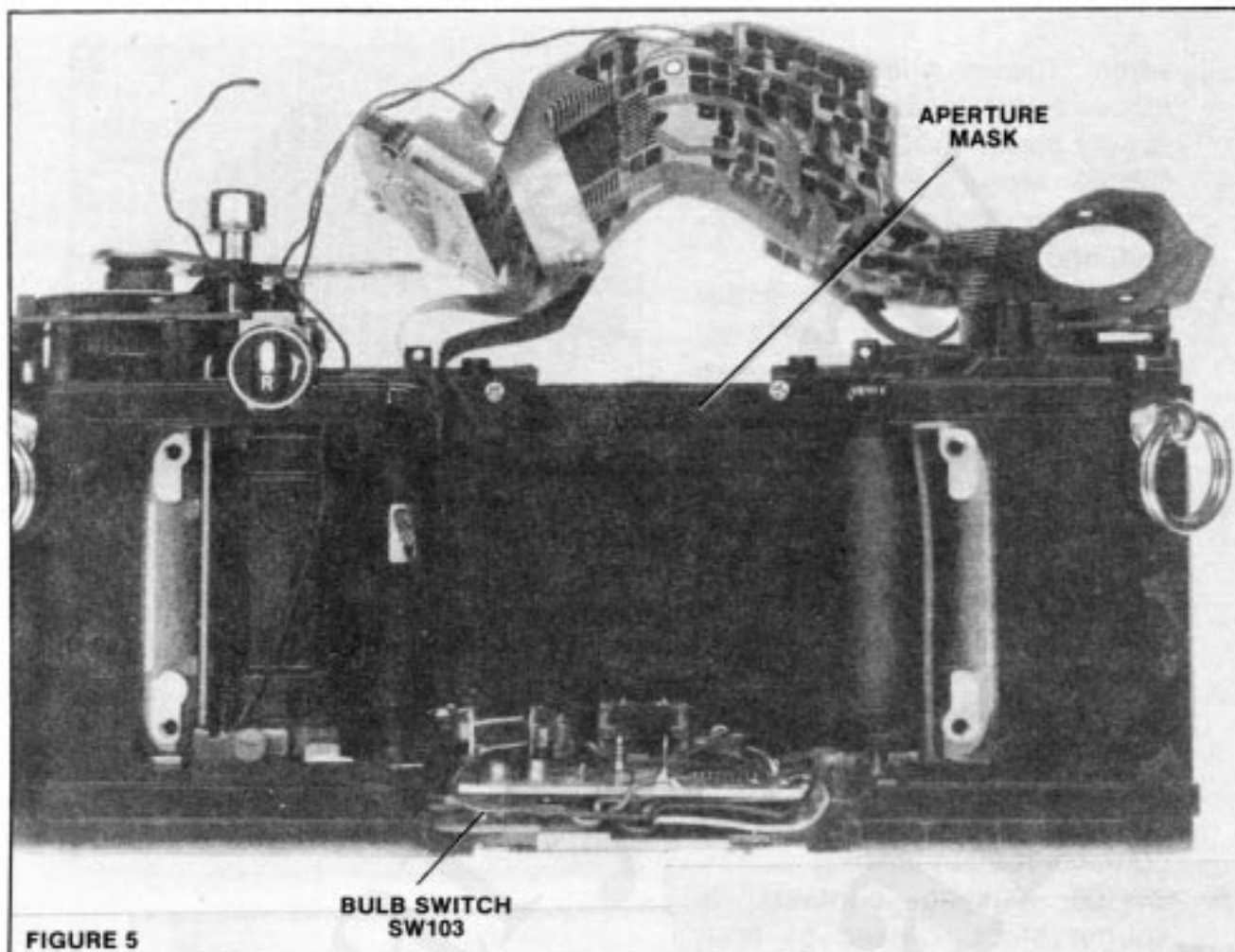

FIGURE 5

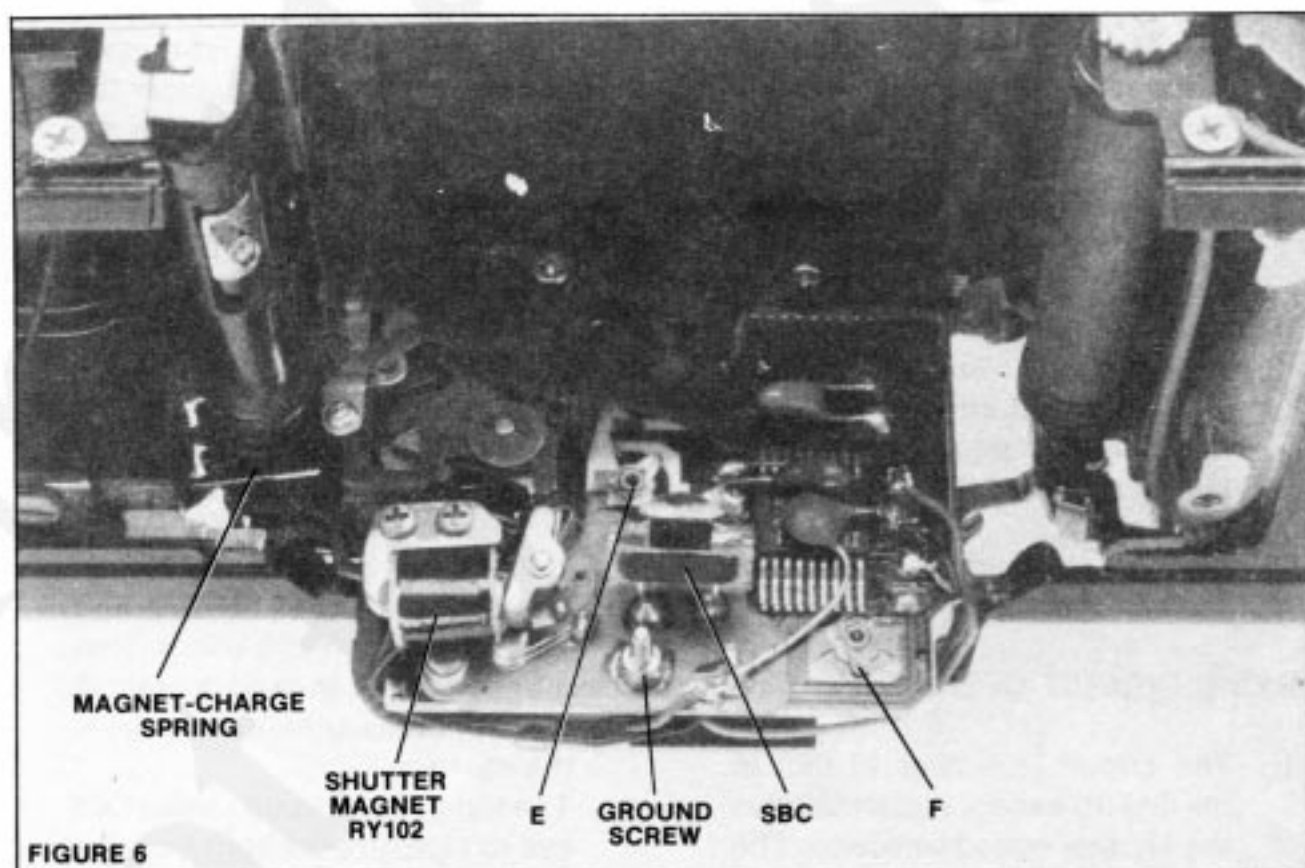

FIGURE 6

- the front LED flickers during the delay.
4. At the batter-test setting with good batteries, the piezo emits a steady tone and the front LED glows steadily.
 5. Turning the film-speed knob to a compensation setting lights the plus/minus LED in the finder display.
 6. Without batteries or with low batteries, the mirror locks up. The mirror releases when you install batteries.

SWITCH LOCATIONS AND FUNCTIONS:

1. SW101. Trigger switch on auto board, Fig. 16. Closed with shutter cocked, opens when first curtain starts to run to begin exposure-measuring time.
2. SW102. Self-timer switch on film-speed board, Fig. 4 (between two green wires). Closes at the self-timer setting.
3. SW103. Bulb switch under auto board, Fig. 5 (orange and red wires). Closes with the release button depressed to prevent the timing capacitor C101 from charging on the bulb function.
4. SW104. Main switch on rewind side of mirror box (two black

- wires). Closes when the mirror moves to the locked position to supply power to IC101.
5. SW105. Mode switch at rewind end of flex. Selects auto, battery-test, and manual functions.
 6. SW106. Metering switch under release button (red and gray wires). Closes when you push the release button part way to supply power to IC102 and turn on the LED display.
 7. SW107. Safety switch for X-sync contacts at bottom of shutter block (black and white wires). Closes when the mirror rises to connect the X-sync contacts to the hot-shoe sync terminal. Opens with the shutter released and the mirror down to break contact (because the X-sync contacts remain closed).
 8. SW108. X-sync contacts in shutter block. Closed by first-curtain brake.
 9. SW109. Safety switch on rewind side of mirror box. Closed as the mirror rises to connect the PC terminal to the hot-shoe sync contact. Opens with the mirror down to break the connection to the PC terminal and prevent electrical shock.
 10. SW110. Exposure-compensation switch in top cover. Closes when the film-speed knob is set to an exposure-compensation setting to turn on the plus/minus LED in the display.
 11. SW111. Motor-drive switch at bottom of camera.

BASIC CIRCUIT OPERATION:

1. The circuit is similar to that in the OM-10 except that it includes the manual-speed selection. The circuit for the auto-speed control (auto board at bottom of mirror box) and the circuit for the LED indication (flex at top of mirror box) are separate. A malfunction in one circuit normally doesn't affect the other circuit. If neither circuit works (no LED indication and mirror locks up), check for battery voltage at the black wire (wind side of flex).
2. The two circuits use separate film-speed resistors (separate brushes on the film-speed brush assembly) and separate photocells. The f-value (diaphragm) resistor serves only for the indication circuit.

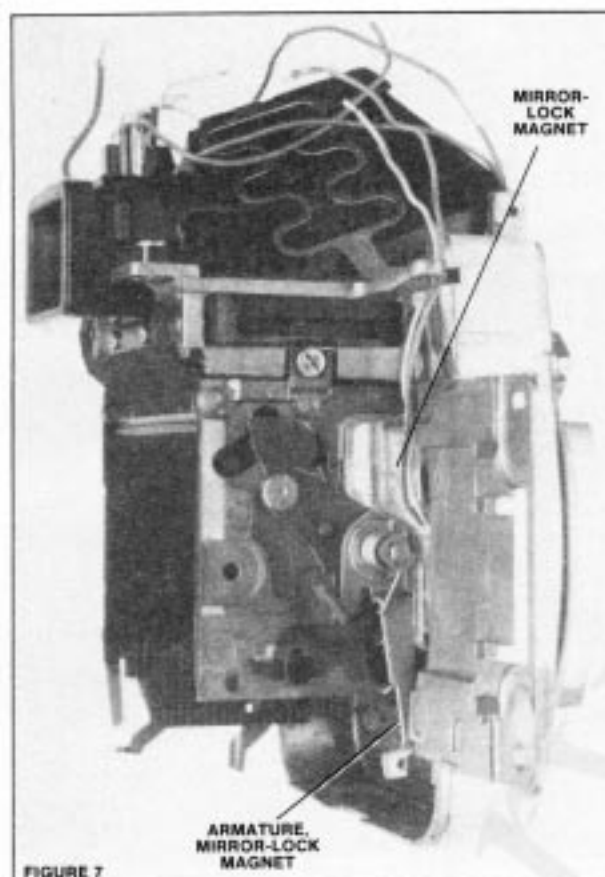

FIGURE 7

3. The auto-speeds circuit uses a silicon photodiode to measure the light from the first-curtain pattern (fast speeds) or from the film (slow speeds). IC101 on the auto board (same IC as in OM-10) provides the calculation for the auto speeds. IC101 receives power when the mirror rises part way and closes the main switch.
4. When the mirror rises far enough to close the main switch, it's locked by the mirror-lock magnet on the mirror box. IC101 now decides if the battery voltage is sufficient for proper operation. If so, IC101 provides current through the mirror-lock magnet. The mirror-lock magnet then repels its armature and frees the mirror.
5. The indication circuit uses a CdS cell to measure the light from the focusing screen. IC102 provides the calculation and the driver for the display LEDs. Pushing the release button part way closes the metering switch to turn on IC102.
6. IC101 controls the shutter speeds both for auto and manual. Manual speeds are controlled by the charge time of capacitor C101 through the shutter-speed resistor RV109. C101 is not used for the auto speeds.

DISASSEMBLY HIGHLIGHTS:

Settings for disassembly: unimportant

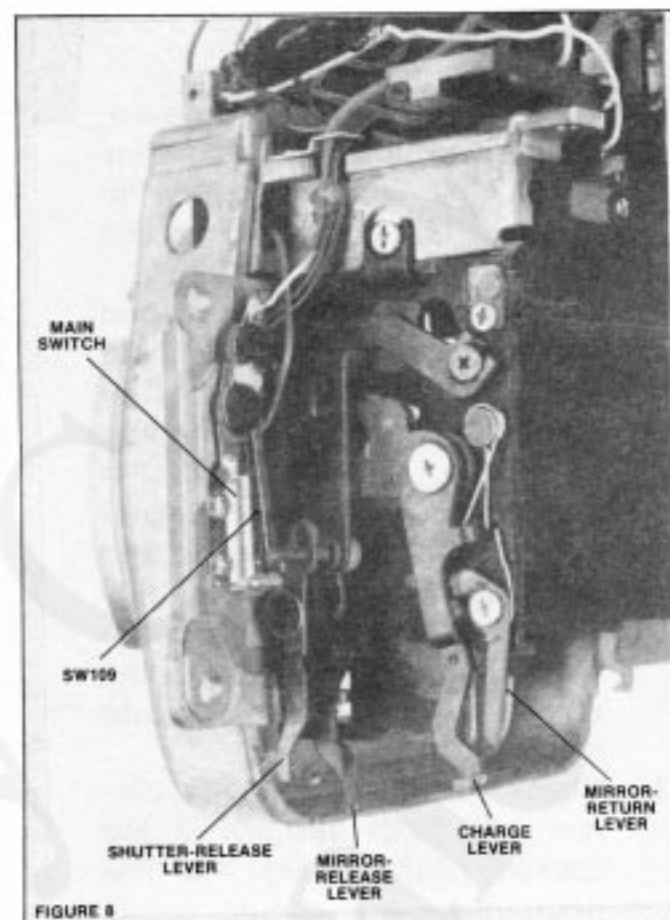

FIGURE 8

Locations of left-hand threads: screw holding mirror-charge lever, screw holding charge-cam assembly (second gear), Fig. 2

Sequence:

1. bottom cover (longer screw goes to center)
2. top cover —
 - a. remove wind-lever cover (1 screw, underside)
 - b. remove wind lever (1 screw)
 - c. remove rewind knob (center screw, top)
 - d. remove mode switch (retaining ring)
 - e. remove disc at top of film-speed knob (snap fit)
 - f. remove film-speed knob (1 screw — spring loose)
 - g. remove 6 top-cover screws (smaller screws go at sides of pentaprism)
 - h. lift aside top cover (back-latch spring loose)
3. lift off plastic insulator above flex
4. unsolder black and orange wires from flex (the wires to the exposure-compensation switch)
5. remove cover plate over auto board, bottom of mirror box (1 screw)

Note: To reach the screw, hold open the shutter on bulb. You can then reach the screw through the back of the focal-plane aperture.

6. unsolder wires from flex —
 - 2 black (main switch)

- 2 pink (CdS)
 - white and red (piezo beeper)
 - green from hot-shoe sync contact or from flex
 - blue and orange (mirror-lock magnet)
 - 2 purple (diaphragm resistor)
 - white (LED)
 - green (shutter-speed resistor)
7. unsolder 2 shielded leads (blue insulation) — white wires from hot-shoe contact, bare wires from flex)
 8. remove palm grip, front of camera on wind side
 9. remove right and left front leather
 10. lift aside film-speed assembly taking out 2 screws
 11. remove 3 screws holding rewind side of flex (2 short screws from mode-switch board, long ground screw)
 12. lift out rewind-shaft assembly
 13. remove screw and clip holding LED display
- Note: With the rewind side of the flex now free, you can lay the flex upside down. You can then reach the clip that holds the LED display (wind side of prism).
14. slide LED display out of focusing-screen slot
 15. remove upper mirror-box screw (wind side of eyepiece)
 16. free wires from wire clip (front of camera, wind side)
 17. remove 4 front-plate screws
 18. remove front-plate/mirror-box assembly

Reassembly highlights:

1. When you replace the mirror box, the armature of the mirror-lock magnet must hook to the back of the magnet-charge spring, Fig. 6 and Fig. 7. First charge the mirror-lock magnet by pulling the lower end of the armature toward the back of the mirror-lock magnet by pulling the lower end of the armature toward the back of the mirror box. Pull the magnet-charge spring toward the front of the camera. Seat the lower end of the mirror box first, making sure the lever on the rewind side passes through the cutout in the bottom of the body casting. Make sure that the lower end of the armature hooks behind the magnet-charge spring and seat the mirror box.
2. Replace the mirror-box and

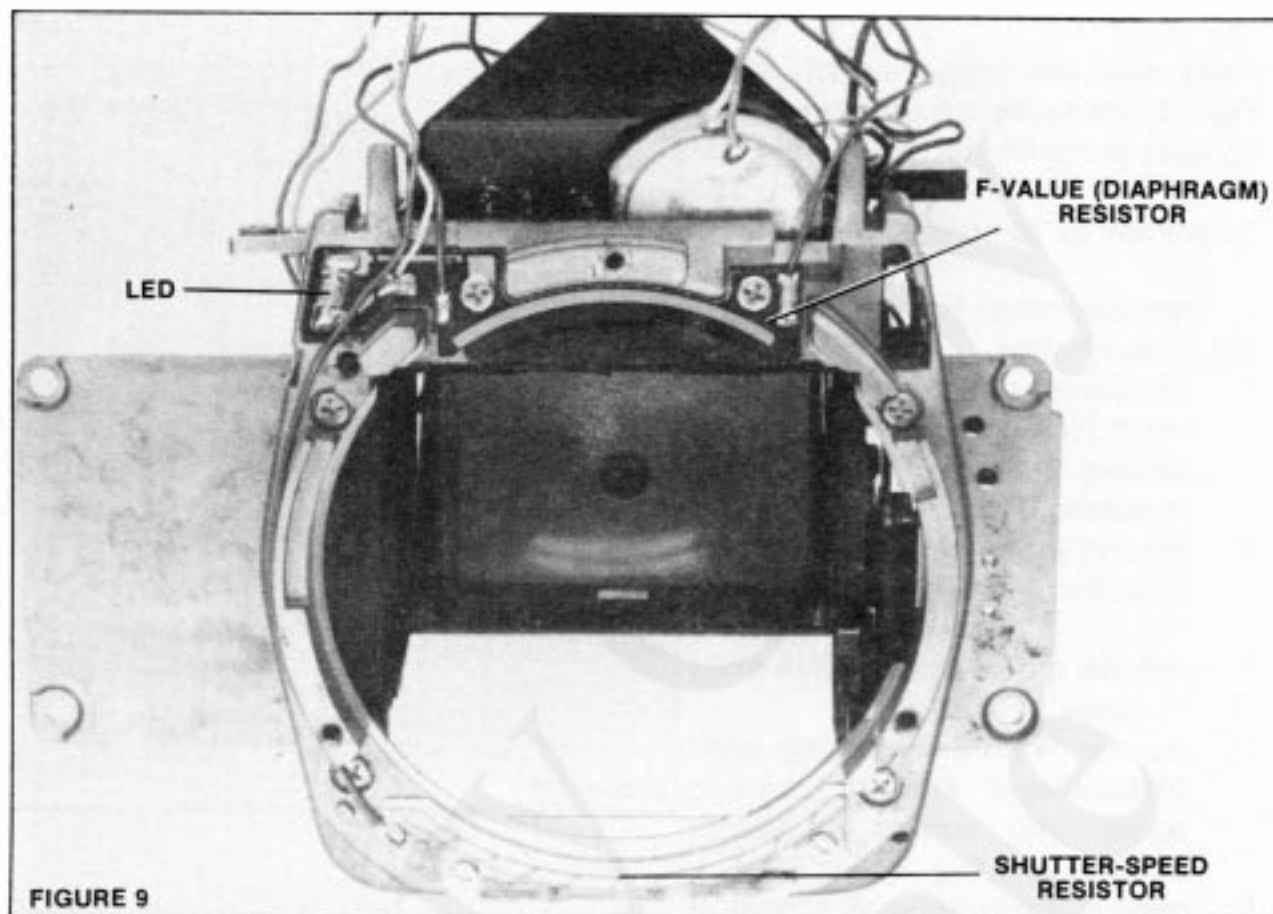

FIGURE 9

front-plate screws. Check by cocking the shutter and pushing the release button — the mirror should move to the lock-up position. Release the mirror with a power supply or one of the camera's batteries — touch the blue wire to the negative side of the battery and touch the orange wire to the positive side. The mirror should complete its travel and release the shutter.

3. To replace the film-speed knob, first rotate the film-speed brush fully clockwise until its stop tab is against the stop lug on the top cover (ASA 1600 position). Next seat the film-speed knob; the square lug on the underside of the film-speed knob should be against the clockwise end of the raised tab of the film-speed brush. Seat the film-speed calibration plate (there's only one position at which you can install the film-speed calibration plate — one tab is larger than the other three). Replace the coil spring (smaller diameter coils go up) and the screw. Rotate the film-speed knob until the plus/minus LED in the finder turns out. Then align the index on the cover disc with the top-cover index.

Sequence to remove flex circuit:

1. remove mirror box
2. unsolder black, gray, orange, and red wires from auto board,

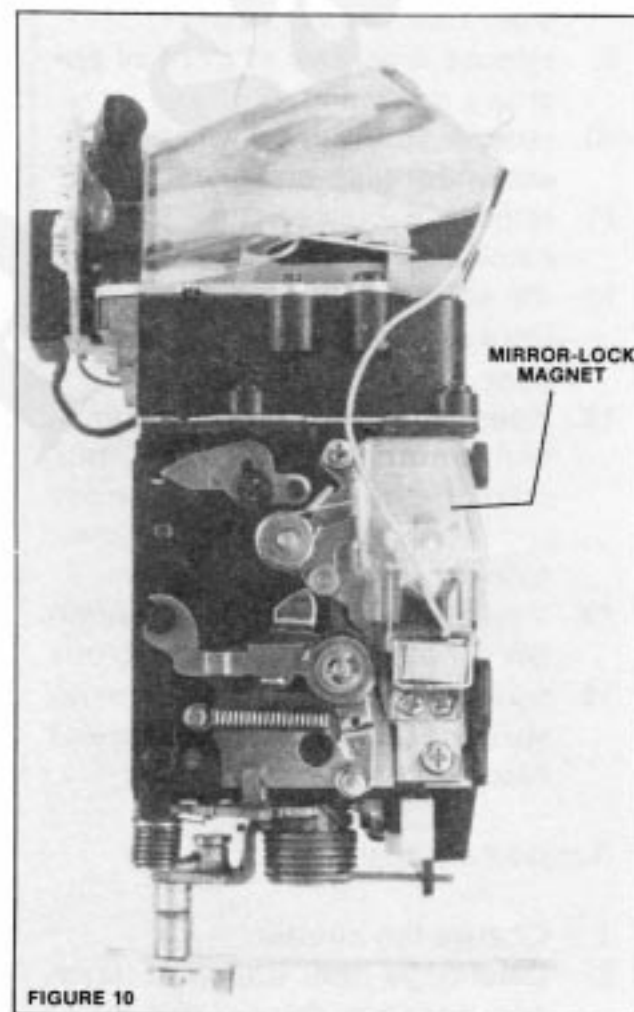

FIGURE 10

Fig. 16

3. unsolder red and gray metering-switch wires from flex
4. unsolder black battery-box wire from flex
5. unscrew auto-board ground screw
6. free connecting strip of flex from double-sided tape on aperture mask
7. lift out complete flex circuit

Reassembly highlights:

When you replace the auto board,

make sure the trigger-switch lever, Fig. 11, fits to the left of the movable contact of the trigger switch, Fig. 16.

Sequence to remove shutter block:

1. remove mirror box and flex
2. cock shutter
3. remove mirror-charge lever (left-hand screw), Fig. 2
4. remove release-slide assembly (1 screw), Fig. 2
5. remove motor-drive switch lever (1 screw — washer under lever), Fig. 2
6. remove motor-drive switch plate (1 screw), Fig. 2
7. remove latch-disengaging lever (disconnect spring, remove screw with spring — washer under lever), Fig. 2
8. remove 2 countersunk screws at top of shutter block (1 on wind side, 1 on rewind side)
9. remove 3 screws at front of aperture mask, Fig. 5
10. remove screw at bottom of camera under take-up rollers
11. remove 3 countersunk shutter-block screws, bottom of camera
12. lift shutter block slightly until third gear separates from second gear
13. disengage transport latch, Fig. 2, and advance wind lever until mirror-charge cam (under second gear) clears shutter block
14. unsolder white wire from switch SW107 at bottom of shutter block
15. hold aside magnet-charge spring, Fig. 6, and lift out shutter block, Fig.

Reassembly highlights:

1. Charge the shutter
2. Disengage the transport latch and advance the wind lever to turn the second gear around 1/4 turn (until the mirror-charge cam clears the cutout at the bottom of the body casting).
3. Hold aside the magnet-charge spring and install the shutter block from the top of the camera.
4. Lift the shutter block slightly so that the third gear (on shutter block) disengages from the second gear (in camera body).
5. Advance the wind lever to turn the second gear to its latched position.
6. Seat the shutter block fully and replace the screws. Make sure the shutter-release lever at the

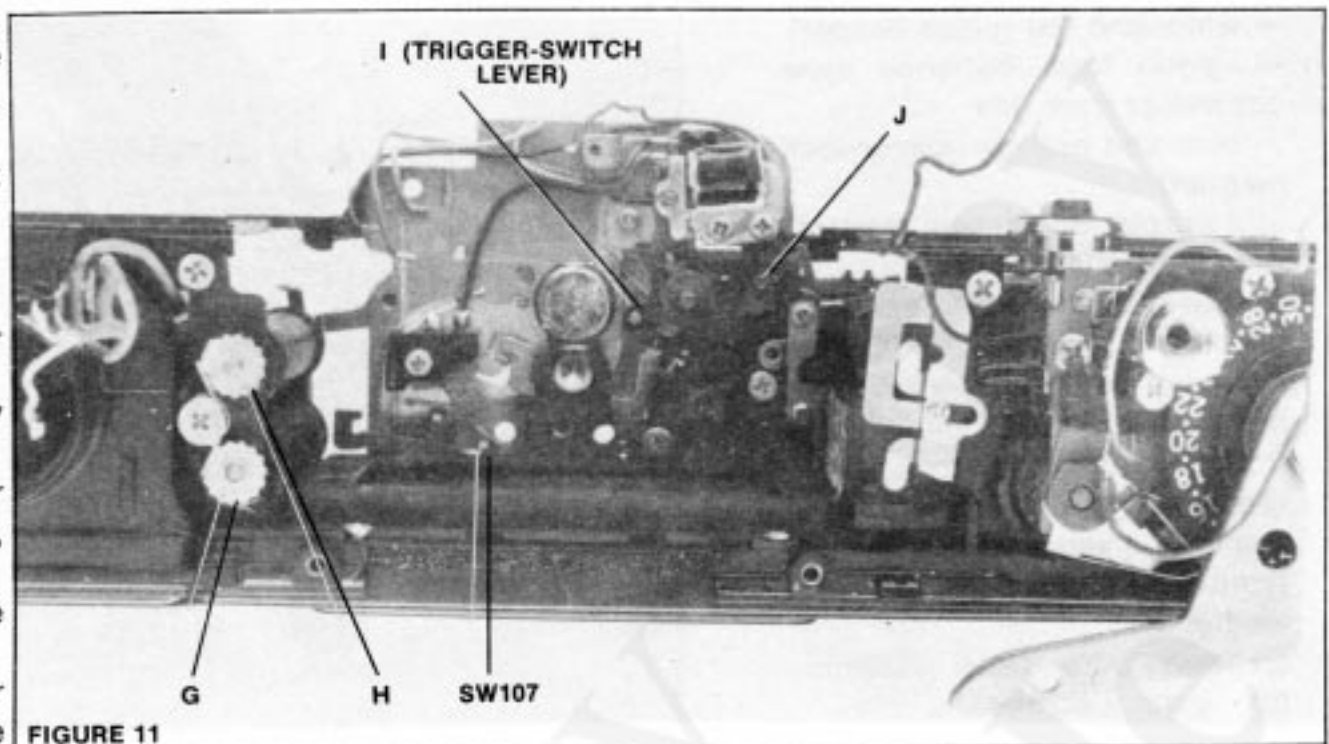

FIGURE 11

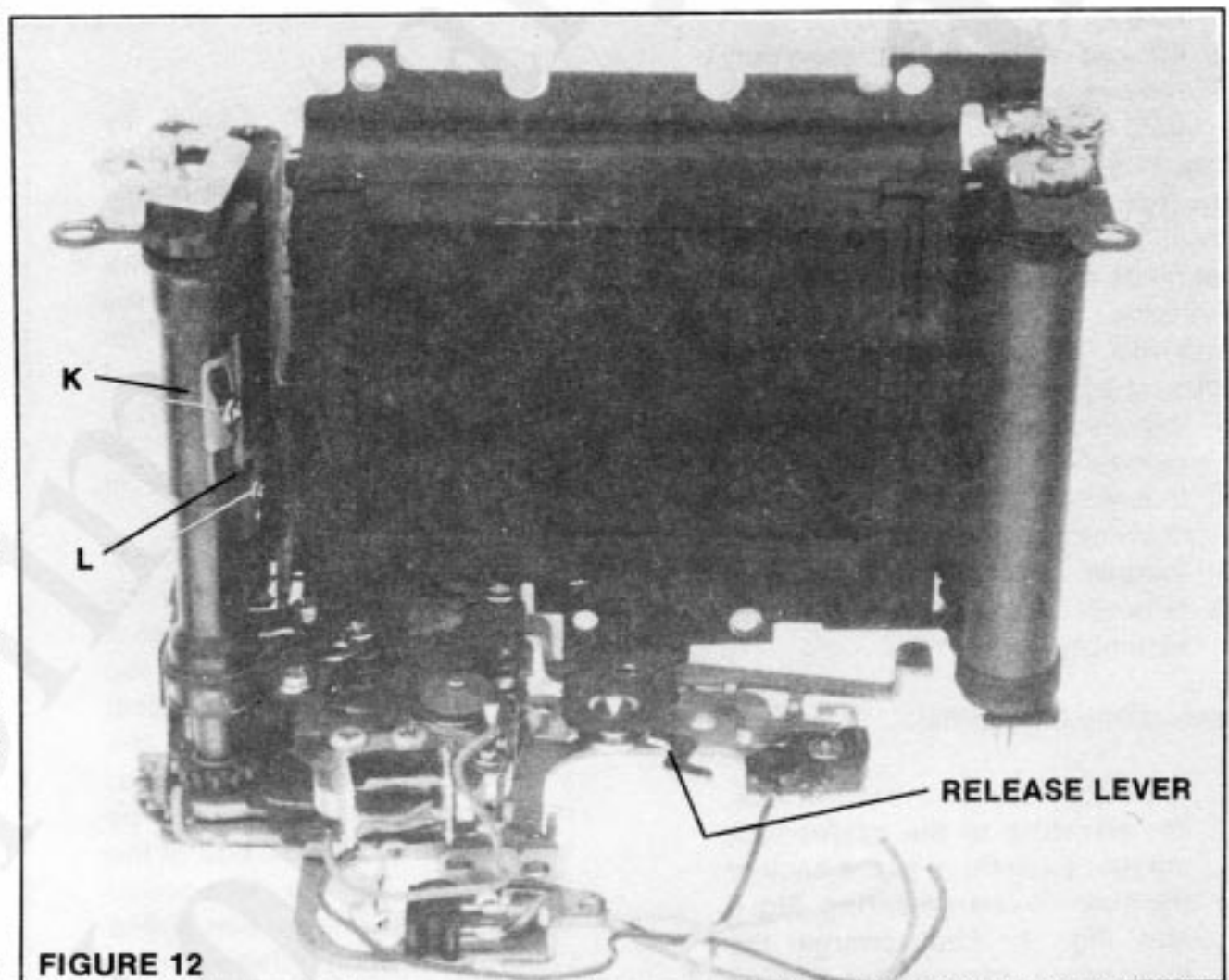

FIGURE 12

bottom of the camera hooks behind the release lever in the shutter block.

7. After installing the shutter block, you can adjust the curtain-travel times and the mechanical speed. Adjust the curtain-travel times either from the top of the camera, Fig. 11, or from the bottom. Adjust eccentric J, Fig. 11, for a mechanical speed of 1/1000 (0.7 — 1ms).

Other disassembly notes:

1. To separate the mirror box from the front plate, take out the lens-mounting ring, shutter-speed

ring (watch for loose ball detent and spring), front decorator plate (by unscrewing PC terminals), and f-value ring with its spring. Then remove the four screws at the front, Fig. 9.

2. To remove the main switch, first remove switch SW109, Fig. 8. Disconnect one end of the coil spring for the charge lever on the mirror box, Fig. 8. Take out the two screws holding the main switch. The two contacts of the main switch must pass under the insulated tab on the aperture-control lever.

TROUBLESHOOTING:

Behavior without batteries: mirror locks up, shutter won't release

Typical current draw:

LEDs on — 2.6ma

Shutter open — 13ma (bulb), 18ma (auto)

Self-timer — 14 - 15ma

Leakage — less than 1 microamp

CdS resistance at EV 15 (lens-mounting ring held against light source, measured between two pink wires): 10.4K

Troubleshooting steps for specific problems:

1. Mirror locks up, shutter doesn't release

Mirror-lock magnet RY101

Apply 2V between the blue and orange magnet wires (one wire disconnected), top of flex at wind side (negative to blue wire). Or short the blue magnet wire to the black battery-box wire. The mirror should complete its travel, and the shutter should release. If so, the mirror-lock magnet is o.k. If not, the mirror-lock magnet may be defective (approximate coil resistance between blue and orange wires — 380 ohms) or there may be oil contamination on the magnet interface.

Main switch

With the mirror locked up, short between the two black wires at the rewind side of the flex, Fig. 15. If the shutter then releases, the main switch is the problem. Or check the resistance between the two black wires with the mirror in the locked-up position. If the main switch is o.k., you'll measure 0 resistance (direct contact).

IC101

With the mirror locked up, short pin 9 of the IC, Fig. 16, to ground. If the mirror then completes its travel, the IC is o.k. If not, check IC101 solder connections and the solder connections between the flex and the auto board.

Poor ground to auto board

Check for a loose ground screw at the front of the auto board, Fig. 6. Also check for poor ground contact between the underside

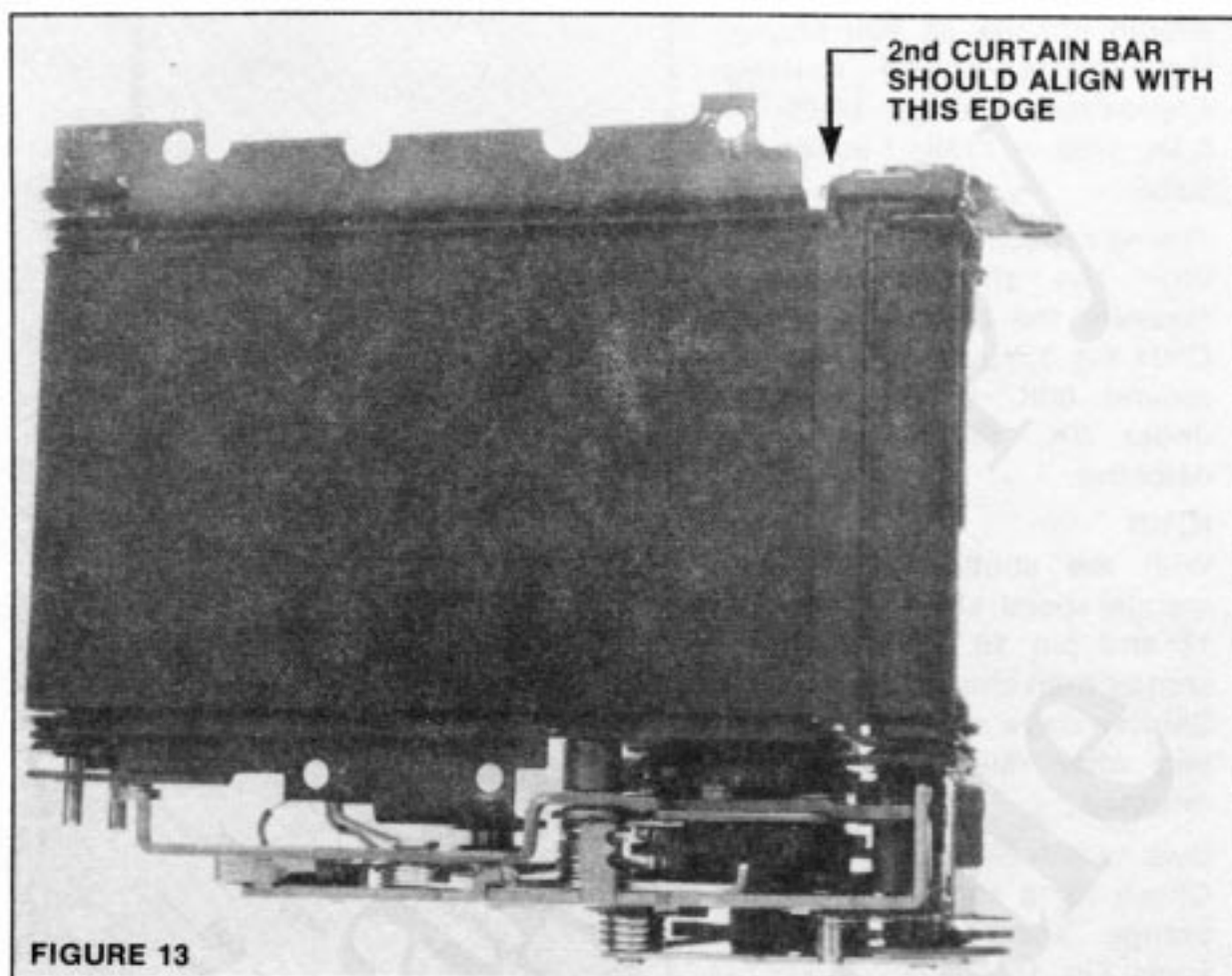

FIGURE 13

of the auto board and the shutter block.

Auto-speed resistor (C in Fig. 1), poor solder to flex

2. Shutter stays open on auto, manual o.k.

Auto film-speed resistor, dirty or poor brush contact

Check by shorting between the two black wires on the film-speed board, Fig. 4. If the shutter then closes, the problem is poor contact between the film-speed brush and the resistor.

Poor connection between auto film-speed resistor and IC101

Check the continuity between pin 11 of IC101 and the black wire to the auto film-speed resistor (the black wire closer to the back of the camera). You should measure direct continuity. Also check the continuity between pin 12 of IC101 and the other black wire of the auto film-speed resistor (the wire closer to the front of the camera). Again you should measure direct continuity. If not, there may be a break in the flex or poor solder between the flex and the auto board.

Silicon photodiode SBC defective

Check the resistance between the two SBC leads, Fig. 6. You should measure around 600 ohms to 1K, depending on ohmmeter polarity. If you measure infinite resistance, the SBC is defective.

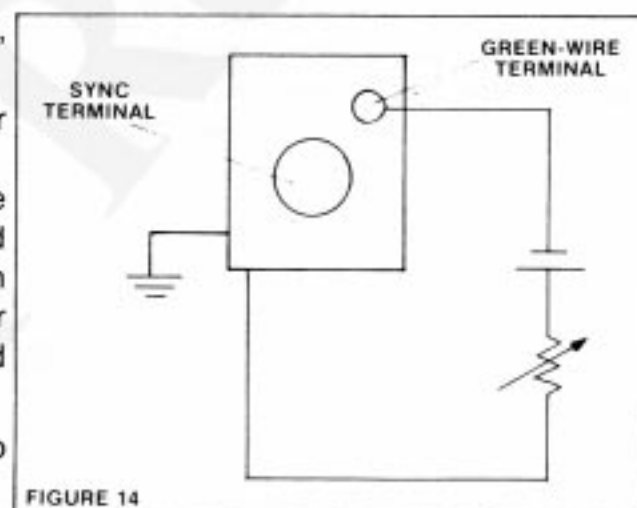

FIGURE 14

IC101

Check by shorting the auto film-speed resistor to ground (black wire closer to front of camera, Fig. 4). Then short pin 10 of IC101 to pin 18, Fig. 16. If the shutter then closes, the IC is o.k. Variable resistor C, Fig. 1, open or poor solder to flex

3. Shutter stays open at manual speeds, auto o.k.

Manual shutter-speed resistor RV106, open or poor brush contact

Check the resistance between the green wire (disconnected) of the manual shutter-speed resistor (top of flex, rewind side) and ground. The resistance

should change as you change the shutter-speed setting. Approximate values: 1/1000 — 6.4K; 1/60 — 117K; 1 second — 6.6M.

Timing capacitor C101, defective
With the shutter released, measure the resistance across C101, Fig. 3. You should measure around 60K. If you measure under 7K, the capacitor is defective.

IC101

With the shutter open on a manual speed, short between pin 11 and pin 18, Fig. 16. If the shutter then closes, the IC is o.k.

4. Shutter stays open at bulb setting after release button has returned

Bulb switch SW103

Check for a short between the orange and red bulb-switch wires, Fig. 16.

IC101

Short pin 18 to pin 17, Fig. 16. If the shutter then closes at bulb, the IC is o.k.

5. Shutter runs through at bulb
Bulb switch SW103, poor contact
With the release button depressed fully, you should measure direct contact between the red and orange wires, Fig. 16.

IC101

Short pin 17 of the IC to ground and release the shutter. The shutter should stay open as long as you ground pin 17. If it does, the IC is o.k.

Mode switch, dirty contacts

Poor solder, flex to auto board

6. Shutter delivers auto operation when set to manual

Q104

Check the collector voltage of transistor Q104, Fig. 3. At manual speeds, the collector voltage should be 0V.

Mode switch, dirty contacts

7. Shutter delivers fastest speed only, all settings

Shutter magnet RY102, open or black wire shorted to ground
Check the resistance of the coil between the gray wire and the black wire at the auto board, Fig. 16. Approximate coil resistance — 600 ohms.

IC101

Check the solder connection at pin 16, Fig. 16.

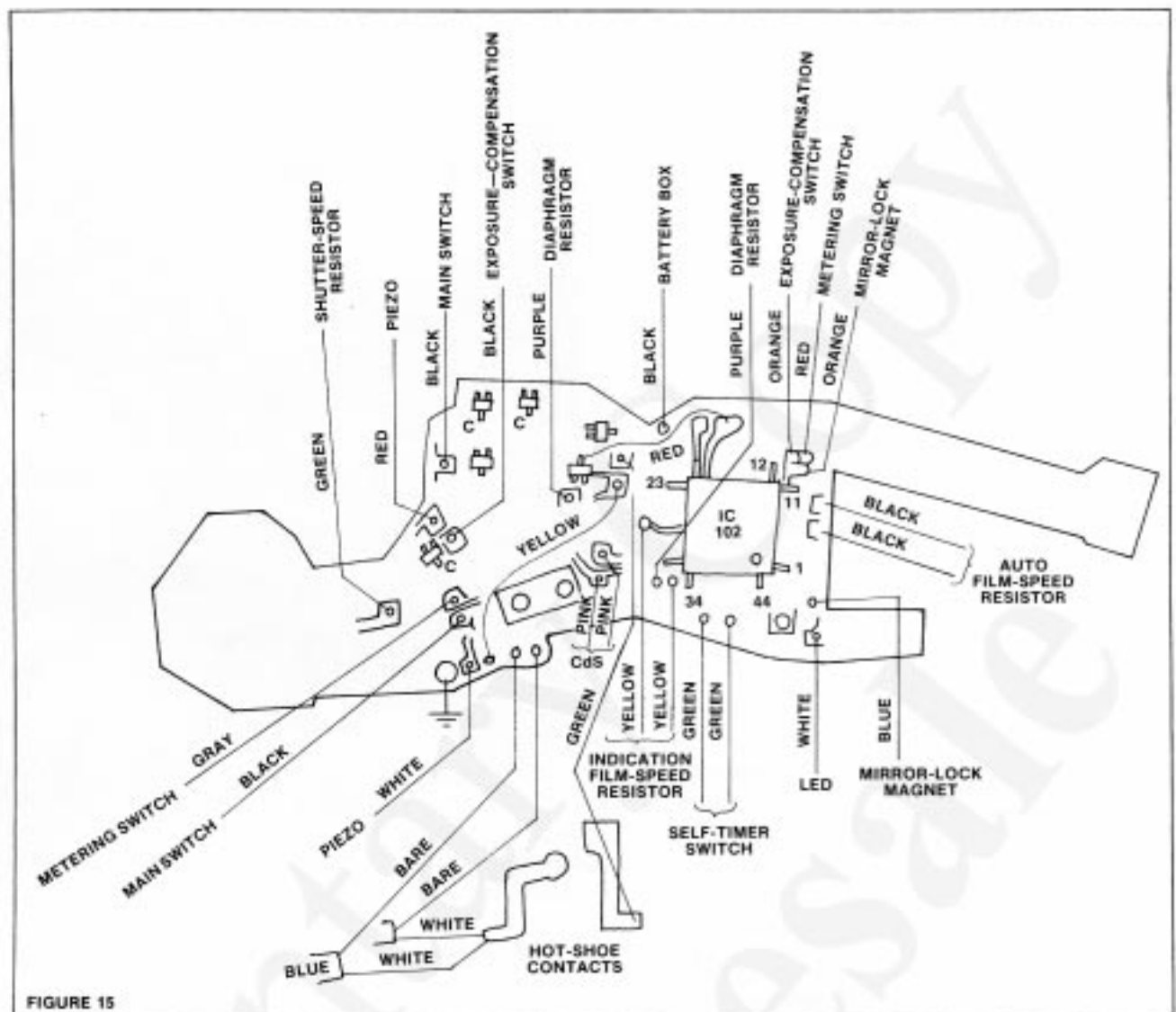

FIGURE 15

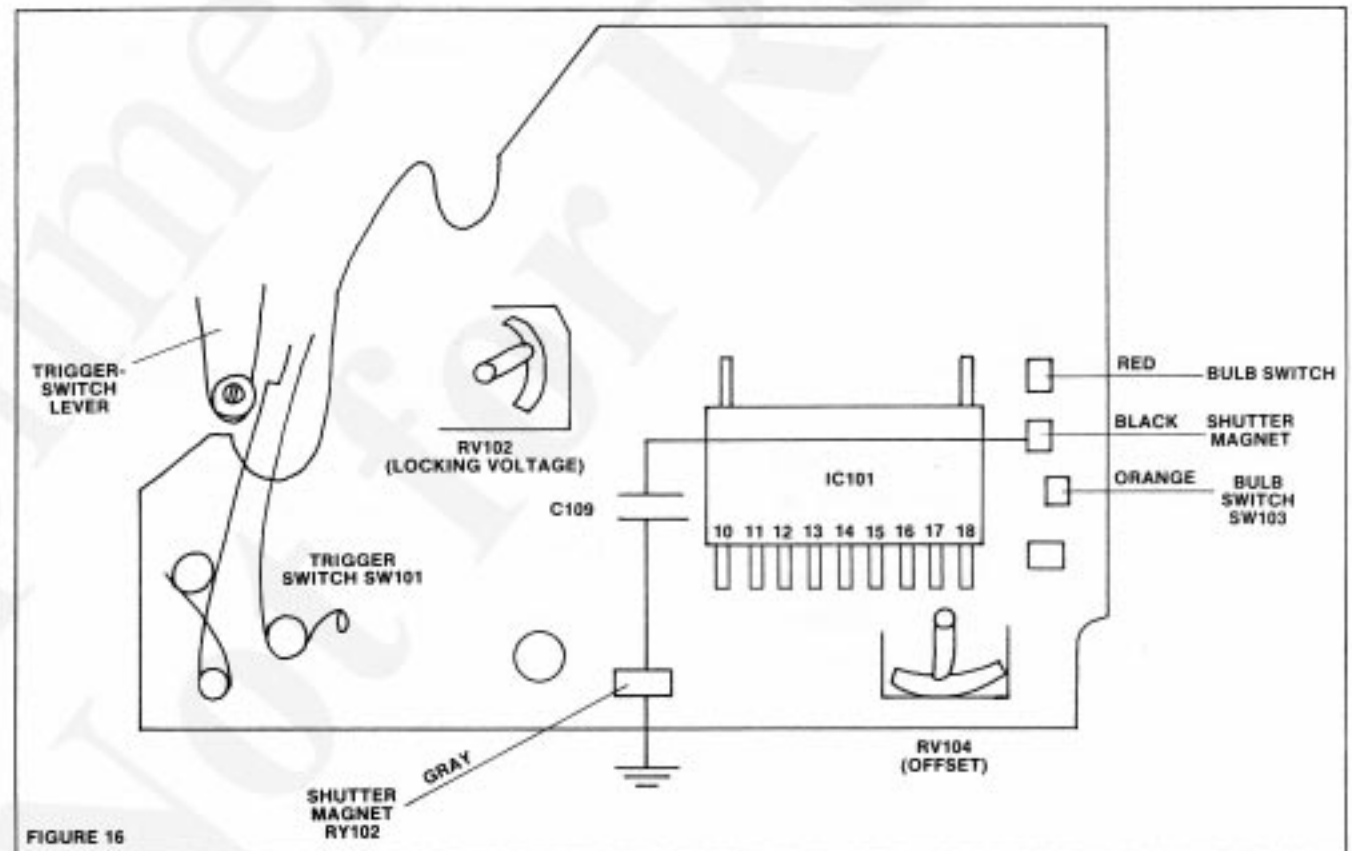

FIGURE 16

8. Shutter delivers overexposure at high light levels, fast manual speeds too slow
Shutter magnet RY102, oil contamination
Ground screw on auto board, loose
Shutter magnet RY102, adjustment incorrect
9. LED display does not turn on
IC102
Check by shorting pin 2 of IC102

to ground. If the LED display then turns on, the IC is o.k.

Metering switch SW106

Check shorting between the red and gray wires of the metering switch. If the display then turns on, the problem is in the metering switch. If the display does not turn on, yet turns on when you short pin 2 of IC102 to ground, check the solder connections of the red and gray wire.

Mode switch, poor contact

- Ground screw loose, rewind side of flex
10. LED display fails to turn off after 90 seconds
IC102
Short pin 3 to ground. The LED display should turn off. If so, the IC is o.k.
Time defective
Check C107 and R107. When you depress the release button, the voltage at pin 3 of IC102 should go to around 3V. The voltage should slowly decrease as C107 discharges. If not, C107 or R107 may have poor solder connections.
11. Only the "over" LED turns on
Indication film-speed resistor, poor contact
Check by shorting together the two yellow wires on the film-speed board. If the over LED turns off and a shutter-speed LED turns on, the problem is in the film-speed resistor
Diaphragm resistor (F board), poor contact
Check by shorting together the two purple wires on the flex (one toward top and one on rewind side). If the over LED turns off and a shutter-speed LED turns on, the problem is poor contact in the diaphragm resistor or a cracked F board. The resistance between the two purple wires should be around 100 ohms (no lens). The resistance should smoothly increase to around 3.4K as you turn the F-value ring against its spring tension.
12. LED display will not change
Cds defective
IC102 defective
13. Several LEDs turn on simultaneously
Indication film-speed resistor dirty
Diaphragm resistor (F board) dirty
14. Exposure-compensation LED will not turn on (plus/minus LED)
Exposure-compensation switch SW110, not closing or poor contact
Check the switch in the top cover. The switch should close with the film-speed knob removed.
Transistor Q102 defective
The collector voltage of Q102 should be around 1.2V with the

- exposure-factor switch closed and 2.6V with the switch open.
15. Manual LED will not turn on
Transistor Q103
The collector of Q103 should drop to around 0.7V in the manual mode.
Mode switch, poor contact
IC102
16. Self-timer does not operate
Self-timer switch, poor contact
Check by shorting between the two green wires at the film-speed board as you release the shutter. The self-timer should now operate. If so, the problem is in the self-timer switch SW102.
IC101
Check by shorting between pins 15 and 18 as you release the shutter. The self-timer should operate. If so, the IC is o.k.
17. LED for battery test and self-timer does not turn on, but piezo beeps
LED defective
Check by disconnecting the white wire at the wind side of the flex. Apply 2V between the white wire (negative) ground. The LED should turn on.
18. Piezo does not beep, but self-timer and LED operate
Voltage to piezo
Check the voltage at the white wire of the piezo crystal, rewind side of flex. During the self-timer delay, you should get a pulsating DC voltage. If you get the pulsating voltage, the piezo may be the problem. If you do not get the pulsating voltage, IC101 may be defective.

PART NUMBERS:

- Flex circuit (complete) — ZC428000 — M circuit board
Silicon photodiode — ZJ157200 (also supplied with complete flex)
Shutter-speed resistor board — ZC428300 — SD2 circuit
F-value (diaphragm) resistor board — ZC426800 — FF circuit
Shutter-speed ring — ZJ159100 — S dial
F-value (diaphragm) ring — ZJ159000 — connecting ring
CdS cell — DS030700
Piezo buzzer — CE424400
Film-speed board — ZC428600 — ASA circuit

- Film-speed brush assembly — ZJ159200 — A lever
Shutter magnet — ZJ156200 — coil
Mirror-lock magnet coil — ZJ15880 (also supplied as part of complete side plate ZC426900)
Focusing screen — LC412400
Take-up spool — CE211700
Shutter block (complete) — ZC427400 (individual parts also supplied separately)

OTHER COMMENTS

1. The flex circuit and the auto board are supplied only as a complete unit.
2. You can remove the focusing screen without taking off the top cover. Pry off the cemented plate at the top front of the mirror box. Then take out the screw and the clip holding the front edge of the focusing screen. A double-ended spring clip holds the rear edge. Insert your tweezers into the two holes visible at the rear edge of the focusing screen. Push both ends of the spring toward the back of the mirror box and drop out the focusing screen.
3. An erratic symptom of the shutter hanging open, often when using dedicated flash, normally means poor solder connections between the flex and the auto board or solder connections of IC101 pins. You may be able to retouch the solder connections, but the normal repair is to replace the complete flex circuit.
4. You can remove the take-up spool for replacement by simply taking out the battery box at the bottom of the camera, Fig. 2.

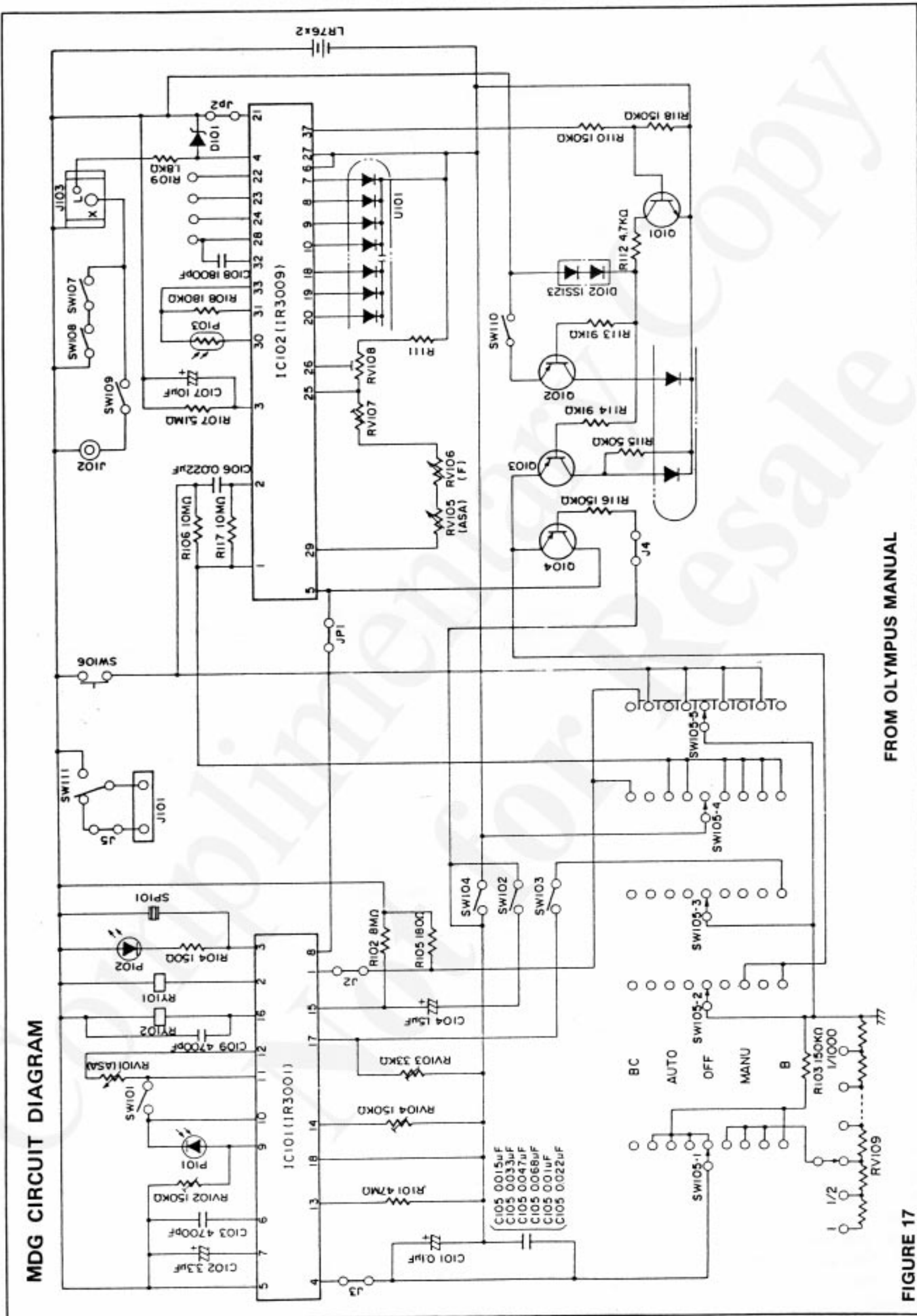

MDG CIRCUIT DIAGRAM

FROM OLYMPUS MANUAL

FIGURE 17