

OMPC

EF

OLYMPUS

OLYMPUS
OMPC

INSTRUCTIONS
MODE D'EMPLOI (A)

Thank you for choosing the Olympus OM-PC. This camera is equipped with a unique "ESP" (Electro-Selective Pattern) metering system. By combining this metering mode with the automatic film speed setting mode and programmed exposure mode, anyone can take perfectly exposed pictures with ease. Before using the camera, please read this operation manual carefully through while checking with your camera to become familiar with this versatile SLR.

Note: All the components of the Olympus OM-PC are carefully designed and their production and assembly is strictly controlled to enhance the unmatched performance of the system. If any interchangeable lenses, flashes, or accessories other than Olympus products are used, Olympus cannot be responsible for poor results or damage of the OM-PC.

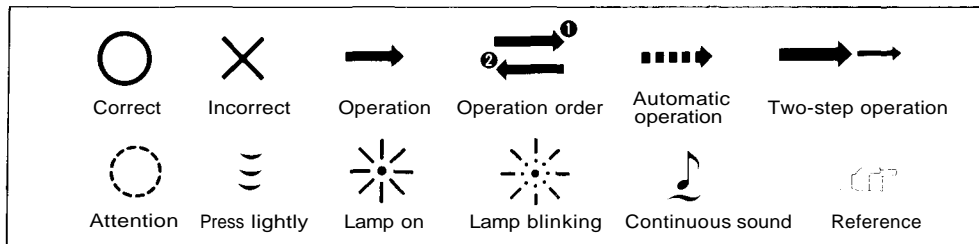
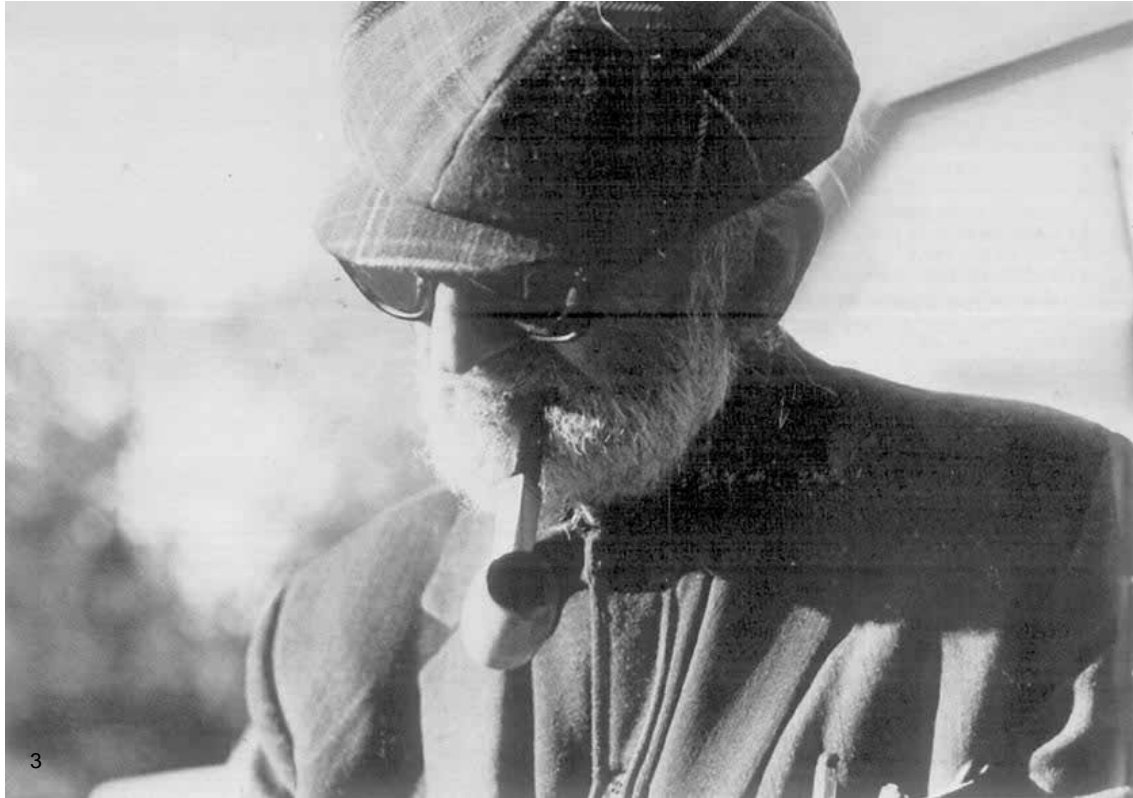

TABLE OF CONTENTS

< Preparations before Taking Pictures >	
• Mounting the Lens	5
• Loading the Batteries	7
• Checking the Batteries	8
• Setting the Camera for Automatic Film Speed Setting	9
• Loading the Film	10
< Taking photographs (I) >	
• How to Take Programmed Automatic Exposure Pictures with ESP Metering	14
• Rewind the Film	17
< Taking Photographs (II) >	
• How to Take Aperture-Preferred Automatic Exposure Pictures	20
• Manual Exposure	23
• Manual Film Speed Setting	25
• Exposure Compensation	27
< Other Operations >	
• Using the Self-Timer	29
• Bulb Exposure	31
< Advanced Techniques >	
• Selecting the Metering Mode (A Choice of Two Metering Modes)	33
• Selecting the Metering Mode (How to Use ESP Metering)	35
• Guide to Selection of Exposure Mode	40
• Selecting the Exposure Mode — PROGRAM —	41
• Program Diagrams	42
• Selecting the Exposure Mode — AUTO (Aperture Preferred)	44
• Depth of Field	45
• Preview Button	46
• Shutter Speeds	47
• Viewfinder Display for Automatic Exposure	48
• Selecting the Exposure Mode — MANUAL —	49
• Combinations of Metering Mode and Exposure Mode	50
• Selecting the Film Speed Setting Mode	51
• Bulb Exposure	53
• Multiple Exposure/Infrared Photography	54
< OM SYSTEM >	
• Flash Photography	56
• T-Series Flashes/Mounting the Flash	57
• How to Use T-Series Flashes	58
• Bounce Flash/Close-up Flash	59
• Using Electronic Flashes Other Than Olympus T-Series Units	60
• Shooting with Motor Drive	61
• Motor Drive Group Units	62
• Macrophotography	63
• Macrophoto Group Units	64
• Other System Units	65
< For Longer Service of Your Camera >	
• Handling Care	67
• Storage Care	68
• Questions and Answers	69
• Description of Controls	73
• Specifications	76





< Preparations before Taking Pictures >

The Olympus OM-PC is basically designed for automatic film speed setting with DX coded film.

Mounting the Lens



1

Remove the rear lens cap.



2

Remove the body cap.



3

Align the red dots and rotate the lens clockwise until it locks.



4

Remove the front lens cap. (Press in the mount tabs on the edges of the lens cap parallel with "OLYMPUS").



Removing the Lens:

Press the lens release button and turn the lens counter-clockwise.

Loading the Batteries



1

Remove the battery cover.

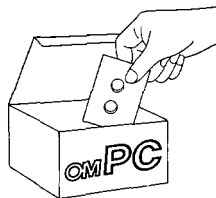

2

Wipe battery surfaces clean. Make sure that + signs are facing upwards. Replace the battery cover.

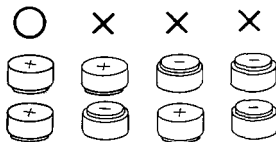

Checking the Batteries

After inserting the batteries, always check as follows:

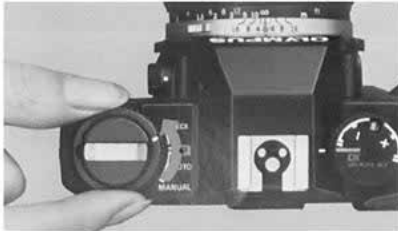

1

Rotate the mode selector dial to the "BATTERY CHECK" position.



2

The audible and visual signals will tell you that the battery voltage is sufficient. If these signals are emitted intermittently, it means that the batteries are almost worn out. Replace them with new ones as soon as possible.

Setting the Camera for Automatic Film Speed Setting

With DX coded film, the OM-PC sets the film speed automatically.



1

Make sure the film you are using is marked "DX".
If the film you are using is not marked "DX" refer to page 25.



2

Set the film speed dial to 

Loading the Film



1

Pull up on the rewind knob to open the camera back.

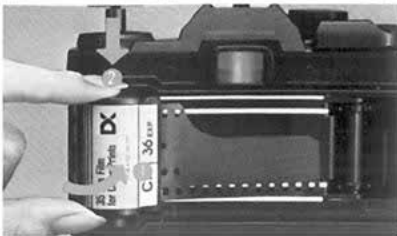

2

Place the film cartridge in the film chamber.



Always load film in the shade.

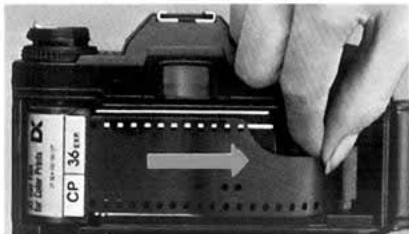

3

Insert the film leader into the take-up spool.

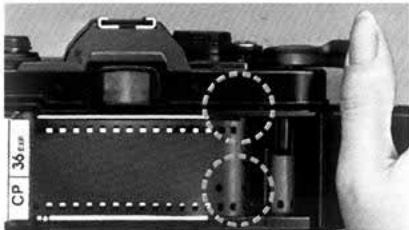
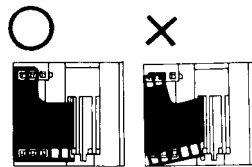

4

Wind the film and make sure the sprocket teeth catch both the upper and lower film perforations.



5

Take up the slack by turning the rewind crank clockwise.



6

Close the camera back until it clicks into place.

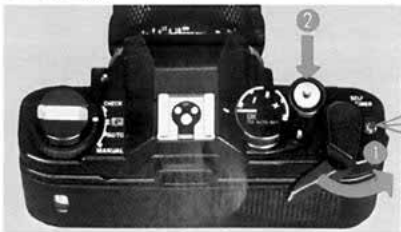

7

Take two blank shots to bring the film to the first frame.

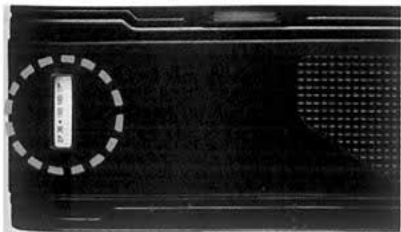

Checking the type of film:

The film check window in the camera back will allow you to check the type of film loaded in the camera.



< Taking Photographs (I) >

This chapter explains how to take programmed automatic exposure pictures with ESP metering. In this mode, anyone can enjoy taking pictures with ease, even in difficult lighting conditions such as backlight.

How to Take Programmed Automatic Exposure Pictures with ESP Metering



1

Make sure the camera is set for the ESP metering.

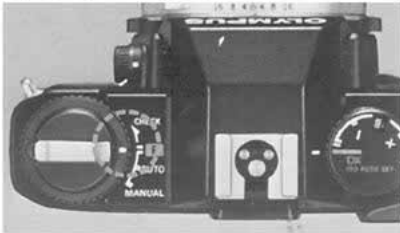

2

Set the mode selector dial to the "PROGRAM" position.



3

Set the lens to its minimum aperture, which is the largest number on the aperture ring.



4

Press the shutter release lightly to activate the viewfinder display.

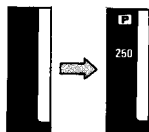

5

Focus on your subject.

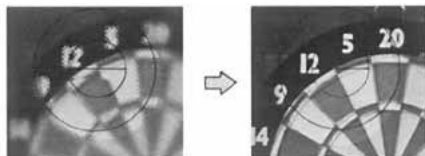



6

The  mark will appear in the finder when ESP metering is adjusting the exposure.



7

Press the shutter release to take the picture.

(A built-in battery conserver turns off the viewfinder display after 60 sec.)

Rewinding the Film



1

When the exposure counter indicates the end of your roll of film.

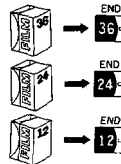

2

Push the "R" button.

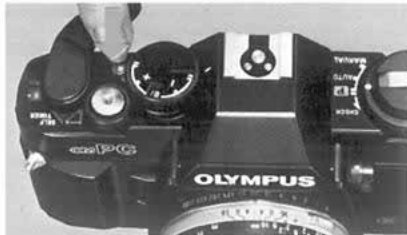



3

Fold out the rewind crank and wind it until the film tension is released.



4

Open the camera back by pulling up on the rewind knob and remove the film.



< Taking Photographs (II) >

This mode allows you to respond creatively to the photo situation by free selection of the lens aperture, shutter speed and exposure compensation settings.

How to Take Aperture-Preferred Automatic Exposure Pictures

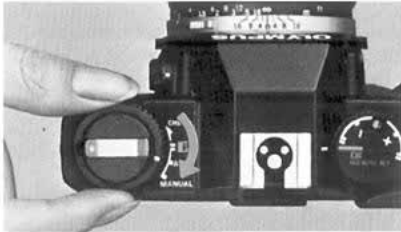

1

Set the mode selector dial to the "AUTO" position.



2

Select the light metering mode.



ESPMetering.



"OTF" Light Metering (Center-Weighted Average Metering)



3

Set the aperture.

Basic aperture settings.

ISO/ASA 100			
F/stop	16	8	4
Weather			



4

Press the shutter release lightly to activate the viewfinder display.

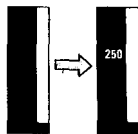

Focus on your subject.



5

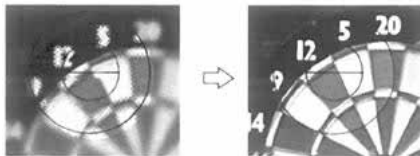



6

Press the shutter release to take the photograph.

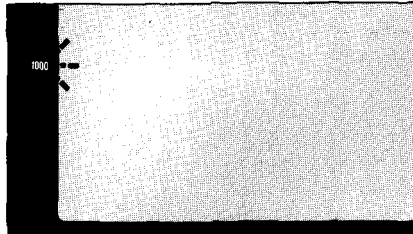

If you see an overexposure warning signal (the number "1000" blinks), set the aperture to a larger number.

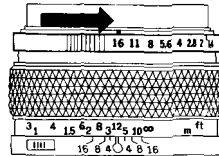

If the shutter speed is too slow, set the aperture to a smaller number to prevent camera shake.

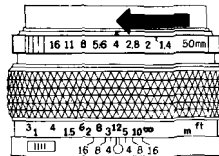
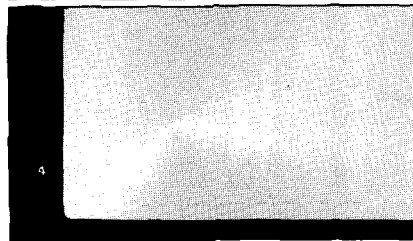

Manual Exposure

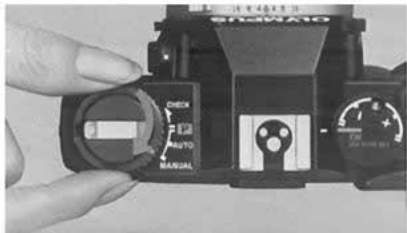

1

Set the mode selector dial to the "MANUAL" position.



2

Set the aperture.



3

Select the shutter speed.



4

Focus, then press the shutter release.

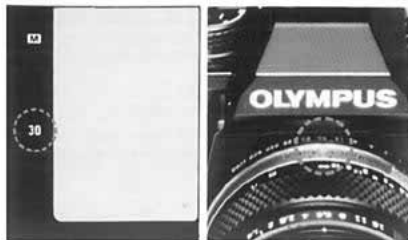

To obtain the proper exposure, set the shutter speed ring to the setting indicated in the viewfinder.



ESP Metering.



Center Weighted Averaged Metering.

Manual Film Speed Setting

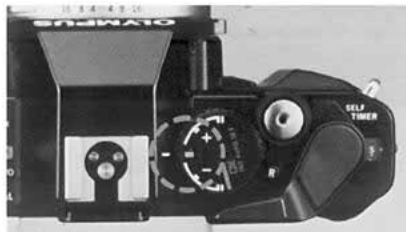

1

Release the DX ISO AUTO SET mode.

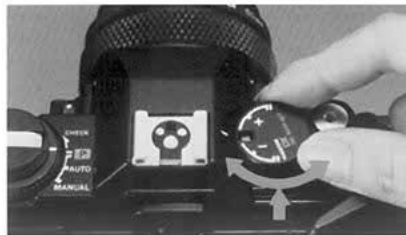

2

Lift up the outer collar and rotate until the desired ISO speed appears in the window.

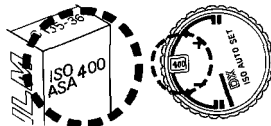

ISO/ASA25~3200

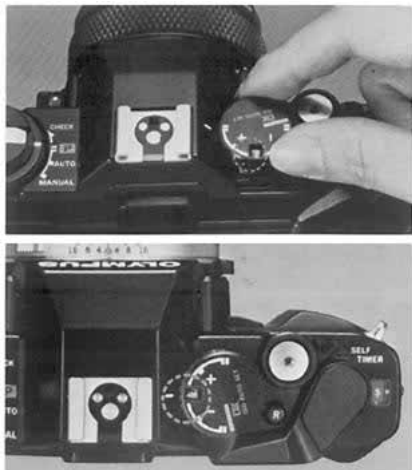

3

Readjust the Index line.

If the film speed dial (exposure compensation dial) cannot be turned to the ISO number of the film used, set it once at an intermediate value then repeat steps 2 to 3 until the desired ISO number is set.

Exposure Compensation

For exposure compensation, set the dial anywhere except at "DX ISO AUTO SET".



1

When an exposure compensation is set, the  indicator lights in the viewfinder.



2

After use, be sure to return the dial to the "normal setting".

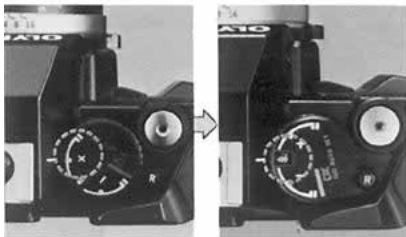



< Other Operations >

Using the Self-Timer



1

Wind the film once.

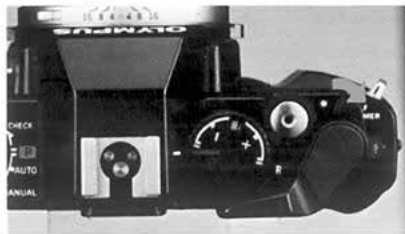

2

Set the self-timer lever.



3

Press the shutter release to start the self-timer. The shutter will fire in 12 seconds.



4

Wind the film for the next shot. The self-timer lever will automatically return to its original position.

If you continue to use the self-timer, wind the film in several short strokes, and it will remain activated. Take note that shutter will fire even if you return the self-timer lever to its original position while it is running.

Bulb Exposure

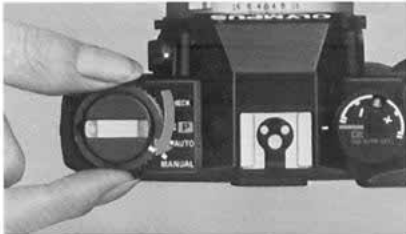

1

Set the exposure mode selector dial to the "MANUAL" position.



2





Set the shutter speed dial to "B" (bulb). ("B" is not displayed in the viewfinder.)



Advanced Techniques

If you want to improve your pictures or refine your shooting techniques, it is important to understand the operation of your camera thoroughly. The following pages will provide detailed technical information on the OM-PC to help you create more sophisticated photographs.

SELECTING THE METERING MODE (A Choice of Two Metering Modes)

Mode	Selector switch	Viewfinder Display	Features
ESP Metering		 <p data-bbox="492 567 641 684">This symbol appears only when ESP Metering is operational.</p>	<ol style="list-style-type: none"> 1. This mode can be selected for general use at all times. 2. Depending on the light distribution in the composition, metering is carried out as follows: <ul style="list-style-type: none"> ■ When the central part of the composition is darker than areas on the periphery, the camera computer increases the exposure to compensate according to the degree of difference in brightness indicated. ■ When the central area is brighter than the rest of the composition the camera sets a predetermined compensation value to reduce the exposure. ■ When the sun or other extremely bright light sources appear directly in the composition they are ignored in making the exposure calculation. ■ When the whole composition is illuminated evenly the camera operates in the same way as in TTL Direct "OTF" Auto Mode (using center-weighted average metering). In this case the ESP Metering symbol  does not appear.
TTL Direct "OTF" Light Measuring (Center-weighted average metering)			<ol style="list-style-type: none"> 1. This mode should be selected when you do not want to leave everything up to the camera, but prefer to set the exposure according to your own experience, 'feel' and creative requirements. 2. In this mode the camera decides the exposure by taking an average (center-weighted) of the brightness of the overall composition, without analyzing light distribution in different parts of the composition.

■ ESP (Electro-Selective Pattern) Metering

Generally, a photograph includes objects with different levels of brightness. Center-weighted, averaged light metering is an excellent method for the majority of ordinary subjects. It averages the light intensity in a picture frame to determine exposure. With backlighting and other types of illumination, however, this metering method may not provide correct exposure because the light level often differs between the subjects and backgrounds. The Olympus OM-4, OM-3 and OM-2S PROGRAM have adopted spot metering systems which allow the photographer to isolate the subject for specific metering and therefore to obtain more accurate exposures.

The new ESP metering system has been specifically developed for the OM-PC to simplify exposure in these difficult lighting conditions. As soon as you fire the shutter, the camera will measure the light intensity in both the center of the frame and outer area separately. The micro computer then processes this information, including contrast data, and automatically sets optimum exposure according to the ESP algorithm*. By simply depressing the shutter release, you can produce a photograph in which the subject will appear as you see it with your eyes.

* For further information on ESP algorithm, refer to page 39.

■ TTL Direct Off-The-Film "OTF" Light Metering (Center-Weighted Average Metering)

This is the direct, center-weighted, averaged light metering system which Olympus pioneered in the original model OM-2. It measures the brightness of the subject as the light registers on the film during the actual exposure. "OTF" metering can respond to any sudden changes in light during exposure, and therefore it is very advantageous for taking quick candid shots and fast moving subjects. In flash photography with an Olympus T-Series flash, this "OTF" Light Metering method will also fully control the flash exposure, thereby eliminating any need for complicated guide number exposure calculations. You can work with all available apertures of your lens and use sophisticated techniques such as bounce flash and multi flash in a fully automatic mode. It has also solved difficult exposure problems with macrophotography.

SELECTING THE METERING MODE (How to Use ESP Metering)

ESP Metering is the mode to set for general use. In this mode, you don't have to worry about how the picture will turn out. All you need do is press the shutter release. Even in tricky situations such as sharp backlighting, the camera responds flexibly to give you correctly exposed shots. This mode assures trouble-free shooting even with the kind of pictures that often turned out as failures because the exposure was wrong. In fact, ESP Metering greatly increases the range of auto exposure technology. The following examples should provide a useful reference.

* When taking pictures in ESP metering mode, activate the viewfinder display by pressing the shutter release button lightly, then shoot.

Subjects for which ESP Metering is Specially Effective



■ Backlighting

With center-weighted average metering, this kind of situation tends to leave the subject's face pitch black. But ESP Metering assures even the fine shades of the subject's expression are faithfully conveyed. For the best results, try to keep the main subject fairly near the center of the composition. Check for the ESP Metering symbol  in the viewfinder.



■ **When part of the subject area is extremely bright**

If a part of the picture frame is extremely bright, the subject is underexposed under the influence of a strong light on the table in the case of center-weighted, averaged metering. In the same picture taken with the ESP metering, even the expression of her face is clearly seen.

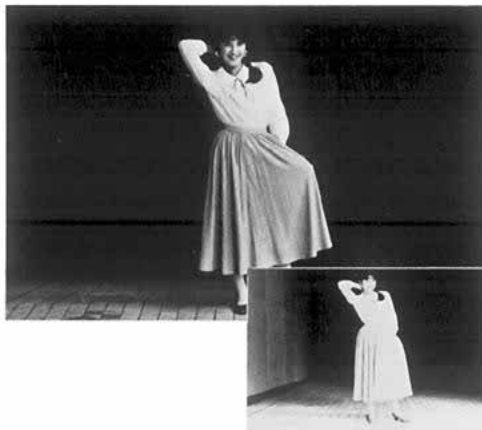

■ **When the surrounding area is very dark**

In center-weighted, averaged light metering, the subject appears slightly overexposed under the influence of a dark surrounding. In ESP metering mode, however, it is correctly exposed. In this case too, you will get the best results by keeping the main subject close to the center of the composition.



■ **When the background is extremely bright in sunlight**

In center-weighted, averaged light metering, the subject appears completely dark; in ESP metering mode, you will see even her face clearly. If there is an extremely bright object in the viewfinder frame, ESP metering mode disregards this object when determining exposure, as shown in this example.

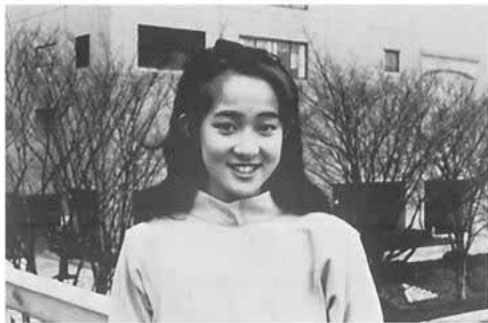

■ **Ordinary lighting conditions**

In this case, the exposure is the same as in center-weighted, averaged light metering. The mark  will not appear.

■ Notes on ESP metering

The ESP metering mode works properly for the majority of subjects, but it may not be as effective in the following cases:

■ When the subject is too small

In this case, the metering method is practically the same as the center-weighted averaged metering.

■ Manual exposure in ESP metering mode

Set the metering mode switch to the ESP and the exposure mode to manual.

- ① Compose your photograph.
- ② Aim the camera so that your subject is located in the center of the viewfinder. Now, the  mark will turn on.

■ When the subject is not in the center of the viewfinder

Because ESP metering measures with emphasis on the center of the viewfinder frame, it will give substantially the same result as the center-weighted, averaged metering. In this case, use manual exposure in ESP metering mode as follows.

- ③ Set the shutter speed at the same value as indicated in the viewfinder.
- ④ Reframe your subject again as you originally did in ①, then focus and shoot it by depressing the shutter release button.



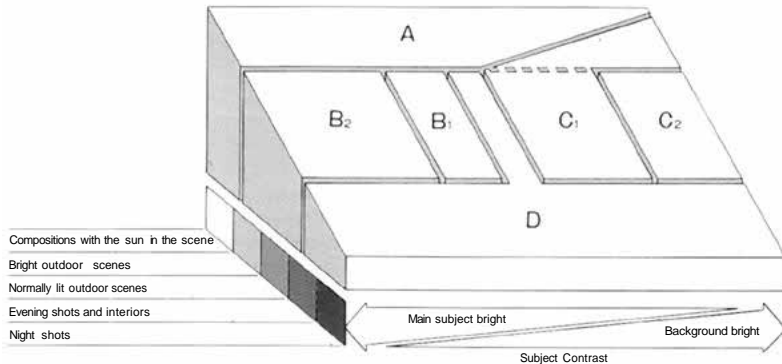

■ ESP Metering Chart (ESP Algorithm)



- A** Concentration on low light areas
- B₂ C₂** Center weighted metering for high contrast subjects
- B₁ C₁** Center weighted metering
- D** Averaged metering

Modes	Mode Selector Dial
PROGRAM	
AUTO (Aperture preferred exposure)	
MANUAL	

GUIDE TO SELECTION OF EXPOSURE MODE

Viewfinder Indication	Features
	<ol style="list-style-type: none"> 1. This is the ideal normal mode for snapshots and general photography. 2. When this mode is set the camera automatically decides both the shutter speed and the aperture. Fully automatic exposures are possible over a wide range of subject brightnesses. 3. You can concentrate on following the subject in the viewfinder without worrying about exposure or shutter speed settings. 4. If you set an intermediate aperture on the lens, the program automatically becomes a continuously variable program.
	<ol style="list-style-type: none"> 1. This is basically an aperture preferred mode, but it is possible to use it also as a shutter speed preferred system. This mode is the one to select when you want to put your creative ideas into the picture. 2. In this mode you can concentrate on special depth of field effects, adjusting the aperture to determine whether the background, etc., will be blurred or in clear focus. <ul style="list-style-type: none"> ■ Here the background is blurred to make the main subject stand out. (Wide open lens aperture) ■ Here the background is also in sharp focus, giving a feeling of greater spaciousness and expansiveness. (Stopped down aperture) 3. You can concentrate on shutter speed effects (blurring with motion, etc.). <ul style="list-style-type: none"> ■ Here a fast shutter speed arrests the movement of the subject, giving it a kind of timelessness. (Wide open aperture) ■ Here use of a slow shutter speed results in a blurred subject, emphasizing the sense of speed. (Stopped down aperture)
	<ol style="list-style-type: none"> 1. In Manual Mode, both the lens aperture and the shutter speed are set by hand, giving free reign to your experience and 'feel' for the picture situation. 2. Use when you want to keep the same exposure settings regardless of the brightness of the subject. 3. Use for "Bulb" photography when the shutter is both opened and closed manually. 4. Use when you are basing the exposure on the values given by a separate exposure meter.

SELECTING THE EXPOSURE MODE - PROGRAM -



■ Program Exposures

In this mode the camera automatically selects the ideal lens aperture and shutter speed for the subject brightness, making you highly responsive even to unexpected shots. In Program Mode, the photographer can forget about exposures and shutter speeds completely, and give full concentration to the subject in the viewfinder. The only settings needed are to turn the Mode Selector Dial to Program **P**, and set the aperture ring to the smallest available aperture (largest F number). Whether the subject is extra bright or unusually dark, you can still rely on fully automatic shots

with the best possible aperture and shutter speed settings. Even if you suddenly come from a dark place out into bright sunlight, the camera responds immediately, assuring you fine photos in both situations. Better still, when you use the Program exposure mode together with the ESP Metering mode, even raw beginners are assured of great shots in every situation — including tricky backlit or high contrast shots that used to stump the experts too! This is the perfect mode for snapshots and general photography, as well as for such special fields as news photography, where being ready for everything at all times is the most important requirement.

■ PROGRAM DIAGRAMS

Regular Program Diagram

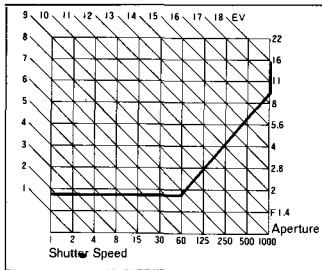

This program shows the regular program settings that will be obtained with a 50mm F 1.8 lens on the camera. From dim light conditions up to a shutter speed of 1/60 sec. the lens aperture remains wide open. At faster speeds than 1/60 sec. the shutter speed and lens aperture settings change in coordination at a ratio of 6/5 as shown. Thus the program is designed to assure adequate shutter speeds and minimize the risk of camera shake spoiling the picture. With still brighter subjects, the program concentrates on closing down the lens aperture sufficiently to assure sharp and clear depth of field effects.

Continuously Variable Program Diagram

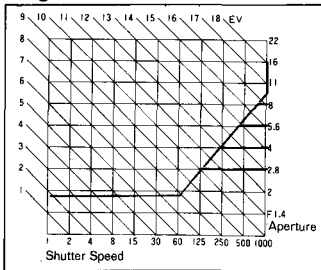

The special OM-PC program system also allows you to intentionally set different lens apertures for a continuously variable program able to assure precise depth of field effects, etc. For a quick unexpected shot, the program will assure a correct exposure providing the shutter speed you need is not over 1/1000 sec. If the lens aperture setting calls for a shutter speed faster than 1/1000 sec., this  symbol and the 1000 indicator in the viewfinder will flash on and off, and will warn you to reset the aperture to the largest number.

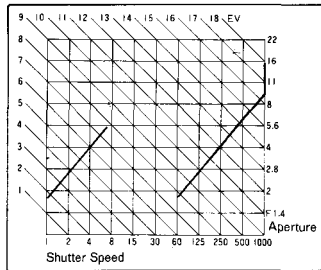

Program Diagram with Use of T Series Flash Unit



The OM-PC assures you "OTF" Program Auto flash performance when you use an OM System T Series flash unit. The flash will fire automatically at program shutter speeds of 1/60 sec. or slower, whenever the flash unit is switched ON. In this situation the camera program automatically shifts three settings to the special Flash Program. The final exposure is made precisely accurate by the camera computer, which shuts off the flash the instant the right amount of light has reached the film.

■ Viewfinder Display in the Program Mode

Set the exposure mode dial to **P** and press the shutter release button lightly while looking through the viewfinder.

The **P** mark will be lighted and the shutter speed will be displayed in the left side of the viewfinder. If  and "1000" blink alternately, it means you have not set the aperture ring to its minimum aperture. Even if it is set at other positions, however, the camera will operate on programmed exposure and  will not turn on if the shutter speed does not exceed 1/1000 sec. This is another intelligent and functional feature of the OM-PC. If "1000" alone blinks, it means your subject will be overexposed. Use a Neutral density (ND) filter to reduce the amount of light entering the lens, or a slower film depending on shooting conditions.

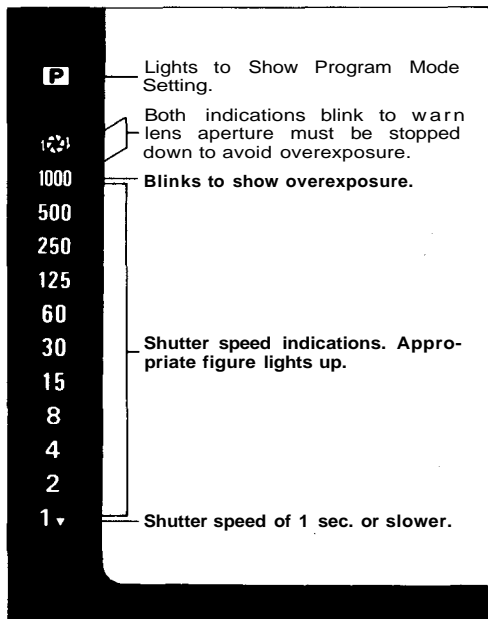

SELECTING THE EXPOSURE MODE - AUTO (Aperture Preferred) -



■ Auto Exposures

This is an aperture preferred auto mode in which the shutter speed is set automatically by the camera to give the correct exposure for the aperture which the photographer has set after considering the kind of picture desired. Settings are simple. First set the Mode Selector Dial to AUTO. Then set the desired aperture on the aperture ring. In this mode you have a creative freedom to select desired depth of field and other effects, for the kind of results it is hard to obtain in Program Mode. For example, if you want to eliminate the background in a portrait shot, open up the lens aperture as far as you can.



When you want the background to appear sharply too, close the aperture down. In this way you can precisely adjust the lens depth of field for just the effect you want. Although this mode is basically aperture preferred, you can also use it as a shutter speed preferred mode by adjusting the lens aperture to get the shutter speed you require in the viewfinder display. Used in this way it is also highly suitable for getting the effects you want with moving subjects.

DEPTH OF FIELD

Depth of field is the area of acceptable sharpness in front of and behind the subject in focus. As you get closer to your subject or as you open your lens (e.g. from F16 to F2.8) the depth of field becomes shallower. By stopping your lens down (e.g. from F2.8 to F16) or getting farther away from your subject this depth of field can be increased.

The table below shows that when the camera-to-subject distance is 3m, the depth of field at F16 ranges from 1.93m to 6.93m.

As you press the preview button, looking through the viewfinder, you can ascertain the actual depth of field.

Depth of Field Table (F1.8 & F1.4 50mm Lenses)

Circle of least confusion 1/30mm

Scale F Stop	Camera-to-Subject Distance (m).									
	0.45	0.5	0.7	1	1.5	2	3	5	10	∞
1.4	0.45 ~0.45	0.50 ~0.50	0.69 ~0.71	0.99 ~1.02	1.47 ~1.54	1.94 ~2.07	2.86 ~3.16	4.61 ~5.46	8.55 ~12.05	57.78 ~∞
1.8	0.45 ~0.45	0.50 ~0.50	0.69 ~0.71	0.98 ~1.02	1.46 ~1.55	1.92 ~2.09	2.82 ~3.20	4.56 ~5.60	8.21 ~12.79	45.05 ~∞
2	0.45 ~0.45	0.50 ~0.50	0.69 ~0.71	0.98 ~1.02	1.45 ~1.55	1.91 ~2.10	2.80 ~3.23	4.47 ~5.68	8.05 ~13.20	40.57 ~∞
2.8	0.45 ~0.45	0.49 ~0.51	0.69 ~0.71	0.97 ~1.03	1.43 ~1.57	1.88 ~2.14	2.78 ~3.33	4.28 ~6.01	7.47 ~15.15	29.02 ~∞
4	0.44 ~0.46	0.49 ~0.51	0.68 ~0.72	0.96 ~1.04	1.41 ~1.61	1.83 ~2.20	2.68 ~3.49	4.04 ~6.57	6.74 ~19.44	20.35 ~∞
5.6	0.44 ~0.46	0.49 ~0.51	0.67 ~0.73	0.94 ~1.06	1.37 ~1.66	1.77 ~2.29	2.5 ~3.74	3.75 ~7.52	5.96 ~31.31	14.55 ~∞
8	0.44 ~0.46	0.48 ~0.52	0.66 ~0.74	0.92 ~1.09	1.32 ~1.73	1.69 ~2.45	2.31 ~4.18	3.39 ~9.61	5.09 ~378.10	10.21 ~∞
11	0.43 ~0.47	0.48 ~0.53	0.65 ~0.76	0.90 ~1.13	1.27 ~1.84	1.60 ~2.68	2.11 ~4.91	3.02 ~14.74	4.30 ~∞	7.44 ~∞
16	0.43 ~0.48	0.47 ~0.54	0.63 ~0.79	0.86 ~1.20	1.19 ~2.05	1.47 ~3.17	1.93 ~6.93	2.57 ~138.43	3.42 ~∞	5.13 ~∞

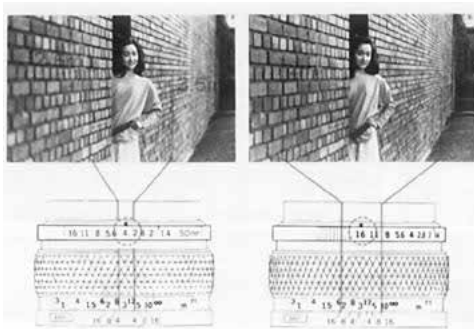

The double series of numbers engraved on the depth of field scale represent F stops: F4, F8 and F16. Once you have focused on your subject, all objects within the distance range indicated on the lens distance scale between the marks for the F/stop you have selected will have acceptable sharpness.

* For other lenses, see the lens instruction manual.

PREVIEW BUTTON



When you wish to see which objects fall within the acceptable zone of sharpness (depth of field), press the preview button on your lens. The diaphragm of the lens will stop down to the preset F stop enabling you to see the depth of field in the viewfinder.

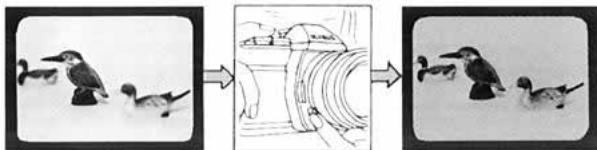

In PROGRAM mode, it is impossible to check the depth of field with the preview button.

CAUTION: • Do not take pictures in the programmed exposure mode with the preview button depressed.

SHUTTER SPEEDS



This camera offers various possibilities for visual expression by changing the shutter speed.

High shutter speeds can be used to "freeze" a moving subject to give sharp definition of the image. Shutter speeds of 1/1000 sec. can "stop" the movement of a considerably fast moving subject. A shutter speed of about 1/250 sec. will be enough to shoot a child at play, if he is not moving too quickly.

There are two methods for giving dynamic expressions. The first one is to blur out the movement of the subject itself, thereby creating a moving image. The second one is to pan the camera according to the movement of the subject. While the background is blurred, the subject is sharply defined to create a moving image.

* In using slow shutter speeds, it is necessary to guard against camera shake. We will suggest a

very practical method for choosing shutter speeds. Generally, shutter speeds of which denominator value is larger than the focal length value of the lens used are good for preventing camera shake. If you are using a 50mm lens, for example, shutter speeds of 1/60 sec. or higher are best; and if you are using a 200mm lens, shutter speeds of 1/250 sec. or higher are best.

VIEWFINDER DISPLAY FOR AUTOMATIC EXPOSURE

If you press the shutter release button lightly while looking through the viewfinder, you will see the automatic shutter speed in the left side of the frame. However, if the "1000" blinks, it means overexposure and you will have to close down the aperture.

If the "1000" does not disappear even when the lens is set to its minimum aperture, the subject is outside the range of automatic exposure control. In this case use an ND (neutral density) filter or shoot with film having a lower ISO number.

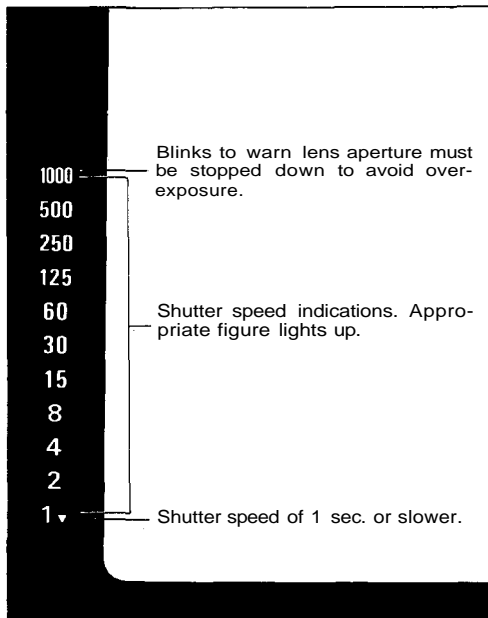

SELECTING THE EXPOSURE MODE - MANUAL -

The OM-PC also provides manual exposure control. With the exposure mode dial set to MANUAL, you can choose your desired aperture and shutter speed combination. You will see the following display in the viewfinder.

As you adjust the aperture ring, the appropriate shutter speed for the aperture you have set will be displayed in the viewfinder. Set the shutter speed dial to that value.



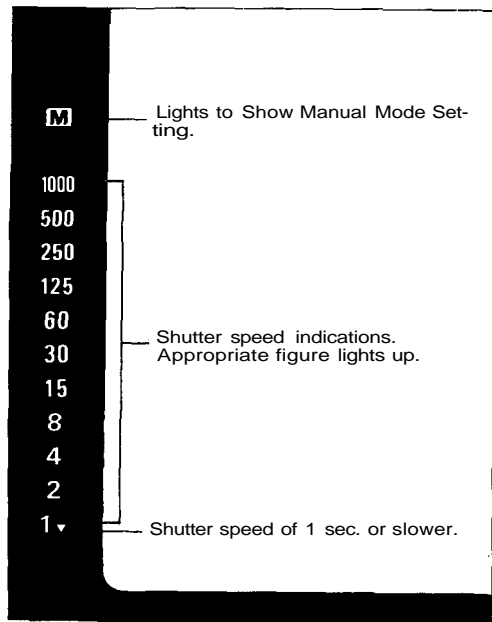



If you are shooting fast moving subjects such as sports scenes, you may prefer to set your shutter speed first. If so, then adjust your aperture until the preselected shutter speed is indicated in the viewfinder. This technique is useful when a specific shutter speed is needed.

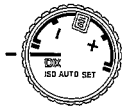

COMBINATIONS OF METERING MODE AND EXPOSURE MODE

Exposure Modes Metering Modes	PROGRAM	AUTO (aperture preferred)	MANUAL
ESP Metering	<p>The ideal mode for snapshots and general photography, that lets you take properly exposed shots easily, even in difficult lighting conditions.</p> <p>It is still simpler and more convenient when combined with the DX ISO AUTO SET Mode for automatic setting of the film speed.</p>	<p>A creative photographic mode that allows control over depth of field and other effects for portraits, souvenir photos, etc. Features automatic exposure compensation for backlit situations.</p>	<p>Useful for situations such as when the main subject is on the edge of the composition in a backlit situation, etc.</p>
TTL Direct "OTF" Light Measuring (center-weighted average metering)	<p>The simple snapshot mode that guarantees good results.</p>	<p>This mode does full justice to the photographer's creative intentions, assuring the full range of control available with conventional high quality 35mm Single Lens Reflex cameras.</p>	<p>This is the sphere of total manual control. Both the aperture and the shutter speed are entirely in the hands of the photographer. In this situation creativity is everything, based on the photographer's own experience and instincts. And when needed, the viewfinder indications are still there to offer helpful suggestions.</p>

SELECTING THE FILM SPEED SETTING MODE

Mode	Mode Selector Dial	Finder Indication	Features
DX ISO AUTO SET			<ol style="list-style-type: none"> 1. If you use film that has the DX code and set the selector dial to this mode, the film speed is set automatically on the camera. (The range of auto settings available is from ISO 25 to 3,200.)
ISO MANUAL SET			<ol style="list-style-type: none"> 1. For when you use film without the DX code. (The range of settings is from ISO 25 to 3,200.) 2. For when you prefer to set a different film speed according to your own experience or preference. 3. For when you plan to use forced or under-developing of the film.
			<ol style="list-style-type: none"> 1. You can make this setting manually according to your own experience in order to prevent darkening of the model's face, etc., in backlit or strong contrast situations. (The exposure compensation range is from -2 to +2 stops, in 1/3 stop increments.) 2. When using a super wide angle lens in situations where the sky unavoidably forms a large part of the composition, it may be useful to set a plus exposure compensation. 3. When using together with ESP Metering mode, exposure compensation set by the ESP Metering system are added to those that are manually set.

■ DX ISO AUTO Film Speed Setting

Film speed information is recorded in the digital pattern imprinted on the cassette of DX type film. The OM-PC reads this information through the electrical contacts located at six positions in the film chamber, and conveys it to the camera's computer. On reading this information, the film speed is automatically set on the camera. In other words, when you turn the OM-PC film speed dial to the DX ISO AUTO SET position, whatever the film speed it is automatically set on the camera. There is no risk of getting a mistaken setting when you change to a different film speed ... a common disaster in the past! When using the DX ISO AUTO setting, first make sure that you are using DX film. Also note that if there is any damage to the digital pattern on the film cassette, this could result in a mistaken film speed setting.

■ ISO Manual Setting

The OM-PC also allows manual setting of the film speed in exactly the same way as previous cameras. Also use this mode at times when you wish to set an exposure compensation on the dial.

■ Exposure compensation

Whether it is in the programmed exposure mode, automatic exposure mode, or manual mode, the OM-PC permits exposure compensation with the exposure compensation dial. (Remember, exposure compensation is not possible in the film speed auto-set mode.) For example, if the background is brighter than the subject (backlighting), turn and set the dial to the (+) side. This will provide more light for the subject.

As you turn the dial, the  sign will blink in the viewfinder and the displayed shutter speed will shift depending on the amount of compensation. The dial can also be set at the intermediate click positions providing accurate 1/3 stop exposure compensations.

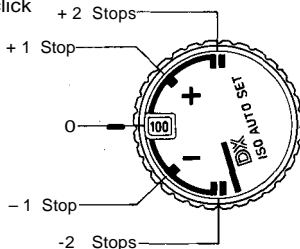

BULB EXPOSURE



If you require long exposure, set the shutter speed dial at "B" (bulb). This is useful for night exposures or other special effects.

* When taking pictures with the shutter speed dial set at "B", it is recommended that you use a tripod and cable release to prevent camera shake.

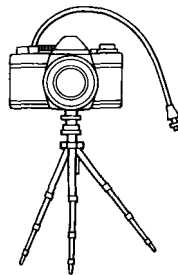

MULTIPLE EXPOSURE

By tripping the shutter several times on the same frame, multiple images are produced on the same frame.

This is how to do:

- ① After the first exposure is ended, erect the rewind crank and turn it clockwise as far as it will go to take up film slack.
- ② While holding both the rewind knob and rewind button with your fingers to prevent them from moving, wind the film advance lever. In fact, the film is not wound and the shutter is cocked by this operation.
- ③ Press the shutter release as you would do normally, and double exposure will occur.
- ④ By repeating the steps ② and ③, the frame will be exposed as many times as you want. However, the frame counter advances each time the shutter release is pressed.
- ⑤ After ending the multiple exposure, put the front lens cap on and make a blind shot.

Note: The frame may shift slightly.

INFRARED PHOTOGRAPHY

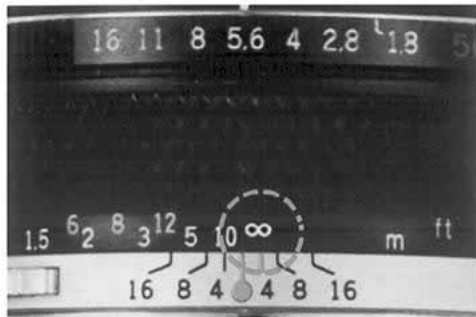

When shooting infrared pictures with infrared film and a red filter, the point of focus will slightly differ if you focus visually. The amount of shift varies with the lens and a red line or red dot is marked on the lens' depth of field scale to compensate for it. First, focus the lens without a red filter on as you would do normally. Next, read that distance on the distance scale and shift it opposite the infrared mark, then put on a red filter and shoot. (The above picture was taken with the distance at infinity.)



Flash Photography



The OM-PC is designed to provide "OTF" Automatic Exposure with Olympus T-Series electronic flashes. There is nothing to set since exposure is determined by the sensors in the camera body itself. You can even adjust exposures using the compensation dial on the camera. Because it directly measures the light at the film plane, it does not allow for flash exposure error utilizing the sensor built into the flash.

Such special techniques as bounce flash, diffused illumination and ultra close-ups can now be accomplished with full automatic ease.

Combined with T-Series flashes, the OM-PC permits flash exposure in three modes: "OTF" programmed exposure mode, "OTF" automatic exposure mode and manual mode.

T-Series Flashes

Electronic flash T20 (small-size flash with a guide number of 20)



Electronic flash T32 (high-capacity flash with a guide number of 32)



* The electronic flash T45 and other flashes that have no direct hot shoe contact cannot be used.

Mounting the Flash



Slide the flash into the camera's accessory shoe and lock it by turning knob until the flash is tight. Make sure the flash is pushed fully forward, to insure proper electrical contact.

* If the flash unit switch is left on, the camera batteries will be drained. Make sure to turn off the flash switch after taking pictures.

How to Use T-Series Flashes

With a T-Series flash on the camera, the flash mode will be automatically set to match the camera's exposure mode. To take pictures in the programmed mode, switch the mode selector dial of the OM-PC to PROGRAM, set the lens' aperture ring to its minimum aperture and turn on the flash. The camera will determine the appropriate aperture depending on the brightness of the subject.

To take pictures in the auto mode, set the mode selector dial to AUTO and choose your desired aperture.

To shoot in the manual mode, switch the camera's mode selector dial to MANUAL and set the shutter speed dial at 1/60 sec. or slower. Select the appropriate aperture based on existing conditions. In MANUAL mode, the flash will always fire at full power output.

* When the power switch of a T-Series flash is turned on in the programmed mode, the camera's exposure mode will switch to the flash program if the light intensity is below the specified level. You will see it because the indicated shutter speed is "8" or slower. In this case, the shutter will trip at 1/60 sec.

* In the "OTF" auto flash mode, T-Series flashes will fire when the shutter speed is 1/60 sec. or slower. If you want to ensure that the flash will fire, however, adjust the aperture so that the shutter speed in the viewfinder becomes 1/30 sec. or slower.

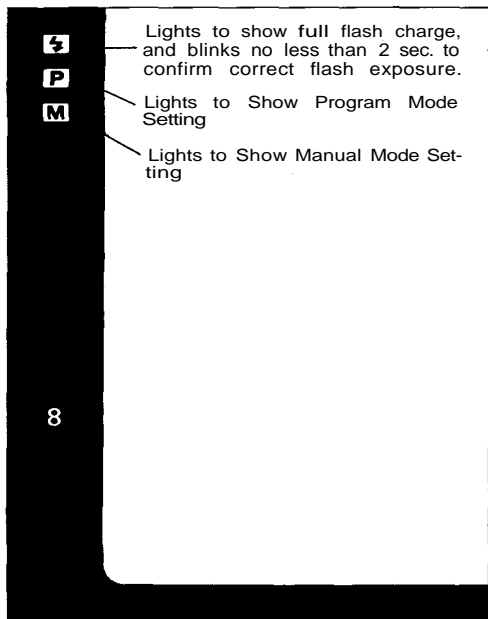

Bounce Flash



The T32 has an adjustable flash head that tilts as much as 90° upward. As it operates on "OTF" auto, it allows you to use bounce flash automatically by simply activating the flash switch.

* Set the tilting angle so that the subject is illuminated by reflected light.



Close-up Flash



On the T32, the flash head also can be adjusted as much as 15° downward. As it operates with all available apertures on "OTF" auto, this feature allows you to take close-ups automatically by simply activating flash switch.



Using Electronic Flashes Other Than Olympus T-Series Units

- (1) Mount the flash on the accessory shoe.

The OM-PC does not accept flash units without direct hot shoe contacts.

- (2) Setting the aperture

If you are using an automatic flash, check the specifications on the flash and set the aperture accordingly.

If you are using a manual flash, determine the required aperture by the following formula. You can also use the flash's calculator panel and set the aperture based on this information.

$$\text{Aperture} = \frac{\text{Flash guide number}}{\text{Flash-to-subject distance}}$$

- (3) Switch the camera's mode selector dial to MANUAL and shoot with a shutter speed of 1/60 sec. or slower.

* Read the instruction manual of your flash carefully.

Shooting with Motor Drive



Shooting with motor drive is both functional and very exciting. It enables you to capture your subject in a critical moment by making several shots in a second.

The high speed OM System motor drive has achieved an extremely compact and lightweight design to take full advantage of operational ease and high maneuverability.

The OM-PC is designed to accept the high-speed Motor Drive 2* as well as the Winder 2. Both offer single-frame exposures and sequential exposures by simply turning a dial.

The OM System's outstanding maneuverability and operability are ideal for shooting dynamic sports photos and documentary press photos.

To shoot on the ESP metering, first activate the viewfinder display by pressing the camera's shutter release softly. The display will remain on for 60 seconds. Then shoot by pressing the Motor Drive's shutter release.

* Up to 3.5 frames a second with OM-PC, OM-2S PROGRAM and up to 5 frames a second with OM-1, OM-2, OM-3, OM-4, OM-G and OM-F.

** When shooting a sequence with Motor Drive, Aperture priority or Manual Mode is recommended. In Program mode, the shutter speed may be slowed depending on the shooting condition.

Motor Drive Group Units

Motor Drive 2. If you want to shoot very fast moving subjects such as a dashing animal or a racing car driving at full speed, the Motor Drive 2 is the best choice because it permits continuous shooting at a maximum speed of 5 frames a second (up to 3.5 frames a second with OM-PC.) This quick shooting capability will often allow you to catch a dramatic instant that would be missed with a slower drive.

The power sources for Motor Drive 2 are a flat-type, rechargeable M.15V Ni-Cd Control Pack 2 and a pistol grip-type replaceable battery powered M.18V Control Grip 2.

Winder 2. The Winder 2 is compactly built and very convenient for shooting. While not as fast as Motor Drive 2, it can help you capture impressive moments such as sports scenes and children at play. The Winder 2 has a self-contained power supply, but two external power units ("AA" battery type) are also available.

Remote Control System In addition, the M. Quartz Remote Controller 1 permits interval shooting with remote control and LCD display. The Remote Cords 1.2m and 5m allow you to shoot away from the camera by simple button operation.



Macrophotography



The world of macrophotography is filled with marvelous discoveries. However, macrophotography has been generally considered difficult technically. In particular, calculations for correct macro exposures in available light photography as well as in flash photography have been a difficult job even for professionals.

Equipped with an "OTF" Light Metering system, the OM-PC has solved this difficult problem and will always provide correct exposure.

The OM Macro System includes a wide choice of macro lenses that offer excellent life-size and larger than life size photographs. Extension units and other components enable you to take hand-held macro shots that previously required a tripod.

Macrophoto Group Units

• Simplified Macro System

These units allow you to take close-ups up to life size with ease.

For example, Close-up lenses 49mm and 55mm (f=40cm) — the 49mm can be used on normal 50mm F 1.8, F 1.4 and F 1.2 standard lenses. You can take up to 0.63X life size close-ups by simply screwing them into the front of the standard lens.

- Auto Extension Tubes 7, 14 and 25. These components are placed between the lens and camera body and available in three thicknesses: 7mm, 14mm and 25mm. Used in combination up to seven variations, they allow you to take up to 1.1 X close-ups with a 50mm lens.

• Basic System

This is a full-scale macro system that permits low to high magnifications. It will produce brilliant images of the marvelous world of tiny things such as the geometric beauty of the compound eye of a dragon fly, or extreme close-ups of flowers. A studio type and a field type are available.

Studio type: This system is suited for taking high-magnification pictures in a studio or other indoor situation.

- **Auto Bellows.** A basic unit that helps you take full advantage of the system's capabilities in combination with various lighting units and mounts for extended magnification ratios.

- **Zuiko Auto Macro 20mm F2.** Large-aperture macro lens designed exclusively for macrophotography. Combined with the Auto Bellows, it permits magnifications ranging from 4.2X to 16X.
- **Zuiko Auto Macro 38mm F2.8.** This lens is designed exclusively for macrophotography and permits magnifications of 2.3X to 6.7X with the Auto Bellows. (Provided with a helicoid for fine focusing.)
- **Macrophoto Stand VST-1.** A compact and sturdy multi-purpose stand for solid camera support in close-up and macrophoto work. Comes with frosted stage glass for incident light.
- **Epi-illuminator PM-LSD2.** A two-piece lighting set which provides ideal reflected light for macrophotography.

Field type: This is a handy and highly maneuverable system which includes various macro lenses and a telescopic extension tube.

- **Telescopic Auto Extension Tube 65 ~ 116.** With its variable tube length, this auto extension tube enables you to change the shooting distance, magnification and angle of view freely. Combined with the Zuiko Macro 80mm F4 and 135mm F4.5, it constitutes a highly maneuverable system suited for outdoor shooting from infinity to 2X life size.
- **Zuiko 1:1 Macro 80mm F4.** This lens is designed exclusively for macrophotography and permits image magnifications of 1/2 ~ 2X.

OTHER SYSTEM UNITS

- **Zuiko Macro 135mm F4.5.** Permits magnifications up to 0.43X with the Telescopic Auto Extension Tube 65 ~ 116. This lens will find wide application because it can also be used as a super sharp 135mm telephoto lens.
- **Zuiko Macro 50mm F3.5.** A convenient lens that can be used not only for close-ups, but also as a standard lens for normal shooting situations.

Interchangeable Lenses: There are lenses to fit every subject, from fisheyes to super telephotos.

Filters: Used to change the color temperature, or for special effects.

Eyecup 1: Attached to the camera eyepiece to prevent stray light spoiling the viewfinder image.

Dioptric Correction Lenses: Used to correct the photographer's own vision. Available in a range from +2 to -5 diopters.

Varimagini Finder: Allows easy, unstrained viewing for low angle shots, copying work, etc. Can be switched between 1.2 and 2.5 magnifications.

Semi-Hard Case: Protects the camera from dust and scratches.

Be sure to get the OM-PC version.



For Longer Service of Your Camera

Handling Care

Take care in handling the camera.

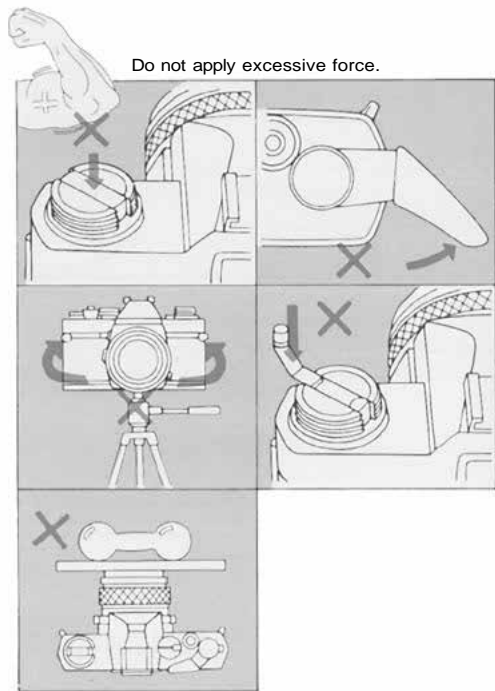
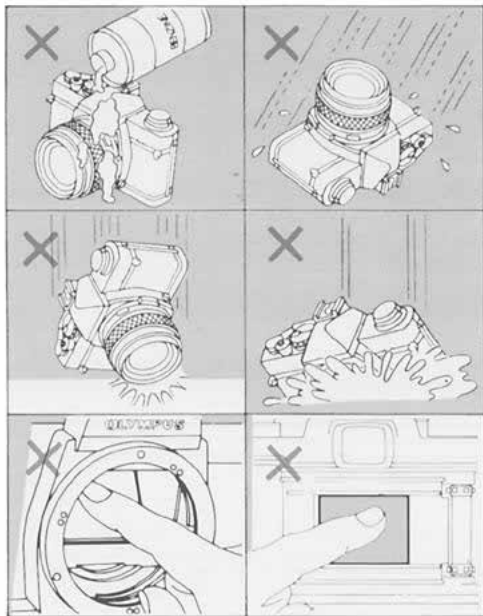

Storage Care

Guard against high temperature and magnetic fields.

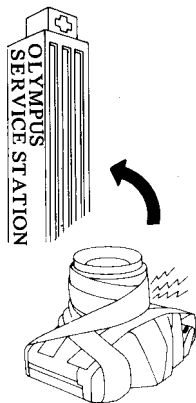

In case of malfunction, take the camera to your nearest Olympus service station.

Battery Precaution

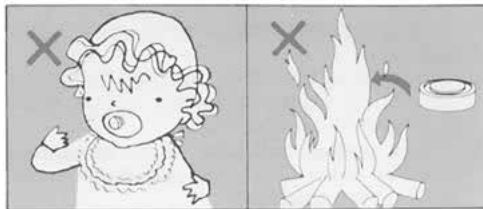

QUESTIONS AND ANSWERS

Q: The film rewind knob does not turn when winding the film, although the camera is loaded with film.

A: This indicates the film is not being wound because it has slipped out of the take-up spool. Load the film correctly again.

Q: A dark shadow "shimmers" in the microprism collar or in the split image rangefinder in the center of the viewfinder.

A: This phenomenon will occur when an interchangeable lens of F5 or slower is used or when the preview button is pressed with the aperture set to F5.6 or smaller. However, there is nothing wrong with the microprism.

Q: The display in the viewfinder turned off while I was looking through the viewfinder.

A: To conserve battery power, it will automatically turn off after 60 seconds. To turn it on again, press the shutter release button lightly.

Q: In the auto mode, the actual shutter speed seems to be slower than the one displayed in the viewfinder.

A: If the shutter is fired in auto mode with no film in the camera, the shutter speed will be slower than that displayed in the viewfinder. This is because the OM-PC uses an "OTF"

Light Metering that measures the light reflected off the film plane. To test the shutter, load an unwanted roll of film that has not been developed or the test card that comes with your camera.

Q: The film rewind crank won't turn.

A: Press in the film rewind button. Do not force the rewind crank.

Q: The film advance lever does not operate. Why?

A: You have wound the film, but you have not yet tripped the shutter. If you depress the shutter release button, you will be able to operate the advance lever. It is also possible that the film has come to its end. If the exposure counter shows the last frame of your film, do not force the lever, but rewind the film back into its cartridge.

Q: The film advance lever does not operate and I see nothing in the viewfinder.

A: The camera is designed to be switched off for safety when the batteries are exhausted. If the audible and visual signals do not function when you rotate the mode selector dial to the "BATTERY CHECK" position, be sure to replace both batteries.

Q: When must the batteries be checked?

A: (1) When new batteries are inserted into the camera, (2) when you are using the camera after it hasn't been used for a long time, (3) when you think the batteries may be worn out, and (4) when the temperature is extremely low.

(If the battery voltage is low, the shutter may not fire when using the self-timer; even if the batteries check out OK.)

Q: What type of batteries should I buy?

A: Buy two SR44 silver-oxide batteries or LR44 alkaline batteries. Do not use HR44 mercury batteries or two different types of batteries of the same size, or mix an old battery with a new battery.

Always replace both batteries at the same time.

Q: How long do the batteries last?

A: Generally, SR44 batteries will last about one year and LR44 batteries about six months.

Q: The batteries seem to have been worn out while I was shooting in cold weather. What can I then do to take pictures?

A: Bring them to room temperature by keeping the camera inside your coat close to your body. They may recover and allow you to resume shooting. Never heat batteries with an electrical appliance or other device.

Q: I took my picture at an intermediate point between two aperture numbers.

A: No problem. Your picture is correctly exposed.

Q: In the manual mode, I took my picture at an intermediate shutter speed.

A: Intermediate shutter speeds cannot be used. If you have set the shutter speed dial at an intermediate position, the shutter will fire at either of its neighboring shutter speeds.

Q: I want to take macro pictures with flash in the programmed mode. Is it possible?

A: The programmed mode tends to give a larger aperture, causing the picture to turn out overexposed or not have enough depth of field. It is recommended, therefore, to use the aperture-preferred "OTF" auto flash mode for macro shots.

Q: In the program mode, "1000" and  blink even with the lens set at its minimum aperture.

A: This indicates overexposure with a lens having less than five aperture stops. In this case, use an ND filter suited or a slower film.

Q: In the program mode, it seems that the shutter speed displayed in the viewfinder differs from the actual shutter speed.

A: When using a 50mm F1.2, 50mm F1.4, 75 ~ 150mm ZOOM or 35 ~ 105mm ZOOM lens, the shutter speed displayed in the viewfinder can differ from the actual one; but by approximately less than one stop. However, correct exposure is always insured.

Q: Are there any lenses that cannot be used?

A: The 1000mm F11 lens cannot be used. The following three lenses cannot be used in the programmed mode. Use them in the aperture-preferred auto mode or manual.

250mm F2, 350mm F2.8, 600mm F6.5

Q: My pictures tend to be overexposed when shooting transparencies with flash in the programmed mode.

A: In this case, the pictures may turn out overexposed depending on the shooting conditions. Use the aperture-preferred auto mode and stop down the aperture.

Q: The shutter speed display and ESP mark  sometimes blink during metering.

A: In the case of a subject with an intermediate luminance, the LED shutter speed display will apparently blink because the adjacent figures turn on alternately. When shooting under a fluorescent lamp, they may blink more frequently. The reason of this phenomenon is as

follows: Though the fluorescent lamp appears to the human eye as if it were lighting continuously, it is in fact blinking repeatedly at a frequency of 50 — 60 cycles a second. In both cases, however, exposure is correct and there is no problem at all.

Q: The flash does not fire.

A: The flash will not fire when the shutter speed is faster than 1/60 sec.

Q: The shutter release button cannot be depressed.

A: You may not have wound the film properly, or the film may have come to its end.

Q: Though the audible and visual signals do not turn on when checking the batteries, the viewfinder display appears faintly.

A: If the battery voltage is extremely low, the LED for viewfinder display may sometimes turn on because the camera circuit allows it.

Q: Even when I gently push down the shutter button, the viewfinder display doesn't come on.

A: Check the batteries by turning the Exposure mode selector dial to the CHECK position. If the batteries are all right, you have probably set the camera to the "B" (Bulb) position on the shutter speed dial. On "B" the finder display does not light.

Q: The mirror does not spring back.

A: Check the batteries. If the batteries are in good condition, and in case the mirror should not spring back or the shutter should not close, the safety mechanism will operate to return them to their original position.

Q: The  mark does not turn on when the picture is composed with the sun in a corner of the picture frame.

A: If the sun is located in a corner of the picture frame, exposure correction with the ESP metering is not effected. Because the four corners of the picture frame have a reduced metering sensitivity, the ESP metering need not be operated.

Other cautions

- When the OM-PC is used with other brand lenses, Olympus can not assume any responsibility for poor image quality or other problems. This is particularly true when other brand lenses are used in PROGRAM mode.
- The exposure value will shift on spot metering with a linear polarizing filter. In this case, use a circular polarizing filter.
- If the exposure mode is switched while the self-timer is running, the shutter will trip.
- The DX ISO auto-setting is not effective when the ISO speed window shows a number "800" or larger. First, set it at "640" or smaller then adjust for ISO auto setting.
- If you are not likely to use the camera for a long time, remove the batteries before putting it away.
- The batteries that come with your camera may not last so long as stated in the camera specifications because they are supplied for test at the time of purchase.

Description of Controls

Self-Timer/Battery
Check Signal

Light Metering Mode
Selector Lever

Shoulder Strap Eyelet



Lens

Lens Release Button

Depth of Field Scale

Aperture Ring

Focusing Ring

Preview Button



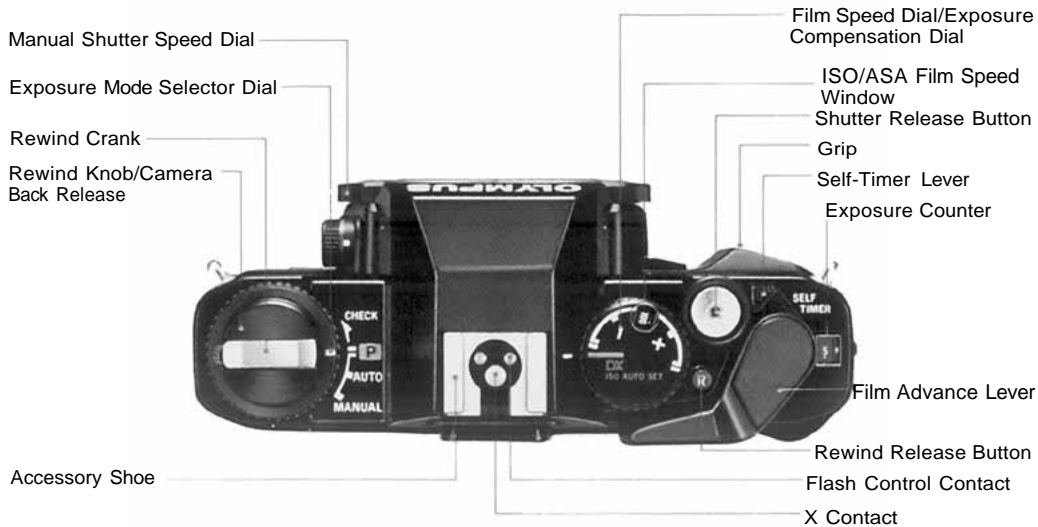

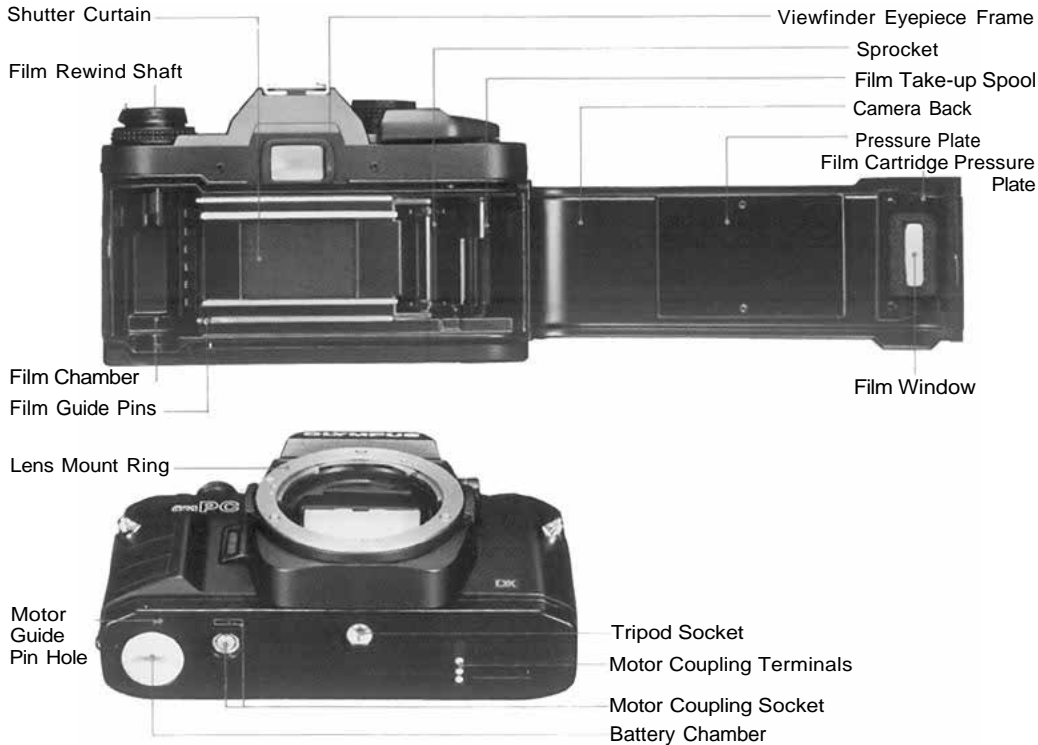

SPECIFICATIONS

Type: TTL auto-exposure 35mm SLR camera.

Film Format: 24mm × 36mm.

Lens Mount: Olympus OM Mount.

Shutter: Horizontal running electronic control type focal plane shutter with automatic exposure controls from 2 sec. to 1/1000 sec.

Synchronization: X contact. Hot shoe with direct contact for OM T-Series electronic flash units.

Metering System: ESP (Electro-Selective Pattern) Metering and TTL Direct "off-the-film" Light Metering (center-weighted averaged metering).

Programmed Automatic Exposure: Type; Electronic shutter with automatic settings of aperture and shutter speed. Light measuring range; 2—1/1000 sec. (with ISO 100 film and 50mm F1.4 lens). EV 0—18.

Aperture-Preferred Automatic Exposure: Type; Automatic exposure control with aperture-preferred electronic shutter. Light measuring range: 2-1/1000 sec. (with ISO 100 film and 50mm F1.4 lens). EV 0—18.

Manual Exposure: B, 1—1/1000 sec.

Auto Flash Exposure: Choice of "OTF" Auto Flash or "OTF" Program Flash. Direct contacts for "OTF" Auto Flash. (Full automatic flash with T-Series Flash); Automatic shutter speed setting for flash exposures.

Exposure Compensation: ±2 EV in 1/3 stop increments.

Film Speed: ISO 25-3200. Selection of automatic setting for DX coded films or manual setting.

Film Advance: Film advance lever with 130° angle for one long or several short strokes and pre-advance angle 30°. Motor drive and winder usable.

Film Rewind: Rewind crank.

Viewfinder: Pentaprism eye-level type. Wide field finder with bright Lumi-Micron Matte focussing screen with central microprism/split image range-finder. Finder view-field: 93% of actual picture field. Finder magnification: 0.92X with 50mm lens at infinity.

Viewfinder Information: LED multi-mode display (1 min. limiter).

Self-timer: 12 second delay electronic self-timer. Setting by lever. Automatically cancelled by film advance. Audio-visual LED and PCV indications.

Battery Check: 3-level display with LED and alarm sound.

Camera Back: Non-detachable, with window for reading DX coded film information.

Grip: Large elastic grip on front and rear of camera with non-slip texture.

Power Source: Two 1.5V silver oxide (SR44) batteries or alkaline-manganese (LR44) batteries.

Dimensions: 135.5x86x53mm (5.33"x3.39"x2.09") (Body only).

Weight: 460 g. (16.2 oz.) (Body only).

OLYMPUS®

OLYMPUS OPTICAL CO.,LTD.

San-Ei Building, 22-2, Nishi Shinjuku 1-chome, Shinjuku-ku Tokyo, Japan. Tel. 03-340-2211

OLYMPUS CORPORATION

Crossways Park, Woodbury, New York 11797, U.S.A. Tel. 516-364-3000

OLYMPUS OPTICAL CO.(EUROPA) GMBH

Postfach 104908, Wendenstrasse 14-16, 2 Hamburg 1, West Germany. Tel: 040-23773-0

OLYMPUS OPTICAL CO. (U.K.) LTD.

2-8 Honduras Street, London EC1Y 0TX, England. Tel. 01-253-2772