



OLYMPUS  
**M-1**

# OLYMPUS M-1 THE SECOND-GENERATION SLR

The Olympus M-1 is what happens when an entirely fresh concept in 35mm SLR system photography is backed up by one of the world's leading all-round optical manufacturers.

The freshness lies in the new basic approach to the design, function and inter-relation of each part of the camera and of each unit of the 280-piece system.

The back-up comes from over half a century of Olympus technology encompassing the whole sphere of high grade optical equipment, such as microscopes and medical equipment, where precision is a matter of microns.

The result is a landmark on the photographic scene. An attractive-looking, top performance camera to answer every need of the most demanding professional, yet with a lightness, compactness and ease of operation that set new standards in the camera maker's art.

In fact, the finely engineered insides of the M-1 take up about a third less volume than you might expect, giving overall external dimensions of 136 x 83 x 81mm (5.4 x 3.3 x 3.2 in.), and, with a standard F1.8 lens attached, total weight is a mere 660 grams (23.3 oz.).

This drastic miniaturization was made possible by 5 years of research into design & function, remorselessly trimming off useless bulk while scrupulously maintaining, or even increasing, essential structural features. The M-1 solves three of the most annoying SLR problems; weight, size and noise level. Noise level is cut to half or even less with 20 special noise reducing devices on the shutter and mirror system.

Prime attention has been given to ruggedness and durability in the M-1, with thorough testing of every part down to the smallest spring and screw. Special materials are used unsparingly, for instance to reduce wear in moving parts of the shutter mechanism and to insure smooth ball-bearing function over a wide temperature range. The lens mount is of extremely tough and long-lasting stainless steel.

Final proof of reliability is provided by the rigorous 100,000-time testing of the camera's vital shutter, winding and mirror mechanisms at temperatures from  $-20^{\circ}\text{C}$  to  $+50^{\circ}\text{C}$ .

In addition to being the most comprehensive 35mm photographic system ever, the System features the same compactness, lightness and ease of handling as the M-1 itself. It boasts some 30 lenses of impeccable quality from 8mm fisheye to 1,000mm telephoto, including world firsts such as a 24mm F2 super wide-angle lens and a full set of four macro lenses.

There is a compact, lightweight motor drive system offering speeds up to 4 frames per second. There are also close-up, macrophoto and photomicro systems, all completely compatible.

The M-1 and the System set new standards in 35mm photography, by realizing the traditional Olympus standard of excellence.

Die Bezeichnung M-1 wird aus warenzeichenrechtlichen Gründen geändert.

The name M-1 will be changed due to trade mark registration reasons.

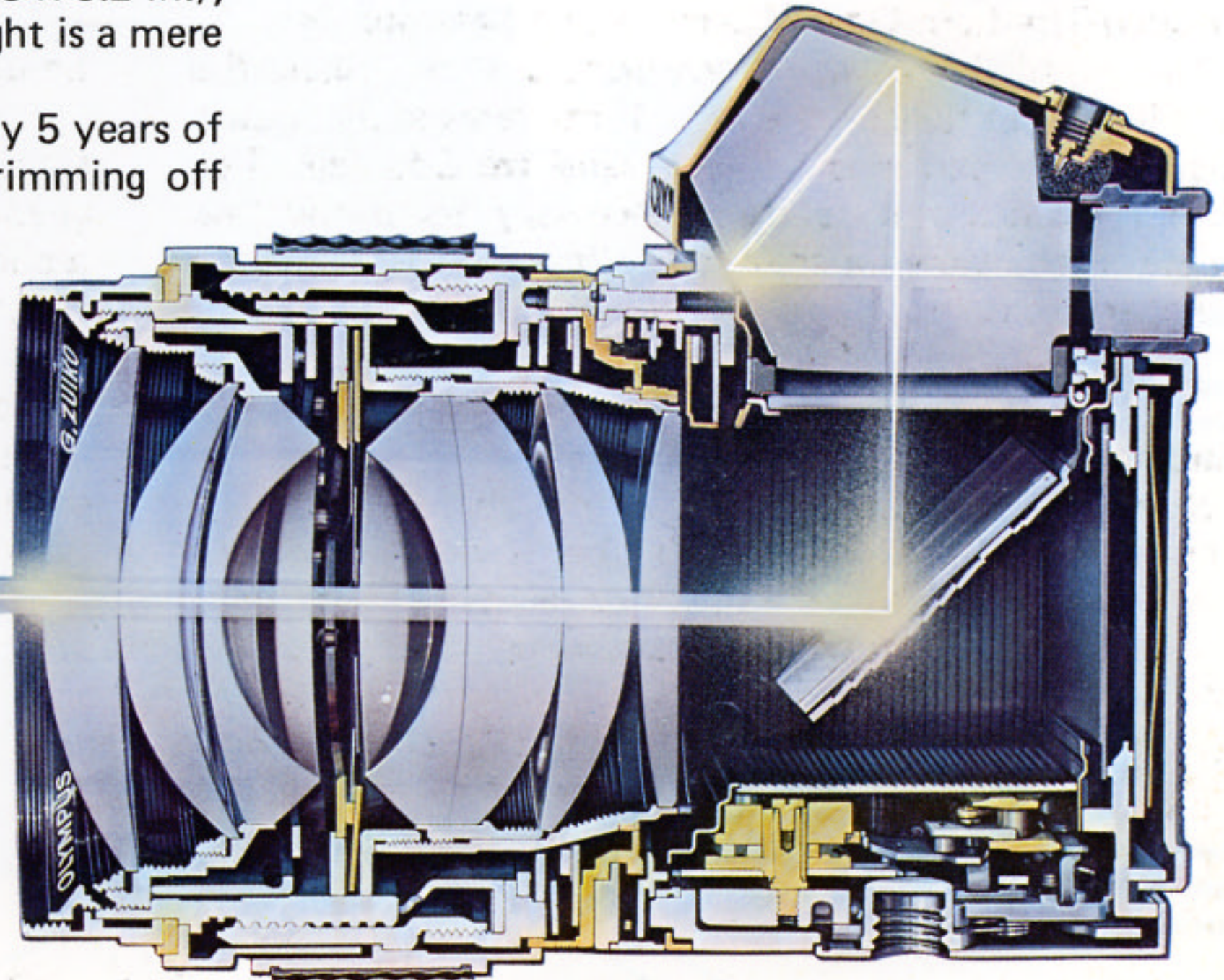

CAMERA CRAFT LTD.  
146, GREEN LANES,  
PALMERS GREEN, N.13.  
TEL: 01-886-887/9

# FEATURES

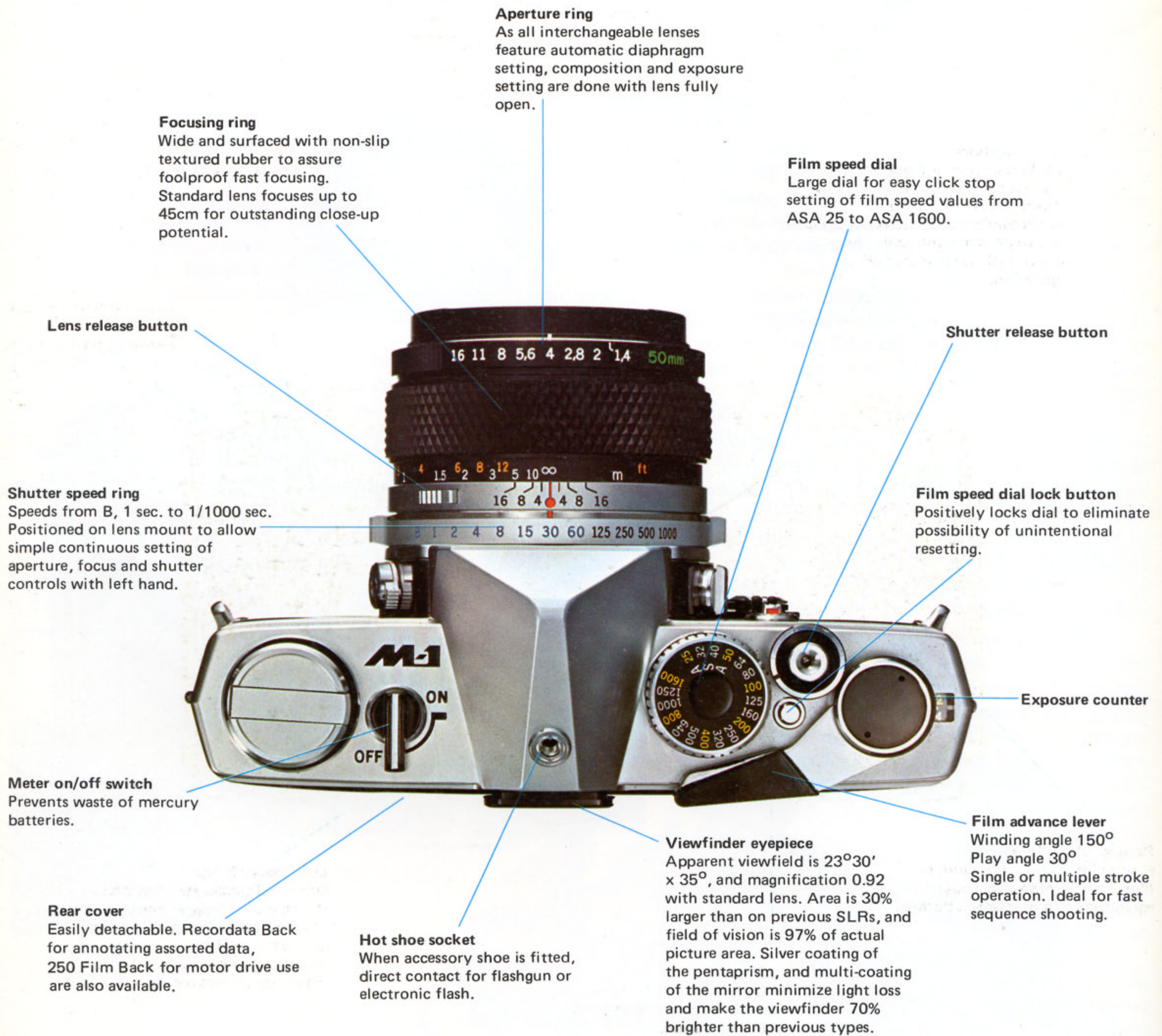

## Main Specifications

System:	OLYMPUS SYSTEM consisting of about 280 units.	Focusing Screen:	Interchangeable. Standard type focusing screen 1-1 (micromatte type), 12 kinds available.
Unit Type:	35mm Single-Lens Reflex focal plane shutter camera.	Finder View Field:	97% of actual picture field.
Picture Size:	24 x 36mm	Viewfinder Magnification:	0.92X at infinity with 50mm standard lens.
Lens:	Closest focusing distance 45cm with all standard lenses. 50mm F1.8 F. Zuiko Auto-S, 6 elements in 5 groups. 50mm F1.4 G. Zuiko Auto-S, 7 elements in 6 groups. 55mm F1.2 G. Zuiko Auto-S, 7 elements in 6 groups.	Apparent View Field:	23°30' by 35°
Lens Mount:	OLYMPUS M mount, bayonet type (46mm flange back, 70°-arc).	Reflex Mirror:	Large, shockless quick return mirror, Lock-up type.
Shutter:	Focal plane shutter, mount dial type, B, 1-1/1000 sec.	Loading:	OLYMPUS easy loading type.
Flash Synchronization:	X and FP contacts with switch.	Film advance:	Film advance lever in a single stroke (150°-arc with 30° play) or multiple short strokes. Self-cocking to prevent double advance and double exposure.
Viewfinder:	Pentaprism type wide-vision finder, focusing screen interchangeable, meter needle is visible in viewfinder.		

# OF THE M-1

## Pentaprism housing

Rational design makes the housing far smaller and silver coating makes the optics brighter than conventional pentaprisms.

## Mirror-up lever

Locks mirror in 'up' position to prevent shock while taking shallow depth-of-field pictures as in photomicro and macrophotography, and to prevent continuous shock during high-speed motor drive operation.

## Rewind crank

Large size for easy handling.

## X and FP flash terminal

X, FP terminal for electronic flash or bulbs

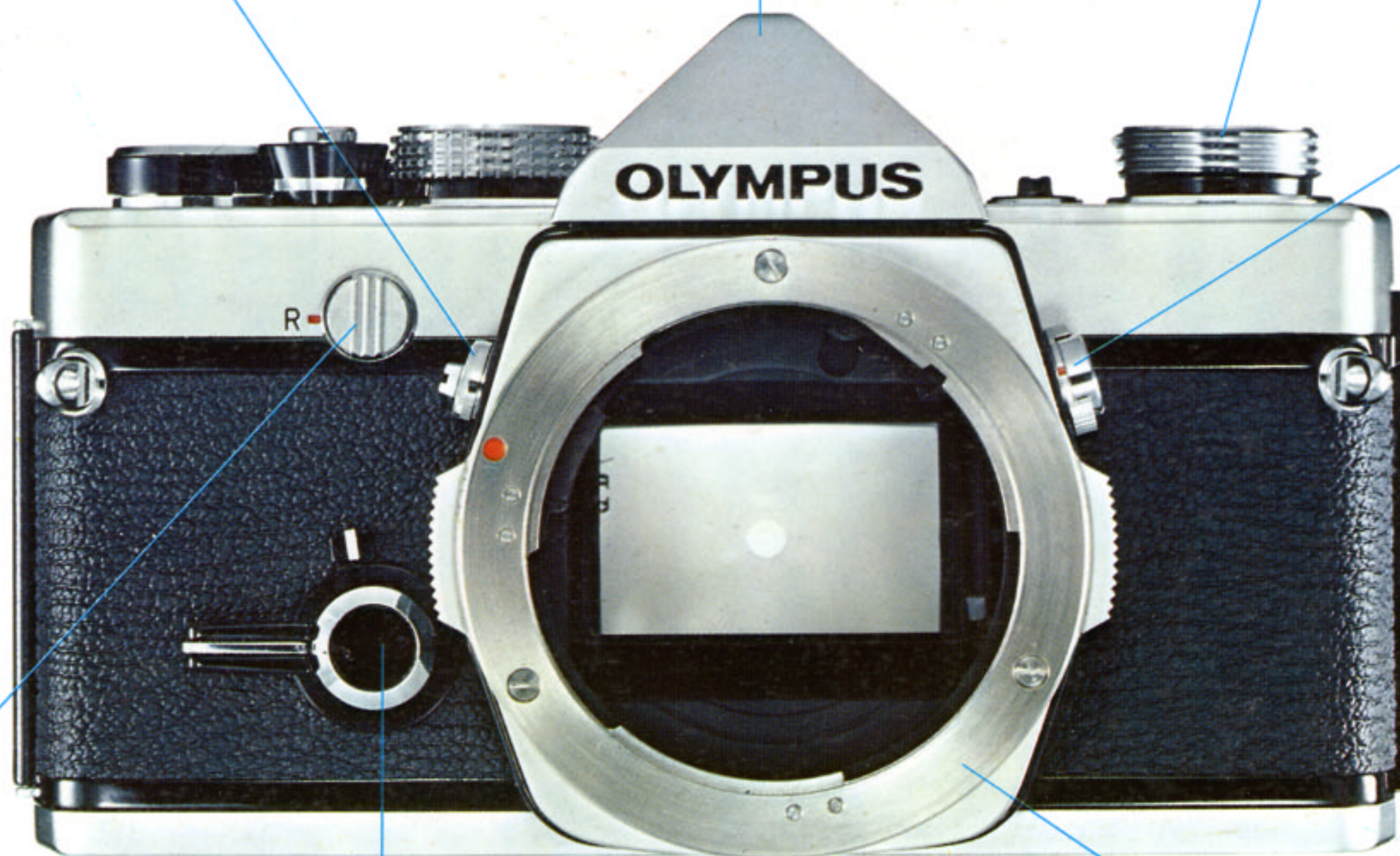

## Rewind release lever

Positioning on the front permits film changing even with copying equipment or motor drive attached.

## Self-timer

Delay from 4 to 12 seconds. Can be stopped or reset freely during operation.

## Lens mount flange

Of wide diameter stainless steel allowing use of bigger mirror. This cuts down internal flare and gives a better viewfinder image. Extra-tough interchangeable lens mount guarantees permanent tight fit.

Exposure Counter: Progressive and automatic reset type.  
Film Rewinding: Rewind crank and aut. reset type rewind release lever.  
Exposure Measurement: Through-the-lens open aperture light measuring method (2 CdS built in), needle setting in viewfinder. ON/OFF exposure meter switch. Automatic warning mechanism incorporated against insufficient brightness and switch-off.  
Light Measuring Range: EV2-17 (ASA 100 with F1.4 standard lens).  
Battery: 1.3-volt mercury battery 1 pc. (Eveready E625, Mallory RM625-R, GE No. 625 or equivalent).

Film Speed Scale: ASA 25-1600 with lock button.  
Self-Timer: Lever type 180 -arc, about 12 sec. delay. Adjustable over 4 sec. Stopped and reset by counter-rotating.  
Rear Cover: "Magic" locking hinge type. Interchangeable with Recordata Back and 250-Film Back.  
Hot Shoe Socket: Olympus hot shoe (optional) attachable.  
Filter Size: 49mm screw-in type for F1.8 and F1.4. 55mm for F1.2 standard lens.  
Size and Weight: (with F1.8 standard lens) 136 x 83 x 81mm 660gr. (with F1.4 standard lens) 136 x 83 x 86mm 720gr. (with F1.2 standard lens) 136 x 83 x 97mm 800gr. (Body only) 136 x 83 x 50mm 490gr.

# DESIGN HIGHLIGHTS

## Interchangeable Focusing Screens

A choice of focusing screens greatly increases the versatility of a photographic system. The M-1 uses a new, straightforward method to change the focusing screen by taking it out from the front of the camera. It eliminates the troublesome and expensive pentaprism replacement system.

The System range of 12 different focusing screens fully meets the requirements of telephotography, macrophotography, photomicrography, etc.

(Illustration: Focusing screen release bar. Focusing screen frame. Focusing screen.)



## Through-The-Lens Open Aperture Light Measuring

This sophisticated light measuring system utilizes the same light that falls on the film. It operates at maximum lens aperture and uses 2 highly sensitive CdS cells. For correct exposure it is only necessary to center the needle in the viewfinder by adjusting the shutter speed and aperture rings.

## Shutter and Mirror

Noise and vibration are little more than half that of conventional SLRs thanks to the four ball bearing shutter mechanism. A newly developed lightweight curtain drum cuts down noise and acts as an air damper for the shutter and mirror mechanisms, further reducing

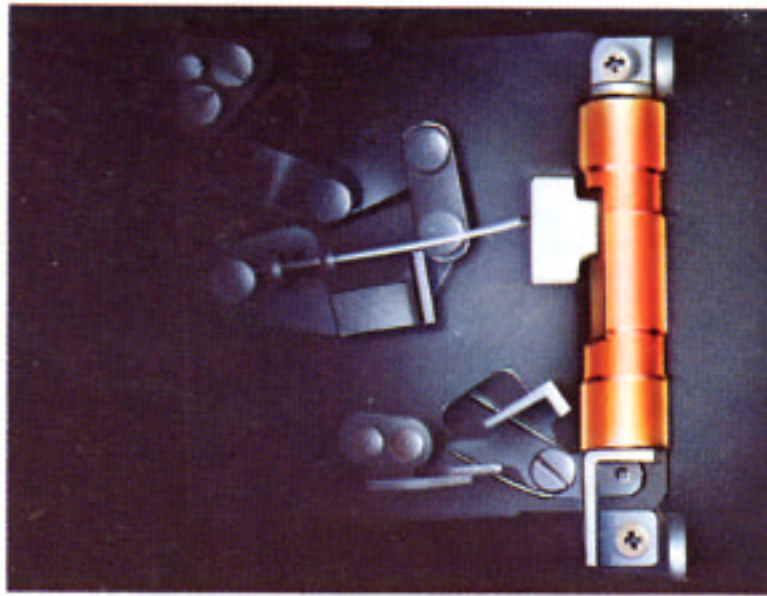

noise and vibration while increasing durability. The outstandingly large mirror gives a full image field with any lens from 8mm fisheye to 800mm super telephoto.

## Size and Weight

The Olympus M-1 is concrete proof that a camera can deliver top performance without being a burden to carry around. By making use of the most modern knowledge and materials, Olympus designers have done an eye-opening job of weight-paring, and far from sacrificing either quality or versatility, in many respects they have improved on both. This can be seen by the fact that while economizing on size and weight wherever practicable, they have never allowed this to diminish ease of operation or performance. Some parts have actually been made larger than their conventional counterparts in order to maximize performance.

With an F1.8 lens the M-1 measures 136 x 83 x 81mm (5.4 x 3.3 x 3.2 in.), and weighs 660 grams (23.3 oz.), a reduction in size and weight of about 35% compared to conventional SLRs.

## Lenses

Every lens in the system features superb resolution, light weight and small size. The sharp resolution is guaranteed by Olympus experience in precision optical technology and design, while ample attention is paid to functionality and easy operation as well as to minimizing size and weight.

For example the 100mm lens is about the same size as a conventional standard lens, but far from this meaning a drop in quality, if anything it is even improved.

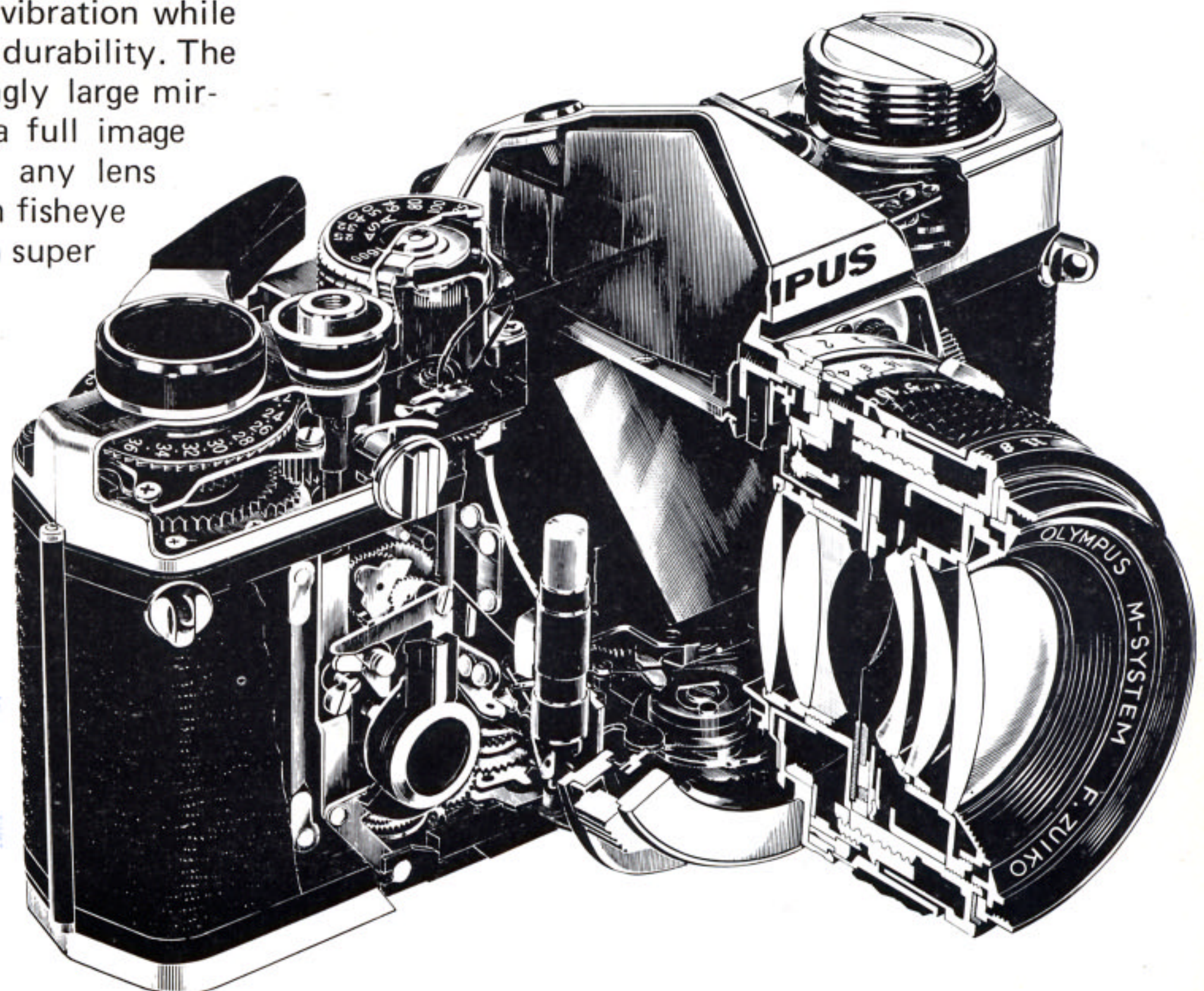

Focusing Screen

Group

50mm  
Macro  
36mm F5.5  
1:1 Macro  
80mm F4  
Macro  
135mm  
Enlarging  
Lens

Spec  
Use

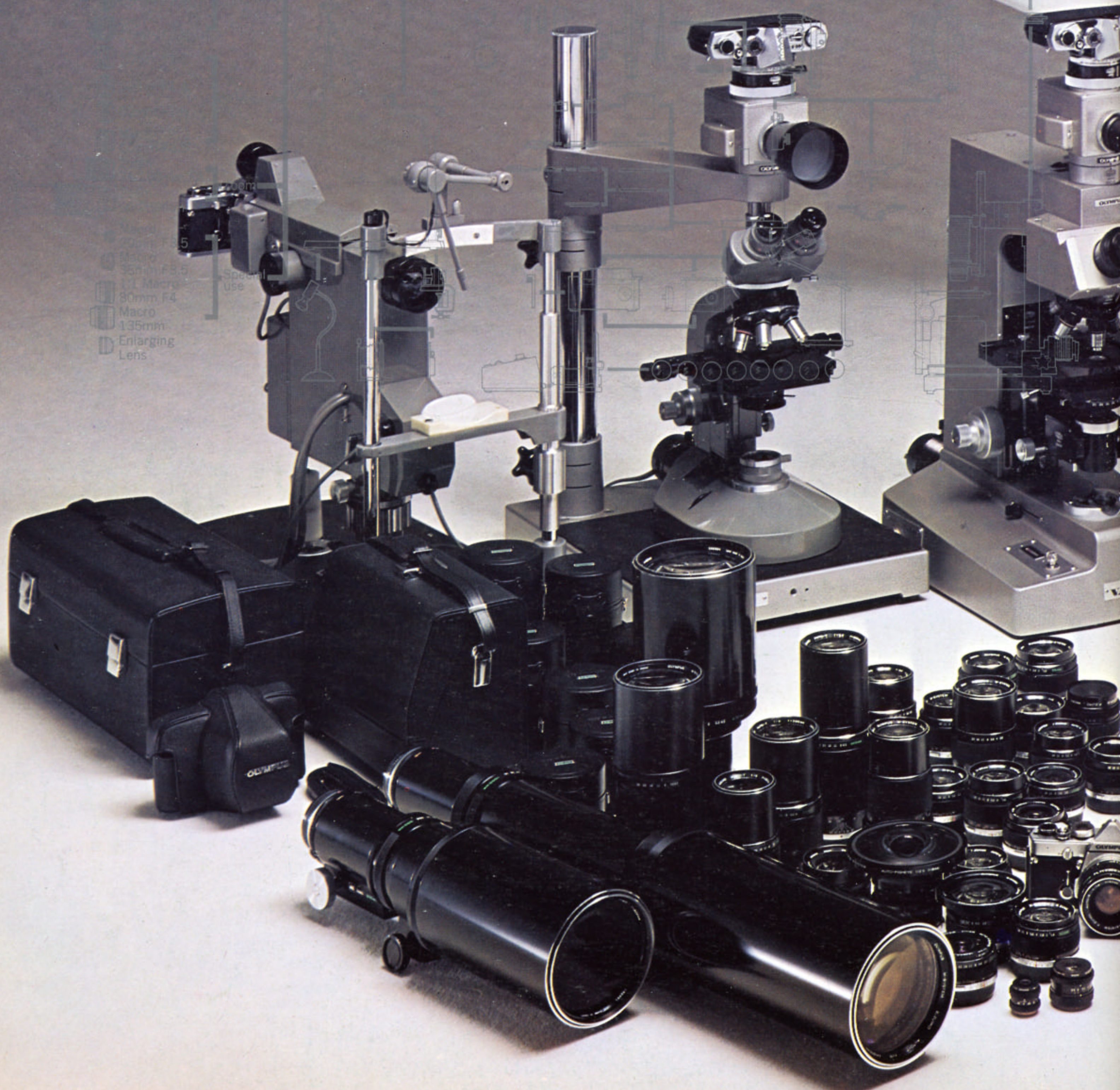

EPIC ACCOMPLISHMENT IN ITS FIELD

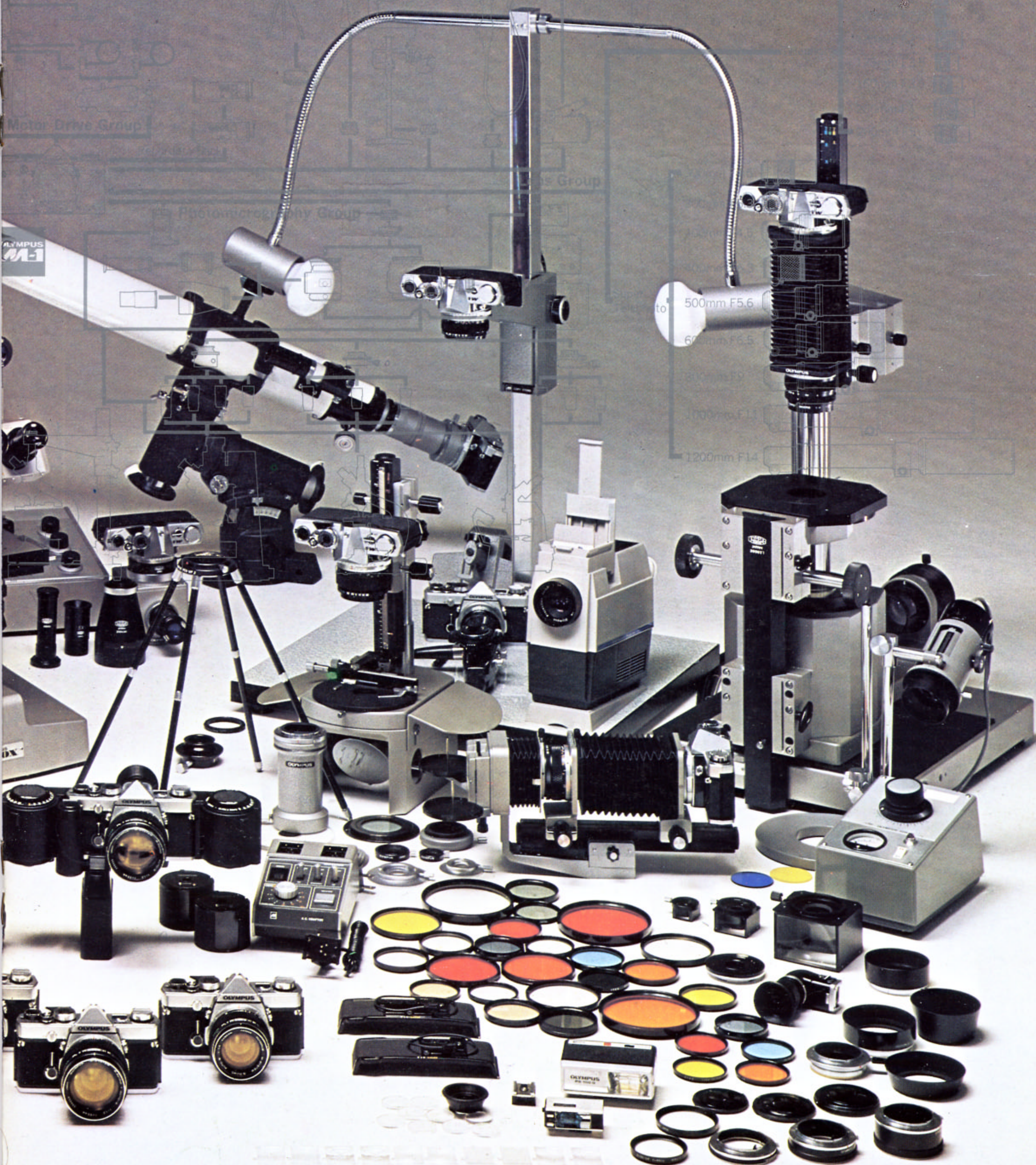

OLYMPUS  
M-1

to 500mm F5.6  
60mm F6.5

1200mm F14

OLYMPUS  
M-1

## The Photomicrography Group

In photomicrography Olympus blends two of its main specialties, cameras and microscopes. A unique photomicrography stand for vibration-free use at high magnifications is one of twenty odd units designed for use with a wide variety of Olympus microscopes. This group has an important role in scientific and industrial research work.

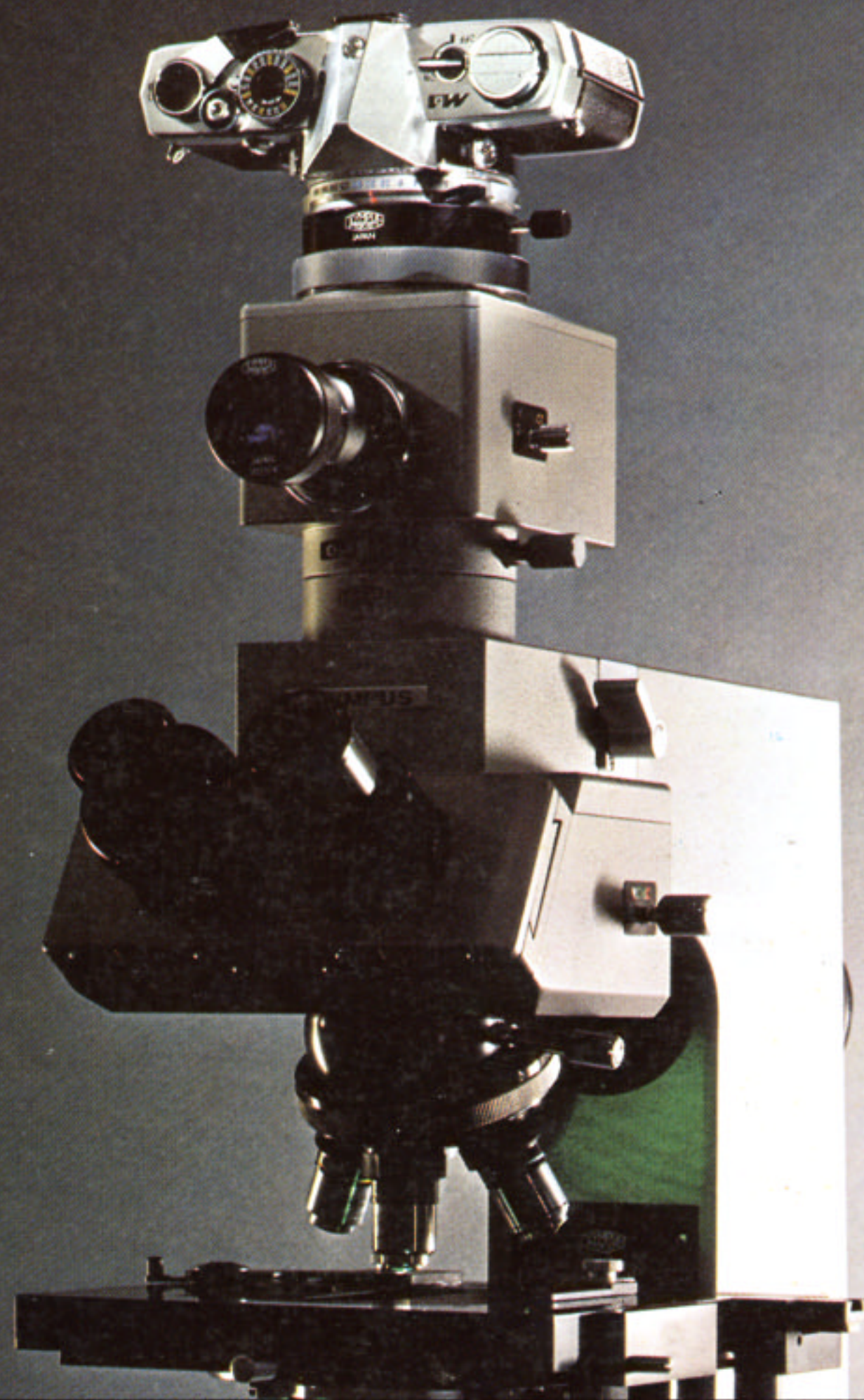

## The System Is Made

### The Lens Group

A generous range of fully automatic diaphragm lenses from 8mm fisheye to 1000mm super telephoto, including zoom. An Olympus pioneered selection of 4 macro lenses and a shift lens is also available. The optical pre-eminence of these lenses is supplemented by their small size, lightness and ease of handling.



## The Motor Drive Group

Every unit is light and compact enough to give hand-held maneuverability even in combination with telephoto lenses. Speed ranges from one frame in 3 seconds to 4 frames per second, with single frame advance also possible.



## The Close-Up Photography Group

This 14 unit group includes focusing rail, bayonet type extension tubes and rings, full-scale and portable copy stands, light sources, illuminators and other close-up equipment.

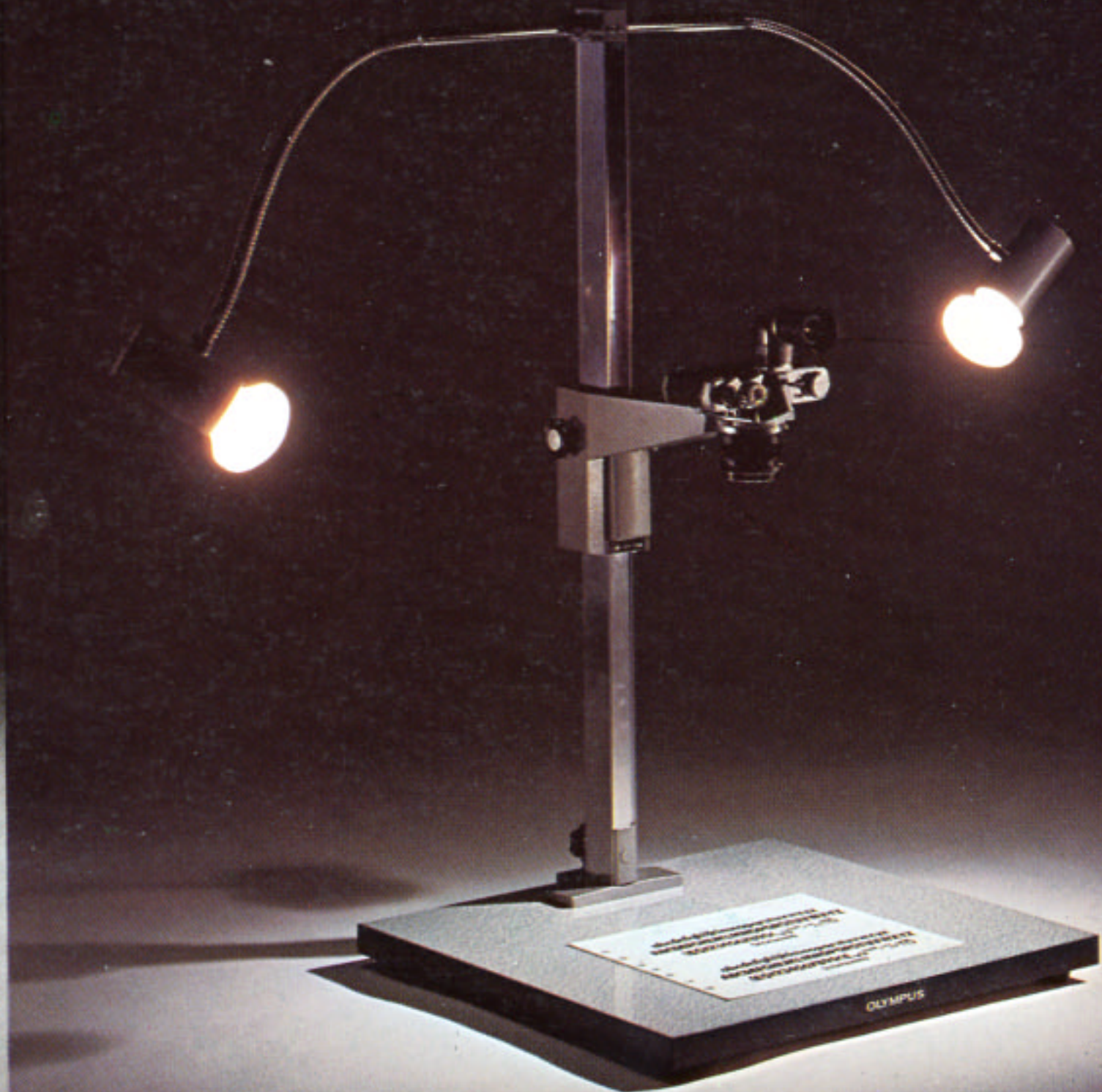



# Up of 5 Main Groups



## The Macrophotography Group

4 new macro lenses including the unique 1:1 reproduction ratio 80mm, plus auto bellows, filters, interchangeable focusing screens, slide copier, a newly developed varimagnifier for pinpoint focusing, etc., to explore the fascinating world of the barely seen.

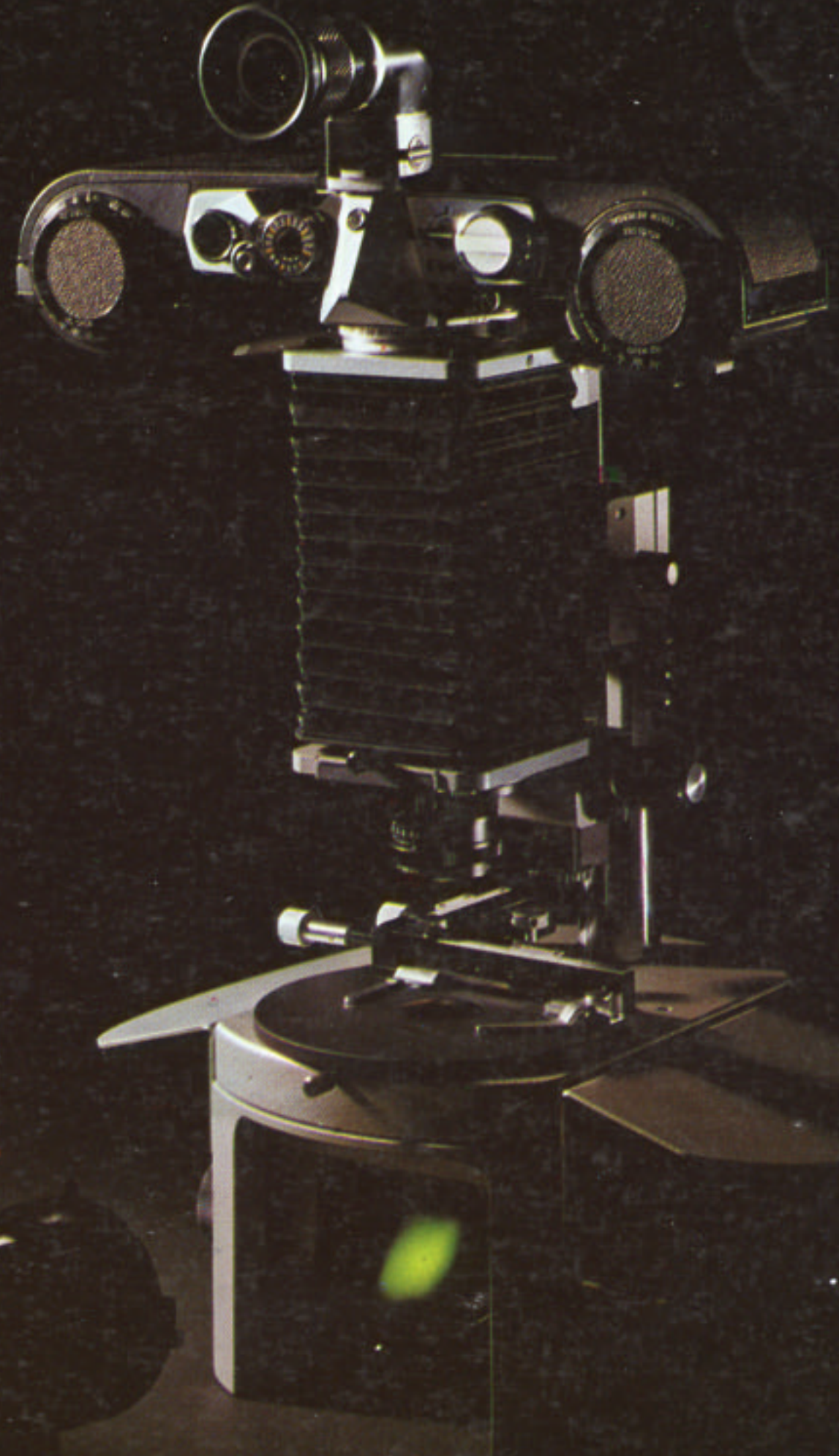

### Olympus System Interchangeable Lenses

Type	Interchangeable lenses	Angle of view	Lens Component element group	Diaphragm	F-stop Range	Min. Focus	Field size	Weight	Length	Max. diameter	Hood	Filter
Fisheye	Zuiko Auto-Fisheye 8mm F2.8	180°	11 - 7	Automatic	2.8 - 22	0.2 m		690g	72mm	102mm	-	Built-in
	Zuiko Auto-Fisheye 16mm F3.5	180°	11 - 8	Automatic	3.5 - 22	0.2 m		170g	28mm	59mm	-	Built-in
Super Wide	L Zuiko Auto-W 18mm F3.5	100°	12 - 10	Automatic	3.5 - 16	0.2 m	21 x 14cm	250g	42mm	75mm	Screw-in	72mm
	H Zuiko Auto-W 21mm F3.5	92°	7 - 7	Automatic	3.5 - 16	0.2 m	21 x 14cm	170g	31mm	59mm	Screw-in	49mm
	J Zuiko Auto-W 24mm F2	83°	10 - 8	Automatic	2 - 16	0.25m	23 x 15cm	250g	49mm	60mm	Screw-in	55mm
	I Zuiko Auto-W 24mm F2.8	83°	8 - 7	Automatic	2.8 - 16	0.25m	23 x 15cm	180g	36mm	60mm	Screw-in	49mm
Wide	J Zuiko Auto-W 28mm F2	75°	10 - 8	Automatic	2 - 16	0.3 m	27 x 18cm	250g	43mm	60mm	Screw-in	49mm
	G Zuiko Auto-W 28mm F3.5	75°	7 - 7	Automatic	3.5 - 16	0.3 m	27 x 18cm	160g	31mm	59mm	Screw-in	49mm
	H Zuiko Auto-W 35mm F2	63°	8 - 7	Automatic	2 - 16	0.3 m	21 x 14cm	230g	42mm	60mm	Screw-in	55mm
	G Zuiko Auto-W 35mm F2.8	63°	7 - 6	Automatic	2.8 - 16	0.3 m	21 x 14cm	170g	33mm	59mm	Slip-on	49mm
Standard	G Zuiko Auto-S 55mm F1.2	43°	7 - 6	Automatic	1.2 - 16	0.45m	23 x 15cm	310g	47mm	65mm	Slip-on	55mm
	G Zuiko Auto-S 50mm F1.4	47°	7 - 6	Automatic	1.4 - 16	0.45m	24 x 16cm	230g	36mm	60mm	Slip-on	49mm
	F Zuiko Auto-S 50mm F1.8	47°	6 - 5	Automatic	1.8 - 16	0.45m	24 x 16cm	170g	31mm	59mm	Slip-on	49mm
Zoom	Zuiko Auto-Zoom 75 - 150mm F4	32° - 16°	15 - 11	Automatic	4 - 22	1.6 m	36 x 24cm 74 x 49cm	400g	115mm	63mm	Built-in	49mm
Telephoto	G Zuiko Auto-T 85mm F2	29°	6 - 4	Automatic	2 - 16	0.85m	29 x 19cm	230g	47mm	60mm	Screw-in	49mm
	E Zuiko Auto-T 100mm F2.8	24°	5 - 5	Automatic	2.8 - 22	1 m	29 x 19cm	230g	48mm	60mm	Screw-in	49mm
	E Zuiko Auto-T 135mm F2.8	18°	5 - 5	Automatic	2.8 - 22	1.5 m	32 x 21cm	350g	80mm	61mm	Built-in	55mm
	E Zuiko Auto-T 135mm F3.5	18°	5 - 4	Automatic	3.5 - 22	1.5 m	32 x 21cm	280g	73mm	60mm	Built-in	49mm
	E Zuiko Auto-T 200mm F4	12°	5 - 4	Automatic	4 - 32	2.5 m	36 x 24cm	490g	127mm	67mm	Built-in	55mm
	F Zuiko Auto-T 250mm F5	12°	6 - 5	Automatic	5 - 32	2.5 m	36 x 24cm	360g	105mm	63mm	Built-in	49mm
Super Telephoto	F Zuiko Auto-T 300mm F4.5	8°	6 - 4	Automatic	4.5 - 32	3.5 m	33 x 22cm	1,000g	181mm	80mm	Built-in	72mm
	F Zuiko Auto-T 300mm F6.3	8°	6 - 5	Automatic	6.3 - 32	3.5 m	33 x 22cm	600g	171mm	70mm	Built-in	55mm
	F Zuiko Auto-T 400mm F4.5	6°	6 - 4	Automatic	4.5 - 32	5 m	35 x 23cm	2,200g	257mm	110mm	Built-in	100mm
	F Zuiko Auto-T 600mm F6.5	4°	6 - 4	Automatic	6.5 - 32	11 m	54 x 36cm	2,800g	377mm	110mm	Built-in	100mm
	E Zuiko Auto-T 1000mm F11	2.5°	5 - 5	Automatic	11 - 45	30 m	98 x 65cm	4,800g	662mm	110mm	Built-in	100mm
Special Use	Zuiko Shift 35mm F2.8	63° - 84°	8 - 7	Manual	2.8 - 22	0.3 m	21 x 14cm	350g	57mm	70mm	Screw-in	49mm
	Zuiko Auto-Macro 50mm F3.5	47°	5 - 4	Automatic	3.5 - 22	0.23m	72 x 48mm	200g	40mm	60mm	-	49mm
	Zuiko Macro 20mm F3.5		4 - 3	Manual	3.5 - 16	0.13m	max. 8 x 5mm min. 3 x 2mm	50g	20mm	26mm	-	21mm
	Zuiko Macro 38mm F3.5		5 - 4	Manual	3.5 - 16	0.16m	max. 20 x 13mm min. 6 x 4mm	70g	28mm	37mm	-	32mm
	Zuiko 1:1 Macro 80mm F4		6 - 4	Manual	4 - 22	0.35m	max. 72 x 48mm min. 18 x 21mm	200g	46mm	59mm	-	49mm

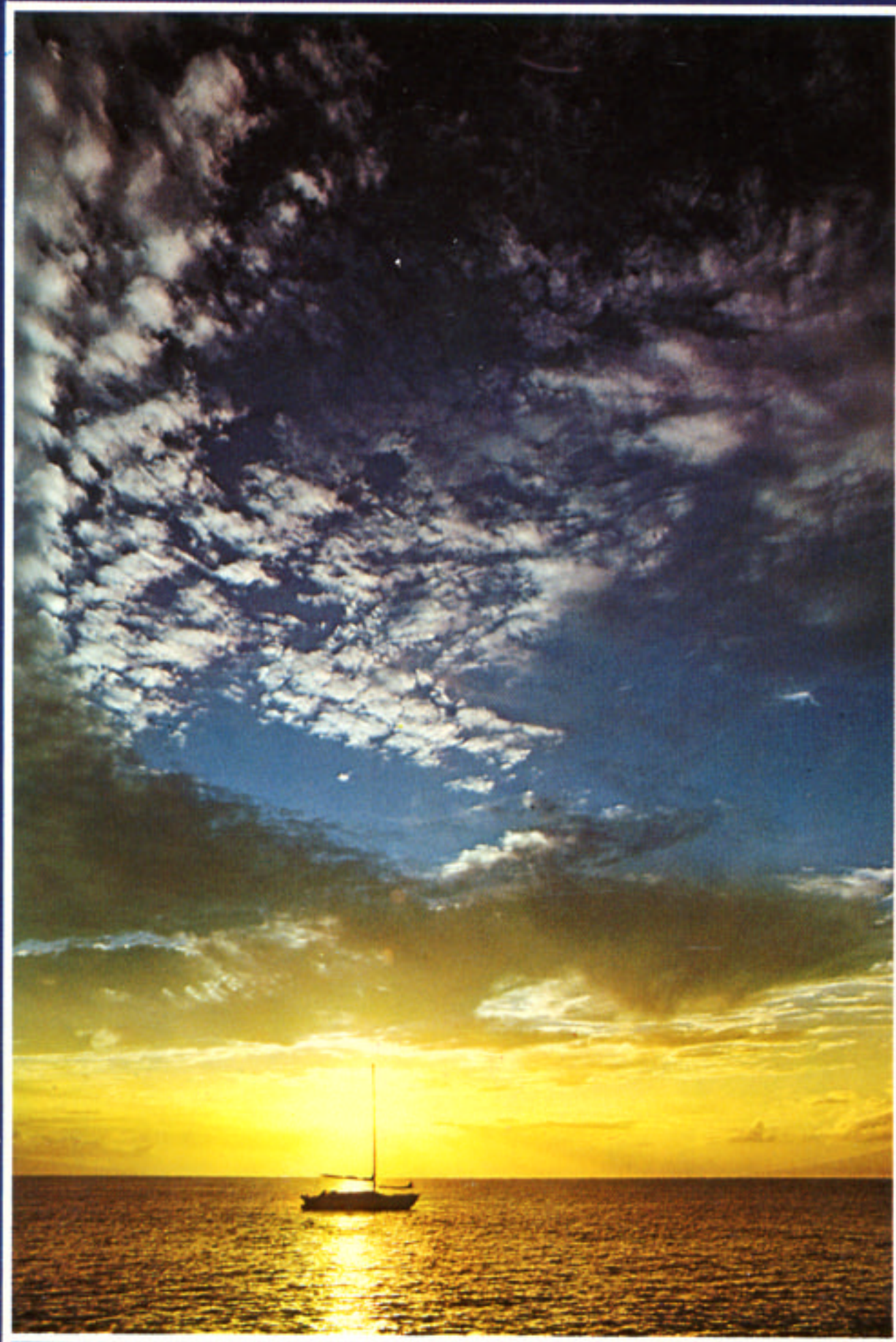

**OLYMPUS**  
OLYMPUS OPTICAL CO., LTD.