

OLYMPUS OM10

E

OLYMPUS

OLYMPUS

OM10

INSTRUCTIONS

## To an OM-10 Owner

We appreciate very much that you have acquired an OM-10, a camera designed to allow you to take good pictures automatically and with the greatest ease.

The Olympus OM-10 is a single lens reflex camera of the finest quality in which the automation of photographic functions has been made possible by employing the most advanced electronics. To its acceptability of Olympus interchangeable lenses, a special film winder, a flash, and a host of

other accessories are added to make it a complete system of photography. With the OM-10 you can gradually widen your enjoyment of the photographic art.

We sincerely wish that it will become for you a source of unending satisfaction. To this effect, please read this instruction manual carefully before using the camera, so that you may be sure of taking correct, beautiful pictures every time you use your OM-10.

# TABLE OF CONTENTS

---



---

● Description of Controls . . . . .	3	● Long Exposures . . . . .	30
● Preparations before Taking Pictures . . . . .	6 to 15	● Flash Photography . . . . .	31
● Mounting and Detaching the Lens . . . . .	7	● Using the Winder 2 . . . . .	33
● Inserting the Batteries . . . . .	9	● From General Photography to the Use of Interchange- able Lenses . . . . .	35
● Checking the Batteries . . . . .	10	● Making Use of the Depth of Field . . . . .	37
● Loading the Film . . . . .	11	● Manual Exposure Control . . . . .	39
● Setting the ASA Film Speed . . . . .	15	● Care and Storage of the Camera . . . . .	43
● The Way to Automatic Photography . . . . .	16 to 25	● Questions and Answers . . . . .	45
● Setting the Aperture . . . . .	17	● Main Specifications . . . . .	47
● Taking Picture Auto- matically . . . . .	19		
● The OM-10: Designed to Save Battery Consumption . . . . .	22		
● Switching the Camera Off . . . . .	23		
● Rewinding the Film . . . . .	23		
● Unloading the Film . . . . .	24		
● The Use of the Self-Timer . . . . .	25		
● Photographic Techniques . . . . .	26 to 42		
● Controlling the Exposure . . . . .	27		
● Photography with Shutter- Speed Priority . . . . .	28		
● Exposure Compensation . . . . .	29		



The photo indicates OM-10 camera body with the 50mm F1.8 standard lens.

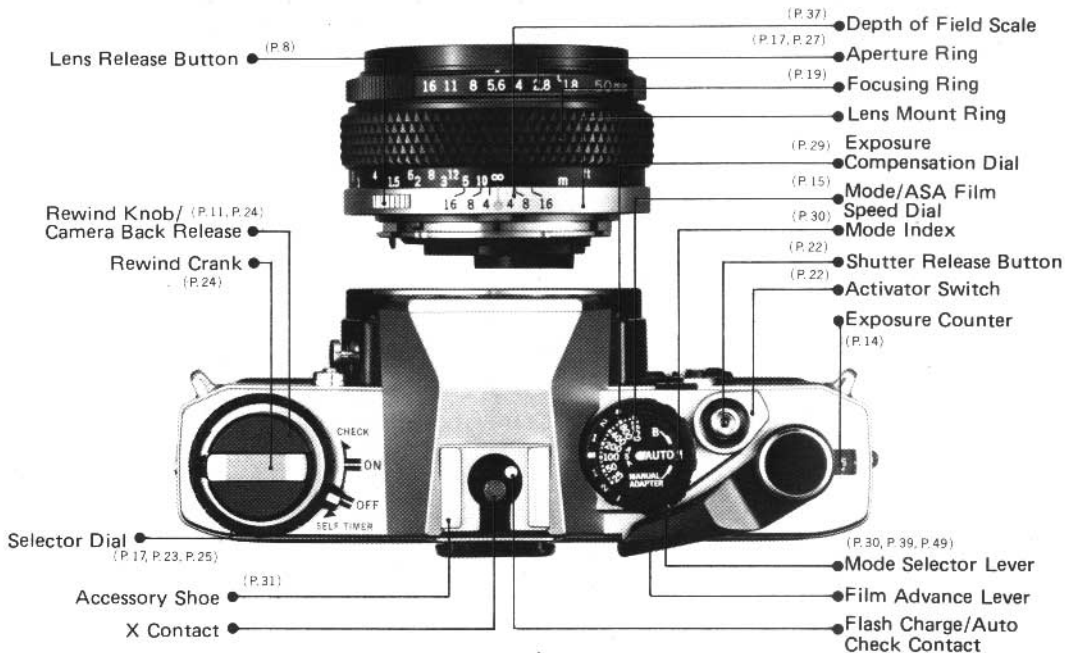

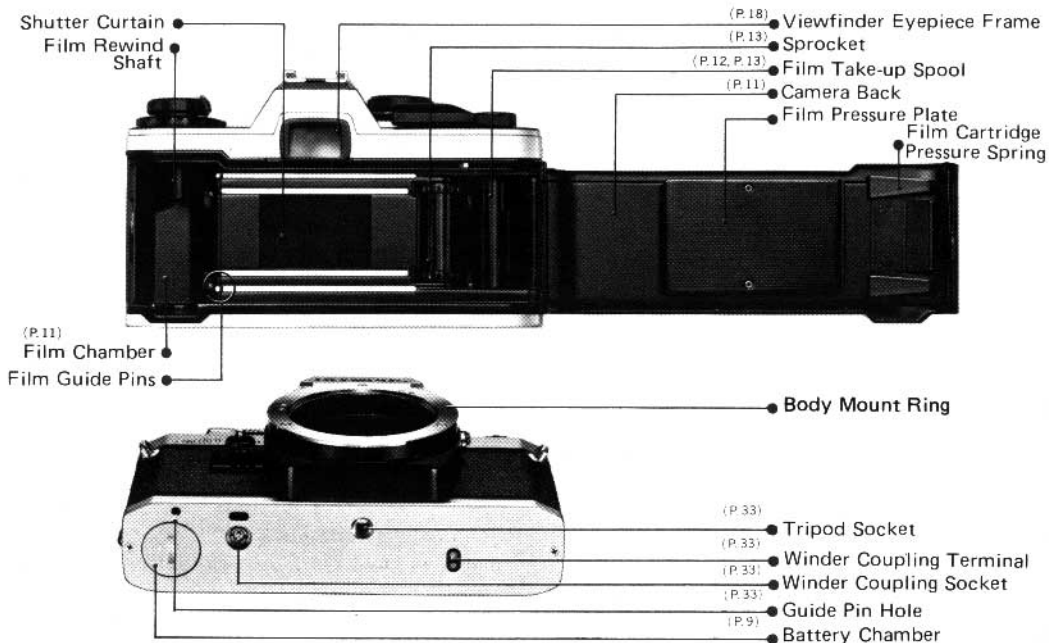

## PREPARATIONS BEFORE TAKING PICTURES

The OM-10's circuits are powered by two 1.5V alkaline-manganese or silver oxide batteries. Without them, the shutter of this electronic single lens reflex camera will not function.

This section is devoted to explaining the preparations which you must go through before proceeding to take pictures. Please keep in mind that they are indispensable for obtaining good results.

## MOUNTING AND DETACHING THE LENS

---



① Remove the body cap and the rear lens cap.\*



② Remove the front lens cap.

\* If you have purchased an OM-10 in conjunction with a lens, the body cap and rear lens cap are not provided.





③ Mount the lens.



④ Detach the lens.

## INSERTING THE BATTERIES



- ① Remove the cover of the battery chamber.



- ② Insert two 1.5V alkaline-manganese batteries LR44 (A76).  
③ Replace the cover.

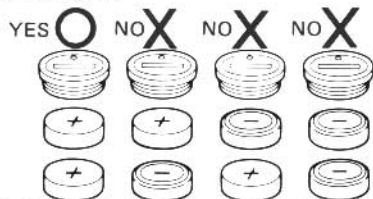

(NOTE)

Two 1.5V silver oxide batteries SR44 (Eveready EPX-76) or equivalents can be also used.

## CHECKING THE BATTERIES

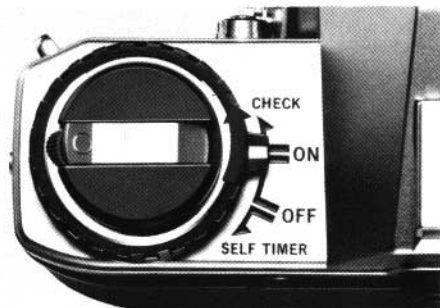

- ① Move the selector dial to "CHECK".



- ② A beeping sound is heard and the battery check light turns on.  
③ After the check set back the dial.

### (Attention)

If no sound is heard and the light does not turn on, the batteries have not been correctly inserted, or their charge is exhausted. In this case they must be replaced.

## LOADING THE FILM

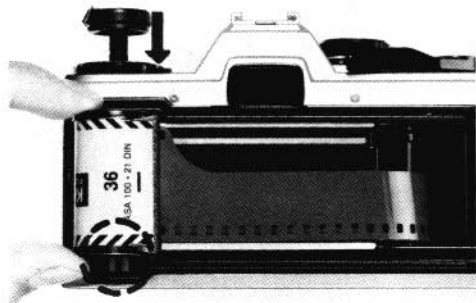

② Load the film.



- ① Open the camera back.  
(Never load or unload  
the camera in direct sun-  
light.)

YES



NO



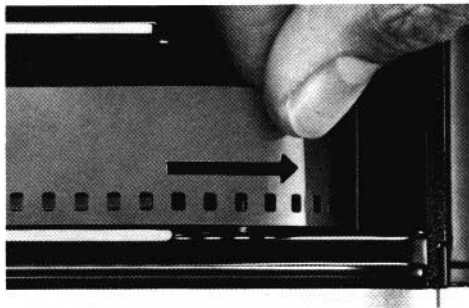

③ Insert the film leader in one of the slots of the take-up spool.

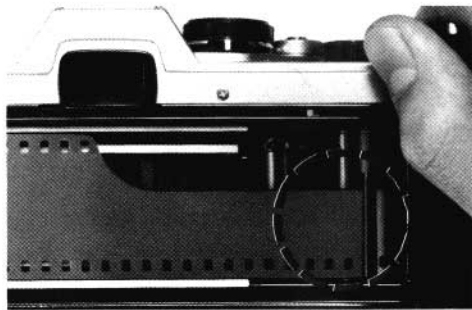

④ The film leader must not be excessively drawn out.

YES ○

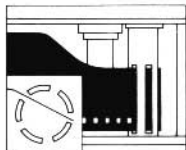

NO X (The film leader is twisted.)

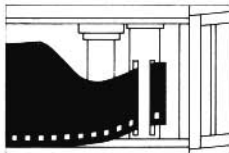

NO X (The film leader does not enter completely.)

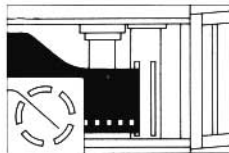

NO X (The film leader is excessively drawn out.)

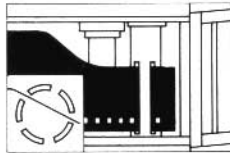



- ⑤ Wind the film once.

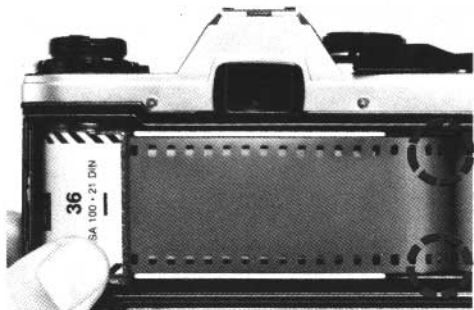

- ⑥ The perforations of the film must engage with the sprocket teeth. Make sure it is well tense, and close the back.

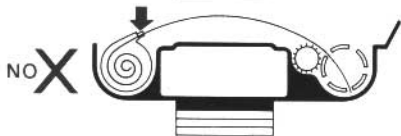
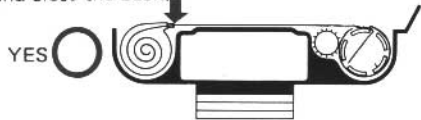

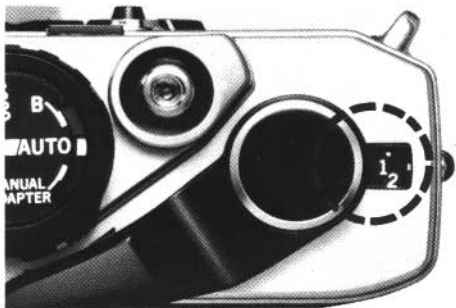

- ⑦ Take blank shots until the exposure counter shows "1".

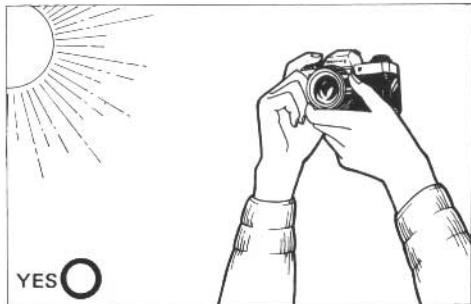
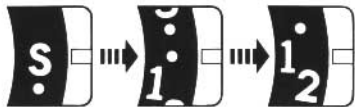

(Ways of taking blank shots)

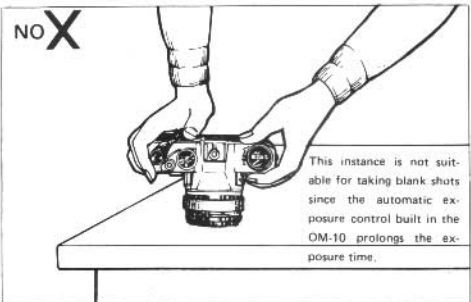

## SETTING THE ASA FILM SPEED



Set the ASA film speed.

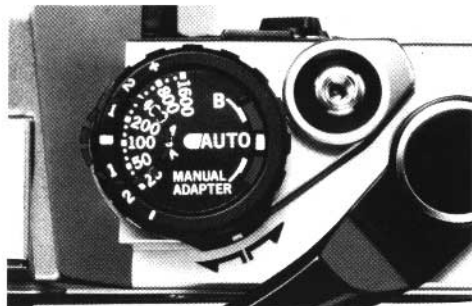

(The ASA film speed dial is set at ASA 100.)

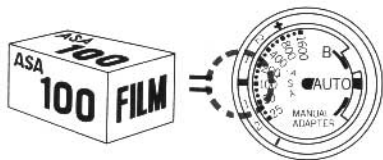



## THE WAY TO AUTOMATIC PHOTOGRAPHY

All the problems  
of exposure are electronically taken care  
by the OM-10.

It is a single lens reflex camera  
which can be set for automatic control of exposure,  
and when set so taking correctly exposed,  
beautiful pictures could not  
be simpler.

# SETTING THE APERTURE



- ① Set the desired aperture.



- ② Confirm that the camera is set at the "AUTO" position.

## (Aperture guideline)

Weather			
F/stop	16	8	4

**NOTE:** To make full use of the aperture ring, read page 27.

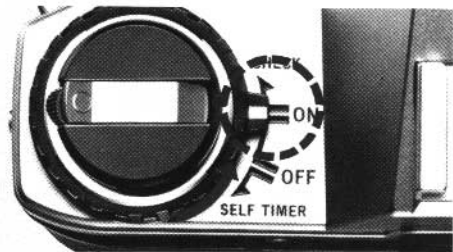

- ③ Set the selector dial at the "ON" position.

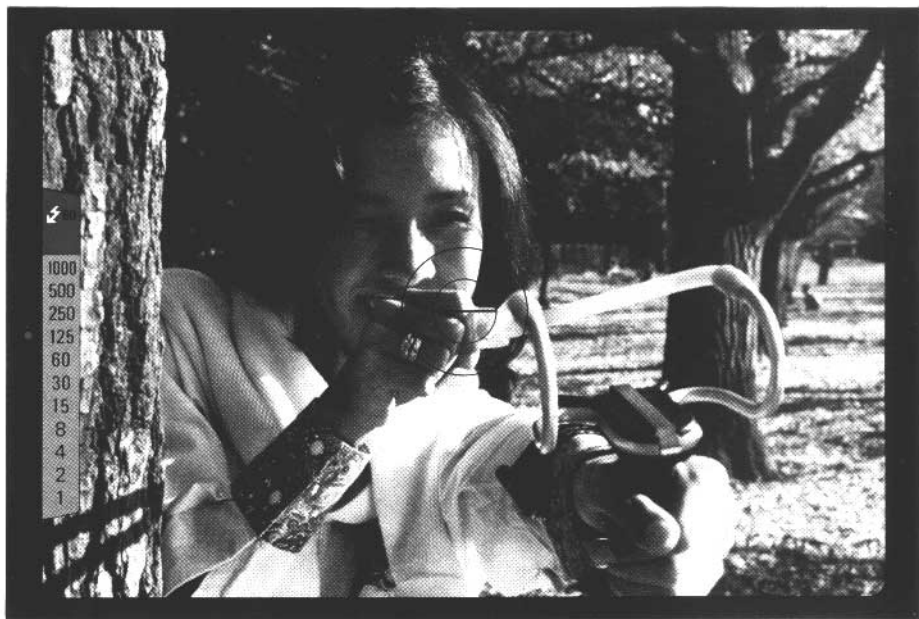

④ The proper shutter speed lights up in the viewfinder.

## TAKING PICTURES AUTOMATICALLY

---

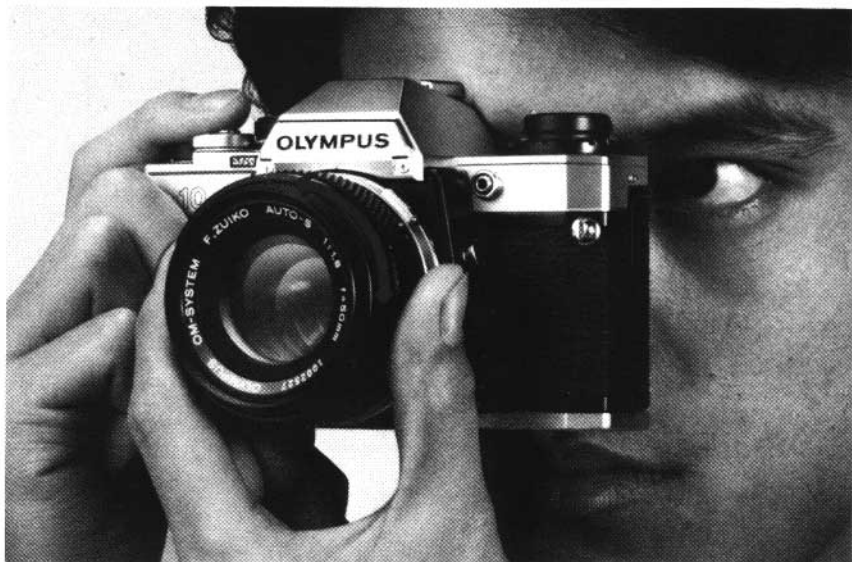

Focus.

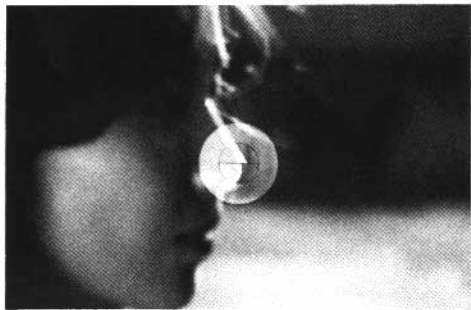

Out of focus.

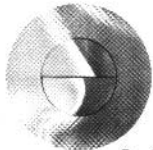

NO **X**



Correct focus.

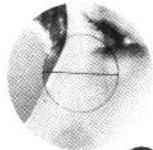

YES **O**

---

When holding the camera horizontally, make sure to press your elbows against your body.



Have your elbow pressed against your body when holding the camera vertically, too.

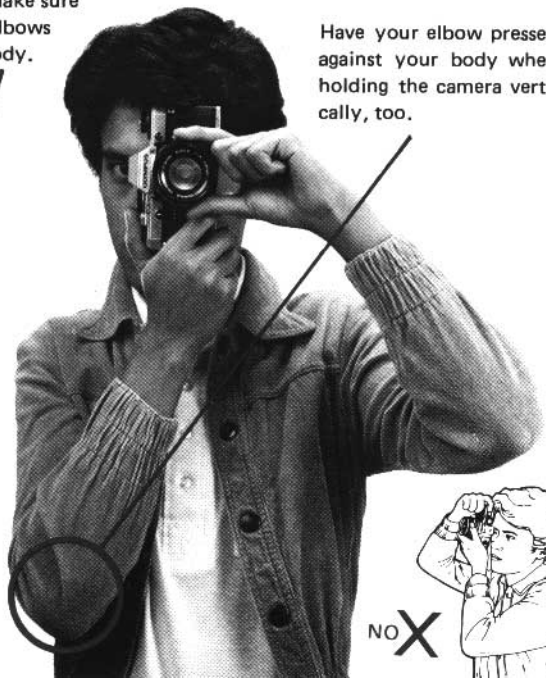

NO X



Gently press the shutter release button.

**< When the selector dial is turned to the "ON" position ... >**

Energy flows from the alkaline-manganese or silver oxide batteries and a light appears by the shutter speed scale in the viewfinder. However,

this light will go off automatically after 90 seconds, to prevent unnecessary battery consumption.

**< When the activator switch is touched ... >**

With a light touch on the activator switch, energy will begin flowing again, and the light which had gone out after 90 seconds will turn on again.



**< When the selector dial is set at the "OFF" position ... >**

No energy will be supplied to the camera's circuits and the light will not turn on. However, if you forget to turn the selector dial to the "ON" position and suddenly you press the shutter release button, energy will flow only during the time the shutter is open, and properly exposed photographs can be taken. Once the picture is taken, all circuits are disconnected as a safety measure to prevent unnecessary battery consumption.

## SWITCHING THE CAMERA OFF

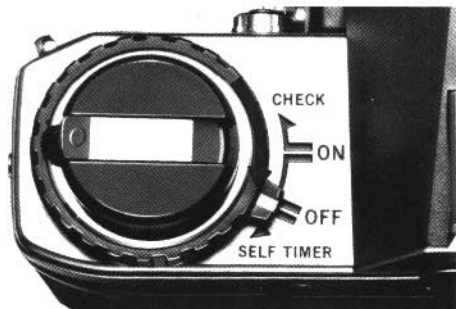

Move the selector dial to the "OFF" position when you are not going to take any more pictures.

## REWINDING THE FILM



- ① Turn the rewind release lever when the film ends.



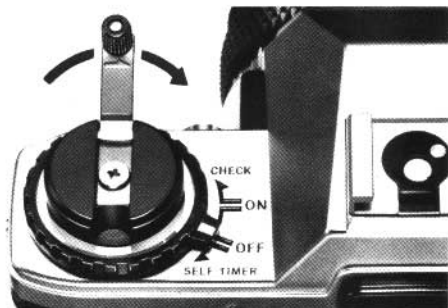

- ② Keep rewinding the film until you feel no more resistance.

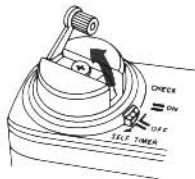

Open the back  
and unload the  
film.

## THE USE OF THE SELF-TIMER

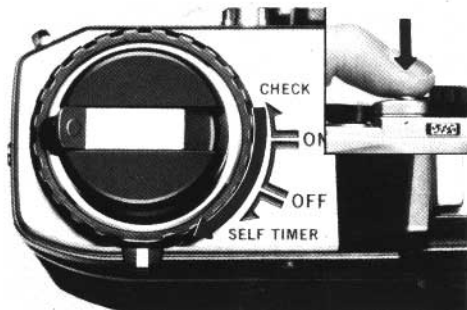

- ① Click the selector dial to the position "SELF TIMER".
- ② Press the shutter release button.



- ③ A beeping sound is heard and the self-timer light blinks. The shutter will be released after about 12 seconds.
- ④ Return the selector dial to its original position.

## PHOTOGRAPHIC TECHNIQUES

The various functions of the OM-10 and the wide variety of lenses, flash, winder, and system accessories which can be used with it allow you to fully master all the techniques which automatic photography can make possible.

We shall devote the following section to some of these photographic techniques.

## CONTROLLING THE EXPOSURE



When taking pictures in a place which is either too dark or too bright, even if you follow the aperture guidelines given on page 17, there will be a tendency to result in whitish photographs (overexposure), or darkened ones (underex-

- ① When a red light turns on in the red zone at the top of the shutter speed scale in the viewfinder it indicates overexposure.
- ② In such a case, turn the aperture ring to the higher f-numbers (toward F16) until the light appears within the proper exposure range, and



posure), or even blurred images. In these circumstances, make full use of the aperture ring in order to control exposure so as to obtain properly exposed photographs.

- then proceed to take the picture.
- ③ When the light appears below "30" (1/30 of a second), blur may easily occur.
- ④ In this case, use a tripod or turn the aperture ring to the lower f-numbers (toward F1.8) until the light goes higher within a range in



With a shutter speed of 1/1000 second.

When photographing fast moving subjects, there is a marked tendency to obtain a blurred image of the subject. This can be made use of as a technique to give the impression of movement, by intentionally allowing the image to be blurred, while making use of the shutter speed priority function.

which blur is not likely to occur.

- ⑤ When the light appears at "1" (1 sec.), the shutter speed is 1 sec. or longer. In such a case it is recommended to turn the aperture ring to the lower f-numbers within the proper exposure range.



With a shutter speed of 1/15 second.

Pictures taken with this technique offer an interesting challenge. Turn the aperture ring until the light in the viewfinder appears by the shutter speed value suitable for the photographic situation, and then press the shutter release button.

# EXPOSURE COMPENSATION



When shooting against the light, or if the subject is standing before a window, the face tends to appear dark on the image. In this case, use the exposure compensation dial to obtain a correctly exposed photograph.

- ① Lift the compensation dial and change the film speed set on the dial (within  $\pm 2$ ). By this means, it is possible to obtain high or low key effects. (+) is for high key (overexposure) and (-) is for low key (underexposure). However it is not possible to obtain (-) compensation for ASA 1600 or the (+) compensation for ASA 25.



Before compensation



Compensated +2 full stops.



(For example, ASA 100 compensated +2 full stops.)  
compensation for ASA 25.

- ② When you finish taking the picture, return the compensation dial to its original position.



Indoors when it is dark, or when photographing at night, use the "BULB" setting and take the pictures by resorting to long exposures. Of course, blur can easily occur in long exposures so it is recommended to use a tripod and a cable release.

- ① Set the mode selector lever to B, and press the shutter release button.
- ② The shutter will remain open as long as the shutter button is being pressed.
- ③ Do not forget to reset at the "AUTO" position after you finish taking pictures.

(Continued on page 49)



With a shutter speed of 2-seconds



With a shutter speed of 8 seconds



Electronic  
Flash T32



Electronic  
Flash T20

The T32 and T20 electronic flash units specifically designed for OM cameras provide artificial illumination when you take pictures at night or

indoors.

## < Characteristics of flash photography using the T32·T20 >

- ① Mount the Electronic Flash T32 (or T20) on the accessory shoe of the camera. When the ON-OFF switch of the T32 (or T20) is turned on, the normal auto flash control begins working. When turned off, it reverts to the camera's AE photography. It takes but a flick of a finger to change it from one to the other.
- ② When the ON-OFF switch of the T32 (or T20) is turned on, the flash will be automatically synchronized at the shutter speed of the camera.
- ③ It is possible to verify when the flash is ready because a full charge signal lights in the viewfinder.
- ④ In addition to the charge signal automatically lighting at  $\frac{1}{2}$  you can refer to the shutter speed indicated by another red light in the viewfinder as required by the available light.
- ⑤ It is possible to check a correct flash exposure in the viewfinder if the signal light blinks.

(Continued on page 49)





1000  
500  
250  
125  
60  
30  
15  
8  
4  
2  
1





Fast moving subjects, such as in sports, car racing, and the like, make you wish to take pictures at a faster pace.

The time spent winding the film may mean that a great chance is lost. In these cases, an accurate, reliable power winder for automatic film winding can well be the perfect answer, such as the Olympus Winder 2 which can be attached on the OM-10 very simply, and switched to the single or sequence mode photography. On single mode, it can wind film immediately after exposure, ready for next chance to release the shutter at any moment, and on sequence mode, it can make sequential filming as fast as 2.5 frames per second.







The main characteristic of the single lens reflex camera is the possibility of using a plurality of different lenses on the same body. From photography with a standard lens to the feeling obtained with a telephoto lens by blurring the background or, on the other hand, by stressing the perspective, giving a special effect to the background by means of a wide angle lens, the world of images which unfolds before you with the OM-10 becomes richer and wider. Olympus Zuiko interchangeable lenses included in the OM System are highly reputed for their sharpness and resolving power.



Wide angle 28mm



Telephoto 200mm

## MAKING USE OF THE DEPTH OF FIELD

When you have a subject in focus, there is a range in the fore and the background which is clearly defined in the picture. This range is called depth of field. The larger the F number becomes, the wider this clearly defined range becomes, and the background becomes sharper. On the contrary, the smaller the F number becomes, this range becomes less wide, while the background loses contrast and out of focus. By using these properties of the depth of field with creativity and imagination, you will be able to take pictures which will have your own personal imprint.



# F4



# F16

## < How to check the depth of field >



- ① The photograph is focused at a distance of about 4m (13 ft).
- ② In this case, if the aperture is set at F 4, the range which appears clearly defined will be approximately from 3m (10 ft) to about 4.5m (15 ft).
- ③ If an F16 is used, the range will be approximately between about 2m (6.6 ft) and 10m (33 ft).



- When you want to check inside the viewfinder the correct focusing range, it simply requires pressing this preview button.

## MANUAL EXPOSURE CONTROL

When the optional Manual Adapter is attached to the OM-10, it is possible to revert to manual exposure control. When photographing fast moving subjects, when there is a possibility of camera shake, or when you want to capture the subject in its natural tones no matter what the illumination behind may be, this accessory proves to be very useful. In order to control exposure in such a way as to obtain special effects to match the photographic situation or your own intentions, you must rely on your own expertise and practice. In photography with manual control of exposure, the mode selector lever must be set at the "MANUAL ADAPTER" position.

To use the electronic flash T32 or T20 with the Manual Adapter attached on, you must set the mode selector lever to AUTO and the flash unit automatically synchronizes at the shutter speed of the camera.

(CAUTION) If an electronic flash other than the T32 or T20 is used with the Manual Adapter, sometimes the shutter is not released at the speed you set on the Adapter due to the noise of the flash.







Shutter-speed priority at 1/1000 sec.

< **When shutter-speed priority is advisable** >

- ① Set the necessary shutter speed in the Manual Adapter.
- ② Turn the aperture ring while looking through the viewfinder until the light on the shutter speed scale turns on at the shutter speed which was set in the Manual Adapter. Then, press the shutter release button.



Aperture priority, high keyed

< **How to apply aperture priority to your photographic needs** >

- ① Set the aperture as preferred.
- ② Look through the viewfinder to see the shutter speed which the light indicates, and set that speed in the Manual Adapter. Then, press the shutter release button.

\* By intentionally ignoring the indicated shutter speed, and setting a different one in the Manual Adapter it is possible to obtain high key or low key results as desired.

# TABLE OF INTERCHANGEABLE LENSES

TYPE	INTERCHANGEABLE LENSES	ANGLE OF VIEW	OPTICAL CONSTRUCTION ELEMENT GROUP	F-STOP RANGE	MIN. FOCUS (ft.)	WEIGHT (oz.)	LENGTH	FILTER
FISHEYE	ZUIKO FISHEYE 8mm F2.8	180° (circle)	11-7	2.8-22	0.2 m (0.7)	640 g (22.6)	83 mm	Built-in
	ZUIKO FISHEYE 16mm F3.5	180°	11-8	3.5-22	0.2 m (0.7)	180 g (6.3)	31 mm	Built-in
SUPER WIDE ANGLE	ZUIKO 18mm F3.5	100°	11-9	3.5-16	0.25 m (0.8)	250 g (8.8)	43 mm	72 mm
	ZUIKO 21mm F2	92°	11-9	2-16	0.2 m (0.7)	250 g (8.8)	44 mm	55 mm
	ZUIKO 21mm F3.5	92°	7-7	3.5-16	0.2 m (0.7)	180 g (6.3)	31 mm	49 mm
	ZUIKO 24mm F2	84°	10-8	2-16	0.25 m (0.8)	275 g (9.7)	48 mm	55 mm
	ZUIKO 24mm F2.8	84°	8-7	2.8-16	0.25 m (0.8)	185 g (6.5)	31 mm	49 mm
	ZUIKO 28mm F2	75°	9-8	2-16	0.3 m (1.0)	245 g (8.6)	43 mm	49 mm
	ZUIKO 28mm F2.8	75°	6-6	2.8-22	0.3 m (1.0)	170 g (6.0)	32 mm	49 mm
WIDE ANGLE	ZUIKO 35mm F2	63°	8-7	2-16	0.3 m (1.0)	240 g (8.5)	43 mm	55 mm
	ZUIKO 35mm F2.8	63°	7-6	2.8-16	0.3 m (1.0)	175 g (6.2)	35 mm	49 mm
	ZUIKO SHIFT 35mm F2.8	63°/83° at max. shift	8-7	2.8-22	0.3 m (1.0)	310 g (10.9)	59 mm	49 mm
	ZUIKO 40mm F2	56°	6-6	2-16	0.3 m (1.0)	140 g (4.9)	25 mm	49 mm
STANDARD	ZUIKO 50mm F1.2	47°	7-6	1.2-16	0.45 m (1.5)	285 g (10.1)	43 mm	49 mm
	ZUIKO 50mm F1.4	47°	7-6	1.4-16	0.45 m (1.5)	230 g (8.1)	40 mm	49 mm
	ZUIKO 50mm F1.8	47°	6-4	1.8-16	0.45 m (1.5)	165 g (5.8)	32 mm	49 mm
	ZUIKO MACRO 50mm F3.5	47°	5-4	3.5-22	0.23 m (0.8)	200 g (7.1)	40 mm	49 mm
	S ZUIKO ZOOM 28-48mm F4	75°-49°	8-8	4-22	0.65 m (2.0)	300 g (10.6)	54 mm	49 mm
	ZUIKO ZOOM 35-70mm F3.6	63°-34°	10-8	3.6-22	0.8 m (2.7)	420 g (14.8)	74 mm	55 mm
ZOOM	S ZUIKO ZOOM 35-70mm F4	63°-34°	7-7	4-22	0.75 m (2.5)	385 g (13.6)	71 mm	55 mm
	ZUIKO ZOOM 35-105mm F3.5 F4.5	63°-23°	16-12	3.5-22	1.5 m (4.9)	470 g (16.6)	85 mm	55 mm
	ZUIKO ZOOM 75-150mm F4	32°-16°	15-11	4-22	1.6 m (5.2)	445 g (16.1)	115 mm	49 mm
	S ZUIKO ZOOM 100-200mm F5	24°-12°	9-6	5-32	2.4 m (7.9)	570 g (20.1)	148 mm	49 mm
	ZUIKO ZOOM 85-250mm F5	29°-10°	15-11	5-32	2 m (6.0)	905 g (31.9)	196 mm	55 mm
	TELEPHOTO	ZUIKO 85mm F2	29°	5-4	2-16	0.85 m (2.8)	250 g (8.8)	48 mm
ZUIKO 100mm F2.8		24°	5-5	2.8-22	1 m (3.3)	235 g (8.3)	48 mm	49 mm
ZUIKO 135mm F2.8		18°	5-5	2.8-22	1.5 m (4.9)	360 g (12.7)	80 mm	55 mm
ZUIKO 135mm F3.5		18°	5-4	3.5-22	1.5 m (4.9)	290 g (10.2)	73 mm	49 mm
ZUIKO 180mm F2.8		14°	5-5	2.8-32	2 m (6.0)	700 g (24.7)	125 mm	72 mm
ZUIKO 200mm F4		12°	5-4	4-32	2.5 m (8.2)	515 g (18.2)	127 mm	55 mm
ZUIKO 200mm F5		12°	6-5	5-32	2.5 m (8.2)	385 g (13.6)	105 mm	49 mm
ZUIKO 300mm F4.5		8°	6-4	4.5-32	3.5 m (11.5)	1020 g (36.0)	181 mm	72 mm
SUPER TELEPHOTO	ZUIKO 350mm F2.8	7°	9-7	2.8-32	3 m (9.8)	3900 g (137.6)	280 mm	46 mm
	ZUIKO 400mm F6.3	5°	5-5	6.3-32	5 m (16.4)	1300 g (46.0)	256 mm	72 mm
	ZUIKO 500mm F8	5°	5-2	5-32	4 m (13.0)	590 g (20.8)	97 mm	72 mm
	ZUIKO 600mm F6.5	4°	6-4	6.5-32	11 m (36.1)	2600 g (92.8)	377 mm	100 mm
	ZUIKO 1000mm F11	2.5°	5-5	11-45	30 m (98.4)	4150 g (146.5)	662 mm	100 mm
	SPECIAL USE	ZUIKO MACRO 20mm F2	9° at highest mag.	6-4	2-16	W/Auto Bellows & PM/MT ob	170 g (6.0)	46 mm
ZUIKO MACRO 20mm F3.5		9° at highest mag.	4-3	3.5-16	W/Auto Bellows & PM/MT ob	70 g (2.5)	20 mm	21 mm Slide on
ZUIKO MACRO 38mm F2.8		9° at highest mag.	6-4	2.8-22	W/Auto Bellows & PM/MT ob	170 g (6.0)	46 mm	
ZUIKO MACRO 38mm F3.5		9° at highest mag.	5-4	3.5-16	W/Auto Bellows & PM/MT ob	90 g (3.2)	28 mm	32 mm Slide on
ZUIKO 1:1 MACRO 80mm F4		9° at highest mag.	6-4	4-32	W/65-116 or Auto Bellows	170 g (6.0)	31 mm	49 mm
ZUIKO MACRO 135mm F4.5	18°	5-4	4.5-45	W/65-116 or Auto Bellows	320 g (11.3)	47 mm	55 mm Slide on	

TELECONVERTER 1.4X-A ● APPLICABLE LENSES: 380mm F2.8, 300mm F4.5, 350mm F2.8, 400mm F6.3

TELECONVERTER 2X-A ● APPLICABLE LENSES: 100mm F2.8, 135mm F2.8, 135mm F3.5, 200mm F4, 200mm F5, 100-200mm F5

● OPTICAL CONSTRUCTION: 6-4 ● WEIGHT: 180g/6.3oz ● LENGTH: 23mm (0.9")

● OPTICAL CONSTRUCTION: 6-6 ● WEIGHT: 215g/7.6oz ● LENGTH: 48mm (1.9")

○ Automatic correction design against close distance aberrations.

(Specifications subject to change without notice.)

\* Picture image may be cut off slightly when OM-10 is used with the 600mm and 1000mm lenses.

\* Make it a point to use the Zuiko Macro 135mm F4.5 with the hood provided.



# CARE AND STORAGE OF THE CAMERA

---

## General

- Dust and moisture are primary harmful agents affecting your camera. When you do not use the camera, remove it from the case and store in a dry, ventilated place, making sure that the shutter is set free from tension and the selector lever at the OFF position.
- When storing the camera for a long period of time, remove the batteries. Wipe all battery surfaces with a dry cotton cloth before re-inserting them into the camera.
- Avoid dropping or hitting the camera.
- Never store the camera where temperatures exceed  $50^{\circ}\text{C}$  ( $122^{\circ}\text{F}$ ). When you use the camera in temperatures under  $-20^{\circ}\text{C}$  ( $-4^{\circ}\text{F}$ ), it may sometimes fail to operate properly. To avoid this, warm the camera before use. Protect against excess moisture by using silica gel or other desiccant.
- Generally speaking, a battery voltage may be reduced when an ambient temperature lowers. As the batteries that activate the camera at normal temperature regularly, sometimes fail to in low temperature, it is recommended to use fresh

batteries in a cold district.

- Take care not to permit water to enter the camera when taking pictures in the rain or snow, especially near sea-water spray, as water drops may easily have a chance to enter the camera through small orifices.
- After use near the ocean, wipe the camera surfaces clean with a soft cloth; never leave salt on the camera. (Salt may be airborne near the ocean and collect on the camera even though it has not been in direct contact with water.)
- Avoid areas exposed to salt water, radios, TV sets, or magnets.
- Have all repairs performed by an authorized OLYMPUS Service Center. You may send it directly or through the store where you bought your camera.

## Parts

- Do not press the release button at random.
- Do not touch any part that moves at high speed such as the shutter, instant return mirror, diaphragm, etc.
- Avoid touching the surfaces of the lens. Clean

---

only with an air brush, antistatic brush, or wipe it lightly with a camel hair brush or lens tissue. In EXTREME cares, use a clean, soft cotton cloth moistened with denatured alcohol. NEVER rub the lens surfaces with your finger, clothing or other abrasive material.

- If dust or fingerprints collect on the mirror, focusing screen, or prism, take the camera to an authorized OLYMPUS Service Center. It needs professional attention.
- Avoid excessive force when mounting on a tripod.

# QUESTIONS AND ANSWERS

---

**Q :** I can neither release the shutter even by pressing the shutter release button, nor advance the film. Why?

**A :** Because no batteries are loaded. Load fresh batteries.

**Q :** Why is the field of view dark and the image obscure?

**A :** Because the batteries are exhausted. Replace them.

**Q :** Why can't I move the film advance lever?

**A :** The self-timer may be set, or the shutter release may be cocked and ready but it has not been pressed yet. If you press the shutter release button, film will advance to the next frame. Has the film reached its end? Check the exposure counter and, if it shows that the film has ended, rewind the film. Are the alkaline-manganese or silver oxide batteries charged? Check the batteries, and if you hear the beeping sound and see the red light flashing, but cannot move the lever, take your camera to an authorized OLYMPUS Service Center.

**Q :** Why doesn't the rewind knob rotate when I

try to advance the film?

**A :** The film leader is not properly engaged on the film take-up spool. Insert the film leader again.

**Q :** Why won't the rewind crank turn?

**A :** Set the rewind release lever once more in the direction of the arrow, and the problem will be solved.

**Q :** Is infrared photography also possible with the OM-10?

**A :** Yes, it is if you use the manual adapter and set the mode selector lever to the MANUAL ADAPTER position. Then, take the following steps: ① Focus without a filter. ② Move the focusing ring to coincide with the infrared mark. Mount a filter for infrared photography, and proceed to take the picture.

**Q :** When should I check the batteries?

- A :** ① When new batteries are inserted.  
② After the camera has been stored for a long time.  
③ When you think batteries may be exhausted.

The alkaline-manganese batteries should

last for about a half year, and the silver oxide batteries for about one year.

④ When the temperature is extremely low,

**Q : I pressed the shutter release button with the selector dial at the "OFF" position. Will the photograph be properly exposed?**

A : Even at the "OFF" position, the camera's circuits will be activated for a proper exposure. Recommended to develop the film and see.

**Q : When set at the "AUTO" position, the actual shutter speed is much slower than the one indicated in the viewfinder. Why does this happen?**

A : If film is not loaded or the film surface is not properly positioned behind the shutter, the speed will be slower than that indicated in the viewfinder.

**Q : What batteries should I use?**

A : Use two 1.5V alkaline-manganese batteries LR44 (A76) or two silver oxide batteries SR44 (Eveready EPX-76 or equivalents). Batteries of a different type (1.3V mercury batteries) cannot be used, though they may

be of the same size.

**Q : A shadow appears darkening the central area of the viewfinder. Why does this happen?**

A : This is quite usual when a lens with a maximum aperture smaller than F5 is mounted on the camera, and the preview button is pressed with the diaphragm closed down beyond F5. There is nothing wrong with the microprism.

**Q : If I return the selector lever to the ON position, while the self-timer in operation, what will become of the shutter?**

A : The shutter will be released. After the use of the self-timer, make it a point to return the selector lever to original position.

**Q : While I was operating the Winder 2, the light in the viewfinder went out... why?**

A : The light goes out in 90 sec. even the selector lever is ON, in order to save the batteries from unnecessary consumption. Touch the activator switch lightly, and the light is on again.

# MAIN SPECIFICATIONS

---

**Camera type:** 35mm single lens reflex camera with electronic control automatic exposure and focal plane shutter.

**Image format:** 24 x 36mm.

**Lens mount:** Olympus OM Mount, bayonet type.

**Shutter:** Electronically controlled focal plane shutter.

**Flash synchronization:** X contact. Direct contact only.

**Automatic exposure control:** Aperture-priority electronically controlled shutter. TTL direct light measuring system. Light measuring range: EV-0.5 to 18 from 2 sec. to 1/1000 sec. at normal temperatures and humidity with ASA 100 and F1.2 standard lens.

Exposure compensation:  $\pm 2EV$ .

Automatic flash exposure: Normal auto flash (at 2 aperture settings F4 and F8 with ASA 100 film) is automatically set to X synch. (1/60 sec.) in conjunction with the electronic flash T20.

**Manual exposure control:** The optional Manual Adapter attached to the OM-10 permits a full range of 11 manual shutter speeds. (1 to 1/

1,000 sec.)

By setting the mode selector lever to the manual mode, the shutter speed can be set to 1/60 sec.

**Film speed range:** ASA 25 to 1600.

**Battery checker:** Battery voltage can be checked by both LED and PCV. Mirror lock to limit drainage.

**Power source:** Two 1.5V alkaline-manganese batteries LR44 (A76), or two 1.5V silver oxide batteries SR44 (Eveready EPX-76 or equivalents).

**Viewfinder:** Pentaprism type.

**Focusing screen:** Microprism/split image-matte type.

**Finder view-field:** 93% of actual picture field.

**Viewfinder magnification:** 0.92X with the 50mm lens at infinity.

**Viewfinder information:** 12-step shutter speed scale and flash charge indicated by LEDs.

**Mirror:** Oversize, quick return mirror.

**Film advance:** Lever type with 130° angle. It can be wound with one long or several short strokes. 30° pre-advance angle. Power wind-



---

ing is possible with the Olympus OM System Winder 2.

**Self-timer:** Electronic self-timer with about 12 second delay.

**Accessory shoe:** Built-in type, with direct contact.

**Dimensions and weights:** Body only: 135(W) x 84(H) x 50(D) mm (5.3'' x 3.3'' x 2'') 430gr. (15.2 oz)

With F1.8 lens: 135(W) x 84(H) x 81(D)mm (5.3'' x 3.3'' x 3.2'') 600gr. (21.2 oz).

With F1.4 lens: 135(W) x 84(H) x 86(D)mm (5.3'' x 3.3'' x 3.4'') 660gr. (23.3 oz).

(Specifications subject to change without notice.)

---

### **Long Exposure**

(From page 30)

- ④ For long exposure photography within 2 sec. (with ASA 100 film) however, you can take pictures on AUTO mode.

### **Flash Photography**

(From page 31)

#### **(CAUTION)**

- ① If any electronic flash other than the T32 and T20 is used, set the mode selector lever to the "MANUAL ADAPTER" position. (If the mode selector lever is set to "AUTO", the shutter speed responds to available light and may sometimes not synchronize with flash.)
- ② In this case, the viewfinder does not indicate the full flash charge and correct flash exposure.
- ③ For further information, refer to the instruction manual supplied with your electronic flash unit.
- ④ If an electronic flash is used while the optional Manual Adapter is attached, set the shutter speed at 1/30 sec. or slower. For details, read the instruction manual supplied with the Manual Adapter.

### **Using the Winder 2**

(From page 33)

It is not possible to use a Motor Drive 1 with the OM-10.

The viewfinder lights may turn off when using Winder 2 with your OM-10. This is due to the special energy saving circuits built into the OM-10. Simply touch the activator switch (collar surrounding the shutter release), and the lights will turn on. See page 22 for further explanation.

# OLYMPUS®

**OLYMPUS OPTICAL CO., LTD.**

San-Ei Building, 22-2, Nishi Shinjuku 1-chome, Shinjuku-ku, Tokyo, Japan. Tel. 03-340-2211

**OLYMPUS CORPORATION**

Crossways Park, Woodbury, New York 11797, U.S.A. Tel. 516-364-3000

**OLYMPUS OPTICAL CO. (EUROPA) GMBH.**

Postfach 104908, Wendenstrasse 14-16, 2 Hamburg 1, West Germany. Tel. 040-23773-0

**OLYMPUS OPTICAL CO. (U.K.) LTD.**

2-8 Honduras Street, London EC1Y 0TX, England. Tel. 01-253-2772