

E

OLYMPUS **OM-4Ti** INSTRUCTIONS
BLACK

Thank you for purchasing the OLYMPUS OM-4Ti BLACK. This new SLR camera employs titanium—a metal lighter and 6 times stronger than aluminum—in the construction of the main part of the body. It is the world's first 35 mm single lens reflex camera equipped with Multi Spot Metering and our new Full Synchro Flash System. This camera has been designed to facilitate serious photography with professional-level techniques including daylight synchro-flash photography, all with a minimum of effort: Its aim is to expand the sphere of creative photography. We recommend that before using the camera, you read this instruction manual carefully, confirming the instructions on the camera so that you can get the very best performance and service life from your new camera.

Note: All the components of the Olympus OM-4Ti BLACK are carefully designed and their production and assembly is strictly controlled to enhance the unmatched performance of the system. If any interchangeable lenses, flashes, or accessories other than Olympus products are used, Olympus cannot be responsible for poor results or damage of the OM-4Ti BLACK.

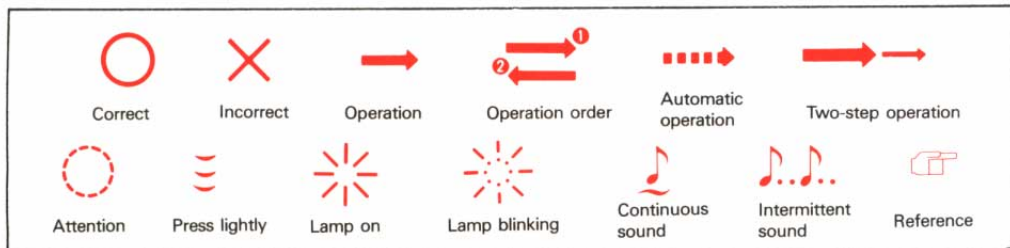

TABLE OF CONTENTS

< Preparation before Taking Pictures >

- Dioptic Correction 5
- Mounting the Lens 7
- Loading the Batteries 9
- Checking the Batteries 11
- Loading the Film 13
- Setting the ISO Film Speed 16

< Taking Photographs (I) >

- Automatic Exposure —
- TTL Direct OTF (Off-The-Film)
Light Metering 19
- Rewinding the Film 23

< Taking Photographs (II) >

- Automatic Exposure —
- How to Use the Spot Measurement 26
- How to Clear the Spot Metering 29
- How to Use the "Multi-Spot Measurement"
Mode 30
- Highlight Control 33
- Shadow Control 36

< Taking Photographs (III) >

- Automatic Exposure —
- How to Use the Exposure Memory
Lock System 40

< Taking Photographs (IV) >

- Manual Exposure —
- How to Take Picture on Center-Weighted,
Averaged Metering 45
- How to Use the Spot Measurement 47

< Taking Photographs (V) >

- Flash Photography —
- Taking Daylight Synchro-Flash Photographs
(Super FP Flash Mode) 51

< Other Operations >

- Using the Self-Timer 56
- Exposure Compensation 57
- Bulb Exposure 58
- How to Shoot when the Batteries
are Exhausted 59
- Using the Viewfinder Illuminator 61
- How to Turn Off the Beeper 62
- Changing the Focusing Screen 63
- Changing the Camera Back 65
- Attaching the Grip 66

TABLE OF CONTENTS

•The Fascinating Results of Creative Exposure and High-Speed Synchronization.....	69	< OM SYSTEM >	
•"OTF" Direct Light Metering	71	•Flash Photography	99
•SPOT Metering (1)	72	•"OTF" AUTO Flash	100
•SPOT Metering (2)	73	•Operation of T-Series Flash.....	100
•AE Lock.....	74	•Main Specification of T-series Flash	101
•Shooting on One-Point Spot Metering	75	•Using Electronic Flashes Other than the T-Series Flash Units	102
•Shooting on Multi-Spot Metering	77	•Bounce Flash	103
•Sophisticated Multi-Spot Metering.....	79	•Shooting with a Motor Drive.....	105
•Highlight Control	81	•Motor Drive Group Units.....	107
•Shadow Control	83	•Recordata Back 4	109
•Memory Function	85	•Chart of Photographic Range	111
•Viewfinder Information.....	87	•Macro Photo Units.....	112
•Application of the Full Synchro Flash F280.....	88	•Finder Group Units	115
•Super FP Flash	89	•Handling Care	119
•Daylight Synchro-Flash Photography	90	•Questions and Answers.....	121
•Exposure Compensation	92	•Description of Controls	126
•Depth of Field.....	93	•Specifications	130
•Preview Button	94		
•Shutter Speeds	95		
•Bulb Exposure	96		
•Multiple Exposures.....	97		
•Infrared photography.....	97		

OM-4 Ti

BLACK

< Preparations before Taking Pictures >

Dioptric Correction

The OM-4Ti BLACK permits dioptric adjustment according to your eyesight.



1 Remove the body cap.



2 Pull out the diopter adjustment knob.

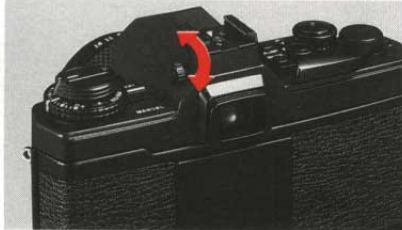

3 Turn and adjust the knob so that the matscreen appears sharp.

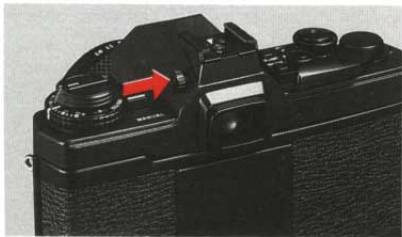
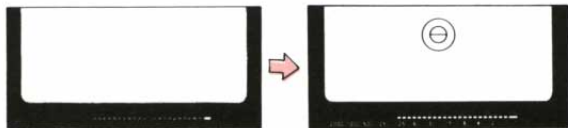

4 Push the knob back in until it locks.

Mounting the Lens



1 Remove the rear lens cap.



2 Align the red dots and rotate the lens clockwise until it locks.



3 Remove the front lens cap. (Press in the mount tabs on the edges of the lens cap parallel with "OLYMPUS").

Removing the Lens:



Press the lens release button and turn the lens counter-clockwise.

Loading the Batteries

Do not use different types of batteries or new and old batteries at the same time. If you are not likely to use the camera for a long period of time, remove the batteries before putting it away.



1 Remove the battery cover.





2 Wipe battery surfaces clean. Make sure that + signs are facing upwards.



Checking the Batteries

Always check the batteries after inserting new batteries, when shooting in cold weather, or if the camera has not been used for a long time.

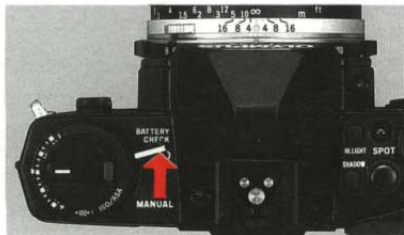

- 1 Rotate the mode selector dial to the "BATTERY CHECK" position.

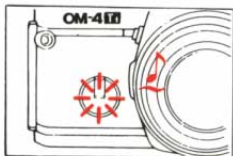

The audible and visual signals will tell you that the batteries have enough power. As the battery power weakens, the signals will become intermittent then vanish completely when they are exhausted. Replace the batteries.

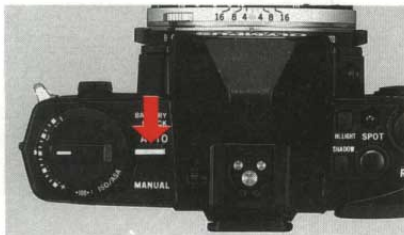

2 After the check, set back the dial.

When checking the batteries, the audible and visual signals will automatically turn off in 30 seconds. If you then press the shutter release, the shutter will trip in the auto exposure mode.

Loading the Film

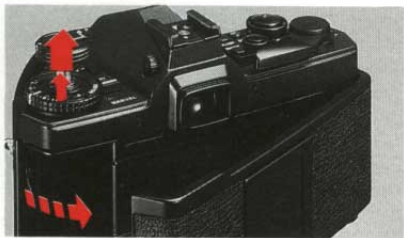

- 1** Pull up on the rewind knob to open the camera back.
- Tear off the top of the film box and insert it into the memo holder. It will remind you which film you are using.

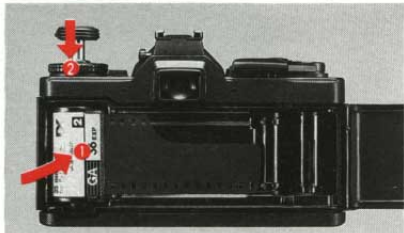
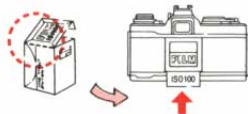

- 2** Insert the cartridge and push down the film rewind knob. (Always load the film in the shade.)



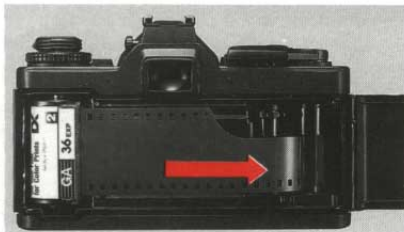

3 Insert the film leader into the take-up spool.

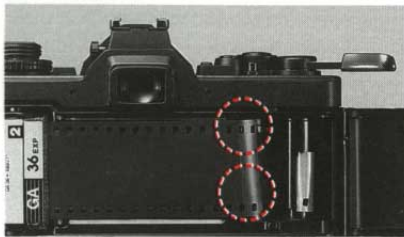
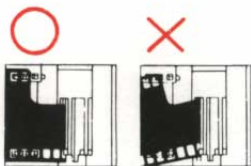

4 Wind the film and make sure the sprocket teeth catch both the upper and lower film perforations.

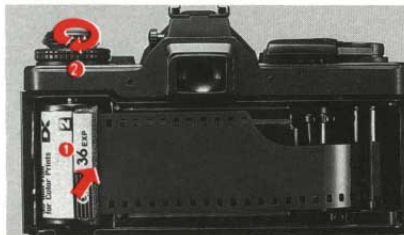

5 Take up the slack by turning the rewind crank clockwise.



6 Close the camera back until it clicks into place.



7 Face the camera toward light and take two blind shots. This will bring the film to the first frame.

○
YES

✗
NO

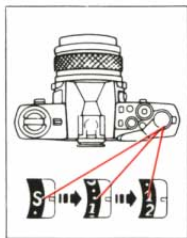
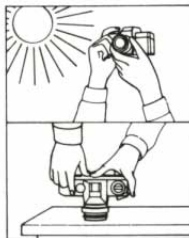

Setting the ISO Film Speed



- 1 Lift up the outer collar and rotate until the ISO speed appears in the window.

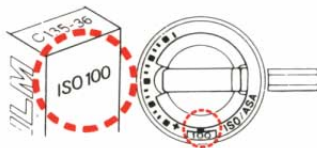

Film speed

(8) (16) (32) (80) (160) (320) (640) (1250) (2500)
6 12 25 40 64 100 200 400 800 1600 3200
(10) (20) (50) (125) (250) (500) (1000) (2000)

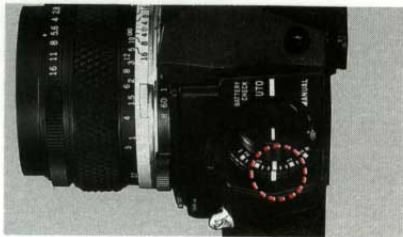

2 Align the exposure line A with the index B.

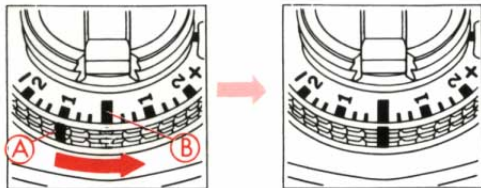

If the exposure compensation dial does not turn to the desired ISO number, set it once at an intermediate value then repeat the procedure.

OM-4Ti

BLACK

< Taking Photographs (I) > — Automatic Exposure —

The OM-4Ti BLACK enables aperture-preferred automatic exposure on TTL direct "OTF" light metering (center-weighted, averaged light metering). This mode can be used for most of the subjects under normal conditions—when shooting with the sun behind you, when the subject contrast is not too strong, and so forth.

TTL Direct OTF (Off-The-Film) Light Metering

Aperture-preferred automatic exposure allows you to take pictures by utilizing the lens depth of field effect (blurred background, for example).  P. 71

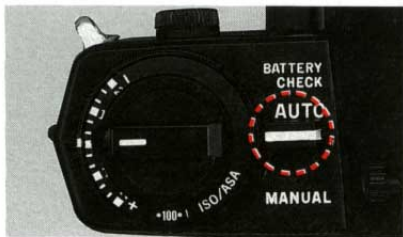



1

Set the mode selector lever to the "AUTO" position.



2 Set the aperture.

 Reference P. 93

ISO 100			
絞り値 (F)	16	8	4
天候			

Basic aperture settings;



3 Press the shutter release lightly to activate the viewfinder display.

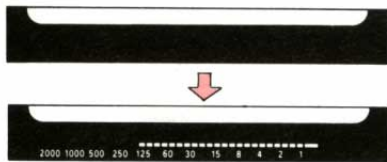

The bar tip indicates the shutter speed.

4

Focus on your subject.



5

Press the shutter release to take the picture.





If you see an overexposure warning signal ("OVER" blinks), set the aperture to a larger number.

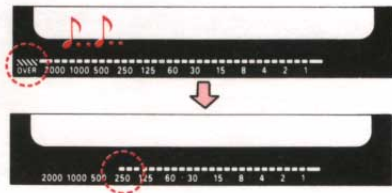

If the shutter speed is too slow, set the aperture to smaller number to prevent camera shake.

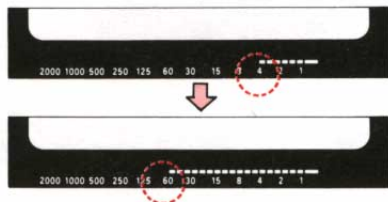

battery converter turns off the viewfinder display after 120 sec.

Rewinding the Film



1 When the exposure counter indicates the end of your roll of film.



2 Push the "R" button.

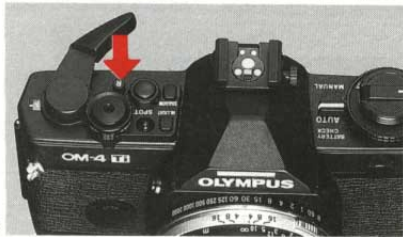



3 Fold out the rewind crank and wind it until the film tension is released.



4 Open the camera back by pulling up on the rewind knob and remove the film.

OM-4Ti

BLACK

< Taking Photographs (II) > **— Automatic Exposure —**

The spot metering system of the OM-4Ti BLACK enables you to control the exposure as you like. It insures perfect exposure of backlighted and high contrast subjects and expands shooting possibilities in the auto mode for more creative photography.

How to use the Spot Measurement

Reference
P. 72 – 76



- 1 Align the microprism area with the area you want to measure. (The spot metering range is outlined by the outer edge of the microprism.)



Spot metering range

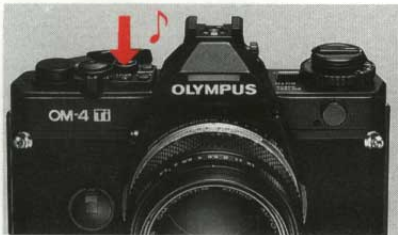

2 Press the spot button to take meter reading. You will hear an electronic sound and the word "SPOT" will appear in the viewfinder. The metered value is displayed by the "◇" mark.



If you shift the camera, another "◇" mark will indicate the exposure value in the center of the frame along with the spot metered value.

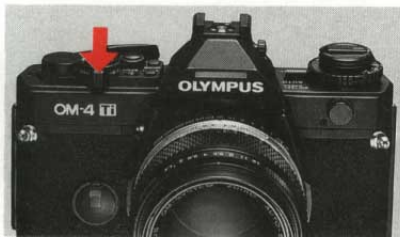

3 Press the shutter release to take the picture.



4 The subject will turn out correctly exposed, regardless of the brightness of the background.

The spot metering mode will be automatically cleared after the shutter has tripped, or after 120 seconds have passed, and it will return to the, TTL direct light metering mode.

How to Clear the Spot Metering



- 1 With the lever at "CLEAR", the mode will return to TTL direct light metering.

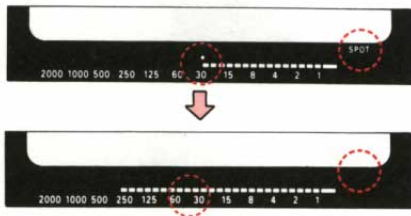

"SPOT" and "◇" mark disappear.

How to Use the “Multi-Spot Measurement” Mode

 Reference
P. 77 – 80

Spot metering is possible in up to 8 spots.



This sample photo shows a backlighting subject.

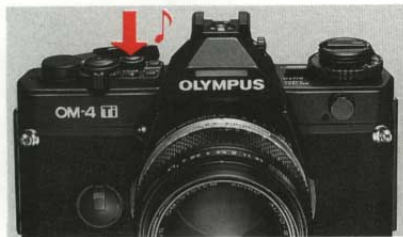

1 Take spot metering on the face (first spot).

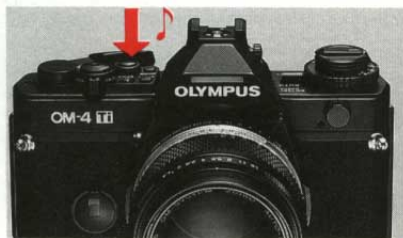
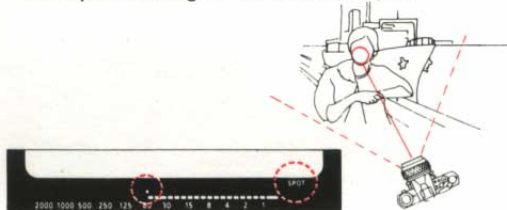

2 Take spot metering on the ship in the background (second spot).

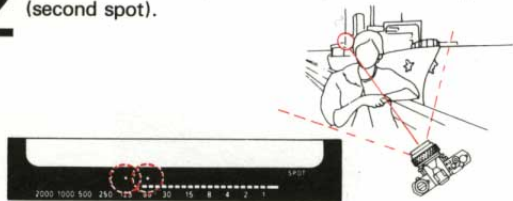



3 Compose your picture and press the shutter release.

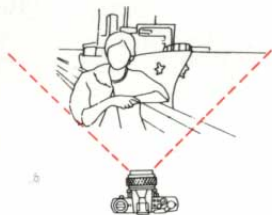

Both the subject and the background are correctly exposed.



To cancel the metered value, operate the clear lever.

Highlight Control

 Reference
P. 81 – 82

If you want to render white objects in white...

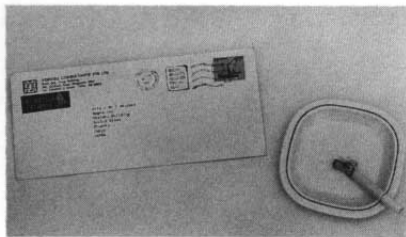

In ordinary shooting, white objects will turn out grayish if the picture is taken in strong brightness over the entire frame.

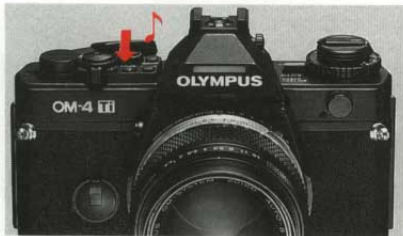

- 1 Take spot metering on the part of the subject which you want to render in white.

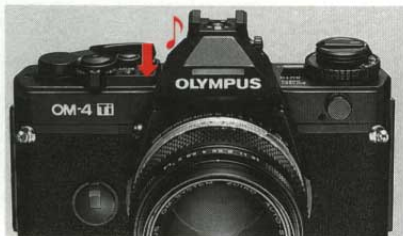
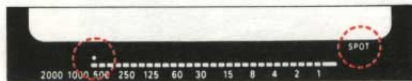

- 2 Press the HI.LIGHT button.



Exposure will be automatically corrected to give 2-step overexposure.

3 Press the shutter release to take the picture.

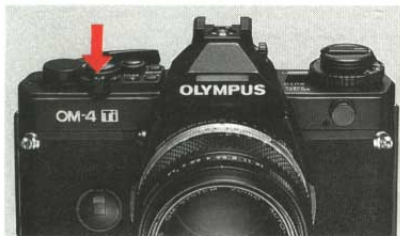

The white object turns out white.

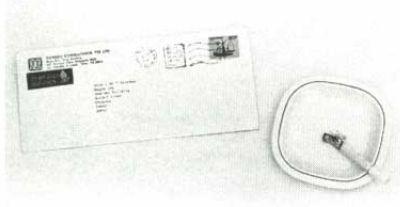

The highlight control is cleared by pressing the HI.LIGHT button once again. To cancel the metered value, use the clear lever.

Shadow Control

 Reference
P. 83 – 84

If you want to render black objects in black...



In ordinary shooting, black objects will turn out grayish if it is very dark over the entire picture frame.



1 Take spot metering on the spot which you want to render in black.



2 Press the SHADOW button.



Exposure will be automatically corrected to give 2 2/3-step underexposure.

3 Press the shutter release to take the picture.



The black object turns out black.



The shadow control is cleared by pressing the SHADOW button once again. To cancel the metered value, use the clear lever.

OM-4Ti

BLACK

< Taking Photographs (III) > — Automatic Exposure —

In automatic exposure, the same picture will be exposed with a very different exposure value if it is taken in different backgrounds. The OM-4Ti BLACK has an exposure memory lock system to solve this problem. It can be used in both the TTL direct "OTF" light metering and spot metering modes. Once an exposure value is stored in memory, it does not vary even if you change the aperture (or shutter speed).

How to Use the Exposure Memory Lock System

Reference
P. 85 — 86

The memory lock system is convenient for taking many pictures of the same subject in different backgrounds or costumes.



- 1 Operate the lever to set up the memory mode. The letters "MEMO" will appear in the viewfinder and the memory signal will blink twice.

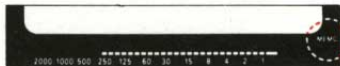

2 Frame the composition as you desire.



3 The exposure value is stored in memory after shooting. The "MEMO" in the viewfinder will start to blink and the memory signal will blink only once.

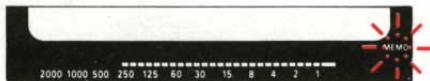

The memory will keep on for 60 minutes after the shutter has tripped.

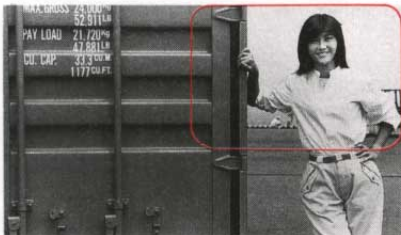

4 Change the composition and shoot.



5 The subject is exposed with the same exposure value even if you change the composition.

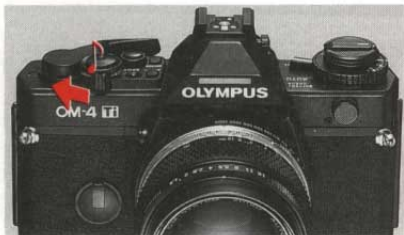

6 To clear the memory, use the clear lever.

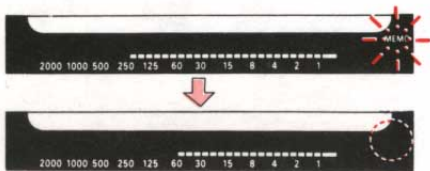

The memory is also cleared in the following cases:

1. When a lens is mounted or dismounted.
2. When the mode lever is switched.
3. The memory is automatically cleared in 60 minutes after the shutter has tripped.

OM-4Ti

BLACK

< Taking Photographs (IV) > **— Manual Exposure —**

The OM-4Ti BLACK permits manual exposure on center-weighted, averaged metering and spot metering. It allows you to choose the optimum aperture and shutter speed which suit your subject and taste.

How to Take Pictures on Center-Weighted, Averaged Metering



- 1 Set the mode selector dial to the "MANUAL" position.

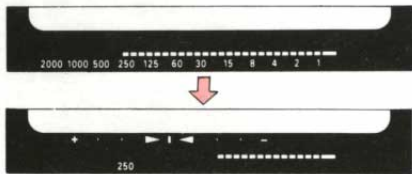



- 2** Set the bar graph tip to the fixed point between the arrows by adjusting the aperture and/or shutter speed rings.

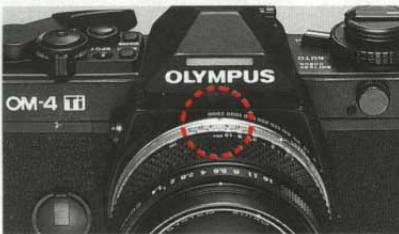
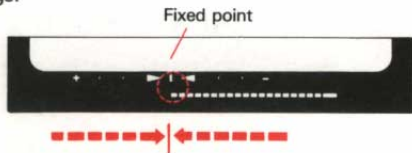

- 3** The shutter speed you have set will be displayed in the viewfinder.

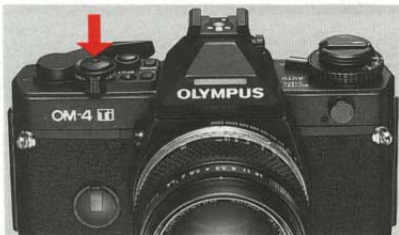
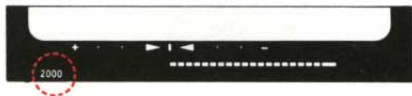

- 4** Shoot.

How to Use the Spot Measurement

Reference
P. 72—76



- 1 Align the microprism area with the area you want to measure.

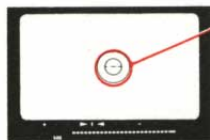

Spot metering range



2 Press the spot button to take meter reading.

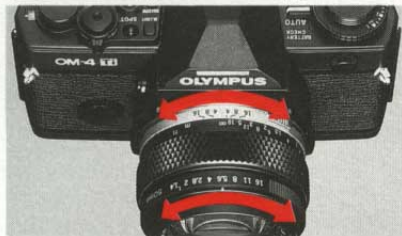
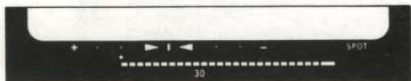

3 Set the bar graph tip to the fixed point between the arrows by adjusting the aperture and/or shutter speed rings.

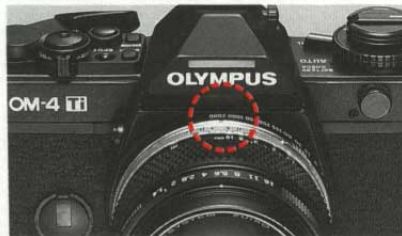
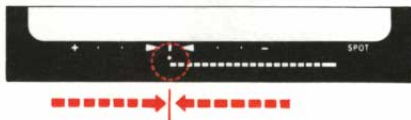

4 The shutter speed you have set will be displayed in the viewfinder.

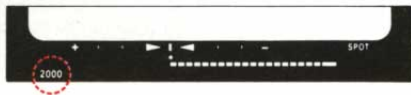



5 Shoot.



6 The subject will turn out correctly exposed, regardless of the brightness of the background.

It is also possible to use the multi-spot metering, highlight control and shadow control. In any case, correct exposure is obtained by simply setting the bar graph at the fixed point.

OM-4Ti

BLACK

< Taking Photographs (V) > **— Flash Photography —**

The OM-4Ti BLACK is the perfect companion for the world's first Full Synchro Flash F280. Professional standards are within the reach of every owner, even during daylight synchro—flash photography—an area which has traditionally required considerable skill.

Taking Daylight Synchro-Flash Photographs (Super FP Flash Mode)

For OTF Auto using the Normal OTF Flash mode, refer to the F280 instruction manual.

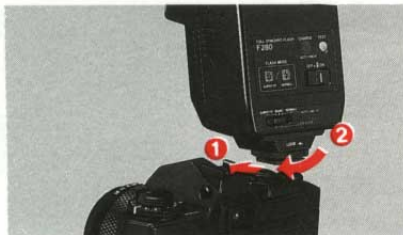

- 1 Slide the F280 into the accessory shoe and secure it with the lock screw.

2 Turn the power switch ON.



3 Check the charge indicator.

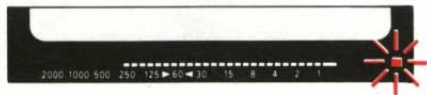

4 Set the mode switch to SUPER FP.



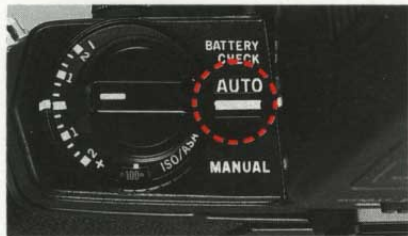

5 Set the camera mode to AUTO.



6 Select an aperture that results in a shutter speed faster than 1/60 sec. (for slower speeds consult the F280 manual).



7 Press the shutter release.



8 Confirm a correct exposure by checking the indicator.

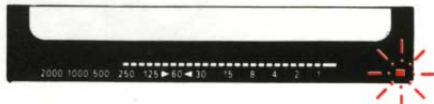

OM-4Ti

BLACK

< Other Operations >

Using the Self-Timer



1 Push the lever down outward.



2 Press the shutter release to start the self-timer. The shutter will fire in 12 seconds.

The shutter will trip immediately if the self-timer lever is returned while it is running.

Exposure Compensation

Reference
P. 92



- 1** When an exposure compensation is set, the indicator lights in the viewfinder.

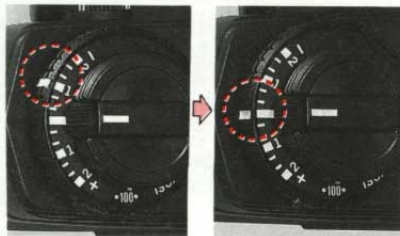
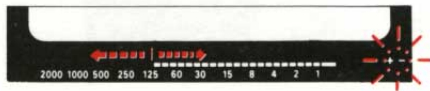

- 2** After shooting, return the dial to its original position.

Bulb Exposure

 Reference
P. 96



- 1 While pressing the "B" lock button, turn and set the shutter speed dial to "B".

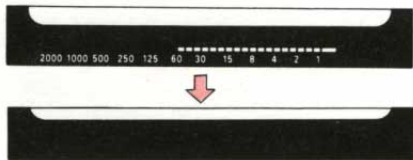

The display in the viewfinder disappears.



2 The shutter will remain open as long as the shutter release button is held depressed.

How to Shoot when the Batteries are Exhausted

If the batteries are exhausted and you do want to take pictures immediately, use the mechanical shutter speed of 1/60 sec.



1 While pressing the "B" lock button, rotate the shutter ring to the red "60" position.



2 Shoot. The mechanical shutter will operate to trip at 1/60 sec.

You cannot use the motor drive, winders and flashes with the mechanical shutter.

Using the Viewfinder Illuminator



- 1 Push the button if the viewfinder display is too dark to read.

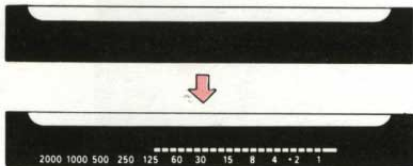

How to Turn Off the Beeper



- 1 To turn off the audible signal, push the lever to the right (in the direction of the arrow).

You will no longer hear PCV sounds when turning on the spot metering, highlight and shadow controls, when operating the memory/clear lever, checking the batteries, or when mounting and dismounting the lens.

Changing the Focusing Screen



Reference
P. 115 – 116

14 screens are available to cover a wide range of applications.

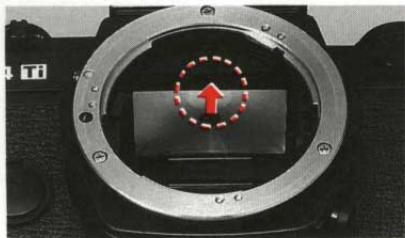

- 1** Pull down the screen frame.
Pull the lug at top inside the body mount toward you to swing down the screen frame.

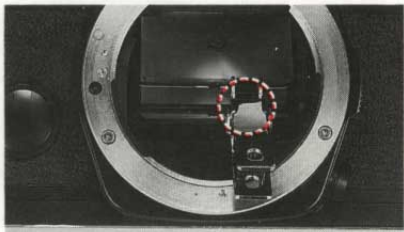

2 To change the focusing screen, use the tweezers supplied with an optional focusing screen. Push the frame upward until you hear a click.

Changing the Camera Back

The camera back is interchangeable with the Recordata Back or 250 Film Back.

 P. 109



- 1 Open the camera back. Press down on the camera back release button and remove the camera back.

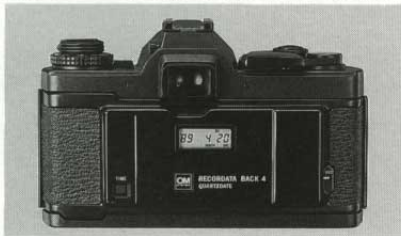

Removing

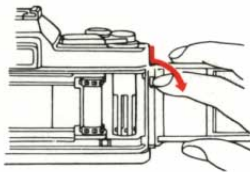

Attaching

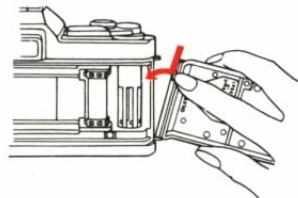

Attaching the Grip

1 Attach the Camera Grip 1 (optional accessory).

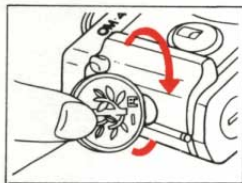

When using a motor drive or winders, detach the Grip.



NICOLETTA
TAVERN
RESTAURANT

Playmate Boutique

MOZZO

RISTORANTE

DUKES
MUSIC

DANCING
MUSIC

DUKES
MUSIC

DANCING
MUSIC

DANCING
MUSIC

DANCING
MUSIC

OM-4 Ti

BLACK

< For Your Creative Photography >

THE FASCINATING RESULTS OF CREATIVE EXPOSURE AND HIGH-SPEED SYNCHRONIZATION

By Akio Kojima

Have you always been satisfied with the results of determining an exposure in accordance with an Automatic Exposure (AE) system? We suppose not. The reason you may sometimes find that an AE exposure is not as you may have expected is that most AE systems are designed for the particular characteristics of the camera, and not those of the photographic subject. Often, the subject's brightness range and contrast level are ignored in the calculation of the exposure, even though there are many situations in which there are large differences between the brightest and darkest spots. In some landscape scenes, for example, there can be a difference of 10 Exposure Values (EV) or more, while a typical color reversal film can accurately reproduce variations over a range of only 5EV. Many cameras, then, are simply incapable of providing an AE system that can help the photographer realize a photographic idea.

To be able to control exposure so as to emphasize certain tones in a composition, a photographer needs to have the option to select a certain tone as an index for the exposure; effectively, to match the tone to the exposure range of the film. To meet the varied exposure requirements that this entails, three methods of exposure calculation are generally employed. The center-based method matches the center of the

subject's brightness range with that of the film, and if the brightness range of the subject is greater than that of the film, the extremes are ignored.

The shadow-based method of exposure calculation gives highest priority to the darker areas in the subject's brightness range so that highlight areas that do not fall in the exposure range are ignored. On the other hand, the highlight-based method gives priority to the highlight areas so that areas of shadow come out somewhat darker as a result. Advanced photography requires all three methods. But the photographer who wishes to employ them must usually be prepared to make a number of hand-held meter readings as well as a series of time-consuming, not to say tedious, calculations before almost every exposure. Not so the user of the OM-4Ti. Employing the Multi-Spot metering system which enables the built-in "OTF" metering system to meter one or several spots in the composition, the OM-4Ti calculates the exposure automatically, leaving the photographer to the more serious concern of creative composition. But while this is a great advance on the old methods, yet more awaits the OM-4Ti user.

While the Multi-Spot metering of the OM-4Ti gives the photographer greater artistic freedom, exposures in conditions of high contrast or wide brightness ranges will inevitably result in a loss of some of the

composition's detail. In certain cases this is in line with the photographer's intention, but when it is not, fill-in flash is required to dissolve areas of shadow. In many cases, however, using a flash in this manner can create more problems than it solves.

In general, the use of a fill-in flash in daylight synchro-flash photography severely restricts the photographer's creative options. As most flash units synchronize at very slow speeds when used with SLR cameras, usually 1/60 sec., the use of such units in daylight compels the photographer to select a small aperture and, as a result, a greater depth of field than might be appropriate. In some cases it may not be possible to stop-down (close the aperture) far enough, effectively preventing daylight synchro-flash in the summer or in tropical areas. What is more, being forced to select a slow shutter speed means that the photographer is wholly unable to freeze any movement occurring within the frame of the composition.

These problems for focal-plane shutter cameras have given rise to a number of attempts to increase synchronizing speeds by changes in the shutter mechanisms. The results have been unimpressive, with 1/250 sec. being the maximum speed so far attainable. The Olympus approach, however, has been different; and the results revolutionary. Rather than trying to modify the shutter system, Olympus

has changed the characteristics of the flash emission to produce a longer flash duration—one which is up to forty times longer than a conventional flash and which, as a result, can synchronize with speeds of up to 1/2000 sec.

By being able to use the new Full Synchro Flash F280, the OM-4Ti offers a daylight synchro-flash capability that requires no creative compromise of the user; you can use the camera just as though the flash were not connected. Synchro-flash photography is possible even in very bright sunlight, and even when there is a great deal of movement within the composition, as in sports events, for example. Additionally, the freedom to select an aperture to create a specific mood or emphasis in a photograph returns to the photographer one of the most important of the photographic techniques.

The OM-4Ti's capacity to employ the Full Synchro Flash System will provide a new stimulus to the creative instincts of those who have been forced to accustom themselves to the restrictive combination of conventional flash units and SLR cameras. The Full Synchro Flash System and the OM-4Ti offer the photographer a photographic world without limit.

OTF (Off-The-film) DIRECT LIGHT METERING

(Center-weighted, averaged light metering)

Exposure is controlled by directly measuring the brightness of the subject off the film plane itself. Developed by Olympus, this is the world's first "OTF" direct light metering system able to respond automatically and accurately to sudden changes in light during the actual exposure. It is perfect for most normal scenes, especially those with even illumination. Combined with a T-series flash, the OM-4Ti also provides for full control of the electronic flash by "OTF" Auto direct light metering at any aperture, thus eliminating all troublesome exposure calculations.

Such sophisticated techniques as multi-flash and bounce flash can be used in the full-automatic mode.

The direct light metering system also solves difficult exposure problems in macro-photography.

Combined with the newly developed Full Synchro Flash F280, the camera offers

two "OTF" Auto flash exposure modes. In the Normal "OTF" Auto mode, also offered on all T-series flashes, proper exposure is achieved by controlling the quantity of light at a shutter speed of 1/60 sec. or slower. However, in the new Super FP Flash mode, where all shutter speeds up to 1/2000 sec. are available, correct exposure is achieved by

controlling the shutter speed.

By employing the "OTF" direct light metering system and offering Multi Spot metering as well as the capacity to connect to the Full Synchro Flash, the OM-4Ti can give you total control over all light conditions.

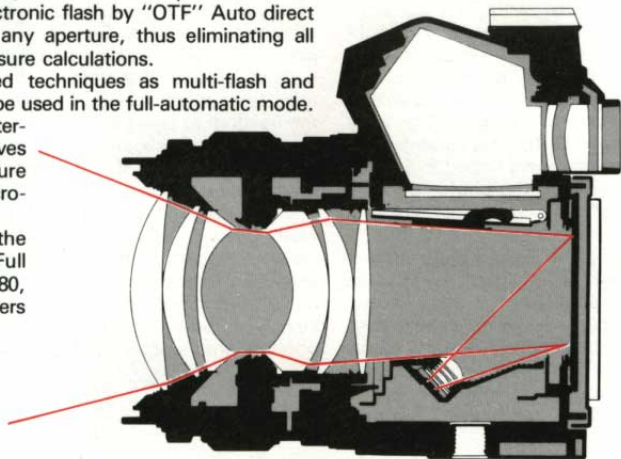

SPOT METERING (1)

This spot metering system measures the brightness of the central spot of the picture frame (2% of the entire frame).

The direct light metering provides correct exposure for subjects in follow light and in pictures having a nearly uniform brightness on the entire frame. Exposure compensation is necessary, however, for backlit subjects and in compositions using special lighting in which there is a difference in brightness between the subject and background. In some cases, it would also be desirable to express subtle lighting effects according to the photographer's subject

motive. To realize such sophisticated expressions, fine metering of various spots on the subject is required. If the "Spot" button of the OM-4Ti is pressed, the metering mode switches to spot metering in which the brightness of the area (corresponding to the microprism section in the center of the viewfinder) is metered and stored in memory. By using this spot

metering, photographers can control exposure as desired to realize creative lighting compositions.

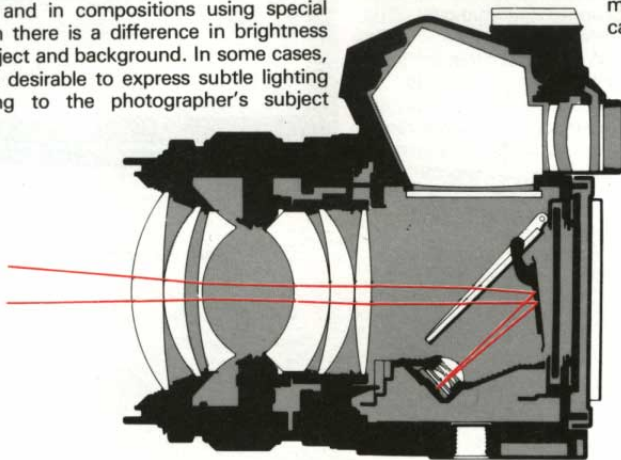

SPOT METERING (2)

To ensure correct operation of the spot metering:

- ① In spot metering, it is necessary to put the area to be metered in the microprism section. If there is a brighter spot in the microprism section, than the intended subject, the metering value will be affected.
- ② If a lens is changed, the light receiving angle for spot metering also changes automatically. The angle is narrower with telephoto lenses, and wider with wide angle lenses. However, the metering area seen in the viewfinder does not change.
- ③ When a zoom lens is used, Spot Metering on the telephoto side permits metering in narrower range and that on the wide angle side in a wider range, thus allowing the users to choose the metering range freely.

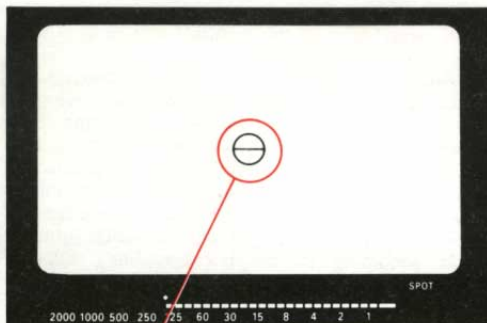

Spot metering area

AE LOCK



① Spot metering

In the auto mode, the AE lock enables a spot-metered value to be stored in the camera memory until the shutter trips.

As soon as the "Spot" button is pressed, the brightness of the metered spot is locked by the AE lock. Because the AE-locked value remains in memory for 120 seconds, the shutter is released with the spot-metered value if you frame your picture and shoot during this period. Even if the aperture is changed after the AE lock is activated, the exposure level remains fixed because the shutter speed changes accordingly. Exposure compensation (\pm) for the metered value is also possible. Only the bar graph will shift depending on the amount of compensation made. (The inputted dot will not shift.) After shooting, the AE lock is automatically released and the camera returns to "OTF" direct light metering (center-weighted averaging light metering). To cancel spot reading, operate the clear



② Framing

lever and make a spot input again. The AE lock is automatically released in 120 seconds without operating the clear lever.



SHOOTING ON ONE-POINT SPOT METERING



This is partial metering of only one point on the picture frame. In the auto mode, correct exposure is obtained by simply pressing the shutter release after pressing the spot button. (In the manual mode, press the spot button and set the bar graph at the fixed point.)

We will give a simple example to explain when one-point spot metering is used. If a backlit girl is exposed on averaged light metering, the expressions in her face will not be clear because it comes out entirely underexposed under the effect of sunlight. For correct exposure of her face, it is recommended to make a one-point spot metering on it. Conven-



tional exposure operations based on the photographer's experiences and guesswork have thus been completely eliminated to facilitate exposure compensation in backlight. As soon as the spot buttons is pressed, the brightness of the spot area is locked. So you can frame your picture as you like. When the shutter is released, the camera returns to center-weighted averaging light metering. To clear the AE-locked value, operate the clear lever and make spot metering again.



SHOOTING ON MULTI-SPOT METERING



This is a partial metering of two or more spots on the picture frame. It can be used to determine exposure by taking into account various spots that differ in brightness. The picture above shows an example in which the exposure of the background should also be considered while taking care to prevent underexposure of a girl. The first spot metering is made on her face by bringing it in the microprism section. Then the second spot metering is made on her dress by directing the camera. Exposure is determined from the average of the two metered values to meet the photographer's requirement. (In the manual mode,



the picture is taken by setting the bar graph tip at the fixed point.) It is also possible to input more than two points in the same procedure. Metering is possible as many times as you want, but the camera's AE lock allows only up to eight points to be stored in memory. If more than eight points are inputted, the last eight points are stored as a basis for determining the exposure value.

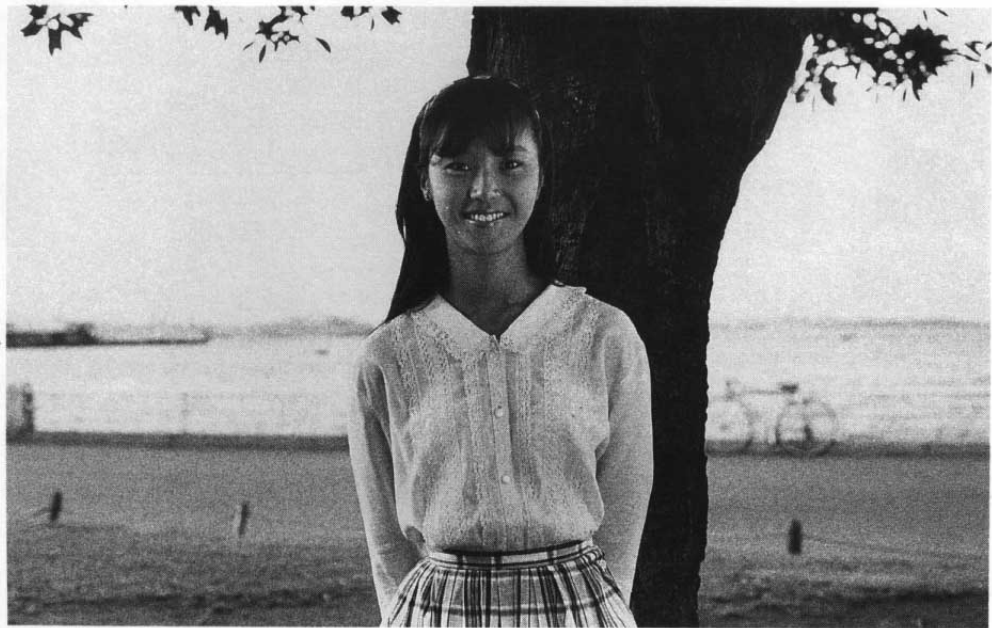

SOPHISTICATED MULTI-SPOT METERING



The OM-4Ti's multi-spot metering system provides highly sophisticated light measurements. Let us take an example in the picture above. If you want to place emphasis on the exposure of the girl, taking the background brightness into consideration, too, you can take two spot meterings on her face and one spot metering on the background, for instance. Exposure is determined from the average of these three values, with greater emphasis on the girl (a 2:1 lighting ratio). With this system, photographers can weight their exposures so as to make sure the prime subject is exposed properly and the secondary subject is con-

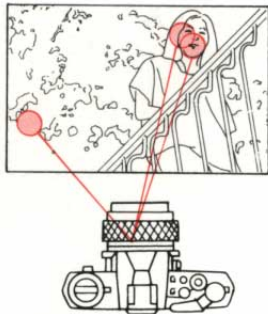

sidered. This is now done without guesswork, in a straightforward easy to understand manner.



HIGHLIGHT CONTROL

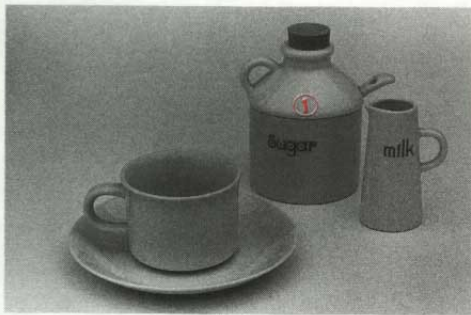

The Highlight button enables white objects to come out white. It is very useful for copy work and shooting light or white subjects on the whole. After spot metering is made on the white subject, then press the Highlight button. The exposure value needed for rendering it in true white will be automatically calculated and set.

In the example picture, the brightest spot of the tableware has been metered on spot metering. Pressing the Highlight button increases exposure and provides the correct overall exposure to make the tableware white and not a dullish gray.

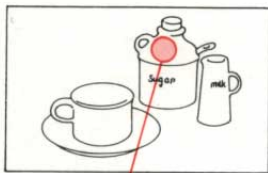

If the Highlight button is pressed again after the "highlight control" is once set up, only the "highlight control" is released and the camera returns to spot metering. To reset center-weighted averaging light metering, operate the Clear lever.

*If the Highlight button is pressed after several spots have been measured the exposure value for the brightest spot only will be adjusted.



SHADOW CONTROL



The Shadow button enables black objects to accurately come out black. It is very useful for shooting dark or blackish subjects on the whole.

After a spot metering is made on the black subject, then press the Shadow button. The exposure value needed for rendering it in a rich black will thus be automatically calculated.

In the example picture, the deep shadow area beside the dial has been inputted. As a result, the black portion comes out "black" without being grayish. By using this function, it is possible to express subtle tone variations on the dark area which would be

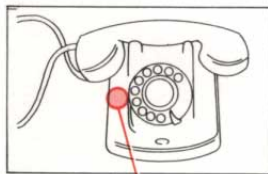

ignored in ordinary photography because they would appear as a dark gray without detail.

If the Shadow button is pressed again after the "shadow control" is already activated, only the "shadow control" is released and the camera returns to spot metering. To reset center-weighted averaging light metering, operate the Clear lever.

*If the Shadow button is pressed after several spot inputs, the exposure value for the darkest spot only will be adjusted.



MEMORY FUNCTION (AUTO MODE)

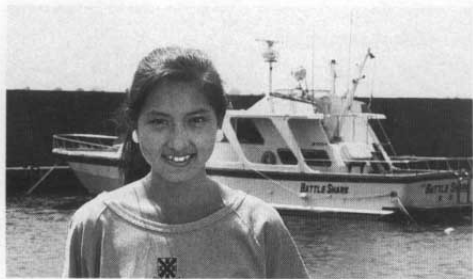

This function enables the camera to store in memory, the exposure level at which a picture was actually taken. It can be used on either center-weighted averaging light metering or Multi-Spot Metering. It is very convenient for shooting a series of pictures at an exposure level determined by the photographer.

Even in photographs of a subject taken under the same illumination, the exposure level of her face may vary significantly if she is taken in different dresses because it is influenced by the brightness of the dress. However this camera can keep the exposure level of her face in memory once it has been inputted, so a number of pictures can be taken at a fixed exposure level even if there are substantial changes

in dress and the background. This function can be used for panorama photography, too. The memory function also allows you to choose your desired aperture or shutter speed without changing the exposure level in memory. In portraits and macro-photographs which utilize the depth of field effect, it is also possible to change the depth of field continuously with the exposure level fixed. In addition, this function is indispensable in motor drive shooting in spot metering mode.

The memory is automatically released about 60 minutes after shooting. To release it earlier, operate the Clear lever.



In panorama photography, the exposure level will differ as shown in the above three photographs taken without using the memory lock, because the shooting conditions vary with the camera angle.



With the memory lock, the exposure level can be kept constant as shown in these sample photos even if the shooting conditions are different.

VIEWFINDER INFORMATION

The OM-4Ti shows the shooting information clearly on a large-size liquid crystal display so that you can concentrate your attention on the subject in the viewfinder. The viewfinder information is different in the auto and manual modes as shown below.

Viewfinder Information for Auto Exposure

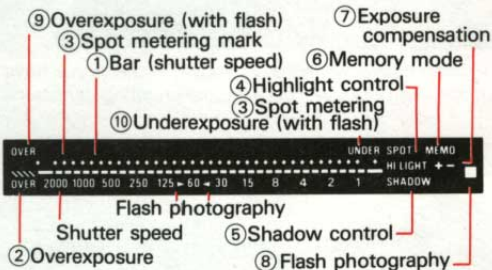

① Analog display of metered value by bar; ② "OVER" blinks in case of overexposure; ③ "SPOT" turns on at the time of spot metering; inputted metered value and luminance value during metering is displayed by dot; ④ "HI.LIGHT" turns on when highlight button is pressed; ⑤ "SHADOW" turns on when shadow button is pressed; ⑥ In memory mode, "MEMO"

turns on with memory standby and blinks after shutter has tripped; ⑦ "+ -" turns on to indicate exposure compensation; ⑧ Green LED turns on when flash is fully charged; and blinks to indicate correct exposure; ⑨ "OVER" blinks in case of overexposure with flash; ⑩ "UNDER" blinks in case of underexposure (with T-series and F280 (Normal OTF mode) flash).

Viewfinder Information for Manual Exposure

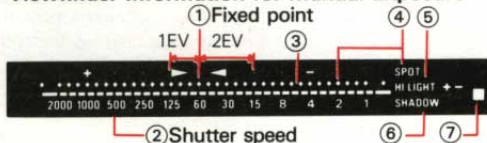

① Fixed point for correct exposure is displayed; ② Shutter speed which is set; ③ Analog display of metered value by bar; ④ "SPOT" turns on at the time of spot metering; inputted metered value and luminance value during metering is displayed by dot; ⑤ "HI.LIGHT" turns on when highlight button is pressed; ⑥ "SHADOW" turns on when shadow button is pressed; ⑦ Green LED turns on when flash is fully charged, and disappears on full firing (with T-series and F280 (Normal OTF mode) flash).

APPLICATION OF THE FULL SYNCHRO FLASH F280



The restricting combination of focal-plane shutter and conventional flash technology that has limited flash synchronization speeds (usually to 1/60 sec. and never above 1/250 sec.) has been broken by OLYMPUS' successful attack on the very heart of the problem: the short duration of the flash emission time. By prolonging the flash duration and producing what it calls a Super FP Flash emission, OLYMPUS has produced the world's first 35 mm SLR flash system which, when attached to the OM-4Ti, is capable of synchronizing with speeds of up to 1/2000 sec. The OM-4Ti has been designed to take full advantage of this revolutionary technology, and is ready to liberate photographers from a number of technical chores including the tiresome and difficult techniques required by daylight synchro-flash photography.

Until now, even with the very best flash systems it has been difficult to balance electronic flash and natural light especially in conditions of strong backlight—all too often the result has been an over-exposed picture. Additionally, the choice of aperture has been severely limited, resulting in a narrowing of creative possibilities. The new Full-Synchro Flash F280, however, provides the solution to this problem, and more. With it, everyone can enjoy professional quality results and a creativity that would have been impossible with previous 35 mm SLR camera systems.

Super FP Flash

In a camera employing a focal-plane shutter, high shutter speeds are achieved by a system that results in adjacent areas of the film being exposed successively through a narrow slit (Fig. 1)—in effect, the light moves across the surface of the film. This poses problems for conventional flash units: as the duration of the flash emission is 1/1000 sec. or less (Fig. 2), at shutter speeds above 1/60 sec., only part of the film surface will receive the increased light from the flash unit. For this reason, conventional flash units are usually synchronized with shutter speeds of 1/60 sec. or slower. At these shutter speeds there is a point in time when the whole area of the film surface is exposed simultaneously, and it is at this time that the flash fires. However, the new OLYMPUS Full Synchro Flash F280 overcomes the high shutter speed synchro problem by extending the duration of the flash emission.

Fig. 1

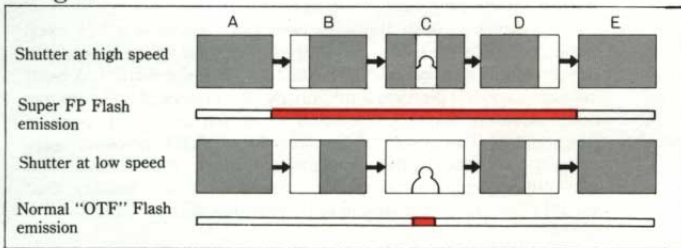

○Normal "OTF" flash emission: Low speed—synchronized at C, High speed—synchronization impossible (Shutter curtain forms a slit which covers part of C)

○Super FP Flash emission: High speed—synchronized B—D

This means that at high speeds the flash will begin firing before any part of the film is exposed to light, and stop only after the shutter has fully closed. This new form of electronic flash, called a Super FP Flash emission, is now available as a second "OTF" controlled alternative with the Full Synchro Flash System.*

An example of when to use of the Super FP Flash setting is in daylight synchro-flash photography. With "OTF" Direct metering, the combination of flash and natural light can be metered at the beginning of the exposure and, because of full synchronization, an appropriate speed automatically selected for a perfect exposure.

*In addition to Manual, two OTF controlled modes are available: Normal "OTF" and Super FP.

Fig. 2

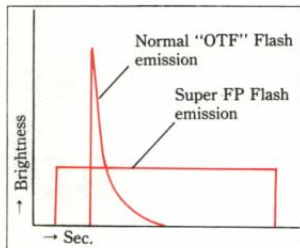

DAYLIGHT SYNCHRO-FLASH PHOTOGRAPHY

Daylight synchro-flash photography utilizing the Super FP Flash mode of the Full Synchro Flash F280 has excellent characteristics, as can be seen by comparing the photographs on the right with those on the following page. The Photo B result from the use of conventional flash emissions, while photo A and Photo C, D, E, result from the use of the Super FP Flash emission method. When using a Normal "OTF" flash emission, the aperture must be stopped down to compensate for the slow shutter speed, and as a result the depth of field is increased to include often distracting background features. However, when using the Super FP Flash mode, which allows you to select the aperture without any concern for the shutter speed, you are free to include or exclude background features. As a result of this new creative freedom, you can exclude background detail even when shooting a portrait with strong backlight, as can be seen from the example. Furthermore, you need no longer live in fear of excessive flash illumination: automatic shutter speed control ensures perfect exposure. All of which means, natural daylight synchro-flash photography is now within the reach of everyone.

Photo A



Photo B



© When using daylight synchro flash in a backlit situation.

Shoot with Super FP Flash mode to make up for the difference between the brightness of the subject and background. Use daylight synchro flash as you desire, such as freezing the movement of water by using a high shutter speed. Although very difficult with a conventional flash emission, a blurred background is easily attained with the Super FP Flash. This flash mode allows truly creative flash photography.

ⓓ ⓔ When using flash to express movement by blurring.

Conventional flash emissions stop movement, but the Super FP Flash mode allows you to express movement, as shown in these pictures. so it is possible to combine flash photography with a slow shutter speed to lend a sense of movement to your photos.



MAIN SPECIFICATIONS OF F280

Guide number	28 (ISO 100. meters at Normal "OTF" Flash)
Coverage angle	53° vertical. 74° horizontal
Number of flashes	(with R6 (AA) alkaline batteries) Super FP Flash mode:80 ~ 260 firings Normal "OTF" Flash mode:80 ~ 600 firings MANUAL:80 firings
Emission time	Super FP Flash mode 20 ~ 40 milliseconds Normal "OTF" Flash mode 25 micro seconds ~ 1 millisecond
Dimensions	110(H) × 68(W) × 71(D)mm (4.3" × 2.7" × 2.8")
Weight	250 grams (8.8oz)

Specifications subject to change without notice.

EXPOSURE COMPENSATION

The OM-4Ti also permits exposure compensation with an Exposure Compensation Dial. If the background is brighter than the subject, turn the dial and set it to a (+) side position. The amount of exposure is double on (+1) position, and four times on (+2) position. If the background is darker than the subject, turn the dial and set it to a (-) position.

If the compensation dial is turned, the + / - display in the viewfinder blinks. The bar graph display shifts according to the amount of compensation.

*Compensation dial operated after spot metering:
Only the bar graph shifts.

Compensation dial operated in memory condition:
The bar graph shifts to make compensation, based on the exposure level stored in memory.

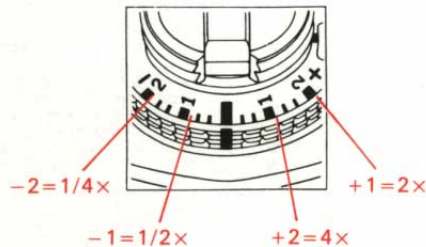

DEPTH OF FIELD

Depth of field is the area of acceptable sharpness in front of and behind the subject in focus. As you get closer to your subject or as you open your lens (e.g. from F16 to F2.8) the depth of field becomes shallower. By stopping your lens down (e.g. from F2.8 to F16) or getting farther away from your subject this depth of field can be increased.

The table below shows that when the camera-to-subject distance is 3m, the depth of field at F16 ranges from 1.93m to 6.93m.

As you press the preview button, looking through the viewfinder, you can ascertain the actual depth of field.

Depth of Field Table (F1.8 & F1.4 50mm lenses)

Circle of least confusion 1/30mm

Scale	Camera-to-Subject Distance (m)									
F Stop	0.45	0.5	0.7	1	1.5	2	3	5	10	∞
1.4	0.45 -0.45	0.50 -0.50	0.69 -0.71	0.99 -1.02	1.47 -1.54	1.94 -2.07	2.86 -3.16	4.61 -5.46	8.55 -12.05	57.78 - ∞
1.8	0.45 -0.45	0.50 -0.50	0.69 -0.71	0.98 -1.02	1.46 -1.55	1.92 -2.09	2.82 -3.20	4.56 -5.60	8.21 -12.79	45.05 - ∞
2	0.45 -0.45	0.50 -0.50	0.69 -0.71	0.98 -1.02	1.45 -1.55	1.91 -2.10	2.80 -3.23	4.47 -5.68	8.05 -13.20	40.57 - ∞
2.8	0.45 -0.45	0.49 -0.51	0.69 -0.71	0.97 -1.03	1.43 -1.57	1.88 -2.14	2.73 -3.33	4.28 -6.01	7.47 -15.15	29.02 - ∞
4	0.44 -0.46	0.49 -0.51	0.68 -0.72	0.96 -1.04	1.41 -1.61	1.83 -2.20	2.63 -3.49	4.04 -6.57	6.74 -19.44	20.35 - ∞
5.6	0.44 -0.46	0.49 -0.51	0.67 -0.73	0.94 -1.06	1.37 -1.66	1.77 -2.29	2.51 -3.74	3.75 -7.52	5.96 -31.31	14.55 - ∞
8	0.44 -0.46	0.48 -0.52	0.66 -0.74	0.92 -1.09	1.32 -1.73	1.69 -2.45	2.34 -4.18	3.39 -9.61	5.09 -378.10	10.21 - ∞
	0.43 -0.47	0.48 -0.53	0.65 -0.76	0.90 -1.13	1.27 -1.84	1.60 -2.68	2.17 -4.91	3.02 -14.74	4.30 - ∞	7.44 - ∞
16	0.43 -0.48	0.47 -0.54	0.63 -0.79	0.86 -1.20	1.19 -2.05	1.47 -3.17	1.93 -6.93	2.57 -138.43	3.42 - ∞	5.13 - ∞

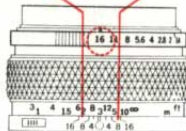
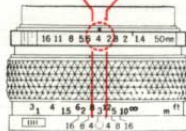

The double series of numbers engraved on the depth of field scale represent F stops: F4, F8 and F16. Once you have focused on your subject, all objects within the distance range indicated on the lens distance scale between the marks for the F/stop you have selected will have acceptable sharpness.

*For other lenses, see the lens instruction manual.

PREVIEW BUTTON

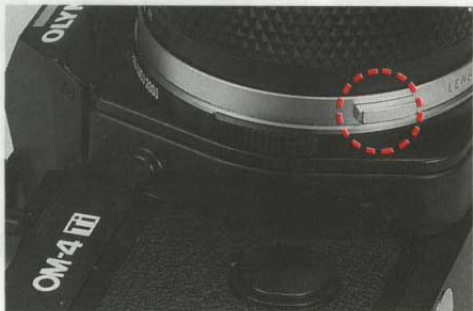

When you wish to see which objects fall within the acceptable zone of sharpness (depth of field), press the preview button on your lens. The diaphragm of the lens will stop down to the preset F stop enabling you to see the depth of field in the viewfinder.

CAUTION: If you jerk the preview button while depressing the shutter release button halfway down the shutter might be released.



SHUTTER SPEEDS



This camera offers various possibilities for visual expression by changing the shutter speed.

High shutter speeds can be used to "freeze" a moving subject to give sharp definition of the image. Shutter speeds of 1/2000 ~ 1/500 sec. can "stop" the movement of a considerably fast moving subject. A shutter speed of about 1/250 sec. will be enough to shoot a child at play, if he is not moving too quickly. There are two methods for giving dynamic expressions. The first one is to blur out the movement of the subject itself, thereby creating a moving image. The second one is to pan the camera according to the movement of the subject. While the background is blurred, the subject is sharply defined to create a

moving image.

*In using slow shutter speeds, it is necessary to guard against camera shake. We will suggest a very practical method for choosing shutter speeds. Generally, shutter speeds of which denominator value is larger than the focal length value of the lens used are good for preventing camera shake. If you are using a 50mm lens, for example, shutter speeds of 1/60 sec. or higher are best; and if you are using a 200mm lens, shutter speeds of 1/250 sec. or higher are best.

BULB EXPOSURE



To take night pictures and other subjects requiring long exposure, use a tripod and cable release and shoot at B (bulb) to prevent camera shake. Set the Manual Shutter Speed Ring to B (bulb) and press the shutter release.

*At "B", the mechanical shutter can be actuated without battery consumption.



MULTIPLE EXPOSURES

By tripping the shutter several times on the same frame, multiple images are produced on the same frame.

This is how to do:

- ① After the first exposure is ended, erect the rewind crank and turn it clockwise as far as it will go to take up film slack.
- ② While holding both the rewind knob and rewind button with your fingers to prevent them from moving, wind the film advance lever. In fact, the film is not wound and the shutter is cocked by this operation.
- ③ Press the shutter release as you would do normally, and double exposure will occur.
- ④ By repeating the steps ② and ③, the frame will be exposed as many times as you want. However, the frame counter advances each time the shutter release is pressed.
- ⑤ After ending the multiple exposure, put the front lens cap on and make a blind shot.

Note: The frame may shift slightly.

INFRARED PHOTOGRAPHY

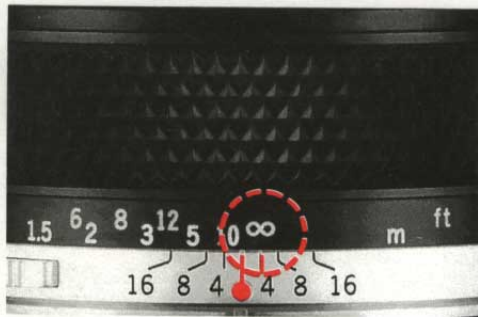

When shooting infrared pictures with infrared film and a red filter, the point of focus will slightly differ if you focus visually. The amount of shift varies with the lens and a red line or red dot is marked on the lens' depth of field scale to compensate for it. First, focus the lens without a red filter on as you would do normally. Next, read that distance on the distance scale and shift it opposite the infrared mark, then put on a red filter and shoot. (The above picture shows the distance at infinity.)

Note: It is impossible to shoot on Auto.



FLASH PHOTOGRAPHY



Electronic flash is very similar to daylight. As it is well balanced for daylight type color films that are most popular, the electronic flash is used for various

photographic applications. Electronic flash is especially useful in unfavorable lighting situations, ensuring easy, error-free picture taking. In dim light, for example, without an electronic flash you will have to use slow shutter speed with a risk of causing camera shake and blurred pictures. Under the illumination of a fluorescent lamp or incandescent lamp, the picture often does not come out with correct colors because it lacks proper color balance. Electronic flash solves all these problems.

The electronic flash can also be used in daylight as fill-in light for backlighted subjects or subjects with too strong a contrast as well as for freezing a fast moving subject.

Because the OM-4Ti provides full control of T-series flashes, there is no operation required on the flash side such as setting the film speed and aperture, mode switchover, and exposure compensation. Since the "OTF" direct light metering system can measure the light that the film, no exposure error occurs due to the difference in covering range of the flash's light receptor and picture frame. You can not only take flash pictures in the auto and manual modes, but also use sophisticated techniques such as bounce, diffuse, ultra close-ups, and multi-lamp flash with ease in a fully automatic mode.

"OTF" AUTO FLASH

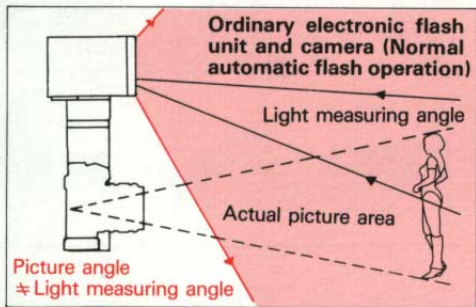
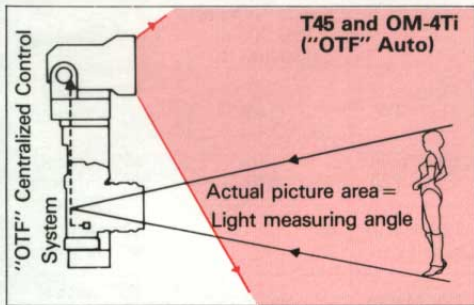

OPERATION OF T-SERIES FLASH

With a T-series flash on the camera, the flash mode will automatically switch according to the camera mode.

If you take pictures in the auto mode, set the camera's mode lever to "AUTO". When the green LED turns on in the viewfinder, the flash is ready for firing. After shooting, the green LED will blink to tell you that your picture has been correctly exposed. If the letters "UNDER" blink, however it means the light is insufficient to get correct exposure and you will have to use a larger aperture. If the letters "OVER" blink, it means an overexposure and you will have to stop down the aperture.

± exposure compensation possible.
The required quantity of light is also adjusted depending on the amount of compensation.

Blinks in case of underexposure after the flash has fired.
Get closer to the subject or open up the aperture.



Blinks in case of overexposure after the flash has fired.
Move slightly away from the subject or close down the aperture.

Lights up when the flash is fully charged; blinks on correct flash firing.

MAIN SPECIFICATION OF T-SERIES FLASH

If the shutter speed is faster than 1/60 sec., the flash will not fire and the camera will automatically switch to the ordinary automatic exposure mode.

To take pictures in the manual mode, set the camera's mode lever to "MANUAL" and set the shutter speed at 1/60 sec. or slower. The flash will always fire with its full capacity. For details, refer to the operation manual of the flash.

	Guide Number ISO 100 m (ISO 100 ft.)	Coverage Angle	
Electronic Flash T45	45 (146)	53° vertical, 74° horizontal	
Electronic Flash T20	20 (66)	40° vertical, 58° horizontal	
T28 Macro Single Flash 1	28 (92)	53° vertical, 74° horizontal	
T28 Macro Twin Flash 1	Single 28 (92) Twin 22 (72)	53° vertical 74° horizontal (Single)	
T10 Ring Flash 1	10 (33)	80°	
T8 Ring Flash 2	8 (26)	80°	

USING ELECTRONIC FLASHES OTHER THAN THE T-SERIES FLASH UNITS

Flash Duration	Number of flashes	Dimensions (less batteries) Weight
1/40,000— 1/1,000 sec.	100—500 with Ni-Cd Pack	283(H) × 87(W) × 116 (D) mm 1,120 gr.
1/40,000— 1/1,000 sec.	120—500 with AA-size alkaline batteries	68(H) × 57(W) × 77(D) mm 160 gr.
1/40,000— 1/1,000 sec.	100—500 with AA-size alkaline batteries (T Power Control 1)	73(H) × 50(W) × 32(D) mm 110 gr.
1/40,000— 1/1,000 sec.		73(H) × 50(W) × 32(D) mm 210 gr.
1/40,000— 1/330 sec.		86φ × 18 mm 95 gr.
1/40,000— 1/330 sec.		91φ × 18,5 mm 110 gr. (Reflector 1: 200φ × 32 mm 80 gr.) (Reflector 2: 150φ × 32 mm, 40 gr.)

- ① Mount the flash on the accessory shoe. If you are using a flash that has no direct contact, connect the flash synchro cord to the synchro terminal.
- ② Set the film speed on the flash.
- ③ Set the shutter speed ring to 1/60 sec.
- ④ If the flash has an AUTO/MANUAL switching device, set it to either AUTO or MANUAL.
- ⑤ Determine the aperture and set it on the camera. If you are using an auto flash, set the desired F stop on the flash unit and then set the aperture ring to this F stop. If you are using a manual flash, calculate the aperture by the following formula or using the flash's calculator panel and set it with the camera's aperture ring. (ISO 100m/ft.)

$$\text{Aperture} = \frac{\text{Flash guide number}}{\text{Flash-to-subject distance (m/ft.)}}$$

BOUNCE FLASH



The T45, T32 have an adjustable flash head that tilts as much as 90° upward. As it operates on "OTF" auto, it allows you to use bounce flash automatically by simply activating the flash switch.

*Set the tilting angle so that the subject is illuminated by reflected light.



Electronic Flash T45

CLOSE-UP FLASH



As it operates with all available apertures on "OTF" auto, this feature allows you to take close-ups automatically by simply activating flash switch.

SHOOTING WITH A MOTOR DRIVE



Shooting with a motor drive is very exciting because it enables you to capture your subject in a critical moment by making several shots in a second.

The high speed OM System motor drive has achieved an extremely compact and lightweight design to take full advantage of its ease of operation and high maneuverability. Motor Drive 2—the world's first 5-frames-per-second high speed motor drive with a built-in computer. It is equipped with an LCD display of the number of frames and the operating procedure and also permits motorized rewind when it is attached to the OM-4Ti.

In addition, the Winder 2 is also available, which offers both single-frame exposures and sequential exposures on dial switching.

The OM System's outstanding maneuverability and operability are ideal for shooting dynamic sports photos and documentary press photos. Various accessories can be connected by a direct contact.

*The Motor Drive 1 can also be used, but motorized rewind is impossible.

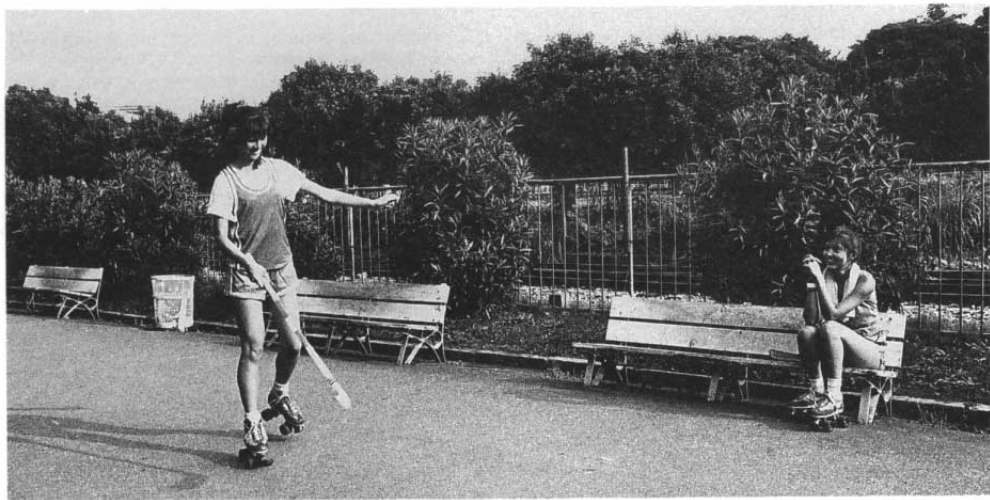

MOTOR DRIVE GROUP

Selection of Motor Units

- Motor Drive 2. If you want to shoot very fast moving subjects such as a dashing animal or a racing car driving at full speed, the Motor Drive 2 is the best choice because it permits continuous shooting at a high speed of up to five frames a second. This quick shooting capability will often allow you to catch a dramatic instant.
- Winder 2. The Winder 2 is very helpful for shooting impressive moments such as sports scenes and children at play. As it permits continuous shooting at a rate of up to 2.5 frames a second, you will not miss a decisive moment.

Selection of Power Sources

- For the Motor Drive 2, the following two power units are available: a small, lightweight and portable flat-type rechargeable power unit, M.15V Ni-Cd Control Pack 2, and a grip-type battery power unit, M 18V Control Grip 2, which provides added stability when used with a telephoto lens.
- The Winder 2 has a self-contained power supply, but two external power units are also available: M.6V Power Pack 1 and 6V Power Pack 2.

Film Back

- To shoot many pictures in succession, the 250 Film Back 1 which permits up to 250 exposures is available for the OM-4Ti. It allows you to save the time for film change and take full advantage of the motor performance.

Remote Control System

- Both the Motor Drive 2 and Winder 2 can be easily remote-controlled with a dedicated remote cord. Besides the Remote Cords 1.2m and 5m, the M. Quartz Remote Controller 1 with an electronic counter is available, which allows you to trigger the camera and check its operation with an LCD display at a remote location. It is very useful for shooting wild birds and animals and for macro-photography and photomicrography to trip the shutter without a shock.



RECORDATA BACK 4

Interchangeable camera back for data imprinting. Data imprinting is possible in the following forms: (1) Year—month—day (Japanese date description), (2) Month—day—year (American date description), (3) Day—month—year (European date description), (4) Hour—minute, (5) Counter (additive type), (6) Classification number up to 6 digits. Provided with an imprint clear switch to be used when data imprinting is unnecessary. This Recordata Back can also be used as a clock which indicates the hour, minute and second via a Time Button.

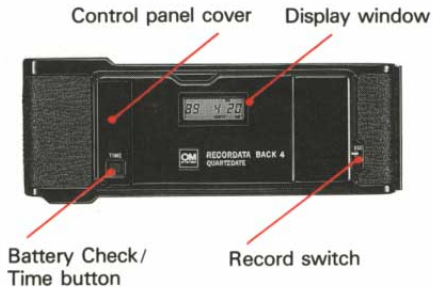

MACROPHOTOGRAPHY



The world of macrophotography is filled with marvelous discoveries. However, macrophotography has been generally considered difficult; calculations of correct exposure, in particular, have been a difficult job even for professionals.

Equipped with a "OTF" direct light metering, the OM-4Ti has solved this problem to always provide correct exposure, regardless of the magnification and aperture. All complicated exposure calculations for multi-lamp flashing are now quite unnecessary. The OM-4Ti also provides a complete macro system including a wide choice of macro lenses that offer excellent life-size and magnified pictures as well as extension units that enable you to take handheld macro pictures.

CHART OF PHOTOGRAPHIC RANGES

ZUIKO INTERCHANGEABLE LENS	EXTENSION UNITS	300	180	120	72	60	45	36	24	12	7.2	3.6	MICRO			
		x	x	x	x	x	x	x	x	x	x	x	100x	500x	1000x	
		0.1x	0.2x	0.3x	0.5x	0.8x	0.8x	1x	1.5x	3x	5x	10x	100x	500x	1000x	
PROFESSIONAL METHOD	INTERCHANGEABLE LENSES	-														
	ZUIKO MACRO 50mm F2/F3.5	1mm 0.1 - 0.14x														
	ZUIKO MACRO 90mm F2	1mm 0.5x														
	ZUIKO MACRO 135mm F4.5	TELESCOPIC AUTO TUBE 85 - 116	1mm 0.43x													
		AUTO BELLOWS	1mm 0.5x													
	ZUIKO 11 MACRO 80mm F4	TELESCOPIC AUTO TUBE 85 - 116	0.48x													
		TELESCOPIC AUTO TUBE 85 - 116	1x 1.2x													
		AUTO BELLOWS	0.09x 0.5x 1x 2x													
	ZUIKO MACRO 38mm F2.8	AUTO EXTENSION TUBE 14	1.7x 1.8x													
		AUTO EXTENSION TUBE 25	2x 2.1x													
		TELESCOPIC AUTO TUBE 85 - 116	3.1x 4.5x													
		AUTO BELLOWS	2.3x 6.7x													
	ZUIKO MACRO 38mm F3.5	TELESCOPIC AUTO TUBE 85 - 116	2.5x 4x													
		AUTO BELLOWS	1.8x 6.1x													
	ZUIKO MACRO 20mm F2	AUTO EXTENSION TUBE 14	4.2x 4.4x													
		AUTO EXTENSION TUBE 25	4.7x 4.9x													
		TELESCOPIC AUTO TUBE 85 - 116	8.8x 9.5x													
		AUTO BELLOWS	5.3x 13.6x													
	ZUIKO MACRO 20mm F3.5	TELESCOPIC AUTO TUBE 85 - 116	5.8x 8.3x													
	AUTO BELLOWS	4.3x 12.4x														
ZUIKO MACRO LENSES	MACROPHOTO GRAPHIC EQUIPMENT PMT35	0.5x 16x														
COMPOSITE METHOD	MICROSCOPE	OM MOUNT PHOTOMICRO ADAPTER	3.3x 750x													
	STANDARD LENS	CLOSE-UP LENS	0.13x 0.28x													
		AUTO EXTENSION TUBE 7	0.16x 0.3x													
		AUTO EXTENSION TUBE 14	0.3x 0.45x													
		AUTO EXTENSION TUBES (7+14)	0.45x 0.56x													
		AUTO EXTENSION TUBE 25	0.5x 0.65x													
		AUTO EXTENSION TUBES (7+25)	0.65x 0.8x													
		AUTO EXTENSION TUBES (7+14+25)	0.8x 0.95x													
		AUTO EXTENSION TUBES (14+25)	0.95x 1.1x													
	ZUIKO MACRO 50mm F2/F3.5	CLOSE-UP LENS	0.13x 0.63x													
		AUTO EXTENSION TUBE 25	0.5x 1x													
	ZUIKO MACRO OR STANDARD LENS	TELESCOPIC AUTO TUBE 85 - 116	1.8x 2.8x													
		AUTO BELLOWS	0.71x 4.1x													
ZUIKO MACRO 90mm F2	TELESCOPIC AUTO TUBE 85 - 116	0.72x 1.72x														

111 ...Recommended close-up range (with lens retracted)

...Recommended close-up range (with lens extended)

...Possible close-up range

MACRO PHOTO UNITS

Simplified Macro System

It allows you to take close-ups up to life size with ease. With this macro system, you will come upon unexpected and wonderful discoveries in tiny things around you such as writing instruments, printed letters, flowers in a vase, etc.

- **Close-up Lenses 49mm and 55mm.** $f=40\text{mm}$.

Simply screw them in the front of the standard lens, and you can take up to 0.63X close-ups.

- **Auto Extension Tubes 7, 14 and 25.** These adapters are placed between the lens and camera body and available in three thicknesses: 7mm, 14mm and 25mm. They can be used in seven combinations. With the standard lens, you can take up to 1.1X close-ups.

Basic System

This is a complete macro system that permits low to high magnifications. It will produce a brilliant image of the marvelous world of tiny things such as the geometric beauty of the compound eye of a dragon fly and close-ups of flowers. An indoor type and outdoor type are available.

Indoor type: This system uses an auto bellows, macro photo stand, top-light illumination device, etc. in combination with various macro lenses. It is suited for taking high-magnification pictures in a room or studio.

- **Auto Bellows.** A basic unit that helps you take full advantage of the system's capabilities with a variety of lighting units and mounts. The stop-down lever that lets you use a variety of OM System lenses at preset aperture or operated in combination with the double cable release, affords an automatic diaphragm photo function.

- **Zuiko Macro 20mm F2.** Large-aperture macro lens designed exclusively for macrophotography. Combined with the Auto Bellows, it permits magnifications ranging from 4.2X to 16X. Provided with a helicoid for fine focusing.

- **Zuiko Macro 38mm F2.8.** Bright, high-magnification macro lens designed exclusively for macro photography. Combined with the Auto Bellows, it permits magnifications ranging from 2.3X to 6.7X. Provided with a helicoid for fine focusing.
- **Macrophoto Stand VST-1.** A compact and sturdy multipurpose stand for solid camera support in close-up and macrophoto work. Comes with frosted stage glass for incident light and may be used in conjunction with Trans-illuminator Base X-DE for lighting of transparent subjects from beneath.
- **Epi-illuminator PM-LSD2.** A two-piece lighting set providing ideal reflected light for macrophotography. Moving the filament allows you to change the position and field of illumination.

Outdoor type: This is a handy and highly maneuverable system which includes macro lenses, telescopic auto extension tube 65—116, etc.







- **Telescopic Auto Extension Tube 65—116.** With its variable tube length, this auto extension tube enables you to change the shooting distance and magnification freely.
- **Zuiko 1:1 Macro 80mm F4:** This lens is designed specifically for life-size reproductions. It functions at its best at a 1:1 ratio, but gives outstanding images from 1/2 to 2X life-size, the range of magnifications available when used with the Auto Bellows. With







the Telescopic Auto Tube it goes up to life-size, and the close-up lens is used to extend the range to 2X magnifications.

- **Zuiko Macro 135mm F4.5.** Shoots from infinity to life-size with the Auto Bellows, or 0.43X magnifications with the Telescopic Auto Tube, giving long working distances and minimal perspective distortion. It has a helicoid ring for fine focusing.
- **Zuiko Macro 50mm F2:** Large-aperture macro lens which is as fast as a normal lens. Basic design magnification 0.1X. Because aberrations are minimized at close and far distances, this lens exhibits excellent resolution from infinity to as close as 0.24m.
- **Zuiko Macro 50mm F3.5.** Designed for optimum performance at 1/10 magnifications, this outstanding lens gives superb results in general purpose photography at infinity, or for macro subjects as large as 1/2 life-size.
- **Zuiko Macro 90mm F2:** This medium-range telephoto macro lens covers a wide focusing range from 1/2X close-ups to infinity. With its large aperture ratio of F2, it provides excellent image definition in macro photography and promises good performance at infinity for extended picture-taking possibilities.



FINDER GROUP UNITS

TYPE	SCREEN	FEATURES
<p>1-1 Microprism-matte type (for most lenses)</p>		<p>Standard type, suitable for general photography. Fast and accurate focusing is done on the central microprism spot as well as on the surrounding matte area. When a lens with a maximum speed of F5.6 or slower is used, the microprism darkens and focusing must be made on the matte area.</p>
<p>1-2 Microprism-matte type (for standard & telephoto lenses)</p>		<p>Suitable for general photography in conjunction with a standard or telephoto lens. Focusing is done on the microprism spot as well as on the matte area. When a lens with a maximum speed of F8 or slower is used, the microprism spot darkens.</p>
<p>1-3 Split image-matte type (for most lenses)</p>		<p>Suitable for general photography ensuring critical focusing, and ideal for photographers who prefer the split-field and coincidence type focusing. When a lens with a maximum speed of F5.6 or slower is used, the split prism darkens.</p>
<p>1-4N All matte type (for most lenses)</p>		<p>Suitable for general photography and ideal for photographers who prefer a view field free from microprism or split prism and for those who are accustomed to focus using matte area. Also suitable for super telephoto photography and close-up photography in conjunction with macro lenses and Auto Bellows. (There is a circle showing the spot metering range.)</p>
<p>1-5 Microprism-clear field type (for wide angle & standard lenses)</p>		<p>This transparent screen provides an exceptionally bright finder image. Highly suitable for snapshots using wide angle lenses. The lack of matte surface means depth-of-field effects cannot be ascertained.</p>
<p>1-6 Microprism-clear field type (for standard & telephoto lenses)</p>		<p>This screen provides an extremely bright finder image. Focusing is done on the microprism spot. The lack of matte surface means depth-of-field effects cannot be ascertained.</p>
<p>1-7 Microprism-clear field type (for super telephoto lenses)</p>		<p>Developed primarily for use with super telephoto lenses this clear field screen provides an extremely bright finder image. The micro-prism spot remains bright even with a lens whose maximum speed is F11. The lack of matte surface means depth-of-field effects cannot be ascertained.</p>

TYPE	SCREEN	FEATURES
1-8 All matte type (for telephoto lenses & astronomical telescopes)		This screen is ideal for use with super telephoto lenses of 300mm or more in focal length, or for astrophotography. The extreme fineness of the matte surface permits outstanding field definition. More accurate focusing may be achieved by the use of the Varimagni Finder.
1-9 Clear field type (for endoscopic photography)		Designed for use with OLYMPUS fiberoptic endoscopes. This condenser type screen without fresnel lens requires no focusing when a special adapter couples the camera with the fiberscope. Exposure is made automatically by the light supply.
1-10 Checker-matte type (for shift lens)		The grid lines engraved on the all-matte surface are used for vertical and horizontal picture alignment. Though originally designed for architectural photography with the shift lens, it is also suitable for general and super-telephotography, and close-up/macrophotography with macro lenses and Auto Bellows.
1-11 Cross hairs-matte type (for close-up & macro- photography)		Highly advantageous for close-up and macrophotography with Auto Bellows and extension tubes. For focusing in low magnification close-up photography, use the matte area and in macrophotography greater than life size, use the double cross hairs the same way as with the 1-12.
1-12 Cross hairs-clear field type (for photomicrography & macrophotography greater than life size)		The transparent screen offers the photographer focusing with an unusually bright finder image. To focus, first correct your diopter using a dioptic correction lens or Varimagni Finder so that each line of the double cross hairs can be seen clearly and separately. Then bring the Spacemen into focus.
1-13 Microprism/split image-matte type (for most lenses)		Most suitable for normal photography, this screen assures pinpoint focusing. The central split-image rangefinder is encircled by a microprism collar. Since the outer area has a matte surface, the screen can be used in the same way as the standard 1-1 and 1-3 Screens. When a lens with a maximum speed of F5.6 or slower is used, the prisms darken and the focusing must be made on the matte area.
1-14 Microprism/split image-matte type (for most lenses)		Most suitable for normal photography. The central split-image range finder, encircled by a microprism collar, is inclined 45 degrees to allow easy focusing on subjects with vertical or horizontal lines. When a lens with a maximum speed of F5.6 or slower is used, the prisms darken and focusing must be made on the matte area. The meter needle gives correct light readings.

SELECTION OF FILTERS

With the aperture and shutter, the camera can control the amount of light, but not the quality of light. Therefore, it is necessary to filter the light components that are not wanted for visual expressions. Filters are useful for this purpose.

■ Filters for color and B&W films

Skylight (1A): For absorbing ultraviolet rays. It yields natural colors on the part of a subject in the shade under a blue sky by filtering the light from the sky. It can be used to protect the lens, but it is not recommended to use this filter for subjects which are not affected by ultraviolet rays or a blue sky because the color balance may be impaired.

L3 (UV): In the open air on a bright day, there are a lot of ultraviolet rays to which photographic films are sensitive although they are invisible to the human eye. Affected by these rays scattering in the air, distant landscapes may turn out whitish and unclear. The skylight filter cuts off detrimental ultraviolet rays. It can always be used for lens protection.

ND2/ND4: Neutral gray filter for reducing the light quantity without affecting the color and contrast. Use this filter if you want to open the aperture for a blurred background, or produce special "blur" effects with a slow shutter speed, or to reduce the light intensity without increasing the shutter speed on a reflex telephoto lens which has no aperture control mechanism. Available in two types: ND2 for reducing the light intensity by one stop and ND4 for reducing it by two stops.

C-POL (circularly polarizing filter): For blocking the light reflected from the surface of glass, water and tile to take sharp pictures of fish in the water, subjects behind a show window, etc. It can also be used as a contrast filter for color pictures of landscapes, because it cuts off the light reflected from dust or vapor under a blue sky as well as the surface of leaves and grass. As this is a circularly polarizing filter it can be used on cameras using a half-mirror such as the OM-4Ti.

■ Filters for B&W films

Y48 (Y2): Yellow filter which absorbs ultraviolet, violet and part of blue light. It decreases the effect of blue sky and brings out the clouds. It is also useful for taking distant shots on a bright clear day. With this filter, the sensitivity of films becomes closer to that of the human eye so that ordinary shots at close distance will appear very natural with a slightly enhanced contrast.

O56 (O2): Orange filter which absorbs a wider range of light (from ultraviolet rays to blue-green light) than Y48, thus producing an intensified contrast. It can also be used for infrared film.

R60 (R1): Red filter which absorbs violet, blue, green light and part of yellow light, thus blocking almost all light except for red and similar colors. As it produces a strong contrast effect, distant shots turn out sharp and crisp while the tone of blue sky weakens. This filter is indispensable for bringing out the effects of infrared film.

■ Filters for color films

A4 (81C): On a cloudy or rainy day, pictures taken on daylight film tend to appear blueish. This amber film suppresses blue and produces natural color reproduction. It can also be used for creating warm and mild effects intentionally under ordinary light.

B4 (82C): Subjects under morning or evening glow will turn out reddish if they are taken on daylight film. This blue filter suppresses red and produces natural color reproduction. In contrast with A4, it can be used for bringing out cool, blueish effects under ordinary light.

Handling Care

Take care in handling the camera.

Do not use extra force.

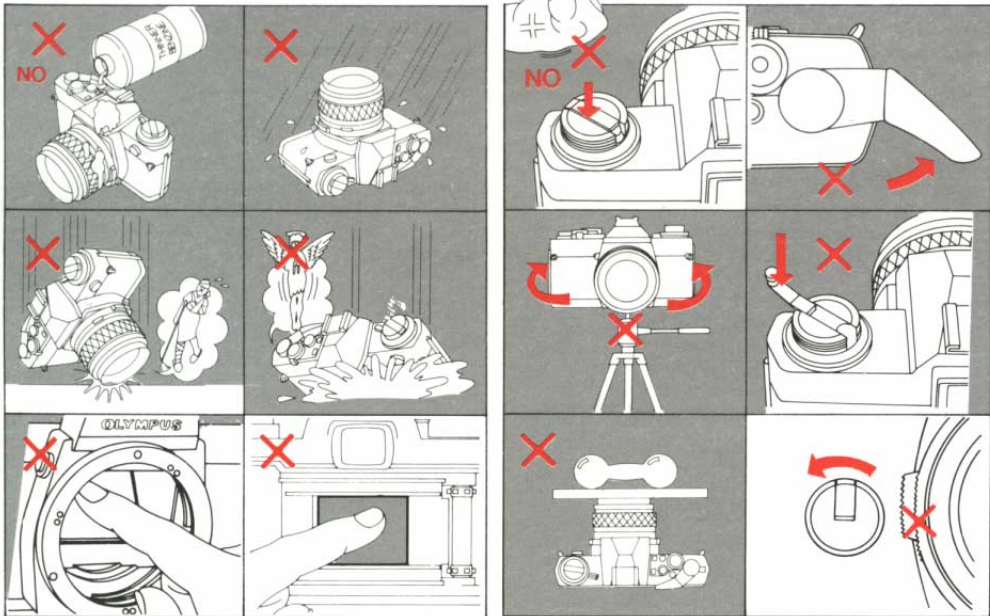

Storage Care

Battery Precaution

Guard against high temperature and magnetic fields.

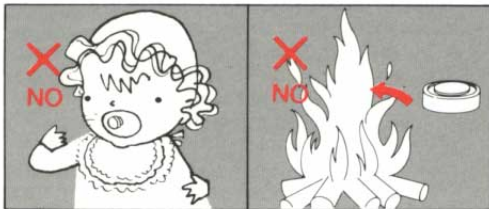

QUESTIONS AND ANSWERS (1)

Q: Why won't the shutter release button move when I press it?

A: The film advance lever may not have been fully advanced or the film may have come to its end.

Q: Why can't I advance the film?

A: The shutter may be cocked and ready to fire. Try pressing the shutter release button.

Or, the film may be fully exposed. Check the exposure counter. If you feel tension on the film advance lever, DO NOT FORCE IT. Rewind the film. Or the self-timer lever is not securely in its upright position, reset and release the self-timer.

Q: The film advance lever does not operate and I see nothing in the viewfinder.

A: Are there batteries in the camera? Are they exhausted? Check with the battery checker to see if they are operating properly. If the audible and visual signals do not turn on, they are not. The mirror will spring back if you replace the batteries or set the shutter speed dial to the red 1/60 sec. (mechanical shutter) or "B".

Q: My camera is loaded with film. Why doesn't the rewind knob rotate when I advance the film?

A: The film leader may not be inserted in the film take-up spool and the film is not advancing.

Q: The rewind crank does not turn.

A: Press in the rewind button.

Q: Is it normal for the microprism in the center of the viewfinder to "shimmer" and darken?

A: Yes, when a lens with a maximum aperture smaller than F5.6 is mounted on the camera. It also happens with other lenses when the depth of field preview button is pressed.

Q: What type of batteries shall I buy?

A: Purchase two SR44 silver-oxide or LR44 alkaline batteries. Silver-oxide batteries are more economical because they last longer. Do not use different types of batteries at the same time (SR44 or LR44 battery and HR44 mercury or lithium battery, for example), even when they are of the same size. Always replace the two batteries at the same time and do not use an old and a new battery together.

(The batteries that come with your camera are supplied for test.)

Q: When should I check the batteries?

A: (1) When new batteries are inserted. (2) After the camera hasn't been used for a long time. (3) Before beginning a prolonged period of use. (4) When the temperature is very cold.

Q: Why can't I set the ISO film speed I need?

- A: At the most, 3 stops can be advanced in a single stroke of the dial. If this is not enough stops, lift up and rotate the outer collar of the dial until it stops; then release the collar and rotate the collar and dial together until the white line is aligned with the black index on the pentaprism. Repeat this procedure until you reach the ISO speed you need.
- Q: With ISO 3200, I made exposure compensation on the minus (-) side.**
- A: Exposure compensation on the minus side is impossible at ISO 3200. If you have made it, the ISO setting value will change. Set the ISO value once again correctly. The same thing applies to (+) side exposure compensation via ISO 6.
- Q: I want to take pictures with the motor cover detached even when I am not shooting with the motor drive, because attaching and detaching it is quite troublesome.**
- A: The motor cover should always be attached if you are not shooting with the motor drive. It will prevent entry of dust and exposure by direct light.
- Q: I took pictures with the aperture ring set at a halfway position between the f/stop numbers. Was the film properly exposed?**
- A: Yes, you can use any in-between settings on the aperture ring to obtain precise exposure.
- Q: In the finished print, a peripheral portion of the picture is cut, though I framed it inside the view-finder.**
- A: In some color prints and color slides, a peripheral portion of the picture may be eliminated in the laboratory. It is recommended, therefore, to leave some margin in composing your picture.
- Q: How do I clean the camera and lens?**
- A: Clean the camera using a clean, soft lintless cotton cloth. Clean the lens only with a hand powered air blower, antistatic brush or lens tissue. NEVER rub the lens surfaces with your finger, clothing or other abrasive material. Take care not to permit water to enter the camera when taking pictures in the rain or snow, especially near seawater spray. After use near the ocean, wipe the camera surfaces clean and never leave salt residue on the camera.
- Q: There are sometimes scratches on the film.**
- A: The cause may be a soiled film passage. The film compartment may be soiled by film debris during long use of the camera. Be sure to dust off the camera periodically.
- Q: How do I store the camera?**

QUESTIONS AND ANSWERS (2)

- A:** Remove the camera from its case and store it in a dry, well ventilated place. Protect against excess moisture by using packs of silica gel or other desiccant in the storage area. Do not store the units near moth balls or similar volatile chemical materials to avoid the possibility of damage to metal surfaces.
- Q: The shutter remains open and does not close.**
- A:** If you shoot on spot metering with the lens cap on (F stop number is set to 22 or more), the shutter will remain open for about 4 minutes. In this case, switch the mode lever to the battery check mode. The shutter will immediately close. (To shoot, return the mode lever to AUTO or MANUAL).
- Q: Why is the automatic exposure shutter speed much longer than indicated by the meter in the viewfinder?**
- A:** If film is not loaded, the shutter speed is much longer than that indicated. If it is necessary to obtain a correct reading without actually taking a picture, insert a waste, undeveloped film or the paper you find behind the camera back at the purchase of your OM-4Ti into the film position in the camera.
- Q: The display in the viewfinder has disappeared while the camera is operating.**
- A:** As the OM-4Ti has an energy-saving design, the display will automatically disappear in 120 seconds. To turn it on again, touch the shutter release lightly.
- Q: On spot inputs, the dot and bar graph tip shift.**
- A:** This may happen because the bar graph is based on digital display. It does not mean that anything is wrong, and you can get correct exposure. It is for the same reason that the bar display shifts at the time of highlight control or shadow control.
- Q: The tip of the shutter speed display bar blinks frequently during light metering.**
- A:** This occurs mostly in the case of metering under a fluorescent lamp. Though the fluorescent lamp appears to the human eye as it were lighting continuously, it is in fact blinking repeatedly at a frequency of 50–60 cycles a second. Each particle of the shutter speed bar display represents 1/3 EV. Therefore, if the luminosity is unstable or in the case of a luminance mediated between the bar tip and the adjacent particle, the bar tip will blink.
- In actual exposure determinations, however,

variations of light are averaged, causing no problem.

Q: In what cases will the AE lock be released except when the shutter is released?

A: The AE lock will be released in the following cases:

(1) Switching of the mode lever, (2) changing the lens, (3) operation of the clear lever, (4) turning on the power switch of a T-series flash and F280, (5) setting the shutter speed dial to "Bulb" or the red 1/60 sec. (mechanical shutter).

Q: After operating the highlight (or shadow) button, I have pressed the spot button by error.

A: If the new spot exceeds the highest value (or falling below the lowest value) that was already inputted comes to be inputted after the highlight (or shadow) button has been operated, exposure is changed according to that value. The bar display shows the highest (or lowest), if the new spot is below the highest value (or above the lowest value), it is not affected.

Q: When I used the highlight (shadow) button, the picture did not come out with the desired colors.

A: Colors on negative film may sometimes be cor-

rected automatically in the printing process. You need not worry about this problem if you use reversal film.

Q: After operating the highlight button, I have pressed the shadow button by error.

A: The highlight control status switches to the shadow control status. On the contrary, if you have pressed the highlight button after operating the shadow button, the shadow control switches to the highlight control status.

Q: In what cases will the memory be cleared except when the clear lever is operated?

A: The memory will be cleared in the following cases: (1) Switching of the mode lever, (2) changing the lens, (3) more than 60 minutes have elapsed after shooting, (4) turning on the power switch of a T-series flash and F280, (5) setting the shutter speed dial to "Bulb" or the red 1/60 sec. (mechanical shutter).

Q: How about in-between settings of the shutter speed dial in the manual mode? For example, between "125" and "250".

A: In this case the film was still properly exposed but at either 1/125 sec. or 1/250 sec. It is recommended that you set the shutter speed ring at a shutter speed index engraved on the camera,

QUESTIONS AND ANSWERS (3)

not in between.

Q: The batteries have worn out while I was shooting in cold weather. What can I do to take pictures?

A: Use a mechanical shutter speed of 1/60 sec.

Q: The flash does not fire.

A: There are two possible reasons. (1) On AUTO mode, flash firing is automatically inhibited at shutter speeds faster than 1/60 sec. (excluding in Super FP Flash mode of F280).

(2) Are the camera batteries exhausted? In this case, the flash will not fire even at a mechanical shutter speed of 1/60 sec. or "B".

Q: Is spot metering possible in the flash mode?

A: No, spot metering is not possible.

Q: I want to use a flash that is not of the T-series and F280.

A: You can use any flash, but you should take the following points into account: The flash will not fire with Mode Selector Lever on AUTO. On auto spot metering or in the manual mode, it will fire with shutter speeds faster than 1/60 sec., but it will not cover the entire picture frame because the camera has a focal-plane shutter. The shutter speed should be set to 1/60 sec. or slower. The flash ready signal and correct exposure

confirmation lamp will not turn on in the viewfinder. Flashes with opposite polarity won't fire at all.

Other cautions

- The exposure value will shift on spot metering with a linear polarizing filter. In this case, use a circularly polarizing filter.
- The Recordata Backs 1 and 2 cannot be used.
- The original 250 Film Back 1 cannot be used. It can be altered for use on the OM-4Ti. Contact Olympus Service Station.
- The Motor Drive Socket Cap on the camera side cannot be stored in the Motor Drive 1 or Winders 1 and 2.
- If you want to use a polarizing filter, always use a circularly polarizing filter. If other filters are used, exposure may vary in the case of spot metering.

Description of Controls

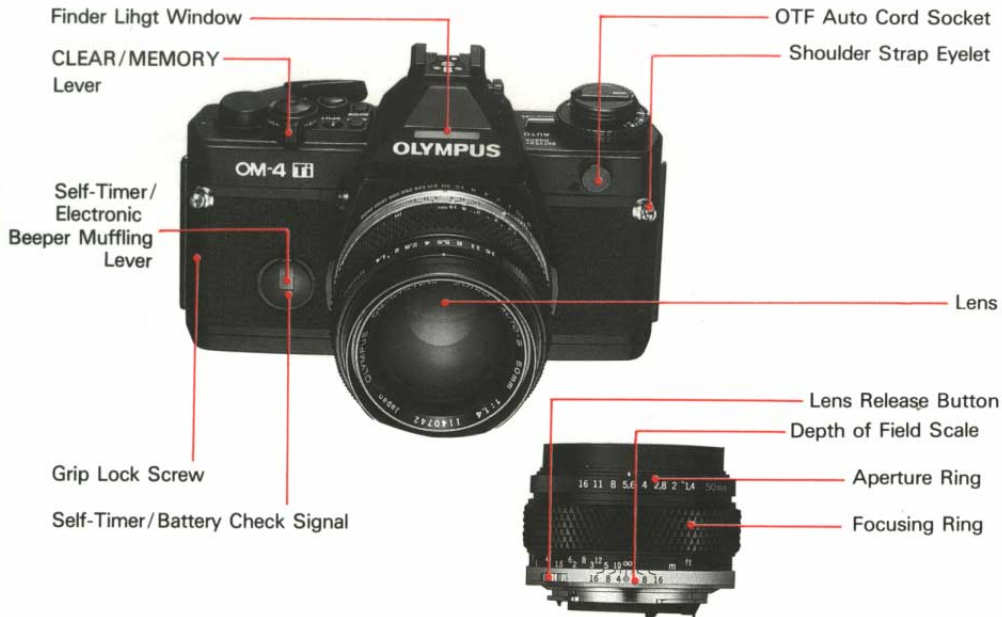

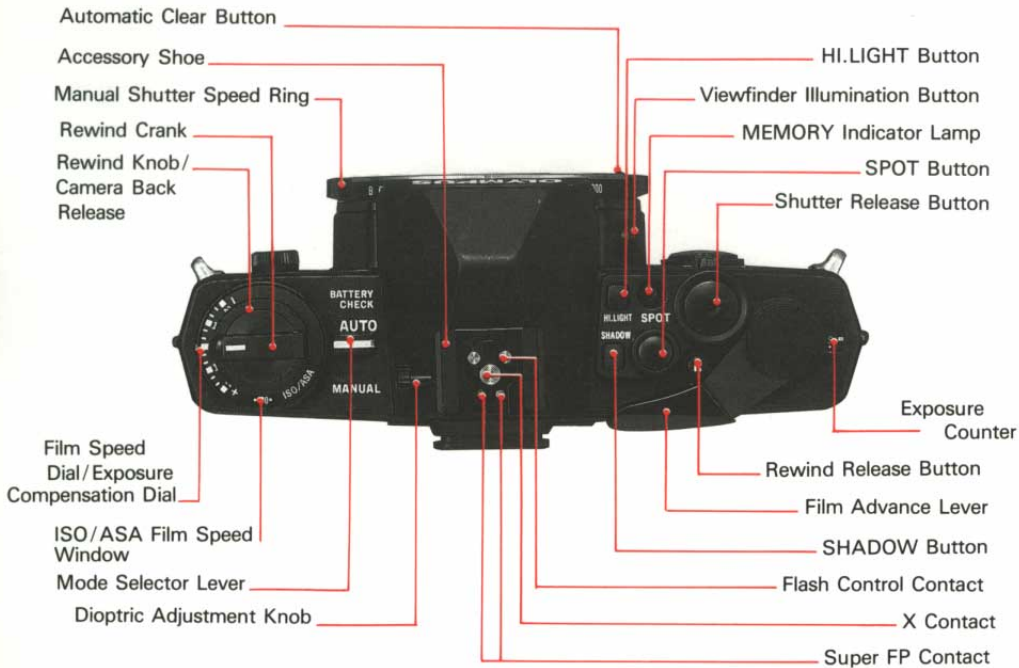

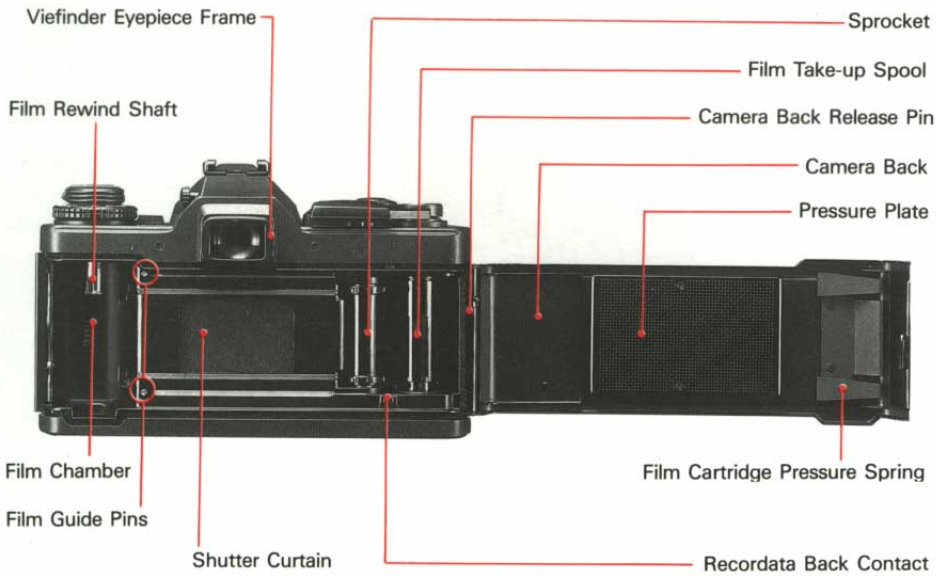

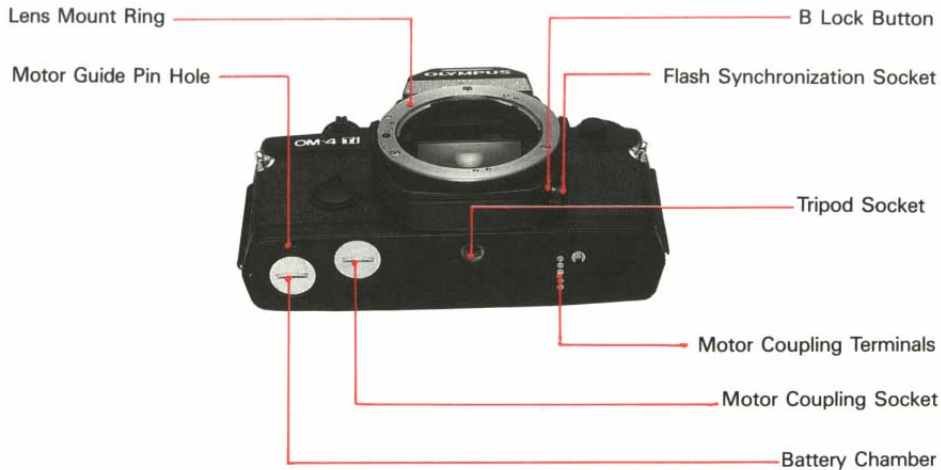

Specification

Type: TTL auto-exposure 35mm SLR camera

Film Format: 24mm × 36mm

Lens mount: Olympus OM mount

Shutter: Electronically controlled cloth focal plane shutter; 1/2000 sec. max. shutter speed; 1/60 sec. mechanical shutter speed

Synchronization: X contact (synchronization at speeds of 1/60 sec. or slower); Super FP Flash contact; Hot shoe (with X and Super FP Flash contacts); 5-pin connector for T-series flash, synchro socket for X

Light measuring method: Center-weighted, average light measurement, switchable to spot measurement; spot measurement selective in 3 modes; multi-spot, highlight- and shadow-based methods.

Automatic exposure control by average light measurement: TTL Direct "off-the-film" Light Measuring with aperture-preferred electronic shutter; exposure control range: about 1 min. ~ 1/2000 sec. light measuring range: approx. EV5 ~ EV19 (ISO 100, 50mm F1.4, normal temperature and humidity); ±2EV exposure compensation.

Automatic exposure control by spot measurement: TTL spot metering memory system (with AE lock); exposure control range: about 4 min. ~ 1/2000 sec. light measuring range: approx. EV0 ~ EV19 (ISO 100, 50mm F1.4, normal temperature and humidity); ±2EV exposure compensation.

Automatic exposure memory control: Exposure value memory system (60 min. limiter)

Manual exposure control: B, 1 sec. ~ 1/2000 sec. mechanical exposure speed 1/60 sec.

Flash exposure control: Super FP Flash mode (when using

the Full Synchro Flash F280) "OTF" AUTO: Synchronizes with shutter speeds from 1/60 sec. to 1/2000 sec.; MANUAL: Synchronizes with all shutter speeds up to 1/2000 sec.; Normal "OTF" or Manual Flash mode (when using a T-series Flash or Full Synchro Flash F280) Synchronizes with shutter speeds of 1/60 sec. and slower.

Film speed: ISO 6 ~ 3200

Film advance: Film advance lever with 130° angle for one long or several short strokes and pre-advance angle 30°; motor drive and winder usable.

Film rewind: Rewind crank (motorized rewind with Motor Drive 2 possible)

Viewfinder: Viewfinder with dioptic correction; dioptic correction range +1.0 ~ -3.0 diopters; interchangeable focusing screens; microprism/split image-matte type screen standardized; finder view field: 97% of actual picture field; magnification 0.84X at infinity with -0.5 diop. and 50mm lens.

Viewfinder information: LCD multi-mode display (2-min. limiter); built-in illuminator, (10-sec. limiter)

Self-timer: 12-sec. delay electronic self-timer.

Battery check: 3-level display with LED and alarm sound; automatic lock with batteries exhausted.

Power Source: Two 1.5V silver-oxide batteries SR44 (Eveready EPX-76; alkaline manganese batteries LR44 or equivalent)

Camera back: Removable hinge type, with memo holder; interchangeable with Recordata Backs and 250 film Back.

Dimensions: 136 × 84 × 50mm (5.35" × 3.30" × 1.97") (body alone)

Weight: 510g (18 oz.) (body alone)



OLYMPUS

OLYMPUS OPTICAL CO., LTD.

San-Ei Building, 22-2, Nishi Shinjuku 1-chome, Shinjuku-ku, Tokyo, Japan Tel 03-340-2211

OLYMPUS CORPORATION

Crossways Park, Woodbury, New York 11797, U.S.A. Tel 516-364-3000

OLYMPUS OPTICAL CO.(EUROPA) GMBH

Postfach 104908, Wendenstrasse 14-16, 2 Hamburg 1, West Germany Tel 040-23773-0

OLYMPUS OPTICAL CO.(U.K.) LTD.

2-8 Honduras Street, London EC1Y 0TX, England Tel 01-253-2772