

E

OLYMPUS

OM-2S
PROGRAM

For Your Creative
Photography [B]

TABLE OF CONTENTS



• The Two Metering Systems of the OM-2S PROGRAM	3	• Viewfinder Display for Automatic Exposure	24
• Three Exposure Modes of the OM-2S PROGRAM	5	• Shutter Speeds	25
PROGRAM		• Exposure Compensation	27
• Programmed Automatic Exposure on "OTF" Direct Light Metering	7	• Bulb Setting	27
• Program Chart	9	• Multiple Exposure	28
• Viewfinder Display in "OTF" Program Mode	10	• Infrared Photography	28
MANUAL/SPOT		• Flash Photography	30
• Manual Exposure on Spot Metering	11	• How to Use a T-series Flash Unit	31
• Shooting on Spot Metering (1)	13	• Main Specification on T-series Flash	31
• Shooting on Spot Metering (2)	15	• Electronic Flashes Other than the T-series Flash Units	32
• Spot Metering Area	17	• Bounce Flash	33
• Viewfinder Display for Manual Exposure on Spot Metering	19	• Close-up Flash	33
AUTO		• Shooting with Motor Drive	35
• Aperture Preferred Automatic Exposure on "OTF" Direct Light Metering	20	• Motor Drive Group Units	37
• Depth of Field	21	• Recordata Back 4	39
• Depth of Field Scale	22	• Macrophotography	40
• Preview Button	23	• Combination of System Units for Choice in Terms of Magnification	41
		• Macrophoto Group Units	44
		• Finder Group Units	47
		• Questions and Answers	49

THE TWO METERING SYSTEMS OF THE OM-2S PROGRAM

Off-The-Film Direct Light Metering

This is a center-weighted, averaged light metering system. Special, because it measures the light intensity of the subject as it registers on the film. It can adapt itself to any change of light during the actual exposure. This "Off-The-Film" direct light metering system was developed by Olympus for the first time in the world. It is very useful for most picture-taking conditions, and especially in situations requiring high maneuverability.

If the camera is used in combination with a T-series flash, it retains perfect control of the available light

exposure and flash exposure through this TTL direct "Off-The-Film" light metering system. It has completely eliminated the need for complicated exposure calculations in flash photography. With a T-series flash on the camera, all apertures of a lens can be used and such sophisticated techniques as multi-flash and bounce flash can be used in a full

automatic mode. This metering system has also solved difficult exposure problems in macrophotography; automatically the OM-2S PROGRAM is based on an TTL direct "OTF" metering system that provides all these photographically functional features.

The camera makes this direct light metering available in both aperture preferred auto-exposure and programmed auto-exposure modes.

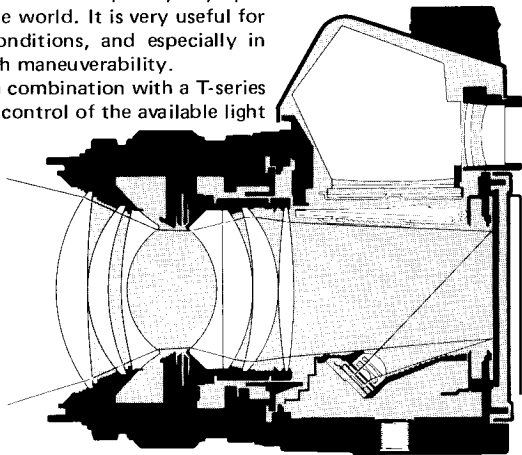

Spot Metering

This is a spot metering system that measures the spot of light intensity in the center of the picture frame (2% of the entire frame). The automatic "OTF" direct light measuring system provides correct exposure in most normal lighting situations, where the light is relatively uniform over the entire picture frame. Exposure compensation becomes necessary if there is a significant difference in brightness between the subject and its background (for example, back-lighted subjects and compositions using special lighting techniques).

The photographer may want to produce a subtle interpretation by adjusting the exposure to suit his needs. To accomplish this, spot metering is required. If the camera is switched to the MANUAL/SPOT mode it will measure the brightness within the microprism center of the viewfinder. By taking full advantage of the feature of this spot metering system, the photographer can control the exposure as he desires to create compositions as he fantasizes.

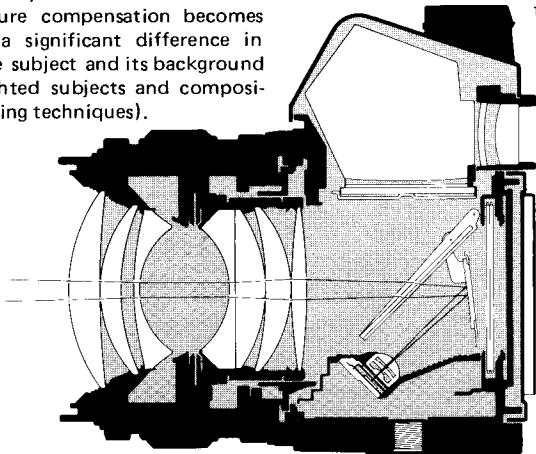

THREE EXPOSURE MODES OF THE OM-2S PROGRAM

The camera offers three different exposure modes based on the before-mentioned two metering modes. The best way to fully understand their features is to use them.

Programmed Automatic Exposure on "OTF" Direct Light Metering

This is the world's first total programmed auto-exposure mode based on "OTF" direct light metering. Because the camera automatically chooses an appropriate combination of shutter speed and aperture depending on the subject brightness, the photographer can concentrate his attention on the subject in the viewfinder. It is suited for point and shoot photography and candid shots.

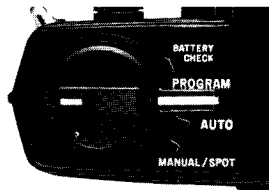

PROGRAM

Aperture Preferred Automatic Exposure on "OTF" Direct Metering

This auto-exposure mode based on "OTF" direct light metering, controls the exposure while measuring the light intensity that is reflected Off-The-Film. As it is an aperture-priority auto-exposure system that sets the shutter speed automatically according to the aperture selected by the photographer, it provides sophisticated exposures of your image.

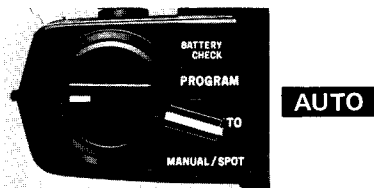

Manual Exposure on Spot Metering

This is a manual exposure mode on spot metering that measures the light intensity in the center of the picture frame (2% of the entire frame). It is especially suited for backlighted subjects and other lighting situations where specific light measurements are needed to create the special effects according to the photographer's taste.

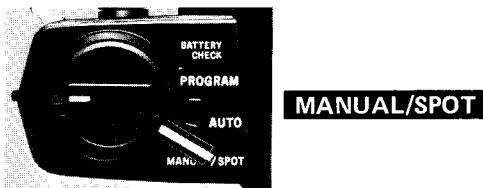

PROGRAM

PROGRAMMED AUTOMATIC EXPOSURE ON "OTF" DIRECT LIGHT METERING



In this mode, the camera automatically selects an appropriate combination of aperture and shutter speed according to the subject brightness. The photographer is freed from manipulating the aperture ring and shutter speed ring and can concentrate his attention on the subject in the viewfinder.

To operate, simply set the mode selector lever to program and set the lens aperture ring to its minimum aperture. Both the bright and dark subjects can be correctly exposed in the program mode with the optimum aperture and shutter speed combination selected by the camera. Even if you move

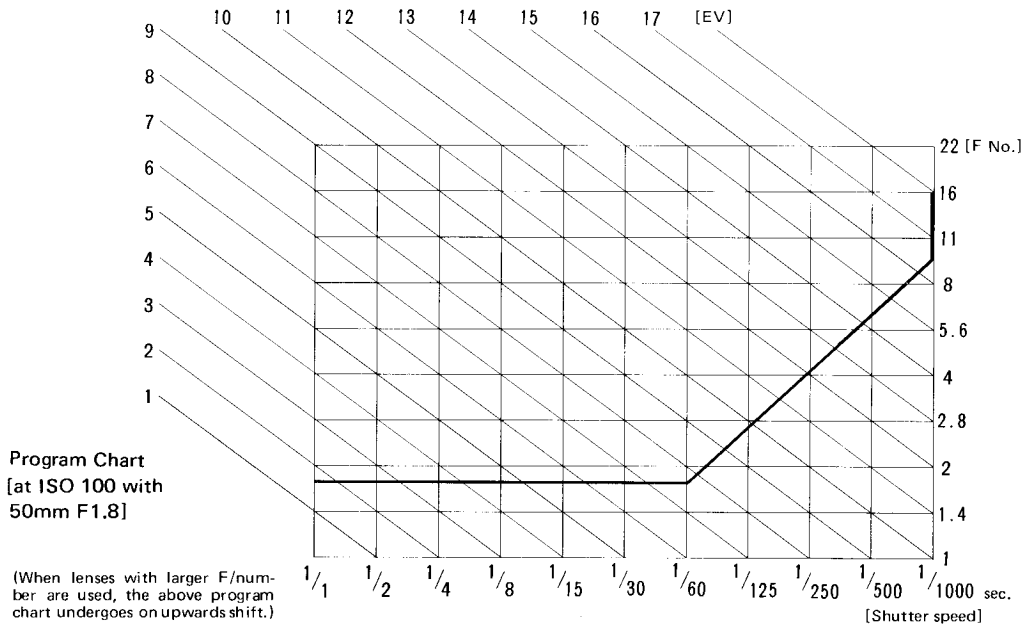

suddenly from a dark place to a brightly lit place, the camera provides the correct exposure by adjusting aperture and/or shutter speed. In this mode, you will not miss a decisive moment for lack of time.

PROGRAM**PROGRAM CHART**

Program Chart
[at ISO 100 with
50mm F1.8]

(When lenses with larger F/number are used, the above program chart undergoes on upwards shift.)

VIEWFINDER DISPLAY IN "OTF" PROGRAM MODE

If you press the shutter release button lightly while looking through the LCD viewfinder, a **PRGM** mark lights and the shutter speed is displayed in the left side of the viewfinder.

Even if the lens aperture is not set to the minimum value, the camera will take perfect exposures, within the limits of the shutter speed range available.

When the **OVER** and {} marks blink and an electronic signal sounds, the aperture ring of the lens must be closed down to its minimum aperture.

If the **OVER** mark blinks alone and the electronic signal sounds, it indicates overexposure. Use an ND (neutral density) filter according to the shooting conditions or shoot with slower film having a lower ISO number.

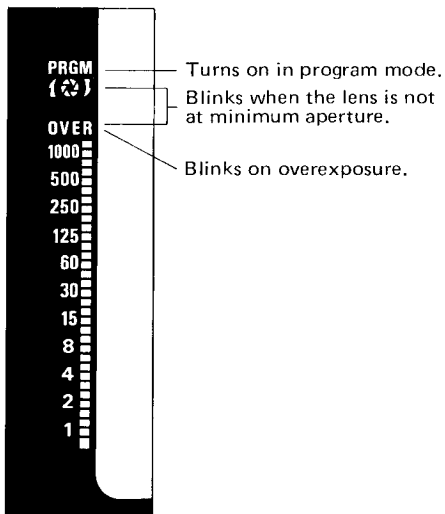

MANUAL EXPOSURE ON SPOT METERING



This mode operates by specifically metering the central spot in the viewfinder frame. If you switch the mode selector lever to "MANUAL/SPOT" and point the camera at your main subject, only that part covered by the central microprism is metered. To set exposure, simply turn the aperture ring and/or shutter speed ring to set the bar graph tip between the arrows. After setting exposure, reframe your subject as you desire. Fractional exposure compensation (\pm) in $1/3$ stop increments is also possible for the metered value.

If you shoot a backlighted portrait on "OTF"

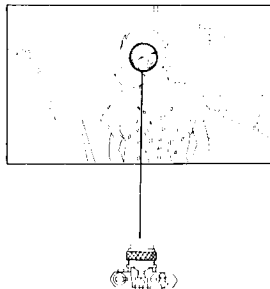

PROGRAM or AUTO for example, the subject's face will turn out underexposed and dark because the exposure meter is affected by the bright background. In this case, spot meter the face so that it is properly exposed.

All complicated calculations involving guesswork and individual experience is no longer necessary and you can shoot those backlighted pictures the way you want with ease.

SHOOTING ON SPOT METERING (1)

In MANUAL/SPOT mode, only the main subject is spot metered, unaffected by the brightness of the background.

On averaged metering, however, the subject will turn out underexposed on a bright background. The face of the subject will always be correctly exposed by spot metering on it.

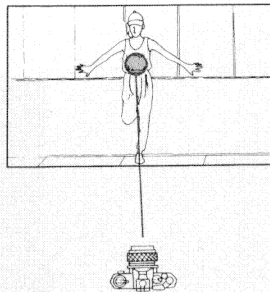

SHOOTING ON SPOT METERING (2)



In MANUAL/SPOT mode, it is also possible to get correct exposure of a subject standing against a dark background, although it will turn out overexposed on averaged metering. By spot metering on the subject alone, you can take correctly exposed pictures, unaffected by the dark background.

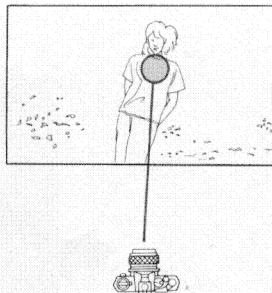

SPOT METERING AREA

To ensure correct operation of the spot metering:

- ① In spot metering, it is necessary to put the area to be metered in the microprism section. If there is a brighter spot in the microprism section than the main subject, the metering value will be affected.
- ② If a lens is changed, the light receiving angle for spot metering also changes automatically. The angle is narrower with telephoto lenses, and wider with wide angle lenses. However, the metering area seen in the viewfinder does not change.

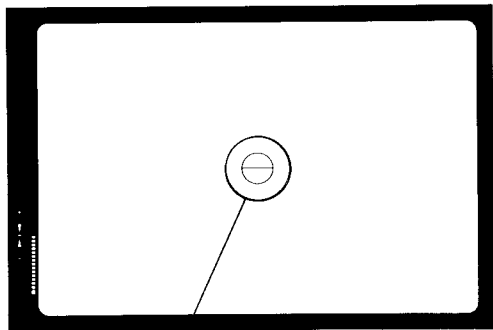

Spot metering area

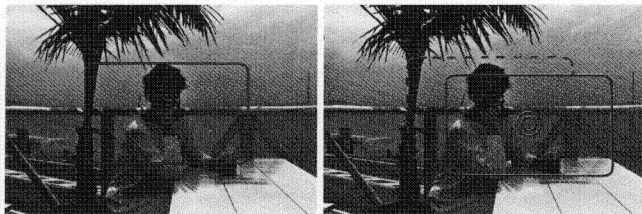

To set correct exposure, simply adjust the aperture ring and/or shutter speed ring until the bar graph tip is set at the fixed point in the viewfinder. You may change the shooting angle after spot exposure setting, too. (After framing the picture, the bar tip may shift from the fixed point.) Exposure compensation (\pm) is also possible for the metered value.

VIEWFINDER DISPLAY FOR MANUAL EXPOSURE ON SPOT METERING

This camera has a large-size liquid crystal display to show all necessary information clearly. You can concentrate your attention on your subject without taking your eye from the viewfinder.

To get correct exposure on spot metering, simply set the bar graph tip to between the arrows with the aperture ring and/or shutter speed ring. The operation is easy, because the bar tip moves in the same direction as the aperture ring turns — remember functionality.

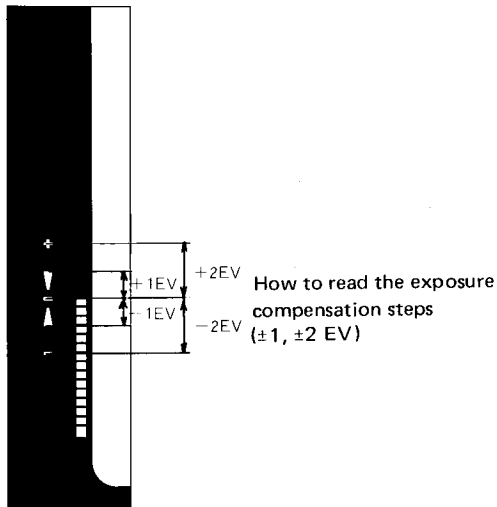

APERTURE PREFERRED AUTOMATIC EXPOSURE ON "OTF" DIRECT LIGHT METERING

AUTO

OLYMPUS
OM-2S
PROGRAM

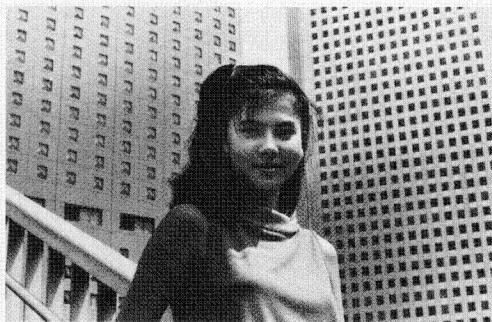

If you switch the mode lever to AUTO, you can take automatic exposure pictures with "OTF" direct light metering.

Unlike the programmed automatic exposure in which the camera chooses an appropriate combination of shutter speed and aperture, the aperture-priority automatic exposure gives you wider possibilities for creative control of time, motion, and depth. For example, if you want to make your main subject stand out on a blurred background, open up the aperture; if you want both the subject and background to be sharp, close down the aperture.



Also, shutter speed of 1/30 sec. or slower may cause camera shake. In this case, it is advisable to turn the aperture ring to a smaller F-number for a faster shutter speed or use a tripod or flash.

DEPTH OF FIELD SCALE

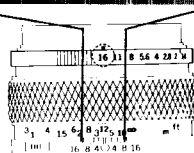
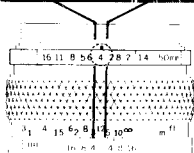
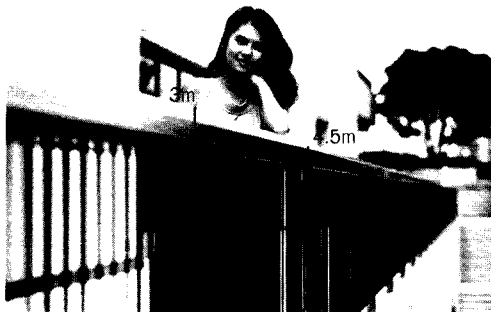

The double series of numbers engraved on the depth of field scale represent F stops: F4, F8 and F16. Once you have focused on your subject, all objects within the distance range indicated on the lens distance scale between the marks for the F/stop you have selected will have acceptable sharpness.

AUTO

PREVIEW BUTTON

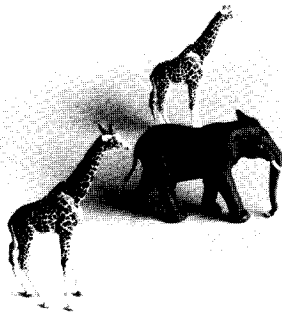

When you wish to see which objects fall within the acceptable zone of sharpness (depth of field), press the preview button on your lens. The diaphragm of the lens will stop down to the preset F stop enabling you to see the depth of field in the viewfinder.

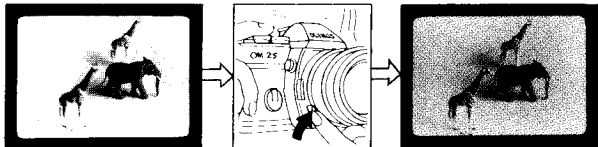

- * In PROGRAM mode, it is impossible to check the steps of field with the preview button.

CAUTION: If you jerk the preview button while depressing the shutter release button halfway down the shutter might be released.

VIEWFINDER DISPLAY FOR AUTOMATIC EXPOSURE

If you press the shutter release button lightly while looking through the viewfinder, you will see the automatic shutter speed in the left side of the frame. However, if the OVER mark blinks and an electronic signal sounds, it means overexposure and you will have to close down the aperture.

If the OVER mark does not disappear even when the lens is set to its minimum aperture, it is necessary to use an ND (neutral density) filter or shoot with film having a lower ISO number.

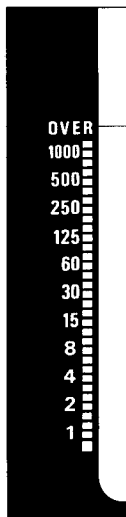

Blinks in case of overexposure

AUTO

SHUTTER SPEEDS

This camera offers various possibilities for visual expression by changing the shutter speed.

High shutter speeds can be used to "freeze" a moving subject to give sharp definition of the image. Shutter speeds of $1/1000$ sec. can "stop" the movement of a considerably fast moving subject. A shutter speed of about $1/250$ sec. will be enough to shoot a child at play, if he is not moving too quickly.

There are two methods for giving dynamic expressions. The first one is to blur out the movement of the subject itself thereby creating a moving image. The second one is to pan the camera according to the movement of the subject. While the background is blurred, the subject is sharply defined to create a moving image.

* In using slow shutter speeds, it is necessary to guard against camera shake. We will suggest a very practical method for choosing shutter speeds. Generally, shutter speeds of which denominator value is larger than the focal length value of the lens used are good for preventing camera shake. If you are using a 50mm lens, for example, shutter speeds of $1/60$ sec. or higher are best; and if you are using a 200mm lens, shutter speeds of $1/250$ sec. or higher are best.

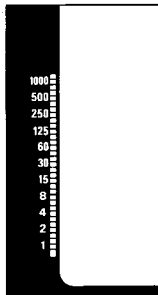

AUTO

OLYMPUS
OM-2S
PROGRAM

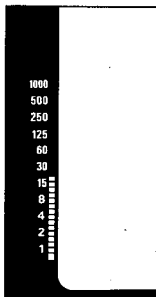
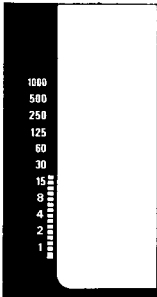
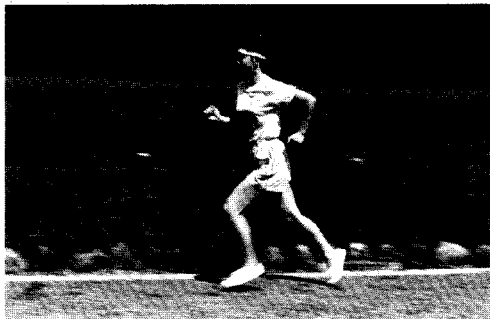

EXPOSURE COMPENSATION

The OM-2S PROGRAM permits exposure compensation with its Exposure Compensation Dial. If the background is brighter than the subject, turn the dial and set it to a (+) side position. The amount of exposure is double on (+1) position, and four times on (+2) position.

If the background is darker than the subject, turn the dial and set it to a (–) position.

If the compensation dial is turned, the +/- display in the viewfinder blinks. The bar graph display shifts according to the amount of compensation.

BULB SETTING



A 29

To take night pictures and other subjects requiring long exposure, use a tripod and cable release and shoot at B (bulb) to prevent camera shake. Set the Shutter Speed Ring to B (bulb) and press the shutter release.

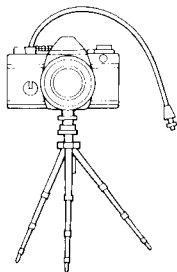

MULTIPLE EXPOSURE

By tripping the shutter several times on the same frame, multiple images are produced on the same frame.

This is how to do:

- ① After the first exposure is ended, erect the rewind crank and turn it clockwise as far as it will go to take up film slack.
- ② While holding both the rewind knob and rewind button with your fingers to prevent them from moving, wind the film advance lever. In fact, the film is not wound and the shutter is cocked by this operation.
- ③ Press the shutter release as you would do normally, and double exposure will occur.
- ④ By repeating the steps ② and ③, the frame will be exposed as many times as you want. However, the frame counter advances each time the shutter release is pressed.
- ⑤ After ending the multiple exposure, put the front lens cap on and make a blind shot.

Note: The frame may shift slightly.

INFRARED PHOTOGRAPHY

OLYMPUS
OM-2S
PROGRAM

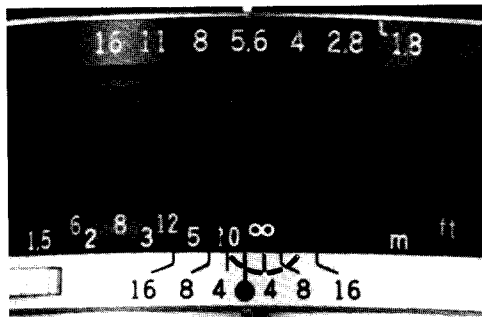

When shooting infrared pictures with infrared film and a red filter, the point of focus will slightly differ if you focus visually. The amount of shift varies with the lens and a red line or red dot is marked on the lens' depth of field scale to compensate for it. First, focus the lens without a red filter on as you would do normally. Next, read that distance on the distance scale and shift it opposite the infrared mark, then put on a red filter and shoot. (The above picture was taken with the distance at infinity.)

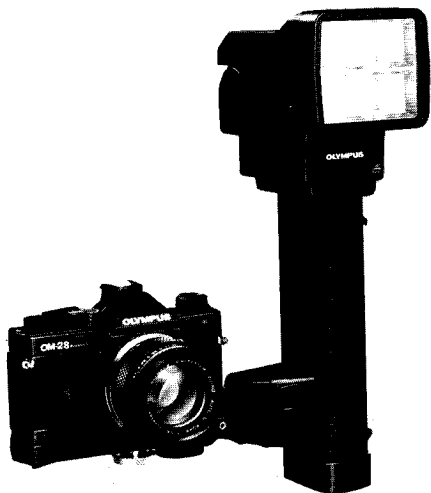

Electronic flash is very similar to daylight. As it is well balanced for daylight type color films that are most popular, the electronic flash is used for various photographic applications. Electronic flash is especially useful in unfavorable lighting situations, ensuring easy, error-free picture taking. In dim light, for example, without an electronic flash you will have to use slow shutter speed with a risk of causing camera shake and blurred motion. Under the illumination of a fluorescent lamp or incandescent lamp, the picture often does not come out with correct colors because it lacks proper color balance. Electronic flash solves all these problems.

The electronic flash can also be used in daylight as fill-in light for backlighted subjects or subjects with too strong a contrast as well as for freezing a fast moving subject.

Combined with a T-series flash, the OM-2S PROGRAM provides four flash exposure modes: "OTF" programmed auto mode, "OTF" aperture preferred auto mode (TTL AUTO), normal auto mode, and manual mode.

HOW TO USE A T-SERIES FLASH UNIT

If you use a T-series flash on the OM-2S PROGRAM the exposure mode on the flash automatically switches according to the camera's exposure mode. If you want to take pictures in the "OTF" programmed exposure mode, set the camera's mode lever to PROGRAM, set the lens to its minimum aperture, clip on the T-series flash and turn on the power switch. The camera will automatically set the aperture depending on the subject brightness. To take pictures in the "OTF" direct auto mode, set the camera's mode lever to AUTO, clip on the flash, and turn on the power switch. You will have to set the aperture by yourself.

To take pictures in the manual mode, set the camera's mode lever to MANUAL/SPOT and set the shutter speed to 1/60 sec. or slower. In this mode, the flash will always fire at full power output.

* If the flash unit switch is left on, the camera batteries will be drained. Make sure to turn off the flash switch after taking pictures.

MAIN SPECIFICATION OF T-SERIES FLASH

	Guide Number	Coverage Angle
Electronic Flash T45	45 (ISO 100, meters) or 146 (ISO 100, feet)	53° vertical, 74° horizontal
Electronic Flash T32	32 (ISO 100, meters) or 104 (ISO 100, feet)	53° vertical, 74° horizontal
Electronic Flash T20	20 (ISO 100, meters) or 66 (ISO 100, feet)	40° vertical, 58° horizontal

ELECTRONIC FLASHES OTHER THAN THE T-SERIES FLASH UNITS



Flash Duration	Number of Flashes	Dimensions and Weight
1/40,000— 1/1,000 sec.	100—500 with Ni-Cd Pack (differs with flash-to-subject distance on Auto)	283(H) x 87(W) x 116(D)mm 1,120 gr. (less batteries)
1/40,000— 1/1,000 sec.	100—500 with AA-size alkaline batteries (differs with flash-to-subject distance on Auto)	81(H) x 70(W) x 104(D)mm 320gr. (less batteries)
1/40,000— 1/1,000 sec.	120—500 with AA-size alkaline batteries (differs with flash-to-subject distance on Auto)	68(H) x 57(W) x 77(D)mm 160gr. (less batteries)

- 1: Mount the flash on the accessory shoe.
If you are using a flash that has no direct contact, connect the flash synchro cord to the synchro terminal.
- 2 Set the film speed on the flash.
- 3: Set the shutter speed ring to 1/60 sec.
- 4: If the flash has an AUTO/MANUAL switching device, set it to either AUTO or MANUAL.
- 5 Determine the aperture and set it on the camera.
If you are using an auto flash, set the desired F stop on the flash unit and then set the aperture ring to this F stop.
If you are using a manual flash, calculate the aperture by the following formula or using the flash's calculator panel and set it with the camera's aperture ring. (ISO 100-m)

$$\text{Aperture} = \frac{\text{Flash guide number}}{\text{Flash-to-subject distance}}$$

BOUNCE FLASH



The electronic flashes T32 and T45 have a flash head that tilts 90° upward. They provide bounced lighting on TTL AUTO by simply turning on the flash switch.

* Set the tilting angle so that the subject is not directly illuminated.

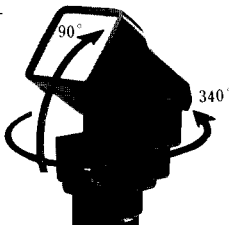

Electronic Flash T45

CLOSE-UP FLASH



On the T32, the flash head also tilts 15° downward. As it operates with all available apertures on TTL AUTO, it enables you to take close-ups easily on auto 90° by simply turning on the flash switch.

* The flash head will stop just in front by setting the stopper in the middle position.



Electronic Flash T32



SHOOTING WITH MOTOR DRIVE

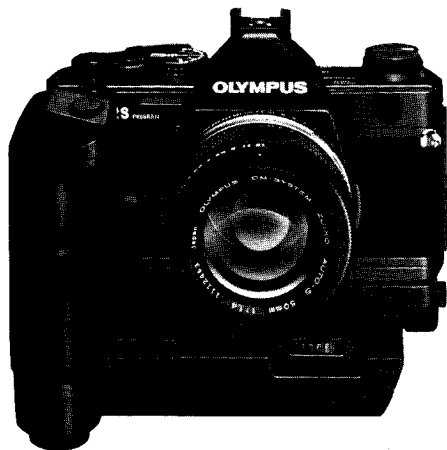

Shooting with motor drive is very exciting because it enables you to capture your subject in a critical moment by making several shots in a second.

The high speed OM System motor drive has achieved an extremely compact and lightweight design to take full advantage of its ease of operation and high maneuverability. Motor Drive 2 — the 5-frame-per-second** motor drive with a built-in computer. It is equipped with an LCD display of the number of frames and the operating procedure. In addition, the Winder 2 is also available, which offers both single-frame exposures and sequential exposures on dial switching.

The OM System's outstanding maneuverability and operability are ideal for shooting dynamic sports photos and documentary press photos. Various accessories can be connected by a direct contact.

* The Motor Drive 1 can also be used.

** Up to 3.5 frames a second with OM-2S PROGRAM.

MOTOR DRIVE GROUP UNITS

Selection of Motors

- **Motor Drive 2.** If you want to shoot very fast moving subjects such as a dashing animal or a racing car driving at full speed, the Motor Drive 2 is the best choice because it permits continuous shooting at a high speed of up to five frames a second (up to 3.5 frames a second with OM-2S PROGRAM). This quick shooting capability will often allow you to catch a dramatic instant.
- **Winder 2.** The Winder 2 is very helpful for shooting impressive moments such as sports scenes and children at play. As it permits continuous shooting at a rate of up to 2.5 frames a second (up to 2.2 frames a second with OM-2S PROGRAM), you will not miss a decisive moment.

Selection of Power Source

- For the Motor Drive 2, the following two power units are available: a small, lightweight and portable flat-type rechargeable power unit, M.15V Ni-Cd Control Pack 2, and a grip-type battery power unit, M.18V Control Grip 2, which provides added stability when used with a telephoto lens.
- The Winder 2 has a self-contained power supply, but two external power units are also available:

M.6V Power Pack 1 and 6V Power Pack 2.

Film Back

- To shoot many pictures in succession, the 250 Film Back 1 which permits up to 250 exposures is available for the OM-2S PROGRAM. It allows you to save the time for film change and take full advantage of the motor performance.

Remote Control System

- Both the Motor Drive 2 and Winder 2 can be easily remote-controlled with a dedicated remote cord. Besides the Remote Cords 1.2m and 5m, the M. Quartz Remote Controller 1 with an electronic counter is available, which allows you to trigger the camera and check its operation with an LCD display at a remote location. It is very useful for shooting wild birds and animals and for macrophotography and photomicrography to trip the shutter without a shock.

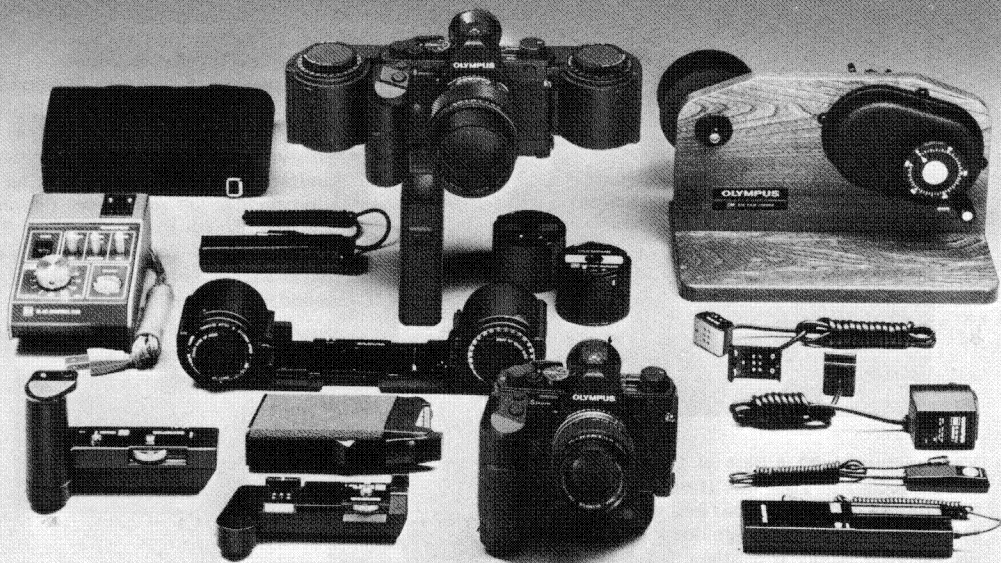

RECORDATA BACK 4

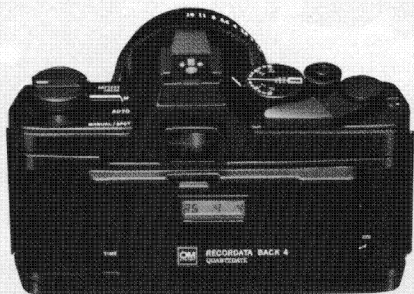

Your pictures with a date or time will provide a perfect record of your life. If you print a date and time on the pictures of your important events such as wedding, entrance and graduation ceremonies as well as your family trips, they will evoke stronger

memories in later years. Pictures with a date are also easier to arrange in an album. This data back can also be used for preparation and classification of various scientific and research materials.

Data imprinting is possible in the following formats:

- (1) Year—month—day (Japanese date description),
- (2) Month—day—year (American date description),
- (3) Day—month—year (European date description),
- (4) Hour—minute, (5) Counter (additive type),
- (6) Classification number up to 6 digits. Provided with an imprint clear switch to be used when data imprinting is unnecessary. This Recordata Back can also be used as a clock which indicates the hour, minute and second via a Time Button.

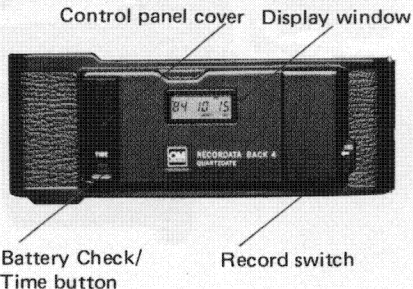

MACROPHOTOGRAPHY



The world of macrophotography is filled with marvelous discoveries. However, macrophotography has been generally considered difficult; calculations of correct exposure, in particular, have been a difficult job even for professionals.

Equipped with a TTL direct light metering, the OM-2S PROGRAM has solved this problem to always provide correct exposure, regardless of the magnification and aperture. All complicated exposure calculations for multi-lamp flashing are now quite unnecessary. The OM-2S PROGRAM also provides a complete macro system including a wide choice of macro lenses that offer excellent life-size and magnified pictures as well as extension units that enable you to take handheld macro pictures.

COMBINATION OF SYSTEM UNITS FOR CHOICE IN TERMS OF MAGNIF

Lens		Magnification (shooting area in mm)						
		0.1× (360×240)	0.2× (180×120)	0.3× (120×80)	0.5× (72×48)	0.6× (60×40)	0.8× (45×30)	1× (36×24)
Standard Lenses		1/∞		0.1~0.14×				
ZUIKO MACRO	50mm F3.5	1/∞			0.5×			
ZUIKO MACRO	135mm F4.5	1/∞			0.43×			
ZUIKO 1:IMACRO	80mm F4				0.48×			1.2
ZUIKO MACRO	38mm F3.5							
ZUIKO MACRO	38mm F2.8							
ZUIKO MACRO	20mm F3.5							
ZUIKO MACRO	20mm F2							
ZUIKO MACRO	38mm F2.8							
ZUIKO MACRO	20mm F2							
ZUIKO MACRO	38mm F2.8							
ZUIKO MACRO	20mm F2							
ZUIKO MACRO	135mm F4.5	1/∞		0.5×			1.0×	
ZUIKO 1:IMACRO	80mm F4	0.09×						
ZUIKO MACRO	38mm F3.5							
ZUIKO MACRO	38mm F2.8							
ZUIKO MACRO	20mm F3.5							
ZUIKO MACRO	20mm F2							

*  Recommended close-up range (with lens retracted)

 Recommended close-up range (with lens extended)

 Possible close-up range

ICATION

1.5× (24.1×16)	3× (12×8)	5× (7.2×4.8)	10× (3.6×2.4)	12× (3×2)	33× (2.7×1.8)	Extension Units	
2×						Close-up Lens 80mm Macro	Telescopic Auto Extension Tube 65-116
2.5×	4×					Used with Objective lens mount	
3.1×	4.5×						
5.8×	8.3×					Used with Objective lens mount	
6.8×	9.5×						
2×	2.1×						
4.7×	4.9×					Auto Extension Tube 25	
1.7×	1.8×						
4.2×	4.4×					Auto Extension Tube 14	
2.2×							
1.8×	6.1×					Used with Objective lens mount	Auto Bellows
2.3×	6.7×						
4.3×	12.4×					Used with Objective lens mount	
5.3×	13.6×						

MACROPHOTO GROUP UNITS



Simplified Macro System

It allows you to take close-ups up to life size with ease. With this macro system, you will come upon unexpected and wonderful discoveries in tiny things around you such as writing instruments, printed letters, flowers in a vase, etc.

- **Close-up Lenses 49mm and 55mm, $f=40\text{mm}$.** Simply screw them in the front of the standard lens, and you can take up to 0.63X close-ups.
- **Auto Extension Tubes 7, 14 and 25.** These adapters are placed between the lens and camera body and available in three thicknesses: 7mm, 14mm and 25mm. They can be used in seven combinations. With the standard lens, you can take up to 1.1X close-ups.

Basic System

This is a complete macro system that permits low to high magnifications. It will produce a brilliant image of the marvelous world of tiny things such as the geometric beauty of the compound eye of a dragon fly and close-ups of flowers. An indoor type and outdoor type are available.

Indoor type: This system uses an auto bellows, macro photo stand, top-light illumination device, etc. in combination with various macro lenses. It is suited for taking high-magnification pictures in a room or studio.

- **Auto Bellows.** A basic unit that helps you take full advantage of the system's capabilities with a variety of lighting units and mounts. The stop-down lever that lets you use a variety of OM System lenses at preset aperture or operated in combination with the double cable release, affords an automatic diaphragm photo function.
- **Zuiko Macro 20mm F2.** Large-aperture macro lens designed exclusively for macrophotography. Combined with the Auto Bellows, it permits magnifications ranging from 4.2X to 16X. Provided with a helicoid for fine focusing.

MACROPHOTO GROUP UNITS

- **Zuiko Macro 38mm F2.8.** Bright, high-magnification macro lens designed exclusively for macro photography. Combined with the Auto Bellows, it permits magnifications ranging from 2.3X to 6.7X. Provided with a helicoid for fine focusing.
- **Macrophoto Stand VST-1.** A compact and sturdy multipurpose stand for solid camera support in close-up and macrophoto work. Comes with frosted stage glass for incident light and may be used in conjunction with Trans-illuminator Base X-DE for lighting of transparent subjects from beneath.
- **Epi-illuminator PM-LSD2.** A two-piece lighting set providing ideal reflected light for macrophotography. Moving the filament allows you to change the position and field of illumination.







Outdoor type: This is a handy and highly maneuverable system which includes macro lenses, telescopic auto extension tube 65—116, etc.







- **Telescopic Auto Extension Tube 65—116.** With its variable tube length, this auto extension tube enables you to change the shooting distance and magnification freely.
- **Zuiko 1 : 1 Macro 80mm F4:** This lens is designed specifically for life-size reproductions. It functions at its best at a 1 : 1 ratio, but gives outstanding

images from 1/2 to 2X life-size, the range of magnifications available when used with the Auto Bellows. With the Telescopic Auto Tube it goes up to life-size, and the close-up lens is used to extend the range to 2X magnifications.

- **Zuiko Macro 135mm F4.5.** Shoots from infinity to life-size with the Auto Bellows, or 0.43X magnifications with the Telescopic Auto Tube, giving long working distances and minimal perspective distortion. It has a helicoid ring for fine focusing.
- **Zuiko Macro 50mm F3.5.** Designed for optimum performance at 1/10 magnifications, this outstanding lens gives superb results in general purpose photography at infinity, or for macro subjects as large as 1/2 life-size.

FINDER GROUP UNITS

TYPE	SCREEN	FEATURES
<p>1-1 Microprism-matte type (for most lenses)</p>		<p>Standard type, suitable for general photography. Fast and accurate focusing is done on the central microprism spot as well as on the surrounding matte area. When a lens with a maximum speed of F5.6 or slower is used, the microprism darkens and focusing must be made on the matte area.</p>
<p>1-2 Microprism-matte type (for standard & telephoto lenses)</p>		<p>Suitable for general photography in conjunction with a standard or telephoto lens. Focusing is done on the microprism spot as well as on the matte area. When a lens with a maximum speed of F8 or slower is used, the microprism spot darkens.</p>
<p>1-3 Split image-matte type (for most lenses)</p>		<p>Suitable for general photography ensuring critical focusing, and ideal for photographers who prefer the split-field and coincidence type focusing. When a lens with a maximum speed of F5.6 or slower is used, the split prism darkens.</p>
<p>1-4 All matte type (for most lenses)</p>		<p>Suitable for general photography and ideal for photographers who prefer a view field free from microprism or split prism and for those who are accustomed to focus using matte area. Also suitable for super telephoto photography and close-up photography in conjunction with macro lenses and Auto Bellows.</p>
<p>1-5 Microprism-clear field type (for wide angle & standard lenses)</p>		<p>This transparent screen provides an exceptionally bright finder image. Highly suitable for snapshots using wide angle lenses. The lack of matte surface means depth-of-field effects cannot be ascertained.</p>
<p>1-6 Microprism-clear field type (for standard & telephoto lenses)</p>		<p>This screen provides an extremely bright finder image. Focusing is done on the microprism spot. The lack of matte surface means depth-of-field effects cannot be ascertained.</p>
<p>1-7 Microprism-clear field type (for super telephoto lenses)</p>		<p>Developed primarily for use with super telephoto lenses this clear field screen provides an extremely bright finder image. The microprism spot remains bright even with a lens whose maximum speed is F11. The lack of matte surface means depth-of-field effects cannot be ascertained.</p>

TYPE	SCREEN	FEATURES
1-8 All matte type (for telephoto lenses & astronomical telescopes)		This screen is ideal for use with super telephoto lenses of 300mm or more in focal length, or for astrophotography. The extreme fineness of the matte surface permits outstanding field definition. More accurate focusing may be achieved by the use of the Varimagni Finder.
1-9 Clear field type (for endoscopic photography)		Designed for use with OLYMPUS fiberoptic endoscopes. This condenser type screen without fresnel lens requires no focusing when a special adapter couples the camera with the fiberscope. Exposure is made automatically by the light supply.
1-10 Checker-matte type (for shift lens)		The grid lines engraved on the all-matte surface are used for vertical and horizontal picture alignment. Though originally designed for architectural photography with the shift lens, it is also suitable for general and super-telephotography, and close-up/macro photography with macro lenses and Auto Bellows.
1-11 Cross hairs-matte type (for close-up & macro-photography)		Highly advantageous for close-up and macro photography with Auto Bellows and extension tubes. For focusing in low magnification close-up photography, use the matte area and in macro photography greater than life size, use the double cross hairs the same way as with the 1-12.
1-12 Cross hairs-clear field type (for photomicrography & macrophotography greater than life size)		The transparent screen offers the photographer focusing with an unusually bright finder image. To focus, first correct your diopter using a dioptic correction lens or Varimagni Finder so that each line of the double cross hairs can be seen clearly and separately. Then bring the specimen into focus.
1-13 Microprism/split image-matte type (for most lenses)		Most suitable for normal photography, this screen assures pinpoint focusing. The central split-image rangefinder is encircled by a microprism collar. Since the outer area has a matte surface, the screen can be used in the same way as the standard 1-1 and 1-3 Screens. When a lens with a maximum speed of F5.6 or slower is used, the prisms darken and the focusing must be made on the matte area.
1-14 Microprism/split image-matte type (for most lenses)		Most suitable for normal photography. The central split-image range finder, encircled by a microprism collar, is inclined 45 degrees to allow easy focusing on subjects with vertical or horizontal lines. When a lens with a maximum speed of F5.6 or slower is used, the prisms darken and focusing must be made on the matte area. The meter needle gives correct light readings.

QUESTIONS AND ANSWERS (1)

Q: In the PROGRAM mode, it seems that the shutter speed displayed in the viewfinder differs from the actual shutter speed.

A: When using a 50mm F1.2, 50mm F1.4, 75–150 mm ZOOM and 35–105mm ZOOM lens, the shutter speed displayed in the viewfinder will differ from the actual one by approximately one stop. However, correct exposure is always insured.

Q: Are there any lenses that cannot be used in the PROGRAM mode?

A: The following lenses cannot be used in the programmed mode. Use these lenses in the (aperture-preferred) AUTO mode or MANUAL/SPOT mode.

250mm F2, 350mm F2.8

600mm F6.5, 1000mm F11

Q: I want to take macro pictures with a flash in "OTF" PROGRAM mode. Is it possible?

A: The pictures may sometimes be slightly overexposed because the PROGRAM mode does not allow the lens to be stopped down enough. It is therefore recommended to use the aperture-preferred "OTF" AUTO mode.

Q: In the PROGRAM mode, OVER & {☺} display appears even at minimum aperture.

A: It may sometimes happen with lenses that have not many F/stops (e.g. 50mm F3.5 macro and 24mm F2.8). Use an ND filter that suits your shooting conditions or a film with a lower ISO/ASA speed.

Q: My pictures tend to be overexposed when shooting transparencies with flash in PROGRAM mode.

A: In this case, the pictures may turn out overexposed depending on the shooting conditions. Use the aperture-preferred auto mode to stop down the lens if necessary.

Q: The tip of the shutter speed display bar blinks frequently during light metering.

A: This occurs mostly in the case of metering under a fluorescent lamp. Though the fluorescent lamp appears to the human eye as it were lighting continuously, it is in fact blinking repeatedly at a frequency of 50–60 cycles a second. Each particle of the shutter speed bar display represents 1/3 EV. Therefore, if the luminosity is unstable or in the case of a luminance mediated between the bar tip and the adjacent particle, the bar tip will blink.

In actual exposure determinations, however, variations of light are averaged, causing no pro-

blem (in AUTO or PROGRAM mode).

Q: The shutter remains open and does not close.

A: If you shoot with the lens cap on, the shutter will remain open for about 1 minute. In this case, switch the mode lever to the battery check mode. The shutter will immediately close.

Q: In flash photography, the auto check lamp (correct flash exposure confirmation lamp) of the flash is blinking while OVER is on display in the viewfinder. Why?

A: The auto check lamp of the flash will blink not only at the time of correct exposure, but also at the time of overexposure. On the OM-2S, however, the display of correct, over and underexposure will appear separately in the viewfinder, so be sure to check exposure in the viewfinder.

Q: Is spot metering possible in the flash mode?

A: No, spot metering is not possible.

Q: I want to use a flash that is not of the T-series.

A: Set the mode lever of the OM-2S to MANUAL. You are now ready to use your flash by simply clipping it on the camera's accessory shoe or connecting it via a PC sync. cord. Caution is required, however, because the flash ready

lamp and the flash discharge confirmation lamp will not turn on in the viewfinder. A flash with opposite polarity will in no case discharge. Be sure to read the Operation Manual of your flash carefully.

Q: The flash does not fire.

A: There are two possible reasons. (1) On PROGRAM mode or AUTO mode, flash firing is automatically inhibited at shutter speeds faster than 1/60 sec. (2) Are the camera batteries exhausted? In this case, the flash will not fire even at a mechanical shutter speed of 1/60 sec. or "B".

Q: I want to take pictures with the motor socket cover detached even when I am not shooting with the motor drive, because attaching and detaching it is quite troublesome.

A: The motor cover should always be attached if you are not shooting with the motor drive. It will prevent entry of dust and exposure by direct light.

Q: Is it possible to use "B" and 1/60 sec. (mechanical shutter) with the motor drive?

A: No, it is not possible. To shoot at "B" or 1/60 sec., use the shutter release button.

QUESTIONS AND ANSWERS (2)

Q: At how many frames per second can the motor drive shoot?

A: 3.5 frames/sec.

Q: Why won't the shutter release button move when I press it?

A: The film advance lever may not have been fully advanced.

Q: My camera is loaded with film. Why doesn't the rewind knob rotate when I advance the film?

A: The film leader may not be inserted in the film take-up spool and the film is not advancing.

Q: Is it normal for the microprism in the viewfinder to "shimmer" and the split image darken?

A: Such a phenomenon will occur when a lens with a maximum aperture of F5 or smaller is mounted on the camera. In this case, focus the lens with the matte area of the focusing screen. Even when a lens faster than F5 is used, the phenomenon may also occur if your viewing angle is off of the optical axis of the finder.

Q: The display in the viewfinder has disappeared while the camera is operating.

A: As the OM-2S has an energy-saving design, the display will automatically disappear in 120 sec-

onds. To turn it on again, touch the shutter release lightly.

Q: What will happen if I return the self-timer lever to its original position while it is operating?

A: The shutter will trip. After using the self-timer, be sure to return the lever to its original position.

Q: Why is the automatic exposure shutter speed much longer than indicated by the meter in the viewfinder?

A: If film is not loaded, the shutter speed is much longer than that indicated. If it is necessary to obtain a correct reading without actually taking a picture, insert a waste, undeveloped film or the paper you find behind the camera back at the purchase of your OM-2S into the film position in the camera.

Q: The rewind crank does not turn.

A: Press in the rewind button.

Q: Why can't I advance the film?

A: The shutter may be cocked and ready to fire. Try pressing the shutter release button.

Or, the film may be fully exposed. Check the exposure counter. If you feel tension on the film advance lever. DO NOT FORCE IT. Rewind the film. Or the self-timer lever is not

securely in its upright position, reset and release the self-timer.

Q: The film advance lever does not operate and I see nothing in the viewfinder.

A: Are there batteries in the camera? Are they exhausted? Check with the battery checker to see if they are operating properly. If the audible and visual signals do not turn on, they are not. The mirror will spring back if you replace the batteries or set the shutter speed ring to the red 1/60 sec. (mechanical shutter) or "B".

Q: When should I check the batteries?

A: (1) When new batteries are inserted. (2) After the camera hasn't been used for a long time. (3) Before beginning a prolonged period of use. (4) When the temperature is very cold.

Q: Is it possible that the shutter does not fire when the battery check is O.K.?

A: When using the self-timer, if the battery voltage is not enough, the shutter may not fire even though the battery check is O.K.

Q: What batteries should I use?

A: Use two 1.5V silver oxide batteries SR44 (Eveready EPX-76 or equivalents). Never use 1.3V mercury batteries (though they are the same size).

Q: How long do the batteries last?

A: Generally, SR44 batteries will last about one year, LR44 batteries about six months.

Q: The batteries have worn out while I was shooting in cold weather. What can I do to take pictures?

A: Use a mechanical shutter speed of 1/60 sec.

Q: Why can't I set the ISO film speed I need with the Film Speed Dial?

A: At the most, 3 stops can be advanced in a single stroke of the dial. If this is not enough stops, lift up and rotate the outer collar of the dial until it stops; then release the collar and rotate the collar and dial together until the white line is aligned with the black index on the pentaprism. Repeat this procedure until you reach the ISO film speed you need.

Q: I took pictures with the aperture ring set at a halfway position between the F/stop numbers. Was the film properly exposed?

A: Yes, you can use any in-between settings on the aperture ring to obtain precise exposure.

Q: How about in-between settings of the shutter speed ring in the manual mode? For example, between "125" and "250".

A: In this case the film was still properly exposed

QUESTIONS AND ANSWERS (3)

but at either 1/125 sec. or 1/250 sec. It is recommended that you set the shutter speed ring at a shutter speed index engraved on the camera, not in between.

Q: In the finished print, a peripheral portion of the picture is cut; though I framed it inside the viewfinder.

A: In some color prints and color slides, a peripheral portion of the picture may be eliminated in the laboratory. It is recommended, therefore, to leave some margin in composing your picture.

Q: How do I clean the camera and lens?

A: Clean the camera using a clean, soft lintless cotton cloth. Clean the lens only with a hand powered air blower, antistatic brush or lens tissue. NEVER rub the lens surfaces with your finger, clothing or other abrasive material.

Take care not to permit water to enter the camera when taking pictures in the rain or snow, especially near seawater spray. After use near the ocean, wipe the camera surfaces clean and never leave salt residue on the camera.

Q: There are sometimes scratches on the film.

A: The cause may be a soiled film passage. The film compartment may be soiled by film debris during long use of the camera. Be sure to dust

off the camera periodically.

Q: How do I store the camera?

A: Remove the camera from its case and store it in a dry, well ventilated place. Protect against excess moisture by using packs of silica gel or other desiccant in the storage area. Do not store the units near moth balls or similar volatile chemical materials to avoid the possibility of damage to metal surfaces.

Other cautions

- When the OM-2S PROGRAM is used with other brand lenses, Olympus can not assume any responsibility for poor image quality or other problems. This is particularly true when other brand lenses are used in PROGRAM mode.
- The exposure value will shift on spot metering with a linear polarizing filter. In this case, use a circular polarizing filter.
- The Recordata Backs 1 and 2 cannot be used.
- The Motor Drive Socket Cap on the camera side cannot be stored in the Motor Drive 1 or Winders 1 and 2.