

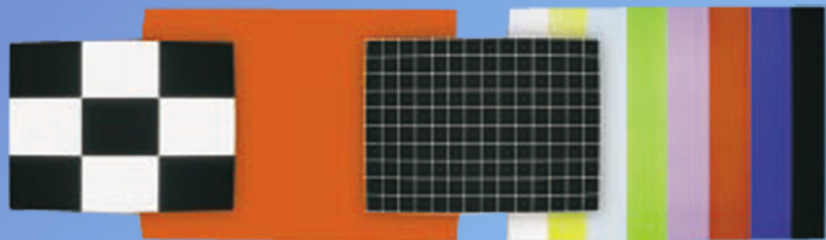

700 Series

Portable Video
Test Generators

Quick Start Guide



Contents

Model 700, 701 Video Test Generators *Quick Start Guide*

Getting Started	2
Computer Interfaces	3
User Interface	4
Selecting Formats	5
Selecting Images	6
Gating Outputs	6
Setting Power Save Preferences	7
Calibrating Generator	8
Adjusting Horizontal Scan Frequency	10
Detecting Formats Supported by a Monitor	11
Using Test Sequences	12
Using Generator with CS-1 Probe	14
Testing Audio	14
Testing HDCP Interfaces	15
Generating Psuedo Random Noise	15
Using Video Generator Manager	16
Creating Video Formats	17
Modifying Test Sequence	18
Pattern Descriptions	19
Updating Firmware	23
Specifications	24
Service and Support Contacts	25

Getting Started

Using AC Power

Use only the AC adaptor provided with the generator to avoid operator injury and damage to the generator.

Using Battery Power

The generator uses six AA rechargeable nickel metal hydride (NiMH) batteries, which can be recharged about 1000 times.

You may use alkaline batteries instead, but not while the AC charger is connected to the generator. Only NiMH batteries can be safely recharged in the generator.

All batteries in the generator must be the same type.

The supplied batteries may not come fully charged. Use the supplied AC charger to charge the batteries for at least 18 hours. The AC adaptor may be used to operate the generator and to recharge the batteries at the same time.

With fully charged batteries, the generator should operate for about 8 hours using VESA mode. Using the LCD backlight, DVI, NTSC/PAL, or RF features will reduce the battery life. The generator displays a *low battery* message when the NiMH batteries need recharging, or when the alkaline batteries need to be replaced.

Computer Interfaces

DVI-I

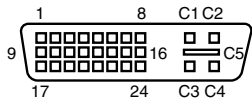

Pin	Signal	Pin	Signal
1	TMDS data 2-	16	Hot plug detect
2	TMDS data 2+	17	TMDS data 0-
3	TMDS data 2/4 shield	18	TMDS data 0+
4	TMDS data 4- shield	19	TMDS data 0/5 shield
5	TMDS data 4+	20	TMDS data 5-
6	DDC clock	21	TMDS data 5+
7	DDC data	22	TMDS clock shield
8	Analog vertical sync	23	TMDS clock+
9	TMDS data 1-	24	TMDS clock-
10	TMDS data 1+	C1	Analog red
11	TMDS data 1/3 shield	C2	Analog green
12	TMDS data 3-	C3	Analog blue
13	TMDS data 3+	C4	Analog horz sync
14	+5V power	C5	Analog ground
15	Ground		

S-Video



NTSC/PAL BNC

NTSC/PAL RF (Active on 701 only)

Stereo Audio - 3.5 mm phone jack

Tip	Left channel (1 KHz)
Ring	Right channel (2 KHz)
Sleeve	Ground



DVI interface on 700 outputs analog signals only, using included DVI-to-VGA adaptor.



RS-232 9-Pin D-Sub Plug

Pin	Signal	Factory defaults
1	No connection	9600 baud
2	Data in (Rx)	8 data bits
3	Data out (Tx)	No parity
4	DTR out	1 stop bit
5	Ground	X on - X off
6	No connection	
7	RTS out	
8	CTS in	

Pinout same as for 9 pin PC-AT serial port connector

External DC Power / Battery Recharge Input

Center pin:	+12.0 VDC
Outer sleeve:	- (Ground)

Warning: Using an external power source other than the Quantum Data supplied AC power supply may injure the operator and damage the generator.

User Interface

LCD Display

The LCD window displays messages and menu options.

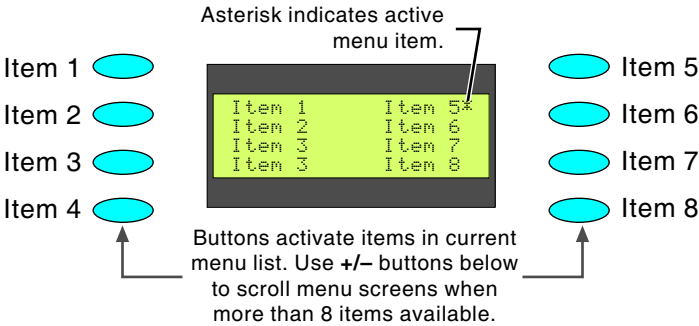

Function Buttons

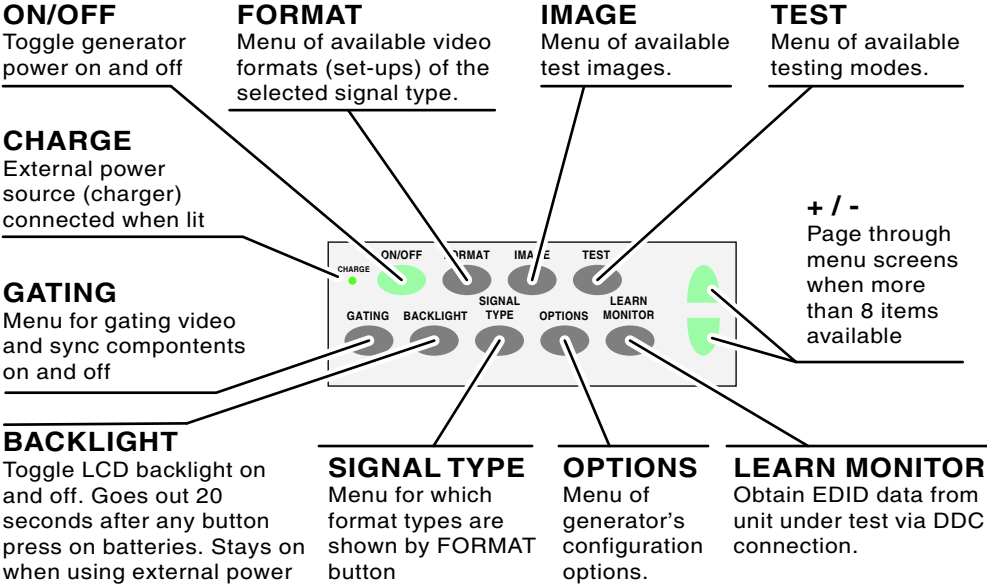

Selecting Formats

Viewing Formats by Signal Type

Press the Signal Type button, and then select a signal type, to list formats based on the selected signal type.

VESA Red, green, blue component color video per VESA standards. (DVI-to-VGA adaptor used for outputs.)

NTSC/PAL Composite color baseband video signal (BNC connector) and Separate Luminance and Chrominance video signals (S-Video connector) or RGB component video per NTSC and PAL standards.

Names of formats using modulated RF output end with *_Cnn*, where *nn* is the NTSC-M or PAL-G television channel used.

HDTV/SDTV-RGB Luminance plus color difference signals per HDTV standards

HDTV RGB RGB component color video signals per HDTV standards

DVI Digital video signals (701 only)

USER User-defined formats, of any type, stored in non-volatile memory

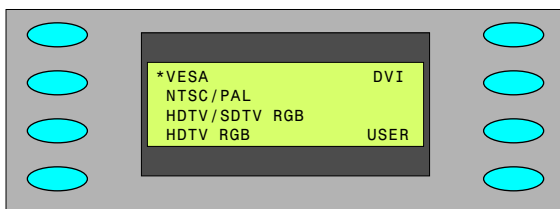

Selecting Formats

Press the Format button to select from a list of video formats of the type selected from the Signal Type menu.

Reloading Standard Formats

If you modify or delete standard formats, you can restore the original formats by reloading the standard formats.

To reload the standard formats:

1. Select Options > Clr_Fmts to delete all formats, including user-created formats.
2. Select Options > Reload Fmts to restore the standard formats to their original memory locations. The standard formats will replace any user-created formats in the original memory locations. User-created formats in locations not previously occupied by a standard formats will not be replaced.

Selecting Images

Selecting Images

Press the Image button to select from list of available test images (patterns).

You cannot modify the images, or add your own images.

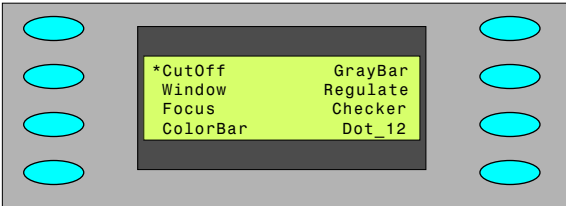

Gating Outputs

Press the Gating button to gate outputs, and to switch sync types.

Note: Color gating works for all images except Ramp.

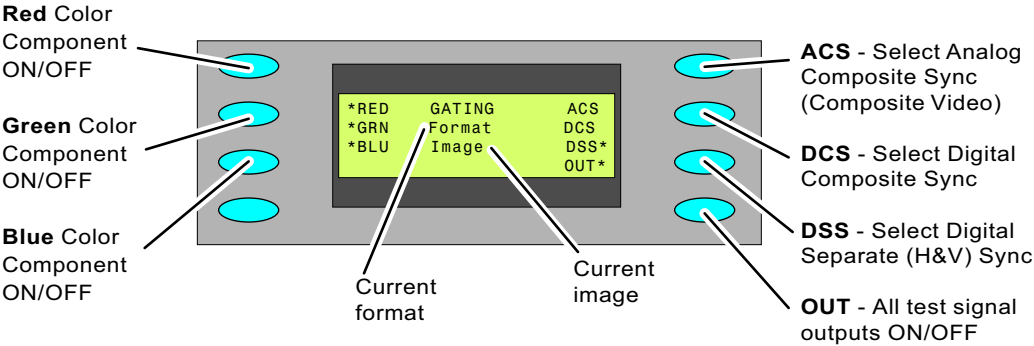

Setting Power Save Preferences

Options Menu

Press the Options button to set system-level options.

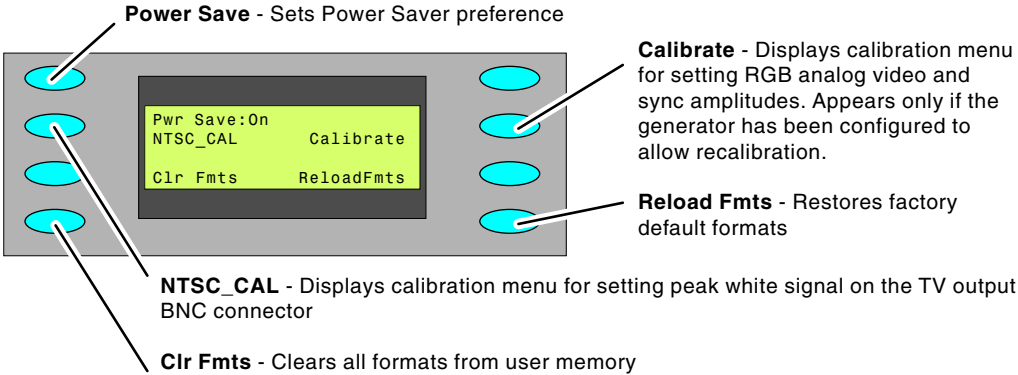

Setting Power Save Preference

When the Power Save preference is on, and the generator is on battery power, the generator will turn off after 30 minutes of no front panel activity.

If the generator is running a test sequence in Burn-in mode, the Power Save preference is ignored.

To set the Power Save preference, select Options > Pwr Save.

Calibrating

Model 700 and 701 generators use programmable hardware to set the amplitude calibration factors for analog video outputs. These calibration factors are stored in Flash EPROM, and are not lost if the batteries are run down or removed.

Quantum Data calibrates the analog video and sync output amplitudes in new generators to published specifications. You can recalibrate these amplitudes over a nominal range to meet your specific testing conditions.



WARNING: Recalling the original factory calibration settings is not possible after saving your own settings.

Equipment Needed for Calibration

- DC voltmeter capable of measuring from 0 to 1 volt with a minimum resolution of 2 millivolts
- Precision 75 ohm (+/- 1%) input terminator for the voltmeter
- Test cable to connect the voltmeter to the R, G, B and ground pins on the VGA connector
- Oscilloscope with a precision 75 ohm (+/- 1%) input impedance and suitable gain and bandwidth to display a 1.00 Volt pk-pk signal with 3.579 MHz color carrier
- 75 ohm coaxial cable to connect the oscilloscope to the BNC TV output
- Vector scope

Calibrating

Calibrating Outputs

1. Select Options > Calibrate > Reset to set the generator's calibration factors to default nominal values.
2. Press Options > Calibrate > Full Scale.
3. Set the voltmeter's scale factor to be able to measure a nominal 1000 millivolts DC.
4. Using a VGA-to-BNC cable, connect the generator's red output to the positive input on the voltmeter, with a 75 ohm (+/- 1%) input terminator. Connect the negative lead of the meter to any ground pin.
5. Select **R_FS+** or **-R_FS** to set the DC output level to 1000 mV +/- 3 mV.
6. Repeat steps 4 and 5 for the green and blue outputs.
7. Select Save.
8. Select Options > Calibrate > Zero.
9. Connect the red output to the positive input of the voltmeter.
10. Select **R_Zero+** or **-R_Zero** to set the DC output level to 0 mV +/- 3 mV.
11. Repeat steps 9 and 10 for the green and blue components.
12. Select Save.
13. Select Options > NTSC_CAL.
14. Adjust the oscilloscope's timebase and sweep trigger to view the entire waveform. Adjust the G_NTSC so that its chrominance is 100 IRE or 714mV.
15. Using a vector scope, use the **R_NTSC** and **B_NTSC** options to adjust the red and green outputs using so that their signals align with the 2% boxes.
16. Press Save.

Note: The modulated RF output does not have any calibration settings.

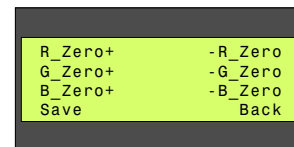
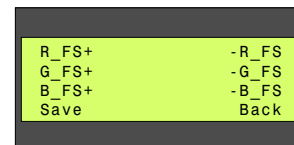
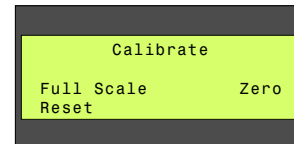

Calibrating

Locking Calibration Settings

The generator uses an internal hardware jumper to enable and disable changes to calibration settings. If the Options > Calibration option is available, the jumper is set to enable re-calibration.

To prevent users from changing calibration settings:

1. Turn the generator off, and remove the back cover.
2. Locate the J10 jumper, which is near the lower-right corner of the board.
3. Connect the jumper to only one pin to disable user calibration. Connect both bins to enable user calibration.
4. Install the back cover.

Adjusting Horizontal Scanning Frequency

Select Test > Freq Shift, and then press the +/- buttons to increase or decrease the horizontal scanning frequency of the current video format +/- 10% in 2% increments. The ^ character indicates the percent deviation. The bottom number is the actual frequency.

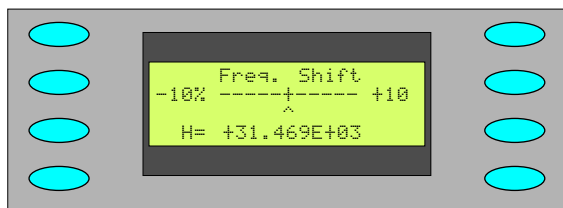

Detecting Formats Supported by a Monitor

Learn Monitor

If the generator is connected to a VESA DCC-compliant display, press the Learn Monitor button to view formats supported by both the display and generator.

To view the format names, select the Details option after the generator completes reading the EDID (Extended Display Identification Data) data. The display's EDID data may include non-VESA formats, which are not listed.

You cannot select formats from this list, but the DDC Step feature can be used to test the listed formats (page 13).

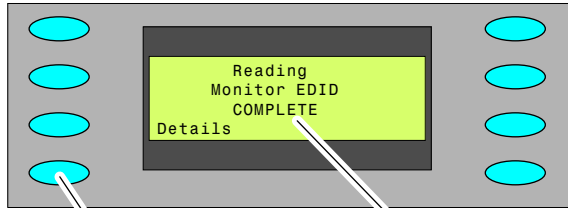

Show details of EDID after successful read back from display under test

Complete indicates EDID data was read back correctly.
Failed indicates unable to read back valid EDID data

Using Test Sequences

Test Menu

Press the Test button to select special test operating modes.

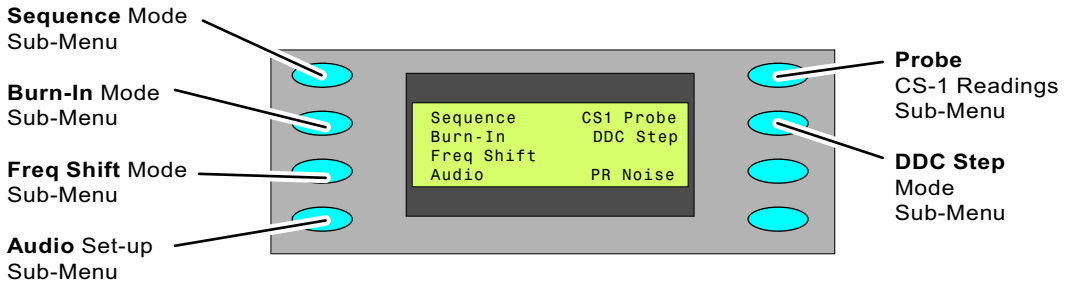

Running Test Sequence Manually

The generator includes a test sequence, which specifies a series of format and image combinations. To run the test sequence, select Test > Sequence > Run, and then press the +/- buttons to step through the sequence. Use the menu buttons to gate video color information, change sync types, and turn all signal outputs on and off.

You can use VGM to modify the test sequence (see page 17).

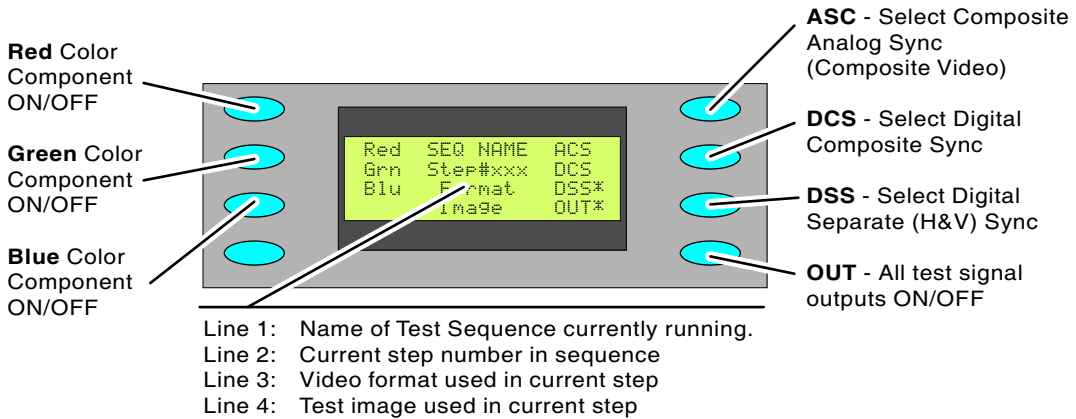

Using Test Sequences

Running Test Sequence in Burn-In Mode

Select Test > Burn-In > Run to automatically cycle through the test sequence. When the Burn-In mode is stopped, you can use the menu buttons to gate video color information, change sync types, and turn all signal outputs on and off.

NOTE: The Burn-In mode disables the Power-Save feature, if enabled.

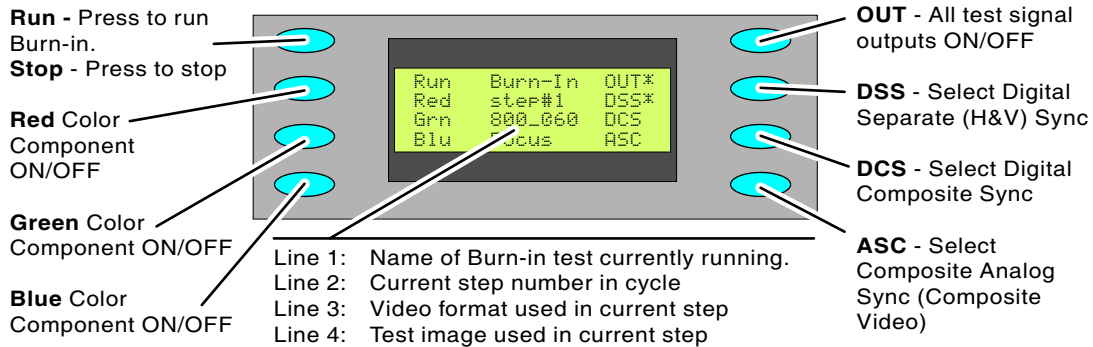

Creating Test Sequence for DDC Displays

If the generator is connected to a VESA DCC-compliant display, press the Learn Monitor, and then Test > DDC Step to setup a test of each format supported by the display.

Press the + button to render the current image with each video format supported by the display.

Press the - button to render all images at the current format.

Select the Run option to automatically test all images for each video format.

When using automatic mode, select Stop to use manual mode.

Special Tests

Using Generator with CS-1 Probe

The Test > CS1 Probe option uses the Quantum Data CS-1 color sensor to measure the chromaticity and luminance (brightness) of a display. The CS-1 probe connects to the generator's serial port. Chromaticity is shown as x,y C.I.E. coordinates and the luminance (Y) can be shown either in units of foot-Lamberts or nits. The CS-1 needs to be over a fully lit white area of the display for accurate readings. The Flat_Whit test image is suitable for use with the CS-1

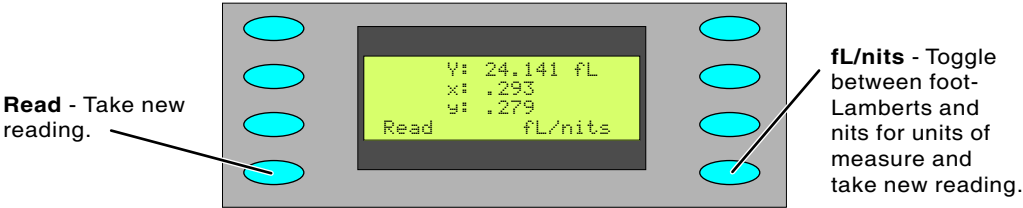

Error codes: 1, 7 - CS-1 not seeing a usable test image.
5, 8 - Generator did not find a CS-1 probe.
2, 3, 6 - Probe malfunctioning.

Testing Audio

Select Test > Audio to independently toggle stereo audio output channels on and off.

On a 701 generator, the left channel is also the monophonic audio source for the modulated RF output.

Testing HDCP Interfaces

Model 701 video test generators may be equipped with an optional production (private) key for testing High-bandwidth Digital Content Protection (HDCP) interfaces of DVI receivers that support HDCP. For more information about HDCP, see <http://www.digital-cp.com/>.

To output HDCP-encrypted video content:

1. Connect the DVI connector of the generator with the DVI connector of the device under test.

Special Tests

2. Choose a DVI video format supported by the device.
3. Press Test > HDCP > Start to output HDCP encrypted content.

The display on the generator indicates if the test passed or failed. If the test passed, the currently selected pattern is displayed on the device under test. Noise is displayed if the HDCP authentication failed.

After the initial authentication of the connection is established, the generator displays the number of authentication verification cycles until you stop the test.

During the test, if you reconnect the cable or restart the device under test, the test should restart automatically.

4. To stop the test, press the Exit soft key or any gray key.

Generating Pseudo Random Noise

When the generator is connected to a device that supports the Quantum Data pseudo random noise standard, press Test > PR Noise to output the noise pattern as a static image. Depending on how the device is designed, it may compare the pattern output by the generator with an identical pattern, created internally, to detect errors in the cable and in the device itself.

Using Video Generator Manager

About VGM

Video Generator Manager (VGM) is a Windows-based application for creating and editing formats and test sequences. As many as 132 formats and one test sequence can be stored in the generator.

VGM was originally created for use with Quantum Data 80x video generators. The 700-Series generators support only some VGM features. For information about using VGM, see the VGM help file.



VGM Quick Tour

1. Connect the generator to your computer using a null modem serial cable.

Note: You may not be able to connect to the generator when it is Power Save mode.

2. Start VGM, and then select Generator > Connect.
3. In the Select Port dialog box, select the Serial option, and then click OK.

The name of the connected generator is listed in the bottom half of the VGM window.

4. Click the View Formats icon  to view the formats available in the generator, and then double-click the format you want the generator to use.
5. Click the  Image List icon to view the available images, and then double-click the image you want the generator to use.

Creating Video Formats

Editing Video Formats

You can use VGM to create your own video formats. You can start with a default format in the VGM format editor, or copy an existing format.

To create a video format:

1. Connect the generator with VGM, and then double-click the generator name.
2. Click the View Formats icon to list the available formats.
3. Right-click a format that is similar to the format you want to create, then select Copy to create a copy of the format. The name of the new format is based on the original format, followed by an underscore and number.
4. Right-click the copied format, select Edit, and then click Yes to open the Format Editor.
5. Specify the format parameters.

The format editor works as described in the VGM help file, except that the physical size entries have no affect on how test images are displayed on the 700 series. However, the integer portion of the horizontal size in millimeters specifies the storage location of the format in the generator. Unlike our other models, the 70x generators store formats by specific numeric locations, and not by name. If you do not change this number, the edited format will replace the previous version of the format when you upload it back to the generator. You will not get any warnings that you are about to overwrite a memory location.

6. Select File > Save to save the format on your PC, and then close the Format Editor window.
7. In the VGM data pane, select the format, and click the Send Data icon  to store the format on the generator.

Modifying Test Sequence

Editing the Test Sequence

The generator has a default sequence, which you can edit in VGM. One sequence can be stored in the generator at the same time.

To modify the test sequence:

1. Connect the generator with VGM, and then double-click the generator name.
2. In the generator window, click the Sequence List icon  to display the sequence name.
3. Right-click the sequence name, and then select Edit to open the Sequence Editor.
4. Select the 70x generator from the Generator list. Do not select the virtual generator.
5. Modify the test sequence.

VGM help describes the basic operation of the Sequence editor. Specify only a format and image for each step. Do not use the *No Change* value. The 700-Series generators do not support the output gating and sync options, and the *No Change* value.

6. Select Edit > Edit Sequence Name to save the sequence as a new sequence file.
7. Select File > Save to save the sequence on your PC, and then close the Sequence Editor.
8. In the top half of the main VGM window, select the sequence, then click the Send Data icon  to store the sequence on the generator.

To run the test sequence, see page 12.

Pattern Descriptions

Flat_Wht/(R,G,B)

Description - Fills the screen with white, blue (B), green (G) or red (R).

Application - Use to test chrominance.

Grid

Description - White crosshatch on a black background. The lines form square boxes. A single pixel dot is located in the center of each crosshatch box.

Application - Use the Grid pattern to test convergence. To accurately produce an image on a color monitor, the three electron beams in the CRT must meet (converge) at the same location at the same time. Lines displayed on a misconverged monitor appear as several multi-colored lines, and the transitions between different colored areas contain fringes of other colors.

Rev_Grid

Description - Black crosshatch drawn on a white background. The lines form square boxes.

Application - Use to test convergence. To accurately produce an image on a color monitor, the three electron beams in the CRT must meet (converge) at the same location at the same time. Lines displayed on a misconverged monitor appear as several multi-colored lines, and the transitions between different colored areas contain fringes of other colors.

Overscan

Description - The image has three parts. The first part consists of five white circles. A large circle is drawn in the center of the screen. Its diameter equals the lesser of the video height or width of the display. A circle also is drawn in each of the corners of the screen. The diameter of the corner circles equals one-fifth of the display width.

The second part of the image consists of a white crosshatch. The number of boxes in the crosshatch depends on the physical size of the display.

The last part of the image consists of white tic marks on the horizontal and vertical center lines of the image. The marks are one pixel thick. Every other mark is slightly longer. The color of the pattern can be changed with the individual video output controls.

Application - Used for detecting non-uniformity and non-linearity. The image presents an undistorted display, the horizontal and vertical sweeps of the electron beam across the face of the CRT should be at uniform speeds. Any non-uniformity in the sweep causes portions of an image to stretch while other portions are compressed. Non-linearity in a monitor shows up in several ways. It may be present across the entire screen, in a large portion of the screen, or localized in a very small area.

Pattern Descriptions

Raster

Description - Black display (nothing being displayed).

Application - Useful for centering the raster on a CRT. Many monitor applications require that the displayed image or text fit completely within a bezel that surrounds the CRT. This usually requires that you first center the blank raster on the face of the CRT, and then center the image within the raster.

Cutoff

Description - The entire active video area is filled with a shade of gray.

Application - Useful for testing chrominance and contrast.

Window

Description - Single white box in the center of active video. The size of the box is one-third the width and height of the active video area.

Application - Use for brightness control adjustment.

Focus

Description - This image fills the screen with white M characters.

Application - Used for testing focus.

ColorBar

Description - The image has 7 full-height vertical color bars.

Application - Useful for verifying that none of the video channels are bad or connected incorrectly.

GrayBar

Description - The image has 16 full-height vertical graybars. The intensity of the bars increases from left to right. All bars are untinted gray at all levels.

Application - Useful for testing brightness control adjustment and brightness uniformity tests.

Pattern Descriptions

Regulate

Description - The image has a pair of white outlined boxes which surround a blinking solid white box.

Application - Tests for proper high voltage regulation.

Checker

Description - The image's active video area is equally divided into a 6x6 checkerboard of black and white boxes.

Application - The pattern is based on a proposed ANSI method of measuring the contrast ratio of video projection systems.

Dot_12

Description - The image's active video area is filled with multiple rows of white, single pixel dots. The dots define the corners of what would appear to be square boxes if all connecting pixels were lit. The number of rows of boxes and the number of boxes per row depends on which version of the image is selected and the screen aspect ratio of the currently-loaded format.

Application - Used to measure convergence. To accurately produce an image on a color monitor, the three electron beams in the CRT must meet (converge) at the same location at the same time. Small dots displayed on a misconverged monitor appear as a group of multi-colored dots.

SMPTEBar

Description - The image's upper 67% of the image consists of a series of color bars. These bars match the order of the bars in the SMPTE and EIA patterns.

The left side of the lower 25% of the image contains isolated -I and Q color difference signals that match the original EIA and SMPTE patterns. The -I signal appears as a bluish-gray bar and the Q signal appears as a purple bar on a TV monitor. The bars are separated by a white (+100 IRE) bar. After the Q blocks there are four blocks: black, (black - 4 IRE), black, (black + 4IRE).

The right side of the lower 25% of the image contains a narrow 12.5 IRE gray bar.

Application - Designed for adjusting the color settings of a television monitor by eye. It can also be used with a TV waveform analyzer and vectorscope for testing video signal processors and color decoders.

Pattern Descriptions

Ramp

Description - This image provides an active video area starting from full black (+7.5 IRE for NTSC) at one edge of the screen to full white (+100 IRE) at or near the opposite end of the screen.

Application - Useful for testing pixel anomalies and chrominance.

PulseBar

Description - The image looks like two vertical lines followed by a wide vertical bar on a display's screen. The first line is a red pulse. The pulse is 20 T for PAL and 12.5 T for NTSC formats. The second narrower line is a 2 T white sine-squared pulse. T = 100 nSec for PAL and 125 nSec for NTSC formats. The wide bar is white with sine-squared edges.

Application - This image is intended for TV formats, but can be displayed with any format up to 100 MHz.

Burst

Description - The left side starts with reference white and black levels. This is followed by six bursts of square waves. Each burst is at a different frequency, forming vertical lines of various widths. The frequencies, going from left to right, are 0.5, 1, 1.53, 2.04, 3.06 and 6.13MHz.

Application - The image can also be used with a TV waveform analyzer to check the frequency response of a video system. One scan line of the image, as it would appear on a waveform analyzer. High frequency roll-off (loss) would show up as a decrease in the peak-to-peak swings on the right side of the waveform. Low frequency roll-off would show up as a decrease in the peak-to-peak swings on the left side of the waveform.

Updating Firmware

Updating Firmware

The generator's operating system firmware is stored in Flash EPROM, which you can update via the serial port.

Firmware updates are available from <http://www.quantumdata.com/support/downloads/>.

To install a firmware update:

1. Turn off generator, and connect it to your PC using a null modem serial cable.
2. Hold down the upper-right menu button, and then press the On/Off button. The LCD screen will indicate that the generator is ready for the upload.

Pressing the upper-right button during startup sets the serial port at 19200 bps. To set the serial port at 9600 bps, press the upper-left button while turning on the generator.

3. If necessary, expand the .zip archive file that contains the firmware update.
4. If you have HyperTerminal, double-click the HyperTerminal setup file (QD70x Upgrade.ht) to start HyperTerminal with the proper communications setup (9600 bps, 8 data bits, no parity, 1 stop bit, Xon/Xoff flow control).

Note: You may not be able to connect to the generator when it is in Power Save mode.

If you are using a COM port other than COM1, choose File > Properties to select the desired COM port.

HyperTerminal Private Edition is recommended when using Windows 2000 to install firmware.

5. In HyperTerminal, select Transfer > Send Text File.
6. In the Send Text File dialog box, double-click the firmware filename to start the transfer.
The generator will display the progress of the update, which takes several minutes, and then restart to complete the installation. If you need to cancel the installation, select Exit.
7. If the firmware update includes new or revised video formats, press Options > Clear Fmts, and then select Yes to delete the current formats. Then press Options > Reload Fmts to load the new formats.

Specifications

Video Formats

Storage: 132 total
Press Signal Type button to view signal types.
Edit method: Windows-based VGM software

Test Images (Patterns)

Press Image button to list images.

Horizontal Timing

Frequency: 1 KHz to 250 KHz
Total pixels: 144 to 4096
Active range: 16 to 4096 pixels

Vertical Timing

Frequency: 1 Hz to 650 Hz
Active lines: 1 to 4096
Scan types: Progressive, 2:1 Interlace

Sync Types

Separate digital horizontal and vertical
Digital and analog composite
Bipolar HDTV

Video Outputs

Timing accuracy: 2%
Connectors: See diagram on page 3.

RF Output (701 only)

Channels: Channels 2, 3, 4, and 6 (VHF) per NTSC (M) and PAL (G).
Video: Color per NTSC (M) and PAL (G)
Audio: Mono 1 KHz tone per NTSC (M) and PAL (G)
Connector: Female F type

Digital Video (701 only)

Pixel rate: Single link 75 MHz

Audio Outputs

Connector: 3.5 mm stereo phone jack
Signals: Left: 1 KHz tone
Right: 2 KHz tone

User Interface

Display: 4 x 20 character backlit LCD
Buttons: 9 function buttons, 8 menu buttons, 2 paging buttons

Computer Interface

Type: RS-232, 9 pin D-sub
Protocol: 9600 baud, 8-N-1, Xon/Xoff

VESA EDID/DDC Support

Reads a monitor's EDID data through DVI connector, and shows list of supported standard formats. DDC test mode for cycling through supported standard formats.

Battery Power Operation

Type: Six AA 1500 mA-H rated rechargeable NiMH batteries (included)
Use time: 8 hours with fully charged NiMH batteries. Less when using backlight, DVI, NTSC, or RF features.

AC Power Operation

Type: External charger/power supply supplied with unit
Input: 100-240 VAC @ 47-63 Hz
Output: 12V

Size and Weight

Size: H 5.5 x W 8.25 x D 2 inches
H 140 x W 210 x D 51 mm
Ship weight: 4 lbs, including batteries

Service and Support Contacts

To contact Technical Support, see <http://www.quantumdata.com/contact/support.asp>.

For factory-authorized service centers, see <http://www.quantumdata.com/contact/locations.asp>.



Model 700, 701 Quick Start Guide 68-00198-D (12-Dec-2004)

Copyright © 2006 by Quantum Data, Inc. All rights reserved.

The information contained in this document is provided for use by our customers and may not be incorporated into other products or publications without the expressed written consent of Quantum Data. Information furnished by Quantum Data is believed to be accurate and reliable. However, no responsibility is assumed by Quantum Data for its use.

Quantum Data reserves the right to make changes at any time and without notice to its products to improve performance, reliability, manufacturing methods, and (or) marketability.

Documentation based on firmware version 1.6.0.

Declaration of Conformity

Manufacturer's Name: Quantum Data, Inc.
Manufacturer's Address: 2111 Big Timber Rd.
Elgin, IL 60123-1100; USA

The manufacturer hereby declares that the product:

Product Name: Video Test Generator
Model Numbers: 700, 701

conforms to the following standards or other normative documents:

CENLEC EN55022, RF Emissions: 1998

EN55022 Conducted Emissions, AC Mains (0.15-30 MHz) Class A
EN55022 RF Radiated Emissions (30-1000 MHz) Class A

CENLEC EN61326, Electrical Equipment for measurement, control and laboratory use - EMC Requirements: 1997

Complies with Sections Listed Above

89/336/EEC EMC Directive

Supplementary Information

The external power supply and power cord supplied with the unit are required for electromagnetic compatibility.

Use of premium quality shielded cables is required for electromagnetic compatibility.

When and Where Issued
07-September-2001
Romeoville, IL; USA

Marks of Compliance



**ANYONE INVOLVED WITH DESIGNING,
BUILDING, INSTALLING, TESTING OR
REPAIRING VIDEO DISPLAYS OR VIDEO
PROJECTORS SHOULD FIND OUT WHAT
QUANTUM DATA VIDEO TEST EQUIPMENT
AND SOFTWARE HAS TO OFFER**

About Quantum Data

Quantum Data products are used, sold, and supported throughout the world. Since its founding Quantum Data has been at the leading edge of programmable video generator technology. Our equipment is the benchmark reference tool for today's leading video display manufacturers and system developers, as well as the standard for use in many video testing servicing environments.

To learn more about Quantum Data products,
visit us at www.quantumdata.com



2111 Big Timber Road, Elgin, IL 60123-1100
Phone: (847)888-0450 • Fax: (847)888-2802
sales@quantumdata.com
www.quantumdata.com

68-00199

