

SDL1000X Series

Programmable DC Electronic Load

User Manual

E02A



Copyright and Statement

Copyright

SIGLENT TECHNOLOGIES CO., LTD. All rights reserved.

Trademark Information

SIGLENT is registered trademark of SIGLENT TECHNOLOGIES CO., LTD.

Statement

- **SIGLENT** products are protected by patent laws in and outside of the P.R. China.
- **SIGLENT** reserves the right to change the specifications and price.
- Information in this publication replaces all previous corresponding published material.
- Contents in this manual are not allowed to be copied, extracted or translated in any form or by any means without **SIGLENT**'s permission.

General Safety Summary

Please review the following safety precautions carefully to avoid personal injury or damage to this product or any product connected to it. To prevent potential danger, please use the instrument as specified.

Use the proper power cord

Only use the power cord designed for use with the instrument and authorized for use with in the local country of interest.

Power supply

AC Input Voltages: 110 V/220 V \pm 10%, 50/60Hz.

Use proper fuse

The fuse types: 110 V/220 V: T315 mA/250 V

Make sure to use the correct type of fuse before turning on the instrument.

Do not connect the power cord before replacing the fuse.

Find and fix the root cause of fuse damage before replacing the fuse.

Ground the instrument

The instrument is grounded through the protective terra/Earth conductor of the power cord. To avoid electric shock, the grounding conductor must be connected to the earth. Make sure that the instrument is properly grounded before activating any inputs or outputs.

Observe all terminal ratings

To avoid fire or electric shock, please observe all ratings and symbols on the instrument. Read this guide carefully to know more details about the ratings before connection.

Keep proper ventilation

Inadequate ventilation may cause an increase of the internal temperature of the instrument, which can lead to damage. Please keep proper ventilation and check the fan and air-vents regularly when using the instrument.

Operating conditions

Location: Indoor, no direct sunlight, minimal interference and pollution

Relative humidity: < 80%

Altitude: < 2000 m

Temperature: 0 ° C to 40 ° C

Electrostatic Prevention

Operate in an area that minimizes the potential for electrostatic discharge .
Always ground both the internal and external conductors of cables to release static before connecting.

Do not operate in an explosive atmosphere

To avoid personal injury or damage to instrument, please do not operate in an explosive atmosphere.

Keep surface of the product clean and dry

Please keep the surface of the product clean and dry.

Safety Terms and Symbols

Important terms that may appear on the product and in this manual:

DANGER: Indicates direct injury or hazard that may happen.

WARNING: Indicates potential injury or hazard that may happen.

CAUTION: Indicates potential damage to the instrument or other property that may happen.

Symbols that may appear on the product:



Hazardous
Voltage



Protective
Earth Terminal



Warning



Earth
Ground



Power
Switch

SDL1000X Brief Introduction

The SDL1000X series Programmable DC Electronic Load has a 3.5 inch TFT-LCD display, a user-friendly interface and superb performance specifications. Two versions are available: The SDL1020X features an input range of 150 V/30 A with a total power of 200 W. The SDL1030X has an input range of with a total power of 300 W. All models have measurement resolutions of 0.1 mV/0.1 mA, Adjustable current rise time of 0.001 A/ μ s ~ 2.5 A/ μ s, and built-in RS232/USB/LAN communication interfaces. The SDL1000X also has a standard SCPI communication protocol that can be used with a computer to create fully automatic testing platforms. The SDL is ideally suited for Power, battery, LED, automotive electronics, and aerospace applications.



Main features of the SDL1000X

- SDL1020X (Single channel): DC 150 V/30 A, total power up to 200 W
- SDL1030X (Single channel): DC 150 V/30 A, total power up to 300 W
- 4 static modes / Dynamic mode: CC/CV/CR/CP
- CC Dynamic mode: Continuous, pulsed, toggled
- CC Dynamic mode: 25 kHz, CP Dynamic mode: 12.5 kHz, CV Dynamic mode: 0.5 Hz
- Adjustable current rising speed: 0.001 A/us ~ 2.5 A/us
- Min. readback resolution: 0.1 mV, 0.1 mA
- Measuring speed of voltage and current: Up to 500 kHz

- 100 step list function
- Over-current protection, over-power protection , battery, short circuit and CR-LED test functions
- 4-wire SENSE compensation mode
- External voltage and current control function
- Voltage and current monitoring via 0-10 V analog output
- 3.5 inch TFT-LCD display, capable of displaying multiple parameters and states simultaneously
- Built-in RS232/USB/LAN communication interface , USB-GPIB module (optional)
- With memory function in case of power-down
- OCP, OVP, OPP, OTP and LRV protections
- Wave form graphing
- Voltage based rise/fall function
- V_{on} and V_{latch} function
- Smart fan control to minimize noise
- Remote control and measurement on PC

Content

Copyright and Statement	I
General Safety Summary	II
Safety Terms and Symbols	IV
SDL1000X Brief Introduction	V
Chapter 1 Start Guide	1
General Inspection	2
The Front Panel	3
The Rear Panel	6
Connect power	8
User interface	10
Fuse Replacement	13
Chapter 2 Function and Features	14
Local/Remote Operation Mode	15
Local Operation Mode	15
Remote Operation Mode	15
Static Operation Mode	16
Constant Current (CC) Mode	16
Constant Voltage (CV) Mode	18
Constant Resistance (CR) Mode	21
Constant Power (CP) Mode	23
Dynamic test function	25
Continuous mode	26
Pulse mode	29
Toggle mode	32
OCPT Test Function	35
OPPT Test Function	39
Battery Test Function	43
List Test Function	47
Auto Test Function	51
LED Test Function	55
Waveform Display Function	58
Restore	60
Function of Terminals on the Rear Panel	64
Sense mode	64
External trigger function	65
Voltage fault function	66
Current and voltage monitor	66
Short-circuit monitor	67
Protection Functions	67

Overvoltage protection (OVP)	67
Overcurrent protection (OCP)	68
Overpower protection (OPP)	68
Over-temperature Protection (OTP)	69
Input Reverse Polarity Protection (RPP)	69
Chapter 3 System Utility Function	70
System	70
1.System info	71
2.Interface	72
2.Sound	76
3.Language	77
4.Factory Setting	77
5.Upgrade	78
6.BoardTest	78
Config	80
Turn ON/OFF the Sense Function	80
Turn ON/OFF SOF Function	80
Break-Over Volatge	80
Turn ON/OFF Von-Latch Function	80
Set Trigger	81
Set Aver	81
Set EXTC(External Interface)	82
SLMT	87
Limit	88
I_Protect	88
P_Protect	89
Troubleshooting	91
Contact SIGLENT	92

Chapter 1 Start Guide

In this chapter, we introduce the front panel and display interface of the SDL1000X, and also tips for how to check and operate the digital load for the first time.

The main content of Chapter 1 includes:

- General Inspection
- The front panel
- The rear panel
- Connecting power
- User interface
- Output Inspection
- Fuse Replacement

General Inspection

Please check the instrument according to the following steps.

1. Inspect the shipping container.

Keep the shipping container or cushioning material until the contents of the shipment have been completely checked and the instrument has passed both electrical and mechanical tests.

The consigner or carrier will be responsible for damage to the instrument resulting from shipment. **SIGLENT** will not provide free maintenance or replacement.

2. Inspect the instrument.

If there are instrument is found damaged, defective or has failed any electrical or mechanical tests, please contact **SIGLENT**.

3. Check the accessories.

Please check the accessories according to the packing list. If the accessories are incomplete or damaged, please contact **SIGLENT**.

The Front Panel

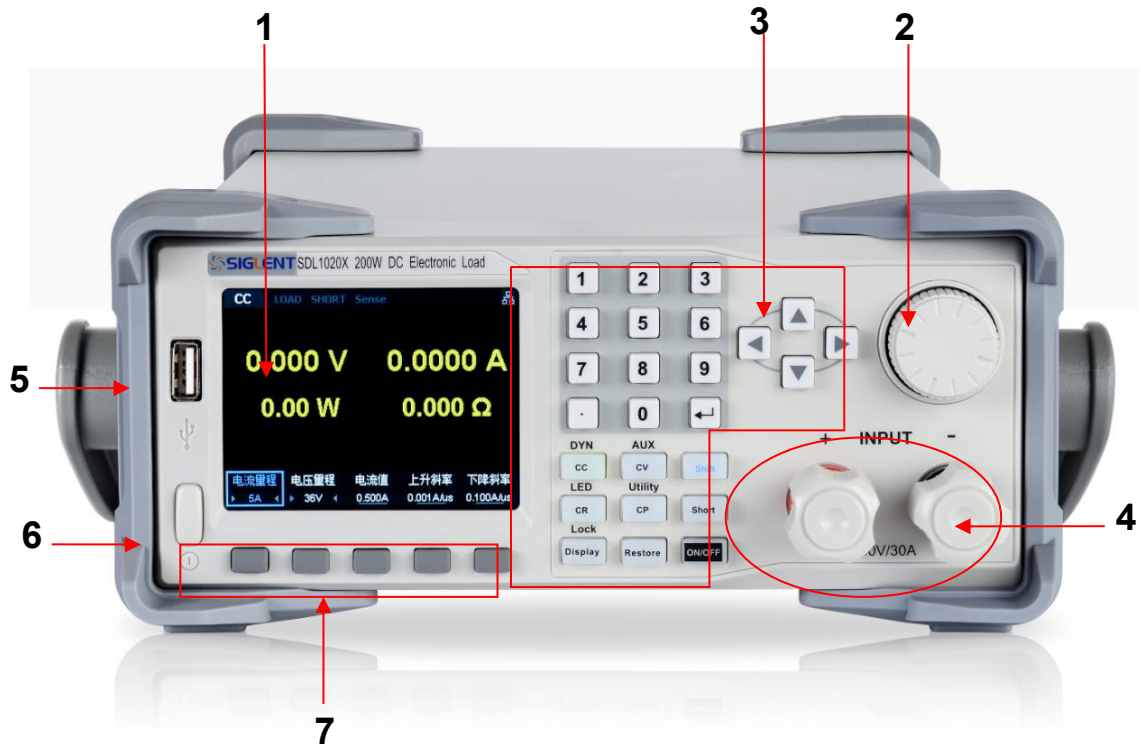

Figure1: The front panel of the SDL1000X

1. LCD

The load has a 3.5 inch TFT-LCD display which can display system parameter settings, system output state, wave forms, menu options, prompt messages, etc.

2. Knob

When setting parameters, rotate the knob to increase or decrease the value of the digit at the cursor. When browsing setting objects (such as of the buzzer state, sense, voltage and current protection, store or read files and switch modes, etc.), rotating the knob can quickly move the cursor or switch options. Pressing down the knob selects/enters the parameter.

3. Function button and power key



Press down the button to enter the constant current mode.

Enter one of the dynamic modes (DYN mode) by pressing the shift button at the same time.



Press down the button to enter constant voltage (CV) mode.

Enter auxillary (AUX) mode by pressing the shift button at the same time.



Press down the button to enter the constant power (CP)

mode. Enter Utility mode by pressing the shift button at the same time.



Press down the button to enter the constant resistance (CR)

mode. Enter LED mode by pressing the shift button at the same time

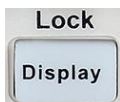

Press down the button to enter the Display mode. Enable the

key lock function by pressing the shift button at the same time.



Press down the button to enter the Restore function



Press down the shift button to access the alternate button functions like Lock or LED as shown above.

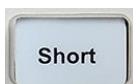

Press down the button to enter the Short function.

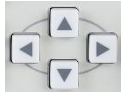

The right, left, up, and down arrow buttons move the on-screen cursor to select the setting parameter.

0~9 Input the number zero to nine using the keypad.



Dot/Period



Enter



Softkey functions are define by the adjacent on-screen label

4. Input Terminal

Physical input connections to the external circuit and voltage.

5. USB interface

Interface that can be insert USB device and support FAT32 file system format.

6. Power key

Turn on or off the instrument.

7. Function key

Used to choose different functions.

The Rear Panel

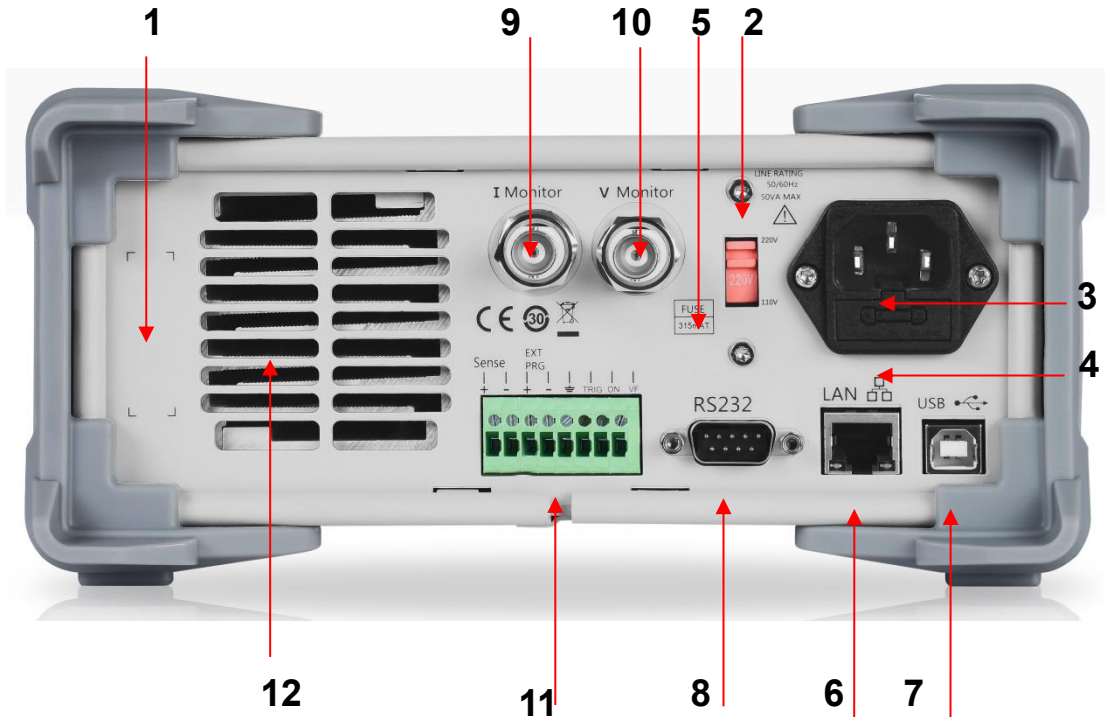

Figure 2: The rear panel of the SDL1000X

1. Warning message

Warnings about grounding the instrument and other important information.

2. AC input voltage description

The frequency and voltage of the AC power supply must match the specification of the fuse.

3. AC power socket

The power plug socket for AC input power.

4. Fuse

The specified fuse must be rated for the input voltage (Please refer to the “ **AC** input voltage description”)

5. AC line power selection switch

AC Input Voltage: 110/220 V

6. LAN interface

Connect to the local network (LAN) using a standard RJ45 interface.

7. USB device

Connect the instrument (as a controlled device) to an external computer/controller via USB.

8. RS232 interface

Connect to the computer via 9-pin RS232 cable.

9. Current detection terminal

Observe the current input to the SDL by connecting the current detection terminal to a measurement instrument (oscilloscope, DMM) to analyze the change of input current with respect to time.

10. Voltage detection terminal

Observe the voltage input to the SDL by connecting the voltage detection terminal to a measurement instrument (oscilloscope, DMM) to analyze the change of input voltage with respect to time.

11. Sense terminal, External control terminal, PWM output terminal



Select different ports to realize its function

12. FAN

Connect power

The SDL1000X supports a variety of AC line power input values. For each line voltage, the rear panel voltage selector settings are different, as shown in table 1 below.

Table 1: AC input line power specifications

AC power input	Voltage selector configure
110 VAC \pm 10%, 50 ~ 60 Hz	 110V
220 VAC \pm 10%, 50 ~ 60 Hz	 220V

Please connect the power carefully follow the steps below:

1. Check the input power

Make sure that the AC line power to be connected to the instrument and meets the requirements in Table 1.

2. Check the voltage selector at the rear panel

Make sure that the voltage selector setting at the rear panel of the instrument matches the actual input voltage.

3. Check the fuse

The specified fuse is installed when the instrument leaves factory. Please check whether the fuse matches the actual input voltage according to the "Input Power Requirements" at the rear panel of the instrument.

4. Connect the power

Connect the instrument to AC power supply using the power cord

provided in the accessories. Then press the button  to turn on the electronic load.

 **WARNING**

Before turning the instrument on, please disconnect the power supply and set the voltage selector to the appropriate value.

 **WARNING**

To avoid electric shock, make sure that the instrument is correctly grounded.

User interface

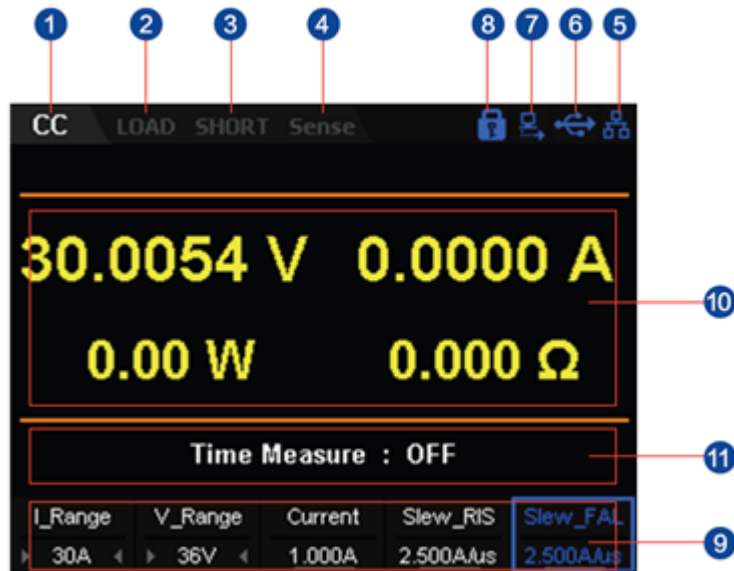

Figure 3: The user interface of the SDL1000X

1. Channel output mode
2. Channel output state
3. Short state
4. Remote sense mode
5. LAN connection icon
6. USB connection icon
7. Remote mode
8. Keyboard lock

9. Setting value

10. Measured output values

11. Voltage rise and fall time

To Power on the instrument

After the instrument is connected to the power source, press the Power key at the left bottom of the front panel to power on the instrument. When the instrument is turned on, it will undergo a self-test. If the instrument passes the self-test, the welcome interface is displayed. If the instrument fails, the self-test failure information will be displayed. If you encounter any problems or failures, please contact your nearest SIGLENT support office.



CAUTION

Ensure that the AC selector setting on the rear panel of the instrument matches the actual AC input voltage, otherwise, the electronic load could be damaged.



CAUTION

Please pay attention to the positive and negative polarities of the electronic load to avoid incorrect connections. Otherwise, the load can be damaged.

Fuse Replacement

The specifications of the fuse are relative to the actual input line voltage shown in the table below. You also can refer to the rear panel “input power requirement”.

Input voltage	Fuse specification
110 VAC	T315mA
220 VAC	T315mA

To replace the fuse, please follow the steps below:

1. Turn off the instrument and remove the power cord.
2. Insert a small straight screwdriver into the slot at the power socket and gently pry out the fuse seat.

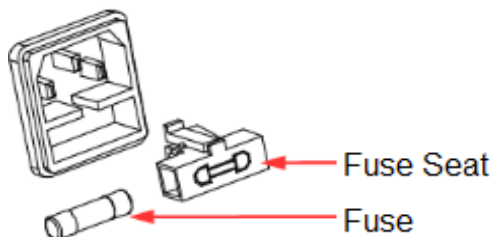

3. Adjust the power voltage selector manually to select the correct voltage scale.
4. Take out the fuse and replace it with the specified fuse (for the corresponding relations between the input voltage and fuse specification, refer to the “input power requirement” at the rear panel).
5. Re-insert the fuse holder into the power socket (please pay attention to the direction).



WARNING

To avoid personal injuries, unplug the power supply before replacing the fuse. To avoid electric shock or fire, select the proper power supply specification and replace only with the proper fuse.

Chapter 2 Function and Features

Contents in this chapter:

- Local/Remote Operation Mode
- Static Operation Mode
- Transient Test Function
- OCPT Test Function
- OPPT Test Function
- Auto Test Function
- LED Test Function
- Waveform Display Function
- Store and Recall
- Rear Panel Terminal functions
- Short monitor function
- Protective function

Local/Remote Operation Mode

The load provides two operation modes: Local and remote.

Local Operation Mode

After you power on the instrument, it enters the local operation mode by default. In the local operation mode, all the keys on the front panel are available for you to use.

Remote Operation Mode

In the remote operation mode, you can send programming commands from a controller (computer) via any one of the interfaces (GPIB, USB, RS232, or LAN). In remote operation mode, all the keys (except the **Shift** key plus the **Display** key) will be disabled. This is known as “local lock out”. When locked, the instrument front panel is disabled and the load can only be controlled via programming commands. To return to the local operation mode, press the **Shift** key plus the **Display** key on the front panel.

Static Operation Mode

The static operation modes include the following 4 modes:

- Constant Current (CC) Mode
- Constant Voltage (CV) Mode
- Constant Resistance (CR) Mode
- Constant Power (CP) Mode

Constant Current (CC) Mode

In CC mode, the electronic load will sink a current in accordance with the programmed value regardless of the input voltage, as shown in Figure 2-1.

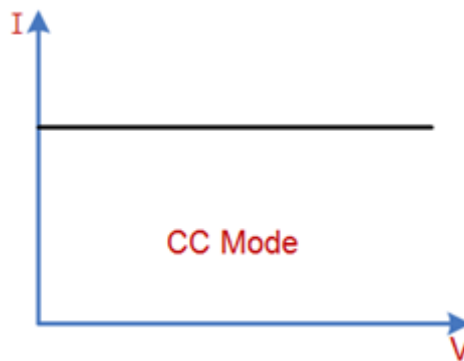

Constant Current Mode

Figure 2-1 Voltage-Current Relationship Schema under CC Mode

Operating Steps

1. Turn off the instrument, as shown in Figure 2-2, connect the DUT and the channel input terminals on the front panel of the load.

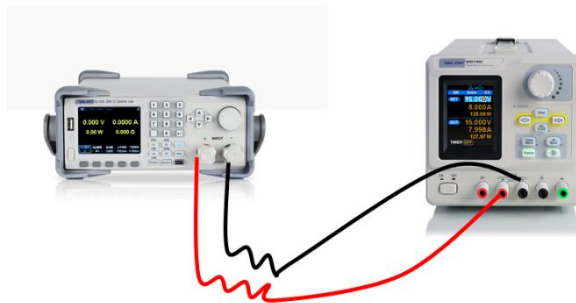
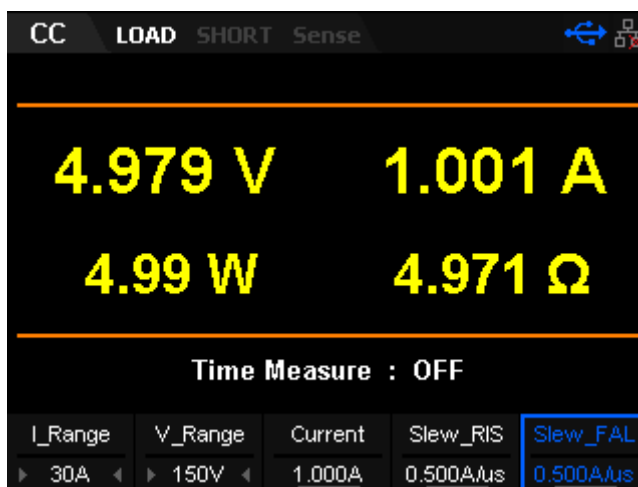

Figure 2-2

**CAUTION**

While making a connection, the positive polarity of the load should be connected to the (+) terminal of the channel output, and the negative polarity of the load to the (-) terminal of the channel output. Incorrect polarity may cause damage to the instrument or the DUT.

- Press **CC** to enter the main interface of CC mode, as shown in Figure 2-3.



3.

Figure 2-3 CC Mode Main Interface

- Set CC mode current range (5 A or 30 A) and voltage mode (36 V or 150 V)

Note: The lower ranges provide better resolution and accuracy at low current settings.

- Set the current input value. This is the amount of current that the load will attempt to draw when the output is enabled.
- Set the rising slew rate and the falling slew rate in CC mode. The default unit for the slew rate is A/us.
- Press On/Off to turn on the channel input. At this time, the actual input voltage, current, resistance and power will be displayed on the main interface.

Note: The load will begin to sink current only if the input voltage is greater than the conduction voltage of the system (default value is 0 V).

**Warning**

To avoid electric shock, ensure that the DUT is connected to the input terminals of the load properly before you turn on the channel input.

8. Press the **Display** key to enter the waveform display interface, as shown in Figure 2-4. By default, the current waveform is displayed. When the input voltage changes, the load will sink a constant current.

Press the **Display** key again to exit the waveform display interface and return to the main interface of CC mode.

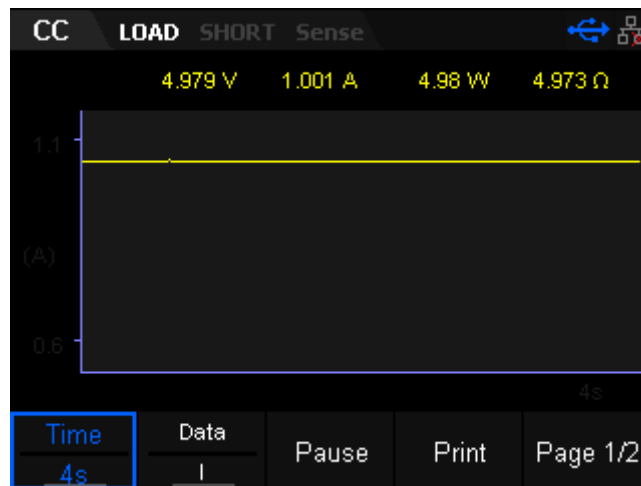
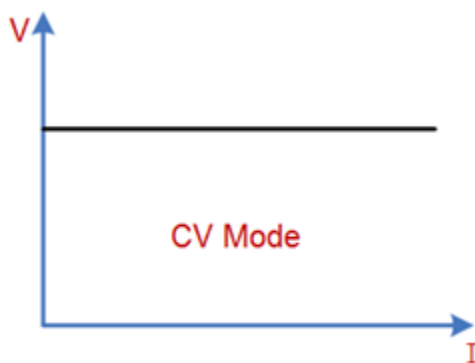

Figure 2-4 Waveform display interface of CC Mode

Constant Voltage (CV) Mode

In CV mode, the electronic load will sink enough current to maintain the input voltage at the setpoint, as shown in Figure 2-5.



Constant voltage mode

Figure 2-5 Voltage-Current Relationship Schema under CV Mode

Operating Steps

1. Turn off the instrument, as shown in Figure 2-2, connect the DUT and the channel input terminals on the front panel of the load.

**CAUTION**

While making a connection, the positive polarity of the load should be connected to the (+) terminal of the channel output, and the negative polarity of the load to the (-) terminal of the channel output. Incorrect polarity may cause damage to the instrument or the DUT.

2. Press **[CV]** to enter the main interface of CV mode, as shown in Figure 2-6.



Figure 2-6 CV Mode Main Interface

3. Set CV mode current range (5 A or 30 A) and voltage range (36 V

or 150 V)

Note: The low range provides better resolution and accuracy at low voltage settings.

4. Set voltage
5. Press On/Off to turn on the channel input. At this time, the actual input voltage, current, resistance and power will be displayed on the main interface.

Note: The load will sink current only if the input voltage is larger than the conduction voltage of the system (default value is 0 V).



Warning

To avoid electric shock, ensure that the DUT is connected to the input terminals of the load properly before you turn on the channel input.

6. Press the **Display** key to enter the waveform display interface, as shown in Figure 2-7. By default, the voltage waveform is displayed. When the input current changes, the load will apply a constant voltage. Press the **Display** key again to exit the waveform display interface and return to the main interface of CV mode.

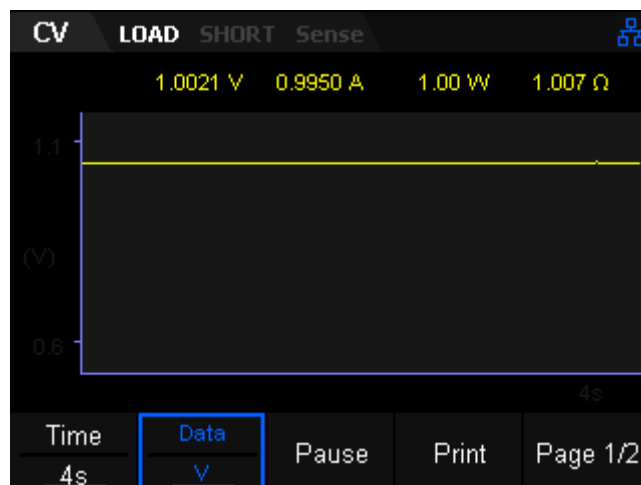
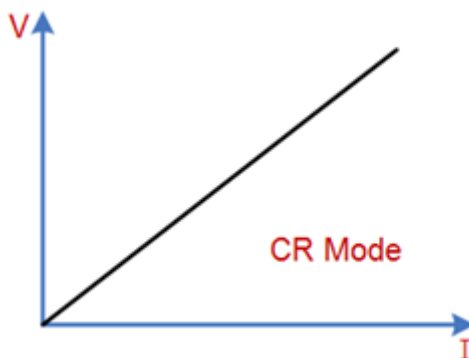

Figure 2-7 Waveform display interface of CV Mode

Constant Resistance (CR) Mode

In CR mode, the electronic load is regarded as a constant resistance and will give linear change of current with respect to input voltage changes, as shown in Figure 2-8.



Constant resistance mode

Figure 2-8 Voltage-Current Relationship Schema under CR Mode

Operating Steps

1. Turn off the instrument, as shown in Figure 2-2, connect the DUT and the channel input terminals on the front panel of the load.



CAUTION

While making a connection, the positive polarity of the load should be connected to the (+) terminal of the channel output, and the negative polarity of the load to the (-) terminal of the channel output. Incorrect polarity may cause damage to the instrument or the DUT.

2. Press **CR** to enter the main interface of CR mode, as shown in Figure 2-9.

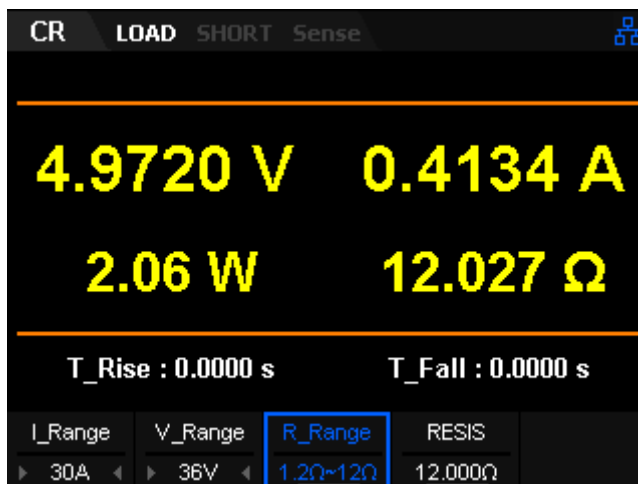

Figure 2-9 Main Interface of CR Mode

3. Set CR mode current range (5 A or 30 A), voltage range (36 V or 150 V) and resistance range (Low/Middle/High/Upper).

Note: The low range provides better resolution and accuracy at low resistance settings.

4. Set the target resistance value
5. Press On/Off to turn on the channel input. At this time, the actual input voltage, current, resistance and power will be displayed on the main interface.

Note: The load will begin to sink current only if the input voltage is greater than the conduction voltage of the system (default value is 0 V)



Warning

To avoid electrical shock, ensure that the DUT is connected to the input terminals of the load properly before you turn on the channel input.

6. Press the **Display** key to enter the waveform display interface, as shown in Figure 2-10. By default, the resistance waveform is displayed. When the input voltage changes, the load current will linearly change. Press the **Display** key again to exit the waveform display interface and return to the main interface of CR mode.

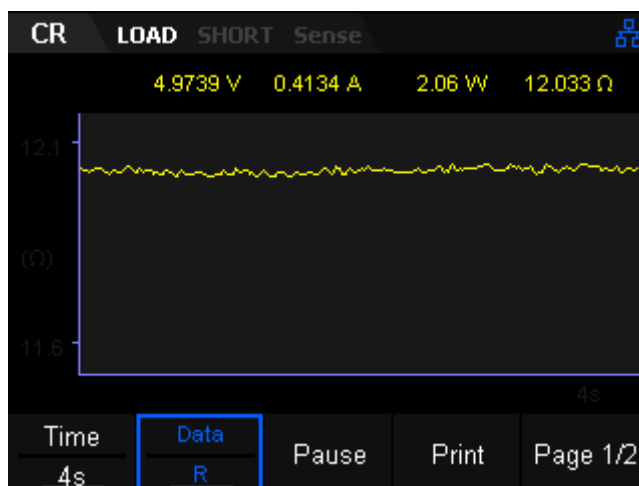
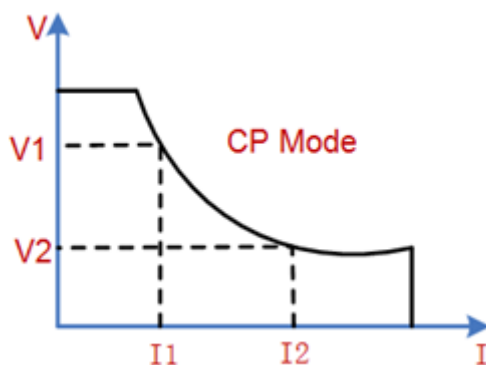

Figure 2-10 Waveform display interface of CR Mode

Constant Power (CP) Mode

In CP mode, the electronic load will sink a constant power. If the input voltage rises, the input current draw will be decreased to maintain a constant power sink following the equation ($P= V \cdot I$), as shown in Figure 2-11.



Constant power mode

Figure 2-11 Voltage-Current Relationship Schema under CP Mode

Operating Steps

1. Turn off the instrument, as shown in Figure 2-2, connect the DUT and the channel input terminals on the front panel of the load.



CAUTION

While making a connection, the positive polarity of the load should be connected to the (+) terminal of the channel output, and the negative polarity of the load to the (-) terminal of the channel output. Incorrect polarity may cause damage to the instrument or the DUT.

2. Press **CP** to enter the main interface of CP mode, as shown in Figure 2-12.

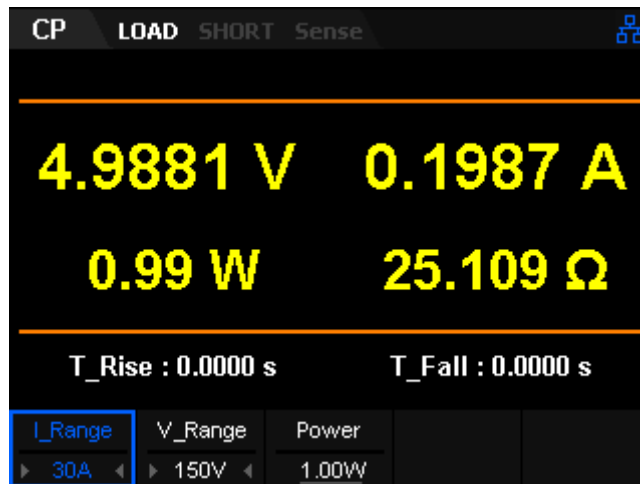

Figure 2-12 CP Mode Main Interface

3. Set CP mode current range (5 A or 30 A) and voltage range (36 V or 150 V).
4. Set power value.
5. Press On/Off to turn on the channel input. At this time, the actual input voltage, current, resistance and power will be displayed on the main interface.

Note: The load begin to sink power only if the input voltage is greater than the conduction voltage of the system (default value is 0 V)



Warning

To avoid electric shock, ensure that the DUT is connected to the input terminals of the load properly before you turn on the channel input.

6. Press the **Display** key to enter the waveform display interface, as shown in Figure 2-13. By default, the power waveform is displayed. When the input voltage changes, the load will sink a constant power. Press the **Display** key again to exit the waveform

display interface and return to the main interface of CP mode.

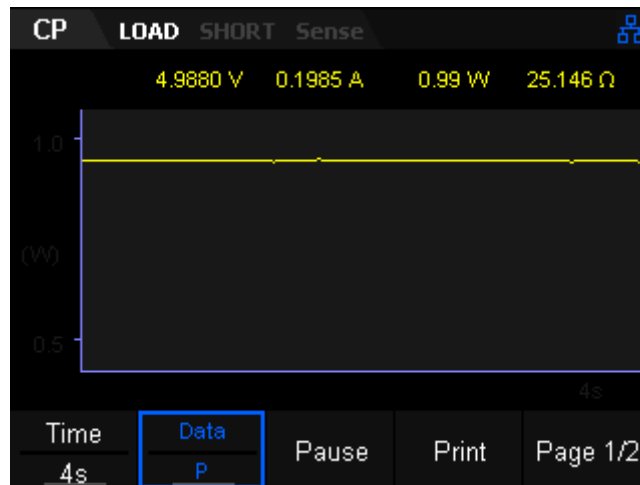

Figure 2-13 Waveform display interface of CP Mode

Dynamic test function

In dynamic test operation, the electronic load can be switched between two parameters based on the set values. This can be useful when testing the dynamic performance of a power supply or source. Press Shift + CC key on the front panel to enter the dynamic test interface.

Before testing, it is important to configure the load set points: A value, B value, pulse width time, frequency, duty ratio, etc. The rise and fall slew rates are also important settings for dynamic testing.

Dynamic test supports three modes:

- ◆ Continuous
- ◆ Pulse
- ◆ Toggle

Continuous mode

In continuous operation, when you enable the dynamic test operation, the load will continuously switch between Level A and Level B, as shown in Figure 2-14.

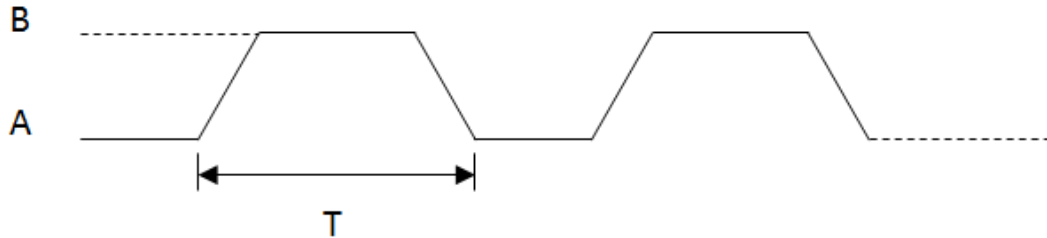

Figure 2-14 Transient CC Continuous Mode (Cont)

Take CC mode as example (other modes function in a similar fashion)
Operating Steps

1. Connect device

Power on instruments Connect the DUT and the channel input terminals of the electronic load, as shown in Figure 2-2.

2. Set running parameters

Press the **Shift** + **CC** key on the front panel to enter transient test operation. Continuous mode (CC) requires setting the proper slew rates for all Level steps, as shown in 2-15, 2-16, 2-17.

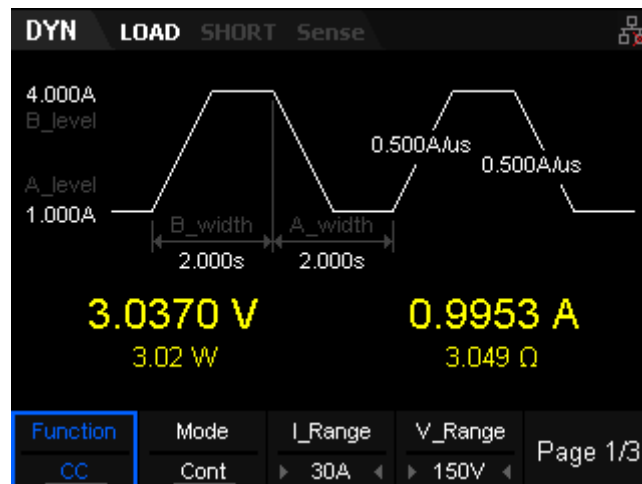

Figure 2-15 CC Cont mode page 1

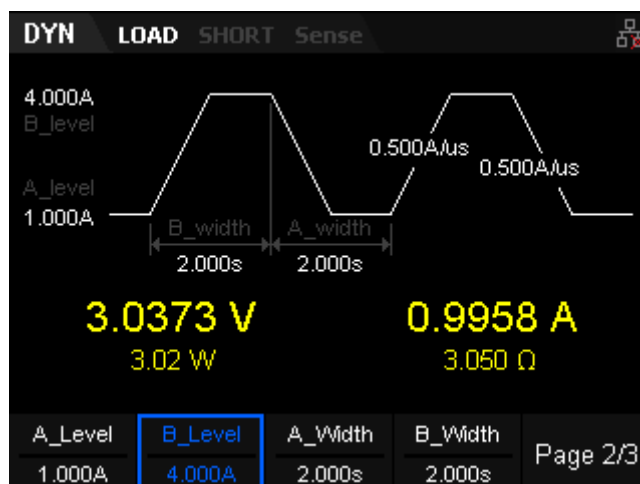

Figure 2-16 CC Cont mode page 2

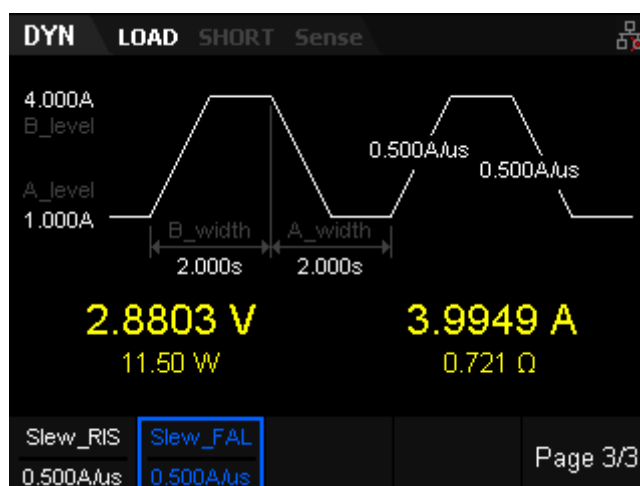

Figure 2-17 CC Cont mode page 3

The parameters for the continuous operation mode include Function, Mode, range, A_Level, B_Level, rising slew rate, falling slew rate, A_width, B_width and trigger selection. The interface menu can be divided into three pages.

Set range

Current range: 5 A or 30 A

Voltage range: 36 V or 150 V

Set A_level

The sink current toggles between a high value and a low value in continuous mode. The A_Level indicates a low value. The default unit for A_Level is Ampere (A).

Set B_level

The sink current toggles between a high value and a low value in continuous mode. The B_Level indicates a high value. The default unit for B_Level is Ampere (A).

Set width

A_width/B_width: The time during which the sink current stays at Level A. Default units are s or ms and the setting range is 0.020 ms ~ 999 s.

Slew_RIS and Slew_FAL

Slew_RIS and Slew_FAL: The set rate of change to a new level from the current value. Its unit is A/us and setting range is 0.001 ~ 2.5 A/us.

3. Enable trigger

Press **Shift** + **CP** key to enter the Utility interface. After pressing the “Config” key, the trigger source can be set in page 2 of the selection menu which includes Manual/Ext/Bus. Manual displays a trigger softkey on page 3 of the Dynamic test. Pressing this key will trigger the step. Ext sets the trigger type to external, which looks for a valid trigger on the rear panel Ext Trig input. Bus is a trigger sent over the remote control bus. See “Set trigger” in Section 3 for more details. Press **On/Off** to turn on the channel input. At this time, the actual input voltage, current, resistance and power will be displayed on the main interface. The sink current will toggle continuously between the set A level and B levels.

Tip:

The sink current may maintain a constant value in the main interface when the width is set to a very small value because the load is switching too quickly between A_level and B_level set points. Use the waveform display function to see the waveform more clearly.

4. View waveform display

Press **Display** to enter waveform display interface, shown in figure 2-18. The waveform will display the current curve when “I” is selected in CC Cont mode. Press **Display** again to exit the waveform display interface and return to the main interface of CC Cont mode.

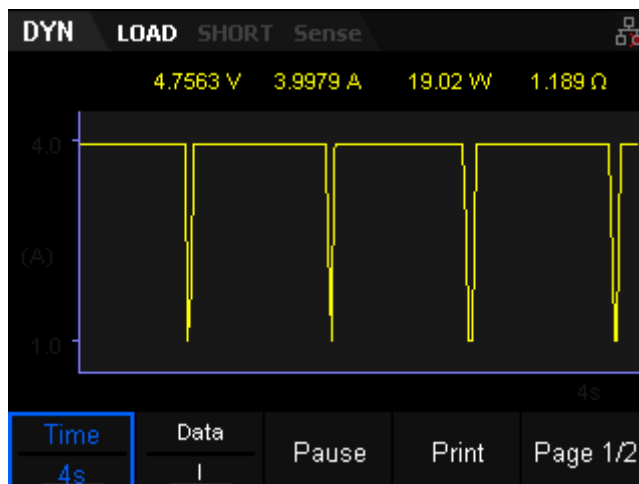

Figure 2-18 Waveform display interface of Cont mode

Pulse mode

Dynamic test operations using pulse mode configures the load to source the low value (Level A) until a valid trigger is received. At this time, the load settings will change to the B values. The settings will switch back to the A values after maintaining B for the set pulse width time, as shown in Figure 2-19.

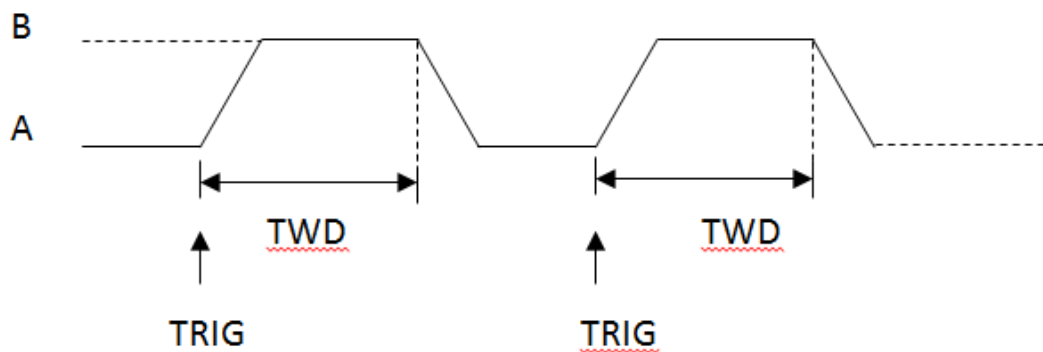

Figure 2-19 Transient CC Pulse Mode(Cont)

Take CC mode as example (other modes are similar)

Operating Steps

1. Connect device

Power on instruments Connect the DUT and the channel input terminals of the electronic load, as shown in Figure 2-2.

2. Set running parameters

Press the **Shift** + **CC** key on the front panel to enter transient test operation. CC continuous mode is not only the default mode but also

the only one mode that requires a set slew rate. Switch to pulse mode by pressing the “Mode” key, as shown in 2-20, 2-21, 2-22.

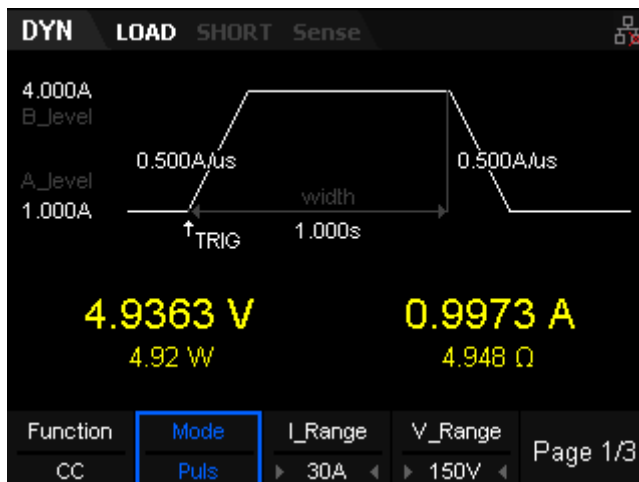

Figure 2-20 CC pulse mode page 1

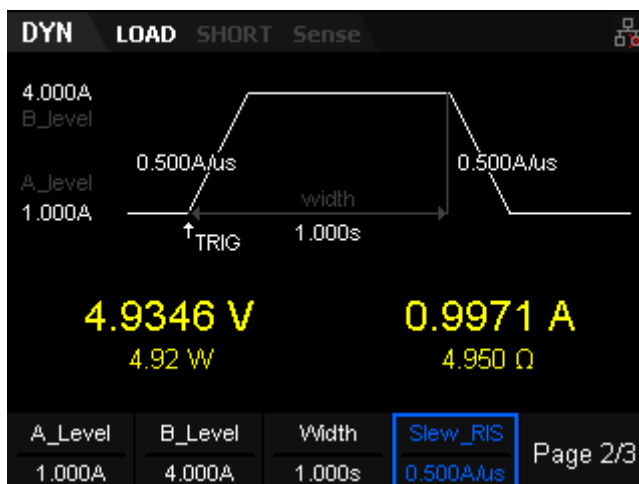

Figure 2-21 CC pulse mode page 2

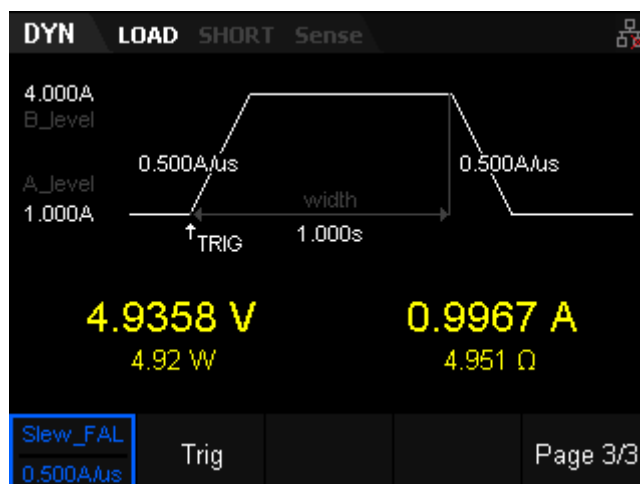

Figure 2-22 CC pulse mode page 3

The parameters for the pulse operation mode include Function, Mode, range, A_Level, B_Level, rising slew rate, falling slew rate, width and trigger selection. The interface menu can be divided into three pages.

Set range

Current range: 5 A or 30 A

Voltage range: 36 V or 150 V

Set A_level

The sink current toggles between a high value and a low value in Pulse mode. The A_Level is designated as the low value. The default unit for A_Level is Ampere (A).

Set B_level

The sink current toggles between a high value and a low value in Pulse mode. The B_Level is designated as the high value. The default unit for B_Level is Ampere (A).

Set width

Width: The time duration for the step to sink current Level B... Its unit is s or ms and setting range is 0.020 ms ~ 999 s.

Slew_RIS and Slew_FAIL

Slew_RIS and Slew_FAIL: The rate of change to a new level from the current sink value of the load. Slew units are A/us and setting range is 0.001 ~ 2.5 A/us.

3. Enable trigger

Press **Shift** + **CP** key to enter the Utility interface. After pressing the “Config” key, the trigger source can be set on page 2 of the menu. There are three trigger options available: Manual/Ext/Bus . Manual displays a trigger softkey on page 3 of the Dynamic test. Pressing this key will trigger the step. Ext sets the trigger type to external, which looks for a valid trigger on the rear panel Ext Trig input. Bus is a trigger sent over the remote control bus. See “Set trigger” in Section 3 for more details. Press **On/Off** to turn on the channel input. At this time, the actual input voltage, current, resistance and power will be displayed on the main interface. The sink current will continuously toggle between the A level and the B level.

Tip: The sink current may maintain a constant value in the main interface when the width is set to a very small value because the load is switching quickly between A_level and B_level. Users can use the waveform display function to see the waveform more clearly.

Toggle mode

Under Toggle mode (Tog), when you enable the dynamic test operation, the load will switch from the A value to the B value after receipt of a trigger signal. It will switch from B to A upon receipt of the next trigger signal, as shown in Figure 2-23.

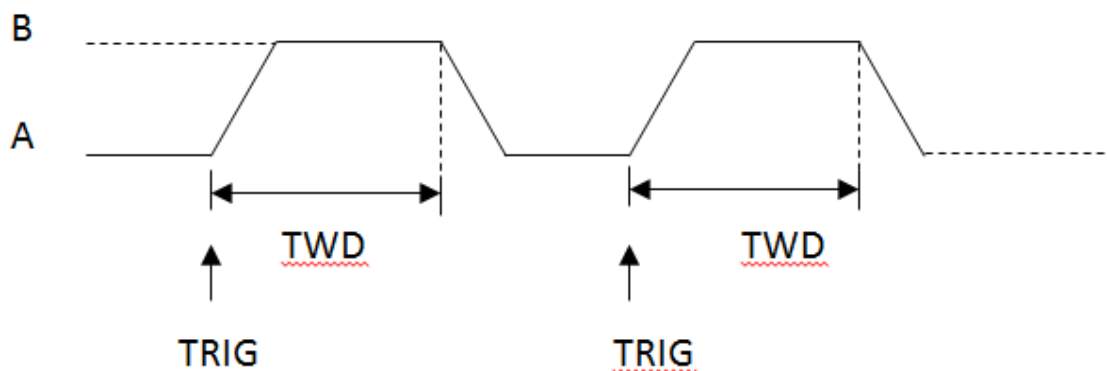

Figure 2-23 Transient CC Toggle Mode(Tog)

Take CC mode as example (other modes are similar)

Operating Steps

1. Connect device

Power on instruments Connect the DUT and the channel input terminals of the electronic load, as shown in Figure 2-2.

2. Set running parameters

Press the **Shift** + **CC** key on the front panel to enter transient test operation. CC continuous mode is not only the default mode but also the only one mode that requires setting the slew rate. Switch to Tog mode by press the “Mode” key, as shown in 2-24, 2-25, 2-26.

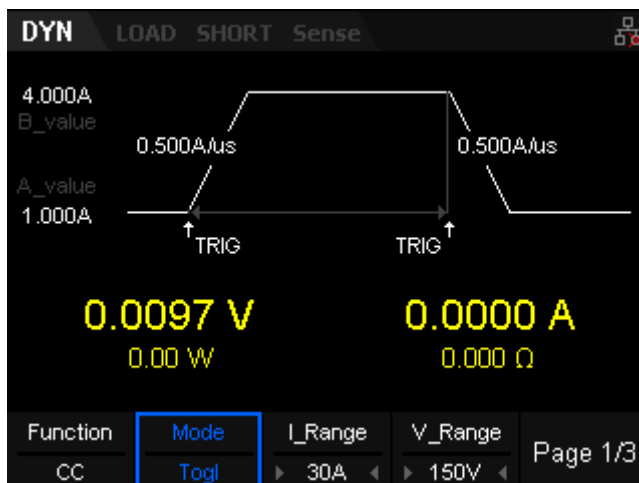

Figure 2-24 CC Tog mode page 1

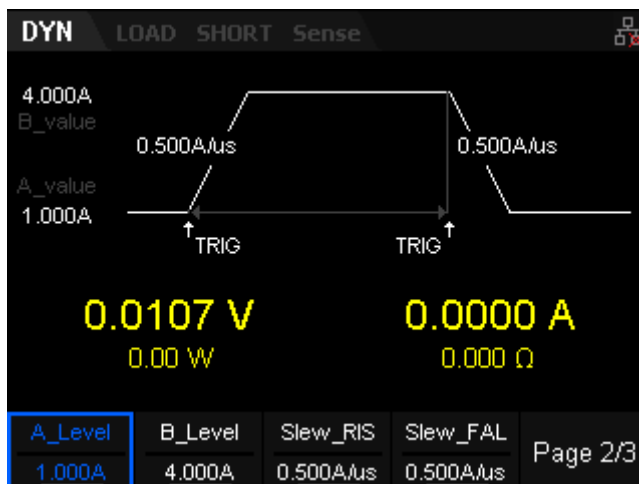

Figure 2-25 CC Tog mode page 2

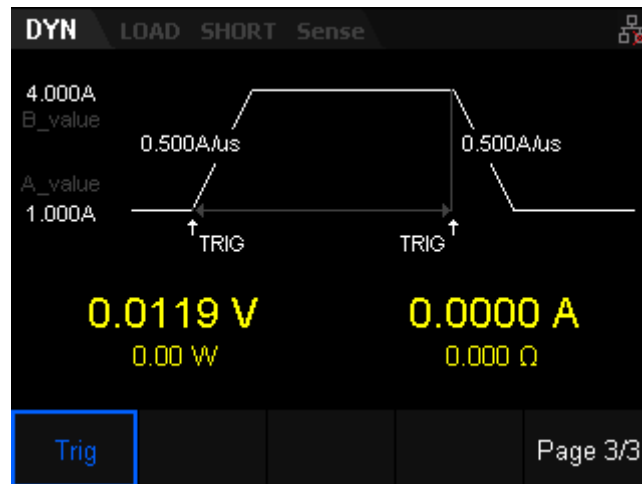

Figure 2-26 CC Tog mode page 3

The parameters for the pulse operation mode include Function, Mode, range, A_Level, B_Level, rising slew rate, falling slew rate and trigger selection. The interface menu can be divided into three pages.

Set range

Current range: 5 A or 30 A

Voltage range: 36 V or 150 V

Set A_level

The sink current toggles between a high value and a low value in Pul mode. A_Level indicates the low value. The default unit for A_Level is Ampere (A).

Set B_level

The sink current toggles between a high value and a low value in Pul mode. B_Level indicates the high value. The default unit for B_Level is Ampere (A).

Slew_RIS and Slew_FAIL

Slew_RIS and Slew_FAIL: The rate of change to a new level from the current sink value of the load. Its unit is A/us and the setting range is 0.001 ~ 2.5 A/us.

3. Enable trigger

Press **Shift** + **CP** key to enter Utility interface .After pressing “Config” key the trigger source can be set in page 2 of the menu. There are three trigger types:Manual/Ext/Bus. Manual displays a trigger softkey on

page 3 of the Dynamic test. Pressing this key will trigger the step. Ext sets the trigger type to external, which looks for a valid trigger on the rear panel Ext Trig input. Bus is a trigger sent over the remote control bus. See “Set trigger” in Section 3 for more details. Press **On/Off** to turn on the channel input. At this time, the actual input voltage, current, resistance and power will be displayed on the main interface.

OCPT Test Function

Overcurrent Protection Testing (OCPT) uses preset limits on current to halt a test. At the beginning of a test, the load measures the input voltage. If this value meets or exceeds the V_{on} setpoint (OCP_V), the load starts to sink the current after a period of delay time. The load then increments the sink current value using the user-defined step size (I_Step) and time interval (Delay). At each step, the load measures the input voltage and compares it to the protection voltage value (OCP_V). If the measured value is higher, it indicates that OCPT does not occur. If the load has not reached the maximum current set point (I_MAX), the sink current will increment again. The load proceeds to run and increases with regular steps until it reaches the set protection voltage value (OCP_V) or the end current (I_End). If the sink current of the load reaches the stop value at any time during the test, the load will halt the test automatically. The OCPT test fails, and the test ends. If lower, it indicates that OCPT does occur. Judge whether the current under test is within the set current range (I_MIN to I_MAX). If yes, the load passes the test. If no, the load fails the test.

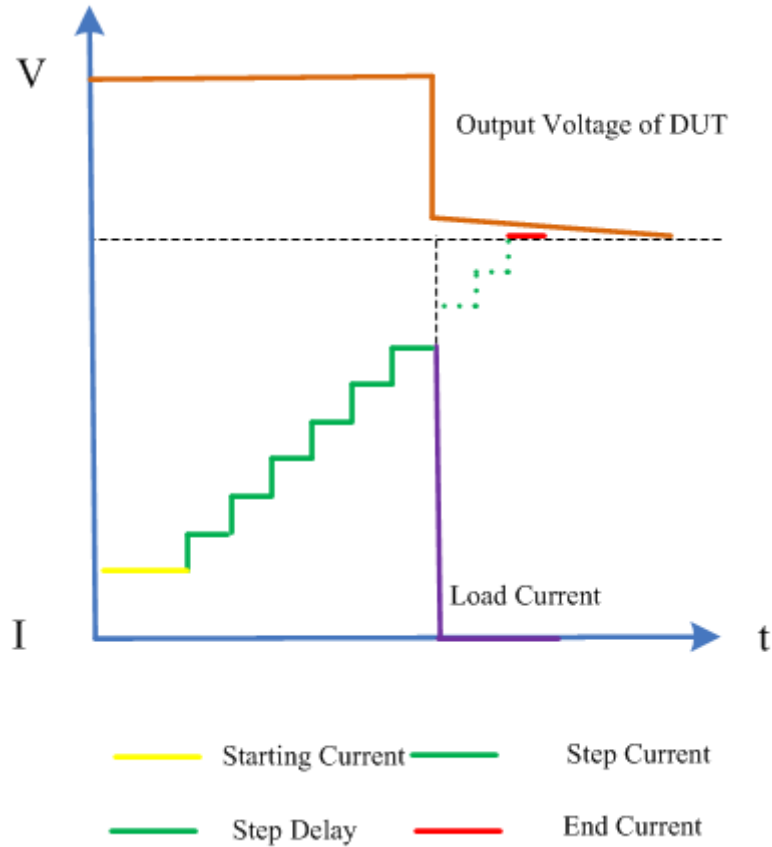

Figure 2-27 OCPT Test Function

Operating Steps

1. Connect device

Power on instruments and connect the DUT and the channel input terminals of the electronic load, as shown in Figure 2-2.

2. Set running parameters

Press the **Shift** + **CV** key on the front panel, select "OCPT" then enter OCPT test operation, as shown in 2-28, 2-29, 2-30.

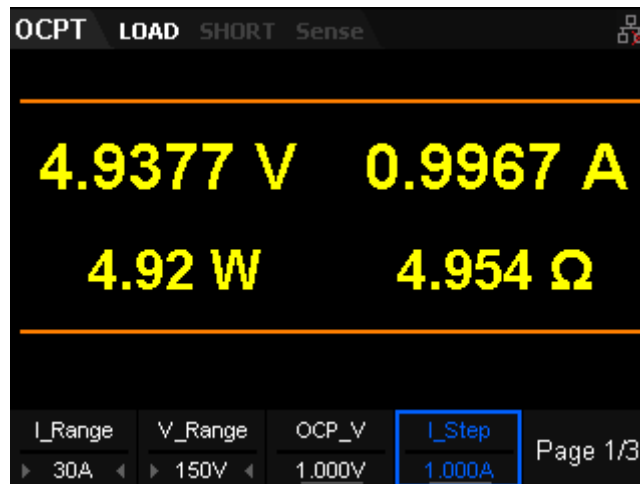

Figure 2-28 OCPT Test Function Page 1

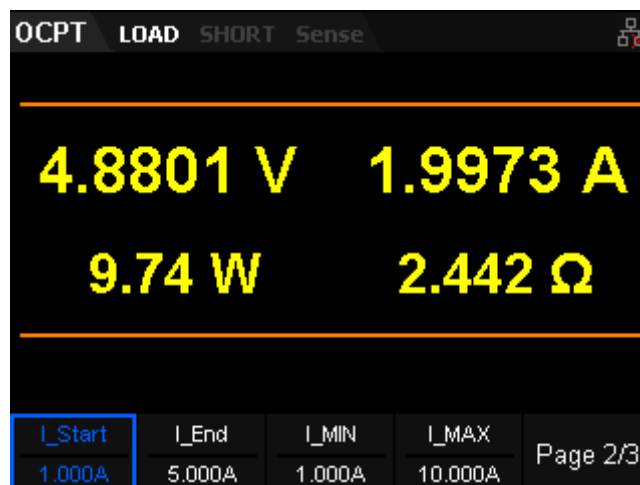

Figure 2-29 OCPT Test Function Page 2

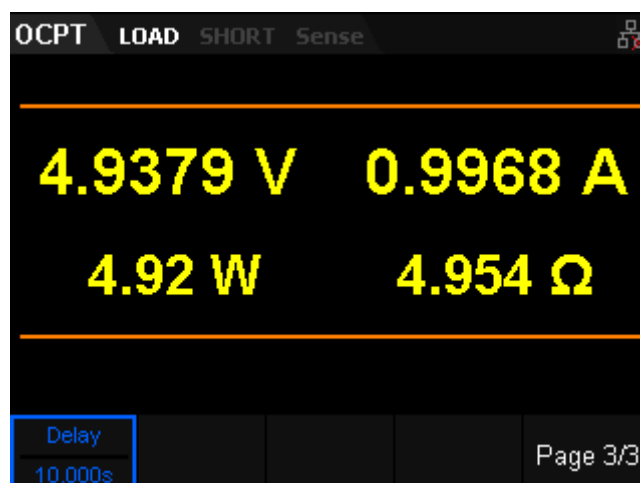

Figure 2-30 OCPT Test Function Page 3

The parameters for the OCPT test mode include range, OCP_V, I_Step, I_Start, I_End, I_MIN, I_MAX, Delay. The interface menu can be divided into three pages.

Set range

Current range: 5 A or 30 A

Voltage range: 36 V or 150 V

Set OCP_V

The protection voltage of the OCPT test function. The default unit for the value is V.

Set I_Step

The step current in OCPT test function. The default unit for I_Step is Ampere (A).

Set I_Start

The sink current when the load starts the OCPT test sequence. The default unit for I_Start is Ampere (A).

Set I_End

The sink current when the load stops the OCPT test sequence. The default unit for I_End is Ampere (A).

Set I_MIN

The minimum value of the protection current in OCPT test function. The default unit for I_End is Ampere (A).

Set I_MAX

The maximum value of the protection current in OCPT test sequence. The default unit for I_End is Ampere (A).

Set Delay

The time interval during which the current moves from step-to-step in the OCPT test sequence. The default unit for Delay is s.

3. Turn on the input channel

Press to turn on the channel input. At this time, the actual input voltage, current, resistance and power will be displayed on the main interface. If OCPT test pass, the interface of the load will pop-up a messagebox with the words "Test complete". Then load will disable its

output. If an OCPT test fails, the interface of the load will pop-up a messagebox such as “Below limit ,test fail”, “Over limit , Test fail”, etc. Then the input channel of the load will be closed automatically.

4. View waveform

Press **Display** key to enter the waveform display interface, as shown in figure 2-31. The sink current should have a stepped increase in the waveform when viewing current (I) data. . Press the **Display** key again to exit the waveform display interface and return to the main interface of OCPT test mode.

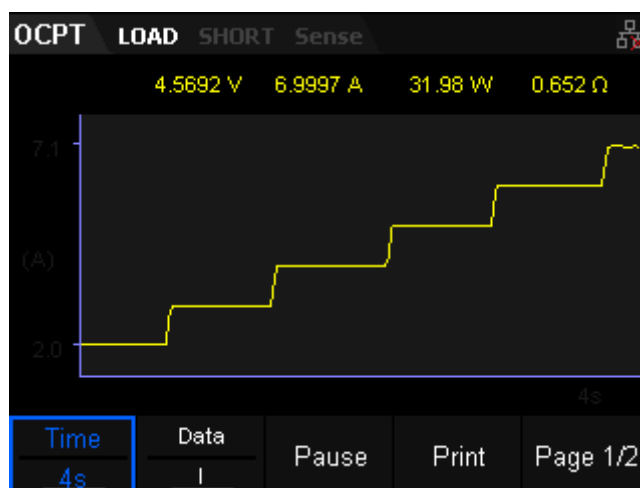

Figure 2-31 Waveform display interface of OCPT

OPPT Test Function

When the Over Power Protection Test (OPPT) test starts, if the input voltage is less than the V_{on} value, the load starts to work after a period of delay time according to the delay setting. The power increases with incrementing steps set by P_Step . At each step, the load input voltage is compared to the overpower protection voltage (OPP_V). If higher, it indicates that OPPT does not occur. The load proceeds to run and increases the sink power with regular steps until it reaches the protection voltage setting (OPP_V) or the last power setting (P_End). If the sink power of the load has reached the stop value (P_End), the load output will be closed automatically, the OPPT test fails, and the test ends. If lower, it indicates that OPPT does occur. If the measured power under test is within the set maximum (P_MAX) and minimum power range (P_MIN), the load passes the test. If not, the load fails the test.

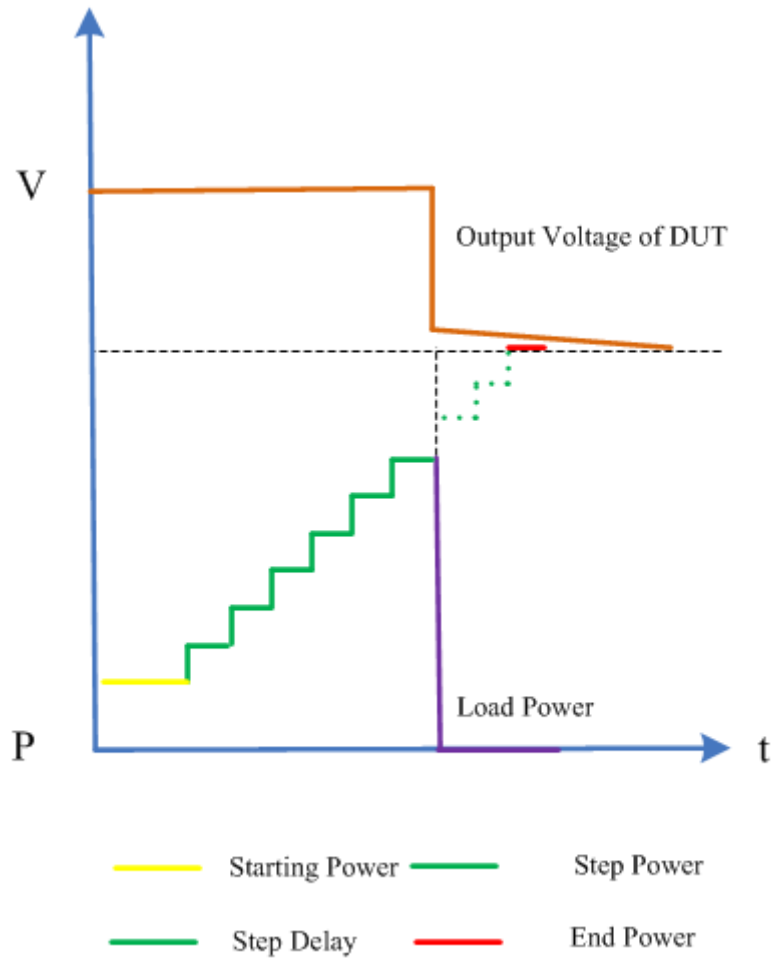

Figure 2-32 OPPT Test Function

Operating Steps

1. Connect device

Power on instruments and connect the DUT and the channel input terminals of the electronic load, as shown in Figure 2-2.

2. Set running parameters

Press the **Shift** + **CV** key on the front panel, select "OPPT" then enter OPPT test operation, as shown in 2-33, 2-34, 2-35.

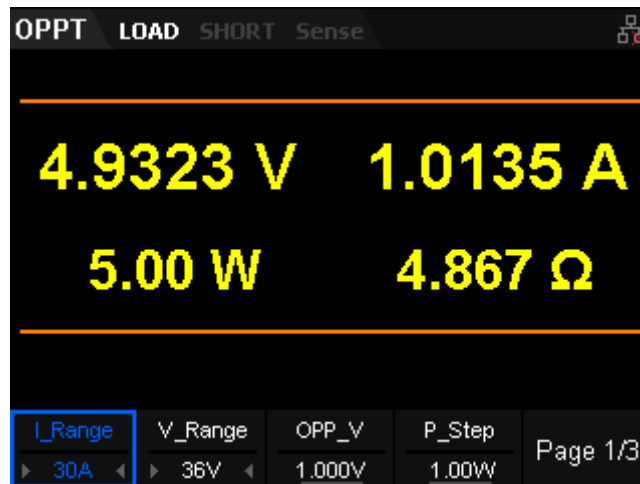

Figure 2-33 OPPT Test Function Page 1

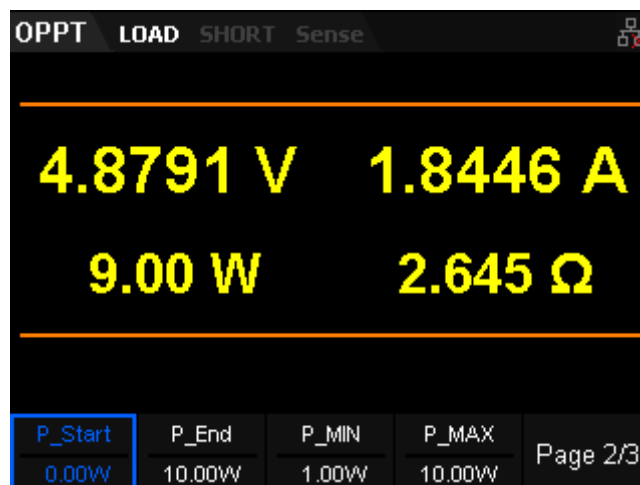

Figure 2-34 OPPT Test Function Page 2



Figure 2-35 OPPT Test Function Page 3

The parameters for the OPPT test mode include range, OPP_V, P_Step, P_Start, P_End, P_MIN, P_MAX, Delay.

The interface menu can be divided into three pages.

Set range

Current range: 5 A or 30 A

Voltage range: 36 V or 150 V

Set OPP_V

The protection voltage of the OPPT test function. The default unit for the value is Volts (V).

Set P_Step

The step power for the OPPT test function. The default unit for I_Step is Watts (W).

Set P_Start

The sink power when the load starts the OPPT test sequence. The default unit for P_Start is Watts (W).

Set P_End

The sink power when the load stops the OPPT test sequence. The default unit for P_End is Watts (W).

Set P_MIN

The minimum value of the protection power in the OPPT test function. The default unit for P_End is Watts (W).

Set P_MAX

The maximum value of the protection power in the OPPT test function. The default unit for I_End is Watts (W).

Set Delay

The time interval during which the power moves from step-to-step in OPPT test function. The default unit for Delay is seconds (s).

3. Turn on the input channel

Press to turn on the channel input. At this time, the actual input voltage, current, resistance and power will be displayed on the main interface. If the OPPT test results are a pass, the interface of the load

will pop-up a messagebox that states “Test complete”. Then the load will disable the output. If the OPPT test fails, the interface of the load will pop-up a messagebox such as “Below limit ,test fail”, “Over limit , Test fail”, etc. Then the input channel of the load will closed automatically.

4. View waveform

Press **Display** key to enter waveform display interface, as shown in figure 2-36. The sink power will have a stepped increase in the waveform after setting the Data selection to be power (“P”). Press the **Display** key again to exit the waveform display interface and return to the main interface of OPPT test mode.

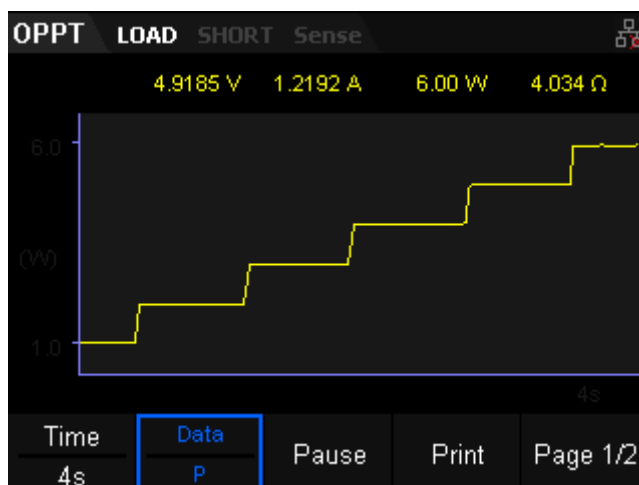

Figure 2-36 Waveform display interface of OPPT

Battery Test Function

The Battery test function can be used in CC, CP, or CR mode. The primary termination conditions for the Battery test function includes: cut-off voltage, cut-off capacity, and/or discharge time. When any one of the three conditions is met, the load immediately stops discharging. When only one or two condition(s) is/are selected as the termination condition(s) for the battery test, please set the unused termination conditions to the "OFF" state. The C-Add function can record accumulated capacity if you like.

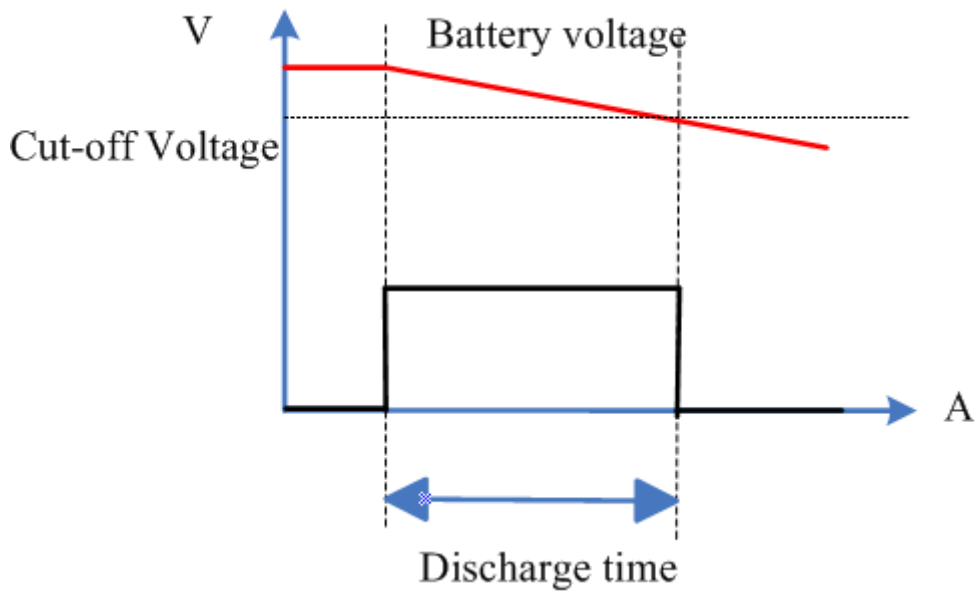

Figure 2-37 OPPT Test Function

The Battery test function reflects the reliability of the battery and the remaining battery life.

Take CC mode as example (other modes are similar)

Operating Steps

1. Connect device

Power on the instrument and connect the DUT and the channel input terminals of the electronic load, as shown in Figure 2-2.

2. Set running parameters

Press the **Shift** + **CV** key on the front panel, select "Battery" then enter the Battery test operation mode, as shown in 2-38, 2-39.

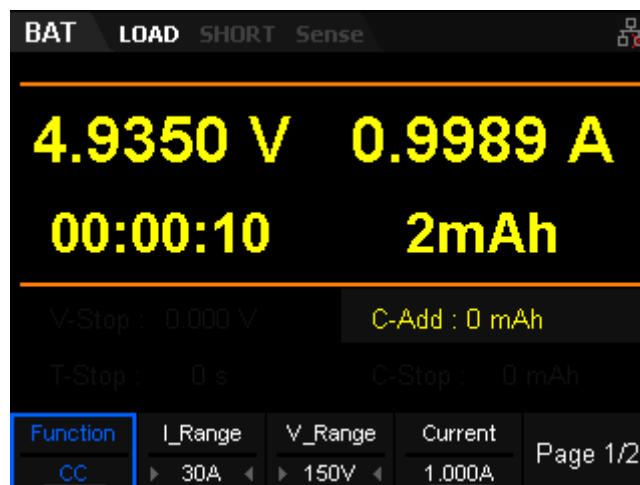

Figure 2-38 Battery Test Function Page 1



Figure 2-39 Battery Test Function Page 2

The parameters for the Battery test mode include Function, Range, Current, V_Stop, C_Stop, T_Stop . The interface menu can be divided into two pages.

Set Function

Choose CC, CR, or CP mode

Set range

Current range: 5 A or 30 A

Voltage range: 36 V or 150 V

Set current

The discharge current of the Battery test function. The default unit for the value is Ampere (A).

Set V_Stop

The cut-off voltage in the Battery test function . When the battery voltage reaches the cut-off voltage, the load stops discharging automatically. The default unit for V_Stop is Volts (V).

Set C_Stop

The cut-off discharge capacity in the Battery test function . When the accumulated capacity is greater than the cut-off capacity, the load

stops discharging automatically. The default unit for C_Stop is milliamp-hour (mAh).

Set T_Stop

The discharge time in the Battery test function. When the accumulated time is greater than the cut-off time, the load stops discharging automatically. The default unit for T_Stop is seconds (s).

3. Turn on the input channel

Press **On/Off** to turn on the channel input. At this time, the actual discharge voltage, current, time and capacity will be displayed on the main interface. If any of the termination conditions are met, the load will pop-up a messagebox stating "Battery test complete", which will disappear by pressing any key.

Note: Once the channel input is turned on, the load will not start to sink current until the input voltage is greater than the break-over voltage.

4. View waveform

Press the **Display** key to enter the waveform display interface, as shown in figure 2-40. By observing the CC waveform with the Data parameter set to current (I), you can see the load discharge with a constant current. Press the **Display** key again to exit the waveform display interface and return to the main interface of OPPT test mode.

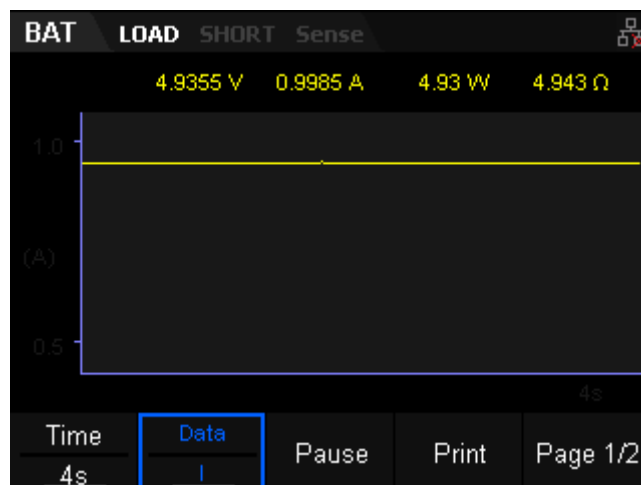

Figure 2-40 Waveform display interface of BAT

DCR Mode

DCR function, which can test the internal resistance of the battery.

Operating Steps

In the "Battery" testing interface, press the mode function key to select "DCR" and enter the DCR testing interface.

Set the time_1 and Time_2. Current_1 and Current_2. After set "ON", the test can be conducted. After two periods of operation, it will automatically stop and a prompt will pop up on the test completion screen.

The graph shown on the screen allows users to clearly understand the relationship between Time_1 and Time_2 and Current_1 and Current_2. The waveform in the graph does not change with the test result. The test result is updated in the 'DCR' item on the screen, and when the next test is performed, the last test result is updated to keep the 'LAST' value.

List Test Function

List test mode enables you to automatically test devices by creating and executing a sequence of test steps using a single function. For example, you could create a list test that contains 10 difference steps using the CC function, or a two step list using CV. You define each step limit, measurement ranges, dwell time, slew rate and trigger mode then save this specific sequence as a list. The external trigger mode can be used to sequence the test with other operations and instrumentation. All listed data is stored in non-volatile memory with ".list" as the file extension. This secures the data and makes it easy to store and edit directly from the SDL front panel.

As shown in Figure 2-41, the load simulates the complex sequences of input changes based on the list parameters that you create. The list function supports CC, CV, CR, and CP modes.

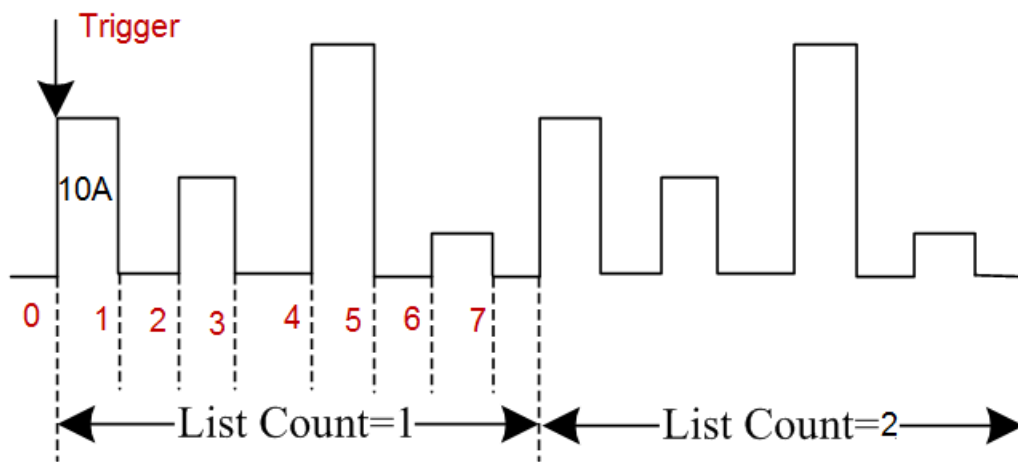

Figure 2-41 List Test Function

Users can edit list files through the front panel or use a previously created list.

Here, we will use the CC mode as an example (other modes are similar)

Operating steps

1. Connect device

Power on the instrument and connect the DUT and the channel input terminals of the electronic load, as shown in Figure 2-2.

2. Set running parameters

Press the **[Shift]** + **[CV]** key on the front panel, select “List” then enter List test mode, as shown in 2-42, 2-43.



Figure 2-42 List Test Function Page 1

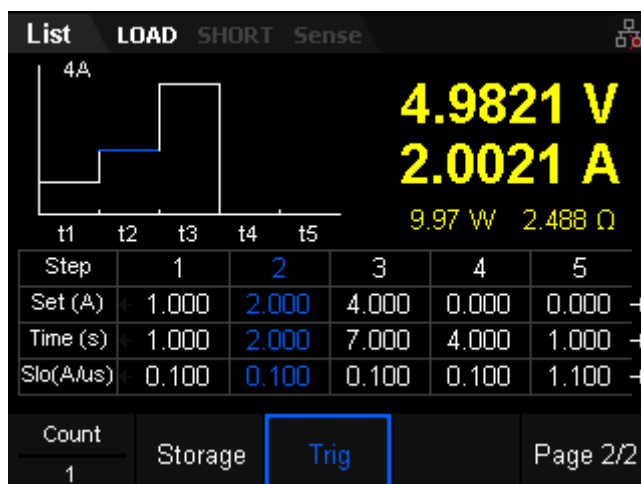
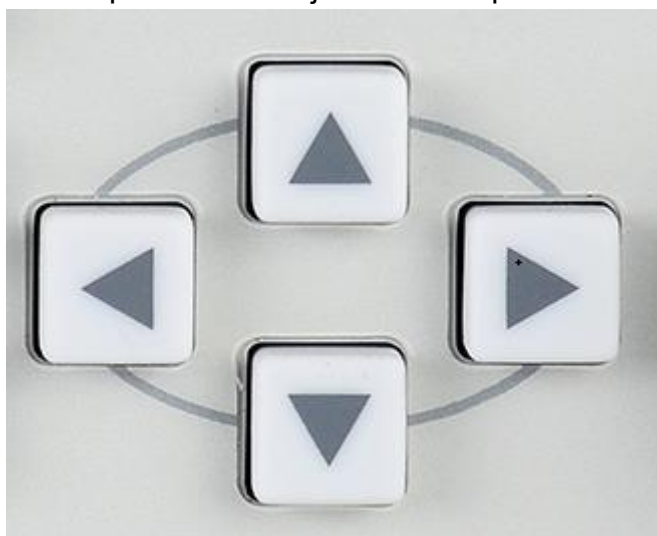

Figure 2-43 List Test Function Page 2

The parameters for the List test mode include Function, Range, Step, Count, Storage, and Trig . The interface menu can be divided into two pages.

To edit the values of the list, use the front panel arrows and keypad to navigate the list step table and adjust each step value:



Set Function

Choose CC,, CV, CR, or CP mode

Set range

Current range: 5 A or 30 A

Voltage range: 36 V or 150 V

Set Step

Here, you set the number of steps that are required for the list.

Set Count

The Count is the number of times the list will be executed before the end of the test. The Count has a range from 0~255. When Count is 0, the SDL will display “infinite” and will run each step in the list until it is disabled or stopped manually.

Set parameter of list

The parameter list of List mode includes step, sink value of each step, running time of each step, slew rate, readback current, readback voltage, readback resistor, readback power. The arrow in the right of parameter list indicates that the current interface can not display parameters of all steps. At this time, the user can edit all parameters of each step by using the direction keys/arrows to move the focus to different areas of the list.

3. Turn on the input channel

Press **On/Off** to turn on the channel input. At this time, the actual discharge voltage, current, time and capacity will be displayed on the main interface. The parameter status can be displayed in real time in parameter preview area.

**Warning**

To avoid electric shock, ensure that the DUT is connected to the input terminals of the load properly before you turn on the channel input.

4. View waveform

Press **Display** key to enter the waveform display interface, as shown in figure 2-44. Here, you can observe the measured performance of the input signal. Change the Data label (I, V, P, or R) to view a different parameter. Press the **Display** key again to exit the waveform display interface and return to the main interface of List test mode.

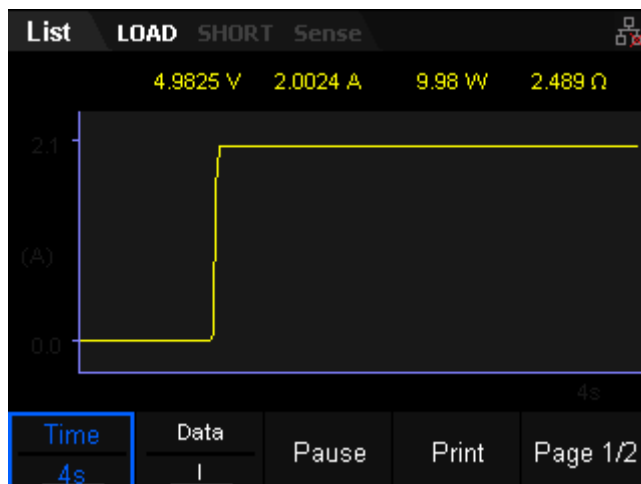

Figure 2-44 Waveform display interface of List mode

5. Storage

In the List function interface, you can press “Save” to save the parameters for List mode to the internal or external memory, and you can read and recall it if necessary by pressing “Recall”. Up to eight List files can be stored internally.

Auto Test Function

The auto test function in the SDL1000X electronic load is very powerful. It allows for multiple steps, similar to List mode. The biggest difference is that it can also change the test function type (CC, CV, CP, CR, LED, etc..) at every step. Up-to ten test files can be saved with each test file having a maximum of fifty steps each. The file extension defined for an Autotest file is “.prog”.

Operating Steps

1. Connect device

Power on the instrument and connect the DUT and the channel input terminals of the electronic load, as shown in Figure 2-2.

2. Set running parameters

Press the **Shift** + **CV** key on the front panel, select “Program” then enter Program test mode, as shown in 2-45.

step	1	2	3	4	5
mode	CC	CV	CP	CR	LED
lrange	30A	30A	30A	30A	30A
Vrange	150V	150V	150V	150V	150V
paus	OFF	OFF	OFF	OFF	OFF
short	OFF	OFF	OFF	OFF	OFF
Ton	1.000s	1.000s	1.000s	1.000s	1.000s
Toff	1.000s	1.000s	1.000s	1.000s	1.000s
Tdly	1.000s	1.000s	1.000s	1.000s	1.000s

Step	Storage	Trig	Result
5			

Figure 2-45 Program Test Function

The parameters for the program test mode include Step, Storage, Trig, Result.

Set Step

Set the number of steps you wish to run in this specific program.

Set parameter of list

The parameter list of Program mode includes mode, current range (lrange), voltage range (Vrange), pause (paus), Short, time on (Ton), time off (Toff), delay (Tdly), min, max, Set, resistance range (Rrange), Vo, Io, Rco. The arrow in the right of parameter list indicates that the current interface can not display parameters of all steps. At this time, user can edit all parameters of each steps by using direction key after move the focus to the list.

(1) Set operating mode

There are five modes that can be selected: CC, CV, CP, CR, or LED.

(2) Set the current and voltage ranges:

Current range: 5 A or 30 A

Voltage range: 36 V or 150 V

(3) Set pause Status

User can pause auto test if need. Simply highlight/select the cell labeled paus using the keypad arrows on the front panel and rotate the SDL control knob to enable change the entry value. Then the load will pause at this step when running this auto test step. Auto test can recover after receiving the next trigger.

(4) Set short Status

User can enter a short circuit step if needed. Similar to pause, use the keypad arrows to select the Short cell and rotate the knob to enable it. Then the load will short the circuit at this step when running an auto test.

(5) Set Loading Time(T_{on})

This is the time duration of each step and its range is 0.01~100 seconds (s).

(6) Set unLoading Time(T_{off})

The time interval in adjacent step and its setting range is 0.01~100S

(7) Set Delay Time(T_{dly})

The time is between begin test to sample the current or voltage value of the load. Its setting range is 0.01~ T_{on} s.

(8) Set minimum

The minimum sink value. Units depend on the current mode in use.

- In CC mode, its default unit is V
- In CV mode, its default unit is A
- In CP mode, its default unit is W
- In CR mode, its default unit is Ω

(9) Set maximum

The maximum sink value Units depend on the current mode in use.

- In CC mode, its default unit is V
- In CV mode, its default unit is A
- In CP mode, its default unit is W
- In CR mode, its default unit is Ω

(10) Set input value

- Set running current value in CC mode. The default unit is A
- Set running voltage value in CV mode. The default unit is V
- Set running power value in CP mode. The default unit is W
- Set running resistance value in CR mode. The default unit is Ω

(11) Set Rrange

Resistance range includes Low, Middle, High and Upper.

(12) Set LED operating voltage (V_o)

Set the operating voltage value in LED mode. The default unit is V

(13) Set LED operating current (Io)

Set the operating current value in LED mode. The default unit is A

(14) Set LED Coeff (Rco)

Users can change the operating voltage and resistance by changing "Rco" which has a set range from 0~1.

3. **Turn on the input channel**

Press **On/Off** to turn on the channel input. At this time, the actual discharge voltage, current, time and capacity will be displayed on the main interface. The parameter status can be displayed in real time in parameter preview area.

NOTE: The test operation depends on the trigger setting. If you have selected manual trigger, you can press Trigger to being the programmed test at this time.



Warning

To avoid electric shock, ensure that the DUT is connected to the input terminals of the load properly before you turn on the channel input.

4. **View waveform**

Press **Display** key to enter the waveform display interface, as shown in figure 2-44. Here, you can observe the change of the current/voltage/resistance/power over time. Press the **Display** key again to exit the waveform display interface and return to the main interface of the Program test mode.

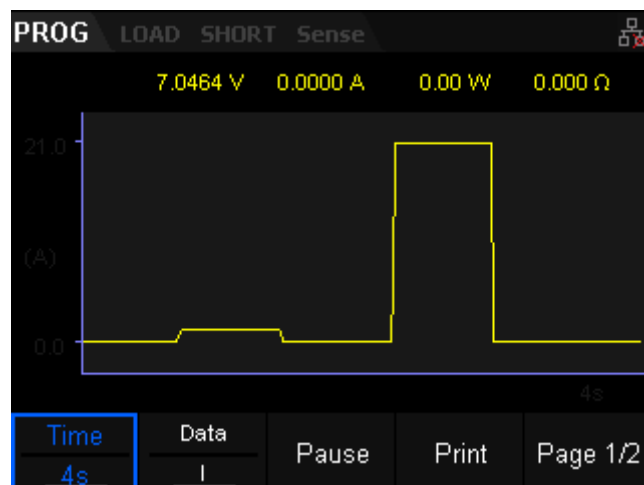

Figure 2-44 Waveform display interface of Program mode

5. Result

The auto test complete interface, as shown in Figure 2-45.

- Result list: Steps, Results and Remarks.
- Readback parameters: Including readback current, etc.
- Running step: Indicates the number of running steps.
- Clear: Remove all data in result list.

6. Storage

In the Program function interface, you can press “Save” to save the parameters for Program mode to the internal or external memory, and you can read and recall it if necessary by pressing “Recall”. The SDL can save ten Program files.

LED Test Function

This function adds a break-over voltage setting to the conventional CR mode. In short, the load acts like a diode. When the input voltage of the load is greater than the diode break-over voltage, the load can simulate the working principle of a diode and measures the drive current as in a real LED test.

Calculation method of V_d and R_d value:

- V_o : Working voltage of the load of an LED constant current source.
- I_o : Working current of an LED constant source.
- V_d : Break-over voltage of the diode
- R_d : Resistance of operating point

A typical $V - I$ characteristic curve of LED lights, as shown in Figure 2-45:

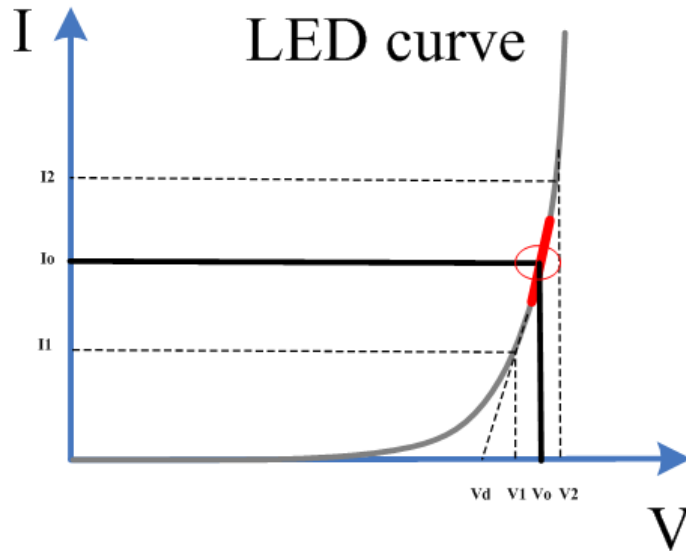

Figure 2-45 V - I characteristic curve of LEDs

According to the V-I curve, we can get R_d and V_d :

$$R_d = \frac{V_2 - V_1}{I_2 - I_1}$$

$$V_d = V_o - (I_o * R_d)$$

Choose V_2 , I_2 , V_1 , and I_1 near the static working point (as shown in the red circle of the curve). Users also can calculate the value of V_d and R_d according to methods below:

$$V_d = V * 0.8 \quad R_d = 0.2 V/I$$

Operating Steps

1. Connect device

Power on instruments and connect the DUT and the channel input terminals of the electronic load, as shown in Figure 2-2.

2. Set running parameters

Press the **Shift** + **CR** key on the front panel to enter LED test mode, as shown in 2-46.



Figure 2-46 LED Test Function

The parameters for the LED test mode include Range, Io, Vo, Rco.

Set Range

Current range: 5 A or 30 A

Voltage range: 36 V or 150 V

Set Vo

The working voltage at the operating point.

Set Io

The working current at the operating point.

Set Rco

Set Rd by the following formula:

$$Rd = (Vo/Io) * (1 - Rco)$$

3. Turn on the input channel

Press **On/Off** to turn on the channel input. At this time, the actual sink voltage, current, power, resistance will be displayed on the main interface. The sink current will be increasing with increase input voltage of the load.

Note:

Once the channel input is turned on, the load will not start to sink the current until the input voltage is greater than the break-over voltage.



Warning

To avoid electric shock, ensure that the DUT is connected to the input terminals of the load properly before you turn on the channel input.

4. View waveform

Press **Display** key to enter waveform display interface, as shown in figure 2-47. Here, you can view data with respect to time. Select a data type to choose the graphed values. Press the **Display** key again to exit the waveform display interface and return to the main interface of LED test mode.

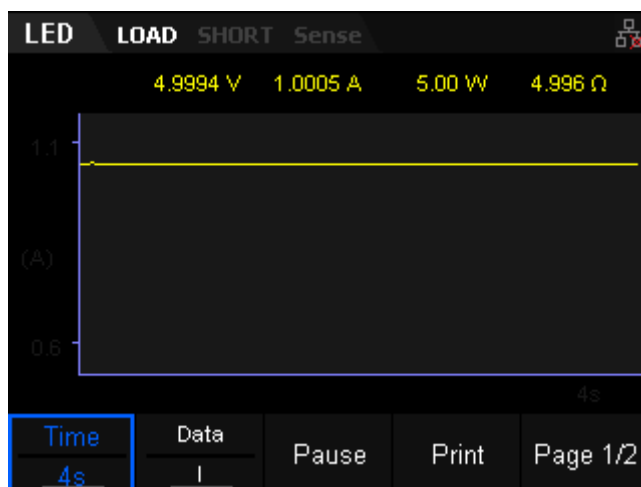

Figure 2-47 Waveform display interface of LED test mode

Waveform Display Function

The electronic load provides the waveform display function and supports the following operations: pausing, recording, , and capturing the waveform. Therefore, you can dynamically observe the trend of the input. The waveform display function is applicable to CC/CV/CR/CP/LED/Con/Pul/Tog/OCPT/OPPT/List/Battery/Program/ExtI/ExtV modes.

For example , in CC mode press Display key to enter waveform display interface, as shown in figure 2-48.

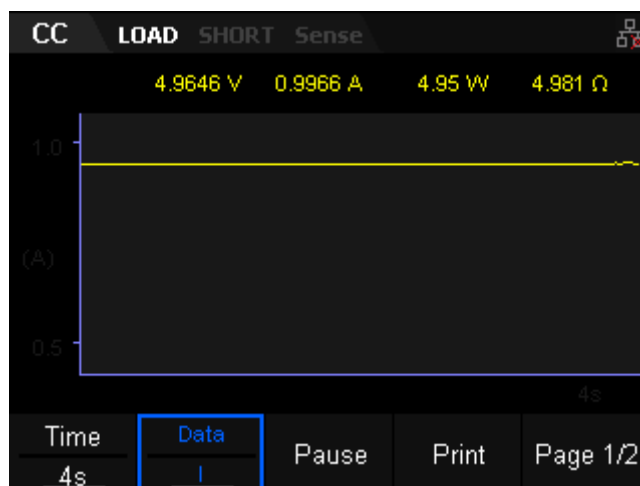

Figure 2-48 The waveform display in CC mode

Operating Steps

1. Set Time

The time set range is 4 s ~ 80 h in all modes.

Tip

When the time that you set is greater than 120 s, it will be automatically displayed in minutes. When greater than 120 min, it will be automatically displayed in hours.

2. Set Data

menu items under "Data" include I, U, R, and P.

3. Pause and Start

When the "Pause" key is pressed, the load will suspend the data collection and graphing of the waveform. When the "Start" key is pressed, the load will continue to graph waveform. These operations govern graphing only. The active state of the load is still being governed independently by the current settings, list, or program running.

4. Print

After you insert the USB storage device, press "Print" to capture the screen or images and save them in ".BMP" format to the USB storage device.

5. Record

After you insert the USB storage device, press the "Record" key to

save the data file in ".CSV" format to the USB storage device.

This will prompt you to name the file. The load will begin to graph the data as well as write it to the USB memory stick. When you are recording data, the corresponding flag will display in the top of the interface :

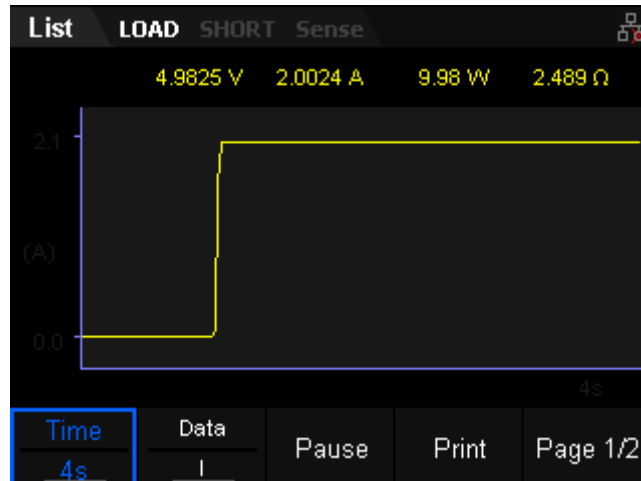

The flag will disappear after pressing the “Record” key again.

6. Playback

Press “PlayBack” to play back the recorded data files.

- (1) After stopping a recording, press “Playback” to enter the playback interface.
- (2) Press the File softkey to open the file dialog window.
- (3) Use the keypad arrows to navigate and select the data file in “.CSV” format that you wish to replay.
- (4) Press the “Read” key , the instrument will read the selected data file and display in the waveform display interface.

Tip

The recording function and palyback function can not be enabled at the same time.

Restore

The load can save various types of files to internal or external memories. You can recall and read them when necessary. The load supports an internal non-volatile memory (Local(C:)) and an external memory (USB(D:)). Disk D is only available when a USB storage device is detected over the USB HOST interface on the front panel.

Note:

The load only supports FAT32 USB flash drives.

1. Local (C:)

User can save the currently set state files to the local storage area and recall them when necessary. Eight list files and ten program files can be saved to the local drive.

2. USB(D)

Disk D is only available when a USB storage device is detected over the USB HOST interface on the front panel. You can save the currently set state files and data files of various function modes to the USB storage device and you can also copy the files from Disk C to Disk D. The number of files that can be saved is determined by the storage space of the disk.

Press **Restore** key on the front panel of the load to enter the storage and recall interface, as shown in Figure 2-49.

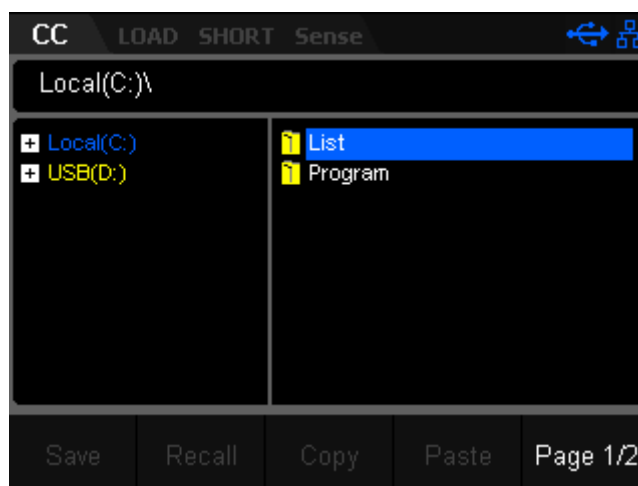

Figure 2-49 Storage and Recall Interface under CC mode

Save

Operating Steps

1. Press **Restore** to enter storage interface, then enter the file catalogue list in List/Program.
2. User can select an arbitrary file in the files catalogue in List/Program, then click “Save” to enter file name edit interface which is default display “Default”, as shown in figure 2-50.

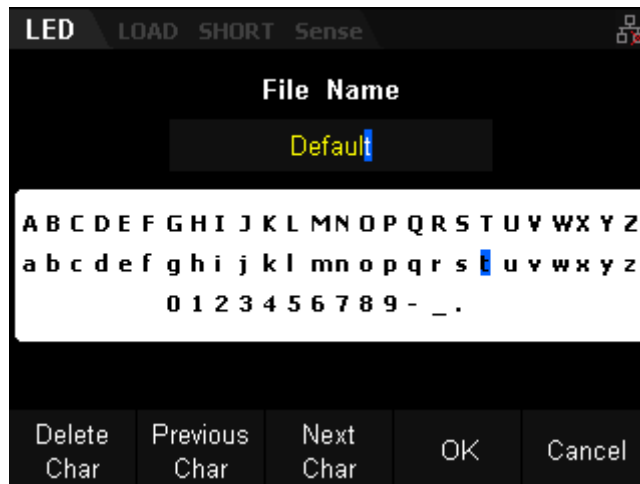

Figure 2-50 filename edit interface

3. The filename edit box can be input uppercase and lowercase English letters、0~9 natural numbers and special characters “-” or “_” or “.”, etc.

Input character:

The character can only be edit in the place where the cursor is located in the filename edit box. Press Enter or “Next Char” key to edit the next character.

Character selection area:

The white color area is the character selection area in the interface. Press up and down key to select character in vertical direction and press left and right key to select character in the horizontal direction. Then press Enter key or rotary knob to confirm.

4. Selection function of the interface:
 1. Delete Char: Delete the character where the cursor is and the length of filename will reduce one character length. If the character is the final one, it will display “A” after deleted.
 2. Previous Char: Cursor moves left
 3. Next Char: Cursor moves right
 4. OK
 5. Cancel

Press “OK” key after input the filename in the filename edit interface.

Read

Operating Steps

1. Press **Restore** to enter the storage interface, then enter the files catalogue list in List/Program.
2. You can select an arbitrary file in the files catalogue in List/Program, then click “Read” to enter List/Program mode.

Copy and Paste

This function only operates in copying files from the internal storage (C:) to an external USB memory device (D:)

Operating steps

1. Press **Restore** to enter the storage interface, then enter the files catalogue list in List/Program.
2. Users can select an arbitrary file in the files catalogue in List/Program, then click “Copy” to copy the current file that is selected.
3. Switch to the Disk D file catalogue and press “Paste” in the target path to paste the file to Disk D. Only one file can be copied and pasted at one time.

Delete

Users can delete files in Disk C and Disk D.

Operating steps

1. Press **Restore** to enter the storage interface, then enter the files catalogue list in Disk C and Disk D.
2. User can select an arbitrary file in the files catalogue in List/Program or Disk C and Disk D, then click “Delete” to delete the current file that be selected. Only one file can be deleted at one time.

Rename

Users can rename filename of the files in Disk C and Disk D.

Operating steps

1. Press **Restore** to enter storage interface, then enter the files catalogue list in Disk C and Disk D.
2. Users can select an arbitrary file in the files catalogue in List/Program or Disk C and Disk D, then click “Rename” to rename the current file that be selected. Press “OK” after finished editing.

Function of Terminals on the Rear Panel

Sense mode

When the DUT outputs large currents, the voltage drop due to the lead and contact resistance of the load leads cannot be ignored. To ensure an accurate measurement for the output voltage of the DUT, the load provides Sense (remote sense) working mode. In this mode, the Sense terminals (as shown in figure 2-51) are directly connected to the output terminals of the DUT. Remote sensing compensates for the voltage drop caused by the load leads, ensuring that the output voltage of the DUT is consistent with the input voltage of the load.

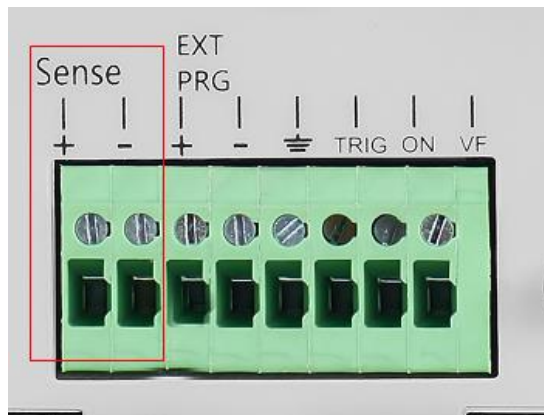

Figure 2-51 Sense terminal on the rear panel

Figure 2-52 shows the Sense connections on the front panel.

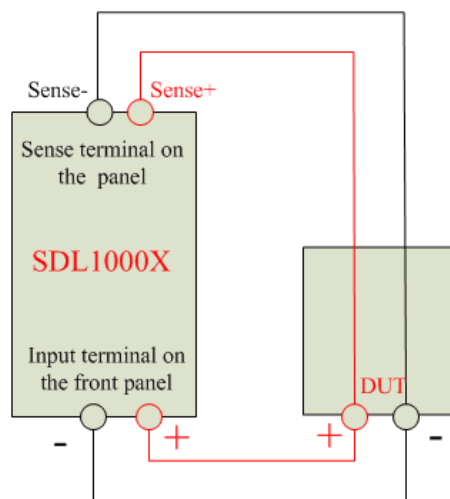

Figure 2-52 Sense connection

Operating steps

1. As shown in the above figure, connect the load to the DUT. Ensure that the polarity of the connections is correct.
2. Press **Shift** and **CP** key to enter the system utility function interface. Press “Config” and “Sense” to enable (disable) the Sense function.

Note: The Sense terminals must be connected to the output terminals of the DUT. If not, then the load cannot accurately measure the voltage of the terminals in any function.

Tip: In case where the DUT outputs large currents, the load leads should be as short as possible. Twisting the sense leads can also assist in minimizing measurement noise.

External Trigger Function

The SDL features an external trigger which allows sequencing and control to be performed using another instrument or trigger source. To start, set the trigger source to “External” by pressing **Shift** > Utility > Config > Page 2/2 and set Trig to Ext. The trigger signal input and ground connection are shown on the rear panel. The trigger input signal should be 0~5V TTL level

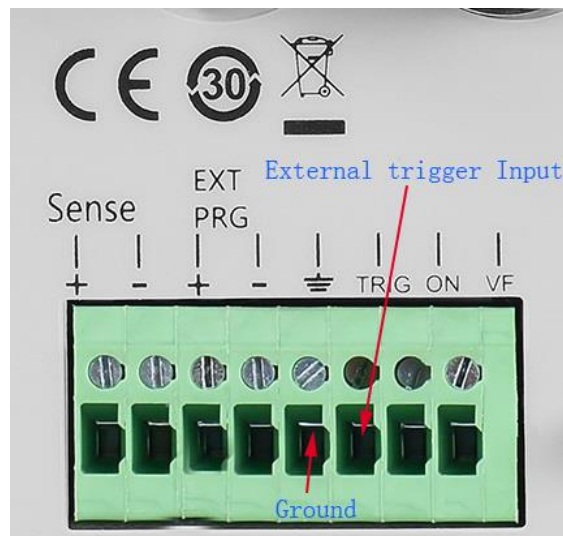

Operating Steps

1. Press **[Shift]** and **[CP]** key to enter the system utility function menu. Select “Config” and set trigger mode of the trigger source be “Ext”, then press **[Enter]** to confirm.
2. When using the external trigger mode, the falling edge of the trigger signal output from the negative and positive trigger terminal can enable trigger function. The trigger can be used in List, Program, and dynamic test mode.



CAUTION

Please do not connect the negative pole of the load and the negative pole of external trigger termination, the fifth termination of rear panel which is grounded.

Voltage fault Indicating Function

When the load is in overvoltage protection or reverse connection protection, the VF terminal which indicates a voltage fault will output a high level.

Current and Voltage monitor

The output terminal of current and voltage monitor sources a 0~10 V analog signal that represents the input from zero to full range. Users can use

an external voltmeter or oscilloscope to observe the trend of the input current or voltage.

Operating Steps

To set up VMON

Press Shift utility, press config. go to page 2, press EXTC, press V_M_OFF and again to change to on state, SDL comes back "Please confirm that the BNC is connected" – move blue highlight over to OK with universal dial, press universal dial to select, V_M_ON goes on. SDL is ready to send output to VMON.

To set up IMON

Press Shift utility, press config. go to page 2, press EXTC, press I_M_OFF and again to change to on state, SDL comes back "Please confirm that the BNC is connected" – move blue highlight over to OK with universal dial, press universal dial to select, I_M_ON goes on. SDL is ready to send output to IMON.



Please do not connect the negative pole of the load and the negative pole of monitor termination.

Short-circuit monitor

The load can deliver a short circuit at the input terminals. The protection functions are still active even when using the short circuit function. Press Shift and Short key to switch the short circuit status. The short circuit status does not influence existing setting values. When exiting short-circuit mode, the load will return back to the original setting status.

Note: The short circuit function needs to turn on the enable switch in the setting, and the short key pressed on the front panel will take effect.

Operation method: Press Shift utility, press config. go to page 3, press Short_EN and again to change to on state.

Protection Functions

Overvoltage protection (OVP)

The load will be immediately disable the input, the buzzer will sound, and

the LCD screen will pop-up an overvoltage message if overvoltage protection is triggered. The VF pin on the rear board will output a TTL high level signal if overvoltage occurs. This signal can be used to monitor the output status of the DUT. Press **Shift** and **Display** key to clear overvoltage protection status.

Overcurrent protection (OCP)

The load supports two kinds of overcurrent protections: Hardware overcurrent protection and software overcurrent protection.

- Hardware overcurrent protection: The maximum load current of the electronic load is limited to the max current of the existing current range by hardware. When the hardware triggers overcurrent protection, the load will automatically disable the input and the LCD screen will pop-up an overcurrent message. The prompt box of overcurrent protection will disappear if the input drops below the set current range (I_Range).
- Software overcurrent protection: For a more precise protection limit, you can set the load software overcurrent protection value using the following steps:
Press **Shift** and **CP** key to enter system utility interface. Then press “Limit” and “I_Protect” to set relevant parameters, such as current value and delay time. If the load sink current is greater than the protection current value, the load input will automatically be disabled and an overcurrent message will pop-up.

To exit OCP protection, press any key on the front panel of the load. .

Overpower protection (OPP)

The load supports two kinds of overpower protections: Hardware overpower protection and software overpower protection.

- Hardware overpower protection: The maximum load power of the electronic load is limited within about two hundred watt. When the hardware triggers overpower protection, the load input will be disabled automatically and the LCD screen will pop-up an overpower message. The prompt box of overpower protection will disappear if the hardware overpower protection situation is relieved.
- Software overpower protection: The user can set load software overpower protection value following steps: Press **Shift** and **CP** key to

enter system utility interface. Then press “Limit” and “I_Protect” to set relevant parameters, such as power value and delay time. If the sink power of the load is greater than the protection power value, the the load input will be disabled and a pop-up overpower message will appear..

To exit OPP protection, press any key on the front panel of the load.

Over-temperature Protection (OTP)

The load will enter OTP if the temperature of internal power devices exceeds 85°C. If an OTP fault occurs, the load input will be disabled and an OTP warning message will pop-up. When the temperature of the load decreases and is below the protection point, press any key on the front panel of the load to clear the error and exit OTP status.

Input Reverse Polarity Protection (RPP)

When the load makes a reverse connection with the DUT, the load input will be automatically disabled immediately. At this time, the buzzer sound and the LCD screen will pop-up an RPP message.

Tip

- If the reverse current is greater than the rated maximum current, the load may be destroyed.



To avoid to damage the load, when the load RPP occurs, the user should close the load and reconnect the positive and negative poles.

Chapter 3 System Utility Function

System

Press **Shift** and the **CP** key to enter the system utility function interface. Then press "system" to enter the system info interface, as shown in figure 3-1 and 3-2.

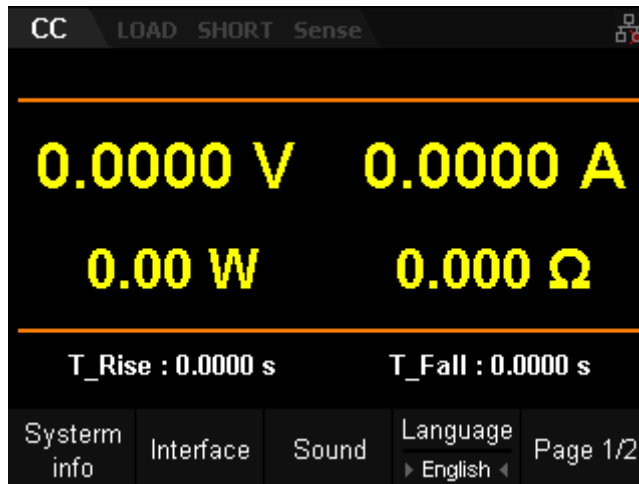

Figure 3-1 System info page 1



Figure 3-2 System info page 2

Table 3-1 Tab Descriptions

No.	Name	Description
-----	------	-------------

1	System info	System info tab. View startup times, software version, hardware version, serial number, and product ID.
2	Interface	Communication interface setting tab. Configures parameters for remote communication interfaces (USB/RS232/GPIB/LAN).
3	Sound	Sound tab. Enabled/disable sounds.
4	Language	Language tab. Chinese/English
5	Factory	Factory tab. Reset the system to the default settings.
6	Upgrade	Upgrade tab. Select software version and upgrade the load.
7	BoardTest	BoardTest Includes LCD test, LED test, LCD test,, Keyboard test, Buzzer function test, and Chip test.

1. System info

Press **Shift** and **CP** key to enter system utility function interface. Then press the “System” key to enter system info interface, as shown in figure 3-3.



Figure 3-3 System info interface

In “System info” interface, user can View startup times、 software version、 hardware version、 serial number and product ID about the load.

2. Interface

Press **Shift** and the **CP** key to enter the system utility function interface. Then press the “Interface” key to enter the interface tab of the load which default selection tab is USB, as shown in figure 3-4.



Figure 3-4 USB interface

The instrument supports USB/RS232/GPIB/LAN communication interfaces. Users can use this remote interface to control the instrument using a computer. Please set the relevant parameters when selecting the communication interface.

Note: The USB and LAN interface of the load are “hot swappable” and can be connected and disconnected while the instrument is powered on. USB/RS-232/GPIB/LAN cannot be used at the same time. Only one interface can be used for remote control.

View USB ID

Use a USB cable to connect the load to a computer via the USB DEVICE interface. Then, the load can be controlled remotely.

Press Interface to enter the communication interface tab, and then press the USB key to select the "USB" tab, as shown in Figure 3-4.

Set the parameters of the RS232 interface

Use the 9-pin RS232 cable (female-to-female, cross-over) to connect the RS232 interface to the PC, and set the interface parameters (such as baud rate, parity, etc.) that match the PC. Then, user can remotely control the instrument. The RS232 interface is shown in the following figure. For the descriptions of the pins, refer to Table 2-2.

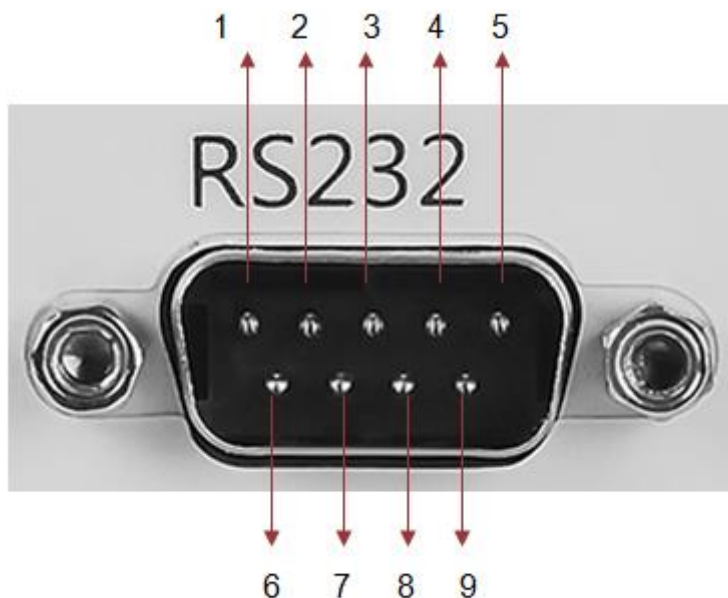

Figure 3-5 RS232 Interface

Table 3-2 Pin description of RS232.

Pin	Name	Description
1	NC	No Conjunction
2	TXD (Transmit Data)	Data transmission
3	RXD (Receive Data)	Data receiving
4	NC	No Conjunction
5	SGND	Signal grounding
6	NC	No Conjunction
7	CTS (Clear To Send)	Clear to send
8	RTS (Request To Send)	Request to send
9	NC	No Conjunction

Press Interface key to enter “Interface” tab and press “RS232” to enter the RS232 interface, as shown in figure 3-6.

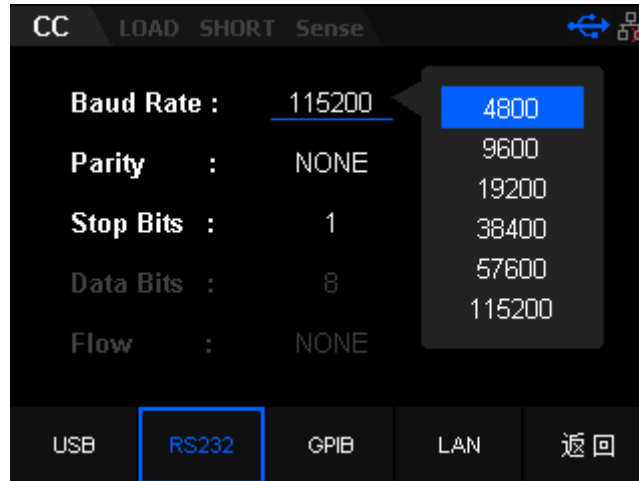

Figure 3-6 RS232 Interface

In “RS232” interface, user can set and view relevant interface parameters about RS232.

1. Baud Rate

The available baud rates include 4800 9600, 19200, 38400 , 57600 , and 115200 bps.

2. Parity

The available parity modes include None, Even, and Odd.

3. Stop Bits

The available stop bits include 1 or 2.

4. Data Bits

The default data bits is 8.

5. Flow

The default flow is None.

Set GPIB Adress

Before using the GPIB interface, use the USB-GPIB interface converter to extend the GPIB interface, and then use the GPIB cable to connect the load to the PC. Figure 3-7 show the GPIB interface.

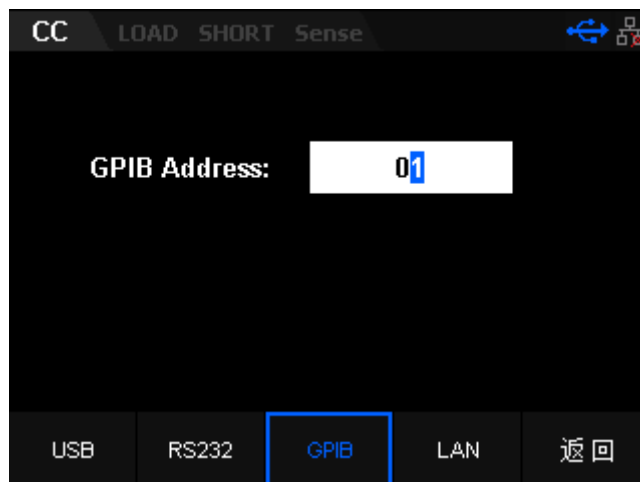

Figure 3-7 GPIB Interface

The GPIB Load address range is from 0~30. The default address of GPIB is 1 which is stored in the non-volatile memory and is not influenced by restoration of factory settings.

Set the parameters of the LAN interface

Before using the LAN interface, connect the load to a computer or the local area network (LAN) where the computer is visible and ensure sufficient connectivity.

Press Interface to enter the communication interface tab, and then press the "LAN" key to select the "LAN" tab to enter the network parameter setting interface, as shown in Figure 3-8.

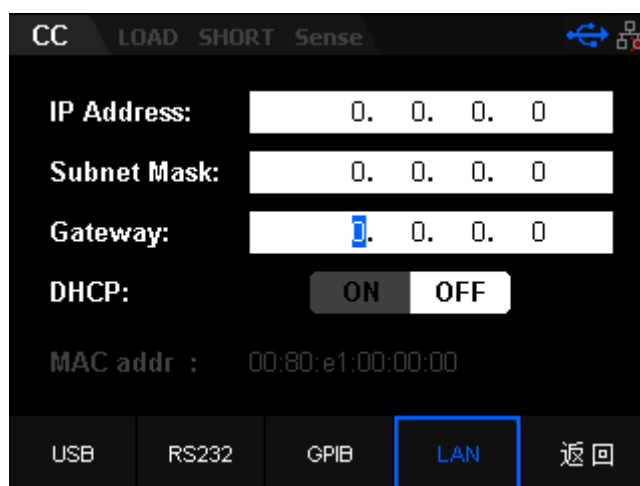

Figure 3-8 LAN Interface

In this interface, you can view the network connection status and configure the network parameters such as IP address, subnet mask, default gateway and DHCP status. The setting is store in the non-volatile memory and do not influenced by restore factory setting.

Connection Status

IP configuration include two modes:

- DHCP(Dynamic host configuration protocol)
- Manual IP(Manual configuration)

In different IP configuration modes, the configurations for IP address and other network parameters are different.

1) DHCP

Under DHCP mode, the DHCP server on the current network assigns network parameters (such as the IP address) to the instrument. When DHCP is ON, relevant parameters can not be edited; When DHCP is OFF, IP parameter must be set manually.

2) Manual IP

In this mode, user need to set sufficient IP net parameters.

1. Mac address

Physical address is also called media access control address (MAC address). It is also called hardware address, which can be used to define the location of the network device. The physical address for one device is unique and is not allowed to be modified. It can be used to identify the instrument when you assign the IP address to the instrument. A physical address is a 48-bit (6-byte) addressing scheme, usually represented in Hex. For example, 00-80-e1-00-00-00.

2. Sound

Press **Shift** and **CP** key to enter system utility function interface. Then press "Sound" to enter the Sound menu, as shown in figure 3-9.



Figure 3-9 Sound tab

In the “Sound” menu, you can enable or disable the key sound and tips sound. The load buzzer will sound when you press the key on the front panel or rotate the knob after the key sound is enabled. It will not sound if the key sound is disabled. If the Tips sound is set to ON, the load buzzer will sound when pop-up tips or warning messages. Turn off the Tips sound, and the load buzzer will not sound except during any load protection tips.

3. Language

The load supports Chinese and English language man-machine interaction and tips.

4. Factory Setting

Press **Shift** and the **CP** key to enter the system utility function interface. Switch to page 2 then press “Factory” to restore factory settings, as shown in figure 3-10.

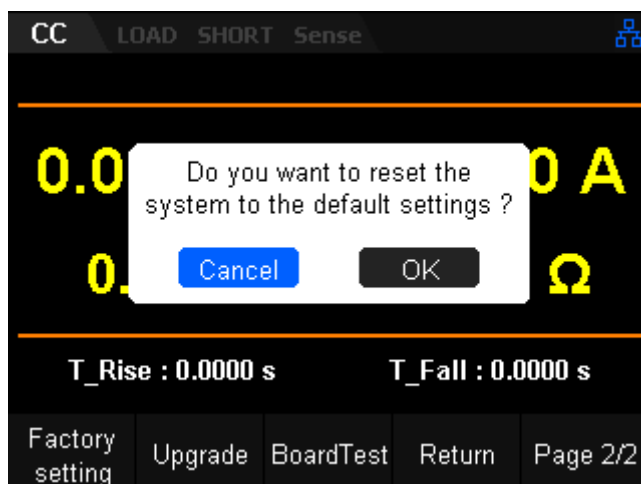

Figure 3-10 Restore factory setting interface

When user selects OK, the parameters in every function will restore to defaults.

5. Upgrade

The SDL1 can be upgraded with new firmware using an external FAT32 formatted USB memory device.

To update the firmware, press **Shift** and **CP** key to enter system utility function interface. Then switch to page 2 and press the “Upgrade” key on the front panel. Finally, select the proper firmware upgrade version in the interface of the USB file catalogue.

NOTE: Firmware updates can be found on the product page located on the website (www.siglent.com, www.siglentamerica.com, www.siglenteu.com)

6. BoardTest

Users can check the current status of the load by using the BoardTest function. This feature tests the keypad LEDs, LCD,, Keyboard, Buzzer and Chip test function.

- ◆ LED Test: Test whether the LED lights responsible for keypad backlighting are operational
- ◆ LCD Test: Test whether the LED screen display is operational
- ◆ Keyboard Test: Test whether the function of all keys except the power switch on

the front panel is normal or not.

- ◆ Buzzer: Test whether the buzzer can sound or not.
- ◆ Chip Test: Including the self-test result of the load, EEPROM and ADC.

Config

Turn ON/OFF the Sense Function

When the DUT outputs large currents, the Sense terminal can be used to accurately test the voltage across the output terminals to compensate for the voltage drop on the load. Set `Vrmt` to ON to enable the remote sense test function.

Turn ON/OFF SOF Function

SOF stands for Stop On Fail. When enabled, the auto test function will stop running immediately when any step fails during an auto test. If SOF is disabled, the auto test will continue to run until the test is completed, even if a failure is detected.

Break-Over Voltage

When testing power products with slow voltage rise rates, if the electronic load input is opened before power, the power may latch protection. In this way, the user may set VON value. The electronic load only latches when the power voltage is higher than this value.

Turn ON/OFF Von-Latch Function

on the Von Latch function locks the input voltage to the Von-Latch value if the Von-Latch value is measured. The load will start testing when the the power output voltage rises and is higher than the break-over voltage.. When the power voltage drops and is lower than the break-over voltage, the load will contine to latch at the Von-Latch value , as shown in figure 3-11.

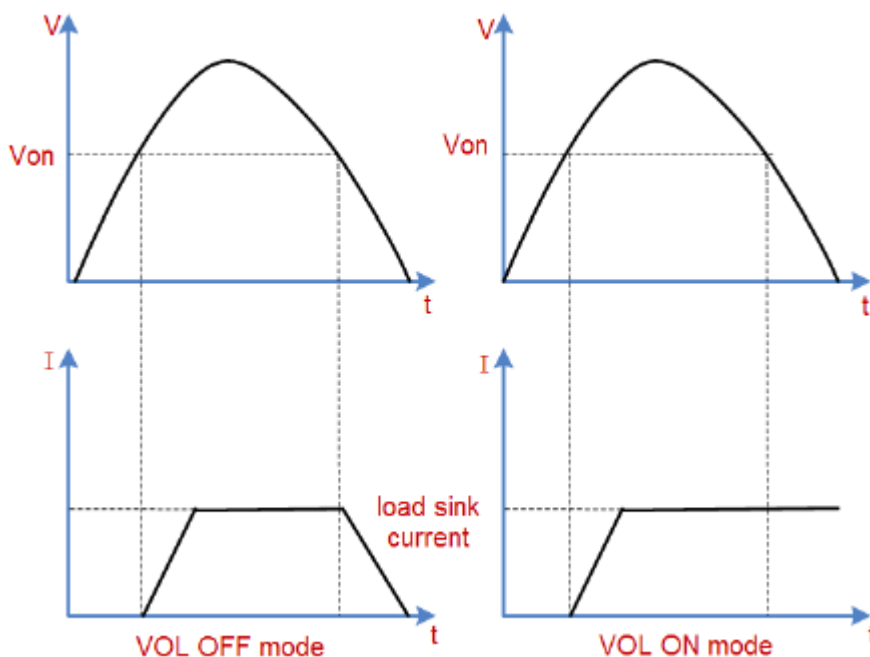

Figure 3-11 V - I characteristic curve of Von Latch

Set Trigger

Trigger operation is mainly applied to the Dynamic, List and Program test functions. The load supports three modes: Manual, Ext and Bus.

- Manual
When the trigger source is set to Manual mode, press the trig tab in dynamic, , List, or Program mode will generate a trigger signal.
- Bus
When the trigger source is set to Bus mode, the load will execute a trigger operation when it receives the remote command (such as *TRG) from USB, LAN, RS232 and GPIB interface.
- Manual

The Ext monitor terminals on the rear panel of the load can receive external trigger signals. When the trigger source is set to be Ext mode and a pulse(0~5V TTL) which have falling edge plus to the terminal, the load will trigger signal.

Set Aver

In “Config” tab, when user select “Aver” can set the average point number of the read-back current and voltage in the load. The range is 6~14. The greater

of the average point number, the slower of the read-back current and voltage in the load.

Set EXTC (External Interface)

The “EXTC” tab includes: (Int, ExtI, ExtV), ExtSwitch, I_M_ON, V_M_ON four tabs. It mainly supply the way user control the external terminals on the rear panel, current and voltage monitor, external control ON/OFF.

Int

The load will return the mode before enter “EXTC” tab after select the “Int” tab.

ExtI

After selecting “ExtI” tab, the load will display the ExtI interface. It includes: Type, RangeI, RangeV options. The sink current of the load can be controlled by the “EXT” terminals on the rear panel of the load. The input voltage is not suggested to greater than 10V , otherwise it may destroy the load. Users can simulate input current of the load which range is from zero to full current range.

Operating Steps

1. Connect device

Power on instruments and connect the DUT and the channel input terminals of the electronic load, as shown in Figure 2-2.



Warning

The input voltage range of the “EXT” terminals is 0~10 V. To avoid damage to the instrument, please pay attention to the polarity of the device terminals .

2. Set running parameters

Press the **[Shift] + [CP]** key on the front panel to enter system utility function interface. Select “Config” option and Switch to page 2, then choose “EXTC”. User can enter ExtI interface after press “INT” and choose “ExtI” tab, as shown in 3-12.

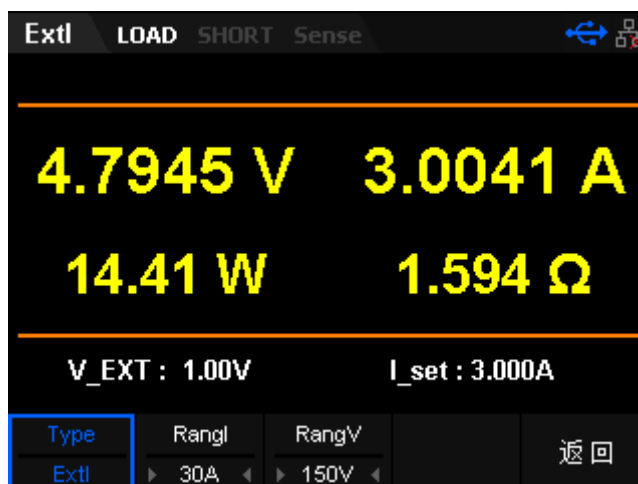

Figure 3-12 The main interface of the Extl mode

The parameters for the Extl mode include RangI and RangV.

Set Range

Current range: 5 A or 30 A

Voltage range: 36 V or 150 V

Set External Input Voltage

The sink current in Extl mode can be controlled by the external input voltage which range is 0~10 V. The default unit of current is A

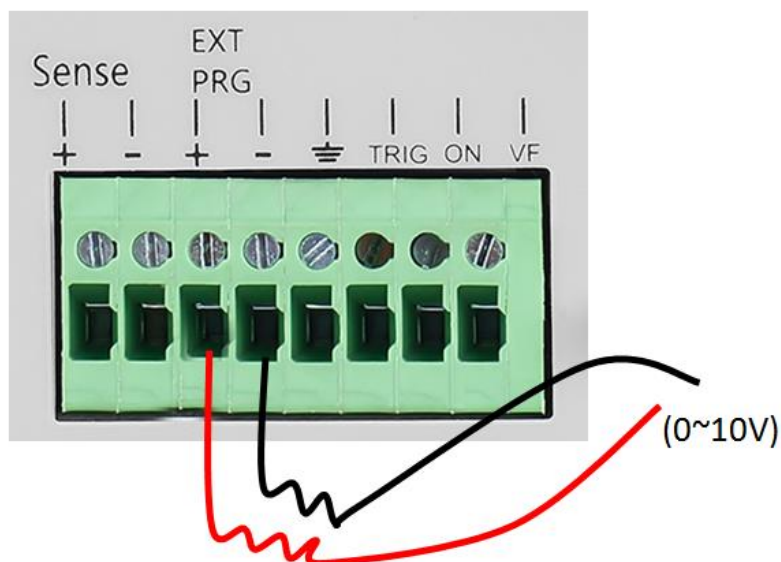

3. Turn on the input channel

Press On/Off to turn on the channel input. At this time, the actual sink voltage, current, power, resistance will be displayed on the main interface.

Note: Once the channel input is turned on, the load will not start to sink the current until the input voltage is greater than the break-over voltage.

4. View waveform

Press **Display** key to enter waveform display interface, as shown in figure 3-13. By means of observe waveform of ExtI mode after set the Data selection be “I”, user can see the trend of the sink current. Press the **Display** key again to exit the waveform display interface and return to the main interface of ExtI mode.

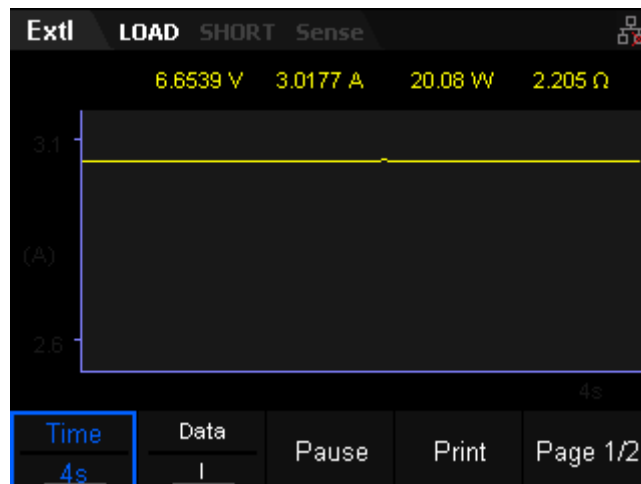

Figure 3-13 Waveform display interface of ExtI mode

ExtV

After selecting “ExtV” tab, the load will enter ExtV interface. It includes Type, RangeI, RangeV three options. The sink voltage of the load can be controlled by the “EXT” terminals on in the rear panel of the load. User can simulate input voltage of the load which range is from zero to full range.

Operating Steps

1. Connect device

Power on instruments and connect the DUT and the channel input terminals of the electronic load, as shown in Figure 2-2.



Warning

The input voltage range of the “EXT” terminals is 0~10 V. To avoid damage to the instrument, please pay attention to the polarity of the

device terminals .

2. Set running parameters

Press the **[Shift]** + **[CP]** key on the front panel to enter the system utility function interface. Select “Config” option and Switch to page 2, then choose “EXTC”. User can enter ExtI interface after press “INT” and choose “ExtV” tab, as shown in 3-14.

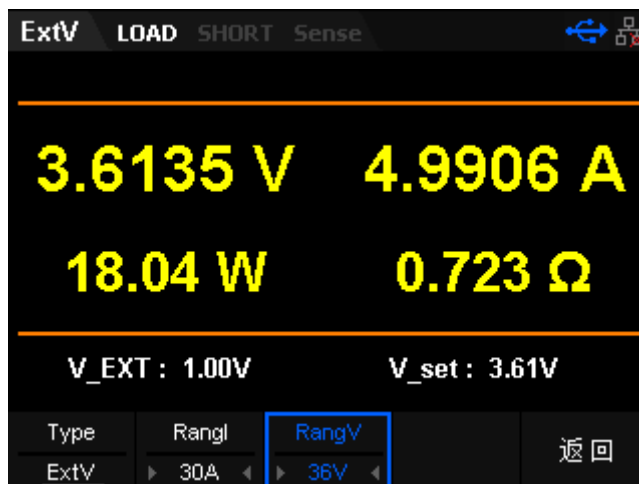

Figure 3-14 The main interface of the ExtV mode

The parameters for the ExtV mode include RangI and RangV.

Set Range

Current range: 5 A or 30 A

Voltage range: 36 V or 150 V

Set External Input Voltage

The sink voltage in ExtV mode can be controlled by the external input voltage which range is 0~10 V. The default unit of voltage is V

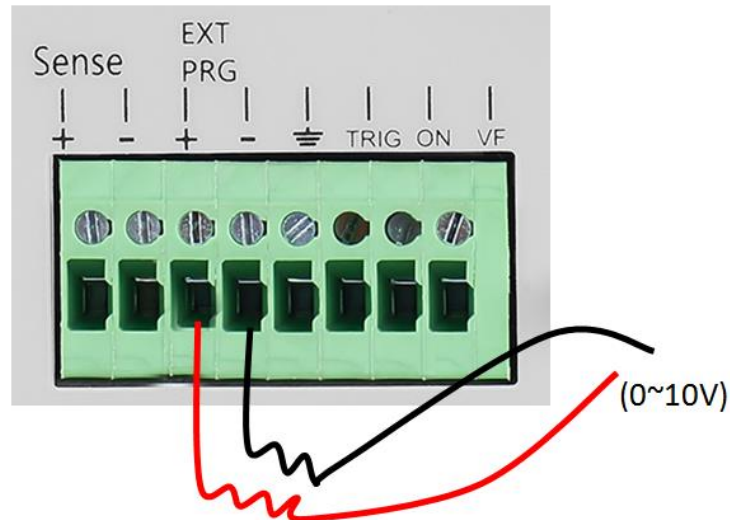

3. Turn on the input channel

Press **On/Off** to turn on the channel input. At this time, the actual sink voltage, current, power, resistance will be displayed on the main interface.

Note: Once the channel input is turned on, the load will not start to sink the current until the input voltage is greater than the break-over voltage.

4. View waveform

Press **Display** key to enter waveform display interface, as shown in figure 3-15. By means of observe waveform of ExtV mode after set the Data selection be "V", user can see the trend of the sink voltage. Press the **Display** key again to exit the waveform display interface and return to the main interface of ExtV mode.

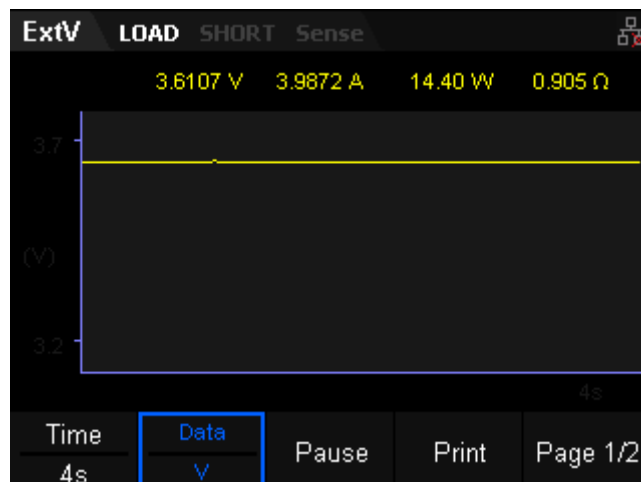

Figure 3-15 Waveform display interface of ExtV mode

ExtSwitch

The load input switches can be controlled by the external TTL electrical level. During external input control, the [On/Off] key will become invalid and the load input switches can only be controlled by the external TTL electrical level. The load input will be switched on in case of low level external input and meet a falling edge; and the load input will be switched off in case of high level external input.

IMON

The 0-10 V analog quantity output signal of current monitoring output terminal represents input current to which the terminal belongs from 0 to full range. The input current is proportional to the voltage on the terminal. An external voltmeter or oscilloscope can be connected to display input current change.

VMON

The 0-10 V analog quantity output signal of voltage monitoring output terminal represents input voltage to which the terminal belongs from 0 to full range. The sink voltage is proportional to the voltage on the terminal. An external voltmeter or oscilloscope can be connected to display input current change.

SLMT

SDL1000X electronic load can measure the rise and fall time of the voltage in CC, CV, CR and CP mode. This function can simply simulate the rise and fall rate of the power voltage.

Operating Steps

1. Press **Shift** and **CP** key to enter system utility function interface. Then enter "Config" tab and select "SLMT" tab to enter SLMT function.
2. Turn on the "TMon" tab, The voltage rise time "T_Rise" and falling time "T_Fall" will be displayed on LCD screen, as shown in figure 3-16.



Figure 3-16 SLTM tab

3. Input the low voltage and high voltage, then turn on the TMon
4. Connect the load to the DC power under test. Set the power output higher than the V_High. At this time, the power is OFF.
5. Set a sink current of the load in CC mode, then turn on the load input.
6. Turn on the power under test, The T_Rise is displayed quickly on the LCD screen which is the voltage rise time.
7. Turn off the power under test, The T_Fail on the LCD screen is the falling time.
8. Close all instruments and finish the test.

Limit

I_Protect

SDL1000X electronic load can overcurrent protection by the software of the load. Turn on the load input, if the sink current of the load is higher than the protection current, the load will turn off input automatically and pop-up an overcurrent protection message after a delay period.

Operating Steps

1. Press **Shift** and **CP** key to enter system utility function interface. Then enter "Config" tab and select "I_Protect" tab to enter I_Protect function.

- Turn on the “TMon” tab to enable the I_Protect. Then set the protection current and delay time, as shown in Figure 3-17.



Figure 3-17 I_Protect tab

- Connect the load to the DC power under test when the power is OFF.
- Set a sink current in CC mode of the load.
- Turn on the power output and the load input. Delay a period of time, the overcurrent protection of the load will occur.
- Close all instruments and finish the test.

P_Protect

SDL1000X electronic load can simulate overpower protection by the software of the load. Turn on the load input, if the sink power of the load is higher than the protection power, the load will turn off input automatically and pop-up over power protection message after a delay period.

Operating Steps

- Press **Shift** and **CP** key to enter system utility function interface. Then enter “Config” tab and select “P_Protect” tab to enter P_Protect function.
- Turn on the “TMon” tab to enable the P_Protect. Then set the protection power value and delay time, as shown in Figure 3-17.



Figure 3-17 P_Protect tab

3. Connect the load to the DC power under test when the power is OFF.
4. Set a sink current in CC mode of the load.
5. Turn on the power output and the load input. Delay a period of time, the overpower protection of the load will occur.
6. Close all instruments and finish the test.

Troubleshooting

Here are some common failures and their solutions. If the problem persists after following the listed steps, please contact **SIGLENT**.

1. The instrument cannot start up.

- (1) Check whether the power is correctly connected.
- (2) Check whether the power switch at the front panel is really on.
- (3) Remove the power cord and check whether the voltage selector is at the proper scale, whether the specification of the fuse is correct and whether the fuse is intact. If the fuse needs to be changed, refer to “**To Replace the Fuse**”.
- (4) If the problem remains, please contact **SIGLENT**.

2. The USB device cannot be identified.

- (1) Check whether the USB device is correctly working
- (2) Check whether the USB Host interface of the oscilloscope is correctly working
- (3) Make sure to use Flash U-disk. This oscilloscope cannot support hard drive disk devices
- (4) Make sure to use FAT32 system format
- (5) Restart the oscilloscope then insert the USB device
- (6) If the problem remains, please contact **SIGLENT**.

Contact SIGLENT

America

SIGLENT Technologies America, Inc
6557 Cochran Rd Solon, Ohio 44139
Tel: 440-398-5800
Toll Free:877-515-5551
Fax: 440-399-1211
info@siglent.com
www.siglentamerica.com

Headquarters

SIGLENT TECHNOLOGIES CO., LTD.
Blog No.4 & No.5, Antongda Industrial Zone, 3rd Liuxian Road, Bao'an
District, Shenzhen, 518101, China.
Tel:+ 86 755 3661 5186
Fax:+ 86 755 3359 1582
sales@siglent.com
www.siglent.com/ens

Europe

SIGLENT TECHNOLOGIES EUROPE GmbH
Liebigstrasse 2-20, Gebaeude 14, 22113 Hamburg Germany
Tel: +49(0)40-819-95946
Fax: +49(0)40-819-95947
info-eu@siglent.com
www.siglenteu.com