

SSG5000X/X-V Series RF Signal Generator

User Manual

EN02A



SIGLENT TECHNOLOGIES CO.,LTD

Contents

1	Introduction	1
2	Important Safety Information	2
2.1	General Safety Summary	2
2.2	Safety Terms and Symbols	4
2.3	Working Environment	4
2.4	Cooling Requirements	5
2.5	Power and Grounding Requirements	6
2.6	Cleaning	7
2.7	Abnormal Conditions	7
	Informations essentielles sur la sécurité	8
	Exigence de Sécurité	8
	Termes et symboles de sécurité	9
	Environnement de travail	10
	Exigences de refroidissement	11
	Connexions d'alimentation et de terre	12
	Nettoyage	13
	Conditions anormales	13
3	First Steps	14
3.1	Delivery Checklist	14
3.2	Quality Assurance	14
3.3	Maintenance Agreement	14
4	Document Conventions	15
5	Getting Started	16
5.1	Power On	16
5.2	Shut Down	16
5.3	System Information	16
5.4	Install Options	16
6	Quick Start	17
6.1	Front Panel Introduction	17
6.1.1	Function Keys	17
6.1.2	Direction Knob and Keys	18
6.1.3	Digital Keyboard	19

6.1.4	Key Backlight.....	20
6.1.5	Connectors	20
6.2	Rear Panel Introduction.....	22
6.3	User Interface	25
6.3.1	Prompt Status Bar	25
6.3.2	RF Frequency.....	26
6.3.3	RF Level	26
6.3.4	Touch Screen Display Area	26
6.4	Touch Operation	26
6.5	Parameter Settings.....	27
6.5.1	Numerical Input	27
6.5.2	Drop-Down Box Input.....	28
6.5.3	Switch Settings	28
6.6	Help Information	29
7	Application Examples.....	30
7.1	REMOTE and LOCAL Mode	30
7.2	Output RF Signal	30
7.3	Correcting 10MHz Reference.....	31
7.4	Use the Flatness Function to Correct Line Loss	32
7.5	Output a Modulated Signal.....	33
7.6	Output a Pulse Train.....	34
7.7	Output IQ Modulated Signal in Custom Mode	35
7.8	Test OIP3 of Active Devices in Multitone Mode	36
7.9	Play Waveform Sequence in ARB Mode.....	37
7.10	Add AWGN to Modulated Signal in ARB Mode	39
7.11	Download/Upload Files Using FTP (LAN).....	40
8	Front Panel Operation	43
8.1	Frequency.....	43
8.1.1	RF Display Frequency and Output Frequency.....	43
8.1.2	Frequency Offset.....	44
8.1.3	Phase Offset.....	44
8.1.4	RF State.....	44
8.2	Level	45
8.2.1	RF Display Level and Output Level.....	45
8.2.2	Level Offset.....	45
8.2.3	ALC State	46

8.2.4	Flatness	46
8.3	Sweep	50
8.3.1	Sweep State	50
8.3.2	Step Sweep	51
8.3.3	List Sweep	51
8.3.4	Sweep Direction	52
8.3.5	Sweep Mode.....	53
8.3.6	Trigger Mode	53
8.3.7	Point Trigger	54
8.3.8	Trigger Slope	55
8.3.9	About Sweep Conditions	55
8.4	Analog Modulation	56
8.4.1	Amplitude Modulation (AM).....	56
8.4.2	Frequency Modulation (FM)	58
8.4.3	Phase Modulation (PM).....	61
8.4.4	Pulse Modulation (PULSE).....	63
8.5	LF	70
8.5.1	LF Source	70
8.5.2	LF Sweep	71
8.6	Power Sensor	74
8.6.1	Parameter Settings.....	74
8.6.2	Level Control	77
8.7	IQ Modulation	79
8.8	UTILITY	80
8.8.1	System.....	80
8.8.2	File	87
8.9	Shortcut Keys	90
8.9.1	PRESET	90
8.9.2	HOME.....	97
8.9.3	ESC/Close	97
8.9.4	Trigger	98
8.9.5	MOD ON/OFF.....	98
8.9.6	RF ON/OFF	98
8.10	Custom	99
8.10.1	Custom State.....	99
8.10.2	Data Source.....	99
8.10.3	Modulation	100
8.10.4	Filter.....	103

8.10.5	Update	103
8.10.6	Save Waveform	104
8.11	ARB.....	105
8.11.1	ARB State	105
8.11.2	Select Waveform.....	105
8.11.3	Waveform Segment.....	105
8.11.4	Waveform Sequence	106
8.11.5	ARB Setup	109
8.11.6	Multi Carrier	111
8.11.7	Marker Utilities	115
8.11.8	Waveform Utilities	119
8.11.9	Trigger.....	122
8.11.10	Waveform Header.....	124
8.11.11	Waveform Segment File Type.....	126
8.12	Stream	128
8.12.1	About Stream File.....	128
8.12.2	Stream Setup.....	128
8.12.3	How to Play a Stream File.....	129
8.13	IoT.....	130
8.13.1	Protocol Introduction and Setup.....	130
8.13.2	Basic Waveform Setup.....	130
8.13.3	Marker Setup	131
8.13.4	IoT Trigger	132
8.14	Multitone	133
8.14.1	Multitone State.....	133
8.14.2	Tone Number	133
8.14.3	Sample Rate.....	133
8.14.4	Freq Spacing	133
8.14.5	Single Side	133
8.14.6	Save State	133
8.14.7	Load State	134
8.15	AWGN.....	135
8.15.1	AWGN State	135
8.15.2	Bandwidth.....	135
8.15.3	Example.....	135
8.16	I/Q Control	136
8.16.1	I/Q Mod State	136
8.16.2	I/Q Source	136

8.16.3	Compensation Channel.....	136
8.16.4	I/Q Adjustment.....	137
8.16.5	I/Q Output.....	137
8.16.6	I/Q Swap.....	138
9	IEEE 802.15.4 ZigBee.....	139
9.1	About ZigBee Protocol.....	139
9.2	ZigBee O-QPSK BPSK PHY.....	139
9.2.1	SHR Field.....	140
9.2.2	PHR Field.....	140
9.2.3	PHY Payload Field.....	141
9.3	User Interface Settings.....	143
9.3.1	General Settings.....	143
9.3.2	PPDU Settings.....	144
9.3.3	Impairments.....	147
9.3.4	ZigBee State.....	147
9.3.5	Save Waveform.....	147
9.3.6	Update.....	148
9.4	Example.....	148
9.4.1	Restore Factory Settings.....	148
9.4.2	Set the ZigBee Signal.....	148
9.4.3	Set the Carrier Signal.....	149
9.4.4	Turn On IQ Modulation and RF Output.....	149
9.4.5	Demod in Spectrum Analyzer.....	149
10	ITU-T G.9959 Z-Wave.....	150
10.1	About Z-Wave Protocol.....	150
10.1.1	Modulation and Encoding.....	150
10.1.2	Data Rates.....	150
10.2	Z-Wave PHY.....	151
10.2.1	Preamble Field.....	151
10.2.2	Start of Frame (SOF) Delimiter Field.....	151
10.2.3	PSDU Field.....	151
10.2.4	End of frame (EOF) delimiter field.....	152
10.3	User Interface Settings.....	153
10.3.1	General Settings.....	153
10.3.2	PPDU Settings.....	154
10.3.3	Impairments.....	157

10.3.4	Z-Wave State.....	157
10.3.5	Save Waveform	158
10.3.6	Update	158
10.4	Example.....	158
10.4.1	Restore Factory Settings.....	158
10.4.2	Set the Z-Wave Signal.....	158
10.4.3	Set the Carrier Signal	159
10.4.4	Turn On IQ Modulation and RF Output.....	159
10.4.5	Demod in Spectrum Analyzer.....	159
11	Remote Control.....	161
11.1	Remote Control via SCPI	161
11.2	Web Control.....	161
12	Troubleshooting.....	163

1 Introduction

The **SIGLENT** SSG5000X/X-V series is a benchtop RF signal source, with an output frequency range of 9 kHz to 6 GHz. It features light weight, small size, and convenient interface make it ideal for R&D, education, production and maintenance.

The series includes the following models:

Model	Frequency Range	
	CW MODE	IQ MODE
SSG5040X	9 kHz - 4 GHz	None
SSG5060X	9 kHz - 6 GHz	None
SSG5040X-V	9 kHz - 4 GHz	10 MHz - 4 GHz
SSG5060X-V	9 kHz - 6 GHz	10 MHz - 6 GHz

Features and Benefits:

- Frequency ranges from 9 kHz to 4 GHz/6 GHz
- 0.001 Hz frequency resolution
- Level output from -140 dBm to +26 dBm
- 0.01 dB level resolution
- Level accuracy ≤ 0.7 dB(typ.)
- Phase noise < -120 dBc/Hz @1 GHz, offset 20 kHz(typ.)
- Standard AM, FM and PM analog modulation with internal, external and Int+Ext source
- Pulse modulation, on/off ratio ≥ 0.7 dB (typ.)
- Pulse train generator(option)
- USB power meter measurement
- Support IQ modulation, output QAM, FSK, ASK, PSK, multitone and other modulation signals, support data source playback generated by Matlab
- Support the modulation of IEEE 802.15.4 ZigBee and ITU-T G.9959 Z-Wave
- Support the playback of protocol files and can generate 5G_NR, LTE, WLAN, WCDMA, GSM, BLUETOOTH and other communication protocol signals
- Support the generation and playback of waveform sequence
- Web remote control is supported, which is convenient for users to control devices remotely
- Equipped with a 5-inch (800x480) display and capacitive touch screen for easy and convenient operation
- Rich communication interfaces. Standard USB-Host, USB Device (USB-TMC), LAN (VXI-11, Socket, Telnet), optional GPIB

2 Important Safety Information

This manual contains information and warnings that must be followed by the user for safe operation and to keep the product in a safe condition.

2.1 General Safety Summary

Carefully read the following safety precautions to avoid personal injury and prevent damage to the instrument and any products connected to it. To avoid potential hazards, please use the instrument as specified.

To Avoid Fire or Personal Injury.

Use Proper Power Line.

Only use a local/state approved power cord for connecting the instrument to mains power sources.

Ground the Instrument.

The instrument grounds through the protective terra conductor of the power line. To avoid electric shock, the ground conductor must be connected to the earth. Make sure the instrument is grounded correctly before connect its input or output terminals.

Connect the Signal Wire Correctly.

The potential of the signal wire is equal to the earth, so do not connect the signal wire to a high voltage. Do not touch the exposed contacts or components.

Look over All Terminals' Ratings.

To avoid fire or electric shock, please look over all ratings and signed instructions of the instrument. Before connecting the instrument, please read the manual carefully to gain more information about the ratings.

Equipment Maintenance and Service.

When the equipment fails, please do not dismantle the machine for maintenance. The equipment contains capacitors, power supply, transformers, and other energy storage devices, which may cause high voltage damage. The internal devices of the equipment are sensitive to static electricity, and direct contact is easy to cause irreparable damage to the equipment. It is necessary to return to the factory or the company's designated maintenance organization for maintenance. Be sure to pull out the power supply when repairing the equipment. Live line operation is strictly prohibited. The equipment can only be powered on when the maintenance is completed and the maintenance is confirmed to be successful.

Not Operate with Suspected Failures.

If you suspect that there is damage to the instrument, please let qualified service personnel check it.

Avoid Circuit or Wire Exposed Components Exposed.

Do not touch exposed contacts or components when the power is on.

Do not operate in wet/damp conditions.

Do not operate in an explosive atmosphere.





Keep the surface of the instrument clean and dry.

The responsible body or operator should refer to the instruction manual to preserve the protection afforded by the equipment. If the equipment is used in a manner not specified by the manufacturer, the protection provided by the equipment may be impaired.

Any parts of the device and its accessories are not allowed to be changed or replaced, other than authorized by the manufacturer or agent.

2.2 Safety Terms and Symbols

When the following symbols or terms appear on the front or rear panel of the instrument or in this manual, they indicate special care in terms of safety.

	This symbol is used where caution is required. Refer to the accompanying information or documents to protect against personal injury or damage to the instrument.
	This symbol warns of a potential risk of shock hazard.
	This symbol is used to denote the measurement ground connection.
	This symbol is used to denote a safety ground connection.
	This symbol shows that the switch is an On/Standby switch. When it is pressed, the instrument's state switches between Operation and Standby. This switch does not disconnect the instrument's power supply. To completely power off the instrument, the power cord must be unplugged from the AC socket after the instrument is in the standby state.
CAUTION	The "CAUTION" symbol indicates a potential hazard. It calls attention to a procedure, practice, or condition which may be dangerous if not followed. Do not proceed until its conditions are fully understood and met.
WARNING	The "WARNING" symbol indicates a potential hazard. It calls attention to a procedure, practice, or condition which, if not followed, could cause bodily injury or death. If a WARNING is indicated, do not proceed until the safety conditions are fully understood and met.

2.3 Working Environment

Environment

The instrument is used indoors and should be operated in a clean and dry environment with an ambient temperature range.

NOTE: Direct sunlight, electric heaters, and other heat sources should be considered when evaluating the ambient temperature.

	WARNING: Do not operate the instrument in explosive, dusty, or humid environments.
---	---

Ambient Temperature

Operating: 0 °C to +50 °C

Non-operation: -20 °C to +70 °C

NOTE: Direct sunlight, radiators, and other heat sources should be taken into account when assessing the ambient temperature.

Humidity

0 °C to 30 °C, ≤ 95 %RH

30 °C to 50 °C, ≤ 75 %RH

Mains supply voltage fluctuations

Please refer to “Power and Grounding Requirements”.

Altitude

Operating: ≤ 3,000 m

Installation (overvoltage) Category

This product is powered by mains conforming to installation (overvoltage) Category II.

NOTE: Installation (overvoltage) category I refers to situations where equipment measurement terminals are connected to the source circuit. In these terminals, precautions are done to limit the transient voltage to a correspondingly low level.

Installation (overvoltage) category II refers to the local power distribution level which applies to equipment connected to the AC line (AC power).

Degree of Pollution

The product may be operated in environments of Pollution Degree II.

NOTE: Degree of Pollution II refers to a working environment that is dry and non-conductive pollution occurs. Occasional temporary conductivity caused by condensation is expected.

IP Rating

IP20 (as defined in IEC 60529).

2.4 Cooling Requirements

This instrument relies on the forced air cooling with internal fans and ventilation openings. Care must be taken to avoid restricting the airflow around the apertures (fan holes) at each side of the instrument.

To ensure adequate ventilation it is required to leave a 15 cm (6 inch) minimum gap around the sides of the instrument.



CAUTION: Do not block the ventilation holes located on both sides of the instrument.



CAUTION: Do not allow any foreign matter to enter the instrument through the ventilation holes, etc.

2.5 Power and Grounding Requirements

The instrument operates on single-phase 100 to 240 Vrms (+/-10%) AC power at 50/60 Hz (+/-5%), or single-phase 100 to 120 Vrms (+/-10%) AC power at 400 Hz (+/-5%).

No manual voltage selection is required because the instrument automatically adapts to line voltage.

Depending on the type and number of options and accessories, the instrument can consume up to 85 W of power.

NOTE: The instrument automatically adapts to the AC line input within the following ranges:

Voltage Range:	90 - 264 Vrms	90 - 132 Vrms
Frequency Range:	47 - 63 Hz	380 - 420 Hz

The instrument includes a grounded cord set containing a molded three-terminal polarized plug and a standard IEC320 (Type C13) connector for making line voltage and safety ground connection. The AC inlet ground terminal is connected directly to the frame of the instrument. For adequate protection against electrical shock hazards, the power cord plug must be inserted into a mating AC outlet containing a safety ground contact. Use only the power cord specified for this instrument and certified for the country of use.



WARNING: Electrical Shock Hazard!

Any interruption of the protective conductor inside or outside of the instrument, or disconnection of the safety ground terminal creates a hazardous situation.

Intentional interruption is prohibited.

The position of the instrument should allow easy access to the socket. To make the instrument completely power off, unplug the instrument power cord from the AC socket.

The power cord should be unplugged from the AC outlet if the instrument is not to be used for an extended period.



CAUTION: The outer shells of the front panel terminals (LF OUTPUT, RF OUTPUT) are connected to the instrument's chassis and therefore to the safety ground.

2.6 Cleaning

Clean only the exterior of the instrument, using a damp, soft cloth. Do not use chemicals or abrasive elements. Under no circumstances allow moisture to penetrate the instrument. To avoid electrical shock, unplug the power cord from the AC outlet before cleaning.



WARNING: Electrical Shock Hazard!
No operator serviceable parts inside. Do not remove covers.
Refer servicing to qualified personnel

2.7 Abnormal Conditions

Do not operate the instrument if there is any visible sign of damage or has been subjected to severe transport stresses.

If you suspect the instrument's protection has been impaired, disconnect the power cord and secure the instrument against any unintended operation.

Proper use of the instrument depends on careful reading of all instructions and labels.



WARNING: Any use of the instrument in a manner not specified by the manufacturer may impair the instrument's safety protection. This instrument should not be directly connected to human subjects or used for patient monitoring.

Informations essentielles sur la sécurité

Ce manuel contient des informations et des avertissements que les utilisateurs doivent suivre pour assurer la sécurité des opérations et maintenir les produits en sécurité.

Exigence de Sécurité

Lisez attentivement les précautions de sécurité ci - après afin d'éviter les dommages corporels et de prévenir les dommages aux instruments et aux produits associés. Pour éviter les risques potentiels, utilisez les instruments prescrits.

Éviter l'incendie ou les lésions corporelles.

Utilisez un cordon d'alimentation approprié.

N'utilisez que des cordons d'alimentation spécifiques aux instruments approuvés par les autorités locales.

Mettez l'instrument au sol.

L'instrument est mis à la Terre par un conducteur de mise à la terre de protection du cordon d'alimentation. Pour éviter un choc électrique, le conducteur de mise à la terre doit être mis à la terre. Assurez - vous que l'instrument est correctement mis à la terre avant de connecter les bornes d'entrée ou de sortie de l'instrument.

Connectez correctement le fil de signalisation.

Le potentiel de la ligne de signal est égal au potentiel au sol, donc ne connectez pas la ligne de signal à haute tension. Ne touchez pas les contacts ou les composants exposés.

Voir les cotes de tous les terminaux.

Pour éviter un incendie ou un choc électrique, vérifiez toutes les cotes et signez les instructions de l'instrument. Avant de brancher l'instrument, lisez attentivement ce manuel pour obtenir de plus amples renseignements sur les cotes.

Entretien du matériel.

En cas de défaillance de l'équipement, ne pas démonter et entretenir l'équipement sans autorisation. L'équipement contient des condensateurs, de l'alimentation électrique, des transformateurs et d'autres dispositifs de stockage d'énergie, ce qui peut causer des blessures à haute tension. Les dispositifs internes de l'équipement sont sensibles à l'électricité statique. Le contact direct peut facilement causer des blessures irrécupérables à l'équipement. L'équipement doit être retourné à l'usine ou à l'organisme de maintenance désigné par l'entreprise pour l'entretien. L'alimentation

électrique doit être retirée pendant l'entretien. La ligne ne doit pas être mise sous tension tant que l'entretien de l'équipement n'est pas terminé et que l'entretien n'est pas confirmé.

Ne pas fonctionner en cas de suspicion de défaillance.

Si vous soupçonnez des dommages à l'instrument, demandez à un technicien qualifié de vérifier.

L'exposition du circuit ou de l'élément d'exposition du fil est évitée.

Lorsque l'alimentation est connectée, aucun contact ou élément nu n'est mis en contact.

Ne pas fonctionner dans des conditions humides / humides.

Pas dans un environnement explosif.





Maintenez la surface de l'instrument propre et sec.

L'organisme ou l'opérateur responsable doit se référer au cahier des charges pour protéger la protection offerte par le matériel. La protection offerte par le matériel peut être compromise si celui-ci est utilisé de manière non spécifiée par le fabricant.

Aucune pièce du matériel et de ses annexes ne peut être remplacée ou remplacée sans l'autorisation de son fabricant.

Termes et symboles de sécurité

Lorsque les symboles ou termes suivants apparaissent sur le panneau avant ou arrière de l'instrument ou dans ce manuel, ils indiquent un soin particulier en termes de sécurité.

	Ce symbole est utilisé lorsque la prudence est requise. Reportez-vous aux informations ou documents joints afin de vous protéger contre les blessures ou les dommages à l'instrument.
	Ce symbole avertit d'un risque potentiel de choc électrique.
	Ce symbole est utilisé pour désigner la connexion de terre de mesure.
	Ce symbole est utilisé pour indiquer une connexion à la terre de sécurité.

	Ce symbole indique que l'interrupteur est un interrupteur marche / veille. Lorsqu'il est enfoncé, l'état de l'instruments bascule entre Fonctionnement et Veille. Ce commutateur ne déconnecte pas l'alimentation de l'appareil. Pour éteindre complètement l'instruments, le cordon d'alimentation doit être débranché de la prise secteur une fois l'instruments en état de veille.
CAUTION	Le symbole " CAUTION" indique un danger potentiel. Il attire l'attention sur une procédure, une pratique ou une condition qui peut être dangereuse si elle n'est pas suivie. Ne continuez pas tant que ses conditions n'ont pas été entièrement comprises et remplies.
WARNING	Le symbole " WARNING" indique un danger potentiel. Il attire l'attention sur une procédure, une pratique ou une condition qui, si elle n'est pas suivie, pourrait entraîner des blessures corporelles ou la mort. Si un AVERTISSEMENT est indiqué, ne continuez pas tant que les conditions de sécurité ne sont pas entièrement comprises et remplies.

Environnement de travail

Environnement

L'instrument doit être utilisé à l'intérieur dans un environnement propre et sec dans la plage de température ambiante.

NOTE: la lumière directe du soleil, les réchauffeurs électriques et d'autres sources de chaleur doivent être pris en considération lors de l'évaluation de la température ambiante.

	ATTENTION: ne pas utiliser l'instrument dans l'air explosif, poussiéreux ou humide.
---	--

Température ambiante

En fonctionnement: 0 °C à +50 °C

Hors fonctionnement: -20 °C à +70 °C

NOTE: pour évaluer la température de l'environnement, il convient de tenir compte des rayonnements solaires directs, des radiateurs thermiques et d'autres sources de chaleur.

Humidité

0 °C à 30 °C, ≤ 95 % HR

30 °C à 50 °C, ≤ 75 % HR

Fluctuation de la tension d'alimentation

Vérifiez s'il vous plaît "Connexions d'alimentation et de terre".

Altitude

Fonctionnement: ≤ 3000 m

Catégorie d'installation (surtension)

Ce produit est alimenté par une alimentation électrique conforme à l'installation (surtension) Catégorie II.

Installation (overvoltage) Category Definitions Définition de catégorie d'installation (surtension)

La catégorie II d'installation (surtension) est un niveau de signal applicable aux terminaux de mesure d'équipement reliés au circuit source. Dans ces bornes, des mesures préventives sont prises pour limiter la tension transitoire à un niveau inférieur correspondant.

La catégorie II d'installation (surtension) désigne le niveau local de distribution d'énergie d'un équipement conçu pour accéder à un circuit alternatif (alimentation alternative).

Degré de pollution

Un instruments peut être utilisé dans un environnement Pollution Degree II.

NOTE: Pollution Degree II signifie que le milieu de travail est sec et qu'il y a une pollution non conductrice. Parfois, la condensation produit une conductivité temporaire.

IP Rating

IP20 (as defined in IEC 60529).

Exigences de refroidissement

Cet instrument repose sur un refroidissement à air forcé avec des ventilateurs internes et des ouvertures de ventilation. Des précautions doivent être prises pour éviter de restreindre le flux d'air autour des ouvertures (trous de ventilateur) des deux côtés de la source de signal. Pour assurer une ventilation adéquate, il est nécessaire de laisser un espace minimum de 15 cm (6 pouces) sur les côtés de l'instrument.



ATTENTION: Ne bloquez pas les trous de ventilation de chaque côté de la source de signal.



ATTENTION: Ne laissez pas d'objets étrangers pénétrer dans la source de signal par les trous de ventilation, etc.

Connexions d'alimentation et de terre

L'instrument fonctionne avec une alimentation CA monophasée de 100 à 240 Vrms (+/- 10%) à 50/60 Hz (+/- 5%), ou monophasée 100 - 120 Vrms (+/-10 %) Alimentation CA à 400 Hz (+/-5%).

Aucune sélection manuelle de la tension n'est requise car l'instrument s'adapte automatiquement à la tension de ligne.

Selon le type et le nombre d'options et d'accessoires, l'instrument peut consommer jusqu'à 85 W d'énergie.

Remarque: l'instrument s'adapte automatiquement à l'entrée de ligne CA dans les plages suivantes:

Plage de tension:	90 - 264 Vrms	90 - 132 Vrms
Gamme de fréquences:	47 - 63 Hz	380 - 420 Hz

L'instrument comprend un jeu de cordons mis à la terre contenant une fiche polarisée à trois bornes moulée et un connecteur standard IEC320 (Type C13) pour établir la tension de ligne et la connexion de mise à la terre de sécurité. La borne de mise à la terre de l'entrée CA est directement connectée au châssis de l'instrument. Pour une protection adéquate contre les risques d'électrocution, la fiche du cordon d'alimentation doit être insérée dans une prise secteur correspondante contenant un contact de sécurité avec la terre. Utilisez uniquement le cordon d'alimentation spécifié pour cet instrument et certifié pour le pays d'utilisation.

	<p>Avertissement: risque de choc électrique!</p> <p>Toute interruption du conducteur de terre de protection à l'intérieur ou à l'extérieur de la portée ou la déconnexion de la borne de terre de sécurité crée une situation dangereuse.</p> <p>L'interruption intentionnelle est interdite.</p>
---	--

La position de l'instruments doit permettre un accès facile à la prise. Pour éteindre complètement l'instruments, débranchez le cordon d'alimentation de l'instrument de la prise secteur.

Si la source n'est pas utilisée pendant une période prolongée, débranchez le cordon d'alimentation de la prise secteur.

	<p>ATTENTION: les enveloppes extérieures des bornes du panneau avant (LF OUTPUT, RF OUTPUT) sont connectées au châssis de l'instrument et donc à la terre de sécurité.</p>
---	---

Nettoyage

Nettoyez uniquement l'extérieur de l'instrument à l'aide d'un chiffon doux et humide. N'utilisez pas de produits chimiques ou d'éléments abrasifs. Ne laissez en aucun cas l'humidité pénétrer dans l'instrument. Pour éviter les chocs électriques, débranchez le cordon d'alimentation de la prise secteur avant de le nettoyer.



Avertissement: risque de choc électrique!

Aucune pièce réparable par l'opérateur à l'intérieur. Ne retirez pas les capots.

Confiez l'entretien à un personnel qualifié.

Conditions anormales

Utilisez l'instrument uniquement aux fins spécifiées par le fabricant.

N'utilisez pas l'instrument s'il présente des signes évidents de dommages ou s'il a été soumis à de fortes contraintes de transport.

Si vous pensez que la protection de l'instruments a été altérée, débranchez le cordon d'alimentation et sécurisez l'instrument contre toute opération involontaire.

Une bonne utilisation de l'instrument nécessite la lecture et la compréhension de toutes les instructions et étiquettes.



Avertissement: Toute utilisation de l'instruments d'une manière non spécifiée par le fabricant peut compromettre la protection de sécurité de l'instrument. Cet instrument ne doit pas être directement connecté à des sujets humains ni utilisé pour la surveillance des patients.

3 First Steps

3.1 Delivery Checklist

First, verify that all items listed on the packing list have been delivered. If you note any omissions or damage, please contact your nearest **SIGLENT** customer service center or distributor as soon as possible. If you fail to contact us immediately in case of omission or damage, we will not be responsible for replacement.

3.2 Quality Assurance

The signal generator has a 3-year warranty from the date of shipment, during normal use and operation. **SIGLENT** can repair or replace any product that is returned to the authorized service center during the warranty period. We must first examine the product to make sure that the defect is caused by the process or material, not by abuse, negligence, accident, abnormal conditions, or operation.

SIGLENT shall not be responsible for any defect, damage, or failure caused by any of the following:

- a) Attempted repairs or installations by personnel other than **SIGLENT**.
- b) Connection to incompatible devices/incorrect connection.
- c) For any damage or malfunction caused by the use of non-**SIGLENT** supplies. Furthermore, **SIGLENT** shall not be obligated to service a product that has been modified. Spare, replacement parts and repairs have a 90-day warranty.

The instrument's firmware has been thoroughly tested and is presumed to be functional. Nevertheless, it is supplied without a warranty of any kind covering detailed performance. Products not made by **SIGLENT** are covered solely by the warranty of the original equipment manufacturer.

3.3 Maintenance Agreement

We provide various services based on maintenance agreements. We offer extended warranties as well as installation, training, enhancement and on-site maintenance, and other services through specialized supplementary support agreements. For details, please consult your local **SIGLENT** customer service center or distributor.

4 Document Conventions

For convenience of description, this article makes the following conventions:

- Text surrounded by a box border is used to represent the front panel buttons. For example, **FREQ** represents the "FREQ" button on the front panel.
- Italicized text with shading is used to represent the touchable or clickable menu/button/region on the touch screen. For example, *AM Shape* represents the "AM Shape" setting items on the screen:

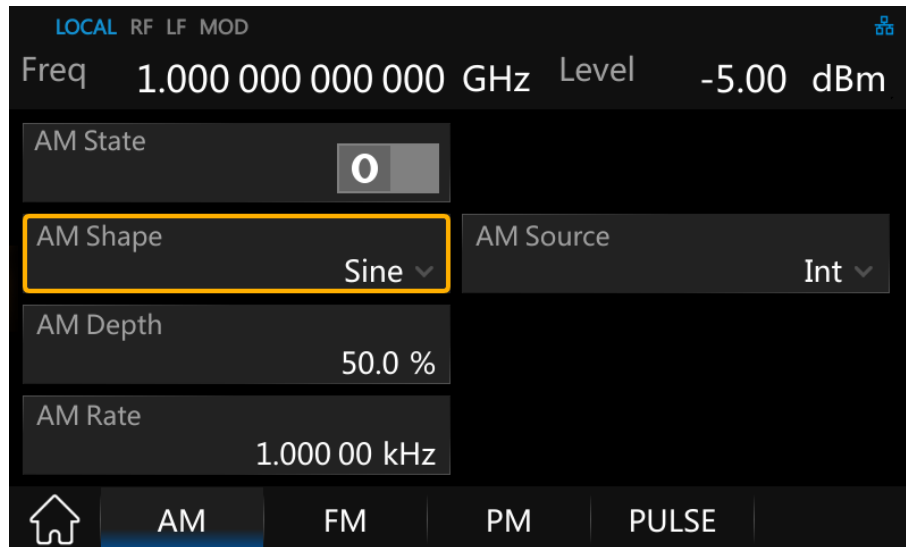

- Bold Text with square brackets is used to represent connectors, such as **[RF OUTPUT 50Ω]** indicating the RF output connector on the front panel.
- For the operations that contain multiple steps, the description is in the form of "Step 1 > Step 2 >...". As an example, follow each step in the sequence to enter the upgrade interface:

UTILITY > *System* > *Update*

Press the **UTILITY** button on the front panel as step 1, choose the *System* group on the screen as step 2, and click the *Update* option on the screen as step 3 to enter the upgrade interface.

5 Getting Started

5.1 Power On

The RF signal source provides two power-on methods, namely:

Power On Line

When the "Power On Line" function is enabled, the RF signal source only needs to be connected to the AC power supply through the power cord to power on.

The steps to set the "Power On Line" enable are:

UTILITY > **System** > **Setting** > **Power On Line**

Power On Manually

When the "Power On Line" function is not enabled, after the RF signal source is connected to the AC power supply through the power cord, you need to manually press the power button to turn on the signal source.

5.2 Shut Down

Press the power button for two seconds to turn off the signal source. Or follow the steps below:

UTILITY > **System** > **Shutdown**

NOTE: After pressing the power off button, the RF signal source is still in standby mode. If you no longer want the RF signal source to consume power, completely power down the instrument by unplugging the instrument power cord from the AC outlet.

5.3 System Information

Follow the steps below to examine the software and hardware versions of the signal source.

UTILITY > **System** > **System Info**

See the section "System Info" for details.

5.4 Install Options

A license is necessary to unlock a software option. See the section "Option" for details.

6 Quick Start

6.1 Front Panel Introduction

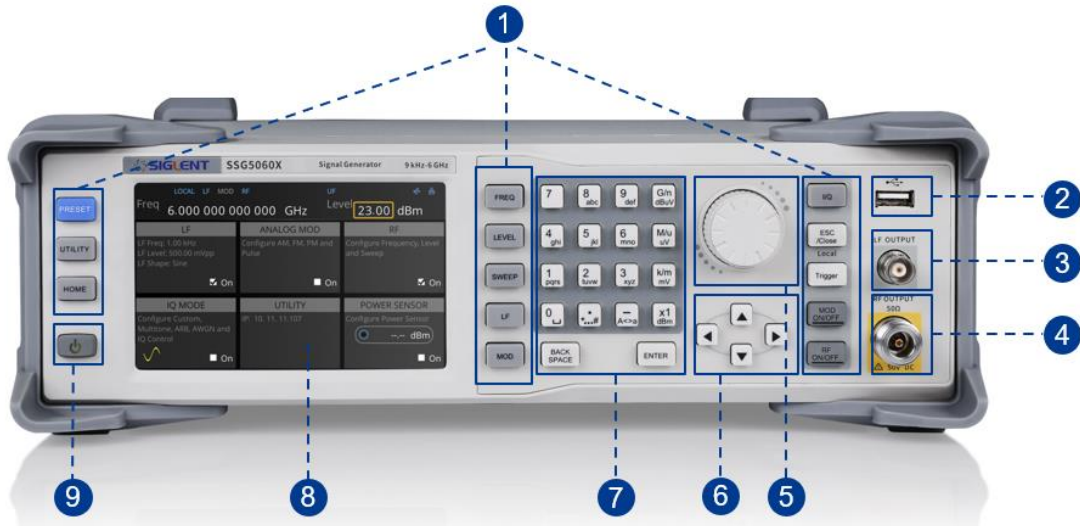

Figure 6-1 the Front Panel

- | | |
|------------------|------------------------------|
| 1. Function keys | 6. Direction key |
| 2. USB Host | 7. Digital keyboard |
| 3. LF output | 8. Touch screen display area |
| 4. RF output | 9. Power button |
| 5. Knob | |

6.1.1 Function Keys

Table 6-1 Function keys description

Control Keys	Description
FREQ	Set frequency, frequency offset, phase offset and other related parameters
LEVEL	Set level, level offset, ALC state, flatness and other related parameters
SWEEP	Set sweep state, step sweep, list sweep, sweep direction and other related parameters

LF	Set LF state, LF level, LF frequency and other related parameters
MOD	Set analog modulation parameters (AM, FM, PM and PULSE)
I/Q	Set IQ related parameters
ESC /Close	During the parameter editing process, pressing this key will clear the input of the active function area and exit the parameter input state Press this key to return to local control if previously controlling the instrument remotely
Trigger	When the trigger type is set to Key, press this button to perform one operation
MOD ON/OFF	The main switch of various modulation modes
RF ON/OFF	RF signal output switch
PRESET	Press this button to revert to the default parameters. The default parameters refer to the default parameter table
UTILITY	System and file related operations
HOME	You can get back to the main interface quickly

6.1.2 Direction Knob and Keys

1. Direction knob

Rotate left and right to increase or decrease the value of the active parameter, or adjust the focus position in non-parametric input state. Pressing it down is equal to "Enter".

2. Direction keys

In the non-parametric input state, press the up, down, left and right direction keys to move the focus frame in sequence.

Press the knob in the parameter input area, the cursor will focus to a certain position, then press the left and right direction keys to change the position of the cursor, and use the up and down keys to fine tune the value of the cursor position.

6.1.3 Digital Keyboard

The front panel of the RF signal source provides a numeric keypad, as shown below. The keyboard supports English uppercase and lowercase characters, numbers and common symbols (including decimal point, space, negative sign and !, @, #, \$, %, ^, &, *), mainly for editing the name of files or folders and setting parameters (refer to the "Parameter Settings" section).



Figure 6-2 Digital keyboard

Table 6-2 Digital keys description

Control Keys	Description
	Digit 0 and space bar switch
	In the English state, enter the special symbol !, @, #, \$, %, ^, &, *. In the digital state, enter the decimal point
	In the digital state, enter the "-" sign. In the English state input for case switching
	When setting the amplitude, press this key to set the unit as dBuV. When setting the frequency, press this key to set the unit as GHz. If the input is a time-related parameter, press this key to set the unit as ns
	When setting the amplitude, press this key to set the unit as uV. When setting the frequency, press this key to set the unit as MHz. If the input is a time-related parameter, press this key to set the unit as us

<div style="border: 1px solid black; padding: 2px; width: fit-content;">K/m mV</div>	<p>When setting the amplitude, press this key to set the unit as MV. When setting the frequency, press this key to set the unit as kHz. If the input is a time-related parameter, press this key to set the unit as ms</p>
<div style="border: 1px solid black; padding: 2px; width: fit-content;">x1 dBm</div>	<p>When setting the amplitude, press this key to set the unit as dBm. When setting the frequency, the unit selected will be Hz. If the input is time, the unit will be set to s</p>
<div style="border: 1px solid black; padding: 2px; width: fit-content;">BACK SPACE</div>	<p>During the parameter editing process, pressing this key will delete the character to the left of the cursor</p>
<div style="border: 1px solid black; padding: 2px; width: fit-content;">ENTER</div>	<p>In the parameter input process, pressing this key will end the parameter input and add the currently set unit for the parameter</p>

6.1.4 Key Backlight

1. Power switch 

Orange light constantly on indicates the instrument is in stand-by state.

Green light constantly on indicates the instrument is in power on state.

2.

MOD
ON/OFF

When the MOD ON/OFF is set to turn on the modulation, the backlight will illuminate. If modulation is off, the backlight will be dark.

3.

RF
ON/OFF

When the RF signal is turned on, the backlight is on. If the RF signal output is turned off, the backlight will be dark.

6.1.5 Connectors

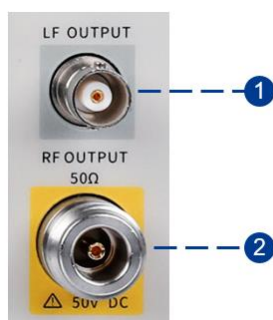

Figure 6-3 Front Panel Connectors

1. LF OUTPUT

Output the LF (low frequency) signal. The output can also be configured to source the modulation waveform for FM and PM modulation types.

Type: female BNC.

Impedance: 50 Ω .

2. RF OUTPUT

Output the RF signal.

Type: female N.

Impedance: 50 Ω .

**CAUTION**

Damage Levels: 50 Vdc; +30 dBm maximum RF power at frequency greater than 1 MHz.

6.2 Rear Panel Introduction

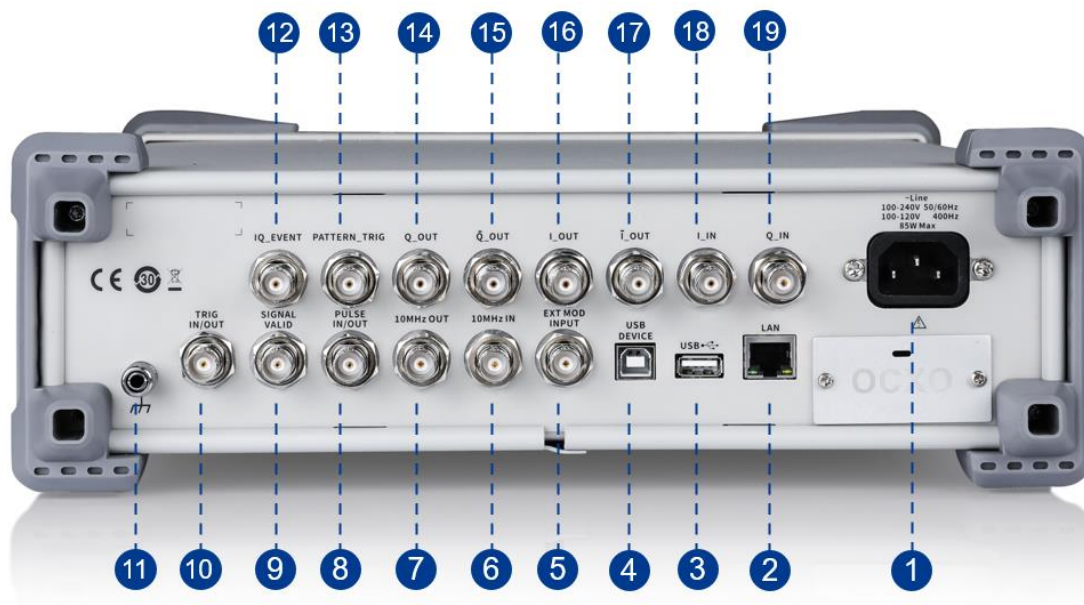

Figure 6-4 the Rear Panel

1. AC power input terminal

The RF signal source can operate with AC power from 100-240 V, 50/60 Hz or 100-120 V, 400 Hz. Please connect the RF signal source to the AC power supply with the supplied power cord.

2. LAN interface

The RF signal source can be connected to a network through the interface and remotely controlled.

3. USB host

The RF signal source can be used as the “main device” to connect to an external USB device, like a USB RF power meter. The interface reads the data or state file in the U disk, or stores the current instrument state or data in the U disk.

4. USB device interface

The interface can be connected to a compatible computer and controlled by software on the host computer.

5. EXT MOD INPUT

Input BNC connection for external modulation.

6. 10MHZ IN

The [10MHZ IN] and [10MHZ OUT] connectors are commonly used to establish synchronization

between multiple instruments.

The RF source can use the internal reference source or an external reference source.

If the instrument detects that there is a valid 10MHz signal at the **[10MHZ IN]** connector, it will use it as an external reference source. At this point the user interface status bar shows "Ext Ref". When an external reference is lost, exceeded, or disconnected, the instrument automatically switches to the internal reference, and the screen status bar will no longer display "Ext Ref".

7. 10MHz OUT

The **[10MHZ OUT]** and **[10MHZ IN]** connectors are commonly used to establish synchronization between multiple instruments.

The RF source can use the internal or an external reference source.

If the instrument uses the internal reference source, the **[10MHz OUT]** connector can output a 10 MHz clock signal generated by the instrument and can be used to synchronize other devices.

8. PULSE IN/OUT

The function of the connector is determined by the current mode of pulse modulation.

- PULSE IN: When the pulse source is "Ext", it is used to input external pulse signals.
- PULSE OUT: When the Pulse modulation source is "Int" and the pulse output switch is turned on, it is used to output the pulse signal generated by the internal generator. The output signal is related to "Pulse Mode", and can be set to "Single", "Double" or "Train".

9. SIGNAL VALID

When the RF output frequency or amplitude is modified, the RF output connector of the front panel outputs the RF signal at the specified frequency and amplitude after a certain response and processing time in the internal circuit of the instrument. In this process, the **[SIGNAL VALID]** connector outputs an impulse synchronization signal to indicate the validity of the RF output signal:

- High level (3.3 V): Indicates that the RF signal is being configured.
- Low level (0 V): Indicates that the RF signal is stable (effective).

10. TRIG IN/OUT

When PULSE trigger source is "Int ", the connector can be used to output the trigger signal.

When the RF Sweep, LF Sweep, or PULSE trigger source is "Ext", the connector is used to input the external trigger signal.

11. Ground

The system ground terminal.

12. IQ_EVENT

Output on this connector occurs whenever Marker is on in an Arb-based waveform.

- Marker level \approx 3.3 V (positive polarity selected),
- Marker level = 0 V (negative polarity selected).

13. PATTERN_TRIG

When the IQ ARB trigger source is "Ext", the connector is used to input the external trigger signal.

14. Q_OUT

Output the analog, in-phase component of I/Q modulation from the internal baseband generator when the internal IQ modulation mode is on.

15. \bar{Q} _OUT

Used in conjunction with the Q_OUT connector to provide a balanced baseband stimulus.

16. I_OUT

Output the analog, quadrature-phase component of I/Q modulation from the internal baseband generator when the internal IQ modulation mode is on.

17. \bar{I} _OUT

Used in conjunction with the I_OUT connector to provide a balanced baseband stimulus.

18. I INPUT

Used to input an external modulated I baseband signal when the external IQ modulation mode is on.

19. Q INPUT

Used to input an external modulated Q baseband signal when the external IQ modulation mode is on.

Note: Only models equipped with the IQ modulation function have IQ modulation-related connectors on the rear panel.

6.3 User Interface

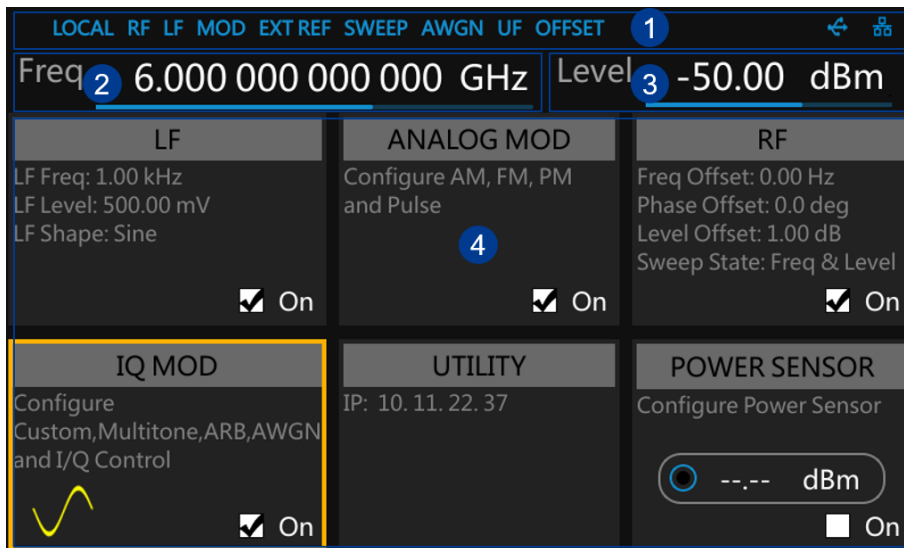





Figure 6-5 the User Interface

- | | |
|----------------------|--|
| 1. Prompt status bar | 4. Touch screen display area:
Display the settings under
each menu |
| 2. RF frequency | |
| 3. RF level | |

6.3.1 Prompt Status Bar

- Display LOCAL (local), or REMOTE (remote). When REMOTE is displayed, the instrument is being controlled by a remote computer and the front panel input will be locked. To unlock the front panel (enter LOCAL mode), press  or send "SYSTEM:REMOte 0" to quit.
- RF: The RF output state.
- LF: Low frequency signal generator state.
- MOD: The modulation state.
- EXT REF: EXT REF shows that the SSG is using an external 10 MHz reference.
- SWEEP: The status of the sweep state.
- AWGN: The status of the Additive White Gaussian Noise (AWGN) to a carrier when IQ Modulation.
- UF: Level flatness function enabled.
- OFFSET: Level offset enabled.
-  The identification is displayed when a USB disk is inserted.
- LAN: LAN state.  Indicates that LAN is successfully connected.  Indicates that there is no network connection or network connection failed.

6.3.2 RF Frequency

RF output frequency setting. When the sweep type is "Freq" or "Freq & Level", the frequency sweeping progress bar is displayed.

6.3.3 RF Level

RF output level setting. When the sweep type is "Level" or "Freq & Level", level sweeping progress bar is displayed.

6.3.4 Touch Screen Display Area

Touch screen display area displays the settings under each menu.

- LF: LF output state, LF waveform and LF sweep related parameters can be set. Sine, Square, Sawtooth, Triangle and DC can be set up.
- ANALOG MOD: Analog Modulation state. Amplitude modulation, frequency modulation, phase modulation, or pulse can be set.
- RF: RF output state. Frequency, level or RF sweep can be set.
- IQ MOD: I/Q modulation state. IQ modulation can be set.
- UTILITY: System and file related parameters can be set.
- POWER SENSOR: Power sensor state and power sensor related parameters can be set.

6.4 Touch Operation

The RF signal source provides a 5-inch capacitive touch screen to support various gesture operations, including:

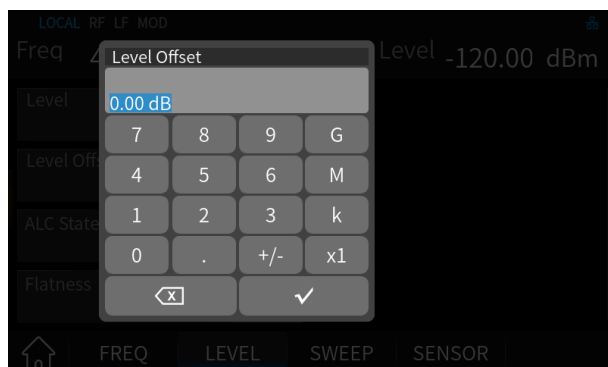

Click on the screen parameters or menu to pop up a virtual keyboard where you can edit the parameters.

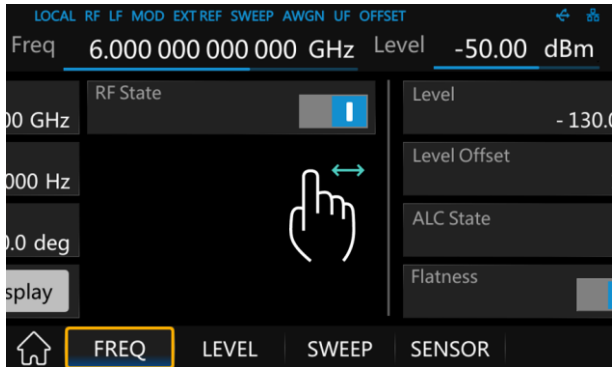

Left or right slide switches menus.

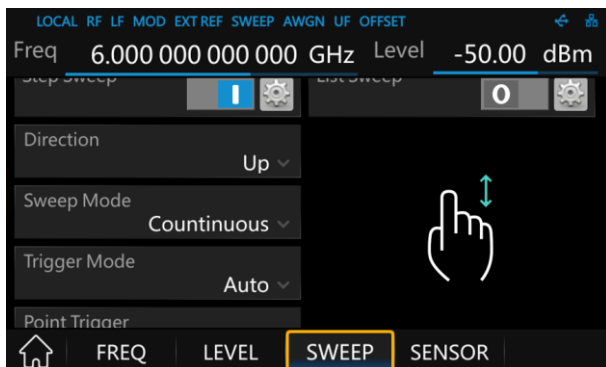

Up or down slides the display menu.

6.5 Parameter Settings

The parameter settings of the RF signal source include numerical input, drop-down box input and switch settings.

6.5.1 Numerical Input

Numerical input can be done through keys and numeric keypad, keys and knob/direction keys, or touch screen. The following takes setting the frequency offset to 100 MHz as an example to introduce three numerical input methods.

1. Use keys and numeric keypad
 - 1) Press the **FREQ** button on the front panel to enter the frequency parameter setting area.
 - 2) Rotate the knob or press the direction keys to focus on the **Frequency Offset** parameter in the parameter setting area.
 - 3) Use the front panel numeric keypad to enter the value "100".
 - 4) Press the **M/u** button to set the unit to MHz.
2. Using the buttons and knob/directional keys
 - 1) Press the **FREQ** button on the front panel to enter the frequency parameter setting area.

- 2) Rotate the knob or press the direction keys to focus on the **Frequency Offset** parameter in the parameter setting area.
 - 3) Press the **ENTER** button or knob to enter the editing state of the parameters.
 - 4) Adjust the left and right direction keys to select the number of parameter digits to be adjusted.
 - 5) Rotate the knob or press the up and down direction keys to change the parameter value until the desired parameter value is obtained.
 - 6) Press the **ENTER** button or knob to confirm the parameter value.
3. Use the touch screen
 - 1) Starting from the main interface, click **RF** Module > **Frequency** > **Frequency Offset**. A virtual keyboard for setting parameters will pop up.
 - 2) Enter 100 on the virtual keyboard, and then select the unit MHz.

6.5.2 Drop-Down Box Input

The input in the drop-down box can be entered through buttons, knobs/direction keys, or touch screen. The following takes setting the ALC status value as an example to introduce two drop-down box input methods.

1. Using the buttons and knob/directional keys
 - 1) Press the **LEVEL** button on the front panel to enter the amplitude parameter setting area.
 - 2) Rotate the knob or press the direction keys to focus on the **ALC State** parameter in the parameter setting area.
 - 3) Press the **ENTER** button or knob to open the drop-down box,
 - 4) Rotate the knob or press the direction keys to select the drop-down box option.
 - 5) Press the **ENTER** button or knob to confirm the option.
2. Use the touch screen
 - 1) Starting from the main interface, click **RF** Module > **LEVEL** > **ALC State**, and the drop-down box will open.
 - 2) Click the option in the drop-down box.

6.5.3 Switch Settings

The switch status can be set through buttons and knobs/direction keys, or the touch screen. When the switch button is on the right and is blue, it is on. When the switch button is on the left and gray, it means off.

The following takes setting the flatness switch as an example to introduce two switch setting methods.

1. Using the buttons and knob/directional keys
 - 1) Press the **LEVEL** button on the front panel to enter the level parameter setting area.
 - 2) Rotate the knob or press the direction keys to focus on the Flatness switch **0** in the parameter setting area.
 - 3) Press the **ENTER** button or knob to switch the switch state.
2. Use the touch screen
 - 1) Starting from the main interface, click **RF** Module > **LEVEL** > **Flatness** **0**,
 - 2) Click the switch to toggle the switch state.

6.6 Help Information

The RF signal source has a built-in help system that provides help information for each function and menu.

1. Press the **UTILITY** key and select **Help** to enter help information page.
2. Click to enter the corresponding directory to view.

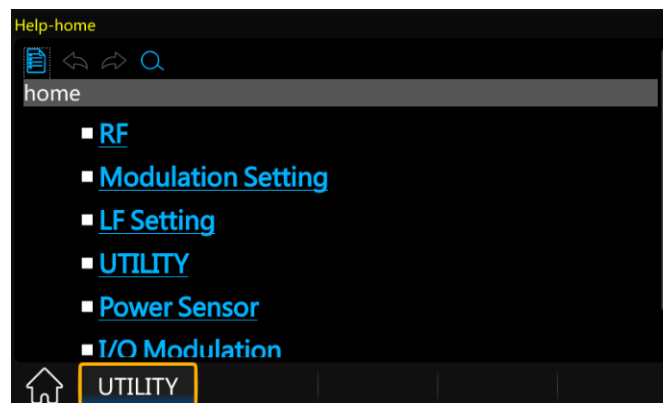

7 Application Examples

7.1 REMOTE and LOCAL Mode

When the signal generator is controlled by a remote computer, the instrument will be in REMOTE mode and the front panel input will be locked.

As shown below, the “REMOTE” icon appears in the status bar, and if you touch the screen or press any key in the front panel, a warning box will appear.

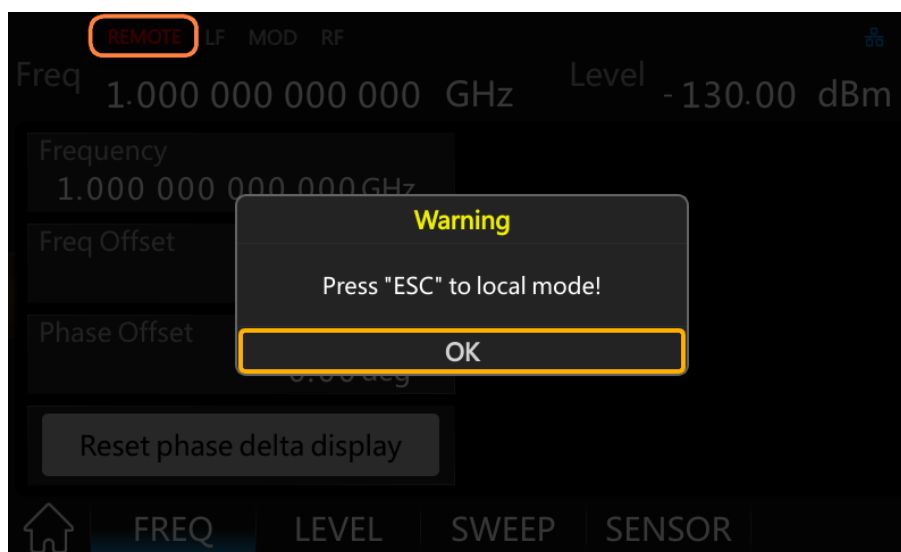

To unlock the front panel, namely, to enter LOCAL mode, there are two ways:

- Press ESC/Close in the front panel to quit.
- Send SCPI command “SYSTem:REMOte 0”.

After exiting the REMOTE mode, the “LOCAL” icon will appear in the status bar.

7.2 Output RF Signal

The following takes the output of a radio frequency signal with a frequency of 3 GHz and an amplitude of 0 dBm from the [RF OUTPUT 50Ω] connector as an example.

1. Restore factory settings
 - 1) Press the **UTILITY** button or click **UTILITY** module > **Setting** > **Preset Type** on the touch screen to set the reset type to default;
 - 2) Press the **PRESET** button or click **UTILITY** module > **Preset** on the touch screen to perform the reset operation.
2. Set the frequency

Press the **FREQ** button and use the numeric keyboard to enter 3 GHz, or click the frequency input box on the touch screen to pop up the virtual keyboard and enter 3 GHz on the virtual keyboard.

3. Set the amplitude

Press the **LEVEL** button and use the numeric keyboard to enter 0 dBm, or click the level input box on the touch screen to pop up the virtual keyboard and enter 0 dBm on the virtual keyboard.

4. Turn on RF output

Press **RF ON/OFF** button to turn on the RF output, or press **HOME** > **RF** module > **On** to turn on the RF output. After turning on the RF output, the **RF ON/OFF** button light turns on, and the "RF" icon in the status bar turns blue.

At this time, the **[RF OUTPUT 50Ω]** connector outputs a radio frequency signal with a frequency of 3 GHz and an amplitude of 0 dBm.

7.3 Correcting 10MHz Reference

Using a high-accuracy frequency meter, the RF signal source can correct the accuracy of the 10 MHz reference signal through the reference correction function. The 10 MHz reference signal is generated by the clock reference source TCXO or OCXO of the RF signal source and is output from the **[10MHz OUT]** connector. Connect the **[10MHz OUT]** connector to the frequency meter and adjust the reference oscillator codeword until the accuracy of the 10 MHz reference signal reaches the target value.

Note: The SSG5000X/X-V series is equipped with a TCXO clock reference source as standard. Users can purchase the 10M_OCXO_L option before the machine leaves the factory to obtain a high-precision clock reference source OCXO.

1. Restore factory settings

- 1) Press the **UTILITY** button or click **UTILITY** module > **Setting** > **Preset Type** on the touch screen to set the reset type to default;
- 2) Press the **PRESET** button or click **UTILITY** module > **Preset** on the touch screen to perform the reset operation.

2. Set the reference oscillator code

- 1) Press **UTILITY** or click **UTILITY** > **Setting** > **10M Adjustment** >  on the touch screen to enter the "Ref Osc setting" page.

- 2) Turn on the **10M Adjustment** switch. At this time, the clock reference will use the code set in **Ref Osc Code**. If the reference calibration is off, the clock reference will use the default code.
 - 3) Click **Ref Osc Code** to pop up the virtual keyboard and set the code.
3. Correcting 10 MHz reference
- The frequency of the reference signal can be modified through the codeword. According to the frequency measured by the frequency meter, increase or decrease the reference oscillator codeword, and repeat the operation until the 10MHz reference signal output by the clock reference source meets the accuracy requirements.

7.4 Use the Flatness Function to Correct Line Loss

In conjunction with a power meter, RF signal sources can use the flatness function to correct for line loss.

Connect the **[RF OUTPUT 50Ω]** connector of the RF signal source to the cable under test, and connect the end of the cable to the power meter. Plug the power meter into the USB port of the RF signal source and wait for the power meter connection to complete.

1. Restore factory settings
 - 1) Press the **UTILITY** button or click **UTILITY** module > **Setting** > **Preset Type** on the touch screen to set the reset type to default;
 - 2) Press the **PRESET** button or click **UTILITY** module > **Preset** on the touch screen to perform the reset operation.
2. Set the frequency and amplitude
 - 1) Press the **FREQ** button and use the numeric keyboard to enter 1 GHz, or click the frequency input box on the touch screen to pop up the virtual keyboard and enter 1 GHz on the virtual keyboard.
 - 2) Press the **LEVEL** button and use the numeric keyboard to enter 0 dBm, or click the level input box on the touch screen to pop up the virtual keyboard and enter 0 dBm on the virtual keyboard.
3. Set the frequency of flatness calibration
 - 1) Press **LEVEL** > **Flatness** >  > **Setting**, and select the **Fill Type** as "Manual Step";
 - 2) Set **Start Freq** to 4 GHz, **Stop Freq** to 5 GHz, and **Points** to 11.
4. Perform amplitude calibration

Click **Fill Flatness with Sensor** button and a “Collecting” dialog will pop up.

After the data collection is completed, the user interface will automatically return to the flatness list page and give the amplitude correction value of each frequency.

7.5 Output a Modulated Signal

The following takes amplitude modulation as an example to introduce the output of an analog modulation signal: the carrier frequency is 1 GHz, the carrier amplitude is -10 dBm, the AM modulation depth is 80%, the modulation frequency is 10 kHz, and the modulation waveform is a sine wave.

1. Restore factory settings
 - 1) Press the **UTILITY** button or click **UTILITY** module > **Setting** > **Preset Type** on the touch screen to set the reset type to default;
 - 2) Press the **PRESET** button or click **UTILITY** module > **Preset** on the touch screen to perform the reset operation.
2. Set carrier frequency and amplitude
 - 1) Press the **FREQ** button and use the numeric keyboard to enter 1 GHz, or click the frequency input box on the touch screen to pop up the virtual keyboard and enter 1 GHz on the virtual keyboard.
 - 2) Press the **LEVEL** button and use the numeric keyboard to enter -10 dBm, or click the level input box on the touch screen to pop up the virtual keyboard and enter -10 dBm on the virtual keyboard.
3. Set the AM modulation parameters
Press **MOD** or click **ANALOG MOD** > **AM** on the touch screen to enter the amplitude modulation parameter setting interface.
 - 1) Set **AM Shape** to Sine;
 - 2) Set **AM Depth** to 80%;
 - 3) Set **AM Rate** to 10 kHz;
 - 4) Turn on **AM State** ;
4. Turn on analog modulation and RF output
 - 1) Press the **MOD ON/OFF** button, the button light turns on, and the MOD icon in the status bar of the user interface changes from gray to blue;
 - 2) Press the **RF ON/OFF** button, the button light turns on, and the RF icon in the status bar of the user interface changes from gray to blue.

At this time, the **[RF OUTPUT 50Ω]** connector outputs the modulated RF signal in the current configuration.

7.6 Output a Pulse Train

The following steps describe how to output a user-defined pulse sequence from the **[PULSE IN/OUT]** connector on the rear panel of the RF signal source. The specific setting parameters of the pulse sequence are shown in the table below.

Serial number	Positive pulse width	Negative pulse width	Repetitions
1	10ms	30ms	1
2	20ms	20ms	2

- Restore factory settings
 - Press the **UTILITY** button or click **UTILITY** module > **Setting** > **Preset Type** on the touch screen to set the reset type to default;
 - Press the **PRESET** button or click **UTILITY** module > **Preset** on the touch screen to perform the reset operation.
- Install the pulse sequence generator option

Press **UTILITY** > **Option** to enter the option installation interface, select "SSG5000X-PT" and enter the correct activation code, then click the **Install** button. The RF signal source will automatically install the pulse sequence generator option.
- Edit pulse list

Press **MOD** or click **ANALOG MOD** > **PULSE** on the touch screen to enter the pulse modulation parameter setting interface.

 - Set **Pulse Mode** to Train,
 - Click **Pulse Train** >  to enter the pulse sequence editing interface, set the **On Time** of the first pulse to 10 ms, the **Off Time** to 30 ms, and the **Count** to 1;
 - Click **Add** to add a row, set the **On Time** to 20 ms, the **Off Time** to 20 ms, and the **Count** to 2.
- Turn on pulse modulation and pulse output

Return to pulse modulation setting interface,

 - Turn on the **Pulse Out** switch,
 - Turn on the **Pulse State** switch.

5. Turn on analog modulation

Press the **MOD ON/OFF** button, the button light turns on, and the MOD icon in the status bar of the user interface changes from gray to blue.

At this time, the **[PULSE IN/OUT]** connector outputs the pulse train signal configured as above.

7.7 Output IQ Modulated Signal in Custom Mode

The following steps describe how to generate an IQ modulated signal with a modulation mode of 32QAM. Users can modify and configure IQ modulation related parameters according to actual application requirements.

1. Restore factory settings

- 1) Press the **UTILITY** button or click **UTILITY** module > **Setting** > **Preset Type** on the touch screen to set the reset type to default;
- 2) Press the **PRESET** button or click **UTILITY** module > **Preset** on the touch screen to perform the reset operation.

2. Set the baseband signal

- 1) Press **I/Q** or select **IQ MOD** block from the home page, and then click **Custom**.
- 2) Open the **Data Source** setting interface, and set **Data Setup** to PN9, **Symbol Rate** to 1MHz, and **Symbol Length** to 512.
- 3) Open the **Modulation** setting interface, and set **Mod Type** to QAM, **QAM Type** to 32QAM.
- 4) Open the **Filter** setting interface, and set **Filter Type** to RootCosine, **Filter Alpha** to 0.35, **Filter Length** to 128, **OverSampling** to 2.
- 5) Turn on **Custom State**.

3. Set carrier frequency and amplitude

- 1) Press the **FREQ** button and use the numeric keyboard to enter 1 GHz, or click the frequency input box on the touch screen to pop up the virtual keyboard and enter 1 GHz on the virtual keyboard.
- 2) Press the **LEVEL** button and use the numeric keyboard to enter 0 dBm, or click the level input box on the touch screen to pop up the virtual keyboard and enter 0 dBm on the virtual keyboard.

4. Turn on IQ modulation and RF output

- 1) Press **MOD ON/OFF** button to turn on IQ modulation.
- 2) Press **RF ON/OFF** button to turn on RF output.

At this time, the **[RF OUTPUT 50Ω]** connector outputs an IQ modulation signal with a modulation mode of 32QAM, and the IQ modulation signal is connected to an IQ demodulation device to observe the demodulation characteristics of the IQ modulation signal:

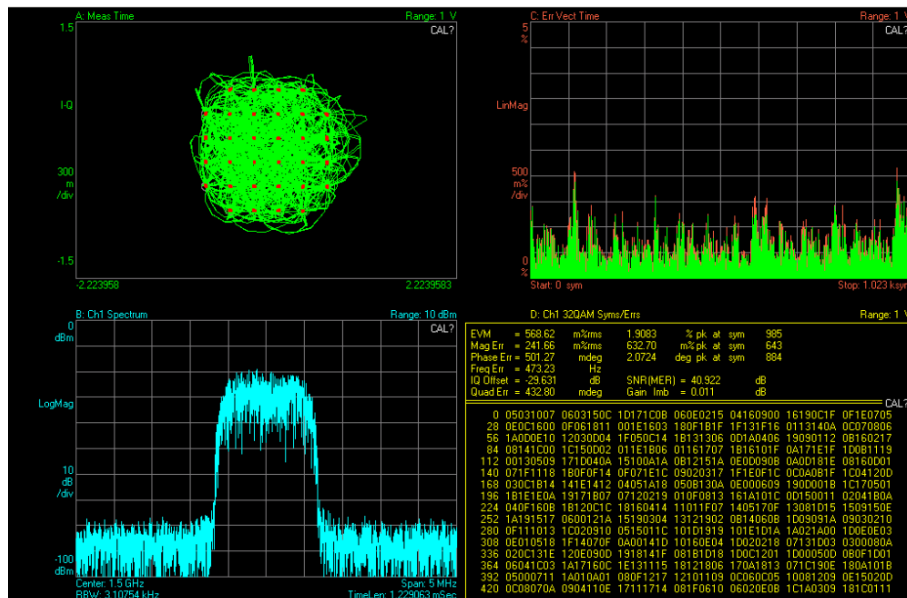

7.8 Test OIP3 of Active Devices in Multitone Mode

OIP3 is a key indicator for evaluating the linearity of active devices. This can be tested using the SSG5000X-V. The following steps describe how to generate a two-tone continuous wave signal with a carrier frequency of 3.2 GHz and an interval frequency of 1 MHz to test OIP3 of the active device.

- Restore factory settings
 - Press the **[UTILITY]** button or click **UTILITY** module > **Setting** > **Preset Type** on the touch screen to set the reset type to default;
 - Press the **[PRESET]** button or click **UTILITY** module > **Preset** on the touch screen to perform the reset operation.
- Set the baseband signal
 - Press **[I/Q]** or select **IQ MOD** block from the home page, and then click **Multitone**.
 - Set **Tone Number** to 1;
 - Set **Sample Rate** to 10 MHz;
 - Set **Freq Spacing** to 1 MHz;
 - Turn off **Single Side** state;
 - Turn on **Multitone State**;
- Set carrier frequency and amplitude

- 1) Press the **FREQ** button and use the numeric keyboard to enter 3.2 GHz, or click the frequency input box on the touch screen to pop up the virtual keyboard and enter 3.2 GHz on the virtual keyboard.
 - 2) Press the **LEVEL** button and use the numeric keyboard to enter -10 dBm, or click the level input box on the touch screen to pop up the virtual keyboard and enter -10 dBm on the virtual keyboard.
4. Turn on IQ modulation and RF output
- 1) Press **MOD ON/OFF** button to turn on IQ modulation.
 - 2) Press **RF ON/OFF** button to turn on RF output.

At this time, the **[RF OUTPUT 50Ω]** connector of the SSG5000X-V outputs a two-tone continuous wave signal with a carrier frequency of 3.2 GHz and an interval frequency of 1 MHz. The signal is used as the input of the active device, and the output signal is tested to obtain the OIP3 characteristic as shown in the following figure.

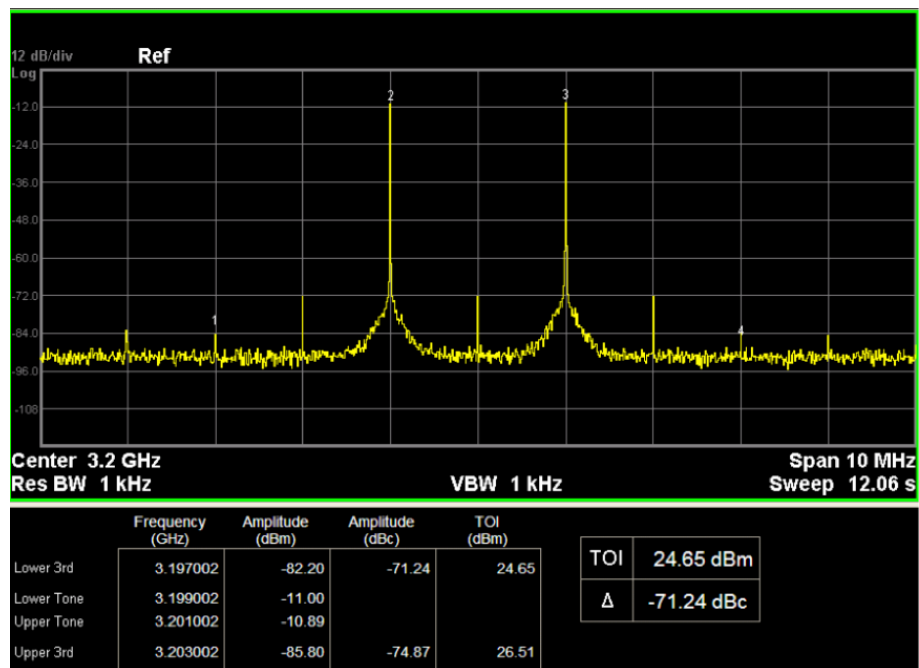

NOTE: IQ compensation can be performed through **I/Q Control** > **I/Q Adjustment** menu of the SSG5000X-V. For example, when the IQ modulation signal shows a significant local oscillator leakage, it can be solved by alternately adjusting the Offset of I and Q.

7.9 Play Waveform Sequence in ARB Mode

Using the ARB (arbitrary waveform) mode of SSG5000X-V, you can play waveform sequences.

1. Restore factory settings

- 1) Press the **UTILITY** button or click **UTILITY** module > **Setting** > **Preset Type** on the touch screen to set the reset type to default;
- 2) Press the **PRESET** button or click **UTILITY** module > **Preset** on the touch screen to perform the reset operation.

2. Create Waveform Sequence

- 1) Press **I/Q** > **ARB** > **Waveform Sequence**, and then click **Build** button to enter the creating new waveform sequence interface;
- 2) Click the waveform segments "SINE_WAVE" and "RAMP_WAVE" in the Segment list on the left, and you can see that both of the waveform segments have been added to the waveform sequence;
- 3) Modify the number of repetitions of SINE_WAVE to 2 and the number of repetitions of RAMP_WAVE to 3;
- 4) Click **Save** button and save the new sequence as "seq1".

3. Play Waveform Sequence

- 1) Press **I/Q** > **ARB** > **Select Waveform**, and select to play the sequence "seq1";
- 2) Turn on **ARB State**;

At this time, the waveform sequence "seq1" is played. You can return to the main page and click  button in the **I/Q MOD** block to view the played waveform. The waveform currently playing is shown as below:

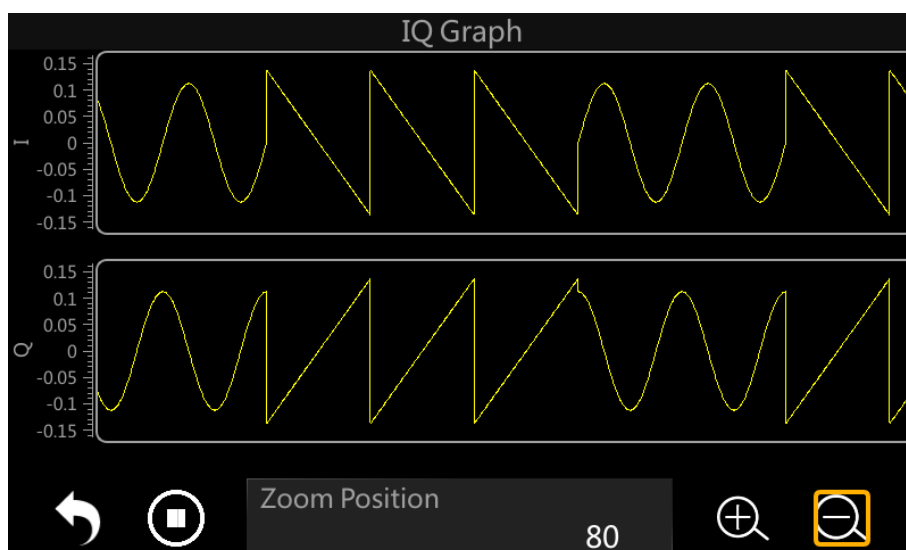

7.10 Add AWGN to Modulated Signal in ARB Mode

Using the ARB (arbitrary waveform) mode of SSG5000X-V, you can add Additive White Gaussian Noise (AWGN) to the carrier while modulating the carrier.

1. Restore factory settings
 - 1) Press the **UTILITY** button or click **UTILITY** module > **Setting** > **Preset Type** on the touch screen to set the reset type to default;
 - 2) Press the **PRESET** button or click **UTILITY** module > **Preset** on the touch screen to perform the reset operation.
2. Set the carrier frequency
Press the **FREQ** button and use the numeric keyboard to enter 2 GHz, or click the frequency input box on the touch screen to pop up the virtual keyboard and enter 2 GHz on the virtual keyboard.
3. Set the real-time AWGN function
 - 1) Press **I/Q** > **ARB** > **ARB Setup** > **Real Time AWGN** to enter real-time AWGN setting interface;
 - 2) Set the **Output Mux** to "Carrier + Noise", the **Carrier Bandwidth** to 3.84 MHz, the **Flat Noise Bandwidth** to 8 MHz, the **Carrier to Noise Ratio Format** to "C/N", the **Carrier to Noise Ratio** to 34 dB, the **Power Control** to "Total", and the **Total Power** to -10dBm;
 - 3) Turn on the **Real Time AWGN** state;
4. Play Waveform
 - 1) Press **I/Q** > **ARB** > **Select Waveform**, and select "WCDMA_3 DPCH" to play;
 - 2) Turn on **ARB State**.
5. Turn on IQ modulation and RF output
 - 1) Press **MOD ON/OFF** button to turn on IQ modulation.
 - 2) Press **RF ON/OFF** button to turn on RF output.

At this time, connect the **[RF OUTPUT 50Ω]** connector of the SSG5000X-V to the spectrum analyzer, set the center frequency to 2 GHz, turn on the trace averaging function, and the spectrum of the modulated wave with Additive White Gaussian Noise is shown below.

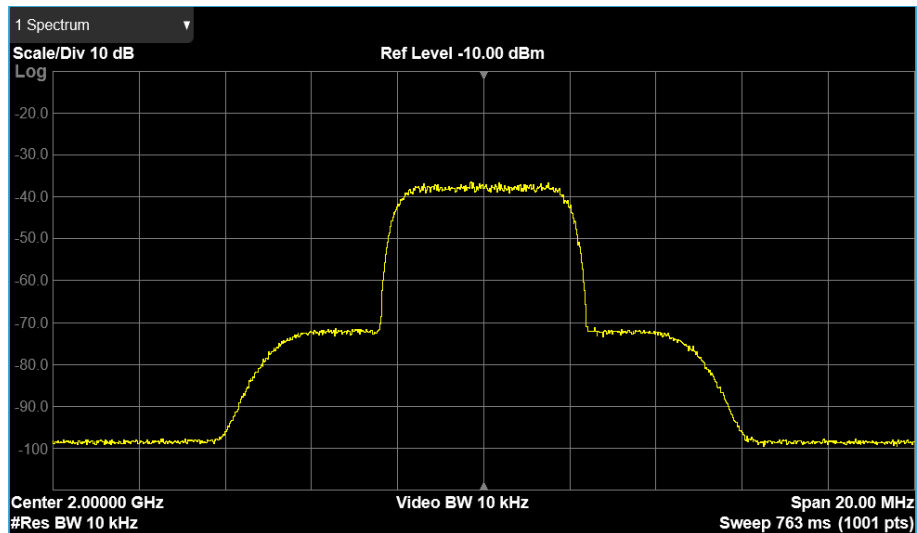

7.11 Download/Upload Files Using FTP (LAN)

The RF signal generator supports LAN and FTP protocols. Users can download files in the "Local" folder of the signal generator to a computer through the free software FileZilla, or upload files from a computer to the "Local" folder of the signal generator. The file transfer supports TLS encryption. Here's how to use FileZilla software to download or upload files via LAN.

1. Install FileZilla software on your computer.

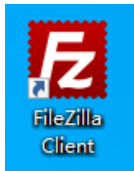

2. Set the LAN parameters of the signal generator, and ensure that the IP address can be pinged.
3. Open the FileZilla software, the user interface is as shown below:

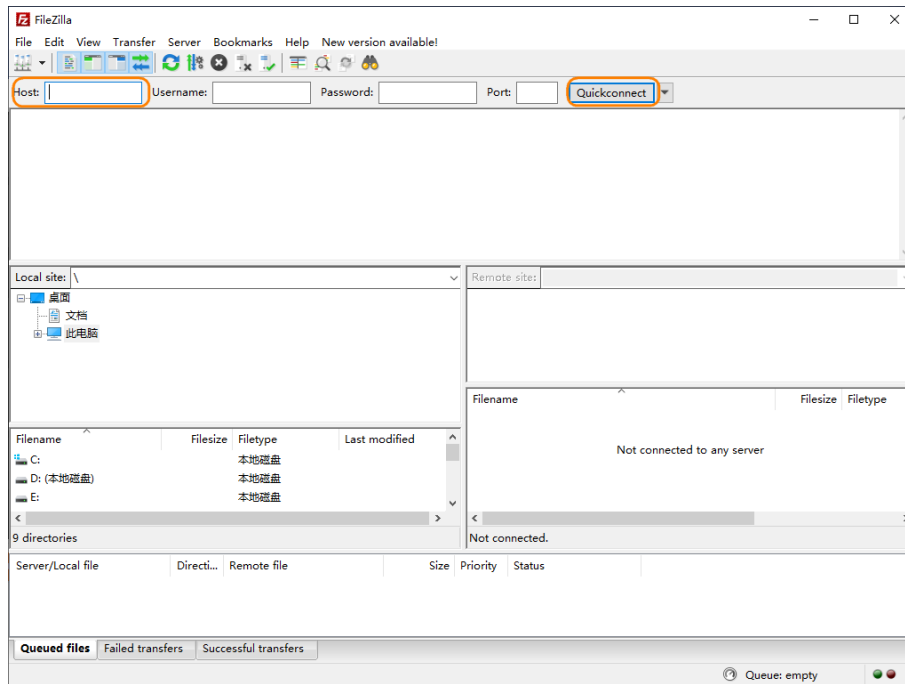

4. Fill in the IP address of the signal generator in the "Host" input box of the FileZilla software, and then click the "Quickconnect" button to connect to the signal source.

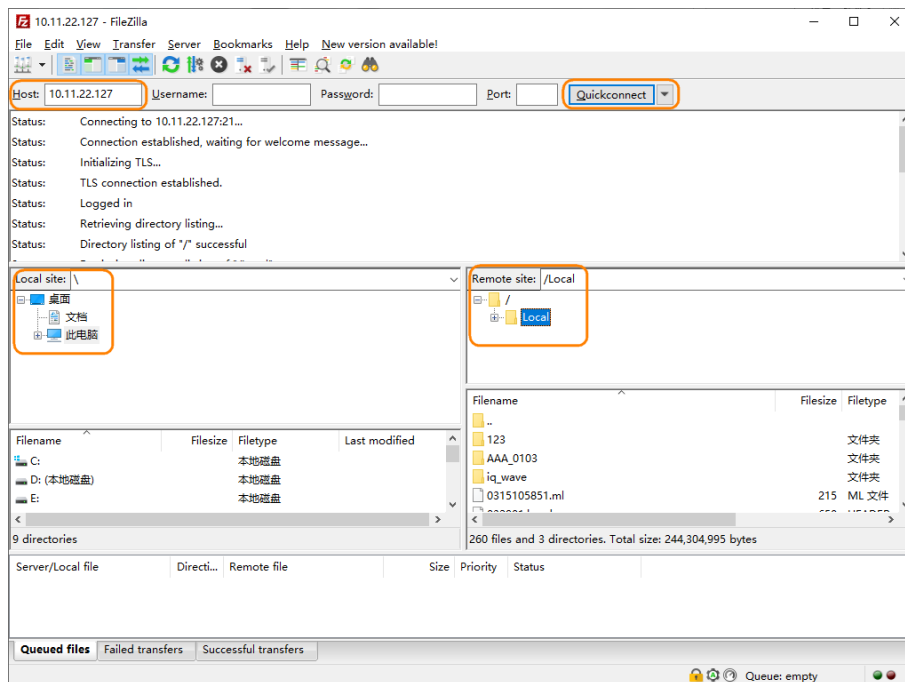

5. Once the signal source is connected, you can transfer files between the local site (computer) and the remote site (the "Local" folder of the signal source).
6. If you want to turn off the FTP function, you can press **UTILITY** > **Interface** > **Web Setting** > **FTP State** to turn off FTP, as shown in the figure below. It will now be impossible to transfer files via FTP (LAN) between the computer and the source.

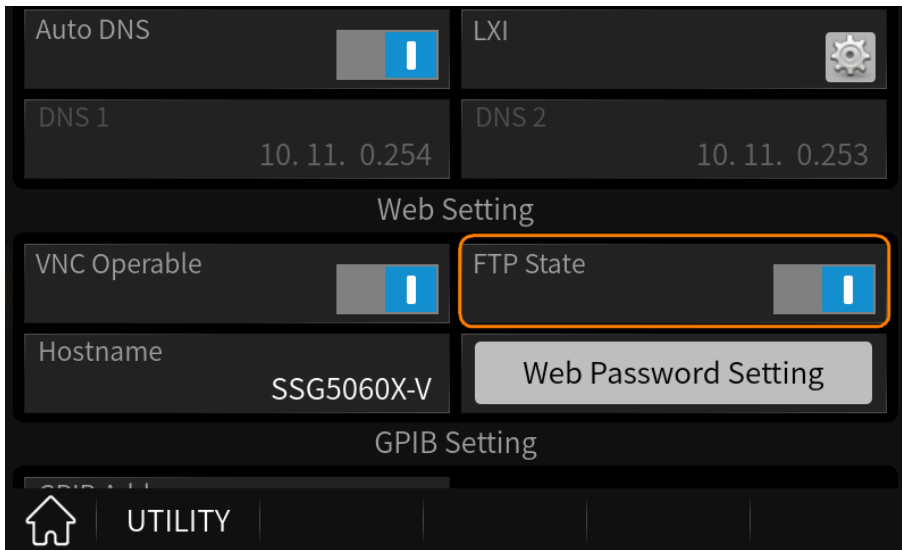

8 Front Panel Operation

This chapter introduces in detail the function keys on the front panel of SSG5000X/X-V and the associated menu functions.

8.1 Frequency

You can set the frequency value in the display frequency input box on the status bar, or you can set the frequency value in the frequency parameter setting area. Note that there is a difference between the frequency displayed on the status bar and the frequency in the parameter setting area. The difference between them will be described in the following chapters.

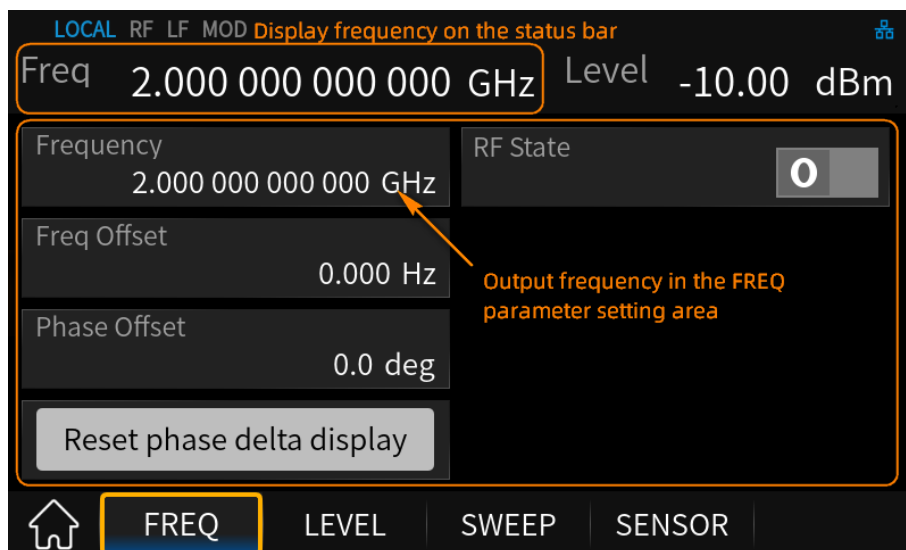

Figure 8-1 Frequency setting

8.1.1 RF Display Frequency and Output Frequency

If the RF output is connected to a downstream instrument, such as a mixer, the frequency offset can be set in the frequency parameter setting area. The relationship between the display frequency of the status bar and the frequency of the parameter setting area is as follows:

1. The relationship between display frequency, output frequency and frequency offset is:

$$\text{Display frequency (display frequency in status bar)} = \text{output frequency (frequency in parameter setting area)} + \text{frequency offset}$$
2. The difference between the displayed frequency and the frequency offset is the RF output frequency.

8.1.2 Frequency Offset

Click **Freq Offset** to set the frequency offset of the RF output signal.

When the RF signal source is connected to an external mixer and other equipment, by setting a reasonable frequency offset, the frequency after passing through the mixer can be directly read and set.

8.1.3 Phase Offset

Click **Phase Offset** to set the phase offset of the RF signal.

When multiple RF sources output signals simultaneously, multiple signals can be output to the same phase or fixed phase offset by adjusting this parameter. At this point you should set multiple RF sources to the same frequency and synchronize their clocks.

Click **Reset Phase delta display** button to reset the currently displayed phase offset value to 0 degrees, but the actual phase offset of the signal does not change.

8.1.4 RF State

Functionally equivalent to the **RF ON/OFF** button on the front panel.

8.2 Level

You can set the level value in the display level input box on the status bar, or you can set the level value in the level parameter setting area. Note that there is a difference between the display level on the status bar and the level in the parameter setting area. The difference between them will be described in the following chapters.

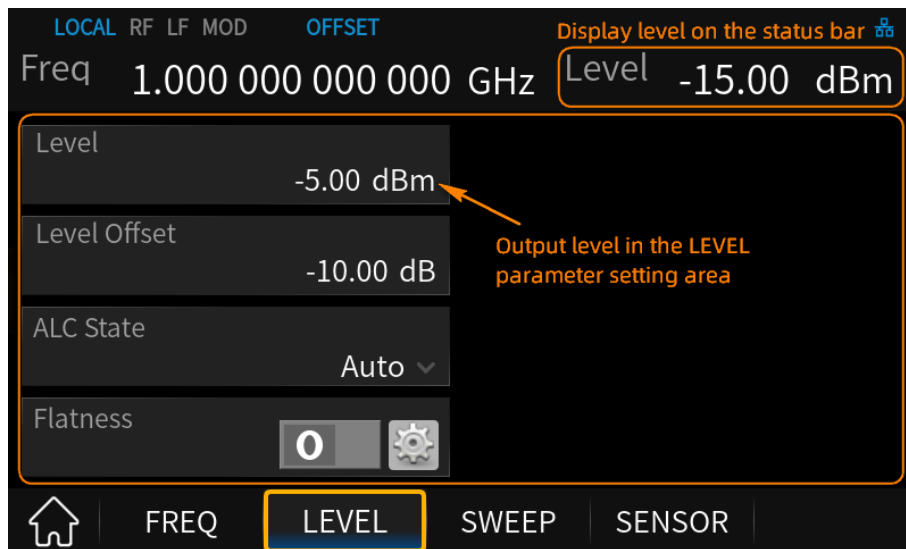

Figure 8-2 Level setting

8.2.1 RF Display Level and Output Level

If the RF signal source works in a system with an attenuator or amplifier, you can set the corresponding level offset parameters in the level parameter setting area. When the signal source and attenuator or amplifier are viewed as a whole, the level value can be viewed directly in the display level area of the status bar.

The relationship between the display level of the status bar and the level of the parameter setting area is as follows:

1. The relationship between the display level, output level and level offset is:

$$\text{Display level (display level in status bar)} = \text{output level (level in parameter setting area)} + \text{level offset}$$
2. The difference between the display level and level offset is the RF output level.

8.2.2 Level Offset

Click **Level Offset** to set the level offset of the RF output signal.

When the RF output is connected to a fixed attenuation or gain, by setting a reasonable level offset,

the attenuated or amplified amplitude value can be directly read and set on the RF source. After setting the level offset to be non-zero, a blue "OFFSET" icon will be displayed on the status bar of the user interface.



8.2.3 ALC State

Click **ALC State** to select the working status of the ALC function.

ALC stands for Automatic Level Control. It is an adaptive control system to stabilize the RF output level. It continuously monitors the current level and adjusts it to keep a steady state over temperature and time.

ALC has three working states: "Off", "On" and "Auto":

AUTO

Automatically turn on or off the ALC function according to the equipment state.

On

Enable ALC permanently, regardless of the currently selected mode.

Off (S&H)

Deactivate ALC. The instrument switches to Sample & Hold (S&H) state, which still allows maintaining a constant output level. In "S&H" mode, the signal generator switches for a short period of time into CW mode and activates ALC. The ALC adjusts the level to the set value and the generator holds the value. Then the generator switches ALC off again and back to the previous operating mode.

8.2.4 Flatness

The flatness correction function can adjust the RF output amplitude corresponding to the frequency point within the frequency range of the instrument to compensate for external losses introduced by cables or other equipment.

The flatness function mathematically adjusts the output by applying a user-defined list of level corrections, thereby adjusting the amplitude at specific frequencies. Correction is performed by adding the correction value from the flatness correction list to the output level of the corresponding RF frequency. For frequencies not included in the list, the level correction is determined by linear interpolation of the nearest correction value.

After the flatness correction function is turned on, a blue "UF" icon will be displayed on the status bar of the user interface.



8.2.4.1 Create Flatness List

Press **LEVEL** > **Flatness** , or click **RF** module on the home page > **LEVEL** > **Flatness** , and then click  to enter the flatness list editing page.

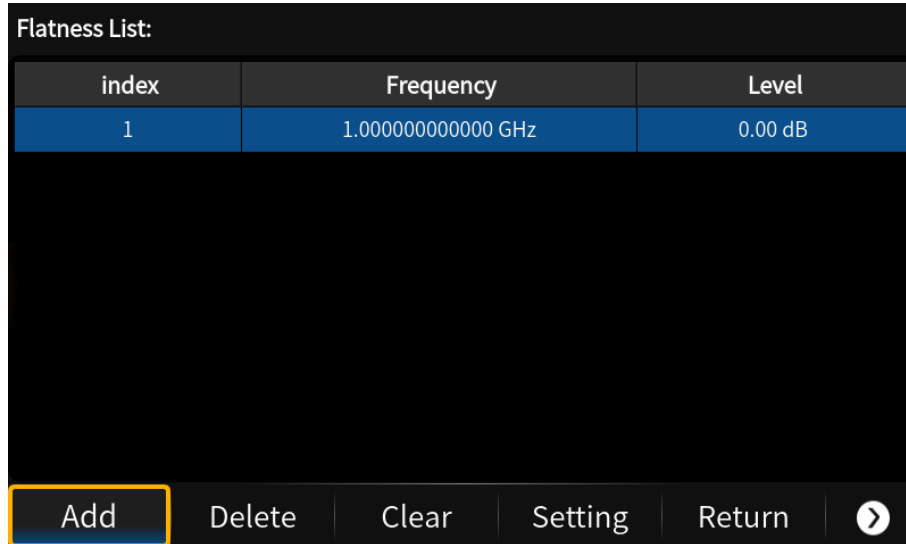





Figure 8-3 Flatness list editing page

The flatness list consists of index, correction frequency and level correction value, and is an empty list by default.

- Click **Add** to insert a row after the last row. The user needs to edit the frequency and level correction values.
- Click **Delete** to delete the currently selected row.
- Click **Clear** to restore the flatness list to empty.
- Click **Setting** to enter the flatness list automatic filling page. For details, please see "Auto Fill Flatness List".
- Click **Return** to return to the previous menu.
- Click  > **Open** to select and load the flatness correction file (*.UFLT).
- Click  > **Save** to save the current flatness list to a UFLT file.
- Each page of the user interface can display up to 25 lines of data. When the flatness list exceeds 25 rows of data, you can click  > **First** / **Previous** / **Next** / **Last** to browse the list content.
- Click each frequency and correction value in the table area to set them through the touch screen keyboard or the front panel keypad.

Users need to pay attention to the following when editing the flatness list:

1. When there is a frequency offset, the frequency offset value needs to be added to the correction

frequency.

2. The flatness list is automatically sorted from small to large according to the correction frequency.

8.2.4.2 Auto Fill Flatness List

After entering the flatness list setting page, you can choose one of the following three methods to automatically fill the flatness list with the power sensor.

1. Flatness List
 - 1) Firstly, set the correction frequency points in the flatness list editing page.
 - 2) Secondly, click the **Setting** button to enter the automatic filling flatness list page.
 - 3) Thirdly, select **Fill Type** as "Flatness List".
 - 4) Finally, click the **Fill Flatness With Sensor** button.
2. Manual Step
 - 1) Firstly, click the **Setting** button to enter the automatic filling flatness list page.
 - 2) Secondly, select **Fill Type** as "Manual Step".
 - 3) Thirdly, in the pop-up edit box, set the start frequency, stop frequency, frequency space mode and frequency step or number of points that need to be corrected.
 - 4) Finally, click the **Fill Flatness With Sensor** button.
3. Sweep List
 - 1) Firstly, set the sweep frequency in **SWEEP** > **List Sweep** .
 - 2) Secondly, select the flatness list **Fill Type** as "Sweep List".
 - 3) Finally, click the **Fill Flatness With Sensor** button.

After clicking the **Fill Flatness With Sensor** button, the RF signal source will automatically generate the amplitude correction values of the flatness list.

NOTE:

- When use sweep list to populate the flatness list, the correction frequencies of the flatness list is consistent with the sweeping frequencies of the sweep list, and the correction frequencies of the flatness list will be automatically sorted from small to large.
- When using the auto-fill flatness list function, please connect the power meter correctly to the RF signal source. If a power meter is not connected or is not recognized, the flatness list will not automatically populate. Please pay attention to the pop-up message.

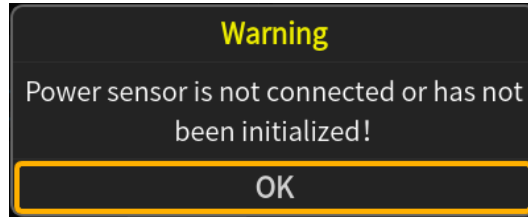

- When automatically filling the flatness list, there's no need for you to turn on the RF state or sensor state. Before or after "Fill Flatness With Sensor" executed, the RF state and sensor state will be turned on or turned off automatically.
- During the process of automatically filling the flatness list, the user interface will pop up the following prompt message. Do not move the power meter during this process.

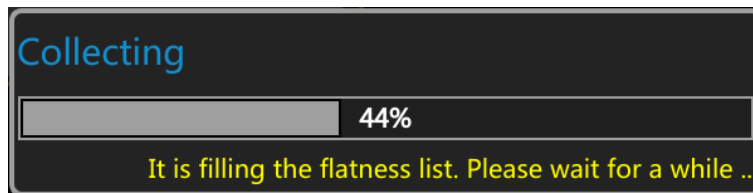

8.3 Sweep

When the RF sweep function is enabled, the sweep signal will be output from the [RF OUTPUT 50Ω] connector on the front panel.

Please note that the RF sweep signal will be output only when the RF switch [RF ON/OFF] is on. You can press the [SWEEP] button on the front panel to enter the RF sweep setting interface.

8.3.1 Sweep State

The sweep state is off by default. The RF signal generator offers three sweep types: Freq, Level, and Freq & Level. Select any one of the sweep types to enable RF sweeping. After the sweep function is enabled, a blue "SWEEP" icon will be displayed on the status bar of the user interface.

Clicking the drop-down box of the *Sweep State* to choose a sweep type:

- Off: Default state. Turn off the sweep function.
- Freq: Enable frequency sweep. At this time, the display frequency refreshes the current sweeping frequency value in real time, and the current sweep progress can be observed on the frequency sweep progress bar.

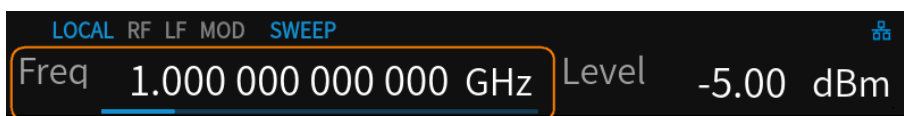

- Level: Enable level sweep. At this time, the display level refreshes the current sweeping level value in real time, and the current sweep progress can be observed on the level sweep progress bar.

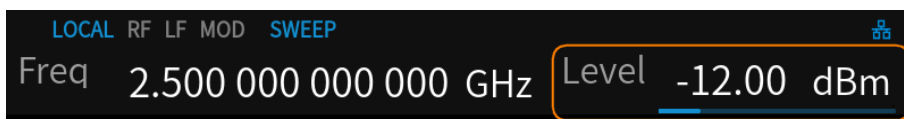

- Freq& Level: Enable both frequency and level sweep. At this time, the display frequency and display level refresh the current sweeping frequency and level values in real time, and the current sweep progress can be observed on the frequency and level sweep progress bar.

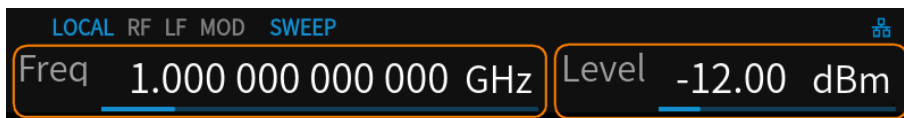

NOTE: Turning on RF sweep turns off the power control function of the power meter. If an RF sweeping is in progress, the power meter's power control function cannot be turned on.

8.3.2 Step Sweep

The step sweep is on by default. Click the slide  to switch the on-off state. Click  to enter the parameter setting menu of step sweep.

NOTE: The step sweep and list sweep are mutually exclusive. One will shut off automatically when the other is on.

Step sweep settings include the following parameters:

- 1) Start Freq: Initial frequency of the sweep.
- 2) Stop Freq: Final frequency of the sweep.
- 3) Start Level: Initial amplitude level of the sweep.
- 4) Stop Level: Final amplitude level of the sweep.
- 5) Dwell Time: The interval time between two adjacent sweep points.
- 6) Sweep Points: The number of points in a sweep. The frequency and level values of each sweep point are interpolated from the start and stop parameters.
- 7) Sweep Shape: The cycle mode of sweep, there are two types: "Sawtooth" and "Triangle", which can be selected by clicking the drop-down box.
 - Sawtooth: Sweep period is always from the start frequency or start level to the stop frequency or stop level. The sweep sequence is similar to a "sawtooth wave".
 - Triangle: Sweep period is always from the start frequency or start level to the stop frequency or stop level, and then return back to the start frequency or start level. The sweep sequence is similar to a "triangle wave".
- 8) Sweep Space: the change from one frequency to another within a frequency sweep step. Frequency sweep has two step types: linear and logarithmic, which can be selected by clicking the drop-down box.

NOTE: Level sweep only supports linear steps and does not need setting.

8.3.3 List Sweep

The list sweep is off by default. Click the slide  to switch the on-off state. Click  to enter the editing page of list sweep.

NOTE: The list sweep and step sweep are mutually exclusive. One will shut off automatically when the other is on.

Sweep List:

Index	Frequency	Level	Time
1	1.000000000000 GHz	0.00 dBm	500.0 ms
2	2.000000000000 GHz	-5.00 dBm	1.0000 s
3	3.000000000000 GHz	-10.00 dBm	2.0000 s

Add Delete Clear Import Return ➤

Figure 8-4 List sweep editing page

The sweep list includes index number, sweep frequency, sweep level and dwell time. The default value is "1,1.5 GHz,-110 dBm,50 ms".

- Click **Add** to insert a row before the currently selected row. The newly inserted row will copy the currently selected row.
- Click **Delete** to delete the currently selected row.
- Click **Clear** to restore the sweep list to the default value.
- Click **Import** to generate a sweep list based on the step sweep settings..
- Click **Return** to return to the previous menu.
- Click **➤** > **Open** to select and load the sweep list file (*.LSW).
- Click **➤** > **Save** to save the current sweep list to a LSW file.
- Each page of the user interface can display up to 25 lines of data. When the sweep list exceeds 25 rows of data, you can click **➤** > **First** / **Previous** / **Next** / **Last** to browse the list content.
- Click each frequency, level and dwell time parameter in the table area to set them through the touch screen keyboard or the front panel keypad.

Users need to pay attention when editing the sweep list: when there is a frequency offset/level offset, the offset value needs to be added to the sweep frequency/sweep level.

8.3.4 Sweep Direction

The sweep direction defaults to "Up". The signal source provides two types: "Up" Or "Down". Click the drop-down box of **Direction** to enable the corresponding sweep direction.

- Up: The signal source sweeps from the start frequency or start level to the stop frequency or stop level. The progress bar displayed in the parameter bar sweeps from left to right.
- Down: The signal source sweeps from the stop frequency or stop level to the start frequency or start level. The progress bar displayed in the parameter bar sweeps from right to left.

8.3.5 Sweep Mode

The sweep mode defaults to "Continuous". The signal source provides two sweep modes: "Continuous" or "Single". Click the drop-down box of **Sweep Mode** to enable the desired mode.

- Continuous: When the trigger conditions are met, the signal source sweeps continuously according to the current settings.
- Single: When the trigger conditions are met, each time you click the **Execute single sweep** button, the signal source will sweep for a cycle with the current settings, and then stop.

Please note that the **Execute single sweep** button will only be displayed when the sweep mode is "Single" and hidden otherwise.

8.3.6 Trigger Mode

The trigger mode defaults to "Auto". The signal source provides four types of trigger mode: "Auto", "Key", "Bus" and "Ext".

Click the drop-down box of **Trigger Mode** to select the desired type:

Auto

- If the sweep mode is "Continuous", after selecting any sweep state, the signal source starts sweeping continuously.
- If the sweep mode is "Single", after selecting any sweep state, you need to click the **Execute single sweep** button to start sweeping. The sweep stops after completing one cycle.

Key

- If the sweep mode is "Continuous", the device will start a one-time sweep after you pressed the **Trigger** button on the front panel or click the **Click to trigger** button on the touch screen.
- If the sweep mode is "Single", first click the **Execute single sweep** button, and then a one-time sweep will be started after you pressed the **Trigger** button on the front panel or click the **Click to trigger** button on the touch screen.

Bus

- If the sweep mode is "Continuous", the device will start a one-time sweep after receiving a "**TRG" command from the control computer via the communication bus (USB, LAN or GPIB).
- If the sweep mode is "Single", first click the **Execute single sweep** button, and then a one-time

sweep will be started after the device received a “*TRG” command.

Ext

The device receives the external trigger signal input from the [TRIG IN/OUT] connector on the rear panel.

- If the sweep mode is “Continuous”, the device will start a one-time sweep every time it receives a TTL pulse of specified polarity.
- If the sweep mode is “Single”, first click the *Execute single sweep* button, and then the device will start a one-time sweep every time it receives a TTL pulse of specified polarity.

Please note that the above description of the sweep trigger mode is based on the point trigger mode being "Auto" mode.

8.3.7 Point Trigger

The point trigger mode defaults to “Auto”. The signal source provides four types of point trigger mode: “Auto”, “Key”, “Bus” and “Ext”.

Click the drop-down box of *Point Trigger* to select the desired type:

Auto

- If the sweep mode is “Continuous”, just select one sweep state to start sweeping each point continuously within one sweep cycle.
- If the sweep mode is “Single”, click *Execute single sweep* button to start sweeping each point within one sweep cycle.

Key

- If the sweep mode is “Continuous”, the device will sweep one point each time the Trigger button on the front panel is pressed or the *Click to trigger* button on the touch screen is clicked.
- If the sweep mode is “Single”, first click the *Execute single sweep* button, then each time you press the Trigger button or click the *Click to trigger* button the device will sweep one point. The sweep stops after completing one cycle.

Bus

- If the sweep mode is “Continuous”, the device will sweep one point each time it receives a “*TRG” command.
- If the sweep mode is “Single”, first click the *Execute single sweep* button, then the device will sweep one point each time it receives a “*TRG” command. The sweep stops after completing one cycle.

Ext

The device receives the external trigger signal input from the **[TRIG IN/OUT]** connector on the rear panel.

- If the sweep mode is “Continuous”, the device will sweep one point each time it receives a TTL pulse of specified polarity.
- If the sweep mode is “Single”, first click the **Execute single sweep** button, then the device will sweep one point each time it receives a TTL pulse of specified polarity. The sweep stops after completing one cycle.

Please note that the above description of the point trigger mode is based on the sweep trigger mode being "Auto" mode.

8.3.8 Trigger Slope

When the trigger mode or point trigger mode is “Ext”, you can select “Positive” or “Negative” as the external trigger slope. The default trigger slope is “Positive”.

Click the drop-down box to select the desired trigger slope:

- Positive: The sweep is triggered when the rising edge of the external trigger signal arrives.
- Negative: The sweep is triggered when the falling edge of the external trigger signal arrives.

Please note that the **Trigger Slope** button will be displayed only when the trigger mode or point trigger mode is “Ext”, and will be hidden in other cases.

8.3.9 About Sweep Conditions

When performing a sweep operation, the priorities that need to satisfy the sweep conditions from high to low are:

Sweep mode > Trigger mode > Point trigger mode.

For example, when "Key" is selected for both trigger mode and point trigger mode:

- In "Continuous" sweep mode, press the **Trigger** button first to meet the trigger condition, and then press the **Trigger** button again to meet the point trigger condition. At this time the signal source will start sweeping.
- In "Single" sweep mode, press the **Execute single sweep** button first to meet the single sweep condition. Then press the **Trigger** button two times to meet the trigger condition and point trigger condition. At this time the signal source will start sweeping. The sweep stops after completing one cycle.

8.4 Analog Modulation

Analog modulation includes amplitude modulation, frequency modulation, phase modulation and pulse modulation.

You need to turn on the analog modulation master switch to enable the analog modulation function. You can turn it on by pressing the **MOD ON/OFF** button on the front panel, or through the **ANALOG MOD** module switch on the home page, as shown in the figure below. After turning on the analog modulation master switch, a blue "MOD" icon will be displayed on the status bar of the user interface.

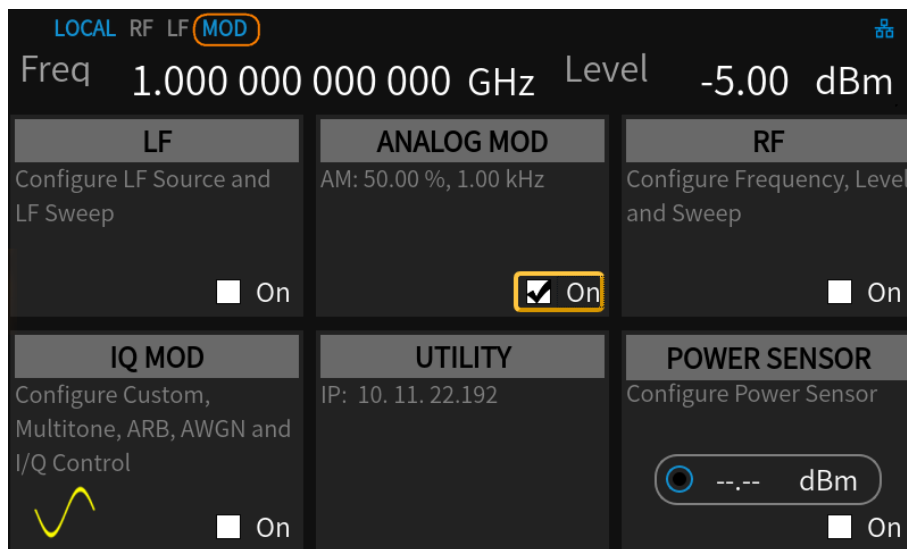

Figure 8-5 Analog modulation master switch

8.4.1 Amplitude Modulation (AM)

Amplitude Modulation (AM) is a technique that modulates the original signal by changing the amplitude of the carrier signal. When the amplitude of the original signal changes, the amplitude of the carrier signal also changes linearly, thus superimposing the characteristics of the original signal on the carrier signal.

You can click **ANALOG MOD** module > **AM** on the homepage to enter the AM page, or you can press the **MOD** button several times until you switch to the AM page.

8.4.1.1 AM State

Press **AM State** to turn on or off the amplitude modulation.

8.4.1.2 AM Source

Internal and/or external source can be selected for amplitude modulation. Press **AM Source** to set

the amplitude modulation source to "Int", "Ext" or "Int + Ext". The default is "Int".

1. Int

The internal modulation source is generated inside the instrument and is shared with the low frequency generator (LF). When internal source modulation is on, the LF output will be off. When the LF output is on, internal source modulation will be off.

2. Ext

External modulation source is the external modulation signal input by the [EXT MOD INPUT] connector on the rear panel of the RF signal source. The modulated signal can be an arbitrary waveform. At this time, the modulation depth is controlled by the level of the external modulation signal.

3. Int + Ext

After selecting "Int + Ext", the modulation signal is synthesized from internal and external modulation sources, which can realize two-tone amplitude modulation.

8.4.1.3 AM Shape

The internal source of amplitude modulation supports two modulation waveforms: sine and square. After setting the AM source to "Int" or "Int + Ext", you can press **AM Shape** to choose the AM waveform of internal source to be "Sine" or "Square".

8.4.1.4 AM Rate

After setting the AM modulation source to "Int" or "Int + Ext", you can press **AM Rate** to set the modulation frequency of the internal source.

- The modulation frequency range of sine wave is 0.01 Hz~100 kHz.
- The modulation frequency range of square wave is 0.01 Hz~20 kHz.

8.4.1.5 AM Depth

Modulation depth represents the degree to which the carrier amplitude changes, expressed as a percentage.

- When selecting internal modulation source, the setting range of AM modulation depth is 0.0%~100%. The relationship between the modulation depth m and the carrier sideband amplitude difference ΔP satisfies the relationship:

$$\Delta P = 6.02 - 20 * \lg m$$

- When selecting external modulation source, the actual modulation depth is related to the

amplitude of the external input modulation signal, that is:

$$\text{Modulation depth} = \text{amplitude of the external input signal} \times \text{external modulation sensitivity}$$

For example, if the modulation depth is set to 100%, then the actual modulation depth is 100% when the external modulation signal is 2 Vpp (0 V offset), and when the external modulation signal is 1 Vpp (0 V offset), the actual modulation depth is 50%.

- When selecting internal + external modulation source, the setting value is the total modulation depth, with the internal source accounting for 50% and the external source accounting for 50%. The modulation depth of the external source is related to the amplitude of the external input modulation signal, that is:

$$\text{Modulation depth} = \text{setting value} \times 0.5 + \text{amplitude of external input signal} \times \text{external modulation sensitivity}$$

For example, if the modulation depth is set to 100%, the modulation depth allocated to the internal source and the external source will be 50% each. Since the external modulation sensitivity is 25%/V, the actual modulation depth is 100% when the external modulation signal is 2 Vpp (0 V offset), and the actual modulation depth is 75% when the external modulation signal is 1 Vpp (0 V offset).

8.4.1.6 AM Sensitivity

It displays the unit depth quantified by the amplitude of the external modulation signal.

8.4.2 Frequency Modulation (FM)

Frequency Modulation (FM) is a technology that modulates the original signal by changing the frequency of the carrier signal. The frequency changes of the original signal are converted into frequency changes of the carrier signal, thereby carrying the characteristics of the original signal on the carrier signal.

You can click **ANALOG MOD** module > **FM** on the homepage to enter the FM page, or you can press the **MOD** button several times until you switch to the FM page.

8.4.2.1 FM State

Press **FM State** to turn on or off the frequency modulation.

8.4.2.2 FM Source

Internal1, internal2 and/or external source can be selected for frequency modulation. Press **FM Source** to set the frequency modulation source to "Int1", "Int2", "Int1 + Int2", "Ext", "Int1 + Ext" or

“Dual”. The default is “Int1”.

1. Int

When "Int1", "Int2", "Int1 + Int2" or "Dual" is selected, the modulation source is completely generated within the instrument and is collectively referred to as "Internal Source". There are two internal sources to choose from, Internal Source 1 and Internal Source 2. Parameters such as waveform, frequency deviation and modulation rate of the two internal sources can be set independently.

When "Int1 + Int2" is selected, two internal modulation sources are used for dual-tone modulation.

When "Dual" is selected, the waveforms of the two internal sources are superimposed and then modulated as a new modulation signal.

2. Ext

External modulation source is the external modulation signal input by the [EXT MOD INPUT] connector on the rear panel of the RF signal source. The modulated signal can be an arbitrary waveform.

3. Int + Ext

After selecting "Int1 + Ext", the modulation signal is superposed by internal source 1 and external source. In this way, two-tone modulation or more complex modulation can be achieved.

8.4.2.3 FM Shape

The internal source of frequency modulation supports four modulation waveforms: “Sine”, “Square”, “Sawtooth” or “Triangle”.

8.4.2.4 FM Rate

After setting the FM source to internal or internal + external, you can set the modulation frequency of internal source 1 through *FM Rate 1*, and set the modulation frequency of internal source 2 through *FM Rate 2*.

- The modulation frequency range of sine wave is 0.01 Hz ~ 100 kHz.
- The modulation frequency range of square wave, sawtooth wave or triangle wave is 0.01 Hz ~ 20 kHz.

8.4.2.5 FM Deviation

Corresponding to different carrier frequencies, the frequency deviation range may be different. The setting range is 0.01 Hz ~ N×1 MHz. The value of N is related to the carrier frequency. Please refer to the data sheet for details.

- When the modulation source is set to “Int1” or “Int2” or “Dual”, the setting value is the frequency

deviation of the RF output.

- When the modulation source is set to "Int1 + Int2", the frequency deviation is related to the frequency deviation set by the two modulation sources respectively. The frequency deviation of the RF output = frequency deviation 1 + frequency deviation 2. "frequency deviation 1" and "frequency deviation 2" correspond to the frequency deviation setting values of "internal source 1" and "internal source 2" respectively.
- When the modulation source is set to "Ext", the actual frequency deviation is related to the amplitude of the external input modulation signal, that is:

$$\text{Frequency deviation of RF output} = \text{amplitude of external input signal} \times \text{external modulation sensitivity}$$

For example, if the maximum frequency deviation is set to 100 kHz, then the actual frequency deviation is 100 kHz when the external modulation signal is 2 Vpp (0 V offset), and when the external modulation signal is 1 Vpp (0 V offset), the actual frequency offset is 50 kHz.

- When the modulation source is set to "Int1+Ext", the setting value is the maximum value of the total frequency deviation, with the internal source accounting for 50% and the external source accounting for 50%. The external source modulation frequency deviation is related to the amplitude of the external input modulation signal, that is:

$$\text{Frequency deviation of RF output} = \text{setting value} \times 0.5 + \text{external input signal amplitude} \times \text{external modulation sensitivity}$$

For example, if the maximum frequency deviation is set to 100 kHz, the frequency deviation allocated to the internal source and the external source is 50% each. Since the external modulation sensitivity is 25 kHz/V, when the external modulation signal is a full-scale 2 Vpp (0 V offset), the actual modulation frequency offset is 100 kHz, and when the external modulation signal is 1 Vpp (0 V offset), the actual modulation frequency offset is 75 kHz.

8.4.2.6 FM Sensitivity

External modulation sensitivity displays the unit frequency deviation quantized by the amplitude of the external modulation signal.

8.4.2.7 FM Phase

When the modulation source selects "Int1 + Int2" or "Dual", set the initial phase of the waveform signal generated by Internal source1 or Internal source2. Different phase settings will affect the final Modulation results.

The setting range of FM phase is $-360^{\circ} \sim +360^{\circ}$.

8.4.2.8 FM Proportion

When "Dual" is selected as the modulation source, set the respective amplitude ratios of the waveform signals of internal source 1 and internal source 2 during the superposition process, that is:

The amplitude of the superimposed waveform = setting value \times waveform amplitude of internal source 1 + (100% - setting value) \times waveform amplitude of internal source 2.

For example, when the setting value is 30%, 30% of the amplitude value of internal source 1 and 70% of the amplitude value of internal source 2 are used for superposition.

The setting range of FM Proportion is 0% ~ 100%.

8.4.3 Phase Modulation (PM)

Phase Modulation (PM) is a technology that modulates the original signal by changing the phase of the carrier signal. The phase change of the original signal is converted into the phase change of the carrier signal, thereby transmitting the information of the original signal on the carrier signal.

You can click **ANALOG MOD** module > **PM** on the homepage to enter the PM page, or you can press the **MOD** button several times until you switch to the PM page.

8.4.3.1 PM State

Press **PM State** to turn on or off the phase modulation.

8.4.3.2 PM Source

Internal and/or external source can be selected for phase modulation. Press **PM Source** to set the phase modulation source to "Int", "Ext" or "Int + Ext". The default is "Int".

1. Int

The internal modulation source is generated inside the instrument, and the modulation frequency can be set and the modulation waveform can be selected.

2. Ext

External modulation source is the external modulation signal input by the **[EXT MOD INPUT]** connector on the rear panel of the RF signal source. The modulated signal can be an arbitrary waveform.

3. Int + Ext

After selecting "Int + Ext", the modulation signal is synthesized from internal and external modulation sources, which can realize two-tone phase modulation.

8.4.3.3 PM Shape

The internal source of PM supports two modulation waveforms: sine and square. After setting the PM source to "Int" or "Int + Ext", you can press **PM Shape** to choose the PM waveform of internal source to be "Sine" or "Square".

8.4.3.4 PM Rate

After setting the PM modulation source to "Int" or "Int + Ext", you can press **PM Rate** to set the modulation frequency of the internal source.

- The modulation frequency range of sine wave is 0.01 Hz~100 kHz.
- The modulation frequency range of square wave is 0.01 Hz~20 kHz.

8.4.3.5 PM Deviation

Different carrier frequencies have different phase deviation ranges. The setting range is 0.01 rad~N×5 rad. The value of N is related to the carrier frequency. Please refer to the data sheet for details.

- When the modulation source is internal, the setting value is the maximum phase deviation of the RF output.
- When the modulation source is external, the actual maximum phase deviation is related to the amplitude of the external input modulation signal, that is:

$$\text{Phase deviation of RF output} = \text{amplitude of external input signal} \times \text{external modulation sensitivity}$$

For example, if the maximum phase deviation is set to 1 rad, then the actual maximum phase deviation is 1 rad when the external modulation signal is 2 Vpp (0 V offset), and when the external modulation signal is 1 Vpp (0 V offset), the actual maximum phase deviation is 0.5 rad.

- When the modulation source is external + internal, the setting value is the maximum value of the total phase deviation, with the internal source accounting for 50% and the external source accounting for 50%. The external source modulation phase deviation is related to the amplitude of the external input modulation signal, that is:

$$\text{Phase deviation of RF output} = \text{setting value} \times 0.5 + \text{amplitude of external input signal} \times \text{external modulation sensitivity}$$

For example, if the maximum phase deviation is set to 1 rad, the phase deviation allocated to the

internal source and the external source is 50% each. Since the external modulation sensitivity is 0.25 rad/V, the actual maximum phase offset is 1 rad when the external modulation signal is 2 Vpp (0 V offset), and the actual maximum phase offset is 0.75 rad when the external modulation signal is 1 Vpp (0 V offset).

8.4.3.6 PM Sensitivity

It shows the unit phase deviation quantified by the amplitude of the external modulation signal.

8.4.4 Pulse Modulation (PULSE)

Pulse Modulation refers to the process of using pulse signals as modulation signals to modulate radio frequency carrier signals.

You can click **ANALOG MOD** module > **PULSE** on the homepage to enter the pulse modulation page, or you can press the **MOD** button several times until you switch to the pulse modulation page.

8.4.4.1 Pulse State

Press **Pulse State** to turn pulse modulation on or off.

8.4.4.2 Pulse Source

Press **Pulse Source** to select "Int" or "Ext" modulation source. The default is "Int".

1. Int

The internal pulse generator of the RF signal source provides the modulation source. You can set the pulse mode, pulse period, pulse width and other parameters of the modulation source.

2. Ext

The RF signal source receives the external pulse signal input from the **[PULSE IN/OUT]** connector on the rear panel as the modulation source. At this time, the setting items such as pulse mode, pulse period, pulse width, trigger mode and pulse output are hidden.

8.4.4.3 Ext Polarity

When the pulse source is external, click **Ext Polarity** to switch the trigger polarity of the external modulation source. The default is "Normal".

- Normal: Pulse modulation is performed when the external modulation signal is high level.
- Inverse: Pulse modulation is performed when the external modulation signal is low level.

8.4.4.4 Pulse Mode

When the modulation source is “Int”, the RF signal source provides three pulse modes: “Single”, “Double” and “Train”. The default is “Single”. Click the drop-down box to select the pulse mode.

- Single: Generate one pulse signal in one pulse period. At this time, the two settings “Double Pulse Delay” and “#2 Width” are hidden.

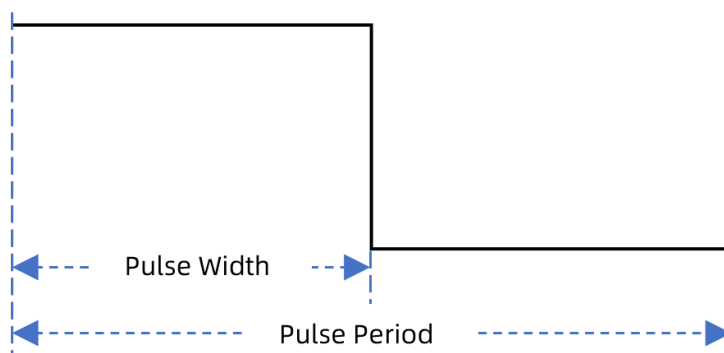

- Double: Generate two pulse signals in one pulse period. At this time, the two settings “Double Pulse Delay” and “#2 Width” are shown.

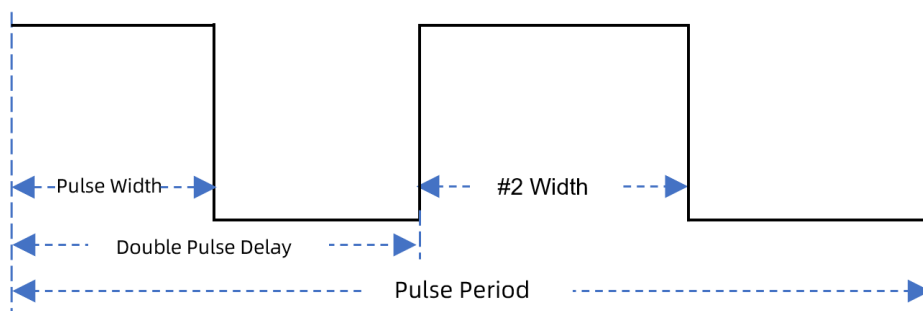

- Train: Generate multiple pulse signals in one pulse period. At this time, the `Pulse Train` setting item appears, and the settings “Pulse Period”, “Pulse Width”, “Double Pulse Delay” and “#2 Width” are hidden. For a detailed introduction to pulse train, please see the "Pulse Train" chapter.

8.4.4.5 Pulse Period

Pulse period represents the time interval between two adjacent periodic pulses. When the pulse mode is single pulse or double pulse, the pulse period needs to be set.

8.4.4.6 Pulse Width

Pulse width represents the high-level duration of a single-pulse modulation signal, or the high-level duration of the first pulse of a double-pulse modulation signal.

8.4.4.7 Double Pulse Delay

Double-pulse delay represents the delay from the start of the first pulse to the start of the second pulse in a single cycle of a double-pulse modulation signal.

8.4.4.8 #2 Width

#2 Pulse Width represents the high duration of the second pulse within a single cycle in a double pulse modulation signal.

8.4.4.9 Pulse Train

When the *Pulse Mode* is set to Train, the *Pulse Train* setting item appears, and the settings "Pulse Period", "Pulse Width", "Double Pulse Delay" and "#2 Width" are hidden.

8.4.4.9.1 The Setting of Pulse Train

Click the setting button  of *Pulse Train* to enter the pulse train editing interface.

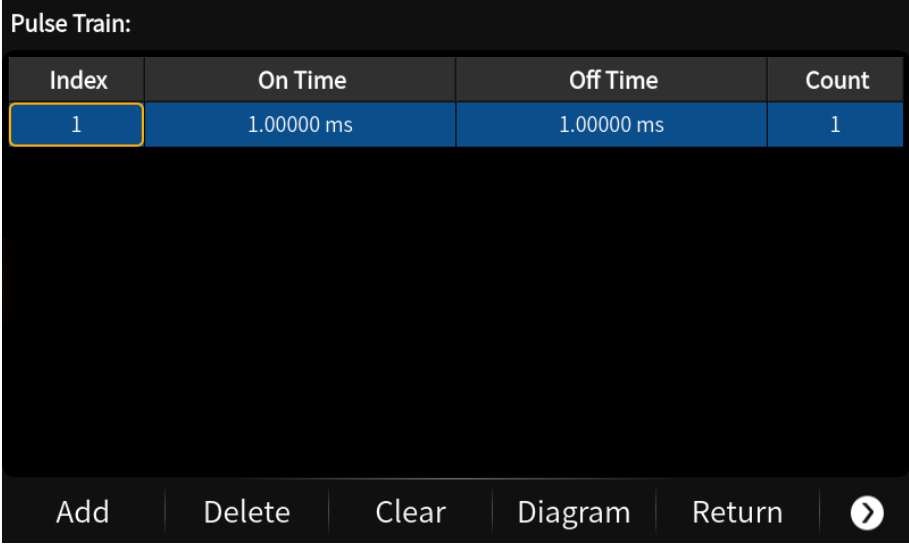

Index	On Time	Off Time	Count
1	1.00000 ms	1.00000 ms	1

At the bottom of the interface, there are buttons for Add, Delete, Clear, Diagram, Return, and a right arrow icon.

Figure 8-6 Pulse train editing page



Each row of parameters of the pulse train represents the settings of each pulse signal within a single pulse period:

- Index indicates the sequence number of the pulse signal corresponding to the row.
- On time indicates the duration of the high level of the pulse signal.
- Off time indicates the duration of the low level of the pulse signal.
- Count indicates the number of repetitions of the pulse signal.

The default value is "1,1 ms,1 ms,1".

- Click *Add* to insert a row before the currently selected row. The newly inserted row will copy

the currently selected row.

- Click **Delete** to delete the currently selected row.
- Click **Clear** to restore the pulse train to the default value.
- Click **Diagram** to view the diagram of the current pulse train.
- Click **Return** to return to the previous menu.
- Click  > **Open** to select and load the pulse train file (*.PULSTRN).
- Click  > **Save** to save the current pulse train to a PULSTRN file.
- Each page of the user interface can display up to 25 lines of data. When the pulse train exceeds 25 rows of data, you can click  > **First** / **Previous** / **Next** / **Last** to browse the list content.
- Click each parameter in the table area to set them through the touch screen keyboard or the front panel keypad.

8.4.4.9.2 Pulse Train Diagram

Click the **Diagram** button in the pulse train editing interface to view the diagram of the current pulse train.

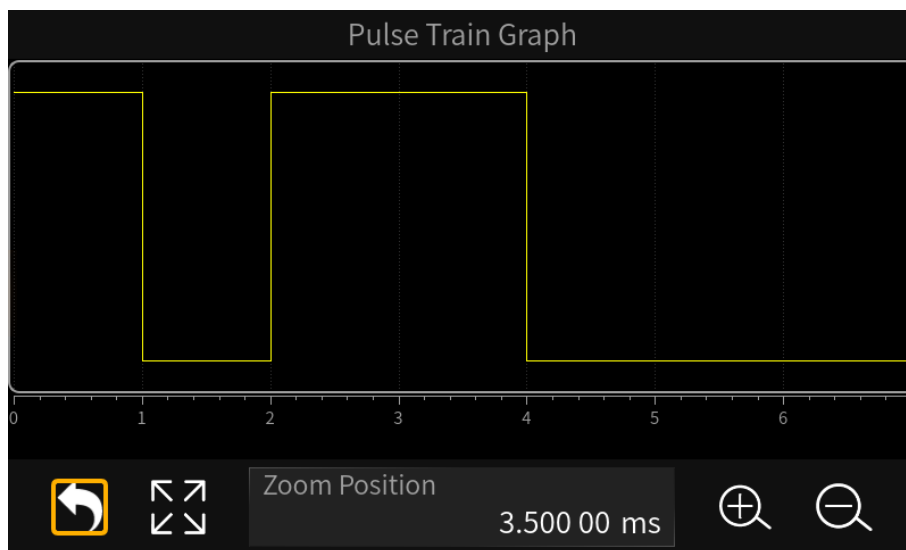





Figure 8-7 Pulse train graph page

As shown in the figure above, the page consists of the upper drawing area and the lower control area:



Drawing area

A schematic diagram of the waveform generated based on the current pulse train. The vertical direction represents the high and low level changes of each pulse signal in the pulse train, and the position of the high and low levels in this direction remains unchanged; the horizontal direction represents the high and low level duration of each pulse signal in the pulse train, which can be enlarged or reduced for easy observation and comparison.

Control area

- Click  to return to the pulse train editing page.
- Click  to restore the waveform to the initial state.
- The “Zoom Position” parameter control displays the center position of the current waveform, and the operations of zoom in, zoom out and restore buttons are based on this position. It can be set through the touch screen keyboard or the front panel keypad to make the current waveform translate to the corresponding position.
- Click  to zoom in the center position of the current waveform.
- Click  to zoom out the center position of the current waveform.

The zoom operation of the drawing area can be achieved in the following ways:

- 1) Zoom, pan and restore through the Control Area's , ,  button, and “Zoom Position” parameter.
- 2) You can also use your finger or stylus to zoom in or zoom out directly on the touch screen.
- 3) On the touch screen, use the mouse wheel. Pull the wheel down to zoom in and up to zoom out. The zoom position of the wheel is consistent with the "zoom position" of the control area.

8.4.4.9.3 Pulse Train Advanced Mode

The advanced mode of the pulse train can be turned on via the **Train Advanced Mode** button. After turning on the advanced mode of the pulse train, each row of parameters of the pulse train will increase the frequency and amplitude parameters, as shown in the figure below. By setting the frequency and amplitude parameters, each pulse signal of the pulse train will modulate a different RF carrier in turn.

Pulse Train:					
Index	On Time	Off Time	Count	Freq	Level
1	400.00 us	600.00 us	1	50.000000 kHz	0.00 dBm
2	1.00000 ms	1.00000 ms	1	1.000000000 MHz	-20.00 dBm



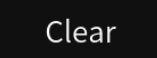
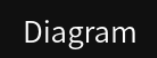
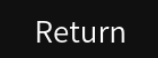

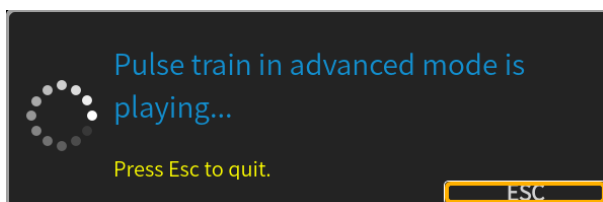







Figure 8-8 Pulse train advanced mode setting page

When the advanced modulation mode of the pulse train is turned on, the user interface will pop up the following prompt box. At this time, the user interface of the RF signal source is locked, the function buttons on the front panel are also blocked, and the user cannot perform other operations.



You can exit the advanced modulation mode of the pulse train by pressing the **ESC** button in the dialog box, or pressing the knob, **ESC/Close**, or **Enter** key of the front panel.

8.4.4.10 Pulse Out

The default state is off. Click the sliding switch to switch the pulse output state.

When the pulse output is turned on, the RF signal source will output the pulse signal generated by the internal pulse generator from the **[PULSE IN/OUT]** connector on the rear panel.

Note: When the pulse source is External, the pulse output state will be automatically turned off.

8.4.4.11 Pulse Out Polarity

Click **Pulse Out Polarity** to switch the polarity of the pulse signal output from the **[PULSE IN/OUT]** connector on the rear panel. The default is "Normal".

- Normal: Output positive polarity pulse signal.
- Inverse: Output negative polarity pulse signal.

8.4.4.12 Trigger Out

The default state is off. Click the sliding switch to switch the trigger output status.

When the trigger output is turned on, the RF signal source will output the trigger signal generated by the internal pulse generator from the **[TRIG IN/OUT]** connector on the rear panel.

Note: When the trigger mode is "Ext Trig" or "Ext Gate", the trigger output function will be automatically turned off. When the trigger mode of RF SWEEP or LF SWEEP is set to external, the trigger output function will also be automatically turned off.

8.4.4.13 Pulse Trigger

The trigger mode defaults to "Auto". The RF signal source offers five pulse trigger types: "Auto", "Key", "Bus", "Ext Trig" and "Ext Gate".

Click the drop-down box corresponding to the trigger mode to select the desired type.

- Auto: The signal source satisfies the trigger condition at any time.

- Key: When the trigger mode is selected as "key", the user interface will display the **Click to trigger** button. Each time you press the **Trigger** key or the **Click to trigger** button on the user interface, the RF signal source will start a pulse modulation.
- Bus: Each time the SCPI command "*TRG" is received, the RF signal source will start a pulse modulation.
- Ext Trig: When the trigger mode is selected as "Ext Trig", the user interface will display the "Trig Slope" button. At this time, the RF signal source receives the trigger signal input from the **[PULSE IN/OUT]** connector on the rear panel. Each time a TTL pulse signal of specified polarity is received, the RF signal source starts a pulse modulation.
- Ext Gate: When the trigger mode is selected as "Ext Gate", the user interface will display the "Trig Polarity" button. At this time, the RF signal source receives the trigger signal input from the **[PULSE IN/OUT]** connector on the rear panel. Each time a TTL pulse signal of specified polarity is received, the RF signal source starts pulse modulation within its effective level.

8.4.4.14 Trigger Delay

The trigger delay represents the delay of the pulse modulated signal from the reception of the external trigger signal to the start of the first pulse modulation. When the trigger mode is "Ext Trig", the user interface will display the **Trigger Delay** setting item.

8.4.4.15 Trigger Slope

The default is "Positive". Click the drop-down box to switch the trigger slope.

- Positive: Trigger a pulse when the positive slope of the external trigger signal arrives.
- Negative: Trigger a pulse when the negative slope of the external trigger signal arrives.

When the trigger mode is "Ext Trig", the user interface will display the **Trigger Slope** setting item.

8.4.4.16 Trigger Polarity

The default is "Normal". Click the drop-down box to switch the trigger polarity.

- Normal: Trigger pulse modulation during the high-level effective time of the external gate signal.
- Inverse: Trigger pulse modulation during the low-level effective time of the external gate signal.

When the trigger mode is "Ext Gate", the user interface will display the **Trigger Polarity** setting item.

8.5 LF

8.5.1 LF Source

The RF signal source has a built-in low-frequency signal generator, which can be used as a low-frequency signal output or an internal source for analog modulation. When used as a low-frequency signal output, LF supports several commonly used waveforms, and the frequency and amplitude of the low-frequency signal can be set.

Press the **LF** key on the front panel, select **LF Source** in the menu, or click **LF** Module > **LF Source** on the home page to enter the LF parameter setting interface.

8.5.1.1 LF State

Press **LF State** to turn LF output on or off.

8.5.1.2 LF Shape

Press **LF Shape** to select the waveform of the LF output signal. The supported waveforms are "Sine", "Square", "Sawtooth", "Triangle" and "DC". The default is "Sine".

8.5.1.3 LF Frequency

Press **LF Frequency** to set the frequency of the LF output signal.

- When the waveform is "Sine", the LF frequency setting range is 0.01 Hz ~ 1 MHz.
- When the waveform is "Square", "Sawtooth" or "Triangle", the LF frequency setting range is 0.01 Hz ~ 20 kHz.

8.5.1.4 LF Level

Press **LF Level** to set the LF output amplitude. The setting range is 1 mVpp ~ 3 Vpp. Multiple unit format settings are supported.

8.5.1.5 LF Level Offset

Press **LF Level Offset** to set the amplitude offset of the LF output. The setting range is

$$|LF \text{ Level Offset}| \leq \min(2.5 - \frac{1}{2}LEVEL, 2 \text{ V})$$

8.5.1.6 LF Phase

Press **LF Phase** to set the LF phase. The setting range is -360° ~ 360°, and it supports setting in degrees or radians.

8.5.2 LF Sweep

The RF signal source supports outputting LF waveforms that gradually change from the start frequency to the end frequency within a specified time, that is, LF output supports frequency sweeping. Press the **LF** key on the front panel, select **LF Sweep** in the menu, or click **LF** Module > **LF Sweep** on the home page to enter the LF Sweep parameter setting interface.

8.5.2.1 Sweep State

Press **Sweep State** to activate the LF frequency sweep signal generation.

8.5.2.2 Start Freq

Press **Start Freq** to set the start frequency of LF frequency sweep.

8.5.2.3 Stop Freq

Press **Stop Freq** to set the stop frequency of LF frequency sweep.

8.5.2.4 Center Freq

Press **Center Freq** to set the center frequency of LF frequency sweep.

8.5.2.5 Freq Span

Press **Freq Span** to set the frequency Span of LF frequency sweep.

8.5.2.6 Sweep Time

Press **Sweep Time** to set the duration of one LF sweep.

8.5.2.7 Direction

Press **Direction** to set the frequency direction of LF sweep to up or down.

- Up: Scan from the start frequency to the end frequency.
- Down: Scan from the end frequency to the start frequency.

8.5.2.8 Trigger Mode

The default LF trigger mode is "Auto". The RF signal generator provides four trigger types: "Auto", "Key", "Bus" and "Ext".

Click the drop-down box of **Trigger Mode** to select the desired type.

1. Auto

Generate a continuously repeating sweep signal immediately after activating the sweep mode.

2. Key

Each time the **Trigger** key on the front panel is pressed or the **Click to Trigger** button on the touch screen is clicked, the signal generator starts a sweep.

3. Bus

Each time the "*"TRG" command is sent, the signal generator starts a sweep.

4. Ext

The signal generator receives the external trigger signal input from the **[TRIG IN/OUT]** connector on the rear panel of the instrument. Each time a TTL pulse signal of a specified polarity is received, the signal generator starts a sweep.

Note: If the trigger mode is changed during the LF sweep, the signal generator will stop sweeping and return to the initial state until the next trigger event starts.

8.5.2.9 Trigger Slope

When the trigger mode is external, you can select the type of **Trigger Slope** to determine whether the sweep is triggered by the "Positive" or "Negative" of the external trigger signal. The default trigger edge is "Positive".

Click the drop-down box to start the corresponding trigger edge setting:

- Positive: When the rising edge of the external trigger signal arrives, the sweep is triggered.
- Negative: When the falling edge of the external trigger signal arrives, the sweep is triggered.

Please note that the **Trigger Slope** button will only be displayed when the trigger mode is "Ext", and it is hidden in other cases.

8.5.2.10 Sweep Shape

Press **Sweep Shape** to select the cyclic mode of LF sweep. There are two types: "Sawtooth" and "Triangle", and the default value is "Sawtooth".

- Sawtooth: Sweep period is always from the start frequency or start level to the stop frequency or stop level. The sweep sequence is similar to a "sawtooth wave".
- Triangle: Sweep period is always from the start frequency or start level to the stop frequency or stop level, and then return back to the start frequency or start level. The sweep sequence is similar to a "triangle wave".

8.5.2.11 Sweep Space

Press **Sweep Space** to select the mode for the calculation of the frequency sweep intervals.

- Linear: Take the frequency value entered as an absolute value in Hz.
- Log: Takes the value entered as a logarithmic value that means as a constant fraction of current frequency in %.

8.6 Power Sensor

The RF signal source can be connected to a USB power sensor through the USB Host interface. The power meter models currently supported by the RF signal source are shown in the following table:

Table 8-1 Power sensor model supported

Manufacturer	Model
R&S	NRP6A, NRP18A
	NRP8S, NRP18S, NRP33S, NRP40S, NRP50S, NRP67S
	NRP40T
Keysight	U2000A, U2001A, U2002A, U2004A
	U2000B, U2001B
	U2000H, U2001H, U2002H

8.6.1 Parameter Settings

Click the **POWER SENSOR** module on the home page to enter the power meter parameter setting interface.

Please note that when the power sensor is not connected or initialized, you cannot set any parameters for the power sensor measurement. At this time, the user interface will pop up the following prompt:

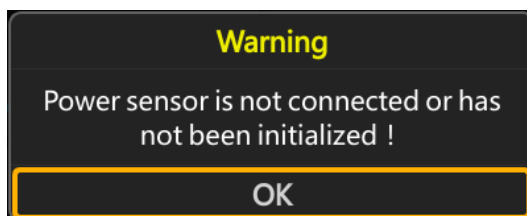

8.6.1.1 Sensor Info

Displays the model information of the connected power sensor. If the power sensor is not connected or initialized, the power sensor information is blank.

8.6.1.2 Sensor State

Turn on or off the level measurement by the power sensor. The default is "off".

After turning on the power sensor measurement function, the measurement control refreshes the power sensor measurement value in real time.

8.6.1.3 Measurement

Display the current reading of the sensor.

You can select the unit used for result display: dBm, dB μ V, uV, mV, V, nW, uW, mW, W.

8.6.1.4 Level Control

With the Level Control function, you can achieve very stable and accurate RF power your DUT. With the aid of a downstream control circuit, a CLPC (Closed Loop Power Control), you can detect frequency response characteristics of the components: such as losses due to cables, modules or components and compensate these effects accordingly.

For details, please refer to the introduction of the "Level Control" section.

8.6.1.5 Statistics

The Statistics function is disabled by default. When enabled, the statistics of the power sensor measurements will be displayed.

- On: Turn on the statistics function. The statistical parameters will be displayed next to the statistics switch. The statistical parameters include the average value, minimum value, maximum value and statistical times. Click the  button to clear all current statistical values and start a new round of statistics.
- Off: Turn off the statistics function. The statistical parameters will be automatically hidden.

8.6.1.6 Auto Zero

The power sensor zero adjustment function can reduce the impact of noise and zero deviation on the measurement results and improve the accuracy of RF power measurement.

Zero adjustment is disabled by default. Click the drop-down box to switch the zero adjustment type.

- Disabled: The zero buttons will be hidden.
- INT: Zero button is displayed.
- EXT: Zero button is displayed.

Click the "Click to perform zeroing" button and the power sensor will start the zero adjustment operation. At this time, the button name will change to "Zero Adjustment...". After the zero adjustment is completed, the button name will return to "Click to perform zeroing".

Please note when performing zeroing of the power sensor:

- 1) Generally, all measurement signals should be turned off before the power sensor performs zeroing. For specific operations, please refer to the user manual of the power sensor.
- 2) If the power sensor does not have the option of internal or external zeroing, the "INT" and "EXT" options in the drop-down box will be replaced by the "Enabled" option.

To reduce the impact of noise and zero deviation on the measurement results, it is recommended to

zero the power sensor in the following situations:

- Warm-up phase just after connecting to the signal source.
- Temperature change exceeds 5 °C.
- Connect the power sensor to the RF output port at high temperature.
- The power sensor has not been zeroed in the past 24 hours.
- Before measuring low-power signals, such as signals with expected measured power more than 10 dB below the lower limit of the measurement range.

8.6.1.7 Frequency

The measured frequency mode is "Auto" by default. Click the drop-down box to switch the mode.

- Auto: Automatically configure the power sensor's measurement frequency value based on the output frequency of the RF.
- Manual: The power sensor's measurement frequency value can be customized.

8.6.1.8 Level Offset

The level offset is set to "off" by default. Click the slide switch to turn the level offset on or off.

- On: The level offset value can be set at this time. The displayed reading value of the power sensor will be the actual measured value plus the level offset value. This function makes measurement easier when there are amplifiers and attenuators in the middle of the signal chain.
- Off: The level offset value setting will be automatically hidden. At this time the displayed reading value of the power sensor is consistent with the actual measured value.

8.6.1.9 Averaging

The averaging mode is "Auto" by default. Click the drop-down box to switch the averaging mode.

- Auto: Automatically configure the average times according to the current measurement. The average times are only displayed and cannot be modified.
- Manual: Manually set the average times of the power sensor measurement.

8.6.1.10 Logging

The log function is disabled by default. Click the slide switch to turn on or off the function. When the log function is turned on, the signal generator will record the measurement values and save them in a log file in TXT format.

The log file is saved in the path: Local:/power_sensor/.

8.6.2 Level Control

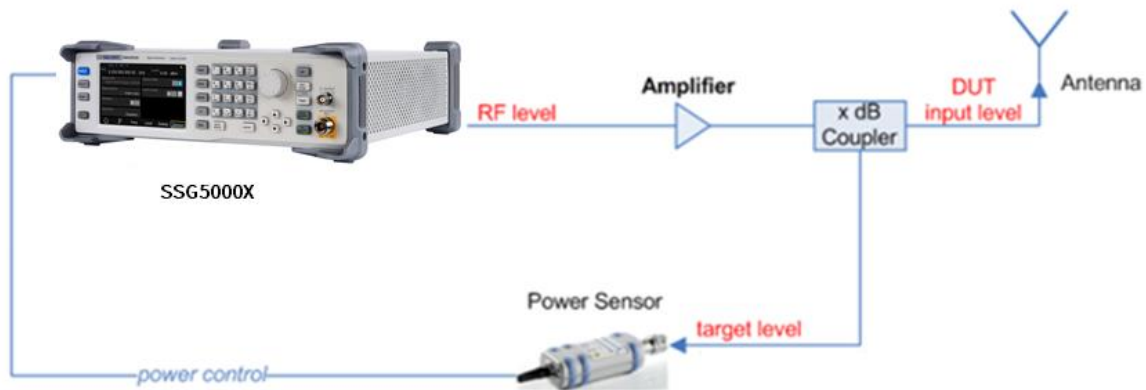

Figure 8-9 Power control

As shown above, the sensor measures a proportional power in defined time intervals, derived from a coupler. It considers optionally the given S-parameters and returns the results to the generator. The signal generator compares the measured level with the set value and adjusts its output level accordingly. This allows you to control the external signal level continuously and reliably reach a constant input level at the DUT in real time.

In practice, an RF splitter is needed to split the RF signal. One of them is connected to the DUT and the other is connected to the power meter. The signal source is for acquisition and compensation. Power compensation can be used to minimize cable losses, the attenuation of passive networks, and the amplification of the signal by a power amplifier and the frequency response of each device in the link as the frequency changes.

Note: When the RF sweep function is turned on, the level control function cannot be turned on. The RF sweep function must be turned off before turning on the level control function, and vice versa.

8.6.2.1 Level Control State

The default setting is "off". Click the slide switch to switch the on/off state.

This setting item is the same as the "Level Control" function in the upper menu.

8.6.2.2 Measurement

Display the current power sensor reading. You can click the drop-down box to change the current power display unit.

This setting item is consistent with the "Measurement" function in the upper menu.

8.6.2.3 Target Level

Specify the nominal level expected at the input of the sensor. The signal generator adjusts the output power accordingly, in order to meet the target value at the sensor input, thus meeting the power required by the DUT.

8.6.2.4 Level Limit

Set an upper limit for RF output power to protect your DUT from damage due to high input power. If the input RF signal power exceeds the limit, the set value will not take effect and the source will pop up a warning message.

8.6.2.5 Catch Range

The capture range means that if the power sensor reading is within the effective capture range, it is a valid reading and the RF signal is adjusted and compensated. Set the capture range of the control system. If the power sensor reading exceeds this range, the reading will be ignored.

Effective Capture Range = Target Level +/- Catch Range

8.7 IQ Modulation

IQ modulation, that is, two orthogonal signals (carriers with the same frequency and phase difference of 90° , generally expressed by Sin and Cos) and I (In-Phase, in-phase component) and Q (Quadrature Phase, quadrature component) signals are carrier modulated separately and then transmitted together, thereby improving spectrum utilization.

The IQ modulation functions of SSG5000X-V include: Custom, ARB, Stream, IoT, Multitone modulation and AWGN modulation, in addition to I/Q control settings. Please see the following chapters for details:

- Custom
- ARB
- Stream
- IoT
- Multitone
- AWGN
- I/Q Control

8.8 UTILITY

The UTILITY settings of the RF signal source include system settings and file management.

8.8.1 System

8.8.1.1 Setting

1. Language

Set the display language of the RF signal source. The signal source supports Chinese and English menu, help and interface display.

Press **UTILITY** > **Setting** > **Language** to expand drop down list, and then select the desired language.

2. Screen Saver

Set the state of screen saver. When screen saver is switched on, screen saver will be enabled if no action is taken within the specified time. Click the touch screen or press any key to resume.

Press **UTILITY** > **Setting** > **Screen Saver** to expand drop down list, and then select “off”, “10 s”, “1 min”, “5 min”, “15 min”, “30 min”, “1 hour” or “2 hour”.

3. Setup Type

Set the type of parameter configuration to be loaded when the instrument startup.

Press **UTILITY** > **Setting** > **Power On** to expand drop down list, and then select “Default” or “Last”.

- Default: The factory defined default settings will be loaded at power-on. For more details, please refer to “Table 8-5 Default Settings”.
- Last: The system setting before the last power-off will be loaded automatically at power-on.

4. Preset Type

Set the parameters for the Preset configuration of the instrument.

Press **UTILITY** > **Setting** > **Preset Type** to expand drop down list, and then select “Default” or “User”.

- Default: The default settings will be loaded when **PRESET** is pressed. For more details, please refer to “Table 8-5 Default Settings”.
- User: The user specified configuration will be loaded when **PRESET** is pressed.

Note: After selecting the preset type as “User”, the file management interface will automatically open to allow the user to load the configuration file. You can also click  to change the configuration file.

5. Factory Reset

Restore the instrument configuration to factory settings.

Press **UTILITY** > **Setting** > **Factory Reset**, set the instrument parameters and status to factory defaults.

To restore factory settings, in addition to loading the default settings, the following functions and parameters will also be configured.

Table 8-2 Factory Default

Parameters	Default Value
Setting	
Language	Chinese/English (depend on factory configuration)
Screen Saver	Off
Setup Type	Default
Preset Type	Default
Beeper	On
Power On Line	Off
10M Adjustment	Off
Interface	
DHCP State	Off
IP Address	10.11.13.220
Subnet Mask	255.255.255.0
Gateway	10.11.13.1
Auto DNS	Off
VNC Operable	On
FTP State	On
Hostname	Consistent with product model
GPIB Address	18
Level	
Flatness	Empty list
Sweep	
List sweep	Keep only one default sweep point "1,1.5 GHz,-110 dBm,50 ms"
Pulse	
Pulse Train	Keep only one default pulse "1,1 ms,1 ms,1"

6. Reset & Clear

“Reset & Clear” will restore the instrument configuration to factory settings, as well as clean up files stored by users in “Local” folder.

Press **UTILITY** > **Setting** > **Reset & Clear** to set the instrument parameters and status to factory defaults and clean up local files.

7. Beeper

Set whether the beeper make a sound when clicking any button, input box or check box.

Press **UTILITY** > **Setting** > **Beeper** to switch the beeper state.

8. Power On Line

Set the instrument power on sequence. In some situations, you may want the instrument to automatically restart if the line power is restored.

- Off: If line power is available, you need to manually press the power key on the front panel to start the instrument.
- On: If line power is available, the instrument starts automatically. This is an idea feature for automatic or remote tests that may be difficult to physically reach.

Press **UTILITY** > **Setting** > **Power On Line** to switch the state.

9. 10M Adjustment

Modifying the Reference Oscillator Code will change the reference frequency. You can externally connect a frequency counter from the 10MHz OUT connector on the rear panel and adjust the 10MHz reference by modifying the code.

- Press **Save Ref Osc Setting** to save “*.dac” file to store the Ref Oscillator Code you currently set.
- Press **Recall Ref Osc Setting** to recall the Ref Oscillator Code you have stored.
- Press **Reset to default** to set the Ref Oscillator Code to default value, and the reference frequency will reset to the original value, too.

Press **UTILITY** > **Setting** > **10M Adjustment** to switch the state.

10. Time Setting

Set the display time of the instrument.

Press **UTILITY** > **Setting** > **Time Setting** , then move the cursor to specified location and change the time by inputting the value.

11. Log Info

The log function mainly records the operation records and some important event records during the operation of the system. When certain problems occur, it can provide some prompt information or

traceback record information to users and developers.

Press **UTILITY** > **Setting** > **Time Setting** to view the log list of the RF signal source.

In the log info interface, you can also save or clear the log content.

8.8.1.2 System Info

Press **UTILITY** > **System Info** to view the instrument's system information, including:

- Model
- Host ID
- Serial Number
- Software Version
- Uboot-OS Version
- Hardware Version
- Startup Times

8.8.1.3 Interface

Press **UTILITY** > **Interface** to view the instrument's remote control interface information, including:

1. LAN Setting

1) Network Configuration

The RF signal source supports LXI standard network configuration.

- IP Setting

IP addresses can be assigned dynamically or statically. Open the **DHCP state** to set a dynamic IP. At this time, the DHCP server will automatically configure the IP address, subnet mask and gateway according to the current network conditions, and the user does not need to set it. Turn off the DHCP state and set a static IP. Users need to customize the IP address, subnet mask and gateway.

- Auto DNS

DNS can also be configured dynamically or statically. The static method requires manual input of the DNS address, and the automatic method directly uses the information returned by the DHCP server.

2) Network reset (LCI)

The LCI mechanism is to prevent incorrect network configuration or forgotten configuration information from causing the device to be unable to modify or access the network.

Click the LXI  button to enter the network reset interface, which includes the device identification indicator light **LXI**, the **LAN Reset** button, and a list of items affected by the network reset.

- You can click the **LAN Reset** button to reset the network.
- The RF signal source supports the LXI standard web interface. On the VNC home page of the signal source, click the **Start** button of **Instrument Identification**, and you can see the device identification indicator light **LXI** flashing on the network reset interface.

2. Web Setting

Web Setting includes the settings of VNC Operable state, FTP state, Hostname and Web password. Press **UTILITY** > **Interface** and scroll the scroll bar on the right side of the window to see the entire Web Setting content.

1) VNC Operable

Turn the Web control function on or off by turning the **VNC Operable** button on or off. When the VNC operation is enabled, users can control the instrument through a Web browser. Enter the IP address of the signal generator in a Web browser, and you can log in to the VNC.

If you want to control the instrument or send SCPI in the VNC, a dialog box will pop up where you need to enter your login password. You can set the log in password in **Web Password Setting**.

2) FTP State

When the FTP state is turned on, users can download files in the "Local" folder of the signal generator to a personal computer through the free software FileZilla, or upload files from a personal computer to the "Local" folder of the signal generator. You can view the application example "Download/Upload Files Using FTP (LAN)".

3) Hostname

Set the hostname of the signal generator. If the host resides on the same network segment as the signal generator, you can enter <http://Hostname.local> in the web browser to log in to the VNC.

4) Web Password

Press **Web Password Setting** to enter the Web Password Setting interface. You can change the password by entering the Current password, New Password and Confirm password. You can also set the password to the default value "siglent" by clicking the "Reset to default" button.

3. GPIB Setting

Set the GPIB address from 1 to 30. A SIGLENT USB-GPIB adapter should be connected to the USB Host port of the RF signal source to expand the instrument's USB interface into a GPIB interface.

8.8.1.4 Self Test

Press **UTILITY** > **Self Test** to enter the system's self-test interface.

1. LCD Test

Press **LCD Test** to enter the screen detection.

The RF signal source cycles through the red, green and blue pixels of the display to verify whether there are dot defects on the screen.

Press **7** to change the color and press **8** to exit.

2. Key Test

Press **Key Test** to enter the keyboard test interface. Press the function keys at the front panel one by one and observe whether the corresponding key is checked. If not, an error may have occurred in the key. To exit the test, press **8** three times or click the screen.

3. LED Test

Press **LED Test** to enter the LED test interface. Press **7** to light or extinguish the key light of the button **MOD ON/OFF** and **RF ON/OFF** and press **8** to exit the test.

4. Board Test

Press **Board Test** to enter the board test interface. Test whether writing and reading are normal for CPLD and FPGA.

5. Touch Test

Press **Touch Test** to enter the touch screen test interface. Click the marks on the interface to test the touch screen and press **8** to exit the test.

8.8.1.5 Shutdown

Press **UTILITY** > **Shutdown** to power off the instrument according to operating hints on the interface.

8.8.1.6 Preset

Reset parameter settings according to the type of preset.

Press **UTILITY** > **Preset** to reset the parameters.

8.8.1.7 Update

Press **UTILITY** > **Update** , and select the update file. Then click **Recall** to update the system software. The progress bar will appear on the screen while updating and the instrument will restart automatically if updates succeed or pop-up prompt box if updates fail.

8.8.1.8 Option

Press **UTILITY** > **Option** , to enter the option interface. Click the drop-down box under the “Install” group box to choose the license type need to be installed. Enter a license in the input box and click **Install** to finish the license installing.

If the installations succeed, the prompt message “license was successfully installed” will be pop-up. If not, the prompt message “license was entered incorrectly” will be pop-up.

Note: The SSG comes with trial options that have a finite number of uses. It allows users to evaluate the options without purchasing them. You can find the remaining number of trials at the top of the option interface. When the remaining time of a certain function is zero, the function will be disabled. When a license is successfully installed for a certain function, the remaining times will be shown as “-” and the type of the license will be permanent, which means users have unrestricted access to the function.

Option Name	License Type	Remaining Times
SSG5000X F60	Permanent	--
SSG5000XV B150	Permanent	--
SSG5000X-PT	Temporary	0
SSG5000XV-IOT	Temporary	30
10M_OCXO_L	Permanent	--
SigIQPro-OFDM	Temporary	24
SigIQPro-BT	Temporary	29
SigIQPro-IOT	Temporary	30

Please refer to the data sheet for the option types of SSG5000X/X-V. Among them, 10M_OCXO_L is a high-precision reference source option, and users need to confirm whether to install it before the instrument leaves the factory.

8.8.1.9 Help

The built-in help system provides help information for each function and menu option on the front panel.

1. Press **UTILITY** button and select **Help** to enter help interface.
2. Click to enter the corresponding directory.

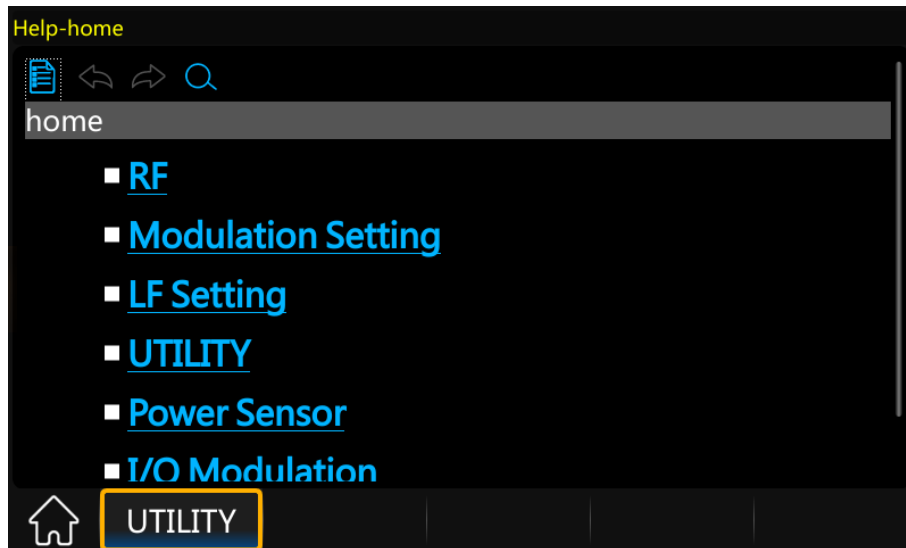

Figure 8-10 Help interface

8.8.1.10 Contact Us

Press **UTILITY** > **Contact Us** to view the contact information for SIGLENT. You can contact us to solve the problems meet in practical use. You can also write info@siglent.com or call your local SIGLENT sales office for support.

8.8.2 File

Press **UTILITY** > **Store/Recall** to enter file management page.

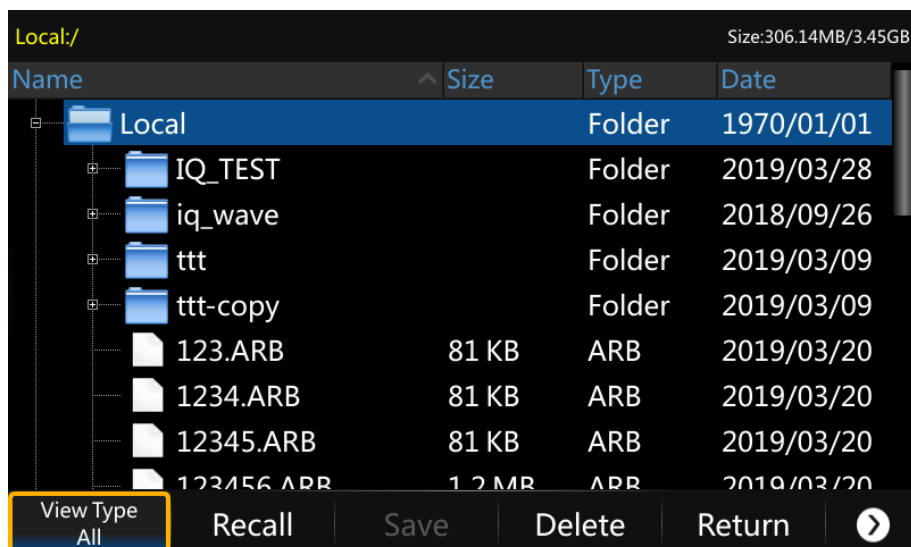

Figure 8-11 File management page

In the file management page, the top bar displays the currently selected path, folder or file, as well as

the size of the used memory and available memory in the Local path or USB flash drive. A file list is displayed in the middle of the interface. You can select files and fold or expand folders by tapping the touch screen. You can also use the up and down keys to select files and the left and right keys to collapse or expand folders. The bottom bar of the interface displays operation buttons. The specific operations are as follows.

1. View Type

Click **View Type** to change the type of files to show, including “All”, “State” and “Update”.

Table 8-3 File Type

File Type	File Extension	Description
All	LSW	Sweep list file
	UFLT	Flatness correction file
	PULSTRN	Pulse train file
	ARB	IQ waveform segment file
	MARKER	IQ waveform segment marker file
	SEQ	IQ waveform sequence file
	SHEADER	IQ waveform sequence header file
	STREAM	IQ Stream file
	MULSTATE	IQ Multitone file
	UDATA	PN sequence file of I/Q modulation
	MAP	Constellation diagram file of I/Q modulation
	ML	ARB multi-carrier list file for I/Q modulation
	DAC	Reference oscillator code file
	TAR.GZ	System running log
	TXT	Power sensor log file
	State	XML
Update	CFG	Configuration update file
	ADS	System update file

2. Recall

Click **Recall** to load the selected file.

3. Save

Click **Save** to save the file with corresponding type according to the type of data.

4. Delete

Click **Delete** to delete the selected file or folder.

5. New Dir

Click **New Dir** to create new folders.

6. Rename

Click **Rename** to rename a file or folder.

7. Copy

Click **Copy** to copy the selected file or folder.

8. Paste

Click **Paste** to paste the copied file or folder to specified location.

8.9 Shortcut Keys

There are some shortcut keys on the front panel of the RF signal source to quickly perform specific functions. These shortcut keys include:

Table 8-4 Shortcut Keys

Shortcut Keys	Function
PRESET	Quick preset
HOME	Quick return to home page
ESC/Close	Exit remote mode or edit mode
Trigger	Execute key trigger
MOD ON/OFF	Modulation master switch
RF ON/OFF	RF output switch

8.9.1 PRESET

Recall the preset settings and restore the signal generator to a specified state.

- Press **UTILITY** > **Setting** > **Preset Type** to select "Default" or "User". When selecting the preset type as "User", you need to select the preset state file.
- Press **PRESET**, and the instrument will recall the default settings or user settings. The default settings are shown in the table below.

Table 8-5 Default Settings

Parameter	Default Value
RF	
RF State	Off
Frequency	
Frequency	6 GHz
Freq Offset	0 Hz
Phase Offset	0 deg
Level	
Level	-130 dBm
Level Offset	0 dB
ALC State	Auto

Flatness	Off
Sweep	
Sweep State	Off
Sweep Mode	Continuous
Direction	Up
Trigger Mode	Auto
Point Trigger	Auto
Trigger Slope	Positive
Step Sweep	
Step Sweep State	On
Start Freq	6 GHz
Stop Freq	6 GHz
Start Level	-130 dBm
Stop Level	-130 dBm
Sweep Points	11
Dwell Time	30 ms
Sweep Space	Linear
Sweep Shape	Sawtooth
List Sweep	
List Sweep State	Off
ANALOG MOD	
ANALOG MOD State	Off
AM	
AM State	Off
AM Source	Int
AM Shape	Sine
AM Rate	1 kHz
AM Depth	50 %
FM	
FM State	Off
FM Source	Int1

FM Shape1	Sine
FM Deviation1	100 kHz
FM Rate1	10 kHz
PM	
PM State	Off
PM Source	Int
PM Shape	Sine
PM Rate	10 kHz
PM Deviation	1 rad
Pulse	
Pulse State	Off
Pulse Source	Int
Pulse Mode	Single
Pulse Period	10 ms
Pulse Width	2 ms
Double Pulse Delay	4 ms
#2 Width	2 ms
Pulse Trigger	Auto
Trig Delay	140 ns
Trigger Slope	Positive
Trig Polarity	Normal
Pulse Train	Off
Trigger Out	On
Pulse Out	Off
Pulse Out Polarity	Normal
LF	
LF Source	
LF State	Off
LF Shape	Sine
LF Frequency	1 kHz
LF Level	500 mVpp

LF Offset	0 uV
LF Phase	0 deg
LF Sweep	
Sweep State	Off
Start Freq	500 Hz
Stop Freq	1.5 kHz
Center Freq	1 kHz
Freq Span	1 kHz
Sweep Time	1 s
Trigger Mode	Auto
Sweep Shape	Sawtooth
Trigger Mode	Linear
Direction	Up
IQ MOD	
IQ MOD State	Off
Custom	
Custom State	Off
Data Setup	PN7
Seed (Hex)	7F
Symbol Rate	1 MSps
Symbol Length	512
Bits/Symbol	4
Mod Type	16QAM
Gray	Off
Filter Type	RootCosine
Filter Alpha	0.35
Filter Length	128
Oversampling	2
ARB	
ARB State	Off
Select Waveform	*NONE

ARB Setup	
Sample Clock	2 MHz
Modulator Atten Type	Auto
Modulation Atten	3 dB
Real Time AWGN	Off
Output Mux	Carrier+Noise
Power Control Mode	Total
Total Power	0 dBm
Carrier to Noise Ratio Format	C/N
Carrier to Noise Ratio	0 dB
Carrier Bandwidth	1 Hz
Flat Noise Bandwidth	1 Hz
Filter Type	None
Baseband Offset	Off
Multi Carrier	
Waveform Name	MULTICARRIER
Power Reference	Peak
Carrier Table	SINE_WAVE,0,0,0
Signal Period Mode	LCM
Signal Period	100 us
Sampling Rate	2 MHz
Marker Utilities	
Marker Number	1
Output Mux	1
Marker Polarity	Negative
Pulse/RF Blank	Off
Marker Delay	0 us
Set Markers	1,1,0
Waveform Utilities	
Select Segment	*NONE
Scaling	100 %

Clipping Type	I+jQ
Clip I+jQ to	100 %
Trigger	
Trigger Type	Continuous
Continuous Mode	Free Run
I/Q Control	
I/Q Mod State	Off
I/Q Source	Internal
Compensation Channel	RF
I/Q Adjustment	On
Gain Balance	0 dB
I Offset	0 %
Q Offset	0 %
Quad Angle Adjustment	0 deg
I/Q Swap	Off
I/Q Output	Off
I/Q Output Atten	0 dB
I/Q Output Gain Balance	0 dB
I Output Offset	0 uV
Q Output Offset	0 uV
I/Q Common Offset	0 uV
Stream	
Stream State	Off
Select Stream File	*NONE
Stream Setup	
Sample Clock	2 MHz
Modulator Atten Type	Auto
Modulation Atten	3 dB
Baseband Offset	Off
IoT	
Protocol Type	ZigBee

Trigger Type	Continuous
Continuous Mode	Free Run
Marker 1 Source	Frame Start
Marker 2 Source	Frame Start
ZigBee	
ZigBee State	Off
Oversampling Ratio	8
Number of Frames	1
PHY Scheme	O-QPSK
Idle Interval	100 us
Frequency Band	868 MHz
MAC FCS	On
MAC Frame Type	General
MAC Header State	On
MAC Header	8821,01,1234,5678,4321,8765,,,
Data Type	PN9
Seed (Hex)	1FF
Data Length	20 Octets
Data Mode	Truncated
Symbol Timing Error	0 ppm
Frequency Offset	0 Hz
Z-Wave	
Z-Wave State	Off
Oversampling Ratio	8
Number of Frames	1
Data Rate	R1-9.6 kbps
Modulation	FSK
Idle Interval	100 us
Ramp Symbols	10
Ramp Up/Down Symbol	First/Last
Preamble Length	10 Octets

Start of Frame Delimiter (Hex)	F0
MAC Header State	On
MAC Header	12345678,01,3412,2A,01,01
Data Type	PN9
Seed (Hex)	1FF
Data Length	32 Octets
Data Mode	Truncated
MAC FCS	On
End of Frame Delimiter	On
Symbol Timing Error	0 ppm
Frequency Offset	0 Hz
Frequency Deviation Scaling	100 %
Guassian BT	0.6
Multitone	
Multitone State	Off
Tone Number	2
Single Side	Off
Sample Rate	2 MHz
Freq Spacing	1 MHz
AWGN	
AWGN State	Off
Bandwidth	10 MHz

8.9.2 HOME

Press the button in any menu to quickly return to the main interface.

8.9.3 ESC/Close

This shortcut key has the following functions:

- Press this key to switch the instrument from remote control to manual control.
- During parameter editing, press this key to clear the input and exit parameter editing mode.
- In a dialog box containing an "ESC" button, press this key to close the dialog box.

- Exit the current menu and return to the previous menu.

8.9.4 Trigger

This shortcut key has the following functions:

- When the trigger mode of RF sweep is Key, press this key once to trigger a sweep.
- When the point trigger mode of RF sweep is Key, press this key once to trigger a point sweep.
- When the trigger mode of pulse modulation is Key, press this key once to start a pulse modulation.
- When the trigger mode of LF sweep is Key, press this key once to trigger a LF sweep.
- When the trigger mode of IQ modulation is Key, press this key once to trigger an IQ modulation.

8.9.5 MOD ON/OFF

Press this key to turn on the RF modulation, the key backlight turns on, and the MOD icon in the user interface status bar changes from gray to blue. Press this key again to turn off all the modulations, the key backlight turns off, and the MOD icon in the user interface status bar changes from blue to gray.

8.9.6 RF ON/OFF

Press this key to turn on the RF output, the key backlight turns on, and the RF icon in the user interface status bar changes from gray to blue. Press this key again to turn off the RF output, the key backlight turns off, and the RF icon in the user interface status bar changes from blue to gray.

8.10 Custom

Custom IQ modulation types include QAM, ASK, PSK, FSK, and MSK modulation. You can also customize IQ data for modulation.

8.10.1 Custom State

Press **I/Q** > **Custom** > **Custom State** to turn on or off the Custom modulation.

8.10.2 Data Source

Press **I/Q** > **Custom** > **Data Source** to set the symbol data that to be modulated.

8.10.2.1 Data Setup

Selects a data source type for modulation.

Choices: PN7 | PN9 | PN15 | PN23 | User. Default: PN7 (Seed: 0x7F).

- For PN7, PN9, PN15 and PN23 selections, the software automatically generates the data source bits. At this time the Seed field is available, and you can input the PN seed in **Seed (Hex)**.
- For User selection, the **User Data** button appears instead the **Seed (Hex)** button. You can click the setting button to enter the user data editing interface.

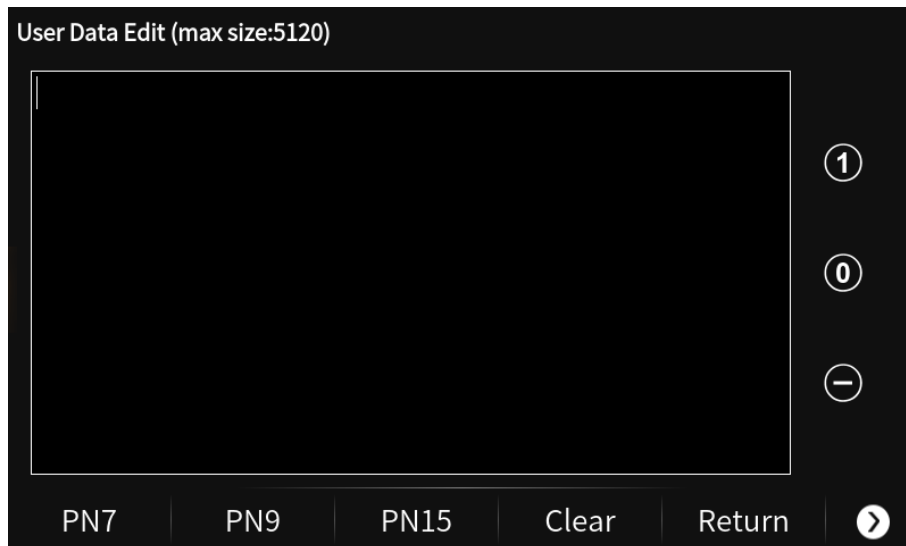



Figure 8-12 Pseudo-random code editing interface

- 1) Press **1** and **0** to add single bits. Press **-** to delete single bits.
- 2) Data editing: After selecting the editing position, you can enter the numbers 0 and 1 through the touch screen keys or the front panel keyboard, or delete them.
- 3) Click **PN7** / **PN9** / **PN15** to insert PN7 or PN9 or PN15.
- 4) Click **Clear** to empty the edited PN code.

- 5) Click **Return** to return to the previous menu.
- 6) Click  > **Load** to select and load a UDATA file.
- 7) Click  > **Save** to save the current PN code to the UDATA file.

8.10.2.2 Seed (Hex)

When select "PN7 | PN9 | PN15 | PN23" as the data source type, you can set the PN seed. The value is displayed in hexadecimal.

Range: PN7: 0 ~ 7F, PN9: 0 ~ 1FF, PN15: 0 ~ 7FFF, PN23: 0 ~ 7FFFFFF.

Default: PN7: 7F, PN9: 1FF, PN15: 7FFF, PN23: 7FFFFFF.

8.10.2.3 Symbol Rate

Sets the symbol rate (symbols per second) of the waveform.

Range: (1000/Oversampling) to (240000000/Oversampling) Sps or 120 MSps, whichever is lower.

Default: 1 MSps.

8.10.2.4 Symbol Length

Sets the length of modulated symbols.

Range: 100 to 100000.

Default: 512.

8.10.2.5 Bits/Symbol

Displays the number of bits contained in a modulation symbol. This parameter is read-only and cannot be set.

8.10.3 Modulation

Press  > **Custom** > **Modulation** to select modulation type.

8.10.3.1 Modulation Type

Choices: QAM | ASK | PSK | MFSK | User. Default: QAM.

- QAM

Select a type in the QAM category for modulation.

Choices: 16QAM | 32QAM | 64QAM | 128QAM | 256QAM | 512QAM. Default: 16QAM.

- ASK

Select a type in the ASK category for modulation.

Choices: 2ASK | 4ASK | 8ASK | 16ASK. Default: 2ASK.

- PSK
Select a type in the PSK category for modulation.
Choices: BPSK | QPSK | 8PSK | DBPSK | DQPSK | D8PSK | OQPSK | PI/4-DQPSK | PI/8-D8PSK. Default: BPSK.
- MFSK
Select a type in the MFSK category for modulation.
Choices: 2FSK | 4FSK | 8FSK | 16FSK | MSK. Default: 2FSK.
- User
When "User" is selected as the modulation type, users can customize the IQ data. For details, please see "User IQ Data".

8.10.3.2 User IQ Data

When "User" is selected as the modulation type, the **Custom** setting button will appear. Click the setting button to enter the editing page of the custom IQ data.

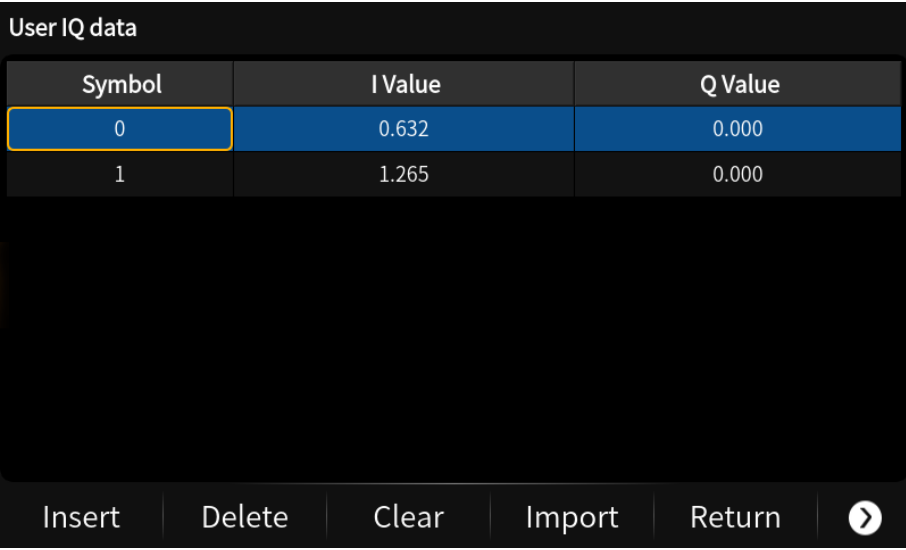

Symbol	I Value	Q Value
0	0.632	0.000
1	1.265	0.000

Insert | Delete | Clear | Import | Return | >

Figure 8-13 User IQ data editing page

As shown in the figure above, the editing page of custom IQ data consists of an IQ data list and a menu at the bottom, where the IQ data list consists of symbols, I values, and Q values.

- 1) Click **Insert** to insert a row before the currently selected row. The newly inserted row will copy the currently selected row.
- 2) Click **Delete** to delete the currently selected row.
- 3) Click **Clear** to restore the IQ data to default value (2ASK).
- 4) Click **Import** to import IQ data of 2ASK / 16QAM / 32QAM / 64QAM / 128QAM / 256QAM / 512QAM / BPSK / QPSK / 8PSK.

- 5) Click **Return** to return to the previous menu.
- 6) Click **>** > **Load** to select and load an IQ data file (*.MAP).
- 7) Click **>** > **Save** to save the current IQ data to a MAP file.
- 8) Click each parameter in the table area to set them through the touch screen keyboard or the front panel keypad.
- 9) Click **>** > **Graph** to open the constellation and edit IQ symbols. The constellation editing page is as follows:



As shown in the figure above:

- The left side of the page is the editing area, which displays the number and I/Q values of the currently selected symbol.
- The right side of the page is the constellation diagram, and the red point is the currently selected point. You can select and move the symbol through the touch screen.
- The bottom of the page are operation buttons, which can insert or delete symbols.

Note: When editing constellation points, the number of points must be a power of 2, otherwise an error message will appear when clicking the "Update" button.

8.10.3.3 Gray

When the modulation type is QAM | ASK | PSK | User, you can turn on or off the Gray code of IQ data. Default is off.

8.10.3.4 FSK Deviation

When the modulation type is selected as 2FSK | 4FSK | 8FSK | 16FSK, the **FSK Deviation** setting is displayed.

FSK Deviation is used to set the frequency deviation of FSK modulation in Hertz (Hz).

Range: $0 \sim 0.8 * \text{Symbol Rate} * \text{OverSampling}$.

Default: 600 kHz.

8.10.4 Filter

Press **I/Q** > **Custom** > **Filter** to enter the filter settings for Custom modulation.

8.10.4.1 Filter Type

Set the filter type for current modulation.

Choices: RaiseCosine | RootCosine | Gaussian | HalfSine | None.

Default: RootCosine.

Note: For HalfSine filter, only OQPSK modulation type is supported.

8.10.4.2 Filter Alpha/BT

Set the Alpha factor of the filter (BT for Gaussian filter).

Filter Alpha range: 0.01~1, default: 0.35.

Filter BT range: 0.1 ~ 1, default: 0.5.

8.10.4.3 Filter Length

Set the symbol length of the filter.

Range: 1~512.

Default: 128.

8.10.4.4 OverSampling

Set the oversampling ratio of the waveform. The waveform sampling rate is determined by the symbol rate and oversampling ratio.

Range: 2 - 32.

Default: 2.

Note:

- For OQPSK modulation, the oversampling rate must be even.
- For HalfSine filter, the oversampling rate must be greater than or equal to 8.

8.10.5 Update

Regenerate waveform data according to current settings.

Note: If the Update button flashes, it means that the current settings have been changed or the update has failed. If the current settings have been changed, you need to click the Update button to regenerate the waveform data. If the update fails, you need to modify the incorrect modulation

parameters and then click the Update button.

8.10.6 Save Waveform

Click the **Save Waveform** button to save the current Custom settings to an ARB file.

8.11 ARB

8.11.1 ARB State

Press **I/Q** > **ARB** > **ARB State** to turn ARB on or off.

8.11.2 Select Waveform

Press **I/Q** > **ARB** > **Select Waveform** to enter the volatile waveform segment and waveform sequence directory and select the waveform segment or waveform sequence to be played.

- Volatile memory, baseband generator (BBG) media, where waveform files are played from or edited.
- Non-volatile memory, either internal (int) or external (USB) media, where waveform files are stored. However, waveform files stored in non-volatile memory cannot be played directly.

Note: For waveform files stored in non-volatile memory that are less than 32 MSa in size, you can load the waveform from non-volatile memory to volatile memory by pressing **I/Q** > **ARB** > **Waveform Segment** > **Load** or **I/Q** > **ARB** > **Waveform Sequence** > **Load** .

8.11.3 Waveform Segment

Press **I/Q** > **ARB** > **Waveform Segment** to access the volatile waveform segment directory. Waveform segment must reside in volatile storage before they can be played, edited, or included in a sequence.



Segment	Point
RAMP_WAVE	200
SINE_WAVE	200

Buttons: Load, Save, Delete, Rename, Return, >

Figure 8-14 Catalog of volatile WFM

As shown in the figure above, the catalog of the volatile waveform segments includes a waveform segment list and operation buttons at the bottom. And the waveform segment list includes the waveform name and the number of waveform segment points.

1. Load

Load the waveform segment file in the non-volatile memory to the volatile memory. After the loading is successful, the name and points of the waveform segment will be added in the waveform segment list.

Now you can choose to play the waveform segment:

- 1) Press **I/Q** > **ARB** > **Select Waveform** to select the waveform segment to be played.
- 2) Turn on **ARB State**.
- 3) Turn on the I/Q MOD module switch on the home page, or turn on **MOD ON/OFF**.
- 4) Configuring RF Output.

The carrier modulated by the waveform segment is now available at the signal generator's **[RF OUTPUT 50Ω]** connector.

2. Save

Stores a waveform file in the volatile memory to the non-volatile memory. Optionally renames the waveform segment.

3. Delete

Delete the waveform segment from the volatile memory. At this time, you can no longer select the waveform segment to play in **Select Waveform**.

4. Rename

Rename the selected waveform segment.

5. Clear

Clear all files in the waveform segment list.

8.11.4 Waveform Sequence

8.11.4.1 About Waveform Sequence

A waveform sequence can contain one or more waveform segments or other waveform sequences, or both. This allows SSG5000X-V to play multiple waveform segments or sequences continuously without stopping.

A waveform sequence can contain up to 1024 segments, and can also include both segments and other sequences (nested sequences). The signal generator can let you set the number of times the

segments and nested sequences repeat in a waveform sequence:

- Each segment can repeat up to 65535 times, but only counted as one segment;
- However, the repetition of a nested sequence counts as additional segments.

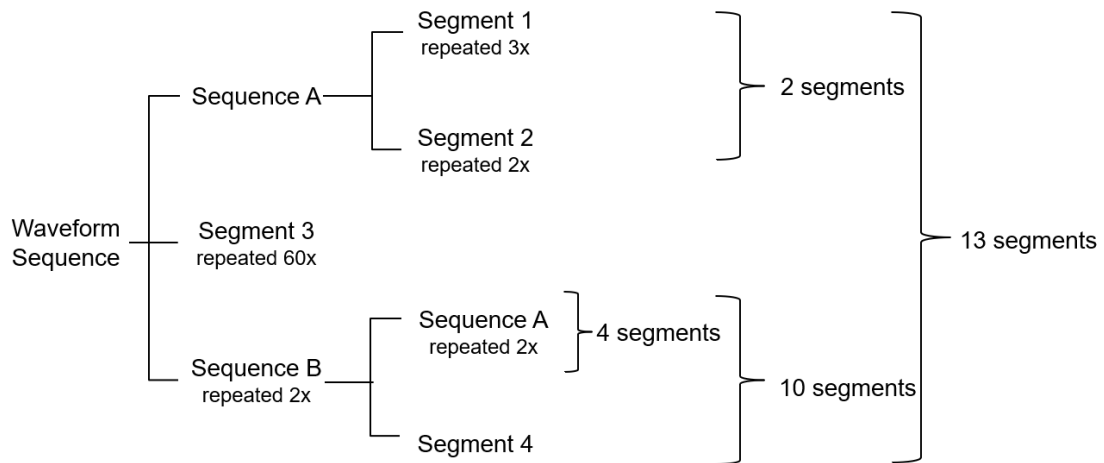

For example, if a waveform sequence contains 24 segments and one nested sequence with 10 segments, the nested sequence can only repeat $(1024-24) / 10 = 100$ times at most.

8.11.4.2 Operations on Waveform Sequence

Press **I/Q** > **ARB** > **Waveform Sequence** to enter the waveform sequence directory.

Catalog of SEQ Files	
Sequence	Size
SEQ1	1024
SEQ2	6144

Build Rename Delete Edit Return >

Figure 8-15 Catalog of waveform sequence

As shown in the figure above, the waveform sequence directory includes a sequence list and operation buttons at the bottom. The sequence list will display the created waveform sequence, including the sequence name and sequence size.

1. Build

Press **Build** to create a sequence. All operations of creating a waveform sequence can be realized through the touch screen of the signal generator:

- On the left side, click to add the segment or sequence to the new sequence.
- On the right side, click **Reps#** of the segment or sequence to change its repetitions.
- On the right side, click **Marker** of the segment or sequence to turn on or off its markers.
- Click the operation button at the bottom to perform delete, insert, clear, and save operations.
- After editing the waveform sequence, click **Save** and then name it to complete the creation of the waveform sequence.

Note: Only waveform segments in volatile memory can be added to a waveform sequence.

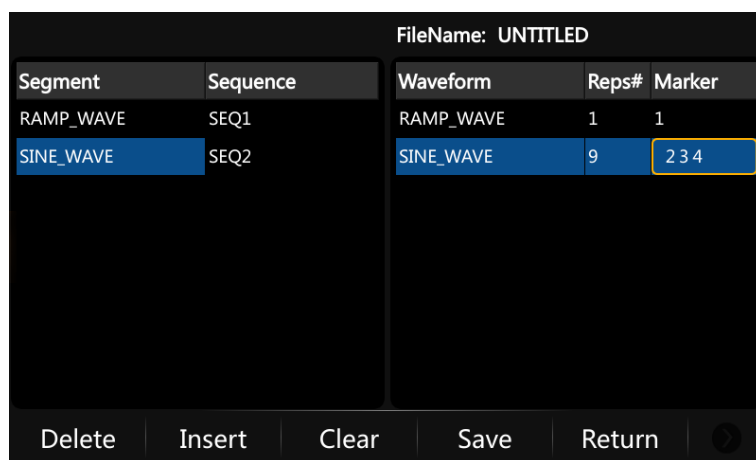

2. Rename

Rename the selected waveform sequence.

3. Delete

Delete the waveform sequence from the sequence list. At this time, you can no longer select and play this waveform sequence in **Select Waveform**.

4. Edit

For a waveform sequence in the sequence list, you can click the **Edit** button to modify the waveform, waveform repetition times, and mark of the waveform sequence.

5. Load

Load the waveform sequence file (*.SEQ) in the non-volatile memory into the waveform sequence list.

8.11.4.3 Example: Play a Sequence

After creating a sequence, you can choose to play it:

- 1) Press **I/Q** > **ARB** > **Select Waveform** to select the waveform sequence to be played.
- 2) Turn on **ARB State** .
- 3) Turn on the I/Q MOD module switch on the home page, or turn on **MOD ON/OFF** .
- 4) Configuring RF Output.

The carrier modulated by a waveform sequence is now available at the signal generator's **[RF OUTPUT 50Ω]** connector.

8.11.5 ARB Setup

Press **I/Q** > **ARB** > **ARB Setup** to enter the arbitrary waveforms setting interface. The waveform generator supports a variety of settings for arbitrary waveforms to meet a wider range of applications requirements.

8.11.5.1 Sample Clock

Set the sampling rate of arbitrary waveforms.

Range: 0.002 Hz ~ 240 MHz, and default is 2 MHz.

8.11.5.2 Modulator Atten

Users can adjust the amplitude of the I and Q signals before entering the IQ modulator. When the modulator attenuation type is set to manual, the waveform generator can set the appropriate modulator attenuation value to obtain the best ACPR characteristics.

- When **Modulator Atten Type** is set to Auto, the **Modulation Atten** value is 3 dB.
- When **Modulator Atten Type** is set to Manual, the **Modulation Atten** value can be set to 0 ~ 20 dB.

8.11.5.3 Real Time AWGN

Press **I/Q** > **ARB** > **ARB Setup** > **Real Time AWGN** to enter the AWGN (Additive White Gaussian Noise) setting interface. By turning on this function, SSG5000X-V enables you to apply additive white gaussian noise (AWGN) to a carrier in real time while the modulating waveform plays in ARB.

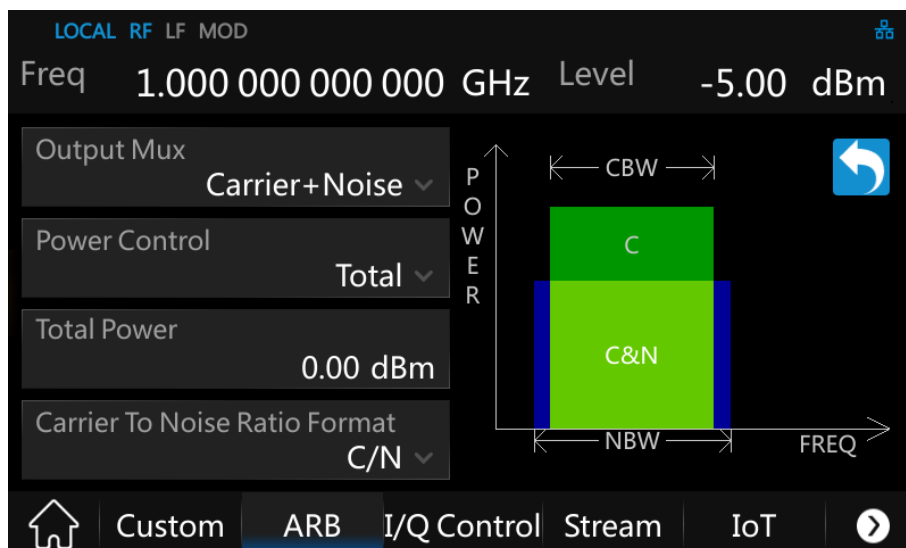

Figure 8-16 Real-time AWGN setting interface

8.11.5.3.1 Output Mux

Set the type of RF output, including "Carrier + Noise", "Carrier" and "Noise".

- Carrier + Noise: Both noise and carrier are output from the internal baseband generator.
- Carrier: Only carrier is output from the internal baseband generator.
- Noise: Only additive noise is output from the internal baseband generator.

With the ALC off, this feature enables direct measurement of the carrier or the noise contributions independently from the total power.

8.11.5.3.2 Power Control

Set the power of carrier and noise.

- Total: Set the total power, namely the sum of the carrier power and total noise power. The carrier power and total noise power change as any noise parameter is adjusted to keep the total power and the C/N at their last specified values.
- Carrier: Set the carrier power. The total power and total noise power change as any noise parameter is adjusted to keep the carrier power and the C/N at their last specified values.
- Total Noise: Set the total noise power. The total power and carrier power change as any noise parameter is adjusted to keep the total noise power and the C/N at their last specified values.
- Channel Noise: Set the channel noise power, namely integral power of noise in carrier bandwidth. The total power, carrier power and total noise power change as any noise parameter is adjusted to keep the total noise power and the C/N at their last specified values.

8.11.5.3.3 Carrier to Noise Ratio Format

Selects either the Carrier to Noise Ratio (C/N) or energy per bit over noise power density at the receiver (E_b/N_o) as the variable controlling the ratio of the carrier power to noise power in the carrier

bandwidth.

Eb/No Carrier Bit Equation:

$$C/N = Eb/No + 10 \log_{10} \frac{\text{bitRate}}{\text{CBW}}$$

When Eb/No is selected, the **Carrier Bit Rate** setting appears and can be used to calculate the Eb/No value.

8.11.5.3.4 Carrier Bandwidth

For the selected carrier to noise ratio, the carrier power and channel noise power are integrated over the carrier bandwidth. Typically, Carrier Bandwidth (CBW) is the occupied bandwidth of the carrier.

8.11.5.3.5 Flat Noise Bandwidth

The actual flat noise bandwidth (NBW) should be slightly wider than the carrier bandwidth (typically 1.6 times wider). The occupied bandwidth is = (1.25 * the Flat Noise Bandwidth).

8.11.5.4 Modulation Filter

Set whether the ARB waveform passes through the filter. The optional filter types are RaisedCosine, RootCosine, Gaussian, HalfSine and None, and the default value is None.

After selecting the filter type, you need to set the corresponding filter parameters and finally click the Update button. The filter settings will be applied to the waveform played by ARB.

This filter is applied as the ARB waveform plays, rather than in the waveform data itself.

8.11.5.5 Baseband Offset

A frequency offset can be set for the baseband spectrum in the range of -60 MHz to 60 MHz.

Common uses for the offset include:

- Offset the carrier from any LO feedthrough (carrier signal spur at the carrier frequency).
- Sum the baseband signal with external I and Q inputs to create a multicarrier signal.
- Use the signal generator's I/Q signal as an IF.

8.11.6 Multi Carrier

This section provides background information about generating multicarrier signals in ARB and the impact of the settings provided.

Press **I/Q** > **ARB** > **Multi Carrier** to enter the parameter settings for multicarrier.

8.11.6.1 About Multi Carrier

To simulate complex multi carrier scenarios with different baseband signals, the SSG5000X-V provides the possibility to generate multi carrier waveforms. These waveforms can consist of up to

512 carriers, each modulated by the same or by different user-selectable baseband signal. Complex multi carrier scenarios composed of signals from different digital standards can be created by this function.

Because the multi carrier files are processed by the ARB generator, the composed waveform file must be created before it is loaded to and played by the ARB. The SSG5000X-V stores the created multi carrier waveform file under user definable name; as with the single carrier waveforms, the used file extension is *.arb, same as the signal carrier waveform. The instrument appends additional information to the header of the composed waveform file.

While creating a multi carrier waveform, the carrier spacing is adjustable within the total available bandwidth. The total RF bandwidth of the composed multicarrier signal should not exceed the available RF bandwidth (please reference to the data sheet). Each carrier can be separately defined in terms of power, phase and modulated input signal. After all the multi carrier processing steps are completed, the instrument calculates the resulting peak and RMS power over the total signal. This value is then written in the waveform file.

8.11.6.2 Waveform Name

Click this item to input the current multi carrier name. The default value is "MULTICARRIER".

8.11.6.3 Power Reference

Defines the way the individual carriers in a composed multi carrier signal are leveled.

- **Peak:** The individual carriers are leveled based on their peak power and the configured Carrier Gain.

For example, a multi carrier signal is composed of two waveform files,

First carrier "Gain" = 0 dB,

Second carrier "Gain" = -3 dB,

In the resulting multi carrier signal, the peak power of the second carrier signal will be 3 dB lower than the peak power of the first carrier signal.

- **RMS:** The individual carriers are leveled based on their RMS power and the configured Carrier Gain.

For example, a multi carrier signal is composed of two waveform files,

First carrier "Gain" = 0 dB

Second carrier "Gain" = -3 dB

In the resulting multi carrier signal, the RMS power of the second carrier signal will be 3 dB lower than the RMS power of the first carrier signal.

8.11.6.4 Carrier Table

Click this item to enter the multi-carrier table setting interface, which contains the settings of each

carrier:

Carrier	Offset Freq	Power	Phase	Info
SINE_WAVE	500.000000kHz	0.00 dB	0.00 deg	Info...
RAMP_WAVE	-500.000000kHz	-3.00 dB	0.00 deg	Info...

Add Delete Clear Assistant Return ➔

Figure 8-17 Multi-carrier table setting interface

This page comprises the settings of each carrier, and all the carriers are displayed in table form. The number of rows corresponds to the number of carriers.

Each row of parameters in the table represents the settings of a single carrier:

- 1) Carrier: Set the carrier signal by selecting the corresponding file from the volatile memory.
- 2) Offset Freq: Set the offset frequency of the carrier relative to the center frequency.
- 3) Power: Set the carrier power gain.
- 4) Phase: Set the carrier phase.
- 5) Info: Indicates the name, sample rate, number of samples, and signal period of the selected carrier.

Functions of each item in the menu bar at the bottom of the page:

- 1) Add: Insert a carrier in the next line of the current cursor
- 2) Delete: Delete the carrier signal in the line where the current cursor is located from the carrier list.
- 3) Clear: Clear the multi-carrier list and keep only one default carrier.
- 4) Assistant: Enter the assistant setting menu of carrier list, which is used to generate a list of carriers with fixed carrier signal and equal frequency spacing. The menu contains the following settings:
 - Select Waveform: Set the carrier signal applied in the carrier list by selecting the corresponding file from the volatile memory.
 - Freq Space: Set the frequency spacing of adjacent carriers.
 - # of Carrier: Set the number of carriers, up to 100.

- Done: Generate the carrier list according to the setting above, and return to the carrier list setting interface.
- 5) Load: Enter the file system directory, select and read the carrier list setting file with the suffix of *.ml.
 - 6) Save: Enter the file system directory, input the file name, and save the current carrier list setting, so as to read it again when necessary.
 - 7) Return: Return to the previous menu.

8.11.6.5 Signal Period Mode

Defines the way the resulting signal period of the multicarrier waveform is calculated. The resulting period is always calculated for all carriers in the carrier table. Use the "Carrier Table > Info" function to obtain information on the sample rate and file length data of each carrier.

- Longest File: The longest I/Q file in the carrier table defines the resulting signal period. Shorter I/Q files are periodically repeated.
- Shortest File: The shortest I/Q file in the carrier table defines the resulting signal period. Only the first part of longer I/Q files is used.
- "LCM": The signal period is defined by the least common multiple of the periods of all waveform files in the carrier table.
- "User": The signal period is set manually (Signal Period). Shorter I/Q files are repeated periodically, and only the first part of longer I/Q files is used.

8.11.6.6 Signal Period

This item displays the signal period of current multi-carrier and can only be set when **Signal Period Mode** is set to "User".

8.11.6.7 Sampling Rate

The item displays the sampling rate of the current multi-carrier signal according to the waveform setting in the carrier table.

8.11.6.8 Create and Load

Click this button to create a multi-carrier signal based on the current settings, load the multi-carrier signal into volatile memory, and then automatically select the multi-carrier signal in **ARB > Select Waveform** .

8.11.6.9 Create a Multi-carrier Signal

To create a multi-carrier waveform file, follow these steps:

- 1) Enter the "Carrier Table", add each carrier as required, and configure the frequency offset, power gain, phase and other parameters. You can also use the "Assistant" function to add multiple carriers to the carrier list at one time.
- 2) Set the "Signal Period" and "Power Reference" of the multi-carrier signal to be generated.
- 3) Name the new multicarrier in "Waveform Name".
- 4) Finally, click "Create and Load" button to add the new multi-carrier to the volatile memory and select it for playback.

8.11.7 Marker Utilities

This chapter introduces the concepts and usage of waveform markers.

Press **I/Q** > **ARB** > **Marker Utilities** to enter marker settings menu.

8.11.7.1 About the Waveform Marker

SSG5000X-V provides four waveform markers to mark specific points on a waveform segment. You can set each marker's polarity and marked points (on a single sample point or over a range of sample points). When the signal generator encounters an enabled marker, an auxiliary signal is routed to the rear panel **[IQ_EVENT]** output.

You can use the auxiliary output signal to synchronize another instrument with the waveform, or as a trigger signal to start a measurement at a given point on a waveform. You can also configure markers to initiate RF Blanking.

8.11.7.2 Marker Number

Select the waveform marker to be set currently. There are four markers 1, 2, 3, and 4 to choose from.

8.11.7.3 Output Mux

Select the marker to be output. There are four markers 1, 2, 3, and 4 to choose from. The **[IQ_EVENT]** connector on the rear panel will output the corresponding pulse signal according to the currently selected marker and related settings.

Note: The **[IQ_EVENT]** connector can only output one marker signal at a time.

8.11.7.4 Marker Polarity

The default value is "Negative". Click the drop-down box to switch the polarity of the marker.

- Positive: the high level (3.3V) signal is output during the on marker points, and the low level (0V) signal is output during the off marker points.
- Negative: the low level (0V) signal is output during the on marker points, and the high level (3.3V) signal is output during the off marker points.

8.11.7.5 Pulse/RF Blank

When this option is turned on, the signal generator will blank the RF output when the marker signal is low. The following two figures show the influence of blanking on the RF output signal when the marker polarity is positive and negative respectively.

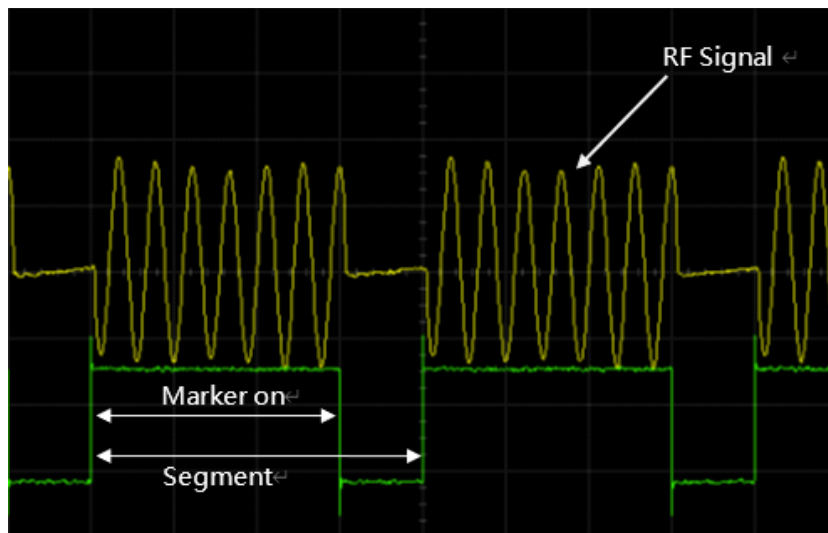

Marker Polarity = Positive

When marker polarity is positive, the RF output is blanked during the off marker points.

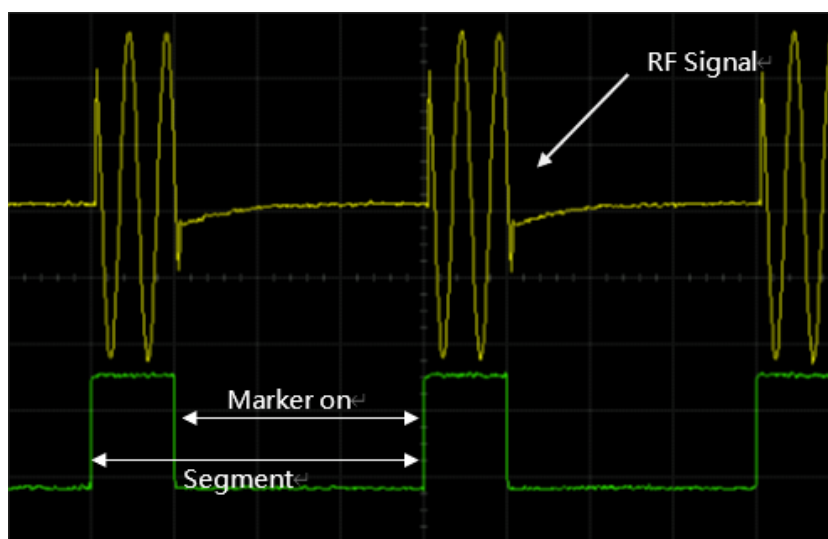

Marker Polarity = Negative

When marker polarity is negative, the RF output is blanked during the on marker points.

8.11.7.6 Marker Delay

Set the delay time of pulse signal output by the **[IQ_EVENT]** connector relative to RF signal. The delay range is -4000 ns to 860 us, and default value is 0 us.

8.11.7.7 Set Markers

Click this item to enter the marker setting interface.

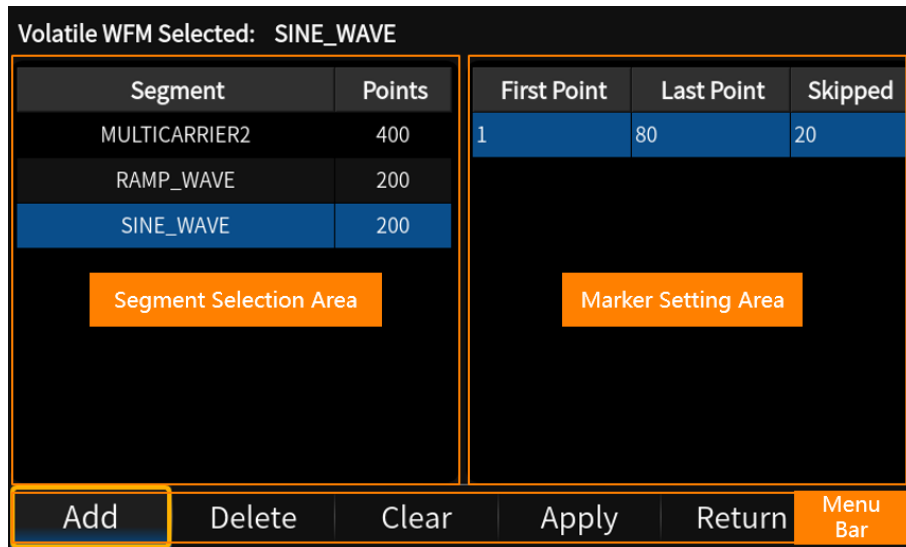

Figure 8-18 Marker setting interface

As shown in above figure, the marker setting page is composed of waveform segment selection area, marker setting area and menu bar.

1. Waveform Segment Selection Area

The waveform segment selection area lists all waveform segments in the current volatile memory and their corresponding sampling points. Select a segment to set the marker points in the right marker setting area.

2. Marker Setting Area

In the marker setting area, each row of parameters in the table represents the marker settings of a segment:

- First Mkr Point: Set the sample point corresponding to the first marker point of the segment.
- Last Mkr Point: Set the sample point corresponding to the last marker point of the segment (the last marker point should always be less than or equal to the number of points in the segment, and greater than or equal to the first marker point).
- Skipped: Set the number of sample points you want to skip, so that only one sample point will be output every corresponding number of sample points in the segment.

When marker points are set, they do not replace points that already exist, but are set in addition to existing points. For example, set the marker point range of a segment to 1-30, and then add a marker point range of 20-50. The marker signal consisting of these two marker point ranges starts on sample point 1, and ends at on sample point 50.

3. Menu Bar

Functions of each item in the menu bar at the bottom of the page:

- Add: Insert a marker point range in the next line where the current cursor is located.
- Delete: Delete the marker point range in the line where the current cursor is located.
- Clear: Clear all the marker points from a waveform segment.
- Apply: Make the current marker points setting of a segment effective.
- Display: Click to view the marker signal diagram.
- Return: Return to the previous menu.

The marker signal diagram showed as below:

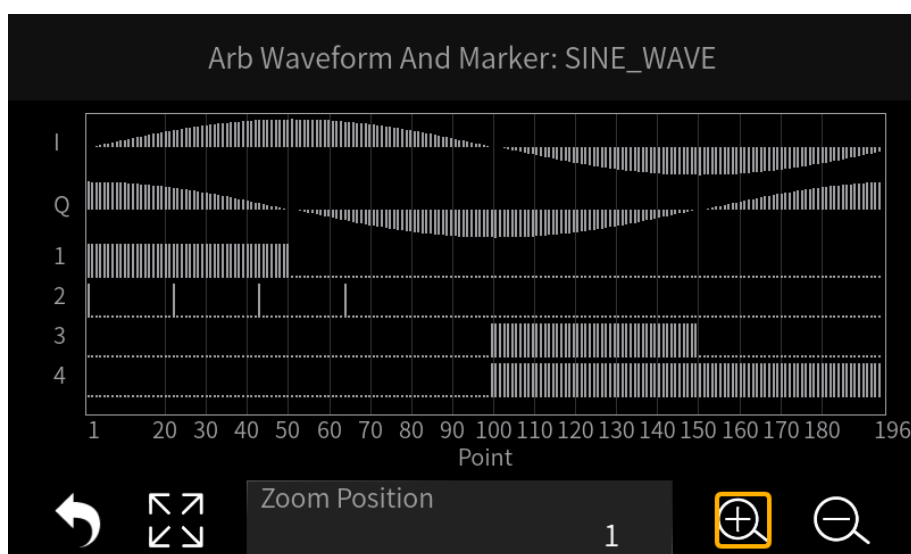

Figure 8-19 Marker signal diagram

As shown, this page consists of the upper plot area and the lower control area:





Plot area:

The marker signal diagram generated according to the current waveform segment and its marker point range.

"I" and "Q" on the right side of Y axis represent the output waveforms of I and Q of the currently selected waveform segment. "1", "2", "3" and "4" represent four marker signals.

The horizontal direction of the schematic diagram represents the sample point and marker point of the waveform segment, and the vertical direction represents the power level of the output signal.

Control area:

- Click  to return to the previous marker point setting page;
- Click  to resume the diagram to the initial state;
- Click  to zoom in the diagram;
- Click  to zoom out the diagram;

- The “Zoom Position” parameter sets the start position of the diagram, and the zoom operation is based on this position.

8.11.8 Waveform Utilities

Press **I/Q** > **ARB** > **Waveform Utilities** to enter the waveform segment scaling and clipping page.

8.11.8.1 Select Segment

Select the waveform segment for amplitude scaling or peak clipping the I and Q data. The waveform segment can only be selected from volatile memory.

8.11.8.2 Scaling

Set the amplitude scaling percentage of a waveform segment.

The signal generator uses an interpolation algorithm (sampling between the I/Q data points) when reconstructing a waveform. For common waveforms, this interpolation can cause overshoots, which may create a DAC over-range error condition. This chapter describes how DAC over-range errors occur and how you can use waveform scaling to eliminate these errors.

Although scaling maintains the basic shape of the waveform, excessive scaling can compromise waveform integrity. For example, if the bit resolution becomes too low the waveform becomes corrupted with quantization noise. To achieve maximum accuracy and optimize dynamic range, scale the waveform no more than is required to remove the DAC over-range error.

8.11.8.3 Clipping

The clipping function enables you to reduce peak-to-average power, and consequently spectral regrowth, by clipping the waveform. Clipping limits waveform power peaks by clipping the I and Q data to a selected percentage of its highest peak.

8.11.8.3.1 Clipping Type

The Signal Generator provides two methods of clipping:

1. Circular clipping

Circular clipping ($|I+jQ|$ clipping) is applied to the composite I/Q data (I and Q data are equally clipped). The clipping level is constant for all phases of the vector and appears as a circle in the vector representation

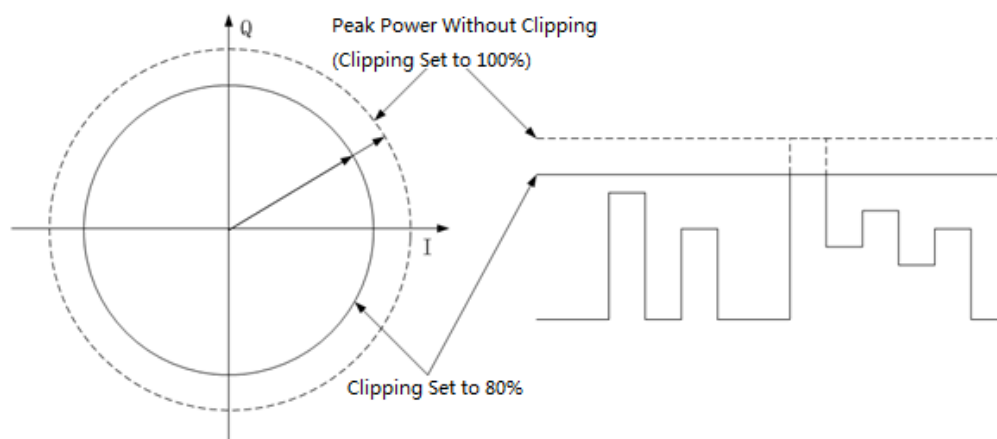

2. Rectangular clipping

Rectangular clipping ($|I|, |Q|$ clipping) is independently applied to the I and Q data. The clipping level is different for I and Q, and appears as a rectangle in the vector representation.

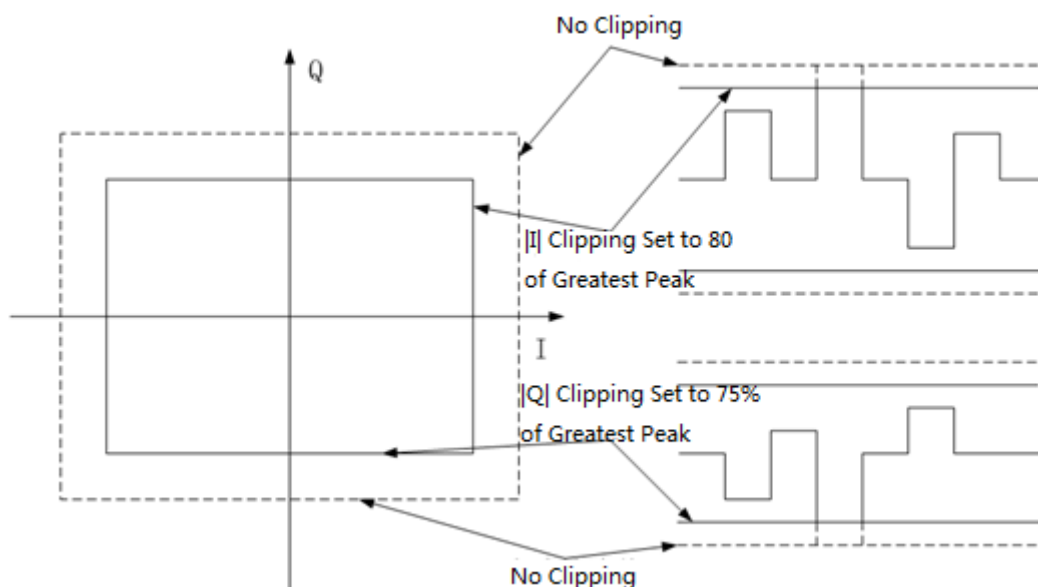

8.11.8.3.2 Clipping Value

- Clip $|I+jQ|$ to
Set the percentage of I / Q signal value ($\sqrt{I^2 + Q^2}$) reduced to the peak value.
- Clip $|I|$ to
Set I Waveform clipping percentage.
- Clip $|Q|$ to
Set Q Waveform clipping percentage.

8.11.8.4 Apply to Waveform

Click the "Apply to Waveform" button to make waveform scaling or clipping effective.

Note: Waveform scaling and clipping are non-reversible. Any data lost in the scaling or clipping operation cannot be restored. Save a copy of the waveform file before scaling or clipping.

8.11.8.5 Display CCDF

Click to view the CCDF (Complementary Cumulative Distribution Figure) before and after waveform segment clipping.

The CCDF diagram shows as below:

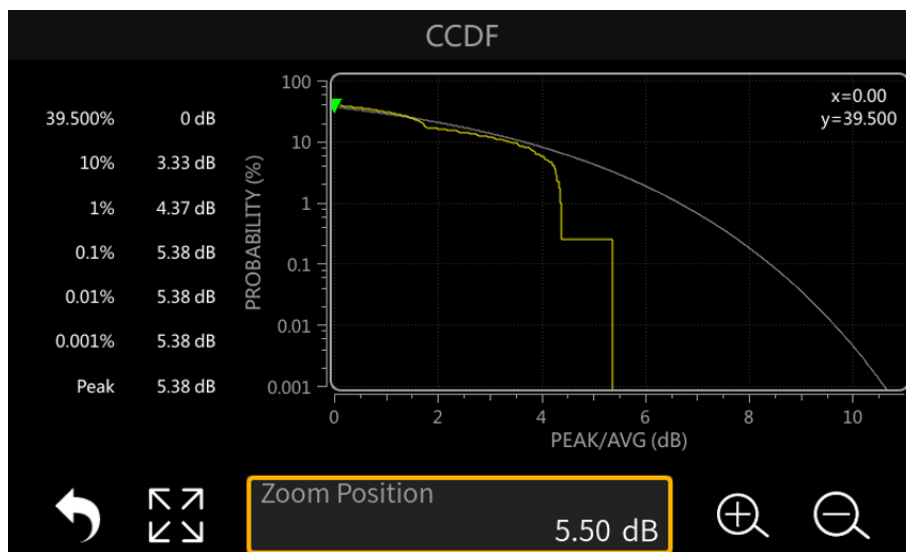

Figure 8-20 CCDF diagram

As shown, the page consists of the upper plot area and the lower control area:





1. Plot area

Generate a CCDF waveform diagram based on the selected waveform.

- The vertical direction represents probability; The horizontal direction represents a multiple of the relative average power (in dB).
- The yellow curve is the current CCDF curve of the selected waveform. And the grey curve is the CCDF reference curve.

2. Control area

The CCDF curve can be zoomed in or out for easy observation and comparison:

- Click  to return to the previous page;
- Click  to resume the CCDF to the initial state;
- Click  to zoom in the diagram.
- Click  to zoom out the diagram;

The “Zoom Position” parameter sets the center position of the diagram, and the zoom operation is based on this position.

8.11.9 Trigger

Press **I/Q** > **ARB** > **Trigger** to enter the ARB trigger setting menu.

Triggers control data transmission by controlling when the signal generator transmits the modulating signal. You can configure trigger settings so that data transmission occurs once (Single mode), continuously (Continuous mode), or starts and stops repeatedly (Gated and Segment Advance modes).

8.11.9.1 Trigger Type

Trigger type defines the trigger mode: how the waveform plays when triggered.

You can set the trigger type to Continuous, Single, Segment Advance or Ext Gated.

- 1) Continuous: Continuous mode repeats the waveform until you turn the signal off or select a different waveform, trigger mode, or response (Free Run, Trigger & Run, and Reset & Run).
- 2) Single: Single mode plays the waveform once.
- 3) Segment Advance: Segment Advance mode plays a segment in a sequence only if triggered. The trigger source controls segment-to-segment playing. A trigger received during the last segment loops play to the first segment in the sequence.
- 4) Ext Gated: Ext Gated mode triggers the waveform at the first active triggering state, then repeatedly starts and stops playing the waveform in response to an externally applied gating signal.

8.11.9.2 Continuous Mode

The **Continuous Mode** can be set to Free Run, Trigger & Run or Reset & Run mode.

- 1) Free Run: Immediately triggers and plays the waveform; triggers received while the waveform is playing are ignored.
- 2) Trigger & Run: Plays the waveform when a trigger is received; subsequent triggers are ignored.
- 3) Reset & Run: Plays the waveform when a trigger is received; subsequent triggers restart the waveform.

8.11.9.3 Single Mode

The **Single Mode** can be set to no retrigger, buffered trigger or restart on trigger mode.

- 1) No Retrigger: Ignores an early trigger received while a waveform is playing.
- 2) Buffered Trig: An early trigger received while a waveform is playing waits until the current waveform completes, then plays the waveform once more.

- 3) Restart on Trig: An early trigger received while the waveform is playing immediately restarts the waveform.

8.11.9.4 Segment Advance Mode

The **Segment Advance** mode can be set to single or continuous mode.

- 1) Single: A segment in a sequence plays once, ignoring the repetition setting, after which the dual ARB player stops and waits for a trigger before advancing to the next segment. The next segment then plays to completion.

If a trigger is received while a segment is playing, the segment plays to completion. The dual ARB player then advances to the next segment and plays that segment to completion.

- 2) Continuous: A segment in a sequence plays continuously until the waveform receives another trigger.

If a trigger is received while a segment is playing, the segment plays to completion. The dual ARB player then advances to the next segment and plays that segment continuously.

8.11.9.5 Ext Gated Mode

The **Ext Gated Mode** can be set to Active High or Active Low. The waveform stops during the inactive state of the trigger source, and plays during the active state.

8.11.9.6 Trigger Source

The trigger source can be set to trigger key, bus, or external.

- 1) Trigger Key: Each time the Trigger key is pressed, the signal source generates a trigger signal.
- 2) Bus: Each time the "*"TRG" command is sent, the signal source generates a trigger signal.
- 3) Ext: The signal generator receives the external trigger signal input from the **[PATTERN_TRIG]** connector on the rear panel of the instrument.

Note: In "Free Run" or "Ext Gated" trigger mode, the "Trigger Source" item is hidden.

8.11.9.7 Ext Polarity

When the trigger source is set to external, the external trigger polarity can be set to positive or negative.

- Positive: The signal generator responds during the trigger signal low state.
- Negative: The signal generator responds during the trigger signal high state.

Note: In Continuous, Single, and Segment Advance modes, use the **Ext Polarity** item to set the external trigger polarity. In Gated mode, the Active Low and Active High items determine the external trigger polarity.

8.11.9.8 Trigger Delay

When setting external trigger source, users can set the external trigger delay. The delay type can be set to off, time, or sample.

- Off: Turn off trigger delay.
- Time: Set the time from when the external trigger signal is received until the trigger takes effect, which can be set through the **Delay Time** button.
- Sample: Set the number of sampling points from the time when the external trigger signal is received until the trigger takes effect, which can be set through the **Delay Samples** button.

Where:

$$\text{Delay time} = \text{Delay Samples} / \text{Sampling rate}$$

Note: When the trigger mode is initially selected or when changing from one trigger mode to another, the carrier signal on the RF output may be lost until the modulating signal is triggered. This is because the signal generator sets the I and Q signals to zero volts before the first trigger event.

8.11.10 Waveform Header

After selecting a waveform segment or sequence in **I/Q** > **ARB** > **Select Waveform**, click the **Waveform Header** button to enter the waveform header setting interface.

Note: When no waveform segment or sequence is selected in **Select Waveform**, that is, *NONE is selected, the waveform header setting interface cannot be entered. At this time, the user interface will pop up a prompt:

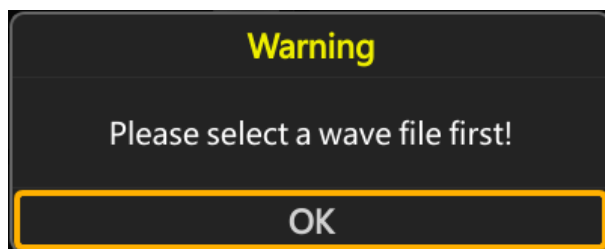

8.11.10.1 About Waveform Header

For certain waveforms, you can save the settings and parameters of the signal generator in the header file, including the marker settings. When you load the stored waveform file into the BBG storage medium, the header file settings are automatically applied to the signal generator so that set up the signal generator the same way every time you play a waveform.

The waveform sequence header file takes precedence over the header file of each waveform segment. When the waveform sequence is played, the waveform segment header files are ignored and the waveform sequence header file is automatically loaded into the signal generator.

8.11.10.2 Editing a Waveform Header

The editing interface of a waveform header is shown as below.

File Header Information: SEQ:SEQ1		Title Bar
Header Field	Saved Header Settings	Current Inst. Settings
Description	waveform seq	waveform seq
Sample Rate	3.000000000 MHz	3.000000000 MHz
Marker 1 Polarity	Pos	Pos
Marker 2 Polarity	Neg	Neg
Marker 3 Polarity	Pos	Pos
Marker 4 Polarity	Neg	Neg
Blank/RF Routing	Marker 3	Marker 3
Output Marker	Marker 2	Marker 2

Parameter Display Area

Describe Clear Header Save To Header Return Menu Bar

Figure 8-21 Waveform header editing interface

The waveform header editing interface is composed of title bar, parameter display area and menu bar.

1. Title Bar

Display the currently selected waveform segment or waveform sequence. Press **I/Q** > **ARB** > **Select Waveform** to select a segment or sequence to edit its waveform header.

2. Parameter Display Area

There are three columns' parameters in parameter display area.

- Header Field: list all the file header parameters.
- Saved Header Settings: show the header settings saved in the currently selected waveform segment or sequence header file. "Unspecified" means that there is no setting saved for that particular parameter.
- Current Inst. Settings: show the current signal generator settings. The header parameters are in **I/Q** > **ARB** > **ARB Setup** and **I/Q** > **ARB** > **Marker Utilities** menu.

Note: If a setting is unspecified in the header file, the signal generator uses its current value for that setting when you select and play the waveform.

3. Menu Bar

- Describe: set a description for the waveform header file.
- Clear Header: reset the saved header settings to default settings, that is "Unspecified".
- Save to Header: save the information in the Current Inst. Settings column to the header file. At this time, the Saved Header Settings column and the Current Inst. Settings column display the same values.

Note: In order to save the waveform segment header file parameters to non-volatile memory, you need to press **I/Q** > **ARB** > **Waveform Segment** and re-save the waveform segment.

8.11.11 Waveform Segment File Type

ARB waveform segments can be loaded into three file types: *.arb, *.WDbin and *.txt.

8.11.11.1 arb file

The arb file (*.arb) is generated by the signal generator, or generated by SIGLENT SigIQPro software.

8.11.11.2 WDbin file

A WDbin file (*.WDbin) is a binary file of pure waveform data. The I and Q waveform data are 16-bit complement data and are alternately stored in the file.

	0	1	2	3	4	5	6	7	8	9	a	b	c	d	e	f
00000000h:	0B	00	00	00	2D	00	00	00	65	00	00	00	B3	00	00	00
00000010h:	17	01	00	00	91	01	00	00	20	02	00	00	C4	02	00	00
00000020h:	7D	03	00	00	49	04	00	00	29	05	00	00	1C	06	00	00
00000030h:	21	07	00	00	38	08	00	00	5F	09	00	00	96	0A	00	00
00000040h:	DC	0B	00	00	31	0D	00	00	92	0E	00	00	00	10	00	00
00000050h:	79	11	00	00	FC	12	00	00	88	14	00	00	1C	16	00	00
00000060h:	B7	17	00	00	58	19	00	00	FE	1A	00	00	A7	1C	00	00
00000070h:	53	1E	00	00	00	20	00	00	AC	21	00	00	58	23	00	00
00000080h:	01	25	00	00	A7	26	00	00	48	28	00	00	E3	29	00	00
00000090h:	77	2B	00	00	03	2D	00	00	86	2E	00	00	FF	2F	00	00
000000a0h:	6D	31	00	00	CE	32	00	00	23	34	00	00	69	35	00	00
000000b0h:	A0	36	00	00	C7	37	00	00	DE	38	00	00	E3	39	02	00

8.11.11.3 txt file

The txt file (*.txt) is a txt file of pure waveform data. The I and Q waveform data are stored in the file in the form of floating-point numbers. I and Q are stored in two columns, I in the first column and Q in the second column.

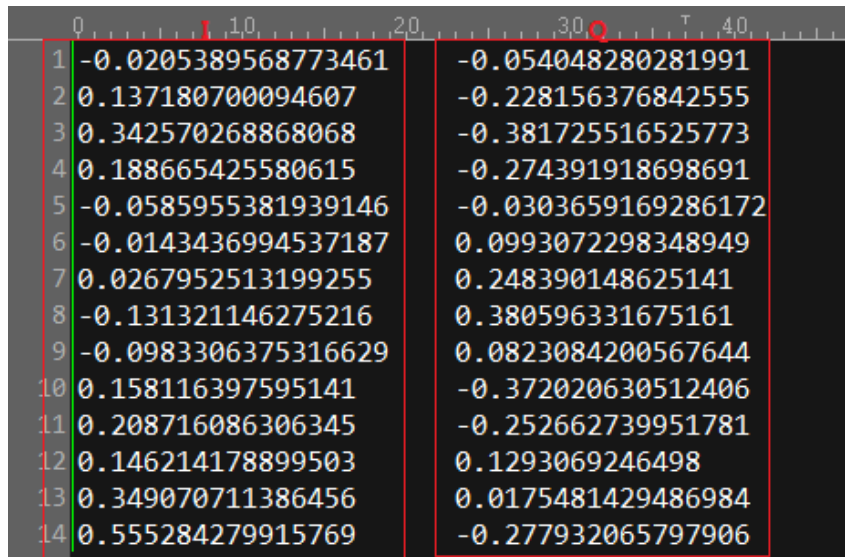

- Sum the baseband signal with external I and Q inputs to create a multicarrier signal.
- Use the signal generator's I/Q signal as an IF.

8.12.3 How to Play a Stream File

Steps below describe how to play a stream file:

- 1) Press **FREQ** > **Frequency** to set the carrier frequency. Press **LEVEL** > **Level** to set the carrier power.
- 2) Press **RF ON/OFF** and **MOD ON/OFF** to turn on the RF output and modulation.
- 3) Press **I/Q** > **Stream** > **Select Stream File** to select the stream file to play.
- 4) Press **Stream Setup** > **Sample Clock** to set the waveform's sampling rate.
- 5) Press **Stream State** to turn on Stream mode.

A progress bar will pop up as shown below. It reminds users that a stream file is in loop playing. At this time, the user interface will be locked by the progress bar.

You can press **Stop Playing** in the progress bar or **ECS/Close** to quit playing.

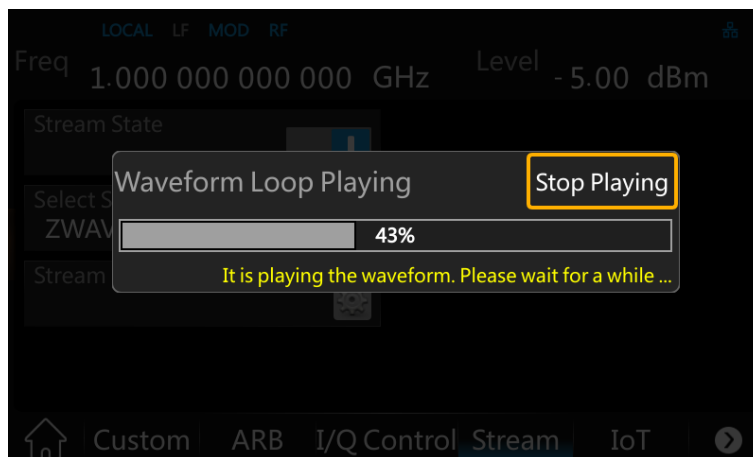

Figure 8-22 Stream file loop playing

8.13 IoT

8.13.1 Protocol Introduction and Setup

Press **I/Q** > **IoT** to enter IoT mode. In IoT mode, you can play two protocols: ZigBee and Z-Wave.

- ZigBee is a low-power Internet of Things standard based on IEEE 802.15.4 standard. For details, please refer to “IEEE 802.15.4 ZigBee” Chapter.
- Z-Wave is defined by Recommendation ITU-T G.9959. For details, please refer to “ITU-T G.9959 Z-Wave” Chapter.

8.13.2 Basic Waveform Setup

Press **I/Q** > **IoT** > **Basic** to enter the basic waveform setup. In Basic Settings, users can set the frame number and oversampling ratio.

8.13.2.1 Oversampling Ratio

Enter the oversampling ratio of the waveform. Ranges from 2 to 64, and the default value is 8. When you set the oversampling ratio, the waveform’s sample rate is determined.

$$\text{Sample rate} = \text{Chip rate} * \text{Oversampling ratio},$$

the value of the Chip rate you can refer to “Table 9-1 Frequency bands and data rates”.

8.13.2.2 Number of Frames

Enter the number of frames for use in the waveform. A ZigBee/Z-Wave waveform can include one or more frames depending on the settings. Ranges from 1 to 2000, and the default value is 1.

8.13.2.3 Total Sample Points

Displays the number of sample points in the waveform. You cannot edit this cell. This parameter is determined by PHY Scheme, the PPDU length, idle interval, oversampling ratio, etc.

8.13.2.4 Waveform Length

Displays the waveform length that are included in the waveform. You cannot edit this cell. The waveform length can be calculated by total sample points and sample rate of the waveform.

$$\text{Waveform Length} = \text{Total Sample Points} / \text{sample rate}$$

8.13.3 Marker Setup

Press **I/Q** > **IoT** > **Marker** to enter the waveform's marker setup interface.

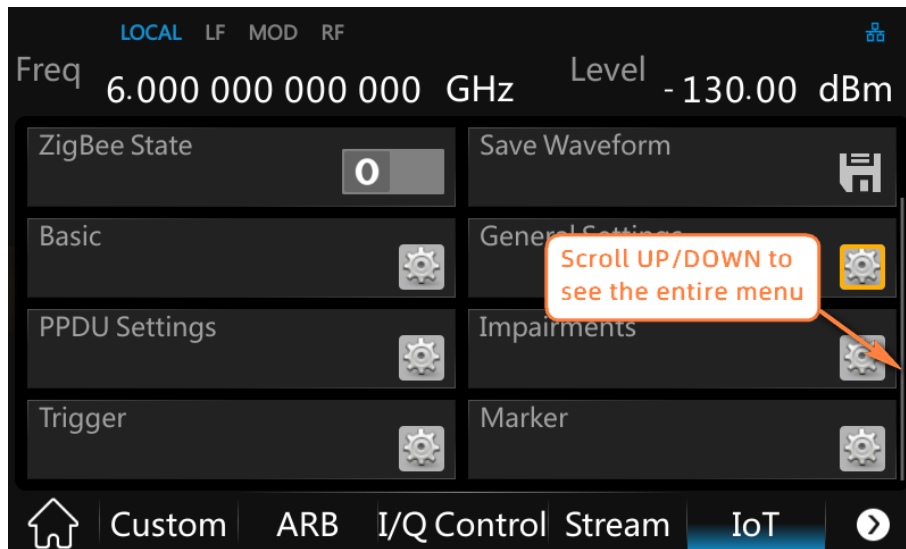

Figure 8-23 IoT setting page

8.13.3.1 Marker 1 Source

Choices: Waveform Start | Frame Start. Default: Frame Start.

Configure the marker points for Marker 1.

8.13.3.2 Marker 2 Source

Choices: Waveform Start | Frame Start. Default: Frame Start.

Configure the marker points for Marker 2.

8.13.3.3 How to Use Marker Source

Example below shows how to use the marker source.

1. Create a Waveform
 - 1) Create a ZigBee waveform first, for example, the waveform's total sample points is 15024, and the frame number is 4.
 - 2) Set **Marker 1 Source** as Frame Start.
 - 3) Set **Marker 2 Source** as Waveform Start.
 - 4) Press **I/Q** > **IoT** > **Save Waveform** and save the waveform in file: zigbee_wave.arb.

2. Play Waveform in ARB
 - 1) Press **I/Q** > **ARB** > **Waveform Segment** and load the file zigbee_wave.arb.

- 2) Press **Select Waveform** and select “zigbee_wave”.
 - 3) Turn **ARB State** on.
3. Check the marker settings
- Press **I/Q** > **ARB** > **Marker Utilities** to check the marker settings.
- 1) Set **Marker Number** as 1.
 - 2) Press **Set Markers** and select “zigbee_wave”. You shall see the marker is “1,15024,3756”.
 - It means that if the marker source is “Frame Start”, the marker will be:
1, waveform’s total sample points, one frame’s points
 - Note that if the frame number is 1, the marker shall be “1,1,0”.
 - 3) Set **Marker Number** as 2.
 - 4) Press **Set Markers** and select “zigbee_wave”. You shall see the marker is “1,1,0”.

8.13.4 IoT Trigger

Press **I/Q** > **IoT** > **Trigger** to enter the waveform’s trigger setup interface.

The trigger function in IoT is the same as that in ARB, but with fewer features. For details, please refer to the “Trigger” section in ARB mode.

Note that there is no trigger mode to set for single trigger in IoT, and the default single trigger mode can be considered as “No Retrigger”.

8.14 Multitone

Press **I/Q** > **Multitone** to enter multitone mode. Multitone mode supports up to 20 tones. The highest sampling rate is 240 MHz, and the maximum spectral spacing can be up to 120 MHz. Both unilateral spectrum and bilateral spectrum modes are supported.

8.14.1 Multitone State

Press **I/Q** > **Multitone** > **Multitone State** to turn Multitone on or off.

8.14.2 Tone Number

Press **I/Q** > **Multitone** > **Tone Number** to set tone number. The maximum support is 20. The multitone spectrum defaults to exist in pairs. The number set here refers to the meaning of how many pairs, and is a bilateral spectrum symmetrically distributed on both sides of the center frequency.

8.14.3 Sample Rate

Press **I/Q** > **Multitone** > **Sample Rate** to set multitone sample rate. Support up to 240 MHz sampling rate.

8.14.4 Freq Spacing

Press **I/Q** > **Multitone** > **Freq Spacing** to set frequency spacing. The frequency spacing here refers to the frequency spacing from the leftmost spectrum to the rightmost spectrum.

8.14.5 Single Side

Press **I/Q** > **Multitone** > **Single Side** to turn the unilateral spectrum mode on or off. If the unilateral spectrum mode is turned on, the spectrum on the left side of the multi-tone (left side of the center frequency) will be removed.

8.14.6 Save State

Press **I/Q** > **Multitone** > **Save State** to save the current parameter settings of the Multitone mode to a MULSTATE file.

8.14.7 Load State

Press > *Multitone* > *Load State* to load a MULSTATE file from the file browser as the setting parameters for Multitone mode.

8.15 AWGN

Press **I/Q** > **AWGN** to enter the AWGN setting menu. You can use AWGN (Additive White Gaussian Noise) to modulate the Carrier waveform.

8.15.1 AWGN State

Press **I/Q** > **AWGN** > **AWGN State** to turn AWGN modulation on or off. When AWGN modulation is on, the user interface status bar will display a blue AWGN icon.

8.15.2 Bandwidth

The setting range of AWGN bandwidth is 1 Hz ~ 150 MHz, and the default is 10 MHz.

8.15.3 Example

Use the following steps to apply 10 MHz bandwidth noise to a 1 GHz, 0 dBm carrier.

- 1) Press **I/Q** > **AWGN** > **Bandwidth** to set the noise bandwidth as 10 MHz.
- 2) Turn on **I/Q** > **AWGN** > **AWGN State**. At the same time, an “AWGN” icon will display on the status bar.
- 3) Turn on **MOD ON/OFF**.
- 4) Configure RF output, set frequency to 1 GHz, amplitude to 0 dBm, and turn on **RF ON/OFF**.

The carrier with AWGN is now available at the signal generator's **[RF OUTPUT 50Ω]** connector.

8.16 I/Q Control

Press **I/Q** > **I/Q Control** to enter the I/Q Control setup menu. The I/Q Control menu not only enables you to select the I/Q signal source and output, but also provides adjustments and calibrations to compensate for differences in I and Q signals.

8.16.1 I/Q Mod State

Turn on or off the I/Q modulation. When turn on the Custom, ARB, Stream, IoT, Multitone, or AWGN modulation, the **I/Q Mod State** will be automatically turned on.

8.16.2 I/Q Source

Set the I/Q modulation source to internal or external.

- Internal: Use the internal signal generated by the signal generator as modulation source.
- External: The signal generator accepts externally supplied analog I and Q signals as modulation sources via the **[I INPUT]** and **[Q INPUT]** connectors on the rear panel.

Example using an external IQ modulation source:

- 1) Connect the external analog I and Q signals to the **[I INPUT]** and **[Q INPUT]** connectors on the rear panel of the signal generator respectively.
- 2) Press **I/Q** > **I/Q Control** > **I/Q Source** to set the I/Q modulation source to External.
- 3) Turn on **I/Q Mod State** .
- 4) Turn on **MOD ON/OFF** .
- 5) Configure the RF carrier and turn on **RF ON/OFF** .

At this time, the **[RF OUTPUT 50Ω]** connector of the signal generator will output the carrier signal modulated by the external modulation source.

8.16.3 Compensation Channel

Set the compensation channel as RF or Output.

- RF: Compensate RF channel of the front panel. At this time, the compensation of the IQ signal output from the rear panel will be turned off.
- Output: Compensate the I/Q signal output from the rear panel connectors. In this case the compensation from baseband to RF will be turned off.

8.16.4 I/Q Adjustment

Use I/Q Adjustment to compensate for or add impairments to the I/Q signals. This adjustment is available only on the RF output.

8.16.4.1 Gain Balance

Adjust the I signal amplitude relative to the Q signal amplitude. And use it as an internal channel image optimization.

Range: -4 dB to 4 dB, default is 0 dB.

8.16.4.2 I Offset

Adjust the DC bias level of I+ and I- baseband signals. Unit: %.

Range: -50% to 50%, default is 0%.

8.16.4.3 Q Offset

Adjust the DC bias level of Q+ and Q- baseband signals. Unit: %.

Range: -50% to 50%, default is 0%.

Users can adjust I Offset and Q offset alternately to optimize LO leakage.

8.16.4.4 Quadrature Angle Adjustment

Offset the phase of the Q signal relative to the phase of the I signal. The baseband quadrature adjustment key is calibrated in units of degrees. This can optimize the image leakage.

8.16.5 I/Q Output

This adjustment is only applied to the I and Q signals on the rear panel output.

8.16.5.1 I/Q Output Atten

Set the I and Q signal attenuation on the rear panel output. I and Q signals will be attenuated at the same time.

Range: 0 to 20 dB, default is 0 dB.

8.16.5.2 I/Q Output Gain Balance

Adjust I signal amplitude or Q signal amplitude.

Range: -4 to 4 dB, default is 0 dB.

When the setting value is positive, the I signal is attenuated, and when the setting value is negative, the Q signal is attenuated.

8.16.5.3 I Output Offset

This adjusts the DC offset level of the I+ and I- output signal. I+ and I- cannot be adjusted independently.

Range: -3 to 3 V, default is 0 V.

8.16.5.4 Q Output Offset

This adjusts the DC offset level of the Q+ and Q- output signal. Q+ and Q- cannot be adjusted independently.

Range: -3 to 3 V, default is 0 V.

8.16.5.5 I/Q Common Offset

Adjust the DC offset of both I and Q signals simultaneously.

Range: -2.5 to 2.5 V, default is 0 V.

8.16.6 I/Q Swap

By swapping the I and Q signals, the modulation sidebands are inverted (the Q portion of the signal is inverted).

- When IQ swapping is off, it is normal output mode, and the output of the RF modulator will be:

$$i(t) \cos(2\pi * fc * t) + q(t) \sin(2\pi * fc * t)$$

Where $i(t)$ and $q(t)$ represent I and Q signals, and fc represents the carrier frequency.

- When IQ swapping is on, the Q signal will be inverted, and the output of the RF modulator will be:

$$i(t) \cos(2\pi * fc * t) - q(t) \sin(2\pi * fc * t)$$

At this time the spectrum is the mirror image of the normal mode.

9 IEEE 802.15.4 ZigBee

9.1 About ZigBee Protocol

ZigBee is a low-power Internet of Things standard based on IEEE 802.15.4 standard, which is maintained by the Zigbee Alliance. According to this protocol, the technology is a short-distance, low-power wireless communication technology. The wireless communication technology of wireless sensor network can use ZigBee technology, Bluetooth, Wi-Fi and infrared technology. Compared with Bluetooth and Wi-Fi, ZigBee is characterized by a low-power, close-range and self-organizing network. Its maximum rate is 250 kbit/s, and it is protected by a 128-bit symmetric encryption algorithm, which has high security.

The IEEE 802.15.4 standard was released in 2003, and the latest revision was in 2020. The following table provides more detail on ZigBee based on IEEE 802.15.4-2020:

Table 9-1 Frequency bands and data rates

PHY (MHz)	Frequency band (MHz)	Spreading parameters		Data parameters		
		Chip rate (kchip/s)	Modulation	Bit rate (kb/s)	Symbol rate (ksymbol/s)	Symbols
868/915	868–868.6	300	BPSK	20	20	Binary
	902–928	600	BPSK	40	40	Binary
868/915 (optional)	868–868.6	400	ASK	250	12.5	20-bit PSSS
	902–928	1600	ASK	250	50	5-bit PSSS
868/915 (optional)	868–868.6	400	O-QPSK	100	25	16-ary Orthogonal
	902–928	1000	O-QPSK	250	62.5	16-ary Orthogonal
2450	2400–2483.5	2000	O-QPSK	250	62.5	16-ary Orthogonal

SSG5000X-V Zigbee operates in 868/915/2450 MHz bands using O-QPSK and 868/915 MHz bands using BPSK.

9.2 ZigBee O-QPSK BPSK PHY

Within the PHY (physical layer), the 802.15.4 O-QPSK BPSK signal is generated on a PPDU (Physical Protocol Data Unit) basis. A PPDU includes the SHR, PHR and PSDU parts as defined in the 802.15.4 specification. The figure below shows a PPDU structure:

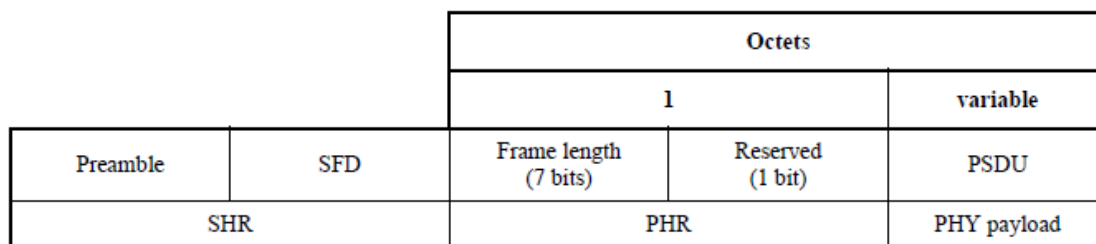

Figure 9-1 ZigBee PPDU format

A frame is the same as a PPDU, so the two terms are interchangeable, meaning that a frame structure is a PPDU structure. Depending on the settings, a waveform can include one or more frames. The following describes the PPDU format, that is, the frame format.

9.2.1 SHR Field

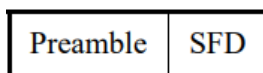

Figure 9-2 Format of SHR field

The SHR field contains Preamble and SFD two fields, and uses fixed values generated by the software.

9.2.1.1 Preamble

The length of the Preamble field is 4 octets, and the bits in the Preamble field shall be binary zeros.

9.2.1.2 SFD

The SFD is a field indicating the end of the SHR and the start of the packet data. The length of the SFD field is 1 octet, and the value of SFD is fixed as below:

Bits: 0	1	2	3	4	5	6	7
1	1	1	0	0	1	0	1

Figure 9-3 Format of SFD field

9.2.2 PHR Field

The PHR field is formatted as below, and the length of it is 1 octet.

Bits: 0–6	7
Frame Length	Reserved

Figure 9-4 Format of PHR field

The Frame Length field specifies the total number of octets contained in the PSDU, i.e., PHY payload.

9.2.3 PHY Payload Field

The PHY Payload field carries the PSDU (PHY Service Data Unit). PSDU is generated by the MAC layer and corresponds to the MPDU (MAC protocol data unit) at the MAC layer. As described in the figure below.

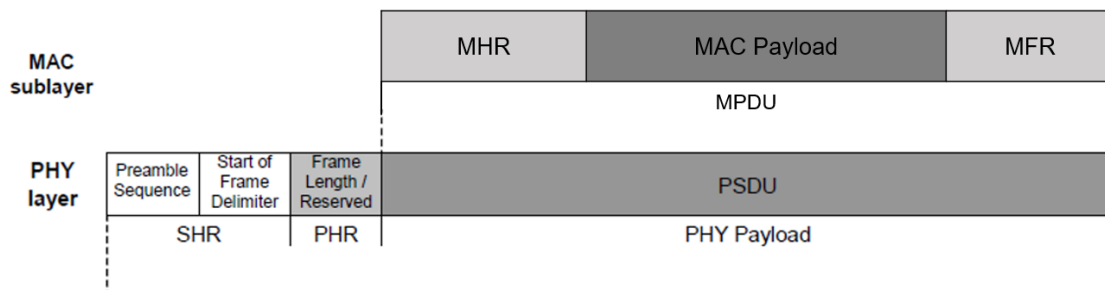

Figure 9-5 ZigBee PHY Payload

The protocol defines four MPDU (frame structure) formats: Beacon, Data, Ack and MAC Command. In addition, the SSG5000X-V also set up a general MAC frame format.

9.2.3.1 General MAC Frame Format

The general MAC frame is defined as below.

Octets: 1/2	0/1	0/2	0/2/8	0/2	0/2/8	variable	variable	variable	2	
Frame Control	Sequence Number	Destination PAN ID	Destination Address	Source PAN ID	Source Address	Auxiliary Security Header	IE		Frame Payload	FCS
							Addressing fields			
MHR							MAC Payload		MFR	

Figure 9-6 General frame format

The fields of the MHR appear in a fixed order.

9.2.3.1.1 Frame Control Field

The length of the Frame Control field is 2 octets, shown as below.

Bits: 0–2	3	4	5	6	7	8	9	10–11	12–13	14–15
Frame Type	Security Enabled	Frame Pending	AR	PAN ID Compression	Reserved	Sequence Number Suppression	IE Present	Destination Addressing Mode	Frame Version	Source Addressing Mode

Figure 9-7 Format of Frame Control field

The Frame Type field consists of 3 bits and is defined as below. The general MAC Frame Type ranges from 0b000 to 0b111.

Table 9-2 Values of Frame Type field

Frame Type value b2 b1 b0	Description
000	Beacon
001	Data
010	Acknowledgment
011	MAC command
100	Reserved
101	Multipurpose
110	Fragment or Frak
111	Extended

9.2.3.2 Beacon Frame Format

The Beacon frame shall be formatted as below.

Octets: 2	1	4/10	variable	2	variable	variable	variable	2
Frame Control	Sequence Number	Addressing fields	Auxiliary Security Header	Superframe Specification	GTS Info	Pending address	Beacon Payload	FCS
MHR				MAC Payload				MFR

Figure 9-8 Beacon frame format

9.2.3.3 Data Frame Format

The Data frame shall be formatted as below.

Octets: 2	0/1	variable	variable	variable		variable	2
Frame Control	Sequence Number	Addressing fields	Auxiliary Security Header	IEs		Data Payload	FCS
				Header IEs	Payload IEs		
MHR				MAC Payload			MFR

Figure 9-9 Data frame format

9.2.3.4 Ack Frame Format

The Ack frame shall be formatted as below. The Ack frame has no data payload.

Octets: 2	1	2
Frame Control	Sequence Number	FCS
MHR		MFR

Figure 9-10 Ack frame format

9.2.3.5 MAC Command Frame Format

The MAC Command frame shall be formatted as below.

Octets: 2	0/1	variable	variable	variable		1	variable	2
Frame Control	Sequence Number	Addressing fields	Auxiliary Security Header	IE		Command ID	Content	FCS
				Header IEs	Payload IEs			
MHR				MAC Payload			MFR	

Figure 9-11 MAC Command frame format

9.3 User Interface Settings

9.3.1 General Settings

Press > > to enter the ZigBee protocol general settings. In General Settings, users can set ZigBee modulation type, frequency band as well as idle interval.

9.3.1.1 PHY Scheme

Selects the 802.15.4 PHY scheme. Choices: O-QPSK | BPSK. Default: O-QPSK.

9.3.1.2 Idle Interval

Enter the idle interval in-between frames in seconds. When idle interval is set to zero, a continuous waveform is generated.

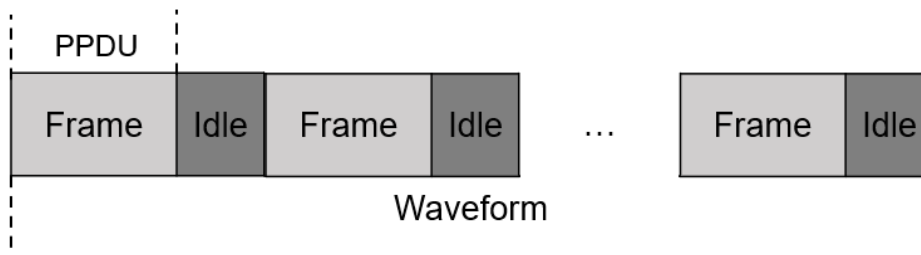

Idle interval Range: 0–200000 us. Default: 100 us.

To determine how many frames are used in the signal, see [错误!未找到引用源。](#) in the **I/Q** >

IoT > **Basic** menu.

9.3.1.3 Frequency Band

Select the frequency band for 802.15.4 O-QPSK/BPSK PHY. This parameter is not coupled with the RF Frequency setting. Set an appropriate carrier frequency for the signal after selecting the band.

- BPSK Choices: 868 MHz | 915 MHz
- QPSK Choices: 868 MHz | 915 MHz | 2450 MHz

9.3.1.4 Data Rate

When you set the PHY Scheme and Frequency Band, the Data Rate changes according to “Table 9-1 Frequency bands and data rates”. You cannot edit this cell.

9.3.2 PPDU Settings

Press **I/Q** > **IoT** > **PPDU Settings** to enter the ZigBee protocol PPDU settings.

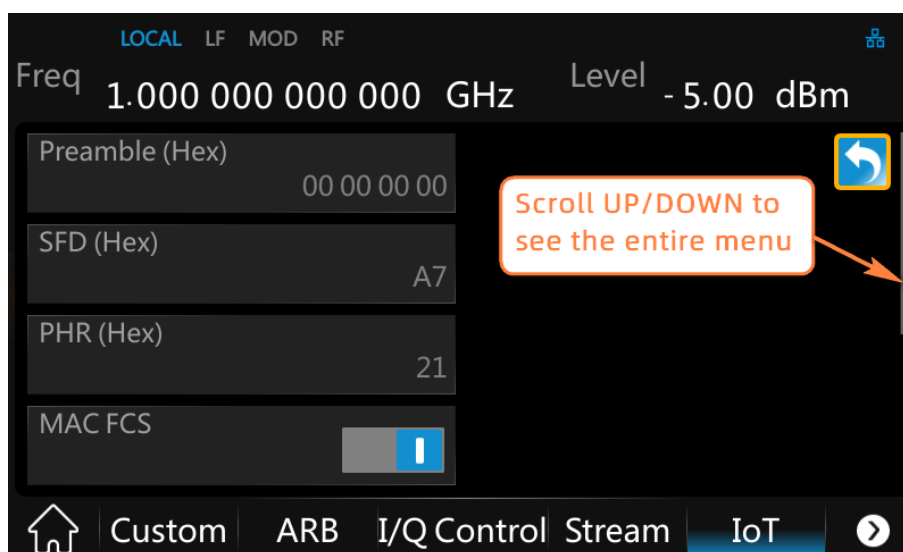

Figure 9-12 ZigBee PPDU setting interface

9.3.2.1 Preamble (Hex)

Displays the Preamble field of PPDU in hexadecimal format. The length of the Preamble field is 4 octets, and the value is fixed as “00 00 00 00” in O-QPSK and BPSK PHY.

9.3.2.2 SFD (Hex)

Displays the SFD field of PPDU in hexadecimal format. The length of the SFD field is 1 octet, and the value is fixed as “A7”.

9.3.2.3 PHR (Hex)

Displays the PHR field of PPDU in hexadecimal format. The value is automatically updated when the PSDU settings are changed.

9.3.2.4 PSDU Settings

These are the settings for the PSDU (Physical Service Data Unit) part of the frame that includes the payload data. As shown in the figure below, in the menu, the MAC Header of the first part, Data Type, Seed, Data Length and Data Mode of the second part, and MAC FCS of the third part configure the PSDU.

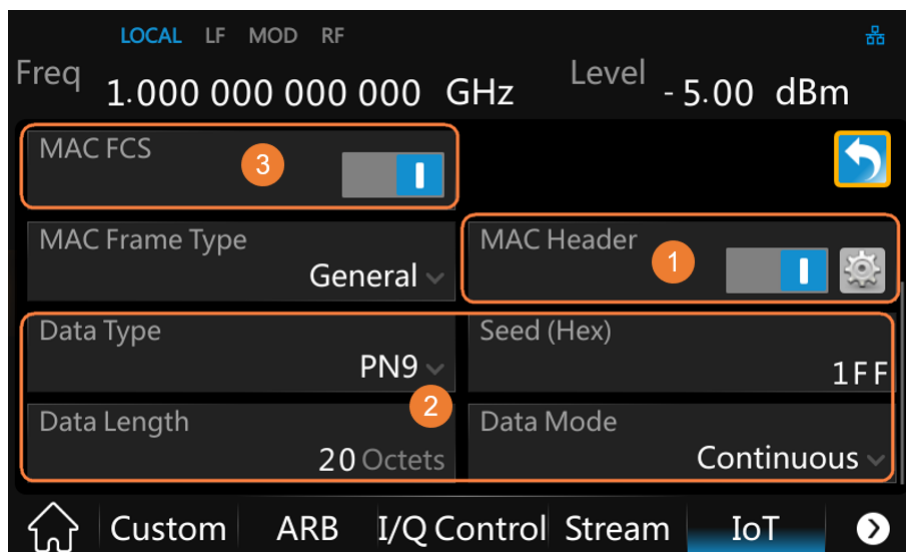

Figure 9-13 ZigBee PSDU setting interface

9.3.2.4.1 MAC Frame Type

Select the PSDU (frame structure) format.

Choices: General | Beacon | Data | Ack | MAC Command. Default: General.

9.3.2.4.2 MAC Header

1. MAC Header state

Click on the **MAC Header** switch button to either turn the header on or off.

2. MAC Header

Click the setting button to enter the header fields setting interface. The header fields vary according to the selected MAC frame type. Note that all the fields are hexadecimal input.

9.3.2.4.3 Data Type

Choices: PN9 | PN15 | User. Default: PN9 (Seed: 0x1FF).

- For PN9 and PN15 selections, the software automatically generates the data source bits. At this time the Seed field is available. You can input the PN seed in **Seed (Hex)**.
- For User selection, the **User Data** button appears instead the **Seed (Hex)** button. You can click the setting button to enter the user data editing interface.

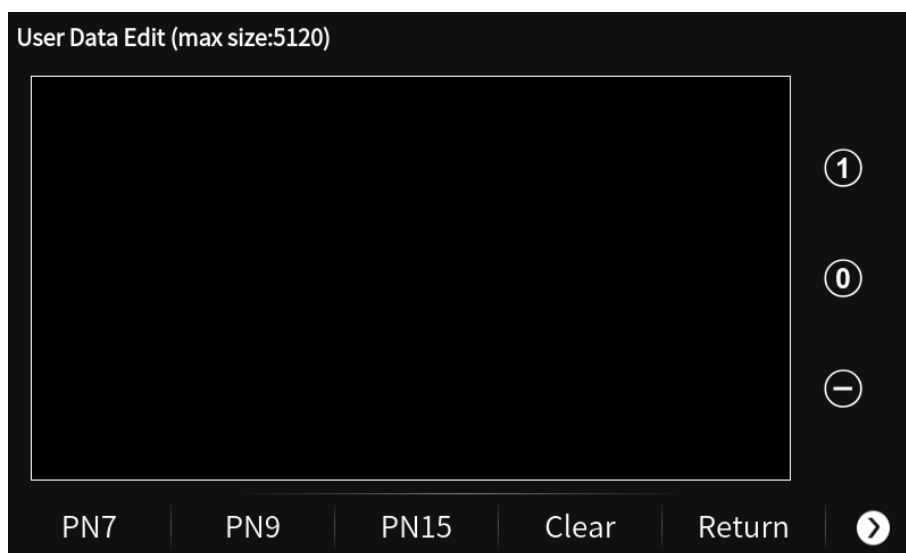

Figure 9-14 Pseudo-random code editing page

- 1) Press **1** and **0** to add single bits. Press **-** to delete single bits.
- 2) Data editing: After selecting the editing position, you can enter the numbers 0 and 1 through the touch screen keys or the front panel keyboard, or delete them.
- 3) Click **PN7** / **PN9** / **PN15** to insert PN7 or PN9 or PN15.
- 4) Click **Clear** to empty the edited PN code.
- 5) Click **Return** to return to the previous menu.
- 6) Click **>** > **Load** to select and load a UDATA file.
- 7) Click **>** > **Save** to save the current PN code to the UDATA file.

9.3.2.4.4 Data Length

Enter the length of MAC payload in octets.

Range: 0–127. Default: 20.

9.3.2.4.5 Data Mode

Choices: Continuous | Truncated. Default: Continuous

For a multi-frame signal, select the mode that is applied to the MAC payload. If there is only one frame in the signal, then there is no difference in the choices.

- Continuous: Payload data bits are continuously distributed across multiple frames.
- Truncated: Payload data bits are the same for all frames, with the data size truncated for one frame.

9.3.2.4.6 MAC FCS

Enable or disable the MAC FCS. Choices: On | Off. Default: On.

- On: Data bits fill the FCS part per the IEEE 802.15.4 standards and adds two Octets to the frame length. When there are multiple Data Length (Octets) values, the FCS octets are added to each of them.
- Off: Used to simulate an invalid FCS case and does not add any octets to the frame length.

9.3.3 Impairments

Press **Impairments** to enter the ZigBee protocol impairments settings interface.

9.3.3.1 Symbol Timing Error

Range: -300 to 300 ppm. Default: 0

Enter an error rate value that is used to shift the symbol rate. This error is added to the standard sample clock in the waveform header.

9.3.3.2 Frequency Offset

Range: -200 to 200 kHz. Default: 0

Enters an offset to the nominal carrier frequency in Hertz.

9.3.4 ZigBee State

Switch ZigBee State to turn ZigBee modulation on or off.

If you want to turn ZigBee modulation on, you should turn **MOD ON/OFF** on at the same time.

9.3.5 Save Waveform

Save the ZigBee current settings to an ARB file.

9.3.6 Update

Regenerate the waveform data based on the current settings.

9.4 Example

The following steps describe how to generate a ZigBee O-QPSK signal in 2450 MHz frequency band.

9.4.1 Restore Factory Settings

1. Press **UTILITY** > **Setting** > **Preset Type** to set the reset type to default;
2. Press **PRESET** to perform the reset operation.

9.4.2 Set the ZigBee Signal

Set **I/Q** > **IoT** > **Protocol Type** as ZigBee.

9.4.2.1 General Settings

Press **I/Q** > **IoT** > **General Settings** to set PHY scheme, frequency band and idle interval.

1. Set **PHY Scheme** as O-QPSK.
2. Set **Frequency Band** as 2450 MHz.
3. Set **Idle Interval** as 1.5 ms.

9.4.2.2 PPDU Settings

Press **I/Q** > **IoT** > **PPDU Settings** to set the PPDU.

1. Set **MAC Frame Type** as Beacon.
2. Switch **MAC Header** on. Press  to enter the header fields setting interface and set the header as:

21 Byte(s) [7898,07,369C,EFBC,CCDD,7896,123456789A,2356,2B,126F]

3. Set **Data Type** as PN15.
4. Set **Seed (Hex)** as 0x78.
5. Set **Data Length** as 40 octets.
6. Set **Data Mode** as Truncated.
7. Switch **MAC FCS** on.

9.4.2.3 Basic Settings

Press **I/Q** > **IoT** > **Basic** to set the oversampling ratio and frame number.

1. Set **Oversampling Ratio** as 10.
2. Set **Number of Frames** as 5.

9.4.3 Set the Carrier Signal

Press **FREQ** , and set **Frequency** as 1 GHz.
 Press **LEVEL** , and set **Level** as -10 dBm.

9.4.4 Turn On IQ Modulation and RF Output

1. Switch **I/Q** > **IoT** > **ZigBee State** on.
2. Press **MOD ON/OFF** on.
3. Press **RF ON/OFF** on.

9.4.5 Demod in Spectrum Analyzer

1. Connect the **[10 MHz OUT]** connector of the SSG5000X-V to the spectrum analyzer.
2. Connect the **[RF OUTPUT 50Ω]** connector of the SSG5000X-V to the spectrum analyzer.

The demod result in the spectrum analyzer can be:

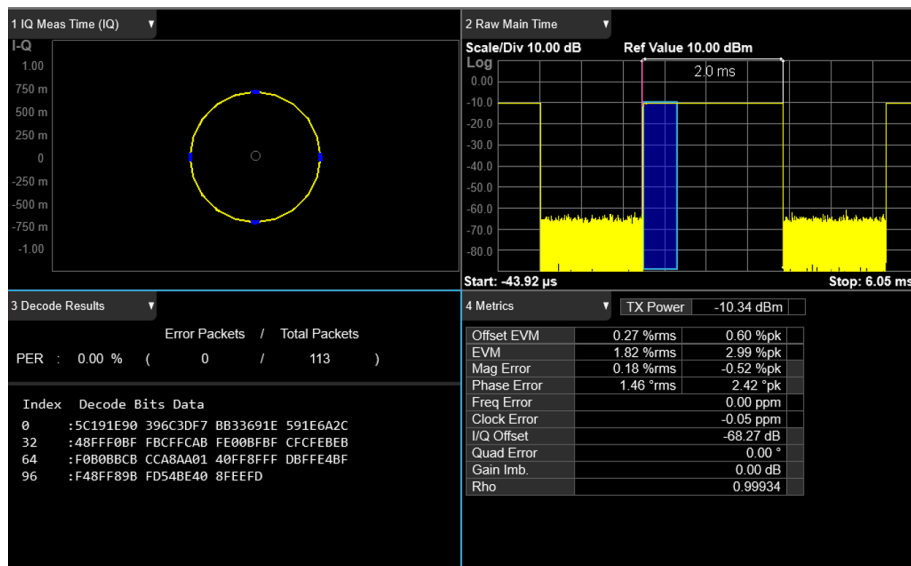

10 ITU-T G.9959 Z-Wave

10.1 About Z-Wave Protocol

The Z-Wave PHY and MAC layers are defined by Recommendation ITU-T G.9959. The protocol is an interoperable, wireless, RF-based communication technology designed for control, monitoring, and status reading applications in residential and light commercial environments.

10.1.1 Modulation and Encoding

ITU-T G.9959 PHY shall employ frequency shift keying (FSK) for RF modulation at data rates R1 and R2. The PHY shall employ Gaussian frequency shift keying (GFSK) for RF modulation at data rate R3. Manchester code shall be used for data symbol encoding at data rate R1 and non-return-to-zero (NRZ) shall be used for data symbol encoding at data rates R2 and R3.

The modulation and the coding format are summarized in table below.

Table 10-1 Modulation and coding format

Data Rate	Modulation	Coding	Frequency offset	Separation	Symbols
R1	FSK	Manchester	20 kHz	40 kHz \pm 20%	Binary
R2	FSK	NRZ	0 kHz	40 kHz \pm 20%	Binary
R3	GFSK, BT = 0.6	NRZ	0 kHz	58 kHz \pm 20%	Binary

10.1.2 Data Rates

The PHY shall comply with the data rate and accuracy requirements listed in table below.

Table 10-2 Data rate and data rate accuracy

Data rate	Bit rate	Symbol rate	Accuracy
R1	9.6 kbit/s	19.2 kbaud	\pm 27 parts per million (ppm)
R2	40 kbit/s	40 kbaud	\pm 27 ppm
R3	100 kbit/s	100 kbaud	\pm 27 ppm

10.2 Z-Wave PHY

Within the PHY (physical layer), the ITU-T G.9959 Z-Wave signal is generated on a PPDU (Physical Protocol Data Unit) basis. The general PPDU frame includes the SHR, MSDU(PSDU) and EHR parts as outlined in Figure 10-1.

The frame format is depicted in the order in which it is transmitted by the PHY, from left to right, where the leftmost bit is transmitted first in time.

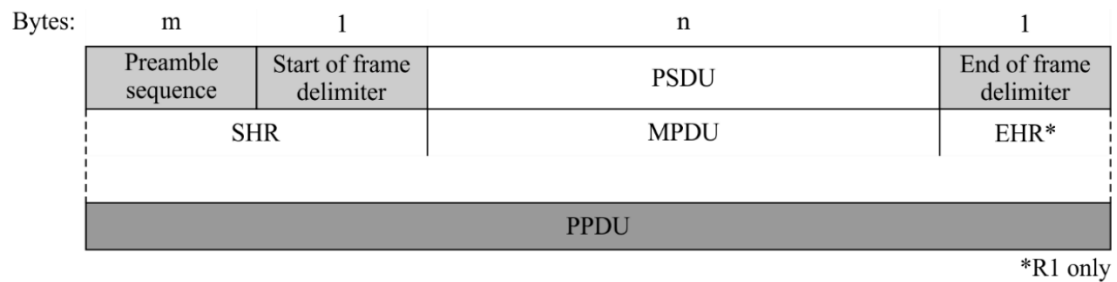

Figure 10-1 Z-Wave PPDU format

10.2.1 Preamble Field

The preamble field allows a receiver to obtain symbol synchronization. The preamble field shall be composed of a sequence of bytes containing the binary pattern "01010101".

10.2.2 Start of Frame (SOF) Delimiter Field

The SOF is an 8-bit field terminating the preamble field and the start of the PSDU. It is configurable in the software and default value is 0xF0.

10.2.3 PSDU Field

Figure 10-2 shows the structure of the general MPDU. The MSDU contains the payload data from higher layers. The MSDU is prepended with a MAC header (MHR) and appended with a MAC footer (MFR). The MHR, MSDU, and MFR together constitute the MPDU.

The MPDU is passed to the PHY layer as a PSDU.

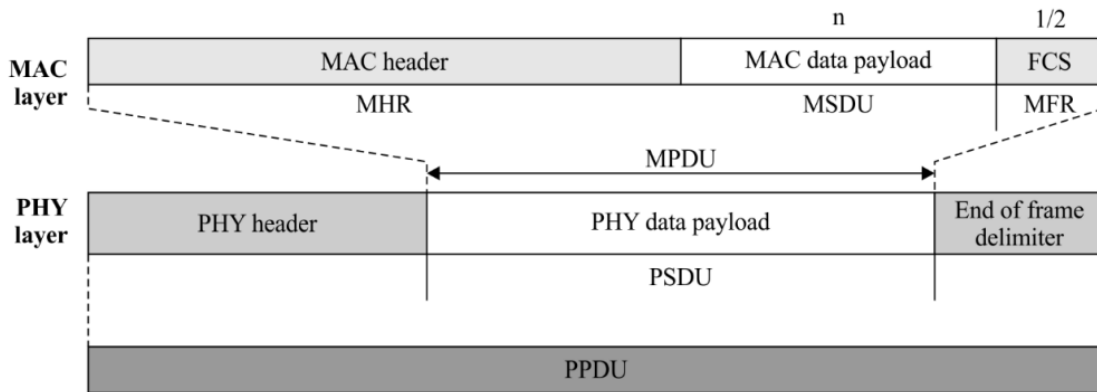

Figure 10-2 General MPDU structure

The PSDU consists of fields that are configurable with the software and the following figure shows these fields.

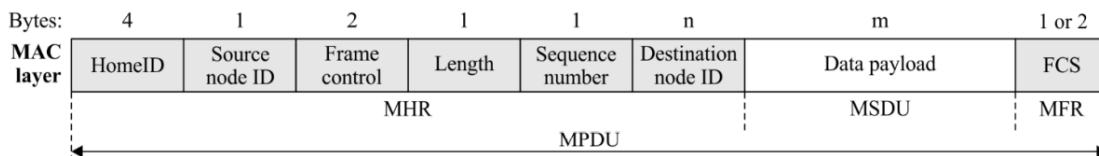

Figure 10-3 General MPDU format

10.2.3.1 Length

The length field is 1 byte in length and shall indicate the length of the PSDU in bytes. The PSDU field has a variable length. The maximum length is 64 octets for R1 and R2, and 170 octets for R3.

10.2.3.2 FCS

An 8-bit non-correcting FCS mechanism is employed to detect bit errors for data rates R1 and R2. A 16-bit non-correcting FCS mechanism is employed to detect bit errors for data rate R3.

10.2.4 End of frame (EOF) delimiter field

The EOF delimiter field shall be sent only when transmitting at data rate R1. The field shall carry a sequence of 8 Manchester code violations each denoted E. Each violation, E, shall be a symbol without transition.

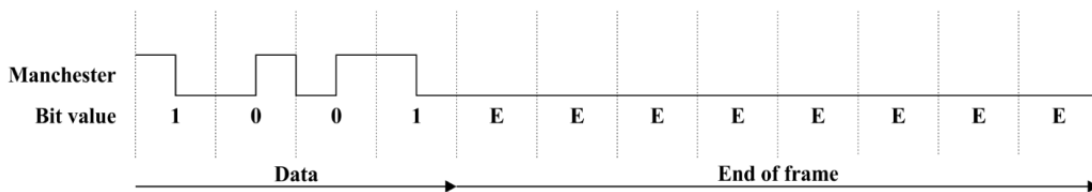

Figure 10-4 EOF delimiter pattern (R1 only)

10.3 User Interface Settings

Press **I/Q** > **IoT** > **Protocol Type** to set protocol type as Z-Wave firstly. Then you can set the parameters of Z-Wave.

10.3.1 General Settings

Press **General Settings** to enter the Z-Wave protocol general settings. In General Settings, users can set Z-Wave data rate, modulation type, idle interval as well as ramp settings.

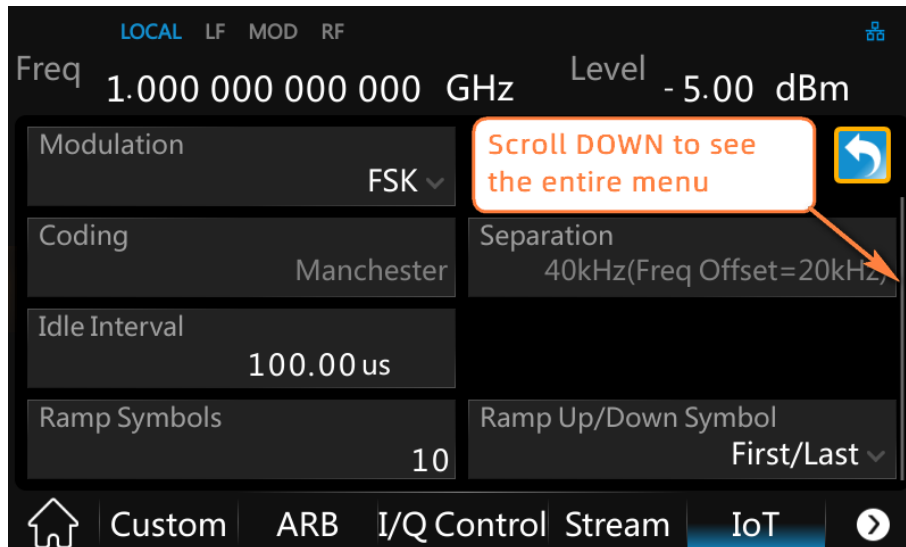

Figure 10-5 Z-Wave general setting interface

10.3.1.1 Data Rate

Set the data rate using the drop-down menu that appear when the cell is clicked.
Choices: R1–9.6 kbps | R2–40 kbps | R3–100 kbps. Default: R1–9.6 kbps.

10.3.1.2 Modulation

Select the modulation type for ITU-T G.9959. See “Table 10-1 Modulation and coding format” for details.
Choices: FSK | GFSK. Default: FSK for R1/R2, GFSK for R3.

10.3.1.3 Coding

Displays the coding type. See “Table 10-1 Modulation and coding format” for details.

10.3.1.4 Separation

Displays the separation. See “Table 10-1 Modulation and coding format” for details.

10.3.1.5 Idle Interval

Enter the idle interval in-between frames in seconds. When idle interval is set to zero, a continuous waveform is generated.

Idle interval Range: 0–200000 us. Default: 100 us.

10.3.1.6 Ramp Symbols

Enter the ramp duration in symbols for the waveform ramp up and down. When the Idle Interval setting is zero, Ramp settings is inactive.

Range: 1–10. Default: 10.

10.3.1.7 Ramp Up/Down Symbol

Select the symbol for the period of waveform ramp up and down. When the Idle Interval setting is zero, Ramp settings is inactive.

Choices: First/Last | Center | One | Zero. Default: First/Last.

- First/Last: uses the first symbol of the frame to ramp up and the last symbol to ramp down.
- Center: ramps up and down at f_0 (the center frequency between deviation).
- One: ramps up and down on 1.
- Zero: ramps up and down on 0.

10.3.2 PPDU Settings

These are the settings to configure the physical (PHY) protocol data unit (PPDU) which is the frame.

Press **PPDU Settings** to enter the Z-Wave PPDU settings.

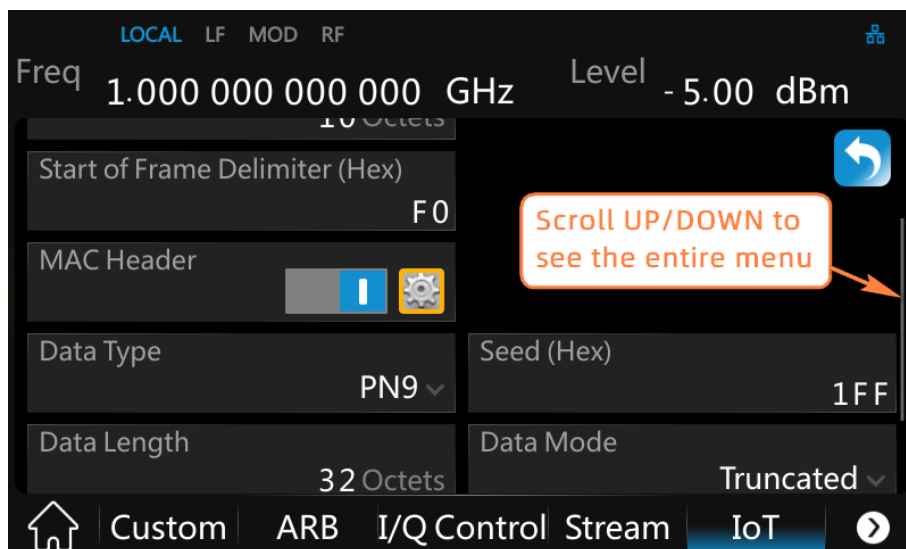

Figure 10-6 Z-Wave PPDU setting interface

10.3.2.1 PPDU Length

Display the total PPDU length in octets. See Figure 10-1 and Figure 10-3 for details.

10.3.2.2 Preamble Length

Enter the preamble length, which is part of the SHR.

Range: 10–100. Default: 10.

10.3.2.3 Start of Frame Delimiter (Hex)

Enter the SOF field in hex in SHR.

Range: 00 to FF. Default: F0.

10.3.2.4 PSDU Settings

These are the settings for the physical service data unit (PSDU) part of the frame that includes the payload data.

10.3.2.4.1 MAC Header

MAC Header state

Click on the MAC Header switch button to either turn the header on or off.

MAC Header

Click the setting button to enter the header fields setting interface. Note that all the fields are hexadecimal input.

- Length field
The length field is 1 octet in length. It cannot be set and shall indicate the length of the MPDU in octets.
- Sequence Number field
You can turn the sequence number field on or off by clicking the check box.

10.3.2.4.2 Data Type

Choices: PN9 | PN15 | User. Default: PN9 (Seed: 0x1FF).

- For PN9 and PN15 selections, the software automatically generates the data source bits. At this time the Seed field is available. You can input the PN seed in **Seed (Hex)**.
- For User selection, the **User Data** button appears instead the **Seed (Hex)** button. You can click the setting button to enter the user data editing interface.

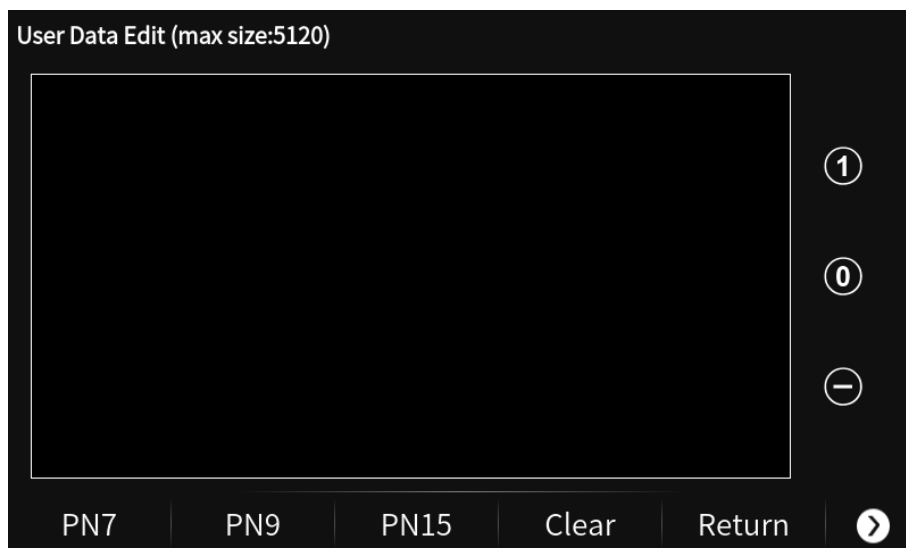

Figure 10-7 Pseudo-random code editing page

- 1) Press **1** and **0** to add single bits. Press **-** to delete single bits.
- 2) Data editing: After selecting the editing position, you can enter the numbers 0 and 1 through the touch screen keys or the front panel keyboard, or delete them.
- 3) Click **PN7** / **PN9** / **PN15** to insert PN7 or PN9 or PN15.
- 4) Click **Clear** to empty the edited PN code.
- 5) Click **Return** to return to the previous menu.
- 6) Click **>** > **Load** to select and load a UDATA file.
- 7) Click **>** > **Save** to save the current PN code to the UDATA file.

10.3.2.4.3 Data Length

The Data Payload field has a variable length. The maximum length of Data Payload field is 54 octets for R1 and R2, and 158 octets for R3.

Range: 0–maximum length. Default: 32.

10.3.2.4.4 Data Mode

Choices: Continuous | Truncated. Default: Continuous

For a multi-frame signal, select the mode that is applied to the MAC payload. If there is only one frame in the signal, then there is no difference in the choices.

- Continuous: Payload data bits are continuously distributed across multiple frames.
- Truncated: Payload data bits are the same for all frames, with the data size truncated for one frame.

10.3.2.4.5 MAC FCS

Enable or disable the MAC FCS. Choices: On | Off. Default: On.

- On: data bits fill the FCS part per the standards.
- Off: used to simulate an invalid FCS case.

10.3.2.5 End of Frame Delimiter

Enable or disable EHR in the PPDU. It is set to off and read-only for data rate R2 and R3.

Choices: On | Off. Default: On.

10.3.3 Impairments

Press **Impairments** to enter the Z-Wave protocol impairments settings interface.

10.3.3.1 Symbol Timing Error

Range: -300 to 300 ppm. Default: 0

Enter an error rate value that is used to shift the symbol rate. This error is added to the standard sample clock in the waveform header.

10.3.3.2 Frequency Offset

Range: -200 to 200 kHz. Default: 0

Enters an offset to the nominal carrier frequency in Hertz.

10.3.3.3 Frequency Deviation Scaling

Range: 50–150%. Default: 100%.

Enter additional scaling to the nominal FSK frequency deviation. This is the equivalent to applying scaling to the FSK modulation index.

10.3.3.4 Gaussian BT

Range: 0.1–10. Default: 0.6.

Enter the BT product of the filter applied to FSK modulation.

Visible only when the Modulation selection is GFSK.

10.3.4 Z-Wave State

Switch Z-Wave State to turn Z-Wave modulation on or off.

If you want to turn Z-Wave modulation on, you should press **MOD ON/OFF** on at the same time.

10.3.5 Save Waveform

Save the Z-Wave current settings to an ARB file.

10.3.6 Update

Regenerate the waveform data based on the current settings.

10.4 Example

The following steps describe how to generate a Z-Wave signal in R2-40 kbps data rate.

10.4.1 Restore Factory Settings

1. Press **UTILITY** > **Setting** > **Preset Type** to set the reset type to default;
2. Press **PRESET** to perform the reset operation.

10.4.2 Set the Z-Wave Signal

Set **I/Q** > **IoT** > **Protocol Type** as Z-Wave.

10.4.2.1 General Settings

Press **I/Q** > **IoT** > **General Settings** to enter Z-Wave general settings interface, and you can set the data rate, idle interval and ramp.

1. Set **Data Rate** as R2-40 kbps. The default modulation shall be FSK.
2. Set **Idle Interval** as 100 us.
3. Set **Ramp Symbols** as 6.
4. Set **Ramp Up/Down Symbol** as Zero.

10.4.2.2 PPDU Settings

Press **I/Q** > **IoT** > **PPDU Settings** to set the PPDU.

1. Set **Preamble Length** as 12 octets.
2. Set **Start of Frame Delimiter (Hex)** as 2B.
3. Switch **MAC Header** on. Press  to enter the header fields setting interface and set the header as:

10 Bytes [6B3552B6,36,3EB2,39,69,3B]

- The Length field cannot be set and shall indicate the length of the MPDU(PSDU) in octets.
 - When you set the Sequence Number field, you should turn it on first.
4. Set **Data Type** as User.
 5. Click **User Data** and insert PN9.
 6. Set **Data Length** as 45 octets.
 7. Set **Data Mode** as Continuous.
 8. Turn on **MAC FCS**.

10.4.2.3 Basic Settings

Press **I/Q** > **IoT** > **Basic** to set the oversampling ratio and frame number.

1. Set **Oversampling Ratio** as 10.
2. Set **Number of Frames** as 6.

10.4.3 Set the Carrier Signal

1. Press **FREQ**, and set **Frequency** as 1 GHz.
2. Press **LEVEL**, and set **Level** as -5 dBm.

10.4.4 Turn On IQ Modulation and RF Output

1. Switch **I/Q** > **IoT** > **Z-Wave State** on.
2. Press **MOD ON/OFF** on.
3. Press **RF ON/OFF** on.

10.4.5 Demod in Spectrum Analyzer

1. Connect the **[10 MHz OUT]** connector of the SSG5000X-V to the spectrum analyzer.
2. Connect the **[RF OUTPUT 50Ω]** connector of the SSG5000X-V to the spectrum analyzer.

The demod result in the spectrum analyzer can be:

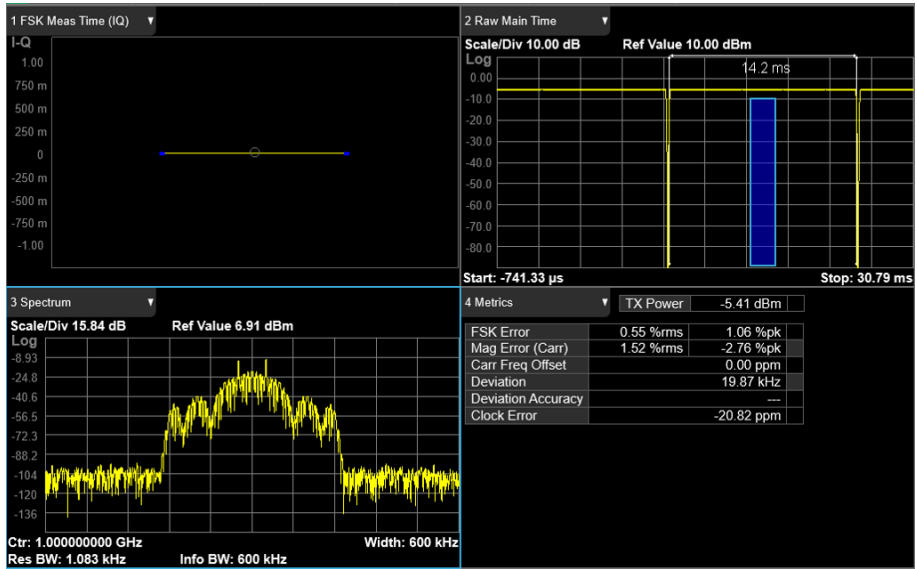

11 Remote Control

The RF signal source has USB, LAN and USB-GPIB interfaces. Based on these three interfaces, users can achieve remote control of RF signal source in a variety of ways.

11.1 Remote Control via SCPI

Based on the above mentioned interfaces, the RF signal source supports remote control by sending SCPI commands to the instrument through NI-VISA, Telnet or Socket connection. For details, please refer to the programming manual of this product.

11.2 Web Control

The RF signal source also supports user access and control through a web browser. Users can access the RF signal source by entering the instrument IP address in the browser address bar.

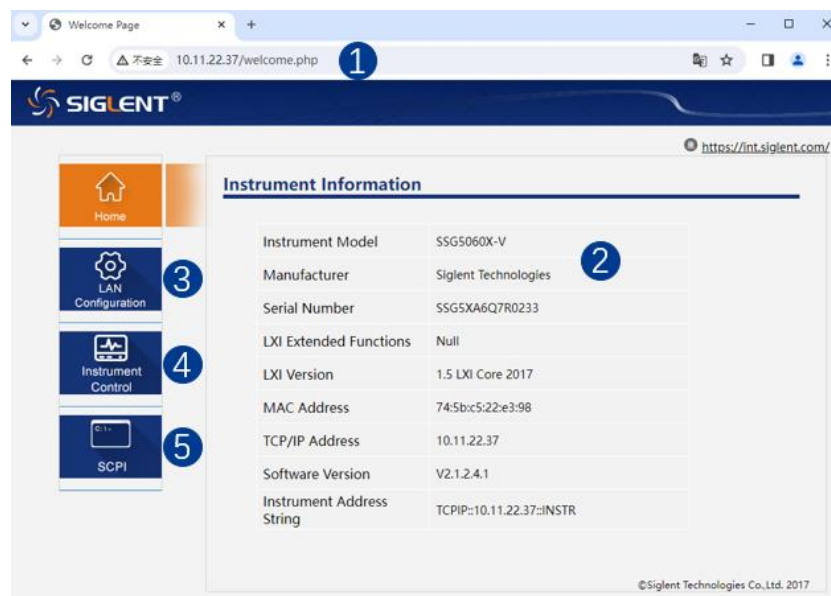

1. Input the IP address of the instrument
2. Instrument information
3. LAN configuration
4. Click here to recall the instrument control interface
5. Click here to send SCPI

Note: For details on the settings of the web page control switch, web page access password and IP address, please refer to the "Interface" section.

Below is the instrument control interface over WebServer:

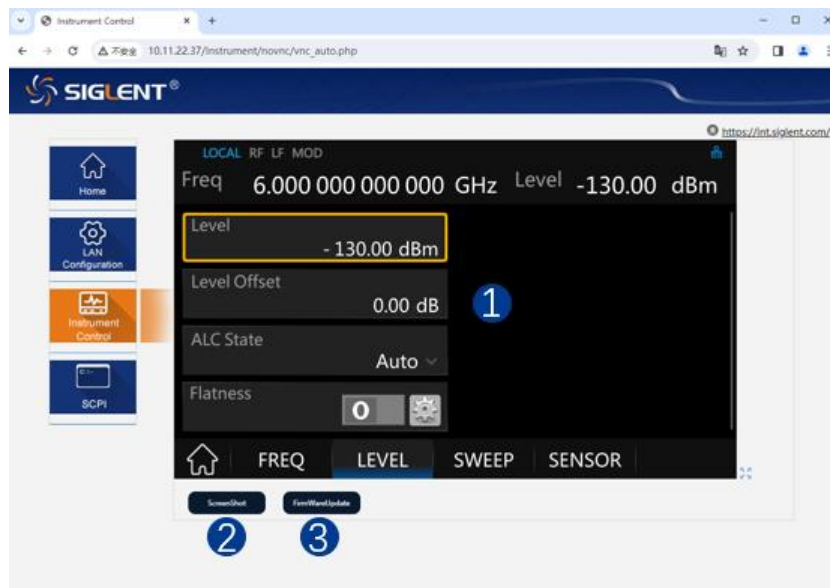

1. Display and control area of the instrument. The display in this area is a copy of the instrument display. Using the mouse to operate in the area is equivalent to directly operating on the display of the instrument
2. Click here to perform a screenshot
3. Click here to perform a firmware upgrade

12 Troubleshooting

The following lists the possible faults and troubleshooting methods that may occur during the use of the RF signal source. When you encounter these faults, please follow the corresponding steps to handle them. If the problem remains, please contact **SIGLENT** as soon as possible.

1. The screen is still black with no display after power on:
 - 1) Check the power supply:
 - Check that the power connector is connected correctly,
 - Check that the power switch is turned on.
 - 2) Check whether the fan rotates normally:
 - If the fan rotates and the screen does not light up, the screen connection cable may be loose.
 - If the fan does not rotate, it means the instrument has not been successfully powered on. Please refer to step 2.
 - 3) Check whether the fuse is burned out. If the fuse needs to be changed, please contact **SIGLENT** timely and return the instrument to the factory for replacement by **SIGLENT** authorized maintenance personnel.
 - 4) After completing the above checks, please restart the instrument. If you still cannot start the product normally, please contact **SIGLENT**.

2. No response when pressing keys or key strings:
 - 1) After powering on, confirm whether all buttons are unresponsive.
 - 2) Press **UTILITY** > **Self Test** > **Key Test** to confirm whether there is any unresponsive button or key string phenomenon.
 - 3) If the above fault exists, it may be that the keyboard connection cable is loose or the keyboard is damaged. Please do not disassemble the instrument yourself and contact **SIGLENT** in time.

3. The settings are correct but the waveform output is incorrect:
 - 1) No RF output
 - Check whether the signal cable is firmly connected to the **[RF OUTPUT 50Ω]** port.
 - Check the connecting cable for damage.
 - Check whether the **RF ON/OFF** button light is on. If it is not lit, press the key to light it, and the RF icon in the status bar of the user interface turns blue. At this point the **RF ON/OFF** output is turned on correctly.
 - Check whether the signal output amplitude is too small and adjust the output amplitude appropriately.

- 2) No modulation on RF output
 - Check whether the signal cable is firmly connected to the **[RF OUTPUT 50Ω]** port.
 - Check the connecting cable for damage.
 - Check whether the **[MOD ON/OFF]** and **[RF ON/OFF]** button lights are on, and check whether the modulation switch is turned on.
 - Check whether the modulation parameters are appropriate and adjust the modulation parameters appropriately.
 - If using an external modulation source, make sure the external source is connected correctly and has an output, and it should work within the specified range of the signal source.

4. Sweep function abnormality
 - 1) Sweeping stalled

The user interface displays a sweeping progress bar in the frequency/level area, indicating that the sweeping operation is in progress. If stagnation occurs, there are a few things you should check:

 - Turn on at least one sweep type: Press **[SWEEP]** > **Sweep State** and select "Freq", "Level" or "Freq & Level".
 - If it is single sweep mode, click **Execute single sweep** and when the trigger conditions are met, a sweep will be started.
 - If the sweep trigger mode is not automatic trigger, set the sweep trigger mode to "Auto" to determine whether the sweep trigger loss is blocking the sweep.
 - If the point trigger mode is not automatic, set the point trigger mode of the sweep to "Auto" to determine whether point trigger loss is blocking the sweep.
 - Determine whether the dwell time is too large or too small, resulting in no visible sweeps.
 - 2) There is no change in amplitude in list or step sweep
 - Make sure the sweep type is set to Level or Freq & Level.
 - If the current sweep type is set to frequency, the amplitude value does not change.

5. The USB storage device cannot be recognized:
 - 1) Check whether the USB storage device can work normally.
 - 2) Make sure the USB interface can work normally.
 - 3) Make sure that the USB storage device being used is a flash storage type. This signal source does not support hardware storage type.
 - 4) Restart the instrument and then insert the USB storage device to check it.
 - 5) If the USB storage device still cannot be used normally, please contact **SIGLENT**.

6. Inaccurate measurement results or insufficient accuracy:

Users can obtain detailed descriptions of technical indicators from the data sheet to calculate system errors and check measurement results and accuracy issues. To achieve the performance specifications listed in this manual, you need to:

- 1) Check if the RF signal source is within the calibration period (1 year).
- 2) Verify that the RF signal source has been warmed up for at least 30 minutes before testing.
- 3) Check that the performance of the test equipment used meets the requirements.
- 4) Ensure that the test equipment used is within the calibration cycle.
- 5) Check if the test equipment used is under the working conditions required by its manual.
- 6) Check if all connections are tightened.

7. Pop-up Message:

The instrument may display prompt messages, error messages or status messages according to the current working status. These messages can help you to use the instrument correctly and are not instrument failures.



About SIGLENT

SIGLENT is an international high-tech company, concentrating on R&D, sales, production and services of electronic test & measurement instruments.

SIGLENT first began developing digital oscilloscopes independently in 2002. After more than a decade of continuous development, SIGLENT has extended its product line to include digital oscilloscopes, isolated handheld oscilloscopes, function/arbitrary waveform generators, RF/MW signal generators, spectrum analyzers, vector network analyzers, digital multimeters, DC power supplies, electronic loads and other general purpose test instrumentation. Since its first oscilloscope was launched in 2005, SIGLENT has become the fastest growing manufacturer of digital oscilloscopes. We firmly believe that today SIGLENT is the best value in electronic test & measurement.

Headquarters:

SIGLENT Technologies Co., Ltd
Add: Bldg No.4 & No.5, Antongda Industrial
Zone, 3rd Liuxian Road, Bao'an District,
Shenzhen, 518101, China
Tel: + 86 755 3688 7876
Fax: + 86 755 3359 1582
Email: sales@siglent.com
Website: int.siglent.com

North America:

SIGLENT Technologies America, Inc
6557 Cochran Rd Solon, Ohio 44139
Tel: 440-398-5800
Toll Free: 877-515-5551
Fax: 440-399-1211
Email: info@siglentna.com
Website: www.siglentna.com

Europe:

SIGLENT Technologies Germany GmbH
Add: Staetzlinger Str. 70
86165 Augsburg, Germany
Tel: +49(0)-821-666 0 111 0
Fax: +49(0)-821-666 0 111 22
Email: info-eu@siglent.com
Website: www.siglenteu.com

Follow us on
Facebook: [SiglentTech](https://www.facebook.com/SiglentTech)

