TeleVideo® Model 925 CRT Terminal Installation and User's Guide



Vital Statistics

When you receive your terminal, enter here the serial number (on rear panel), date received, and switch settings. This will expedite any technical conversations about your terminal.

Serial Number _____

Date Received _____

Switch Settings Used:

(Enter U or D for Up or Down)	S1	U/D	S2	U/D	S3	U/D
		1 ___		1 ___		1 ___
		2 ___		2 ___		2 ___
		3 ___		3 ___		3 ___
		4 ___		4 ___		4 ___
		5 ___		5 ___		5 ___
		6 ___		6 ___		6 ___
		7 ___		7 ___		7 ___
		8 ___		8 ___		8 ___
		9 ___		9 ___		9 ___
		10 ___		10 ___		10 ___

Disclaimer

TeleVideo Systems, Inc. makes no representations or warranties with respect to this manual. Further, TeleVideo Systems, Inc. reserves the right to make changes in the specifications of the product described within this manual at any time without notice and without obligation of TeleVideo Systems, Inc. to notify any person of such revision or changes.

TELEVIDEO SYSTEMS, INC.
1170 Morse Avenue
Sunnyvale, California 94086
408/745-7760

“**Warning:** This equipment generates, uses, and can radiate radio frequency energy, and if not installed and used in accordance with the instruction manual may cause interference to radio communications. As temporarily permitted by regulation, it has not been tested for compliance with the limits for Class A computing devices pursuant to Subpart J of Part 15 of FCC Rules, which are designed to provide reasonable protection against such interference. Operation of this equipment in a residential area is likely to cause interference, in which case the user at his own expense will be required to take whatever measures may be required to correct the interference.”

MODEL 925 OPERATOR'S MANUAL

**Specifications and Information Subject to Change
Without Prior Notification**

**TeleVideo No. B300013-001
Revision B
Copyright TeleVideo Systems, Inc.
19 May 1982**

Copyright © 1982 by TeleVideo Systems, Inc. All rights reserved. No part of this publication may be reproduced, transmitted, transcribed, stored in a retrieval system, or translated into any language or computer language, in any form or by any means, electronic, mechanical, magnetic, optical, chemical, manual, or otherwise, without the prior written permission of TeleVideo Systems, Inc., 1170 Morse Avenue, Sunnyvale, California 94086.

TABLE OF CONTENTS

<p>WARRANTY POLICY AND RETURNED MATERIAL PROCEDURE SPECIFICATIONS iii</p> <p>1. INTRODUCTION iv</p> <p> 1.1 Description of Manual 1</p> <p> 1.2 How to Use This Manual 1</p> <p> 1.3 Description of Terminal 1</p> <p> 1.4 Protect Yourself! 1</p> <p> 1.5 Protect the Terminal 2</p> <p>2. INSTALLATION</p> <p> 2.1 Introduction 2</p> <p> 2.2 Unpacking and Inspecting the Terminal 2</p> <p> 2.2.1 Shipping Damage Inspection 2</p> <p> 2.2.2 Unpacking the Terminal 2</p> <p> 2.2.3 Inspecting the Terminal 2</p> <p> 2.2.4 Reporting Damage 2</p> <p> 2.2.5 Reshipping the Terminal 2</p> <p> 2.3 Preparing the Site 3</p> <p> 2.3.1 Power Requirements 3</p> <p> 2.3.2 Physical Requirements 3</p> <p> 2.4 Installation 3</p> <p> 2.4.1 Power Configuration 3</p> <p> 2.4.1.1 115 VAC Configuration 3</p> <p> 2.4.1.2 230 VAC Configuration 3</p> <p> 2.4.1.3 Setting Power Select Switch 3</p> <p> 2.4.2 Connecting the Terminal to Your Computer System 3</p> <p> 2.4.3 Interfacing to a Printer 5</p> <p> 2.4.4 Configuring the Terminal for the Computer and Printer 5</p> <p> 2.4.4.1 Character Sets 6</p> <p> 2.4.4.2 Video Display 6</p> <p> 2.4.5 Composite Video Jumper Option 6</p> <p> 2.4.6 Two-Page Memory Option 6</p> <p> 2.4.7 Additional Field Modifications 6</p> <p> 2.5 Checking Your Installation 6</p> <p>3. OPERATION</p> <p> 3.1 Introduction 6</p> <p> 3.2 Turning On the Terminal 6</p> <p> 3.2.1 Rear Controls 6</p> <p> 3.2.2 Turning On the Terminal 7</p> <p> 3.3 Keyboard Controls 7</p> <p> 3.3.1 Keyboard Layout 7</p> <p> 3.3.2 Other Controls 11</p> <p> 3.3.2.1 Cursor 11</p> <p> 3.3.2.2 Cursor Addressing 11</p> <p> 3.3.2.3 Bell 11</p> <p> 3.3.2.4 Break 11</p> <p> 3.4 Basic Operations 11</p> <p> 3.4.1 925 Status Line and Setup Mode 12</p> <p> 3.4.2 Editing 12</p> <p> 3.4.3 Tab Controls 12</p> <p> 3.4.4 Emulations 14</p> <p> 3.4.5 Transmission Modes 14</p> <p> 3.4.5.1 Conversation Mode 14</p> <p> 3.4.5.1.1 Half Duplex Mode 14</p> <p> 3.4.5.1.2 Full Duplex Mode 14</p> <p> 3.4.5.2 Block Mode 14</p> <p> 3.4.6 Sending Data to the Printer 14</p> <p>4. PROGRAMMING</p> <p> 4.1 Introduction 14</p> <p> 4.2 Monitor Mode 14</p> <p> 4.3 Function Keys 15</p> <p> 4.4 FUNCT (Function) Key 15</p> <p> 4.5 Addressing and Reading the Cursor 15</p> <p> 4.5.1 Addressing the Cursor 15</p> <p> 4.5.2 Reading the Cursor 16</p>	<p> 4.6 Video Attributes 16</p> <p> 4.7 Tabs 17</p> <p> 4.7.1 Setting Tabs (ESC 1) 17</p> <p> 4.7.2 Using Tabs 17</p> <p> 4.7.2.1 Typewriter Tab (Protect and Unprotect) (CTRL/I) 17</p> <p> 4.7.2.2 Field Tab (Protect Only) (ESC i) 17</p> <p> 4.7.2.3 Back Tab (ESC I) 17</p> <p> 4.7.3 Clearing Tabs 18</p> <p> 4.8 Protect Mode 18</p> <p> 4.8.1 Application 18</p> <p> 4.8.2 Effect 18</p> <p> 4.8.3 Procedure 18</p> <p> 4.8.3.1 Input 18</p> <p> 4.8.3.2 Protection 18</p> <p> 4.9 Editing Control 18</p> <p> 4.9.1.1 Set Local Edit Mode 18</p> <p> 4.9.1.2 Set Duplex Edit Mode (ESCI) 19</p> <p> 4.9.2 Cursor Control 19</p> <p> 4.9.2.1 Cursor Control Codes 19</p> <p> 4.9.2.2 Normal and Reverse Linefeed 19</p> <p> 4.9.2.3 Editing Commands 20</p> <p> 4.9.2.4 Clear Function 20</p> <p> 4.10 Send Function 20</p> <p> 4.10.1 Send Line Unprotected (ESC 4) 20</p> <p> 4.10.2 Send Page Unprotected (ESC 5) 20</p> <p> 4.10.3 Send Line All (ESC 6) 20</p> <p> 4.10.4 Send Page All (ESC 7) 21</p> <p> 4.10.5 Send Message Unprotected (ESC S) 21</p> <p> 4.10.6 Send Message All (ESC s) 21</p> <p> 4.11 Termination Character Selection 21</p> <p> 4.12 Print Function Programming 21</p> <p> 4.12.1 Page Print (ESC P) 21</p> <p> 4.12.2 Transparent Print On (ESC `) 21</p> <p> 4.12.2.1 Transparent Print Off (ESC a) 21</p> <p> 4.12.3 Extension Mode On (ESC @) 21</p> <p> 4.12.4 Extension (Copy Print) Mode Off (ESC A) 21</p> <p> 4.12.5 Enable Bidirectional Port (CTRL/R) 21</p> <p> 4.12.5.1 Disable Bidirectional Port (CTRL/T) 22</p> <p> 4.12.6 Send Time of Day 22</p> <p> 4.12.7 Printer Termination Character 22</p> <p> 4.13 X-ON/X-OFF Control 22</p> <p> 4.14 DTR Control 22</p> <p> 4.15 Time of Day Clock 22</p> <p> 4.16 Keyboard Keyclick 22</p> <p> 4.17 Disabling the Keyboard 22</p> <p> 4.18 Screen Time Out 23</p> <p> 4.19 Page Control 23</p> <p> 4.20 User Line 23</p> <p> 4.20.1 To Load the User Line 23</p> <p> 4.20.2 Entering Data 23</p> <p> 4.21 912/920C Emulation 23</p> <p> 4.22 Cursor Attributes 23</p> <p> 4.23 Screen Off 23</p> <p>5. PREVENTIVE MAINTENANCE 23</p> <p> 5.1 Care 23</p> <p> 5.1.1 Cleaning 23</p> <p> 5.1.2 Inspection 23</p> <p>6. TROUBLESHOOTING AND REPAIR 24</p> <p> 6.1 Troubleshooting 24</p> <p> 6.1.1 Testing the Terminal (Self Test) 24</p> <p> 6.2 Repair 24</p> <p> 6.2.1 Changing the Line Fuse 24</p> <p> 6.2.2 Changing the Power Supply Fuses 24</p> <p> TROUBLE SHOOTING CHART 25</p> <p> GLOSSARY 27</p> <p> US ASCII CHART 29</p>
---	--

LIMITED WARRANTY AND RETURNED MATERIAL PROCEDURE

STATEMENT OF LIMITED WARRANTY

TeleVideo Systems, Inc. ("TeleVideo") warrants to Buyer that products, except software, manufactured by TeleVideo will be free from defects in material and workmanship. TeleVideo's obligations under this warranty will be limited to repairing or replacing, at TeleVideo's option, the part or parts of the products which prove defective in material or workmanship within 90 days after shipment by TeleVideo, provided that Buyer gives TeleVideo prompt notice of any defect and satisfactory proof thereof. Products may be returned by Buyer only after a Return Material Authorization number ("RMA") has been obtained from TeleVideo by telephone or in writing. Buyer will prepay all freight charges to return any products to the repair facility designated by TeleVideo and include the RMA number on the shipping container. TeleVideo will deliver replacements for defective products or parts on an exchange basis to Buyer, freight prepaid to the Buyer. Products returned to TeleVideo under this warranty will become the property of TeleVideo. With respect to any product or part thereof not manufactured by TeleVideo, only the warranty, if any, given by the manufacturer thereof, will apply.

EXCLUSIONS

This limited warranty does not cover losses or damage which occurs in shipment to or from Buyer or is due to (1) improper installation or maintenance, misuse, neglect or any cause other than ordinary commercial or industrial application or (2) adjustment, repair or modifications by other than TeleVideo-authorized personnel or (3) improper environment, excessive or inadequate heating or air conditioning and electrical power failures, surges or other irregularities or (4) any statements made about TeleVideo's products by salesmen, dealers, distributors or agents, unless confirmed in writing by a TeleVideo officer.

THE FOREGOING TELEVIDEO LIMITED WARRANTY IS IN LIEU OF ALL OTHER WARRANTIES, WHETHER ORAL, WRITTEN, EXPRESS, IMPLIED OR STATUTORY. IMPLIED WARRANTIES OF MERCHANTABILITY AND FITNESS FOR A PARTICULAR PURPOSE WILL NOT APPLY. TELEVIDEO'S WARRANTY OBLIGATIONS AND BUYER'S REMEDIES HEREUNDER ARE SOLELY AND EXCLUSIVELY AS STATED HEREIN. TELEVIDEO MAKES NO WARRANTY WHATSOEVER CONCERNING ANY SOFTWARE PRODUCTS, WHICH ARE SOLD "AS IS" AND "WITH ALL FAULTS."

TELEVIDEO'S LIABILITY, WHETHER BASED ON CONTRACT, TORT, WARRANTY, STRICT LIABILITY OR ANY OTHER THEORY, SHALL NOT EXCEED THE PRICE OF THE INDIVIDUAL UNIT WHOSE DEFECT OR DAMAGE IS THE BASIS OF THE CLAIM. IN NO EVENT SHALL TELEVIDEO BE LIABLE FOR ANY LOSS OF PROFITS, LOSS OF USE OF FACILITIES OR EQUIPMENT, OR OTHER INDIRECT, INCIDENTAL OR CONSEQUENTIAL DAMAGES.

Service Out of Warranty

If your terminal is out of warranty when it needs service, you should follow the same procedure to receive an RMA. You will be responsible for all shipping costs.

Should your company require a purchase order for out-of-warranty repairs, let us know the purchase order number when you call in. One purchase order may cover several repairs but we will give each item its own individual RMA number. This allows us to return each item quickly and not hold up the entire purchase order because of one item.

Technical Assistance (Other than Repair)

The Technical Marketing Support Group is normally open from 8:00 a.m. until 5:00 p.m., Pacific Time, continuously, Monday through Friday. If the line is busy and your problem can wait, leave a message with the TeleVideo operator and your call will be returned at our first opportunity.

Extended Warranty

TeleVideo offers an Extended Warranty Contract. To take advantage of this Extended Warranty, you must sign the Extended Warranty Contract and return it, together with full payment, to TeleVideo prior to the end of your normal warranty period. The extended warranty lasts for one year; the cost is \$75.00

To renew the extended warranty for another year, the same procedure must be followed.

Shipping charges are *not* included in the Extended Warranty. This is the only expense you incur.

SPECIFICATIONS

MONITOR

Size: 12 inches measured diagonally
Phosphor: P31 nonglare green screen

DISPLAYED CHARACTER SET

128 displayable characters
(96 character ASCII upper/lower case alphabet with true descenders plus 32 control characters)
24 lines
80 characters per line
25th Status Line
1920 characters per screen

VIDEO ATTRIBUTES

Blinking fields
Security (blank) fields
Reverse video
Underlined fields
Half intensity

CHARACTER SETS

English, French, German, Spanish

EMULATIONS

TeleVideo 912/920 terminals

CHARACTER FONT

7X8 dot matrix
8X10 resolution

CURSOR CONTROL

↑, ↓, ←, →, Home, Tab, Back Tab, Return, Line Feed, Backspace

EDITING

Line insert/delete
Character insert/delete
Line scroll
No Scroll

REPEAT

20-cps auto-repeat

PARITY

Even, Odd, Mark, Space or No Parity

TRANSMISSION

Conversation mode: Full or half duplex (keyboard selectable), Block mode

BAUD RATE

15 baud rates: 50, 75, 110, 135, 150, 300, 600, 1200, 1800, 2400, 3600, 4800, 7200, 9600, 19,200

WORD STRUCTURE

7 or 8 data bits
One or 2 stop bits
10-11 bit word

INTERFACES

Standard RS232C point-to-point
20ma current loop (optional)
RS232C printer port (bidirectional)

AUXILLIARY PORT

Printer RS232C, bidirectional, page print, buffered transparent, buffered with screen copy

COMMUNICATION PROTOCOL

X-ON/X-OFF, DTR

DIMENSIONS

Cabinet dimensions: 16.50" (41.9 cm) wide X 14.00" (35.6 cm) deep X 14.25" (36.2 cm) high
Keyboard dimensions: 16.50" (41.9 cm) wide X 7.50" (19.0 cm) X 3.00" (7.6 cm) high

VENTILATION REQUIREMENTS

Minimum 4 inches (10.2 cm)

WEIGHT

Cabinet Weight: 30 lbs. (13.6 kg)
Keyboard Weight: 4.5 lbs. (2.04 kg)
Shipping Weight: 44 lbs. (19.96 kg)

AMBIENT OPERATION TEMPERATURE

32° F (0° C) to 122° F (50° C)

RELATIVE HUMIDITY (nonoperating)

No restrictions

POWER REQUIREMENTS

115 VAC at 0.5 amp
230 VAC at 0.25 amp
50/60 Hz, 55W

1. INTRODUCTION

1.1 DESCRIPTION OF MANUAL

This manual will teach you how to install, operate, program, and troubleshoot your new terminal. The manual has been designed to help you use the terminal easily regardless of your previous experience with terminals. As you progress through the manual, you will find the following chapters:

2. Installation

Setting up your site for the terminal, the power requirements, unpacking and checking the terminal, setting switches to take advantage of the options available, configuring the terminal for your computer system and printer.

3. Operation

Turning on the terminal, a description of the keyboard and functions of the keys, using tabs, editing, sending data to the computer and the printer.

4. Programming

Controlling the terminal through commands from your computer system: programming special functions, setting visual attributes, monitoring the program, loading and reading the cursor position, disabling the keyboard and printer.

5. Preventive Maintenance

Periodic cleaning and inspection of the terminal.

6. Troubleshooting and Repair

Troubleshooting simple problems (using a table of symptoms, possible causes, and solutions), using self-test.

Glossary

Explanation of terms commonly used in this manual.

Appendices

Reference tables.

Index

References to main subsections by subject.

1.2 HOW TO USE THIS MANUAL

Each subsection of the manual is numbered. To find a topic later, look in the index and find the appropriate subsection.

As you read the manual, you will notice some special symbols at the left margin of the text. These symbols call your attention to information of special importance. The symbols used are:



General note giving information to every operator.

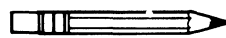

Programming note giving information of special significance to the programmer.



Warning giving information concerning the safety of the operator or possible loss of data. **When you see this note, STOP and read the note before proceeding!**

On the back cover is the Operator's Quick Reference Guide, listing all control and escape commands for the terminal.

Emulation commands are given in the Operator's Quick Reference Guide. The descriptive text of the manual will **only reference the 925 commands.**

1.3 DESCRIPTION OF TERMINAL

A brief overview of the capabilities of your terminal will help you take advantage of its features as you use it. The Model 925 operates in Block or Conversational modes (HDX, FDX). Baud rates can be set at any of 15 speeds, from 50 to 19,200 bps.

Depending on switch settings, the 925 will emulate TeleVideo's 912 and 920 terminals. Character sets can be changed to English, Spanish, German, or French. Visual attributes can be set a line at a time, or a page at a time, either alone or in combination. You can set the display to monitor the computer program (to facilitate program debugging).

Printing is easily controlled with a special PRINT key. Using the FUNCT key with any alpha or numeric key allows you to quickly transmit the key selected bracketed by SOH and a CR. To create custom applications, you can easily substitute a ROM with twice as much space. The keyboard is a Selectric style which includes a ten-key pad and 22 function keys for easy data entry.

1.4 PROTECT YOURSELF!

When you install or test the terminal, observe standard safety precautions (as you would with any electrical or electronic equipment). Only qualified service personnel should open the terminal housing. Disconnect all power before performing any inspection or maintenance.



Beyond the normal precautions, you should be aware of two additional conditions:

1. If the CRT tube should be broken, always wear heavy rubber gloves or use tongs to pick up the broken CRT fragments since the coating on the inside of the tube is poisonous.

2. Even after the power is turned off, charges are retained by the CRT and capacitors. Always discharge them to ground before touching them. Never reach into the terminal enclosure unless someone capable of giving aid is present.

1.5 PROTECT THE TERMINAL

Although the terminal is packaged in a durable housing, you can help protect it by observing two simple precautions:

1. Take care to keep foreign objects such as paper clips or liquids off the keyboard.
2. Use the terminal on a secure surface and don't drop the terminal or drop heavy objects onto it.

2. INSTALLATION

2.1 INTRODUCTION

This chapter will tell you how to unpack and check your terminal for damage, check power and site requirements, and set the power and interface configurations. A brief checklist at the end will make sure you did not skip any part of the installation process.

Once your terminal is installed, you will be ready to operate the terminal and you will probably not need to use this chapter again unless you need to move the terminal, reshipe it, or use it with another computer system.

As you start the installation, you will want to have some information about your computer system and its configuration requirements.

2.2 UNPACKING AND INSPECTING THE TERMINAL

2.2.1 Shipping Damage Inspection

After the terminal is delivered to you, inspect the shipping container as well as the terminal (inside and out) for damage before taking it to your installation site. You should inspect the container for obvious damage before accepting delivery of the terminal. If damage is found, note it on the waybill and require the delivery agent to sign the waybill. Notify the transfer company immediately and submit a damage report to the carrier, your dealer, and to TeleVideo. If no exterior damage is found, unpack the terminal and inspect it for hidden damage.

2.2.2 Unpacking the Terminal

Carefully unpack the terminal from the shipping container. Avoid using sharp instruments to open the container. Save the packing material for possible use in reshipping the terminal.

2.2.3 Inspecting the Terminal

After you unpack the terminal, inspect it thoroughly for hidden damage and loose components or fittings. The inspection checklist is as follows:

1. Remove the terminal cover by removing the screws underneath the front bottom and the rear of the terminal. Lift up the cover carefully.
2. Inspect the keyboard and display cabinet interior for shipping damage.
3. Examine cable harnesses for stress, loose or broken wires, or broken cable ties.
4. Examine all internally mounted components for loose or missing hardware.
5. Tighten all loose hardware.
6. Clean loose debris from the cabinet interior.
7. Replace the cover. Do not overtighten the screws.

2.2.4 Reporting Damage

If hidden damage is found, immediately notify the transfer company of the damage. Save all packing materials for the transfer company's inspection, file a damage report with the carrier, and notify your dealer and TeleVideo of the damage. Since terms of sale for the terminal are FOB TeleVideo, Sunnyvale, California, TeleVideo is not responsible for any damage which occurred during shipment and will not repair this damage under warranty. All repairs for shipping damage are billable. Prompt notification of damage will ensure claim validity and expedite payment for necessary repairs by the transfer company or its insurance agent.

2.2.5 Reshipping the Terminal

Should you need to reshipe the terminal, follow these procedures:

1. Remove the two screws on the bottom front and bottom rear of the terminal and lift off the cover.
2. Check the integrity of the cabling and security of internal mounting hardware.
3. Replace cover, being careful not to overtighten the screws.
4. Repack the terminal in the original TeleVideo shipping container or other suitable materials.
5. Put the RMA number on the outside of the box.

2.3 PREPARING THE SITE

Before you proceed with the actual installation, make sure you are ready with the proper power and a large enough table.

2.3.1 Power Requirements

- 115 VAC 60 Hertz at 0.5 amp
OR
230 VAC 50 Hertz at 0.25 amp
- 55 watts
- NEMA standard 5-15R, 3-prong receptacle (US only)

2.3.2 Physical Requirements

- Flat, level area: 13¼" H X 16⅛" W X 20⅛" D
33.66 cm H X 40.96 cm W X
50.96 cm D
- Surface dimension: 13½" H X 16⅛" W X 20⅛" D
33.66 cm H X 40.96 cm W X
50.96 cm D
Refer to Figure 2-1
- Recommended ventilation clearance is 4 inches (10.2 cm) on all sides.

2.4 INSTALLATION

The actual installation and set-up consists of only three steps:

1. Configuring the terminal for either 115 or 230 VAC operation.
2. Configuring and connecting the terminal to the computer and printer connectors.
3. Setting up the terminal's operating switches and jumper options.

These procedures should only be performed by technically qualified personnel.

2.4.1 Power Configuration

Depending on your location, the terminal can be configured to operate with either 115 VAC (United States) or 230 VAC (international).

2.4.1.1 115 VAC Configuration

Keep the three-prong plug which is provided with the terminal and make sure your outlet is grounded. If an adapter is used, ground with a pigtail.

2.4.1.2 230 VAC Configuration

If you are located outside the United States and use 230 VAC power, cut off the US-style three-prong plug provided and install a connector compatible with your local power receptacles. The power cord wires are color coded as follows:

- Green Earth ground
- Black Primary power (hot)
- White Primary power return (neutral)

2.4.1.3 Setting Power Select Switch

Set the power select switch on the bottom of the terminal to either 115V or 230V. You will set Hertz to match your power frequency when you set S2.

2.4.2 Connecting the Terminal to Your Computer System

You can connect the terminal directly to your computer system or use a modem. Table 2-1 points out pin connections which are always used for either the computer connection or to a modem.

Interfacing Connections—The interface connection to the computer system (main) port is P3, located on the rear of the terminal. The connector configuration of P3 is given in Table 2-1.

**TABLE 2-1
P3 (COMPUTER INTERFACE)
CONNECTOR**

PIN No.	SIGNAL NAME
1	Frame Ground
2	Transmit Data Output
3	Receive Data Input
4	Request To Send Output
5	Clear To Send Input
6	Data Set Ready Input (opt.)
7	Signal Ground
8	Carrier Detect Input
20	Data Terminal Ready Output
9	20 mA source (+ 12V, no load)
14	20 mA source (+ 12V, no load)
10	Detected current loop data
25	Current Loop +, Transmit
13	Current Loop -, Transmit
12	Current Loop +, Receive
24	Current Loop -, Receive

(Reference EIA Standard RS232 for Signal Definitions)

**TABLE 2-2
SERIAL PRINTER INTERFACE (P4)
PIN CONNECTIONS**

PIN No.	SIGNAL NAME
1	Protect Ground
2	Receive Data
3	Transmit Data
4	Request To Send
5	Clear To Send
6	Data Set Ready
7	Signal Ground
8	Data Carrier Detect
20	Data Terminal Ready

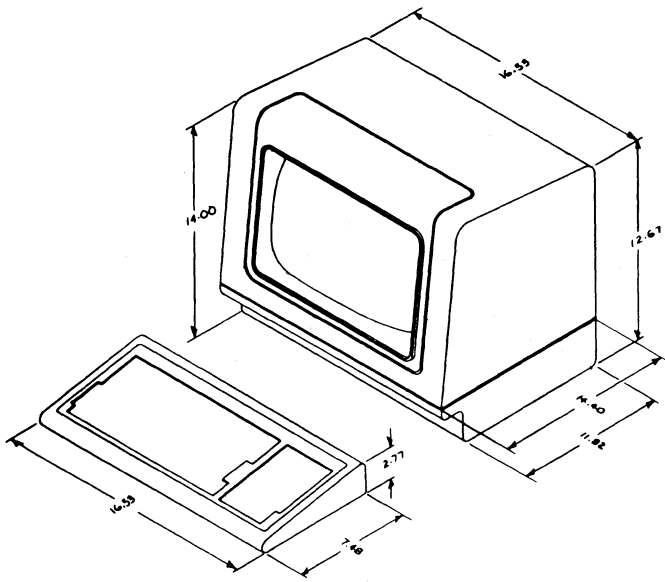

Figure 2-1 Model 925 Dimensions

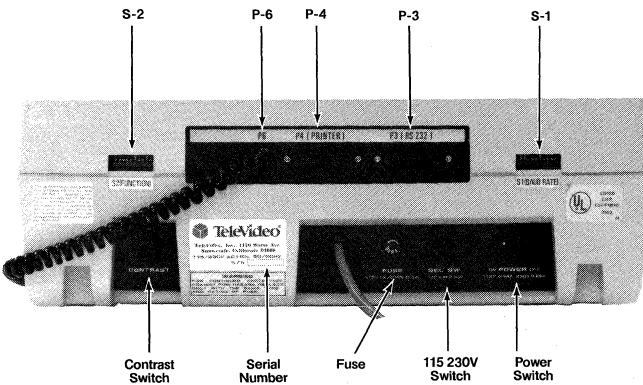

Figure 2-2 925 Rear Panel

**TABLE 2-3
EXTERNAL SWITCH SETTINGS FOR
MODEL 925**

Switch	Position				Baud Rate Setting
	7	8	9	10	
S1	1	2	3	4	[Printer] [Main RS232]
	D	D	D	D	9600
	D	D	D	U	50
	D	D	U	D	75
	D	D	U	U	110
	D	U	D	D	135
	D	U	D	U	150
	D	U	U	D	300
	D	U	U	U	600
	U	D	D	D	1200
	U	D	D	U	1800
	U	D	U	D	2400
	U	D	U	U	3600
	U	U	D	D	4800
U	U	D	U	7200	
U	U	U	D	9600	
U	U	U	U	19200	

Legend: U = Up
D = Down

NOTES

1. Set to match powerline frequency to avoid screen flicker.

Toggle Setting				
Switch	Position	Up	Down	Description
S1	5	X		7-bit word
			X	8-bit word
	6	X		2 stop bits
			X	1 stop bit
S2	1	X		Local Edit
			X	Duplex Edit (transmit editing keys)
	2	X		912/920 emulation
			X	925
	3		X	
		4		X
	5			X
		3		X
	4			X
		5	X	
3			X	
	4	X		Even Parity
5		X		
	3	X		
4			X	Mark Parity
	5	X		
3		X		
	4	X		Space Parity
5		X		

Switch	Position	Toggle Setting		Description
		Up	Down	
S2	6	X		White on Black
			X	Black on White
	7		X	Half Duplex
			X	
	8		X	Full Duplex
			X	
	7	X		Block Mode
			X	
	8	X		50 Hz ¹
			X	
9		X	60 Hz ¹	
		X		
10	X		CR/LF (Auto LF)	
		X	CR only	

TABLE 2-4
S3 INTERNAL SWITCH SETTINGS

Dipswitch Number	Position		Description
	UP	DN	
1	X		Keyclick Off
		X	Keyclick On
2		X	English
	3		X
2			X
	3	X	
2		X	
	3		X
2		X	
	3	X	
4			X
	5		X
4			X
	5	X	
4		X	
	5		X
4		X	
	5	X	
6		X	
			X
7	X		Page Attributes
			X
8	X		DCD Disconnected
			X
9	X		DSR Disconnected
			X
10	X		DTR Disconnected
			X

2.4.3 Interfacing to a Printer

Your terminal can be connected to an auxiliary serial printer to make a permanent hard copy of data displayed on the screen. The terminal's serial printer interface allows the terminal to be used with most RS232-compatible serial printers currently available on the market, including both character-by-character and buffered printers. The serial printer interface is a 25-pin connector, P4, located on the rear of the terminal. Table 2-2 defines the printer interface pin connections.

S1 and S2 are accessible from the rear of the terminal. [S3 internal switch is only accessible by removing the four cabinet screws (see 2.2.3) and removing the cover.]

2.4.4 Configuring the Terminal for the Computer and Printer

Several switches, located at the rear and internally (see Figure 2-2), allow you to configure the terminal to operate according to the requirements of your computer system and printer. This section lists all possible switch settings (in table form).



Whenever you change any switches, reset the terminal by turning the power off and then back on or pressing SHIFT/BREAK/BREAK keys to allow the software to scan all of the new switch positions.

Setting the switches as shown in Tables 2-3 and 2-4 allows you to preset the terminal to operate in any of several optional conditions:

Baud Rates

You can select any of 15 baud rates according to the requirements of your computer system.

Character Sets

You can select English, French, German, or Spanish character sets. Refer to Table 2-4.

Hertz

You can set the Hertz switch to match your powerline frequency.

Parity Stop Bits Word Structure

You can set the parity, number of stop bits, and number of data bits in the word structure to match the requirements of your computer system.

Signals

You can connect/disconnect Data Set Ready, Data Carrier Detect, and Data Terminal Ready. (See Table 2-4.)

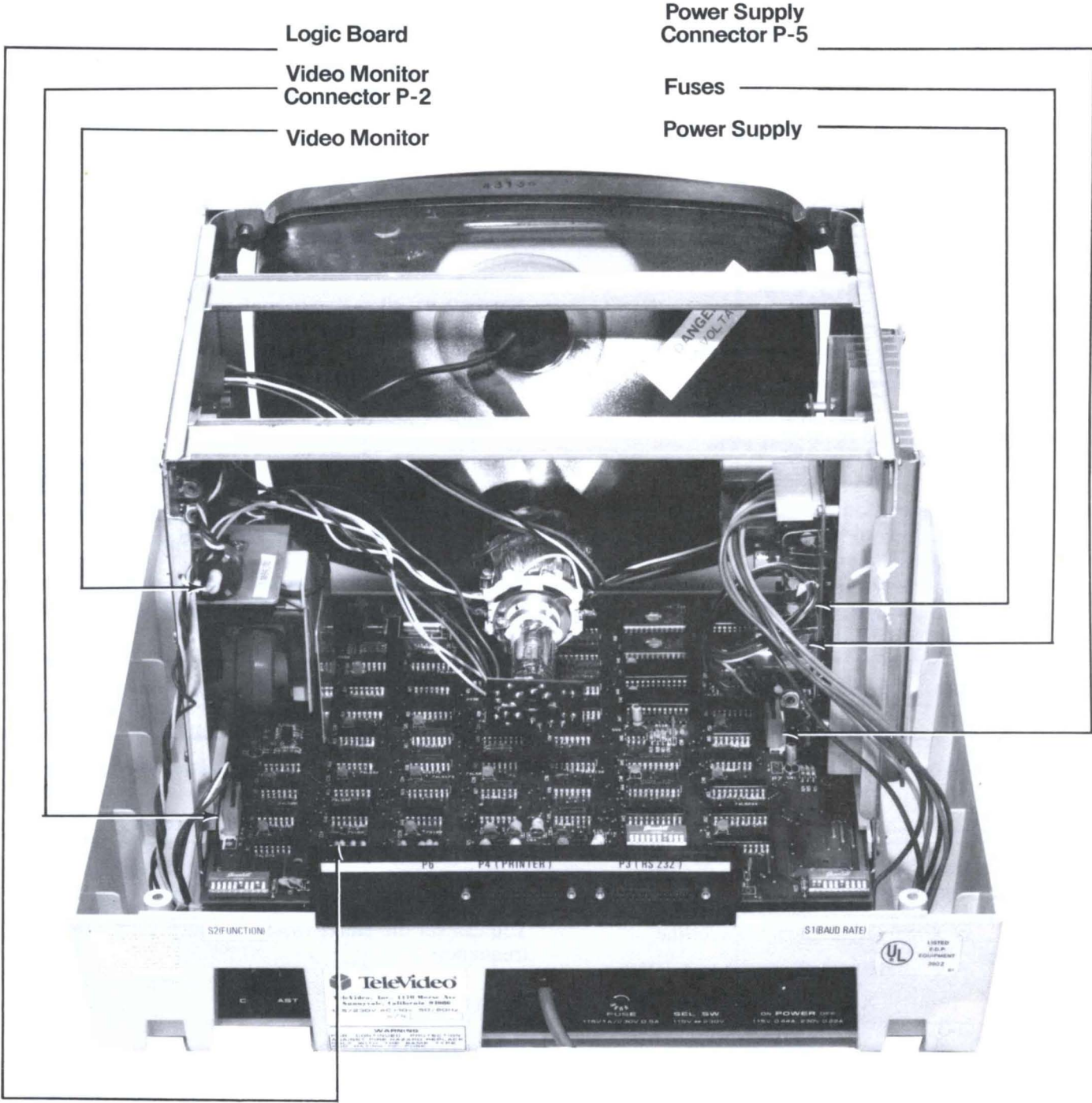

Logic Board

Power Supply
Connector P-5

Video Monitor
Connector P-2

Fuses

Video Monitor

Power Supply

Figure 2-3 Terminal Interior

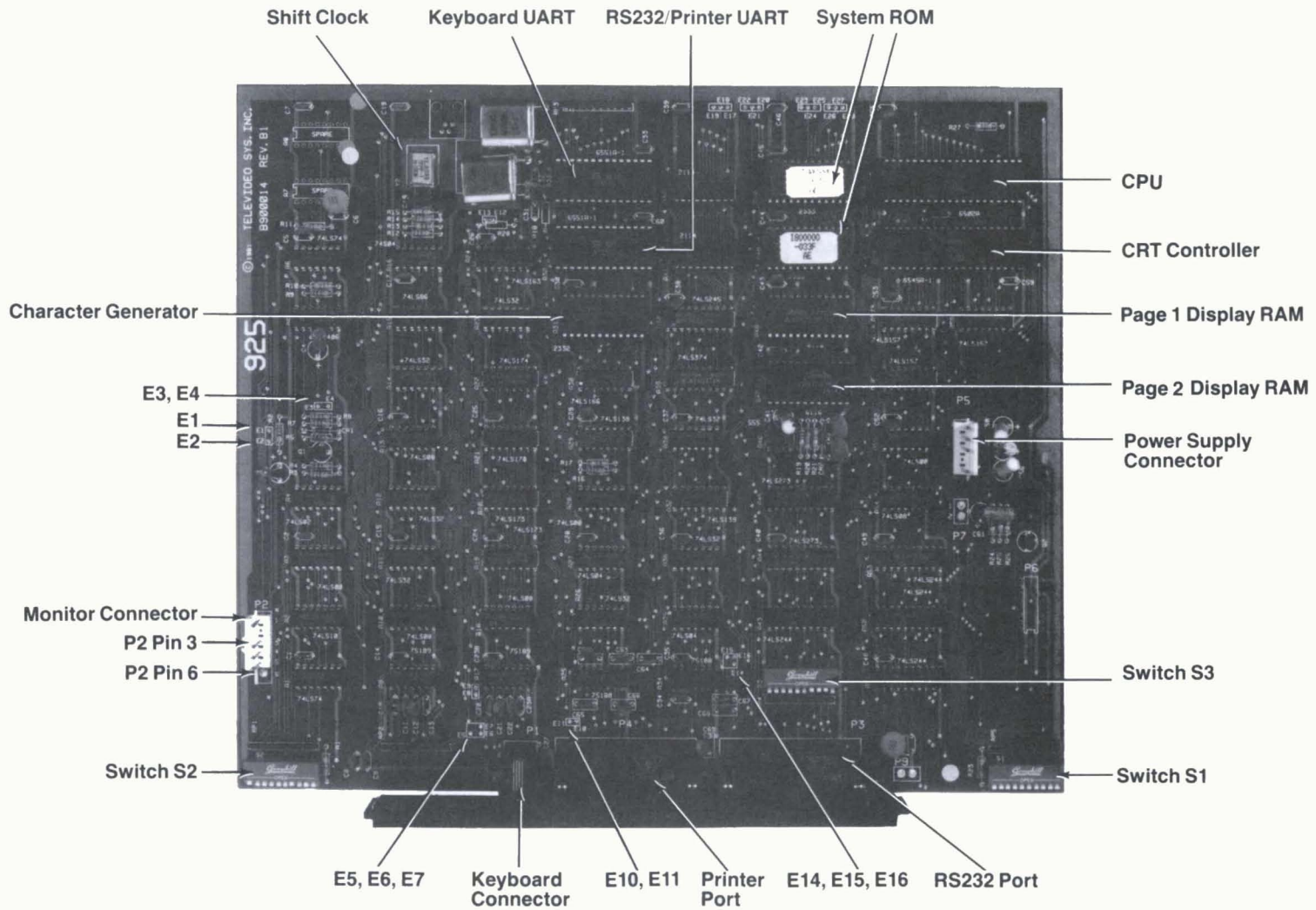

Figure 2-4a Logic Board (Part No. -001)

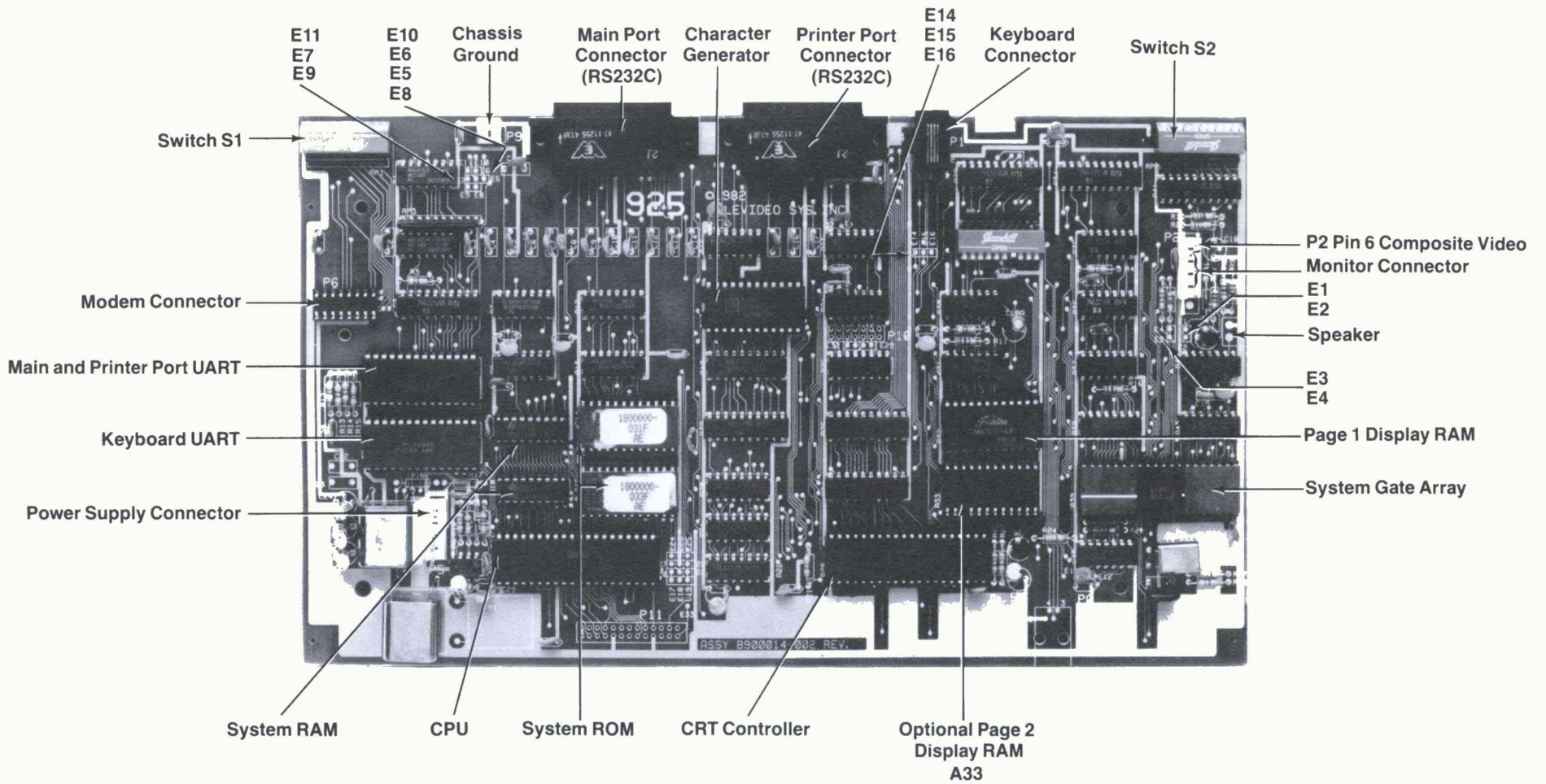
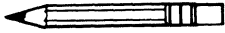

Figure 2-4b Logic Board (Part No. -002)

2.4.4.1 Character Sets

The 925 has four possible character sets, controlled by S3. The standard set is English. To select another character set, refer to Table 2-4.



Character sets are resident in the character generator. You must reprogram the terminal system ROM for the particular keyboard layout desired.

2.4.4.2 Video Display

You can set the display of the terminal to be green on black or black on green, with a steady or blinking cursor which is either an underline or a block.

2.4.5 Composite Video Jumper Option

To drive a monitor in addition to the terminal monitor, you can modify the 925 logic board. The logic board's part number may be labeled -001 (Figure 2-4a) or -002 (Figure 2-4b). The modification instructions for the composite video jumper are the same, regardless of the logic board designation.

The modifications needed are as follows:

1. Add a BNC connector to the back panel.
2. Connect the center lead to P2 pin 6; connect the ground lead of the BNC connector to P2 pin 3.
3. Cut the trace between E3 and E4 and install a jumper between E1 and E2.

2.4.6 Two-Page Memory Option

You can add one additional page of display memory to the 925. This is not normally factory-installed. Follow these steps to install this option:

1. Unplug the terminal and remove the top cover.
2. Install a 6116 2KX8 bit 150 NS RAM chip onto the control board. If the logic board is labeled -001, install the chip in position A48. If the board is labeled -002, install it in position A33.

The notch on the chip should face the same direction as the notches on the other chips. Be careful not to bend the pins.

3. Check the notch position again before installing the cover and turning on power again.

2.4.7 Additional Field Modifications

The following field modifications may also be made. The directions given in this section apply to boards labeled -001 or -002.

1. For handshaking, use pin 4 (on P4) rather than pin 11 on P4. Cut the trace between E6 and E7 and install a jumper from E5 to E7.

2. To disconnect DTR from the printer (pin 20 on P4), cut the trace between E10 and E11.
3. To control DTR output (pin 20 on P3) with RTS output (pin 4 on P3), cut the trace between E15 and E16 and install a jumper between E14 and E16.

2.5 CHECKING YOUR INSTALLATION

Before you proceed to the next chapter and turn on the terminal, check to be sure you installed the terminal correctly.

1. Did you install the correct power plug for your wall outlet?
2. Did you set the power selector switch to match your power requirements?
3. Is the main interface cable to the computer system properly wired and plugged in?
4. If you are using a printer, did you plug in the printer interface connector?
5. Did you set the switches for the correct
 - baud rate (both for terminal and printer)?
 - stop bits?
 - word structure?
 - parity?
6. Did you set switches for
 - 50 or 60 Hertz (to match your powerline/frequency requirements)?
 - full or half duplex?
7. Did you plug the terminal in to the wall outlet?

If the answers are YES, then you are ready to proceed with actually using the terminal.

3. OPERATION

3.1 INTRODUCTION

This chapter will lead you step-by-step through the operation of the terminal. Even if you have never used a computer terminal before, you will be able to use the terminal easily if you read this chapter carefully. If you are a programmer, you will want to continue on to Chapter 4, which covers additional information for programming a computer to interface with your terminal.

During this chapter you will learn about:

- Turning on and adjusting the terminal's display screen
- Using the various keys on the keyboard
- Directing data to the computer system and the printer through send commands.
- Setting tabs
- Changing visual attributes of the screen
- Communicating with your computer system

3.2 TURNING ON THE TERMINAL

3.2.1 Rear Controls

Several controls are located at the rear of the terminal (see Figure 2-2)

- Baud rate switches (S1)
- Function switches (S2)
- Internal Switch (S3)

Set these prior to turning on power to the terminal (as explained in 2.4.4, and keep a permanent record on page iv of how you have set the switches.

The connectors to the main interface and printer ports are also located here.

Once these have been set during installation, they will seldom need to be changed unless the terminal is being used with several different computer systems.

3.2.2 Turning On the Terminal

Turn on the terminal as follows:

1. Make sure the ON/OFF switch at the back of the terminal (Figure 2-2) is OFF.
2. Plug the terminal cord into a grounded outlet (115 VAC in United States).
3. Push the end of the rocker power switch marked with a white dot. The terminal should beep within one second, indicating that power is on and the CPU has initialized the terminal. After another 10 to 15 seconds, the cursor should appear in the upper left corner of the screen (HOME).

4. If the cursor does not appear at the HOME position, press the HOME key on the keyboard. If the cursor still does not appear, check the contrast control at the rear of the terminal (Figure 2-2).
5. Adjust the contrast control for the desired screen intensity.
6. Adjust the tilt of the screen by unscrewing the leg in the center front.
7. Follow the sign-on protocol required by your computer system.
8. See Chapter 6, Troubleshooting and Repair, for help if the installation does not proceed smoothly.

3.3 KEYBOARD CONTROLS

In addition to standard alphanumeric typewriter keys, your terminal has several keys which perform special operations. These special keys can be used in conjunction with your computer to allow:

- Modifying action of other keys
- Editing
- Entering preprogrammed data

Each key on the keyboard is actually a switch. Sometimes two keys can be used together to provide a totally different message to the computer (CTRL or SHIFT). When used together, these keys control the generation of data sent to the computer system and the receipt and printing of information.

3.3.1 Keyboard Layout

Figure 3-1 illustrates the keyboard layout. Refer to Table 3-1, where each key's function is described in detail. This table is subdivided by types of functions and gives information on the effect of each key and commands. For detailed information, refer to Table 3-1.

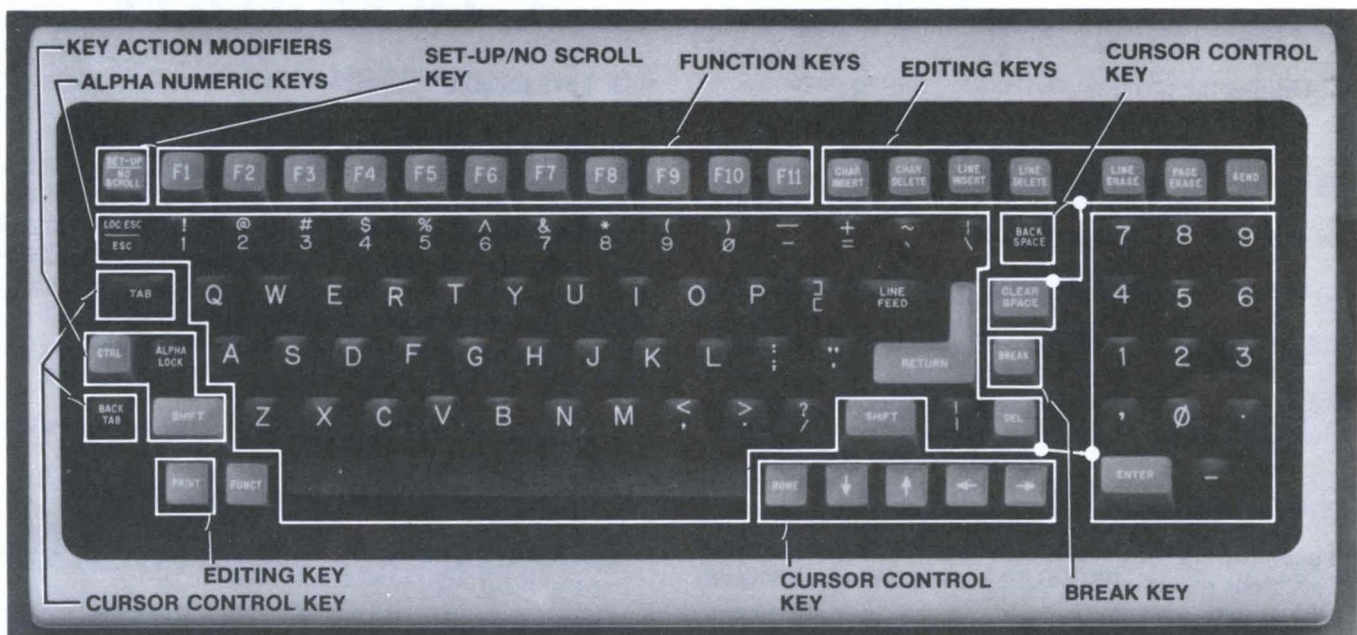

Figure 3-1 Model 925 Keyboard Layout

**TABLE 3-1
FUNCTION OF KEYS**

Key Name	Transmitted? (Yes/No)	Repeat Action? (Yes/No)	Description
Space Bar	Y	Y	Causes a blank space to appear on the display and transmits an ASCII space code (20 Hex).
SHIFT	N	N	Selects upper character inscribed on a key, changes operation of most special keys, and capitalizes alpha characters.
ALPHA LOCK	N	N	Locks the SHIFT keys so that all alpha keys transmit codes for upper-case characters. The key is pressed to lock and pressed again to release.
TAB	Y	Y	(CTRL/I)—TAB moves the cursor forward to typewriter tabs (Protect mode off) or to the start of the next unprotected field (Protect mode on).
BACK TAB	Y	Y	(ESC I)—Moves cursor backward to typewriter tabs (Protect mode off) or to the previous start of an unprotected field (Protect mode on).
CTRL (Control)	N	N	<p>Generates normally-nondisplayed ASCII control codes (32) when used in conjunction with another key.</p> <p>The control key combinations are used for special action by the terminal and/or the application program in the computer.</p> <p align="center">☼</p> <p>The Control key is always used simultaneously with the other character in the command; i.e., the control key is pressed first and held down while the other key is pressed. (It is similar in action to the SHIFT key.) The commands which require simultaneous depression of two keys are indicated by a slash separating the two key names.</p>
ESC (Escape)	Y	N	<p>The Escape key sends an ASCII code for Escape to the display processor. The key is generally used to momentarily leave (escape) an application program in order to use a special feature or function.</p> <p>Another function of the Escape key causes the next control character entered to be displayed on the screen. This facilitates putting control characters on the screen instead of going into Monitor mode.</p> <p>LOC ESC—When pressed in combination with SHIFT, the ESC key operates only locally to invoke the terminal functions and special features of the 925. It causes the next character entered to be interpreted as a command.</p> <p align="center">☼</p> <p>The Escape key is used in conjunction with one alphanumeric character in the command sequence; i.e., the Escape key is pressed and released before the second key is pressed.</p>

**TABLE 3-1
FUNCTION OF KEYS**

Key Name	Transmitted? (Yes/No)	Repeat Action? (Yes/No)	Description
RETURN/ ENTER	Y	N	<p>(CTRL/M)—The RETURN and ENTER keys perform the same function. They send the ASCII code (0D) for a carriage return (CR) to the display or computer. Depending on the communication mode used, the code causes the terminal to transmit a CR to the computer and/or the cursor to be moved to the first unprotected position.</p> <p>If the entire current line is protected, the code moves the cursor to the next unprotected position on the page.</p> <p align="center">☼</p> <p>The 925 features an auto wraparound function which eliminates the need to manually enter a carriage return and a linefeed at the end of each 80-character line.</p>
HOME	Y/N	N	(CTRL/Λ)—Moves cursor to first unprotected character position on the page [usually Column One of Row (Line) One].
LINEFEED	Y	Y	(CTRL/J)—The LINEFEED key sends an ASCII code (0AH) for a linefeed (LF) to the computer. The code causes the terminal to transmit an LF code to the computer and the cursor to be moved down one line on the screen in half duplex, or echoed by the computer in full duplex.
BACKSPACE ←	Y/N	Y	(CTRL/H)—Moves cursor one character to the left.
↑	Y/N	Y	(CTRL/K)—Moves cursor up one line.
↓	Y/N	Y	(CTRL/V)—Moves cursor down one line. If the cursor is on the bottom line of the screen, the display will roll up one line. If the cursor is on the bottom line of the page, the code has no effect.
→	Y/N	Y	(CTRL/L)—Moves cursor one character to the right.
DEL (Delete)	Y	Y	The DEL key sends an ASCII DEL character to the computer portion of the 925. The computer echoes the code back to the 925 to be performed. This is usually interpreted by the 925 as a character erase code.
BREAK	Y	N	Transmits a 250-millisecond ASCII Break pulse to the computer.
Clear Space	Y/N	Y	Replaces all unprotected characters on the page with spaces. When pressed the same time as SHIFT (ESC *), it clears the entire page to nulls and turns off Protect and Half Intensity modes.
Print Key See Section 4.12 for print functions.	Y/N	N	PRINT causes all data on a page from the home position to the cursor position to be output through the printer port. The data is output with a CR, LF, and null automatically inserted at the end of each 80-character line. When Print is pressed at the same time as SHIFT, the time of day followed by a CR LF and data will be transmitted out the (P4) printer port.

**TABLE 3-1
FUNCTION OF KEYS**

Key Name	Transmitted? (Yes/No)	Repeat Action? (Yes/No)	Description
			<p>Although escape sequences appear here with a space before the alphanumeric character, this space is <i>not</i> to be entered as part of the sequence. It is included only for the sake of clarity.</p>
Send Key	Y/N	N	<p>Data may be sent to a computer from the 925 by several methods. When SEND is pressed, the terminal transmits all data on the page from home through the cursor position. When SEND is pressed the same time as SHIFT, the terminal transmits all data on the present line from the first column through the cursor position.</p> <p align="center">☼</p> <p>See Section 4.10 for send routines.</p>
“FUNCT” Key	Y	N	<p>The FUNCT key transmits a user-selected character bracketed by CTRL/A (01H) and Carriage Return (CR).</p> <p align="center">☼</p> <p>See Section 4.4 for FUNCT key.</p>
F1-F11 Function Keys	Y	N	<p>The function keys, F1 through F11, in conjunction with SHIFT key provide 22 special keys that, when pressed, transmit a 3-code sequence to your computer. When received by your computer this sequence may initiate a special form or subroutine in the program that causes the 925 to display or perform a particular function.</p> <p align="center">☼</p> <p>See Section 4.3 for function keys.</p>
Set-Up/ No Scroll	Y/N	N	<p>The No Scroll key stops screen updating during normal operation. When pressed, the 925 stops updating the screen.</p> <p>When pressed again, the 925 starts updating the screen.</p> <p>If the receive buffer fills up while update is disabled, X-Off will be sent to the computer, causing it to stop sending data. When update is reenabled, the buffer will empty, causing X-On to be sent and data to be transmitted to the computer. During normal operation, the No-Scroll function of the Set-Up/No Scroll key is active.</p> <p>The Set-Up key manually displays and changes the 925's operating characteristics. The set-up function is enabled by pressing Shift and Set-Up/No Scroll at the same time.</p>
Character Insert	Y/N	Y	<p>The Character Insert key (ESC Q) enters a space at the cursor position, causing all succeeding characters to shift one position to the right. All characters shifted past the 80th character will be lost.</p>

**TABLE 3-1
FUNCTION OF KEYS**

Key Name	Transmitted? (Yes/No)	Repeat Action? (Yes/No)	Description
Character Delete	Y/N	Y	The Character Delete key (ESC W) deletes the character at the cursor position and causes all succeeding characters to shift one position to the left. All characters shifted to the cursor position will be deleted.
Line Insert/ Delete	Y/N	Y	The Line Insert (ESC E) key creates an entire line of space characters on the cursor line. The data on the cursor line and all following lines shift down one line (the last line on the page is lost). The Line Delete (ESC R) causes the entire line at the cursor position to be deleted. All following lines shift up one line.
Line Erase & Page Erase	Y/N	N	Line Erase (ESC T) and Page Erase (ESC Y) replace the unprotected data (from the cursor to the end of the line or page) with a space of the proper intensity. When these keys are pressed at the same time as SHIFT, they cause a line erase to null (ESC t) or a page erase to null (ESC y).

3.3.2 Other Controls

3.3.2.1 Cursor

The lighted rectangular block which appears on the screen indicates the entry spot for the following characters to be typed. It is called a "cursor." During typing, the cursor moves from left to right. As it reaches the end of a line, it "wraps around" to the beginning of the next line. If you place the cursor over a character which you have already typed, the character within the cursor will be changed into a reverse image within the cursor. (If the characters have been green on a black background, the cursor will appear as a green rectangle around a black character.)

The movement of the cursor is easy to control. To move the cursor, press one of the cursor control keys marked with an arrow. The cursor will move in the direction of the arrow until you release the key. To return the cursor quickly to the top left position on the screen, press HOME. The cursor will now be in Column One, Line One.



The cursor display may appear any one of five ways. See Chapter 4.

3.3.2.2 Cursor Addressing

The Model 925 may address the cursor to any location on the screen through a special ESC code. The cursor may also be addressed to any page row or column the operator wants to address.

3.3.2.3 Bell

The terminal can sound a short, loud bell upon your command. To sound the bell, press down CTRL and G at the same time.



From now on, you will not be told to press CTRL and the other character at the same time. The command will be shown as CTRL/G instead.

3.3.2.4 Break

You can transmit a 250-millisecond break pulse (a break signal) to your computer system. The effect will depend on the operating program in your computer system. Usually it stops communication.

3.4 BASIC OPERATIONS

This section describes various options available to you as you use the terminal:

- Setting up the terminal
- Editing data
- Tab controls
- Emulating TeleVideo 912 and 920 terminals
- Communicating with your computer system
- Printing

**TABLE 3-2
Status Line Fields**

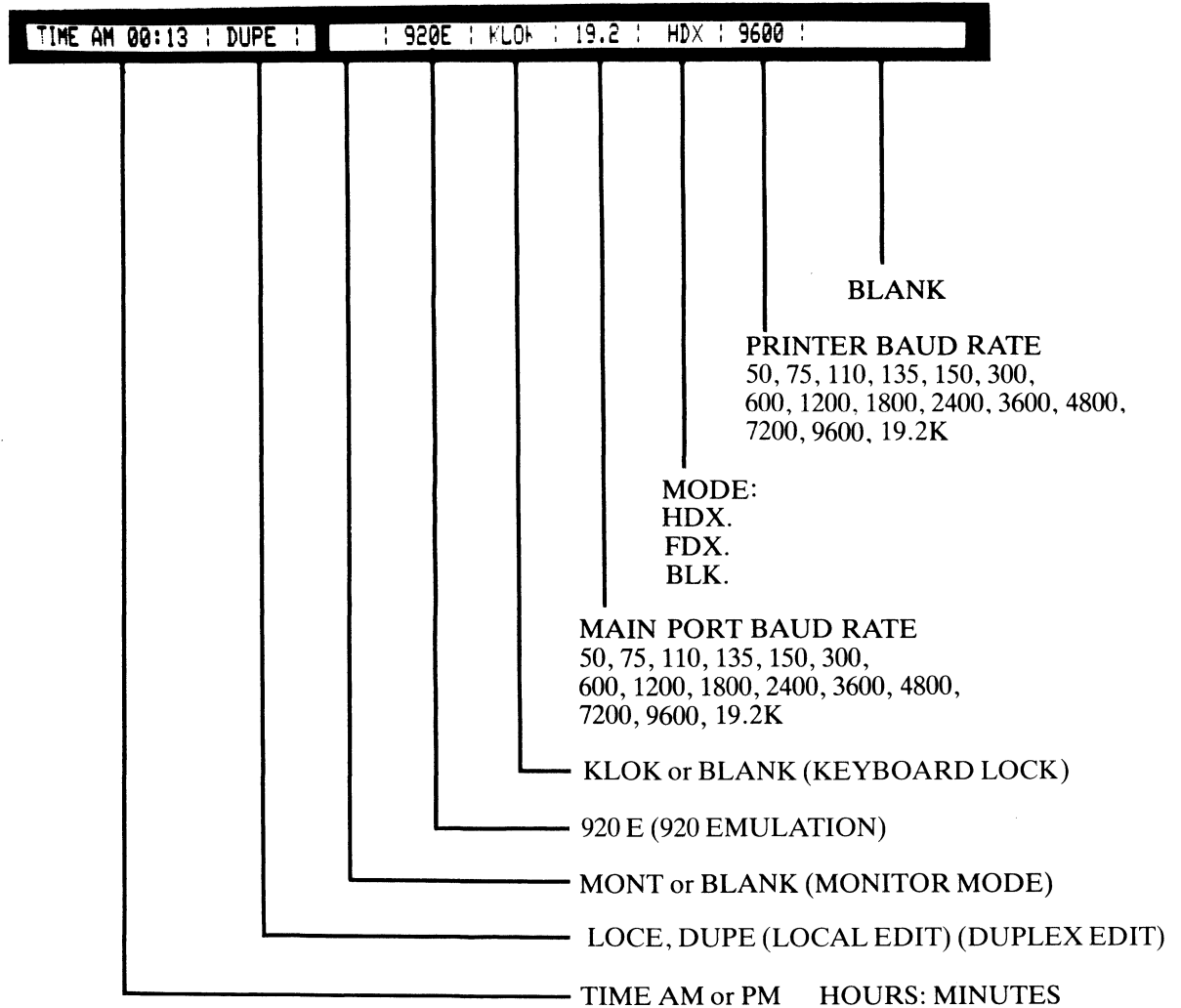

3.4.1 925 Status Line and Setup Mode

The 925 has a status line which is only displayed during setup mode. To display the status line and enter setup mode, press the SHIFT key and the Set-Up/No Scroll key simultaneously. This sequence will display the status line on the 25th line of the screen as shown in Figure 3-2.

You may change fields on the status line by moving the cursor to the right using the cursor right (→) key, or to the left using the cursor left (←) key to the field to be changed.

When the cursor is in the field you wish to change, press the "T" key to toggle the field to the mode desired. Field descriptions are shown in Table 3-2.



The only field that cannot be changed during setup mode is the first field, which is the time of day.

3.4.2 Editing

Should you need to change text on the screen, you can delete a line (either partially or completely) or the whole display (either partially or completely). This will give you space to enter the correct data. Deletions will start with the column position under the cursor. The commands for editing are found in Chapter 4. The 925, in addition to the above, can modify screen data using character insert/delete and line insert/delete. Both of these take place starting at the cursor position.

3.4.3 Tab Controls

You can set regular typewriter-style tabs on your terminal. Pressing the TAB key causes the cursor to stop whenever it reaches that column position, regardless of which line the cursor was on when the tab was set. Characters can be superimposed on the tab position.

TELEVIDEO PRODUCTS

MODEL	DESCRIPTION	LIST PRICE
910	CONVERSATIONAL	XXXX.XX
912C	SMART	XXXX.XX
920C	SMART	XXXX.XX
925	VERY SMART	XXXX.XX
950	SUPER SMART	XXXX.XX

FOR MORE INFORMATION
CONTACT

TELEVIDEO SYSTEMS INC.
1170 MORSE AVENUE
SUNNYVALE, CA. 94086
PHONE # 408-745-7760
TWX # 910-338-7633

TELEVIDEO SYS INC. SHIPMENTS

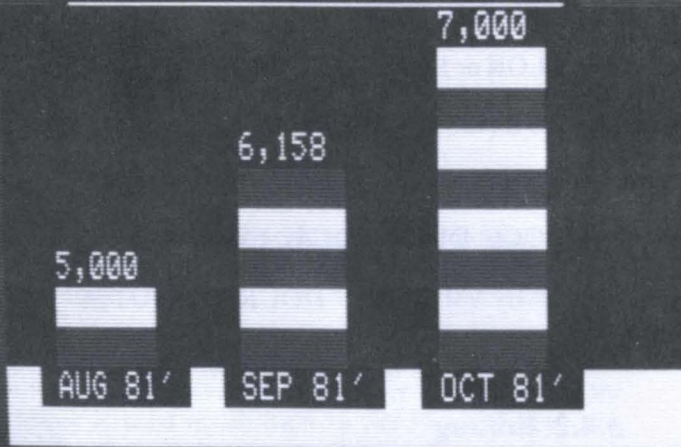

UNITS INSTALLED !

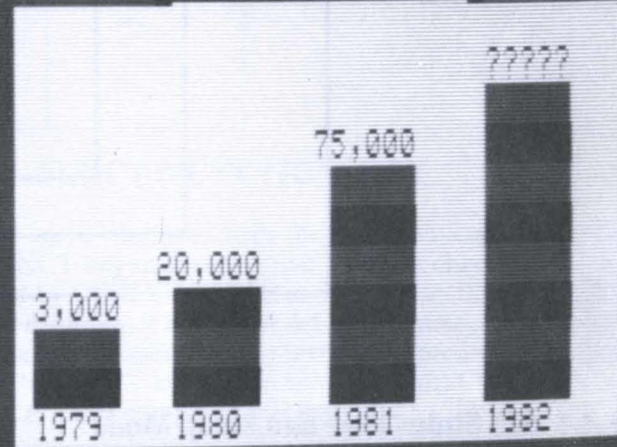

TIME AM 00:05 | LOCE | | | | 4800 | HDX | 9600 |

Figure 3-2 Model 925 Screen Display

3.4.4 Emulations

The 925 has the capability of emulating the TeleVideo 912 and 920 terminals. To set the 925 to the 920 emulation mode, refer to Table 2-3, Switch Settings. All control codes for this emulation can be found in Chapter 4.

3.4.5 Transmission Modes

You may set the 925 to one of three transmission modes by entering the setup mode or setting the switches. See Figure 3-3.

1. Block
2. Conversation
 - a. Half Duplex (HDX)
 - b. Full Duplex (FDX)

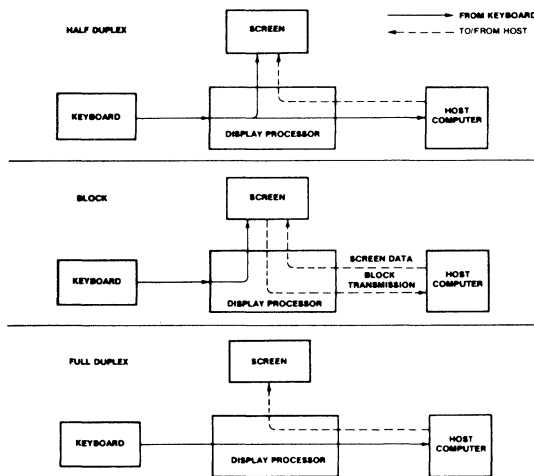

Figure 3-3 Communication Modes

3.4.5.1 Conversation Mode

In this mode, two-way transmission occurs continuously between the screen and the computer. To enter Conversation mode, enter ESC C. The 925 is conversational in either half or full duplex.

3.4.5.1.1 Half Duplex Mode

The Half Duplex mode sends keyboard entries to the screen and to the computer at the same time.

3.4.5.1.2 Full Duplex Mode

The Full Duplex mode sends keyboard entries to the computer only. If the computer is programmed to act upon a code received from a keyboard entry, it may echo the result back to the 925. (The time needed to echo back the information is so short it will seem to happen simultaneously!) For example, if the "A" is pressed on the keyboard, the computer will probably send the "A" back to the 925's screen.

What the computer sends back to the screen (if anything) and the action it takes on data, text, or command sequences sent to it depends on the application program in use. Refer to the application program's user documentation for complete information.

3.4.5.2 Block Mode

Operating in the Block Mode generally consists of entering or changing text locally. In this mode, the terminal sends the results to the screen. When you are satisfied with the results of the data entry or change, you can press SEND (or use a send data control sequence) to send the data to the computer. Block mode allows you to make all corrections before transmission.

To enter Block Mode, enter ESC B or change it on the status line.

If the terminal is set in Block Mode on S2 and a ESC C is received or typed the terminal will revert to Full Duplex operation.

3.4.6 Sending Data to the Printer

The 925 will send a page of data from the screen to an auxiliary printer when PRINT is pressed. SHIFT/PRINT sends the time of day followed by CRLF and data to the printer (see Chapter 4). Printing can also be controlled by the applications program.

4. PROGRAMMING

4.1 INTRODUCTION

Your computer program can completely control your 925 terminal by transferring the appropriate ASCII codes. This chapter tells you how to translate keyboard functions into remote control functions.

Unless otherwise specified in the text, all control code sequences are transmitted to the 925 to elicit the response associated with the code.

4.2 MONITOR MODE

The Model 925 provides a Monitor mode for displaying all characters received from the computer or entered on the keyboard, including escape and control sequences (refer to Table 4-1). The escape and control sequences on the screen will provide visual cues in long program routines. To control the Monitor mode, use the following code sequences:

Monitor Mode ON ESC U
Monitor Mode OFF ESC u or ESC X

Using monitor mode will make program debugging easier.

TABLE 4-1 MONITOR MODE

CODE	ASCII	HEX	SCREEN CHARACTER
^@	NULL	00	none
^A	SOH	01	S H
^B	STX	02	S X
^C	ETX	03	E X
^D	EDT	04	E T
^E	ENQ	05	E Q
^F	ACK	06	A K
^G	BEL	07	B L
^H	BS	08	B S
^I	HT	09	H T
^J	LF	0A	L F
^K	VT	0B	V T
^L	FF	0C	F F
^M	CR	0D	C R
^N	SO	0E	S O
^O	SI	0F	S I
^P	DLE	10	D L
^Q	DC1	11	D 1
^R	DC2	12	D 2
^S	DC3	13	D 3
^T	DC4	14	D 4
^U	NAK	15	N K
^V	SYN	16	S Y
^W	ETB	17	E B
^X	CAN	18	C N
^Y	EM	19	E M
^Z	SUB	1A	S B
ESC	ESC	1B	E C
^\ ^J	FS GS	1C 1D	F S G S
^^ ^_ DEL	RS US DEL	1E 1F 7F	R S U S ⊠

4.3 FUNCTION KEYS

The Model 925 has the ability to transmit special function codes to your computer. This is possible through the eleven function keys located on the keyboard (Figure 3-1).

Operation of these keys (F1 through F11) causes the following three-code sequence to be transmitted. When the shift key is used in addition to the function keys, the following three code sequence is transmitted.

Key	Unshifted Code	Shifted Code
F1	CTRL/A @ CR	CTRL/A ` CR
F2	CTRL/A A CR	CTRL/A a CR
F3	CTRL/A B CR	CTRL/A b CR
F4	CTRL/A C CR	CTRL/A c CR
F5	CTRL/A D CR	CTRL/A d CR
F6	CTRL/A E CR	CTRL/A e CR
F7	CTRL/A F CR	CTRL/A f CR
F8	CTRL/A G CR	CTRL/A g CR
F9	CTRL/A H CR	CTRL/A h CR
F10	CTRL/A I CR	CTRL/A i CR
F11	CTRL/A J CR	CTRL/A j CR

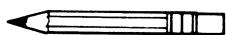

To change the default value of the function keys, the system ROM of the 925 must be replaced with a modified 2732 EPROM.

4.4 FUNCT (FUNCTION) KEY

Not to be confused with the Function keys (4.3), the FUNCT key transmits a user-selected character bracketed by Control A (SOH) and a Carriage Return (CR). For example, if a Control A C CR sequence is required for a special operation in a text editing program, pressing FUNCT and C at the same time transmits CONTROL A C CR to the computer automatically.

4.5 ADDRESSING AND READING THE CURSOR

4.5.1 Addressing the Cursor

The computer can tell the terminal where to position the cursor with a four-character escape sequence. (See Table 4-2) This is called "loading" the cursor.

To load the cursor on a 925 with two pages of memory installed, enter

ESC-PRC

where

- P = 0 for page 1; 1 for page 2
- R = the desired row (line)
- C = the desired column (character)

Use Table 4-2 to find the ASCII code representing the desired row and column. Find the appropriate ASCII code corresponding to the desired column position (1 through 80 possible) and enter that code.

To load the cursor with one page of memory (standard), enter

ESC = rc
 where r = desired row/line
 c = desired character

For example, if you want to program the cursor to go to Row 9, column 50, enter

ESC = (Q

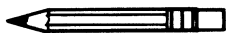

If your computer inserts nulls between characters, loading the cursor will not function as described; instead the cursor will go to an unpredictable position.

4.5.2 Reading the Cursor

The computer can also "read" the cursor's page, row, and column position. To read the cursor's position, enter

ESC ?

To read the cursor position with more than one page of memory installed, enter

ESC /

This causes the computer to read the cursor's current page (if additional page is installed), row, and column position. Row and column are read as specified in the cursor addressing table, followed by a carriage return.

4.6 VIDEO ATTRIBUTES

The 925 screen attributes (see Figure 4-2) may be controlled to provide reverse video, half intensity, underline, blink, and blank. The attribute characters are normally displayed as a space on the screen. They also appear as a half-intensity space on a black-on-green background. The attributes are implemented with an ESC G sequence followed by a parameter. For the video attributes, enter the following codes in the exact sequence shown below:

Normal (green on black) video	ESC G0
Blank	ESC G1
Blink	ESC G2
Invisible blink	ESC G3
Reverse (black on green)	ESC G4
Invisible reverse	ESC G5
Reverse blink	ESC G6
Invisible reverse blink	ESC G7
Underline	ESC G8
Invisible underline	ESC G9
Underline blink	ESC G:
Invisible underline blank	ESC G;
Underline reverse	ESC G<
Invisible underline reverse	ESC G=
Underline reverse blink	ESC G>
Invisible underline reverse blink	ESC G?
Half Intensity On	ESC)
Half Intensity Off	ESC (

TABLE 4-2 MODEL 925 CURSOR ADDRESSING CODES

POSITION R or C*	ASCII CODE Transmitted	POSITION C	ASCII CODE Transmitted	POSITION C	ASCII CODE Transmitted
1	Space	33	@	65	`
2	!	34	A	66	a
3	"	35	B	67	b
4	#	36	C	68	c
5	\$	37	D	69	d
6	%	38	E	70	e
7	&	39	F	71	f
8	'	40	G	72	g
9	(41	H	73	h
10)	42	I	74	i
11	*	43	J	75	j
12	+	44	K	76	k
13	,	45	L	77	l
14	-	46	M	78	m
15	.	47	N	79	n
16	/	48	O	80	o
17	0	49	P	81	p
18	1	50	Q	82	q
19	2	51	R	83	r
20	3	52	S	84	s
21	4	53	T	85	t
22	5	54	U	86	u
23	6	55	V	87	v
24	7	56	W	88	w
25	8	57	X	89	x
26	9	58	Y	90	y
27	:	59	Z	91	z
28	;	60	[92	{
29	<	61	\	93	
30	=	62]	94	}
31	>	63	^	95	~
32	?	64	_	96	DEL/RUB

*Value of R can't be greater than 24.

Figure 4-2 Model 925 Video Attributes

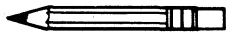
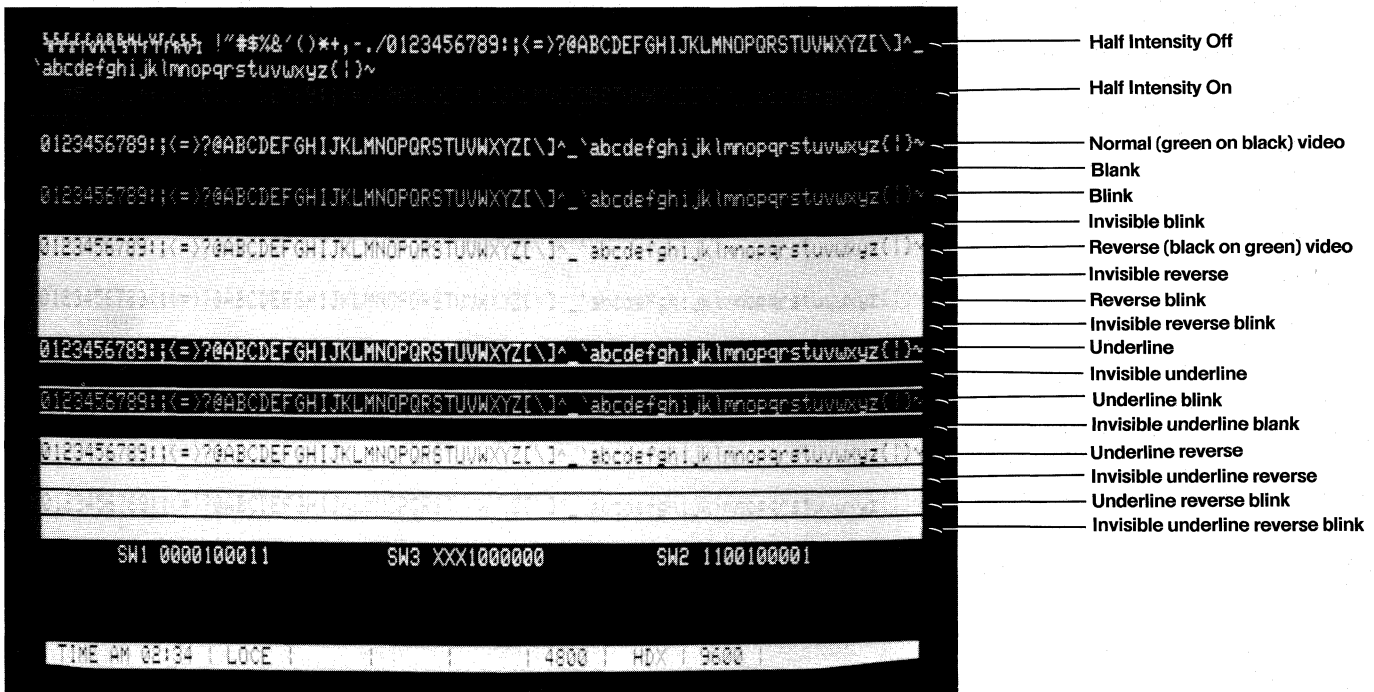

When used in combination with Protect mode, all half intensity fields will denote a protected field. Half intensity fields do not take up a character space on the screen.



When the 925 is in the 912/920 emulation mode, all video attributes will respond to those used by the 912/920 terminal; see 925 Quick Reference Guide (inside back cover).

The entire screen of the 925 may be reversed from a black on green screen to a green on black screen, or from green on black to a black on green with a one-code sequence. To reverse the screen, enter

ESC b (black on green)

ESC d (green on black)



Using one of the above codes does not take up a character space on the screen.

4.7 TABS

4.7.1 Setting Tabs (ESC 1)

When the Protect mode is on, the ESC 1 code generates a vertical column of half intensity spaces from the cursor position down to the first write-protected character or to the end of the page, whichever is first.

When the Protect mode is off, the code sets a typewriter-style column tab.

4.7.2 Using Tabs

4.7.2.1 Typewrite Tab (Protect and Unprotect) (CTRL/I)

When the Protect mode is off, the code causes the cursor to advance through the next typewriter-style tab set. If no tabs are set, the code has no effect and the cursor will not move.

When the Protect mode is set, the cursor is moved to the first unprotected character following the next protected field.

4.7.2.2 Field Tab (Protect only) (ESC i)

With the Protect mode set, the cursor moves exactly as described for CTRL/I, above.

With the Protect mode off, this code has no effect.

4.7.2.3 Back Tab (ESC I)

When the Protect mode is off, the code causes the cursor to back to the previous tab position set. If no tabs are set or if the cursor is on the first tab position, Back Tab moves the cursor to the first column on the line.

If the Protect mode is on, Back Tab moves the cursor back to the start of the first preceding unprotected field. If no preceding positions exist, the cursor will not move.

If the cursor is at the first unprotected position on the page, the code has no effect. If no protected fields exist, Home position is considered the start of an unprotected field.

4.7.3 Clearing Tabs

4.7.3.1 Typewriter Tabs (ESC 2)

Clears the typewriter tab at the cursor column. The code has no effect when the Protect mode is set.

4.7.3.2 All Tabs (ESC 3)

Clears all tabs.

4.8 PROTECT MODE

4.8.1 Application

Using Protect mode during the creation of a page allows you to protect designated areas of the page from future change by the operator and control its transmission. A typical application would be the creation of a form, leaving blank spaces for later entry of variable information. Where the form headings not protected by Protect mode, they would be vulnerable to change or accidental deletion as the form was being filled in.

4.8.2 Effect

Protected areas appear on the screen at half the regular intensity. The cursor is not able to enter a field which has been protected, but will instead advance across that area to the first unprotected field when entering arrow right or left. Arrow up, down, linefeed, or reverse linefeed may, however, move the cursor to the protected field. If the whole screen is protected the cursor will go to the HOME position and will not move.

Protect mode affects cursor action during tabulating, editing, sending, and printing.

4.8.3 Procedure

Using Protect mode is actually a two step process: input and protection.

4.8.3.1 Input

Individual areas (fields) which will be given blanket protection from later change are created using Protected Writing.

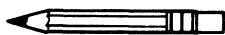

Information must be input using this procedure if it is to be protected later.

- a. To start Protected Writing, position the cursor where the first protected character is to be located.

- b. Enter

ESC)

This turns on the Write Protect mode (also called Half Intensity). Until the mode is reset, each character entered is displayed at half intensity.

- c. Enter the information for that area of the screen.

- d. Proofread the entry and change if necessary.

- e. End data entry in that area by entering

ESC (

This turns off the Protected Writing mode

- f. Move the cursor to the next area to be protected and repeat.

4.8.3.2 Protection

When all areas to be protected have been entered correctly, the whole screen is ready to be protected from change (Protect ON). Once this protection is given, the cursor will not be able to enter those areas unless the protection is removed.

To start Protect mode, enter

ESC &

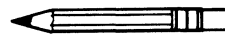

The position of the cursor is irrelevant during this escape sequence.

This turns on the Protect mode. Protect mode causes half-intensity and attribute characters to be protected from overwriting or erasure. All visual attributes within protected areas are protected.

To remove Protect mode (Protect OFF), enter

ESC'

All characters entered are displayed at full intensity.

4.9 EDITING CONTROL

The editing control sequences and a description of their functions follow:



Use of the Model 925 editing commands may result in the loss of data. Read the following explanations of the editing control functions carefully.

4.9.1.1 Set Local Edit Mode (ESC k)

Sets the edit keys (CHAR INSERT, CHAR DELETE, LINE ERASE, PAGE ERASE, SEND, PRINT, LINE INSERT, LINE DELETE, CLEAR, BACKSPACE, ↑, ↓, ←, →, TAB, and BACK TAB) for local operation only. These keys will affect data in the terminal; no characters associated with the keys will be transmitted to the host. All other keys operate normally.

4.9.1.2 Set Duplex Edit Mode (ESCI)

Sets the edit keys (see above) to operate in the mode set for the alphanumeric keys. For example, if the terminal is set for Half-Duplex operation (refer to paragraph 3.4.5.1.1), the alphanumeric keys operate in Half Duplex mode, and the edit keys operate in Half Duplex mode.

4.9.2 Cursor Control

The cursor control key operation is described in paragraph 3.3.3. Escape and Control sequences may be sent from the host to perform the various cursor functions.

4.9.2.1 Cursor Control Codes

The cursor control code sequences and a description of the functions follows:

- Cursor up (CTRL/K)—Moves the cursor up one line until it encounters the top of the screen. If the cursor is not on the first line of the page, the display will roll down one line each time until the cursor reaches the top of the page. Once it reaches the top of the page, further receipt of the code has no effect.
- Cursor down (CTRL/V)—Moves the cursor down one line. If the cursor is on the bottom line of the screen, the display will roll up one line. If the cursor is on the bottom line of the page, the code has no effect.
- Cursor left (CTRL/H)—Same as BACKSPACE. Moves the cursor left to the next unprotected position on the page. If the cursor is currently in the first column of the line, it will move to the last column of the preceding line or to that line. If Auto Page is off and the cursor is currently at the Home position or the first unprotected position on the page, the code has no effect.
- If Auto Page is on and the cursor is at the Home position or the first unprotected position on the page, the cursor will move to the end of the preceding page or to the last position of the last unprotected field of the preceding page. If the current page is page 0, the code has no effect.
- Cursor right (CTRL/L)—Moves the cursor right one column; if at column 80, it moves the cursor to the first column of the next line. With Auto Page off and the Protect mode off, it will cause a scroll if the cursor is at column 80 of the last line. With Auto Page on and the cursor at the last unprotected position on the page, the cursor will advance to the first unprotected position of the next page. If the page is the last, the cursor will advance to Home of the first page. With Auto Page off, the Protect mode on, and the cursor at the last unprotected position on the page, the cursor will move to the first unprotected position of the current page.

- Carriage return (CTRL/M)—Moves the cursor left to column 1 of the current line.
- Cursor Home (CTRL/^)—Moves the cursor to the first unprotected character on the page.
- New line (CTRL/_)—Causes the terminal to perform a carriage return and a linefeed.

4.9.2.2 Normal and Reverse Linefeed

The linefeed control code sequences and a description of their functions follow:



Linefeeds received by the Model 925 under certain conditions may result in the loss of data. Read the following control code explanations carefully!

- Linefeed (CTRL/J or LINEFEED)—With Auto Page and the Protect mode off, a linefeed advances the cursor to the next line on the page. If the cursor is at the bottom of the screen, linefeeds cause the display to roll up one line for each linefeed. If the cursor is also at the bottom of the page, a linefeed causes a new line of data to appear at the bottom of the screen and results in the loss of the top line of data on the page. The new line contains spaces. Shifted ↓ causes a linefeed.

With the Protect mode off or on and Auto Page on, linefeed advances the cursor to the next line on the page. When it reaches the bottom of the page, it advances to the first line of the next page. When it reaches the last line of the last page, it advances to the first line of page 0.

With the Protect mode on and Auto Page off, the cursor advances to the top of the current page when it reaches the bottom of the page.

- Reverse linefeed (ESC j)—Moves the cursor up one line for each reverse linefeed received. If the Protect mode is on and Auto Page is off, the cursor stops when it reaches the top line of the page. If Auto Page is on and the Protect mode is on or off, the cursor moves to the last line of the previous page when it reaches the first line of the current page. If the cursor is at line 1 of page 0, it will not move.

If the Protect mode and Auto Page are off, the screen will scroll down one line when the cursor reaches the top line of the screen. If the cursor is also at the top of the page, the page will scroll down one line, causing a new line of data to appear at line 1 of the screen and deleting the last line of the current page. Shift ↑ causes a reverse linefeed.

4.9.2.3 Editing Commands

- **Character Insert (ESC Q)**—Causes the character at the cursor to move right one column and enters a space character at the cursor position. The character at column 80 is lost. If the Protect mode is on, this control will insert from the cursor position to the end of the line or to the first protected field.
- **Character Delete (ESC W)**—Deletes the character at the cursor position and moves all following characters left one position. At the end of the delete function, a space character is written into the last position on the line. If Protect mode is on, character delete operates only from the cursor position to the end of the unprotected field or line.
- **Line Insert (ESC E)**—With the Protect mode off, inserts a line consisting of fill characters at the cursor position. This causes the cursor to move to the start of the new line and all following lines to move down one line, resulting in the loss of the last line on the page. If the Protect mode is on, a line insert command has no effect.
- **Line Delete (ESC R)**—When Protect mode is off, deletes the line at the cursor position, and all following lines move up one line. Also causes the cursor to move to column 1 of the line and fill characters to load into the last line of the page. Has no effect when Protect mode is on.
- **Erase to End of Line (ESC T)**—Erases all unprotected characters from the cursor to the end of the line (or field, if in the Protect mode) and replaces them with fill characters. If Half Intensity is on, fill characters in half intensity will replace the erased characters.
- **Erase to End of Line with Nulls (ESC t)**—Erases all characters from the cursor position to the end of the line or the end of an unprotected field and replaces them with null characters. If Half Intensity is on, the erased characters are replaced with half-intensity null characters.
- **Erase to End of Page (ESC Y)**—Replaces unprotected characters from the cursor position to the end of the page with spaces. If Half Intensity is on, erased characters will be replaced with half-intensity spaces.
- **Erase to End of Page with Nulls (ESC y)**—Erases all unprotected characters from the cursor position to the end of the page and replaces them with null characters. If Half Intensity is on, erased characters are replaced with half-intensity null characters.

4.9.2.4 Clear Function

The Model 925 clear function is used in one of four ways to clear data from screen memory and/or computer memory. The clear function escape codes and a description of their functions follow:

- **Clear unprotected to nulls (ESC :)**—Clears all unprotected data on the page to the null character (or half-intensity nulls if set).
- **Clear unprotected to insert character (ESC ; or ESC + or CTRL/Z)**—Clears all unprotected data on the page to the insert character. The insert character is a space by default. If Half Intensity (H.I.) is set, the screen will be cleared to half-intensity insert characters.
- **Clear page to half-intensity spaces (ESC,)**—Clears all unprotected data on the page to half-intensity spaces.
- **Clear all data to nulls (ESC *)**—Clears all data on the page to nulls and resets the Half Intensity and Protect modes.

4.10 SEND FUNCTION

Once data or text has been entered and edited, it may be transmitted to the computer by either pressing SEND or by entering a control sequence to send specific data. To send the computer specific data, type the code in the exact sequence shown in the following send descriptions.

4.10.1 Send Line Unprotected (ESC 4)

Sends all unprotected data on a line from column 1 through the cursor position. The code also sends field delimiters in place of protected fields and an end-of-text character at the end of the send transmission.

4.10.2 Send Page Unprotected (ESC 5)

Sends all the unprotected data on page from Home through the cursor position. It sends field delimiters in place of protected fields. The code also sends a line delimiter at the end of a line and an end-of-text character at the end of the send transmission.

4.10.3 Send Line All (ESC 6)

Sends all data from the first column through the cursor position. It also sends the start-protected field and end-protected field delimiters at the start and end, respectively, of each protected field. If the character at the cursor position is protected, the 925 sends an end-protected field to the computer. The code sends the end-of-text character at the end of the send transmission.



If the data to be sent includes attribute characters, these will be sent too (the 925 will automatically include the suitable escape sequences).

This also applies to any attribute characters encountered on the screen.

4.10.4 Send Page All (ESC 7)

Sends all data on the page from Home through the cursor position. It also sends the start-protected field delimiters at the start and end, respectively, of each protected field. If the character at the cursor position is protected, the 925 sends an end-protected field delimiter to the computer. This code also sends the end-of-text character at the end of the send transmission.

4.10.5 Send Message Unprotected (ESC S)

Sends all unprotected data bracketed by the state of text (STX) and end of text (ETX) codes displayed on a page. After the data is sent, the 925 positions the cursor at the ETX code. If the page contains no STX codes, transmission begins from Home. If the page contains no ETX code, the 925 sends to the end of the page and positions the cursor at Home after the data is sent. If the page contains neither an STX nor an ETX code, the entire page will be sent. The code sends field delimiters in place of protected fields. It also sends line delimiters at the end of each line and an end-of-text delimiter at the end of the send transmission.

4.10.6 Send Message All (ESC s)

Operates in the same manner as ESC S, except that protected fields delimited by start-protected field and end-protected field are also transmitted.

4.11 TERMINATION CHARACTER SELECTION

At the completion of each send sequence, a Carriage Return (CR) is sent to the computer. This termination character may be changed to any ASCII code. To change the termination character, enter

ESC x 4NN

where NN = any two ASCII characters

Example: To change the termination character to a ETX enter

CTRL/@ (NULL) CTRL/C (ETX)

For NN, two characters must be entered. Use a NULL (CTRL/A) as a filter code.

- Line Terminator—at the end of each line a US (1FH) is transmitted. To change the line termination character, enter

ESC x1 NN

where NN = any two ASCII characters.

4.12 PRINT FUNCTION PROGRAMMING

The Model 925 printer port may be set for terminal page date transmittal, data transmittal from the computer or

two-way communications between a KSR-type printer and the computer. If during a print operation, the device connected to the printer port cannot accept any more data, the device may signal the terminal to stop sending data by setting P4-20 to -12 Vdc. The device may then request the transmission of more data by setting P4 20 to +12 Vdc. Refer to 2.4.7 for field modifications which affect the printer port.

The print function control sequences and their descriptions follow.

4.12.1 Page print (ESC P)

Sends page data from Home through cursor position to the printer port and advances the page number by 1. Data entry on the advanced page may continue while the previous page is printing. This print mode prints page data exactly as entered plus line delimiters (a carriage return and a linefeed) at the end of each line. Control characters are also sent to the printer port as are a carriage return and a linefeed at the end of the transmitted data. The terminal transmit an ACK to the host indicating that all print data has been output to the printer port.

4.12.2 Transparent print on (ESC `)

Sends all subsequent data received by the terminal (including control and escape characters) to output to the printer port. No screen updating occurs while the mode is active. The printer and main baud rates must be the same.

4.12.2.1 Transparent print off (ESC a)

Turns off the transparent print. The printer and main baud rates must be the same.

4.12.3 Extension (copy print) mode on (ESC @)

Causes all subsequent data received by the terminal to be sent to the screen and to the device connected to the printer port. The printer and main baud rates must be the same.

4.12.4 Extension (copy print) mode off (ESC A)

Turns off the Extension (copy print) mode. Screen updating continues normally.

4.12.5 Enable bidirectional port (CTRL/R)

Functionally connects P3 RS232C and P4 PRINTER in parallel. The function allows a device connected to the printer port [such as a keyboard send/receive (KSR) printer] to communicate directly with the computer while allowing screen update to continue.

4.12.5.1 Disable Bidirectional Port (CTRL/T)

Functionally disconnects P3 RS232C and P4 PRINTER in parallel.

4.12.6 Send Time of Day

The 925 has a built in clock which keeps track of the time of day. To transmit the time to your printer, press the PRINT key in conjunction with the SHIFT key. The time will then be transmitted to the printer followed by a CR/LF and data.

4.12.7 Printer Termination Character

The printer's termination character may be reprogrammed to any character desired. To program the termination character, use the following dialogue.

ESC pn

Example: To program a null for the termination character, type:

ESC p CTRL/@

The default printer termination character is an ACK (CTRL/F).

4.13 X-ON/X-OFF CONTROL

The Model 925 automatically transmits X-OFF to the computer, requesting it to stop sending data when the terminal's receive buffer is almost full (less than 16 characters). When the data in the buffers are processed (output to the screen or to the printer buffer), the Model 925 automatically transmits X-ON to the computer, indicating that the computer may resume sending data to the terminal. The X-ON/X-OFF feature may be enabled or disabled with the following control sequences:

Enable X-ON/X-OFF CTRL O
and disable DTR Control

Disable X-ON/X-OFF CTRL N
and enable DTR Control

4.14 DTR CONTROL

The Model 925 Data Terminal Ready (DTR) line will go low whenever the 256-byte storage receive buffer fills to 240 bytes. The DTR line will go high again once the buffer is 20 per cent empty. The DTR feature may be enabled or disabled by changing the following switch setting:

S3 switch 10
UP DTR Disconnected
DOWN DTR Connected

See 2.4.7 for field modifications which control DTR output.

4.15 TIME OF DAY CLOCK

The 925 has a time of day clock. The time of day will appear only when the status line is displayed during Set-Up mode. It will appear in the first field of the Status Line as follows:

TIME A(AM) P(PM) XX(HOUR):XX(MINUTES)

To change the time, enter

ESC SPACE 1 N HH MM

where N = A(AM) or P(PM)
 HH = 2 digit number for the hour
 MM = 2 digit number for the minutes

Example:

If you wish to program 3 o'clock in the afternoon, enter

ESC SPACE (SPACE BAR) 20H) 1 P 0300

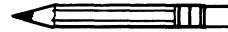

The time of day may be sent to the printer for reports; see Section 4.12.6, print functions.

The computer may request the time from the 925 by sending the following sequence:

ESC SPACE 2

The 925 will respond with a 6-character code (A or P, hour and minutes and CR).

4.16 KEYBOARD KEYCLICK

The Model 925 features an audible keyclick whenever a key on the keyboard is depressed. The keyclick may be disabled either through a switch (see Table 2-4) or software control.

Keyclick ON ESC >
Keyclick OFF ESC <

4.17 DISABLING THE KEYBOARD

You can disable all keyboard functions by remote commands from the computer. Once the keyboard is disabled, it can only be enabled once again by another remote command from the computer.



If your computer system echoes all codes, the keyboard may be accidentally disabled.

To disable the keyboard remotely, enter

ESC #

While the keyboard is disabled, all keys are disabled except FUNCT, PRINT, BREAK.

To subsequently enable it, you must receive an ESC " from the computer or type a SHIFT/BREAK BREAK (reset) from the keyboard.

4.18 SCREEN TIME OUT

The 925 has a time out device used to increase the life of the phosphor on your screen. If this feature is selected (see Table 2-4), the data displayed on the screen will turn off 15 minutes after the last keystroke entered. The 925 is normally shipped with this feature disabled. To display the screen after it has shut off, press any key.



No data will be lost as long as the terminal has not been turned off.

4.19 PAGE CONTROL

The Model 925 has the option of two 24-line pages of display memory. These pages may be incremented forward or backward, one page at a time. When the next page or previous page is called to the screen, the cursor assumes the last position previously occupied on that page. To control the paging functions, enter the following codes in the exact sequence shown below.



Do not enter the spaces between the characters; spaces are for clarity only.

Advance page	ESC K (advances to next page)
Back page	ESC J (displays previous page)
Print page and display next page	ESC P (sends current page data to the printer and displays the second page)
Auto flip on	ESC v (When the cursor is advanced past the 24th line, 80th character, the 925 will flip to the next page)
Auto flip off	ESC w (When the cursor is advanced past the 24th line, 80th character, the cursor will move to the HOME position.)

4.20 USER LINE

4.20.1 To load the User Line

Enter,
ESC f...CR

where... = data to appear in the user line up of 79 characters.

To cause your entry to be displayed, enter
ESC g

(You can enter data and display it later or you may display the blank User Line before entering data. This allows you to see the data as it is loaded.)

The cursor will not enter the User Line while you are inputting data.

4.20.2 Entering Data

You can enter up to 79 characters of text on the User Line. Press RETURN to terminate entry of the user message.

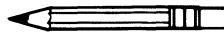

The User Line will be cleared when power is turned off or an ESC h is received.

4.21 912C/920C EMULATION

The model 925 offers a firmware emulation of the TeleVideo Models 912C and 920C.



You can put the 925 in the 912/920 emulation mode by entering the set-up mode or putting S1 dip-switch two in the down position.

The differences in codes between the 925 and 912/920 are shown in the Operator's Quick Reference Guide.

4.22 Cursor Attributes

The cursor display may appear any one of five ways. To set the cursor display, enter the control code for the desired attribute. Type the code in the exact sequence shown below (do not enter the spaces between the characters; spaces are for clarity only):

4.23 Screen Off

Attribute	Code
Not Displayed	ESC.0
Blinking Block	ESC.1
Steady Block	ESC.2
Blinking Underline	ESC.3
Steady Underline	ESC.4

To blank the entire screen, enter
ESC O

To return the screen to normal display, enter
ESC N

5. PREVENTIVE MAINTENANCE

5.1 CARE

Tender loving care will prolong the useful life of your terminal. Clean and inspect it periodically.

5.1.1 Cleaning

To clean the terminal exterior:

1. Vacuum the keyboard every three months with a soft brush attachment (or use a small soft brush).
2. Clean the housing with a soft, lint-free cloth and a commercial detergent every three months.

DO NOT use solvent-based or abrasive cleaners.

5.1.2 Inspection

Description	Frequency
1. Inspect the terminal cabinet for cracks or breaks.	1/Yr.
2. Check each key for free movement.	1/Yr.
3. Check the cable connector (at the rear of the terminal cabinet) for damage.	1/Yr.

6. TROUBLESHOOTING AND REPAIR

6.1 TROUBLESHOOTING

Your computer terminal is just one of several components in the computer system. A failure anywhere else in the system can cause the improper operation of the terminal. The computer system, memory systems, cables, modems, and operational procedures should be checked if there has been a malfunction. Table 6-1 will be helpful in determining the cause of a problem. If this table does not help locate the cause of the problem, run the self test or call a qualified service technician for assistance.

6.1.1 Testing the Terminal (Self Test)

You can test the terminal yourself to verify proper operation of the video display circuitry. The test will display all displayable characters, and all 16 video attributes—in both half and full duplex.

To start the test, enter

SHIFT/Setup 1

The display screen should now look like that in Figure 4-2. Look at the display carefully to verify that all characters appear, all video attributes appear correctly, and all half intensity characters are shown. Each character should be formed properly and you should not be able to see any extra dots (and no dots should be missing).

Check the switch settings on the terminal against those on the display (see Fig. 4-2). The display will show the dip switches as a 1 (up) or a 0 (down).

To stop the test

press **SHIFT/BREAK/BREAK**

Should your display not appear as pictured in Figure 4-2 call a qualified service technician.

6.2 REPAIR

Model 925 operator repair is limited to changing the line fuse and the two internal power supply fuses.

6.2.1 Changing the Line Fuse

To change the line fuse, proceed as follows:



To avoid electrical shock, disconnect the terminal power cord before changing the line fuse.

1. Disconnect the terminal power cord from primary power.
2. Remove the fuse holder (see Figure 2-2) by unscrewing it counterclockwise.
3. Remove the blown fuse and replace it with a 3AG, 1 amp "slo blo" 125V or 0.5 amp, 250V fuse for 220 VAC applications instantaneous (fast blow) fuse.
4. Install the fuse in the reverse order of Steps 1 through 3.

6.2.2 Changing the Power Supply Fuses

The terminal power supply fuses are installed in fuse clips on the power supply assembly inside the terminal (see Figure 2-3). To replace either of these fuses, proceed as follows:



Hazardous voltages are exposed in the cabinet. Turn off the power switch and disconnect power *before* opening the terminal cabinet.

1. Disconnect the terminal power cord from primary power.
2. Turn the terminal upside down and set it on a soft surface to prevent marring the cabinet. Remove the four Phillips screws that hold the cabinet cover on the terminal.
3. Turn the terminal right side up and lift off the cabinet cover.



Make sure there is adequate table space for the open terminal.

4. Remove the blown fuse from its fuse clip (see Figure 2-3).
5. Replace the blown fuse with a 3AG, 3 amp, 125V fuse.
6. Reinstall the terminal cover and secure it with the four screws. (Do not overtighten screws!)

**TABLE 6-1
TROUBLESHOOTING TERMINAL PROBLEMS**

Symptom	Possible Cause	Solution
Terminal dead (no beep; no cursor)	No AC power	Plug in power cord. Turn on power switch. Check 115/230 power switch setting.
Terminal dead; cursor may appear	Loose or defective line or power supply fuses	Turn terminal power off and change fuses.
Terminal will not go on line	System is not "up" Loose, unconnected, or damaged cables Modem not turned on, defective, or phone handset on modem upside down	Check status of system. Attach all cables and check for cable damage. Check main port (P3) interface cable pins: <ul style="list-style-type: none"> • 5,6, and 8 must be driven by +12 VDC or not connected at all for normal operation. See Table 2-4. • 1 and 7 must be grounded. • 3 must be connected to the host transmitter. • 2 must be connected to the host receiver. Turn on modem. Attach different modem. Check phone handset position.
Cursor will not appear	Defective contrast pot Contrast set too light	Refer to technical representative for adjustment of contrast settings.
System does not respond while on line	Incorrect parity switch setting, word structure, stop bits	Set parity switch to match system.
Terminal is not responding to settings	Terminal not powered down after being reconfigured; software has not scanned new settings.	Power down terminal and turn back on.
Terminal "locked up"	System is not responding; communication link broken Terminal incorrectly set for on line and full duplex	Set to half duplex and try to type. If terminal will type, check cables, modem, phone lines, and computer system. Set to full duplex and perform self test. Set to half duplex.
Terminal locked up	Keyboard disabled from computer Switches set incorrectly	Enter ESC" Review Chapter 2 switch settings carefully and check all switch settings.

**TABLE 6-1 Continued
TROUBLESHOOTING TERMINAL PROBLEMS**

Symptom	Possible Cause	Solution
Terminal prints correct data only part of the time	Parity settings incorrect	Check parity settings with system requirements.
	Stop bits or word structure wrong	Change switch settings.
Display is wavy	Hertz setting incorrect; does not match local power frequency	Change switch setting.
Printer does not print what is transmitted	Correct print mode selected?	Refer to 4.12.1 and 4.12.2.
	Cable connector pins connected incorrectly	Refer to Table 2-2. Check printer port (P4) interface cable connector pins: <ul style="list-style-type: none"> • 4 or 20 must be driven by +12 VDC or not connected at all for normal operation. • 3 must be connected to printer data input. Check other printer port device requirements.
Escape and control codes do not function as specified	The escape and/or control codes being used are not correct	Check model number of terminal and code table for correct model of terminal being used. Make sure upper and lower case codes are used. Is a numeral one required instead of lowercase "L"?
	Keyboard locked in SHIFT position (AUTO LOCK on)	Put in lower case. Disconnect computer system. Connect P3-2 to P3-3 and try in full duplex.
Terminal prints "garbage"	Improper baud rate setting	Set correct baud rate.
	Improper handshaking protocol	Check handshaking protocol requirements of system with terminal protocol.
	Defective modem	Replace modem
	Noisy telephone lines	Check phone lines. Install dedicated phone lines.
	Static electricity	Check operating environment for static.
	EIA and AC power cords intermingled	Separate cables. Keep EIA cable separate from power cord to prevent noise on data line.

TABLE 6-1 Continued
TROUBLESHOOTING TERMINAL PROBLEMS

Symptom	Possible Cause	Solution
Terminal prints "garbage"	AC outlet not wired properly	Check for proper wiring and grounding.
Erroneous data sent to computer Scrambled output Terminal loses memory	Static electricity AC outlet not wired properly	1. Check operating environment for static problems. 2. Install antistatic floor mat. 3. Spray carpeting with antistatic spray. 4. Increase humidity. Check for proper wiring and grounding.
Terminal does not print what is typed while on line	Duplex switch incorrectly set	Set duplex switch to match host system.
Terminal only prints @ characters	Word length switch set incorrectly Parity switch set incorrectly Stop bits set incorrectly	Set word length switch to match computer system. Set parity switch to match computer system. Set stop bit switch to match computer system.

GLOSSARY

ASCII

The acronym for American Standard Code for Information Interchange. This is a standardized code for the transmission of data within the United States. It is composed of 128 characters (upper and lowercase letters, numerals, punctuation marks, symbols, and control characters) in a 7-bit binary format.

Asynchronous Communication

A method of communication where the time synchronization of the transmission of data between the sending and receiving stations is set by start and stop bits and the baud rate.

Baud

The rate of transmission of data. One baud equals one binary bit per second.

Bit

An abbreviation for binary digit. A bit is the smallest unit of data. ASCII codes are composed of seven bits.

BREAK

To break or interrupt communications. When the BREAK switch on the terminal is toggled, a 250-millisecond tone is sent to the computer to immediately halt communications.

Buffer

An electronic device within the terminal that allows for the temporary storage of incoming data should the transmission rate of the incoming data be faster than the terminal's printing speed.

Bug

An error in a computer program or in the operation of the computer.

Byte

A coded group of binary bits which represents a character (letter, numeral, symbol, command, etc.).

Code

A method of representing data by groups of binary digits.

Command

A code that will cause the terminal or computer to perform an electronic or mechanical action.

Computer

An electronic system which, in accordance with its programming, will store the process information and perform high-speed mathematical or logical operations.

Control Codes

Special nonprinting codes which cause the terminal or computer to perform specific electronic or mechanical actions (such as setting tabs, etc.).

CPU

Central Processing Unit. The “brains” of a computer or computer terminal; that section where the logic and control functions are performed.

Default

Condition which exists from POWER ON or RESET if no instructions to the contrary are given to the terminal.

DEL

The ASCII DELETE code used in some instances to delete transmitted characters or to exit modes of operation.

Digit

One of the numerals in a number system.

Digital

Information in the form of individual parts—bits or digits.

EOT

An ASCII code that means “end of transmission” (EOT); used in the EOT/ACK handshaking protocol. The computer sends an EOT at the end of each transmission to the terminal. When the terminal is ready to receive more data, it transmits an acknowledge (ACK) back to the computer.

ESC

An ASCII code meaning “escape” which is used to control various electronic and mechanical functions of the terminal.

Full Duplex

In full duplex communication, the terminal can transmit and receive *simultaneously*. The transmitted data is not printed locally unless it is “echoed back” by the computer.

Half Duplex

In half duplex communication, the terminal transmits and receives data in separate, *consecutive operations*. Transmitted data is printed locally.

Handshaking

A communications protocol which is necessarily used when the transmitting speed of the computer is faster than the printing speed of the terminal. It consists of a set of commands, recognized by both stations, which control the flow of the data transmission from the computer.

Hardware

The electronic components of a computer system or terminal.

Host

The computer system.

Interface

A communications channel which is typically used for external devices.

Main

The computer system.

Memory

That part of a computer system or terminal where information is stored.

Microprocessor

An electronic circuit on the surface of a small silicon chip which can be programmed to perform a wide variety of functions within the computer system or terminal.

Modem

An electronic device which converts (modulates) the serial communications between the computer and terminal into audible tones which can be transmitted over telephone lines. All received data is reconverted (demodulated) from the audible tones into serial information.

NUL

An ASCII code (“nothing”) which is used as a fill character in some communications formats.

Parity

A method of checking for errors in data communications. An extra bit (either a “1” or “0”), called the parity bit, is added to the end of each ASCII character to make the final count of “1” bits in the character an even or odd number, according to a prearranged format. Some systems always use even parity, some always use odd parity, and some do not check for parity. Both terminal and system *must* be set for the same parity.

Protocol

All of the conventions which must be observed in order for the computer and terminal to communicate with each other.

Serial Communication

The standard method of ASCII character transmission where bits are sent, one at a time, in sequence. Each 7-bit ASCII character is preceded by a start bit (see Asynchronous Communication) and ended with a parity bit and stop bit.

Toggle

Activation or deactivation of function or mode key (either a receive key, command sequence, or manual keystroke).

Wraparound

Movement of the cursor as it reaches the right edge of screen, disappears, and “wraps around” to the beginning of the next line.

X-ON/X-OFF

A handshaking protocol. When the terminal's buffer is nearly full, it transmits an X-OFF to the computer to stop transmission; when the buffer is almost empty, an X-ON is transmitted to the host to resume transmission.

ASCII CODE CHART

Bits	7 6 5 4				Column	0 0 0	0 0 1	0 1 0	0 1 1	1 0 0	1 0 1	1 1 0	1 1 1
	4	3	2	1	Row	0	1	2	3	4	5	6	7
	0	0	0	0	0	NUL	DLE	SP	0	@	P	.	p
	0	0	0	1	1	SOH	DC1	!	1	A	Q	a	q
	0	0	1	0	2	STX	DC2	"	2	B	R	b	r
	0	0	1	1	3	ETX	DC3	#	3	C	S	c	s
	0	1	0	0	4	EOT	DC4	\$	4	D	T	d	t
	0	1	0	1	5	ENQ	NAK	%	5	E	U	e	u
	0	1	1	0	6	ACK	SYN	&	6	F	V	f	v
	0	1	1	1	7	BEL	ETB	'	7	G	W	g	w
	1	0	0	0	8	BS ←	CAN	(8	H	X	h	x
	1	0	0	1	9	SKIP HT	EM)	9	I	Y	i	y
	1	0	1	0	10 (a)	LF	SUB	*	:	J	Z	j	z
	1	0	1	1	11 (b)	VT ↑	ESC	+	;	K	[k	{
	1	1	0	0	12 (c)	FF →	FS	,	<	L	\	l	
	1	1	0	1	13 (d)	CR	GS	-	=	M]	m	}
	1	1	1	0	14 (e)	SO	HOME RS	.	>	N	^	n	~
	1	1	1	1	15 (f)	SI	NEW LINE US	/	?	O	_	o	DEL RUB

*ASCII Code Table
Abbreviations For Control Characters*

NUL	null	FF	form feed	CAN	cancel
SOH	start of heading	CR	carriage return	EM	end of medium
STX	start of text	SO	shift out	SUB	substitute
ETX	end of text	SI	shift in	ESC	escape
EOT	end of transmission	DLE	data link escape	FS	file separator
ENQ	enquiry	DC1	device control 1	GS	group separator
ACK	acknowledge	DC2	device control 2	RS	record separator
BEL	bell	DC3	device control 3	US	unit separator
BS	backspace	DC4	device control 4	SP	space
HT	horizontal tabulation	NAK	negative acknowledge	DEL	delete
LF	linefeed	SYN	synchronous idle		
VT	vertical tabulation	ETB	end of transmission block		

INDEX

- Addressing Cursor 4.5.1
- Alpha Lock T3-1
- Attributes Cursor 4.22
- Attributes Video 4.6
- Audible Functions 3.3.3.3
- Backspace T3-1
- Backtab T3-1, 4.7.2.3
- Bell 3.3.3.3
- Bidirect Port 4.12.5
- Block Model 3.4.5.2
- Break T-3-1, 3.3.3.4
- Buffer—see Transparent Print
- Care 5.1
- Carriage Return T3-1
- Char Del Key T3-1
- Char Insert Key T3-1
- Character Sets 2.4.4.1
- Cleaning 5.1.1
- Clear Functions 4.9.2.4
- Clear Space T3-1
- Composite Video Jumper Options 2.4.5
- Connecting terminal to computer 2.4.2
- Conversation Mode 3.4.5.1
- Copy (extension) Print 4.12.4
- CTRL T-31
- Cursor Addressing 3.3.3.2,4.5
- Cursor Attributes 4.22
- Cursor Control 3.3.3.1, 4.9.2
- Cursor Control Codes 4.9.2.1
- Cursor Down T3-1
- Cursor Home T3-1
- Cursor Left T3-1
- Cursor Reading 4.5
- Cursor Right T3-1
- Cursor Up T3-1
- DEL (delete) T3-1
- Dimensions 2.3.2
- Disabling/enabling keyboard 4.17
- DTR Control 4.14
- Duplex Edit 4.9.12
- Duplex Modes 3.4.5.1.1
- Edit Commands 4.9.2.3
- Line (see Line Edit)
- Edit Modes 4.9.1.2
- Editing 3.4.2, 4.9
- Emulations 3.4.4,4.21
- Enter T3-1
- Enabling/Disabling Keyboard 4.17
- Escape Key T3-1
- Extension Mode 4.12.3
- Field Modifications 2.4.7
- Field Tabs 4.7.2.2
- Full Duplex Mode 3.4.5.1.2
- FUNCT Key T3-1, 4.3
- Fuses, changing 6.2.1, 6.2.2
- Half Duplex Mode 3.4.5.1.1
- Half Intensity 4.8.3.1
- Home T3-1
- Inspection 2.2, 5.1.2
- Installation and Checking Ch2, 2.4, 2.5
- Key Functions Table 3-1
- Key Repeat Actions T3-1 Specifications
- Keyboard Controls 3.3
- Keyboard enable/disable 4.17
- Keyboard Layout 3.3.1
- Keyclick 4.16
- Line Delete T3-1
- Line Erase T3-1
- Line Feed T3-1
- Line Insert/Delete Key T3-1
- Manual, How to Use 1.2
- Memory option, two page 2.4.6
- Monitor Mode 4.2
- Monitor Control Characters T4-1
- Overview 1.3
- Page Control 4.19
- Page Erase T3-1
- Physical Requirements 2.3.2
- Power Configurations 2.4.1
- Power Requirements 2.3.1
- Power Select switch 2.4.1.3
- Preventative Maintenance Ch5
- Print Key T3-1
- Print Buffer (transparent) 4.12.2
- Print Copy Print (extension) 4.12.4
- Printer Interface 2.4.3
- Printer Port T2-2
- Printer Termination Character 4.12.7
- Programming Ch4
- Programming Function keys 4.3
- Programming Print function 4.12
- Programming Tabs 4.7
- Programming User Line 4.20
- Protected Mode 4.8
- Reading Cursor 4.5.2
- Rear Panel Controls Fig 2-2, 3.2.1
- Repair 6.2
- Reshipping 2.2.5
- Return Key T3-1
- Return Materials Authorization (RMA), front
- Safety Precautions 1.4
- Screen Attributes 4.6
- Screen Time Out 4.18
- Self Test 6.1.1
- Send Function 4.10
- Send Key T3-1
- Serial Number front
- Service front
- Set-up/No Scroll Key T3-1
- Set-up procedure 3.4.1
- Shift key T3-1
- Site preparation 2.3
- Space Bar T3-1
- Specifications
- Status Line 3.4.1
- Switch Settings, record of, front
- Tab Key T3-1
- Tab Controls 3.4.3
- Tab Programming 4.7
- Technical assistance, front
- Terminating Character 4.11
- Test, Self 6.1.1
- Time of Day Clock 4.12.6, 4.15
- Transmission Modes 3.4.5
- Transmission Block 3.4.5.2
- Transmission Conversation 3.4.5.1
- Transmission Full Duplex 3.4.5.1.2
- Transmission Half Duplex 3.4.5.1.1
- Transparent Print 4.12
- Troubleshooting 6.1
- Turning on Terminal 3.2
- Two-page Memory Option 2.4.6
- Typewriter Tabs 4.7.2.1
- User Line 4.20
- Ventilation Requirements 2.3.2
- Video Attributes 4.6
- Video Display 2.4.4.2
- X-on/X-off Control 4.13
- Warranty, limited iii
- Write Protect Mode 4.8.3.1

MODEL 925

OPERATOR'S QUICK REFERENCE GUIDE

FUNCTION	912C/920C	925
Bell	CTRL/G	CTRL/G
Cursor Left	CTRL/H	CTRL/H
Cursor Right	CTRL/L	CTRL/L
Cursor Down	CTRL/J	CTRL/V
Cursor Up	CTRL/K	CTRL/K
Cursor Home	CTRL/^	CTRL/^
Address Cursor Page Row Column	ESC-PRC	ESC-PRC
Address Cursor Row Column	ESC = rc	ESC = rc
Read Cursor Page Row Column	ESC/ .	ESC/
Read Cursor Row Column	ESC?	ESC?
Carriage Return	CTRL/M	CTRL/M
Linefeed	CTRL/J	CTRL/J
Newline	CTRL/_	CTRL/_
Tab	CTRL/I	CTRL/I
Back Tab	ESC I	ESC I
Back Page		ESC J
Set Column Tab	ESC 1	ESC 1
Clear Column Tab	ESC 2	ESC 2
Clear All Tabs	ESC 3	ESC 3
Field Tabs	ESC i	ESC i
Clear All to Nulls	ESC *	ESC *
Clear Unprotected to Spaces	ESC; or CTRL/Z	CTRL/Z or ESC + or /ESC;
Clear All to Half Intensity		ESC ,
Clear Unprotected to Null	ESC :	ESC :
Clear All to Space	ESC +	
Character Insert	ESC Q	ESC Q
Character Delete	ESC W	ESC W
Line Insert	ESC E	ESC E
Line Delete	ESC R	ESC R
Advance Page	ESC K	ESC K
Keyclick On		ESC >
Keyclick Off		ESC <
End of Reverse Video	ESC k	ESC G0
Reverse Video	ESC j	ESC G4
Start Blink Field	ESC ^	ESC G2
Start Blank Field	ESC _	ESC G1
End Blink/Blank	ESC q	ESC G0
Start Underline	ESC l	ESC G8
End Underline	ESC m	ESC G0
Black On Green		ESC b
Green On Black		ESC d
Erase EOL with Spaces	ESC T	ESC T
Erase EOL with Nulls	ESC t	ESC t
Erase EOP with Spaces	ESC Y	ESC Y
Erase EOP with Nulls	ESC y	ESC y
Auto Page On	ESC v	ESC v
Auto Page Off	ESC w	ESC w
Lock Keyboard	ESC #	CTRL/R
Unlock Keyboard	ESC "	CTRL/T
Protect Mode On	ESC &	CTRL/O
Protect Mode Off	ESC '	CTRL/N
Write Protect (Half Intensity) Off	ESC (ESC (
Write Protect (Half Intensity) On	ESC)	ESC)
Block Mode On	ESC B	ESC B
Conversation Mode On	ESC C	ESC C
Blank Screen		ESC O
Normal Screen		ESC N
Send Line Unprotect Only	ESC 4	ESC 4
Send Page Unprotect Only	ESC 5	ESC 5
Send Line All	ESC 6	ESC 6
Send Page All	ESC 7	ESC 7
Send Message Unprotect Only	ESC S	ESC S
Send Message All	ESC s	ESC s
Monitor Mode On		ESC U
Monitor Mode Off		ESC u or ESC X
Enable Bidirectional Printer Mode		CTRL R
Disable Bidirectional Printer Mode		CTRL T
Enable X On/Off		CTRL O
Disable X On/Off		CTRL N

FUNCTION	912C/920C	925
Extension Mode On	ESC @	ESC @
Extension Mode Off	ESC A	ESC A
Print (Page Print)	ESC P	ESC P
Transparent Print On		ESC `
Transparent Print Off		ESC a
Load User Line		ESC f [text] CR
Display User Line		ESC g
Turn Off 25th Line		ESC h
Reverse Linefeed		ESC j
Set Local Edit Mode		ESC k
Set Duplex Edit Mode		ESC l
Select Termination Character		ESC x 4 nn
Set Cursor Attribute		ESC .n
Set Print Termination Character		ESC pn
Load Time		ESC sp 1 nnnnn
Read Time		ESC sp 2

S1 (RIGHT REAR)

	1	2	3	4	5	6	7	8	9	10
	BAUD RATE	BAUD RATE	BAUD RATE	BAUD RATE	DATA BITS	STOP BITS	BAUD RATE	BAUD RATE	BAUD RATE	BAUD RATE
UP	SEE CHART				7 BIT	2 BIT	SEE CHART			
DOWN	MAIN PORT BAUD RATE				8 BIT	1 BIT	PRINTER PORT BAUD RATE			

S2 (LEFT REAR)

	1	2	3	4	5	6	7	8	9	10
	EDIT MODE	EMULATION	PARITY	PARITY	PARITY	SCREEN VIDEO	MODE	MODE	REFRESH	CARRIAGE RETURN
UP	LOCAL	912/920	SEE			WOB	SEE		60 HZ	CR/LF
DOWN	DUPLEX	925	CHART			BOW	CHART		50 HZ	CR

345 78
 DDD NO PARITY DD HDX
 DDU ODD PARITY UD FDX
 DUU EVEN PARITY DU BLK
 UDU MARK PARITY
 UUU SPACE PARITY

S3 (INTERNAL)

	1	2	3	4	5	6	7	8	9	10
	KEYCLICK	CHAR SET	CHAR SET	CURSOR ATTRIBUTE	CURSOR ATTRIBUTE	TIME OUT BLANK	ATTRIBUTE	DCD	DSR	DTR
UP	OFF	SEE				ON	PAGE	DISCONN.	DISCONN.	DISCONN.
DOWN	ON	CHART				OFF	LINE	CONN.	CONN.	CONN.

23 56
 DD ENGLISH DD BLINKING BLOCK
 DU GERMAN DU BLINKING UNDERLINE
 UD FRENCH UD STEADY BLOCK
 UU SPANISH UU STEADY UNDERLINE

S1

	7	8	9	10	
	1	2	3	4	
9600	DN	DN	DN	DN	
50	DN	DN	DN	UP	
75	DN	DN	UP	DN	
110	DN	DN	UP	UP	
135	DN	UP	DN	DN	
150	DN	UP	DN	UP	
300	DN	UP	UP	DN	
600	DN	UP	UP	UP	
1200	UP	DN	DN	DN	
1800	UP	DN	DN	UP	
2400	UP	DN	UP	DN	
3600	UP	DN	UP	UP	
4800	UP	UP	DN	DN	
7200	UP	UP	DN	UP	
9600	UP	UP	UP	DN	
19200	UP	UP	UP	UP	

 **TeleVideo Systems, Inc.**

1170 Morse Avenue • Sunnyvale, CA 94086