



# Owners Manual

---

**ROADSTER 2 / ROADSTER SPORT**

---



## **A WORD TO ROADSTER OWNERS**

Thank you for choosing a Tesla Roadster. Not only have you chosen one of the finest sports cars on the road, you have also chosen the most energy efficient sports car ever sold. You are participating in a revolution, demonstrating that kicking the oil habit does not mean you have to give up performance and driving pleasure.

Take the time to get well acquainted with your Tesla Roadster by reading this manual. The more you know and understand your vehicle, the more safety and pleasure you'll experience driving it.

Tesla Motors knows your Roadster best. So when service or maintenance is required, Tesla Motors is the place to go. Visit us regularly at [www.teslamotors.com](http://www.teslamotors.com) for more information about your Tesla Roadster. By signing into the owners area of this web site, you can access all the information you need about your specific vehicle, including service information.

Enjoy your Tesla Roadster!

Tesla Motors  
San Carlos, California, USA

---

# Table of Contents

<b>Introduction and consumer information</b>		<b>Maintenance and care</b>	
Important notes about your vehicle	1-2	Maintenance	8-2
Important notes about this manual	1-3	Fluid reservoirs	8-5
Consumer information	1-5	Windshield wiper and washer	8-7
		Cleaning and vehicle care	8-8
<b>Your vehicle at a glance</b>		<b>Roadside emergencies</b>	
Exterior	2-2	Tool kit	9-2
Interior	2-4	Energy Depletion	9-3
		Tire repair	9-4
<b>Seating and safety restraints</b>		Wheels	9-6
Seats	3-2	Fuse replacement	9-7
Seat belts	3-3	Bulb replacement	9-9
Airbag system	3-6	Raising the vehicle	9-11
		Vehicle recovery	9-13
<b>Doors, locks, and security</b>		<b>Technical specifications</b>	
Keys	4-2	Vehicle identification	10-2
Doors	4-4	Wheels and tires	10-4
Trunk	4-6	Approved fluids and capacities	10-14
Vehicle security	4-7	Vehicle dimensions and weights	10-15
		Subsystem specifications	10-17
<b>Charging your vehicle</b>			
General information about charging	5-2		
Charge settings	5-4		
Charging components	5-6		
<b>Driving your vehicle</b>			
Driving basics	6-2		
Switches and controls	6-6		
Instruments	6-11		
<b>Comfort and convenience</b>			
Power windows	7-2		
Rear view mirrors	7-3		
Interior temperature control	7-4		
Interior accessories	7-6		
Removable roof	7-8		
HomeLink®	7-14		

For information on how to use the Touch Screen and how to charge your vehicle, refer to the separate manuals provided in your owners package. For information on how to use the audio and navigation system, refer to the Original Equipment Manufacturer (OEM) documentation provided by Tesla Motors.

# Introduction & consumer information

---

<b>Important notes about your vehicle</b>	
Electric vehicle precautions	1-2
California Proposition 65	1-2
Vehicle modifications	1-2
Service data recording	1-2
Change of address or ownership	1-2
<b>Important notes about this manual</b>	
Read this manual first	1-3
Copyright and trademarks	1-3
Symbols glossary	1-4
<b>Consumer information</b>	
Reporting safety defects	1-5

# Important notes about your vehicle

## Electric vehicle precautions

 **WARNING: HIGH VOLTAGE.** The Tesla Roadster™ has both AC and DC high voltage systems in addition to a normal 12V DC system. High voltage is very dangerous and can cause personal injury including electric shock, severe burns and even fatal injury. Always observe and obey the instructions on all labels attached to components on your vehicle - they are there for your safety. Do not touch, remove or replace any high voltage parts. If your vehicle is involved in an accident, do not touch any high voltage wiring (identified by the orange outer sleeving), the connectors or the components connected to the wiring.▲

## California Proposition 65

 **WARNING:** Certain vehicle components contain or emit chemicals known to the State of California to cause cancer and birth defects or other reproductive harm. In addition, certain fluids contained in vehicles and certain products of component wear contain or emit chemicals known to the State of California to cause cancer and birth defects or other reproductive harm.▲

 **WARNING:** Certain components of this vehicle such as airbag modules and seat belt pretensioners may contain Perchlorate Material. Special handling may be required for service or vehicle end of life disposal. See <http://www.dtsc.ca.gov/hazardouswaste/perchlorate>.▲

 **WARNING:** Battery posts, terminals, and related accessories contain lead and lead compounds. Wash hands after handling.▲

## Vehicle modifications

 **WARNING:** The fitting of non-approved parts and accessories, or the implementation of non-approved modifications to any vehicle components, including any “hacking” of the vehicle’s software, may be dangerous and could affect the safety of your vehicle and its occupants and also invalidate the terms and conditions of the New Vehicle Limited Warranty.▲

 **WARNING:** Tesla Motors™ will not accept any liability for death, personal injury or damage to property which may occur as a direct or indirect result of non-approved modifications or the fitment of non-approved accessories.▲

If you have a disability which requires modification to your vehicle, consult Tesla Motors before making these modifications.

## Service data recording

Service data recorders in your vehicle are capable of collecting and storing diagnostic information about your vehicle. This potentially includes information about the performance or status of various systems and control modules in your vehicle such as motor, accelerator, or brakes. To properly diagnose and service your vehicle, Tesla

Motors and service facilities may access vehicle diagnostic information through a direct connection to your vehicle.

## Change of address or ownership

If you change your address, it is in your best interest to notify Tesla Motors so we can contact you should the need arise. Send in the “Change of Address Notice” found in the New Vehicle Limited Warranty” booklet, or simply call Tesla Motors.

If you sell your vehicle, leave all original owners package materials in the vehicle to make it available for the next owner.

If you bought this vehicle used, either fill in the “Change of Address Notice” found in the New Vehicle Limited Warranty booklet, or simply call Tesla Motors.

## Read this manual first

This owners manual contains a great deal of information you need to know about a Tesla Roadster. We urge you to read it carefully and familiarize yourself with the vehicle before driving.

For your own safety, follow the instructions and warnings contained in this manual. Ignoring them could result in damage to the vehicle or personal injury to you or others. Vehicle damage caused by failure to follow instructions is not covered by the New Vehicle Limited Warranty.

Keep this manual in your Roadster as a reference for the safe and enjoyable use of your Tesla Roadster. Should you sell your vehicle, be sure to provide this manual to the new owner.

All specifications and descriptions are accurate at the time of printing. Because improvement is a constant goal at Tesla Motors, we reserve the right to make changes at any time, without notice and without obligation.

This manual applies to all Roadster 2 and Roadster Sport vehicles. As a result, you may find some explanations for equipment or options not installed on your vehicle. When required, Tesla Motors distributes an addendum to provide updated information.

An effective way to find the information you need is to use the index at the back of this manual. If you are unable to find the

information you need, note that the following additional documents are included in your owners package:

- Audio and Navigation Guides - describes how to use the audio/navigation system
- Quick Reference - a summarized version of the information contained in all manuals to help you quickly understand your vehicle and its features
- Touch Screen Users Manual - describes how to use the screens to display important information while parking, driving, and charging the vehicle
- Charging Your Vehicle - describes how to charge your vehicle
- Roadside Assistance Guide - describes the Tesla Motors Roadside Assistance program and provides instructions on how to transport the vehicle
- Warranty Booklet - details the New Vehicle Limited Warranty
- Tire Warranty - details the warranty for the vehicle's tires

In addition to the documents in your owners package, Tesla provides the following documents:

- High Power Connector Installation Manual - provides planning guidelines for the installation of the High Power Connector as well as step-by-step installation instructions. This manual is included with the delivery of the High Power Connector.

- Mobile Connector Users Manual - describes how to use a Tesla Motors mobile connector. This manual is included with the delivery of a Tesla Motors mobile connector.
- OEM Audio & Navigation System manual - describes how to use the vehicle's audio and navigation system. This manual is provided in your vehicle's trunk.

When required, Tesla Motors may also include an addendum in the owners package if your vehicle differs from what is in the manuals. If you are missing a document, contact Tesla Motors.

## Copyright and trademarks

©2009 TESLA MOTORS INC. All rights reserved. This material may not be reproduced or copied, in whole or in part, without the written permission of Tesla Motors, Inc.

"Tesla Motors™" and "Tesla Roadster™" are trademarks of Tesla Motors, Inc. "HomeLink®" is a registered trademark of Johnson Controls, Inc. iPod® is a registered trademark of Apple Computer, Inc. Havoline® is a registered trademark of Chevron or its affiliates. TORX® is a registered trademark of Textron, Inc. All other trademarks are the property of their respective owners.

# Important notes about this manual

---

## Symbols glossary

The following symbols used within this manual call your attention to specific types of information:



**WARNING:** Indicates a situation in which serious bodily injury or death could result if the warning is ignored.▲



**Caution:** Indicates a situation in which bodily injury or damage to your vehicle, or both, could result if the caution is ignored.



Identifies items that must be disposed of safely to prevent unnecessary damage to the environment.

**Note:** A note provides useful supporting information and sometimes suggests how to make better use of your vehicle.



## Reporting safety defects

### United States

If you believe that your vehicle has a defect which could cause a crash or could cause injury or death, you should immediately inform the National Highway Traffic Safety Administration (NHTSA) in addition to notifying Tesla Motors.

If NHTSA receives similar complaints, it may open an investigation, and if it finds that a safety defect exists in a group of vehicles, it may order a recall and remedy campaign. However, NHTSA cannot become involved in individual complaints between you and another party such as Tesla Motors.

To contact NHTSA, call the Auto Safety Hotline toll-free at 1-888-327-4236 (TTY: 1-800-424-9153); go to <http://www.safercar.gov>; or write to:

Administrator, NHTSA  
1200 New Jersey Avenue SE  
Washington, DC 20590

You can also obtain other information about motor vehicle safety from <http://www.safercar.gov>.

### Canada

If you believe that your vehicle has a defect which could cause a crash or could cause injury or death, you should immediately inform Transport Canada, in addition to notifying Tesla Motors.

To contact Transport Canada, call their toll-free number: 1-800-333-0510.

# Your vehicle at a glance

---

## Exterior

Exterior overview

2-3

## Interior

Dashboard overview

2-5

# Exterior

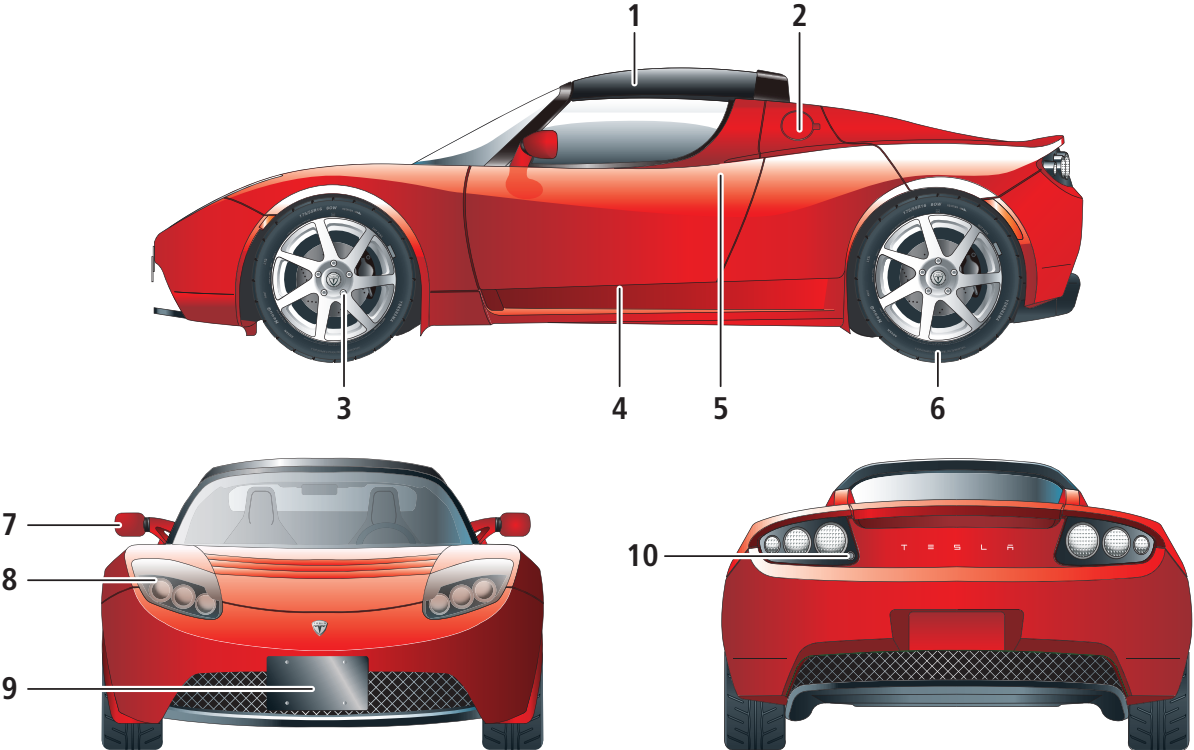

10TR0109

## Exterior overview

1. Roof. See Removable roof, page 7-8.
2. Charging port door. For details on vehicle charging, see the manual titled “Charging Your Vehicle” provided in your owners package.
3. Wheel bolts. See Removing the wheel, page 9-6.
4. Emergency door unlock. See Emergency unlocking, page 4-5.
5. Exterior door release. See Exterior door release, page 4-4.
6. Wheels and tires. See Wheels and tires, page 10-4.
7. Exterior mirrors. See Exterior rear view mirrors, page 7-3.
8. Headlights. See Exterior lights, page 6-6.
9. Vehicle recovery eye. See Attaching the vehicle recovery eye, page 9-14.
10. Trunk lock. See Opening the trunk, page 4-6.

# Interior

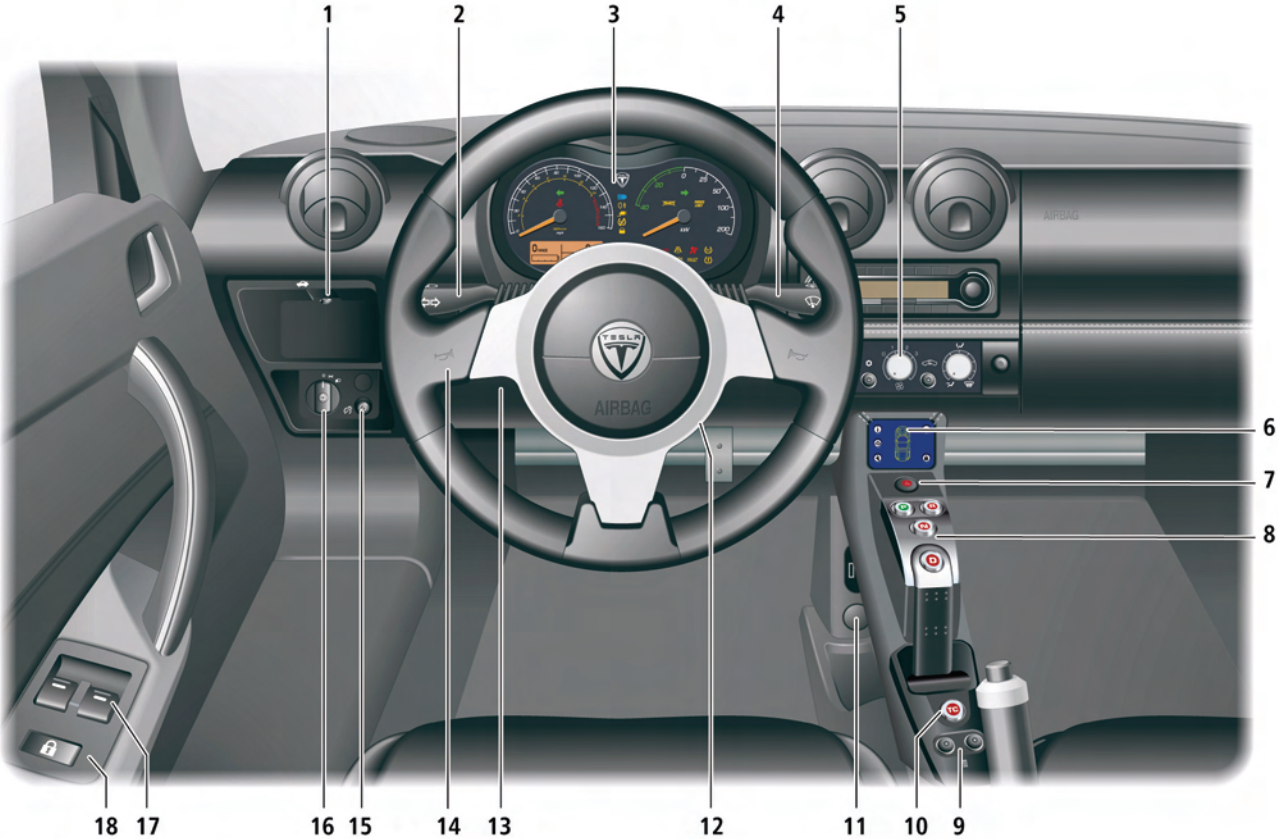

TR1321

## Dashboard overview

1. Trunk release. See Opening the trunk, page 4-6.
2. Turn signals, headlight high beam and cruise control. See Exterior lights, page 6-6 and Cruise control, page 6-9.
3. Instruments. See Instruments, page 6-11.
4. Windshield wiper and washer. See Windshield wiper and washer, page 6-8.
5. Heating and air conditioning. See Interior temperature control, page 7-4.
6. Touch Screen. See Touch Screen Users Manual provided in your owners package.
7. Hazard warning light switch. See Hazard warning, page 6-10.
8. Gear selector. See Selecting gears, page 6-3.
9. Seat heaters. Seat heaters, page 7-5.
10. Traction control switch. See Traction control, page 6-5.
11. Accessory power socket. See Accessory power socket, page 7-6.
12. Starter switch. See Starting the vehicle, page 6-2.
13. Hood release. See Opening the hood, page 8-3.
14. Horn. See Horn, page 6-10.
15. Instrument panel illumination control. See Instrument panel lighting, page 6-14.
16. Exterior lights master switch. See Exterior lights, page 6-6.
17. Power windows. See Operating the windows, page 7-2.
18. Central door locking. See Central door locking, page 4-4.

# Seating and safety restraints

---

## Seats

Seat adjustment 3-2

## Seat belts

General information 3-3

Seat belt safety instructions 3-3

Using the seat belts 3-3

Seat belt reminder 3-4

Wearing seat belts during pregnancy 3-4

Seat belt tensioners 3-4

Caring for seat belts 3-4

Child seats and restraints 3-5

## Airbag system

General information 3-6

How the system works 3-6

Deployment effects 3-6

Obstruction of airbags 3-7

Airbag warning indicator 3-7

Airbag warning labels 3-7

Using child seats 3-7

Passenger airbag deactivation 3-7

Airbag service information 3-8

# Seats



## Seat adjustment

**!** **WARNING:** Never adjust the driver's seat while your vehicle is moving. Unexpected or sudden seat movement could result in an accident.▲

## Driver's seat position

To adjust the forward/rearward position of the driver's seat, raise the bar beneath the front of the seat and slide the seat to the required position. Release the bar to lock the

seat into position. Ensure that the seat is locked in position before driving, by trying to slide the seat forward.

To reduce the risk of injury in the event of an accident, Tesla recommends the following when adjusting seat position:

- Adjust the seat so that you can press the foot pedals fully to the floor with your knees slightly bent.
- Make sure that you can comfortably reach the top of the steering wheel.
- Ensure a distance of at least 10 inches (25 cm) between the steering wheel and your breastbone. The airbag will not provide adequate protection if you sit closer.
- Fasten your seat belt correctly.

## Lumbar support

Adjust lumbar support using the inflator bulb located on the outside front edge of the driver's seat **1** or on the inside front edge of the passenger seat **2**.

To increase lumbar support, squeeze the bulb repeatedly until sufficient support is obtained. To reduce the amount of support, press the button located on the clamp between the hose and the inflator bulb.

## Head restraints

Each seat is provided with a head restraint. The head restraints are integral with the seats and therefore can not be adjusted or removed.



## General information

**!** **WARNING:** Seat belts should be worn by all occupants, for every journey no matter how short. Failure to do so greatly increases the risk of death or serious injury in the event of an accident.▲

It is an established fact that seat belts provide good protection in accidents. Therefore wearing a seat belt is required by law in most states.

Both the driver and passenger seating positions are equipped with three-point inertia reel seat belts. Inertia reel belts are tensioned automatically and allow freedom of movement during normal driving conditions.

The belt reel automatically locks, preventing movement of occupants, whenever your vehicle experiences the force associated with hard acceleration, braking, cornering or on impact in a collision. The reel may also lock when driving on steep hills or slopes.

## Seat belt safety instructions

**!** **WARNING:** Ensure that all seat belts are worn correctly. An improperly worn seat belt increases the risk of death or serious injury in the event of a collision.▲

**!** **WARNING:** Seat belts are designed to bear upon the bony structure of the body, and should be worn low across the pelvis, over the shoulder and across the chest. Avoid wearing the lap section of the belt across the abdominal area.▲

**!** **WARNING:** Always adjust the belt to remove slack. Seat belts worn too loose can result in injuries because they allow excessive forward movement in an accident.▲

**!** **WARNING:** Do not wear seat belts over hard, fragile or sharp items in clothing, such as pens, keys, eyeglasses, etc. In an impact, the pressure from the seat belt on such items can cause them to break, which in turn may cause serious injury.▲

**!** **WARNING:** Seat belts should not be worn with any part of the strap twisted.▲

**!** **WARNING:** Each belt assembly must be used by only one occupant. It is dangerous to put the belt around a child being carried on an occupant's lap.▲

**!** **WARNING:** It is essential that seat belts that have been worn in an accident are replaced, even if damage to the assembly is not obvious. The belt anchors must also be checked.▲

**!** **WARNING:** Care must be taken to avoid contaminating the seat belt webbing, and seat belt mechanisms with any chemicals, liquids, grit, dirt or cleaning products. If a seat belt fails to retract or latch into the buckle, it must be replaced immediately.▲

**!** **WARNING:** No modifications or additions should be made that prevent the seat belt mechanism from taking up

slack, or that prevent the seat belt being adjusted to remove slack. A slack belt greatly reduces the level of occupant protection.▲

## Using the seat belts



## Fastening the belt

1. Ensure that the seat is correctly positioned.
2. Take hold of the latch plate and pull it slowly across your chest and lap.
3. Insert the latch plate into the buckle and press down until you hear a "click" that indicates it is securely locked into place.
4. Pull the belt to check that it is securely fastened.
5. Position the belt so that it is worn low across the front of the pelvis, and across the chest and shoulder.

# Seat belts

- Pull the diagonal part of the belt towards the retractor to remove excess slack.

## Releasing the belt

Release the seat belts by pressing the red button on the buckle. The belt retracts automatically.

## Seat belt reminder

 The seat belt warning indicator in the instrument panel illuminates whenever the driver's seat belt is unbuckled. Also, an audible sound will be heard for six seconds if the key is turned to the ON position and the driver's seat belt is unbuckled.

## Wearing seat belts during pregnancy

 **WARNING:** Pregnant women should always wear seat belts to protect themselves and their unborn child.▲

 **WARNING:** Never place anything between you and the seat belt to cushion the impact in the event of an accident.▲

The lap portion of the belt should be worn as low as possible across the hips, not the waist. Position the diagonal part of the belt between the breasts and to the side of the abdomen.

If you have any concerns about wearing seat belts, contact your doctor.

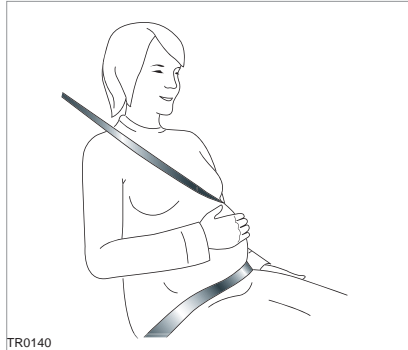

## Seat belt tensioners

 **WARNING:** If the seat belt pre-tensioners have been activated once, they must be replaced. After any accident, always have the airbags, seat belt pre-tensioners and any associated components checked and, if necessary, replaced by Tesla Motors.▲

The seat belts are equipped with pre-tensioners that activate in conjunction with the airbags and provide additional protection in the event of a severe frontal impact on your vehicle.

The pre-tensioners automatically retract the seat belt buckle, reducing any slack in both the lap and diagonal portions of the belts, resulting in reduced forward movement of the occupant.

Following an accident in which the pre-tensioners have been activated, the seat belts continue to function as restraints and must be worn if you drive your vehicle.

## Caring for seat belts

 **WARNING:** Regularly check the condition of both belts. Replace seat belts if you notice any damage to the belt webbing, fittings, retractor mechanisms or buckles.▲

Three tests for checking seat belts:

- With the seat belt fastened, give the webbing nearest the buckle a quick pull. The buckle should remain securely locked.
- With the belt unfastened, unreel the webbing to its limit. Check that unreeling is free from snags and visually check the webbing for wear. Allow the webbing to retract, checking that retraction is smooth and complete.
- With the webbing half unreeled, hold the tongue plate and pull forward quickly. The mechanism must lock automatically and prevent further unreeling.

If a seat belt fails any of these tests, contact Tesla Motors immediately.

For seat belt cleaning information, see Seat belts, page 8-9.

## Child seats and restraints

Currently, child seats and restraints are not approved for use in your vehicle. Until these are available, Tesla Motors strongly recommends that children are not carried as passengers in your vehicle.

 **WARNING:** The seat belts fitted to your vehicle are designed to secure adult sized passengers only.▲

 **WARNING:** Children under age 12 and those weighing less than 80 lb (36 kg) are not of sufficient size to be carried safely wearing a standard seat belt of the type fitted to your vehicle.▲

 **WARNING:** It is dangerous for children to travel in any type of vehicle without being restrained by a harness, child seat, or restraint system suitable for both their age and size.▲

 **WARNING:** Never let a passenger hold a child on his or her lap while your vehicle is moving. The passenger cannot protect the child from injury in a collision.▲

# Airbag system



TR1322

## General information

The airbag for the driver is located in the padded hub of the steering wheel. The airbag for the passenger is located on the dashboard. These are indicated by the word AIRBAG on the trim.

Provided the occupants are correctly seated and the seat belts are properly worn, the airbags provide additional protection to the chest and face of the occupants in the event of a severe frontal impact.

**Note:** Airbags inflate and deflate very quickly and will not protect occupants against the effects of secondary impacts that may occur.

## How the system works

**!** WARNING: The airbags are a supplemental restraint system providing additional protection in certain types of collisions only - they do not replace the need to wear a seat belt.▲

Operation of the airbag system depends on the rate at which your vehicle's passenger compartment changes speed as a result of a collision.

In the event of a collision, the airbag control unit monitors the rate of deceleration induced by the collision to determine whether the airbags should be deployed.

When deployed, airbags inflate instantly, with considerable force accompanied by a loud noise. The inflated bag, together with the seat belt restraint system, limit the movement of the occupants, thereby reducing the risk of injury to the head and upper torso.

The airbag system is not designed to operate as a result of:

- Rear collisions
- Minor front impacts
- Minor side impacts
- Heavy braking
- Driving over bumps or potholes

It follows, therefore, that significant superficial damage can occur without the air bags deploying or, conversely, that a relatively small amount of structural damage can cause the airbags to be deployed.

## Deployment effects

**!** WARNING: Following inflation, some airbag system components are hot. Do not touch until they have cooled.▲

**!** WARNING: The airbag module inflates with considerable speed and force. An inflating airbag can cause facial abrasions and other injuries. To limit these injuries, ensure that occupants are correctly seated, with the seat as far back as is practical, and are wearing seat belts.▲

**!** WARNING: The National Highway Traffic Safety Administration (NHTSA) recommends a minimum distance of 10 inches (25 cm) between an occupant's chest and the driver's airbag module.▲

When the airbags are deployed, a fine powder is released. This is not a malfunction. However, the powder may irritate the skin and should be thoroughly flushed from the eyes and from any cuts or abrasions on the skin.

After inflation, the airbags will deflate to provide a gradual cushioning effect for the occupants and to ensure the driver's forward vision is not obscured.

If the airbags have been deployed or if your vehicle has been in an accident, always have the airbags, seat belt pre-tensioners and any associated components checked and, if necessary, replaced by Tesla Motors.

## Obstruction of airbags

**!** **WARNING:** Do not allow passengers to obstruct the operation of the airbags by placing feet, knees or any other part of the body, or any other objects in contact with, or in close proximity to, an airbag module.▲

**!** **WARNING:** Do not attach or position items on an airbag cover which could interfere with the inflation of the airbag or be propelled inside your vehicle and injure occupants.▲

## Airbag warning indicator



A warning indicator in the instrument panel alerts you of any malfunction of the airbag system.

The components of the system being monitored include: the airbag modules, the seat belt pre-tensioners, the airbag control unit and the airbag wiring harness.

When the key is turned to the ON position, the airbag control unit monitors the readiness of the system's electrical circuits.

Contact Tesla Motors if:

- The warning indicator fails to illuminate when the key is turned to the ON position.
- The warning indicator fails to extinguish within approximately six seconds after the key is turned to the ON position.
- The warning indicator illuminates while your vehicle is being driven.

## Airbag warning labels

**!** **WARNING:** Extreme hazard! Do not use a rearward facing child restraint on a seat protected by an airbag in front of it. Doing so increases the risk of death or serious injury when the airbag deploys.▲



Airbag warning information is printed on the driver's and passenger's sun visor.

## Using child seats

**!** **WARNING:** Currently, child seats and restraints are not approved for use in your vehicle. Until these are available, Tesla Motors strongly recommends that children are not carried as passengers in your vehicle, and that you do not fit any type of child seat into your vehicle. Death or serious injury may occur if the child is too close to the dashboard when the airbag inflates.▲

## Passenger airbag deactivation

**!** **WARNING:** Your vehicle is fitted with an airbag system that has no provision for switching off or deactivating the passenger airbag.▲

# Airbag system

---

## Airbag service information

 **WARNING:** The disposal of used airbag units is subject to stringent regulations, and should only be handled by Tesla Motors.▲

For your safety, a Tesla Motors technician, who is familiar with your vehicle, must perform the following tasks:

- Removal, replacement, repair, or modification, of any wiring or component in the vicinity of airbag system components, including the steering wheel, steering column, dashboard and instrument panel.
- Modification to the front or side of your vehicle, including the bumper and chassis.

In addition, always seek the assistance of Tesla Motors if:

- An airbag inflates
- A pre-tensioner activates
- The front or side of your vehicle is damaged, even if the airbag has not inflated
- Any part of an airbag module cover shows signs of cracking or damage

# Doors, locks, and security

---

## Keys

About your keys	4-2
Using the key fob	4-2

## Doors

Exterior door release	4-4
Interior door release	4-4
Central door locking	4-4
Emergency unlocking	4-5
Glove box	4-5

## Trunk

Opening the trunk	4-6
Closing the trunk	4-6
Trunk interior release handle	4-6

## Vehicle security

Alarm System	4-7
Security PIN	4-7
PIN lock	4-9
Valet mode	4-10

# Keys

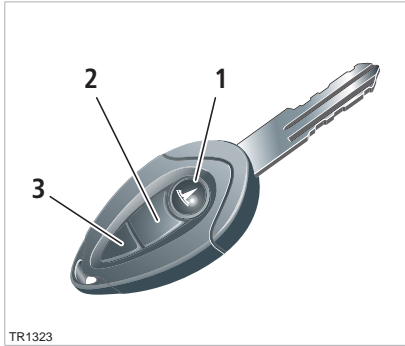

## About your keys



Caution: The key fob contains delicate electronic circuits and must be protected from impact, water damage and high temperatures. Avoid contact with solvents, waxes and abrasive cleaners.

You have been supplied with three keys. Two of the keys are key fobs with three buttons:

1. Lock button
2. Unlock button
3. Programmable button. See Programmable button, page 4-3.

Keep one of the keys in a secure place for use in emergencies. If you lose a key, contact Tesla Motors for a replacement.

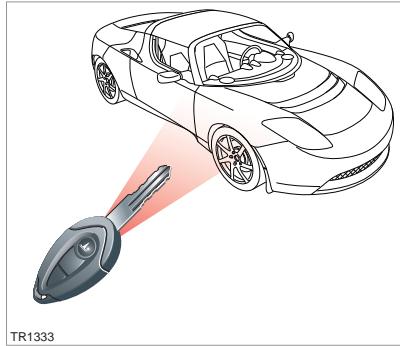

## Using the key fob

The buttons on the key fob transmit a coded radio signal to a receiver in your vehicle. It is not necessary to point the key fob at your vehicle, but you must be within operating range and you must hold the button down for two seconds. The operating range will vary according to the key fob's battery condition and other physical factors.

If the vehicle can not be locked or unlocked using the associated button on the key fob, you may need to change the battery in the key fob. See Replacing the key fob's battery, page 4-3.

**Note:** Interference from other radio equipment operating on a similar frequency may affect operation of the key fob. If this happens, operate the key fob as close to your vehicle as possible. If you are unable to

unlock your vehicle with the key fob, use the emergency key lock. See Emergency unlocking, page 4-5.

## Locking



**WARNING:** Never leave anyone in your vehicle when it is locked using the key fob. The interior door release handles will operate, but because the car was locked using the key fob, the alarm will sound. To re-open the doors using the exterior door release handles, you must first disarm the alarm using the key fob.▲

Press the Lock button on the key fob to lock the doors and arm the alarm.

The turn signals will flash once and the red security indicator on the console (illustrated on page 4-7) will illuminate and continue to flash red while the vehicle is locked. If you push the Lock button after the vehicle has already been locked, you'll hear a confirmation beep.

If a door, the hood or the trunk are not fully closed when the lock button is pressed, the turn signals will not flash and your vehicle is not armed. Check that the doors, hood and trunk are fully closed, then try again.

If an attempt is made to open the doors or the hood from inside the vehicle after the alarm has been set, the horn will sound and the turn signals will flash for one minute. See Alarm System, page 4-7.



## Unlocking

Press the center button on the key fob to unlock the doors and disarm the alarm.

The turn signals flash twice and the red alarm indicator on the console extinguishes.

**Note:** If neither door or trunk are opened within one minute, the doors will automatically re-lock and the alarm will arm.

## Programmable button

You can program the top button on the key fob to perform one of the following functions:

- Alarm — sounds the horn and flashes the exterior lights flash for one minute. Press again to cancel the alarm.
- Trunk release — opens the trunk
- HomeLink® device — operates a HomeLink device such as a garage door or gate

By default, Tesla has programmed this key to open the trunk. To re-program this button, use the Touch Screen. Refer to the Touch Screen Users Manual, provided in your owners package.

To activate the programmed function, press the button twice.

## Replacing the key fob's battery

The key fob's battery should last for approximately one year depending on use. When the battery needs replacing, you'll notice a deterioration in performance. For example, you'll gradually need to be closer to the vehicle to operate the key fob.

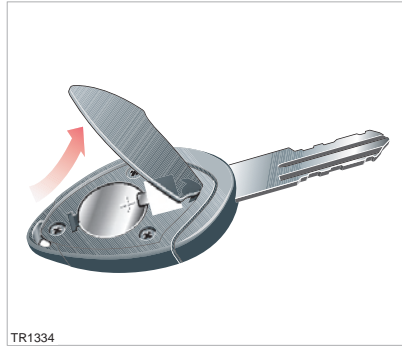

To replace the battery:

1. Insert a screwdriver into the top of the key fob and carefully separate the two halves. Avoid damaging the seal between the two halves.
2. Remove the battery, taking care to avoid touching the circuit board or the contact surfaces of the battery holder.
3. Fit the new battery (type CR2032) with the '+' side facing upwards.  
If possible, avoid touching the flat surfaces of the battery because finger marks will reduce battery life. Wipe the battery clean before fitting.
4. Re-assemble the two halves of the key fob by aligning them and pressing them together until they snap into place.

## Compliance

The key fob complies with Part 15 of the FCC rules and IC-RSS-210 Industry Canada. Operation is subject to the following conditions:

- This device may not cause harmful interference.
- This device must accept any interference received, including interference that may cause undesired operation.

Any changes or modifications to the key fob not expressly approved by the manufacturer or Tesla Motors could void the user's authority to operate the equipment.

# Doors

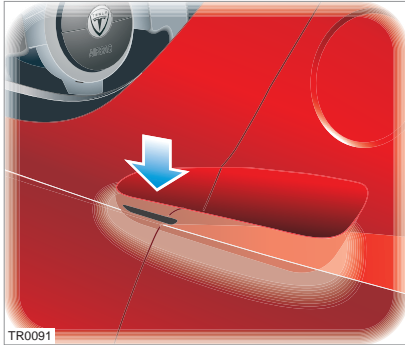

## Exterior door release

With the doors unlocked, *lightly* press the touch pad (located in the air inlet on the door) to release the door. There is no need to press hard. Pull the door to open.

**Note:** The door release touch pads operate only if the doors are unlocked.

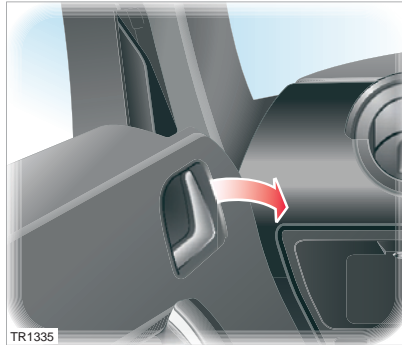

## Interior door release

From inside your vehicle, pull the interior door release handle to unlock and open the door.

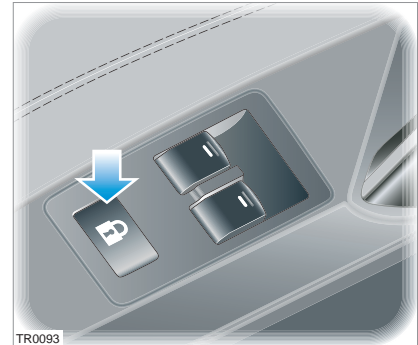

## Central door locking

For your security, you can lock both doors from inside your vehicle by pressing the central locking switch on the driver's door panel. The doors will lock automatically when the vehicle is being driven over 5 mph (8 kmh).

Press the switch once to lock the doors and inhibit the use of the exterior door release touch pads. The alarm indicator on the instrument panel will illuminate when the doors are locked.

Press the switch to unlock the doors and enable operation of the exterior door release touch pads. You can also unlock the doors using the key fob.

**Note:** The central door locking switch does not operate if the doors have been locked using the key fob. You'll need to unlock the

doors using the key fob. The central door locking switch also does not operate if a door, trunk, or the hood is not completely closed.

## Drive away locking

For your security, the doors lock and the trunk release switch is inhibited whenever your vehicle's speed exceeds 5 mph (8 kmh).

The trunk release button is reactivated when your vehicle's speed is less than 5 mph (8 kmh).

## Emergency unlocking

If the key fob fails to unlock the doors (for instance if there is an electrical failure), you can unlock the driver's door using the mechanical key.

A lock is located on the underside of the driver's door. Turn the key clockwise to unlock the door.

**Note:** If active, the alarm will sound when the door is opened. To cancel the alarm, press the unlock button on the key fob or enter the PIN Code on the Touch Screen. The default PIN Code is 1234 but you can personalize this code using the Touch Screen. For details, refer to the Touch Screen Users Manual provided in your owners package.



TR1350

## Glove box

To open the glove box, press the button located on the dashboard immediately to the left of the glove box.

To close the glove box, simply push it closed.

**Note:** The glove box will not open when the alarm system is on.

# Trunk



TR1331

## Opening the trunk

To open the trunk, press the trunk release button on the dashboard, or insert the key in the external lock and turn counter-clockwise. You can also use the key fob if you have set up its programmable button to remotely open the trunk. For details on programming the key fob, refer to the Touch Screen Users Manual provided in your owners package.

The trunk release button is disabled when the doors are locked with the key fob, or when the vehicle's speed exceeds 5 mph (8 kmh).

## Closing the trunk

Close the trunk one side at a time. Use both hands to firmly but gently apply downward pressure on one side of the rear spoiler until you hear it "click: into place. Repeat for the other side.

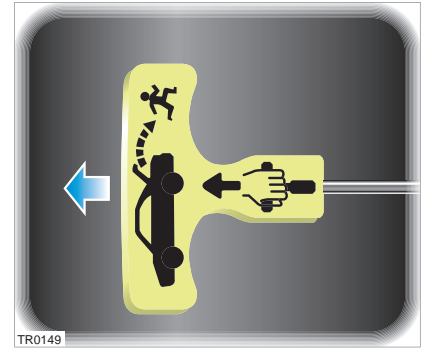

TR0149

## Trunk interior release handle

Your vehicle is equipped with a mechanical trunk release handle that provides a means of escape in the event that a person becomes locked inside the trunk. Adults are advised to familiarize themselves with the operation and location of the release handle.

A T-shaped handle is located at the back of the trunk towards the drivers side of the vehicle. This handle is made using a luminescent material that glows for hours after a brief exposure to ambient light. To open the trunk from the inside, pull the T-shaped handle and push up on the trunk lid.

## Alarm System

Your vehicle is equipped with an anti-theft alarm system. The alarm is switched on automatically when you lock the doors with the key fob. The turn signals flash once to confirm that your vehicle is locked. The alarm indicator on the instrument panel flashes red when the vehicle is locked. An audible tone will also be heard from inside your vehicle.

Once activated, the alarm monitors the opening of the:

- Hood
- Doors
- Trunk

If a door is opened without the key fob, the alarm sounds.

To switch off the alarm, unlock the doors using the key fob or enter the PIN Code on the Touch Screen.

**Note:** If the doors are unlocked with the key fob, they will automatically re-lock if neither the trunk or a door is opened within one minute of the unlock button being pressed.

### Alarm indicator



An indicator on the instrument panel will flash red whenever the alarm system is active.



An indicator on the instrument panel will illuminate green whenever the doors are locked and the alarm is not active.

### If the vehicle didn't lock

If the vehicle doesn't lock when you press the Lock button on the key fob, the turn signals will not flash. Check that both doors, the hood and the trunk are fully closed before pressing the lock button again. If the problem persists, contact Tesla Motors.

### Switching off the alarm

If the alarm is triggered, the horn will sound for one minute and the turn signals will flash to attract attention. To silence the alarm, press the UNLOCK button on the key fob or enter your PIN code on the Touch Screen.

**Note:** Turning the key to the ACC position will silence the alarm. However, it will not be possible to start your vehicle until you either press the Unlock button on the key fob or enter the PIN code on the Touch Screen. For details on using the Touch Screen, see the Touch Screen Users Manual provided in your owners package.

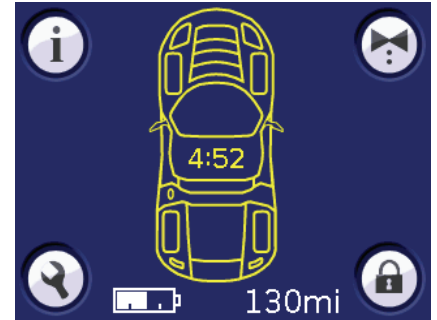

## Security PIN

As an alternate level of vehicle security, you can restrict operation of your vehicle until a security PIN (Personal Identification Number) is entered. The security PIN is used by the following features that can be selected on the Touch Screen's parked screen (shown above—the parked screen is active whenever the hand brake is engaged).



Valet mode. See Valet mode, page 4-10.



PIN Lock. See PIN lock, page 4-9.

You can also use the security PIN to turn off the vehicle's alarm.

The default PIN code is 1234. Tesla Motors strongly recommends that you change this to a unique PIN code. If you sell your vehicle, you'll need to tell the new owner the security PIN you have set.

# Vehicle security



## Setting the security PIN

With the hand brake engaged, touch the **SETTINGS** icon on the main parked screen (or any of the drive screens) to display the settings screens.

Press the right arrow icon to navigate to the second settings screen.

### Touch **Security PIN**.

You will be asked to enter the old PIN code. Enter the old PIN code (if you haven't previously set a PIN code, the default code is 1234) by touching the numbers on the screen and then touch **OK**. If you enter an incorrect PIN code, an invalid entry message will be displayed. Either enter the correct PIN code or touch the **EXIT** icon to return to the previous screen.

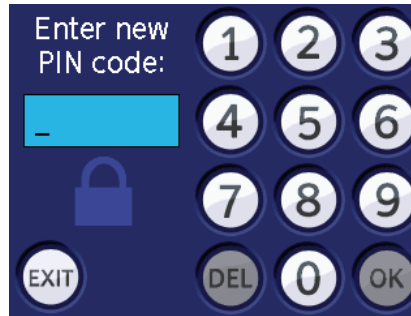

You will be then be asked to enter the new PIN code. Enter a new PIN code and then touch **OK**.

**Note:** The PIN code must be between four and eight digits in length.

You will then be asked to confirm the new PIN code. Enter the new PIN code again and then touch **OK**.

If the PIN code does not match the previously entered code a message will be displayed telling you that the PINs differ and you will need to enter the PIN code again.



If the PIN codes match, then the PIN Code Set screen will be displayed.

Touch **OK** to return to the Settings screen.

**Note:** Always keep a record of your PIN code and store it in a safe place. Do not store your PIN code in your vehicle.

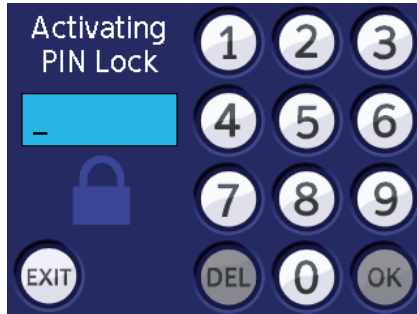

## PIN lock

When activated, the PIN lock inhibits starting and driving your vehicle until the PIN code is entered on the Touch Screen.



## Activating PIN lock

 To activate the PIN lock, touch the **LOCK** icon on the main parked screen. Enter your PIN code. The Touch Screen displays a message (shown above) telling you that the PIN lock is activated.

If a PIN code has not been set, the Touch Screen displays a message telling you to enter a new PIN code. Touch OK to enter a new PIN code. See Security PIN, page 4-7.

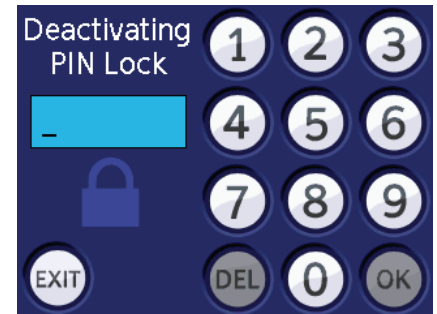

## Deactivating PIN lock

 To deactivate the PIN lock, touch the **UNLOCK** icon to display the PIN code entry screen.

Enter your PIN code and then touch **OK**. If the correct PIN code was entered, the Touch Screen displays the main parked screen.

If you enter an incorrect PIN code, a message is displayed telling you that you've made an invalid entry. Either enter the correct PIN code or touch the **EXIT** icon to return to the previous screen.

# Vehicle security

## Valet mode

For your peace of mind, your vehicle has a unique valet mode for those times that your vehicle is parked by another person.

When valet mode is active, your vehicle's power is limited and the Touch Screen displays activity information about the vehicle. The maximum speed the vehicle can travel in valet mode is 50 mph (80 kmh). Operation of the Touch Screen is restricted to the valet mode screen which displays information on how your vehicle was used while in valet mode.

Valet mode can only be deactivated by entering the vehicle's PIN code.

### Activating Valet mode



To activate valet mode, touch the bow tie icon on the Touch Screen's main parked screen.

Provided a vehicle PIN code has been set, you'll be prompted to enter your PIN code. Enter your PIN code and touch OK. The Touch Screen displays the Valet Mode Activated screen.

If a PIN code has not been set, the Touch Screen displays a message telling you to enter a new PIN code. Touch OK to enter a new PIN code. See Security PIN, page 4-7.

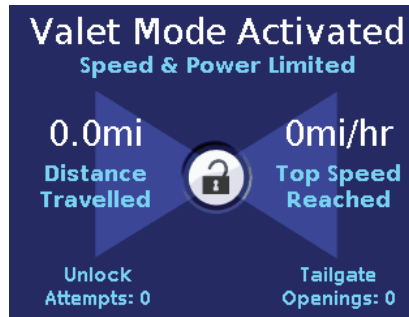

The Touch Screen displays the following information for the current period that valet mode has been active:

- Distance travelled
- Top speed reached
- Unlock attempts (the number of unsuccessful attempts at entering a PIN code)
- Trunk openings (the number of times the trunk has been opened)



### Deactivating Valet mode



To deactivate valet mode, touch the **UNLOCK** icon to display the PIN code entry screen.

Enter your PIN code and then touch **OK**. If the correct PIN code was entered, the Touch Screen displays the main parked screen.

If you enter an incorrect PIN code, a message is displayed telling you that you've made an invalid entry. Either enter the correct PIN code or touch the **EXIT** icon to return to the previous screen.



# Charging your vehicle

---

<b>General information about charging</b>		
Important!		5-2
The Battery		5-2
Designed to be plugged in		5-2
Leaving the vehicle unplugged		5-2
Storing your vehicle		5-3
Maximum level of charge		5-3
Charge level and range are estimates		5-3
How long does it take to charge?		5-3
<b>Charge settings</b>		
About charge settings		5-4
Four charge modes		5-4
Schedule the charge time		5-5
Setting current limit		5-5
Cost		5-5
<b>Charging components</b>		
Charging components		5-6
Mobile connector		5-6

# General information about charging

## Important!

 Caution: If the Battery's charge level falls to 0%, it must be plugged in immediately. Failure to do so can permanently damage the Battery and this damage is not covered by the New Vehicle Limited Warranty. Also, if you allow the Battery to fall to a critically low level it may not be possible to charge the vehicle. If you are unable to charge the vehicle, contact Tesla Motors.

 **WARNING:** The Battery has no parts that an owner, or a non-Tesla authorized technician can service. Under no circumstances should you open or tamper with the Battery. Always contact Tesla Motors to arrange for Battery servicing. ▲



At the end of its service life, the Battery will be recycled. Contact Tesla Motors for recycling arrangements.

## The Battery

The Tesla Roadster's Battery provides power to the motor as well as all the other electrical systems on the vehicle, such as lights, instruments, audio system, etc.

The Battery is one of the largest and most advanced battery packs in the world, consisting of several thousand lithium-ion battery cells that store enough energy for the vehicle to travel over 200 miles (320 kms) without recharging.

**Note:** Actual range will vary based on driving style. The vehicle consumes more energy if you are driving aggressively, driving up hills,

or are using more resources such as air conditioning. Also, over time, the Battery experiences a gradual loss of capacity, inherent in all lithium-ion batteries. So, as your vehicle ages, the capacity of the Battery declines.

As you drive your vehicle, the level of charge in the Battery is depleted and you'll need to recharge it. The Roadster's built-in charging system allows you to easily recharge it by connecting an electrical power supply to the vehicle's charging port.

## Designed to be plugged in

The Tesla Roadster is designed to be plugged in when not in use. This ensures that the next time you use the vehicle, it is fully charged and ready to go. There is no advantage to waiting until battery level is low before charging. Plugging in every night eliminates the risk of damage that could be caused by over-discharging the battery.

When plugged in, the vehicle optimizes the lifetime of the Battery by managing its charge level and temperature. The vehicle wakes up every 24 hours and, if needed, automatically initiates the charging process to keep the Battery at an optimum charge level.

If you're not driving your vehicle every day, see [Storing your vehicle](#), page 5-3.

## Leaving the vehicle unplugged

Even when you're not driving the vehicle, the Battery will slowly lose its charge. Therefore, when you're not using the vehicle, you should leave it plugged in. However, situations may arise in which you must leave the vehicle unplugged for an extended time (for example, at an airport when travelling for a couple of weeks). If this is the case, it is your responsibility to ensure that the Battery does not become fully depleted. Charge the Battery to a maximum level before leaving it. Keep in mind that when the vehicle is left unplugged with a full Battery, the initial rate of decline can be significant. When fully charged, the Battery's charge level can drop as much as 7% a day and 50% within the first week. When the Battery's charge level falls below 50%, the rate of decline slows down to approximately 5% per week. Over-discharge can permanently damage the Battery.

If for some reason, you are unable to keep the vehicle plugged in when it is not being used, it is up to you to preserve battery life by paying attention to the charge level and the temperature (see bulleted list below). If leaving your vehicle unplugged for more than 24 hours, follow these do's and don'ts to avoid prematurely decreasing the life of your vehicle's Battery:

- DO leave the vehicle plugged in whenever possible.
- DO maintain at least a 15% charge level in the Battery if leaving it unplugged for more than 48 hours.

- DO charge the Battery to a full charge before leaving it unplugged. This maintains the charge level needed to keep the Battery's electronics operational. If storing for more than 15 days, it is strongly recommended that you keep it plugged in.
- DO NOT expose an unplugged vehicle to ambient temperatures below -20°F (-29°C) or above 120°F (49°C).

Use the vehicle's Touch Screen to determine the charge level and temperature of the Battery. For details, refer to the Touch Screen Users Manual, provided in your owners package.

## Storing your vehicle

If you plan to leave the vehicle unused for longer than 15 days, it is recommended that you leave the vehicle connected to the High Power Connector and select the 'Storage' charge setting using the Touch Screen. When you charge the vehicle using the Storage charge setting, the vehicle is automatically kept at a reduced charge level to optimize the life of the individual cells within the Battery. Keep in mind that the reduced charge level also reduces the vehicle's available driving range. So remember to change the setting back to 'Standard' before taking the vehicle on an extended drive. For details on how to select the Storage charge setting, refer to the Touch Screen Users Manual, provided in your owners package.

## Maximum level of charge

The maximum level of charge the Battery will be charged to depends on the charge setting you select (see About charge settings, page 5-4). The Standard charge setting is the preferred setting for normal use. Selecting the Range or Performance charge settings will charge the Battery to its maximum allowable charge level, whereas selecting the Storage charge setting will charge the Battery to a relatively low level.

## Charge level and range are estimates

The vehicle's Touch Screen displays the charge level and number of miles you can drive on the remaining charge. The numbers that are displayed are estimates only. The Touch Screen allows you to display these estimates based on how you've been driving for the last 40 miles (64 kms) (EST RANGE) or how many miles you can achieve in ideal driving situations (IDEAL RANGE). Therefore, if you have been driving on hills for the past 40 miles (64 kms), and you are now driving on a flat highway, the number of miles you can drive on the remaining charge will actually be more than the estimate that is displayed when EST RANGE is selected. Likewise, if you are displaying remaining miles based on IDEAL RANGE, but are using the vehicle's air conditioning system and driving aggressively, the number of miles you can drive on the remaining charge will be less the estimate that is displayed. Charge level

and estimated remaining mileage are also displayed on the vehicle's LCD panel (see page 6-11).

The charge level and estimated mileage are continuously updated. Also, they may be lower or higher after a period of rest. For example, when parking your vehicle you notice that the estimated remaining mileage is 85. When returning to your vehicle a few hours later, you notice that the estimated mileage is now 91. This is normal behavior and is not a cause for concern. The mileage that is displayed when the vehicle has been at rest is more accurate.

## How long does it take to charge?

The amount of time it takes to fully charge the vehicle will vary depending on current and voltage. Charge time is also impacted by both the ambient temperature and the vehicle's Battery temperature—if out of the optimal range, the HVAC system starts up and diverts a portion of the energy. It also depends on the charge setting you are using. For example, a full charge at Range or Performance takes approximately 15% longer.

Use the following table as a guideline when estimating how long it will take to charge your vehicle. This table assumes you are charging a fully depleted Battery to a full charge using the Standard or Range charge setting. Charge times are estimates only.

# Charge settings

Charge Specification (amps/voltage)	Charge Time in Standard mode	Charge Time in Range mode
12A/120V	48 hours	54 hours
15A/120V	37 hours	41.5 hours
10A/240V	23.5 hours	26.5 hours
13A/240V	18 hours	20 hours
16A/240V	14.5 hours	16 hours
24A/240V	10 hours	11 hours
30A/240V	8 hours	9 hours
32A/240V	7.5 hours	8 hours
40A/240V	6.2 hours	7 hours
48A/240V	5.3 hours	6 hours
56A/240V	4.7 hours	5 hours
64A/240V	4.2 hours	4.7 hours
70A/240V	4 hours	4.5 hours

**Note:** The charge process slows down as the Battery approaches a full charge. Therefore, reaching a high level of charge is much quicker than reaching a full charge.

## About charge settings

Your vehicle has been set up with default charging settings. However, you can override these default settings. You may want to optimize the charging environment when storing your vehicle, or you may want to extend the vehicle's driving range. You can also reduce the default charge current, set a time that you want charging to begin, and display your electrical cost per charge.

Charge settings can be changed using the Touch Screen. The various charge settings are summarized below. For details on how to use the Touch Screen to adjust settings, refer to the Touch Screen Users Manual, provided in your owners package.

## Four charge modes

The charge mode always defaults to Standard charge. In other words, changing the charge type is a one-time event—the charge type reverts back to Standard the next time the charging port door is opened after the vehicle has been driven over a tenth of a mile (.16 kms).

### Storage

If you are not using the vehicle for an extended period of time, Tesla recommends leaving the vehicle plugged in and setting the charge type to Storage.

This setting charges the Battery to a medium level of charge to ensure the maximum lifetime of the cells within the Battery, while also maintaining the integrity of the vehicle's electronic systems, such as the security system.

This charge setting is automatically cancelled and reverts back to Standard if the vehicle's charging port door is opened after the vehicle has been driven over a tenth of a mile (.16 kms).

If the vehicle is driven after being charged using the Storage setting, the range of the vehicle will be limited because the charge level is lower than the other charge types.

This is temporary and returns to normal after charging the vehicle using the Standard setting.

### Standard

By default, the vehicle is set up to charge using the Standard charge setting—this setting provides the best performance while also maximizing the life of the Battery.

### Range

This setting charges the Battery to the maximum available level. It also limits the vehicle's power by 50%. The result is that the vehicle can achieve the maximum number of miles possible on a single charge.

To preserve the life of the Battery, this charge setting is automatically cancelled and reverts back to Standard after 72 hours or when the vehicle's charging port door is opened after the vehicle has been driven over a tenth of a mile (.16 kms).

 **Caution:** Repeated use of the Range charge setting reduces the lifetime of the cells within the Battery.

### Performance

This setting is available for those rare times in which you want to achieve maximum power and hence, minimize the time it takes to accelerate from 0-60 mph (0-100 kmh). Use this setting with caution because it allows the Battery to run at a higher temperature—which reduces the life of the cells within the Battery. Frequent use of this setting is strongly discouraged.

This setting also charges the cells within the Battery to the maximum available level.

To preserve the life of the Battery, this charge setting is automatically cancelled and reverts back to Standard after 72 hours or if the vehicle's charging port door is opened after the vehicle has been driven over a tenth of a mile (.16 kms).



Caution: Repeated use of the Performance setting reduces the lifetime of the cells within the Battery.

## Schedule the charge time

If you don't want the vehicle to begin charging immediately after you plug it in, you can set a charge start time. This is a useful way to charge the vehicle during non-peak hours when there is less demand on your electrical system and your electricity may cost less.

## Setting current limit

The charging current is automatically set to the maximum possible value available from the attached power supply. With the charging port door open, you can use the Touch Screen's charge settings screen to manually change the current. If you do so, the changed value remains in effect for the current location until you manually change it. The vehicle location is determined by the internal global positioning system (GPS). This allows you to set a different current limit for each of your charging locations.

## Cost

You can display the cost of a charge on the Touch Screen when the vehicle has finished charging. You can obtain an accurate reading of your power cost for each charge cycle by entering the cost of power (in kWh) on the Cost Settings screen. In most areas, you can obtain your power costs from your utility bill. For details on setting charge costs, refer to the Touch Screen Users Manual provided in your owners package.

# Charging components

1. Battery
2. Charging cable connector
3. Charging port door
4. Charging cable
5. Cable hanger
6. High Power Connector

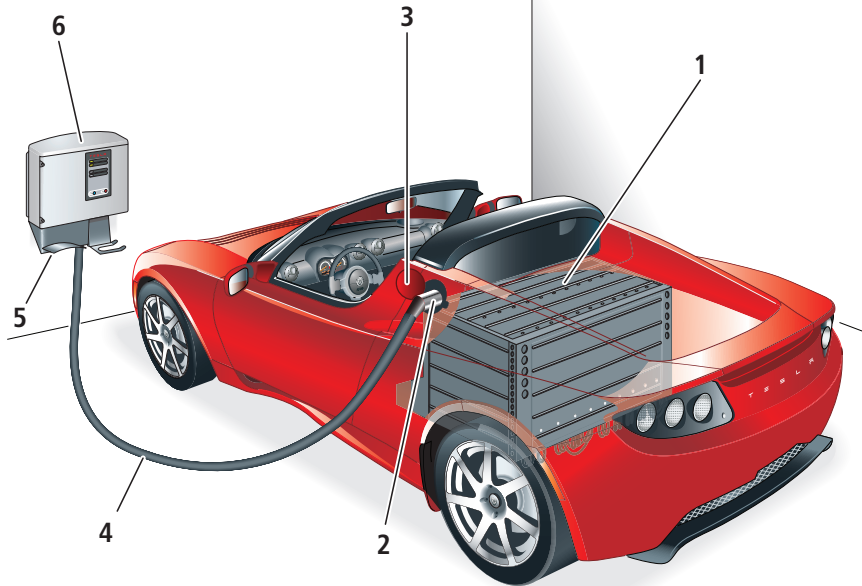

TR1347

## Charging components

A Tesla Motors High Power Connector is the fastest way to recharge your vehicle.

During normal use, the High Power Connector should be left on, even when the charging cable is not connected to the vehicle. The READY light on the control panel illuminates green to indicate that the High Power Connector is operating correctly.

Although the High Power Connector is on and ready, no electricity is supplied until you connect the charging cable to the vehicle, and both the vehicle and the High Power Connector determine that it is safe for charging to begin.

For details on how to use the High Power Connector to charge your vehicle, refer to the manual titled "Charging Your Vehicle," provided in your owners package.

## Mobile connector

The Tesla Motors Mobile Connector connects into most power outlets to allow you to charge your vehicle when you are away from home. Its small size allows it to be carried in the vehicle's trunk. Keep in mind that it takes longer to charge the vehicle using the Mobile Connector than when using the High Power Connector. Always check the vehicle's charge level before driving and plan your drive and charging requirements accordingly. For details on how to use a Mobile Connector to charge your vehicle, refer to the manual titled "Charging Your Vehicle,"

## Driving basics

Starting the vehicle	6-2
Key positions	6-2
Steering column lock	6-3
Selecting gears	6-3
Driving tips	6-3
Hand brake	6-4
Braking	6-4
Anti-lock Braking System (ABS)	6-5
Traction control	6-5

## Switches and controls

Exterior lights	6-6
Turn signals	6-7
Windshield wiper and washer	6-8
Cruise control	6-9
Hazard warning	6-10
Horn	6-10

## Instruments

Instrument panel components	6-11
Power meter	6-11
LCD panel	6-11
Warning indicators	6-12
Instrument panel lighting	6-14

# Driving basics

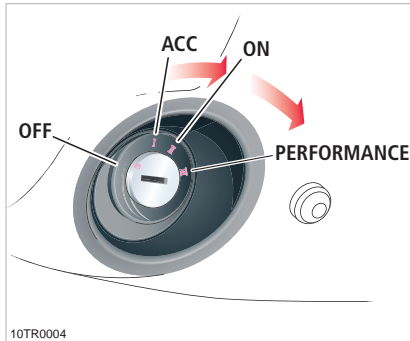

## Starting the vehicle

To start the vehicle, turn the key to the ON position.

All warning indicators on the instrument panel will illuminate briefly. When these indicators extinguish and the gear selector buttons illuminate, the vehicle is ready to be driven.

To drive the vehicle, press the brake pedal and press the D (Drive) or R (Reverse) gear button. Place your foot on the brake pedal to change the gear out of P (Park) or N (Neutral).

## Key positions

The starter switch has the following key positions to control the electrical circuits and steering column lock.

### OFF

When the key is OFF, the vehicle is automatically in the P (Park) gear position and the following features are operational:

- Touch Screen
  - All interior and exterior lights (including trunk light and hazard warning lights)
- Central door locking switch
- Trunk release switch

**Note:** When you turn the key to the OFF position, the circuits that operate in ACC continue to operate until you remove the key.

### ACC

In addition to the features that operate when the key is OFF, the following features operate when the key is in the ACC position:

- Audio and navigation systems
- Brake lights
- Windows
- Seat heaters
- LCD panel

### ON

When the key is in the ON position, all controls and switches, lights, instruments, warning indicators and electrical circuits are operational.

### PERFORMANCE

Move the key all the way forward to engage “Performance” mode. In Performance mode, you can achieve maximum power and minimize the time it takes to accelerate from

0-60 mph (0-100 km/h). When in Performance mode, you’ll notice a small blue letter “P” in the upper right-hand corner of the Touch Screen’s Drive screen.

**Note:** You will be unable to use the key to engage Performance mode within the first 10 seconds of starting the vehicle, or if you are driving in Range mode with the Battery almost fully depleted.

Use this mode with caution because it allows the Battery to run at a higher temperature—which reduces the life of the cells within the Battery. Frequent use of this setting is strongly discouraged.

To cancel Performance mode, turn the key all the way forward again. You can also cancel it using the Touch Screen.

You can also engage Performance mode at any time using the Touch Screen. For more information, see Performance, page 5-4 or refer to the Touch Screen Users Manual included in your owners package.

## Removing the key

To remove the key, turn the key to the OFF position. Exterior lights (except hazard warning lights) automatically turn off when you remove the key.

If you leave the key in and open the driver’s door, you’ll hear an audible alert reminding you to remove the key.

**WARNING:** Never remove the key when the vehicle is moving. The steering column will lock and you can no longer steer the vehicle.▲



## Steering column lock

The steering column locks whenever you remove the key. You may need to turn the steering wheel slightly to align the mechanism that engages the lock.

To release the steering column lock, turn the key to the ACC position. If it is difficult to turn the key, turn the steering wheel slightly.

## Selecting gears

The vehicle has four selectable gear positions. When a gear is engaged, it's associated button illuminates green.



- **P** (Park). Selectable whenever the vehicle's forward speed is less than 1 mph. To select another gear when the vehicle is in Park, you must press the brake pedal. Whenever the key is in the OFF position,

Park is activated automatically, regardless of which gear was engaged before you turned the key.

- **N** (Neutral). Allows the vehicle to be stationary without the transmission being locked. If the hand brake is not engaged, the vehicle can roll freely if pushed, or if located on a slope. To select another gear when the vehicle is in Neutral and moving at a speed less than 5 mph (8 kmh), you must press the brake pedal.
- **R** (Reverse). Selectable whenever the vehicle's forward speed is less than 5 mph (8 kmh). The maximum speed in reverse is limited to 15 mph (24 kmh). An audible tone will be heard when you select Reverse.
- **D** (Drive). Can be selected at any time except when the vehicle is moving over 5 mph (8 kmh) in reverse.

When a gear is engaged, its associated button illuminates green. If you select a gear that is not allowed in the current situation (for example, you select Reverse when driving forward over 5 mph (8 kmh), its associated button illuminates red to indicate that the gear change is denied.

Similar to a conventional automatic transmission, when you select Drive or Reverse, the vehicle will move, even if you have not pressed the accelerator pedal.

**Note:** When in Park, the transmission is locked and the rear wheels cannot turn. **In the event that the vehicle needs to be hauled on a flatbed truck, Park must be deactivated before the vehicle can be pulled onto the**

**truck.** You can pull the vehicle by selecting Neutral or by using the Touch Screen to activate Tow Mode. For details, see Vehicle recovery, page 9-13.

## Driving tips

Driving an electric vehicle is similar to driving a gasoline-powered vehicle. Maximizing driving range is done using the same driving habits that you use when maximizing fuel economy. However, here are a few guidelines:

### Drive sensibly to maximize range

Energy consumption depends on driving habits and operating condition. Your vehicle is designed to travel over 200 miles (320 kms) on a charge.

To get the maximum mileage from a charge, you should:

- Avoid frequent acceleration and deceleration.
- Anticipate stops and instead of using the brake pedal to slow down, move your foot off the accelerator. Whenever the vehicle is moving and your foot is off the accelerator, regenerative braking slows the vehicle and feeds energy back to the battery.
- Drive with the top on and the windows up to minimize aerodynamic drag.
- Keep tires at the recommended inflation pressures.
- Remove unnecessary belongings from the trunk.

# Driving basics

- Minimize the use of resources such as heating and air conditioning. Using seat heaters to keep warm is more efficient than heating the cabin.

In addition to driving habits, energy consumption is also increased based on environmental conditions, such as cold weather and hilly roads.

The power meter on the vehicle's instrument panel and the Touch Screen's Energy screen displays precise real-time feedback on the amount of energy you're using.

## Deep water

Do not drive through flooded areas, water of unknown depth, or deep puddles. When driving through even a relatively shallow puddle, drive slowly to prevent water from entering the vehicle.

## Carrying items in cabin area

The trunk is the preferred place to carry objects. In an accident, during hard braking, or sudden maneuvers, loose items carried in the vehicle's cabin area can be thrown around, and cause injury to occupants unless securely fastened.

## Hand brake

**WARNING:** Do not apply the hand brake when the vehicle is moving. This could result in a loss of control and may damage the rear brakes.▲

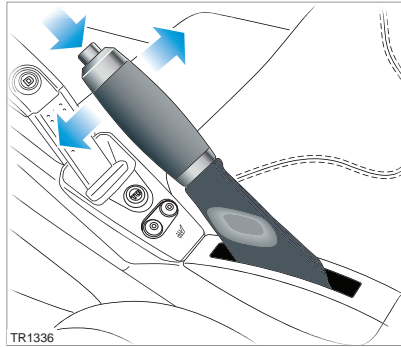

To apply the hand brake, pull the lever fully upwards. The hand brake operates on the rear wheels only, and is totally independent of the foot-operated hydraulic brake system.

**BRAKE** If the key is turned to the ON position and the hand brake is applied, the warning indicator in the instrument panel illuminates and the Touch Screen displays the main Parked screen.

**Caution:** If you apply the hand brake when the brakes are hot (such as after prolonged or frequent hard use), ensure that the lever is fully engaged. As the brakes cool, the amount of braking applied by the lever decreases.

To release the hand brake, pull the lever up slightly, depress the button (shown in illustration) and fully lower the lever. The warning indicator will extinguish and the Touch Screen will display a Drive screen.

## Braking

**WARNING:** After driving through heavy rain, you may experience a loss of response from the brakes. As soon as safety permits, apply the brakes to generate heat and dry the brake components. Never drive the vehicle through deep water—doing so can cause damage that is not covered by the New Vehicle Limited Warranty.▲

The brakes operate through dual circuits. If one circuit fails, the other continues to function, but braking performance is reduced. If you experience longer stopping distances, or if you find that you need to increase pressure on the brake pedal, you should not drive the car. Contact Tesla Motors as soon as possible.

The brakes are servo-assisted, but only when the key is in the ON position and the electrical systems are operating. Without servo-assistance, you will need to apply more pressure on the brake pedal and you will experience longer stopping distances.

## Regenerative braking

Whenever the vehicle is moving and your foot is off the accelerator, regenerative braking slows the vehicle and feeds energy back to the battery. By anticipating your stops and simply removing your foot from the accelerator to slow down, you can take advantage of the energy gained from regenerative braking. A visual display on the instrument panel provides real-time feedback of the vehicle's regenerative braking. See Instruments, page 6-11.

The amount of regenerative braking can vary depending on the current state of the Battery. For example, you'll experience a loss of regenerative braking if the Battery is extremely hot or cold or if the Battery has already been charged to its maximum allowable level using the Range or Performance charge setting.

You'll also experience a loss of regenerative braking in slippery road conditions—when this occurs, the traction control indicator on the instrument panel may flash and you may experience that the brakes feel slightly different. This is not a cause for concern.

 When regenerative braking is not available or has been significantly reduced, a warning indicator illuminates on the instrument panel.

## Anti-lock Braking System (ABS)

 **WARNING:** ABS cannot overcome physical limitations such as stopping the vehicle in too short a distance, turning the vehicle at high speeds, or the lack of grip on the road's surface.▲

 **WARNING:** Do not take driving risks and hope that ABS will correct judgement errors. It is always your responsibility to drive with due care and attention.▲

Your vehicle is equipped with an anti-lock braking system (ABS) that prevents the wheels from locking when you apply

maximum brake pressure. This allows you to maintain steering control during heavy braking on most road conditions.

During emergency braking conditions, the ABS constantly monitors the speed of each wheel and varies the brake pressure according to the grip available.

The alteration of brake pressure can be felt as a pulsing sensation through the brake pedal. This demonstrates that ABS is operating and is not a cause for concern. Keep firm and steady pressure on the brake pedal while experiencing the pulsation.

## Emergency braking

 **WARNING:** DO NOT pump the foot brake. ABS does this for you and by pumping the foot brake yourself, you are interfering with ABS operation, which may increase braking distance.▲

In an emergency, fully press the brake pedal even when the road surface is slippery. ABS will vary the braking pressure to each wheel according to the amount of traction available. This prevents the wheels from locking and ensures that the vehicle stops as safely as possible.

**Note:** ABS operates only when control of the vehicle is jeopardized. It can not compensate for driver error.

## ABS warning indicator

When the key is turned to the ON position, and also at frequent intervals while driving, the ABS checks that all its components are operating correctly.



If a fault is detected, the warning indicator in the instrument panel flashes and the ABS shuts down. Contact Tesla Motors as soon as possible.

The vehicle's brakes remain fully operational and are not affected by an ABS failure. However, braking distances may increase and wheels may lock under heavy braking.

## Traction control

 **WARNING:** Traction control cannot overcome the physical limitations of the vehicle turning at too high a speed and cannot prevent any accident which may result.▲



The traction control system constantly monitors the difference in speed between the front and rear wheels. If a loss of traction is detected, it reduces torque to the rear wheels to minimize wheel spin. When this happens, you may notice the traction control warning indicator on the instrument panel illuminate briefly.

Traction control is automatically switched on each time the key is turned to the ON position. The traction control button on the center console illuminates amber to indicate the vehicle's traction control system is operating.

**Note:** For safety reasons, you can not drive without traction control when using cruise control. If you disable traction control, cruise control will also be disabled. Or, if you are

# Switches and controls

driving without traction control and then enable cruise control, traction control will automatically switch back on.

## Switching off traction control

If required, traction control can be manually switched off by pressing the switch on the center console. When the button is released, traction control will be disabled, the traction control button will be illuminated red and the warning indicator in the instrument panel will illuminate amber.

 The warning indicator in the instrument panel remains illuminated whenever the vehicle is operating without the advantages of traction control.

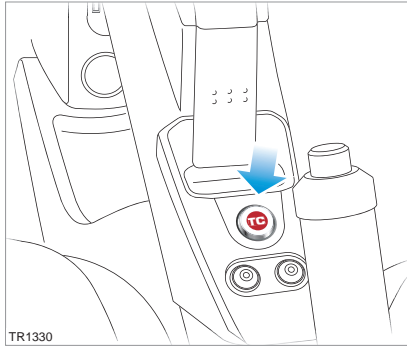

Under normal conditions, traction control should be left on. The system should only be switched off in circumstances where you deliberately want the wheels to slip. As soon

as the circumstances requiring you to switch traction control off have passed, press the switch to turn traction control back on.

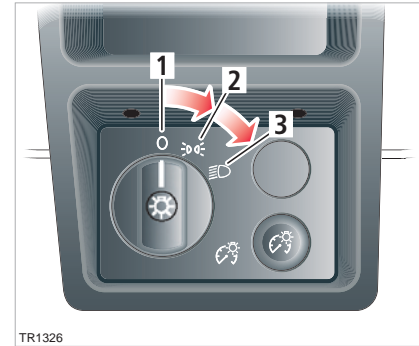

## Exterior lights

The exterior lights are controlled using a rotary switch mounted on the dashboard, below the Touch Screen.

The switch has three positions:

1. All exterior lighting and backlighting for instruments and switches is switched off.
2. Front and side lights, tail lights and license plate light are switched on. If the key is in the ACC or ON position, backlighting for instruments and switches is also switched on.
3. Headlights on.

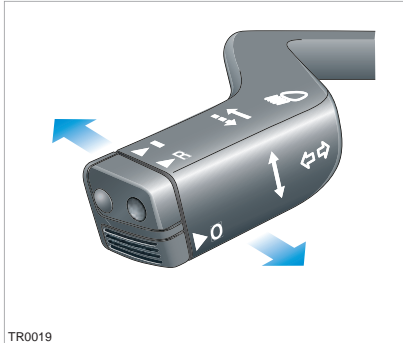

## Headlight high beam

Push the left-hand steering column lever away from you to select high beam. To cancel high beam, pull the lever towards you.



An indicator in the instrument panel illuminates when high beam is active.

**Note:** The high beams operate only when the exterior lights master switch is turned ON and the key is in either the ACC or ON position.

## Headlight high beam flash

High beams can be flashed by briefly pulling the steering column lever towards you and releasing.

## Exterior lights active period

The exterior lights will automatically extinguish if the key is removed from the starter switch. To keep the exterior lights on

after the key is removed, manually turn the exterior light switch to the OFF position and then back to the ON position.

## Lights on warning

If the exterior lights have been left on, an audible alert sounds when the driver's door is opened.

## Day time running lights

If regions that require the vehicle's lights to be left on even during the day (for example, Canada), the exterior lights will remain turned on whenever the key is in the ON position.

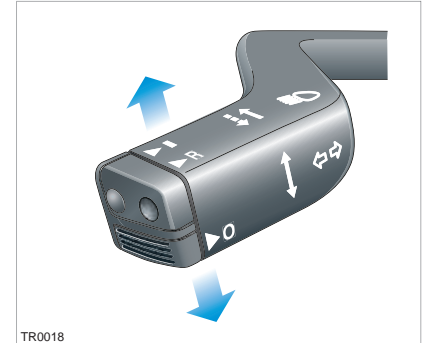

## Turn signals

Move the left-hand steering column lever down to operate the left turn signals or up to operate the right turn signals. The turn signals continue to operate until cancelled by the steering wheel or by returning the lever to its central position.



Indicators in the instrument panel illuminate green and flash to show which turn signals are operating. An audible ticking is also heard.

**Note:** The turn signals operate only when the key is in the ON position.

# Switches and controls

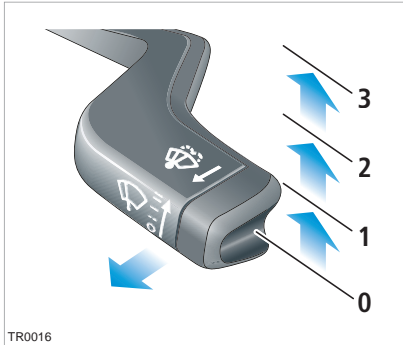

## Windshield wiper and washer



Operation of the windshield wiper and washer is controlled by the right-hand steering column lever. Move the lever to the following positions to operate:

- 0. OFF
- 1. Intermittent operation of wiper
- 2. Wiper operates at normal speed
- 3. Wiper operates at fast speed

**Note:** The windshield wiper and washer operate only if the key is in the ON position.

## Windshield washer

Pull the lever towards you to operate the windshield washer and wiper. The washer and wiper continue to operate as long as the lever is held in this position. When you release the lever, the wiper blade operates for six sweeps of the blade.

-  Caution: Do not operate the wiper on a dry windshield.
-  Caution: In freezing or very hot temperatures, ensure that the wiper blade is not frozen or adhered to the windshield before operating.
-  Caution: In winter, remove any snow or ice from the windshield, wiper arm and blade before operating.

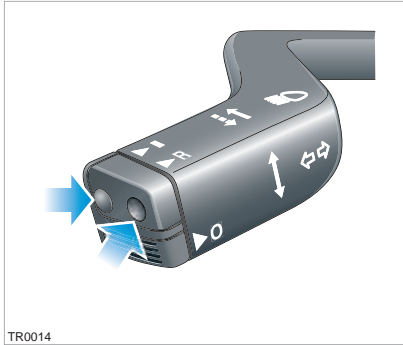

## Cruise control

**WARNING:** Only use cruise control when conditions are favorable, on straight, dry, open roads with light traffic.▲

The cruise control system allows you to maintain a selected vehicle speed above 30 mph, (48 kmh) without having to use the accelerator pedal.

**CRUISE** When cruise control is active, the warning indicator in the instrument panel illuminates.

### Operating cruise control

Operate cruise control using the following controls on the left-hand steering column lever:

▶O - OFF

▶I - initially sets the current speed.  
Subsequent presses increase the speed.

▶R - initially resumes a previously set speed. Subsequent presses reduce the speed.

### Setting the vehicle speed

To engage cruise control, the vehicle must be moving at least 30 mph (48 kmh). Once you have accelerated to your desired speed, press and release ▶I to set the speed at which the vehicle is currently traveling. Cruise control is engaged and the set speed will be maintained when you release your foot from the accelerator pedal. To actively disengage cruise control, press the ▶O button on the end of the control lever.

**Note:** Cruise control automatically disengages when you press the brake pedal, apply the hand brake, or when the vehicle's speed falls below 30 mph (48 kmh).

**Caution:** When you disengage cruise control, the vehicle decelerates rapidly.

### Changing the set speed

Accelerate or decelerate to the desired speed and then press and release ▶I to change the set speed.

- Press and release ▶I to increase the speed in 1 mph (1.6 kmh) increments or press and hold until the desired speed is reached.
- Press and release ▶R to reduce the speed in 1 mph (1.6 kmh) increments or press and hold until the desired speed is reached. Pressing ▶R when the vehicle is at, or below, 31 mph (50 kmh) cancels cruise control.

Alternatively, use the rocker switch to increase (▶I) or reduce (▶R) speed when cruise control is active.

You can press the accelerator pedal to exceed the set speed. Then, on releasing the pedal, the vehicle will decelerate until the set speed is reached.

### Resuming a set speed

**Caution:** The resume function should only be used if you are aware of the set speed and want to return to it.

Press ▶R to accelerate to the previously set speed. This function will not operate if the previously set speed is zero or if cruise control is already operating.

The set speed is reset to zero when:

1. The key is turned to the OFF position.
2. Reverse gear is selected.
3. The hand brake is applied.
4. The vehicle speed is below 1 mph (1.6 kmh).

# Switches and controls

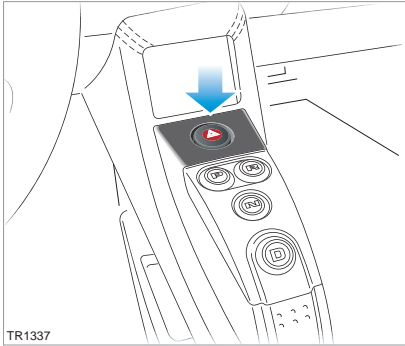

## Hazard warning

The hazard warning switch is located in the center console and operates even when the key is not in the starter switch.

Press to operate. All turn signals will flash and the turn signal indicators on the instrument panel will also flash.

**Note:** Only use hazard warning lights in an emergency to warn other road users of a breakdown or other potential danger. Remember to switch off when the hazardous situation has been resolved.



## Horn

Press either of the two horn symbols embossed on the steering wheel to sound the horn.





TR1315

## Instrument panel components

1. Speedometer (mph)/tachometer (rpm)
2. Power meter
3. LCD panel
4. Warning indicators

## Power meter

The power meter displays the amount of power currently entering or leaving the Battery.

## LCD panel

The Liquid Crystal Display (LCD) panel in the instrument panel operates whenever the key is in the ON position. The LCD displays three types of information.

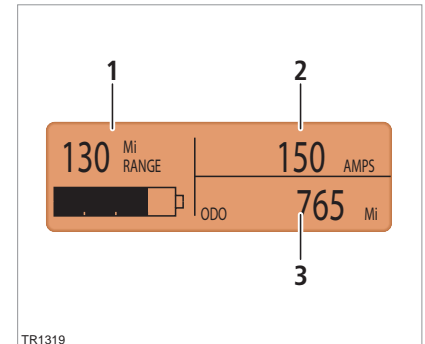

TR1319

1. Range and charge level
2. Current
3. Odometer/trip display

Using the Touch Screen, you can set this panel to display either miles or kilometers. For details, refer to the Touch Screen Uses Manual provided in your owners package.

## Range and Charge level

The left side of the LCD panel **1** displays the remaining range and charge level.

# Instruments

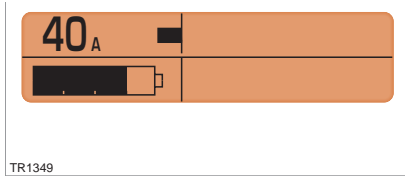

TR1349

The size of the filled region within the battery icon provides a visual indicator of the amount of charge remaining in the Battery.

## Current

The number at the top right of the LCD **2** indicates the amount of current (in amps) entering or exiting the Battery.

## Odometer and trip display

This portion of the LCD display **3** can display either odometer or trip display information. To toggle back and forth between these two types of information, press the button located on the right-hand side of the steering column:

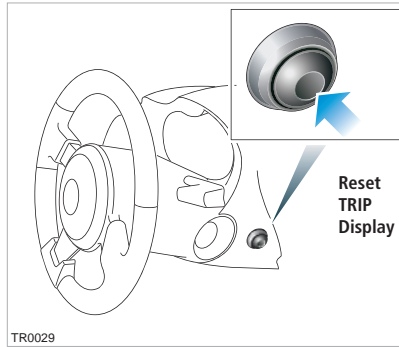

- The TRIP display shows the miles traveled since the trip display was last reset. To reset the trip display to zero, press and hold the button on the side of the steering column for about one second.

**Note:** The TRIP display can also be viewed and reset using the Touch Screen's Drive screen called "Trip". Resetting the TRIP display using the button on the steering column resets the trip display on the Touch Screen, and vice versa.

- The ODO display shows the total miles traveled by the vehicle in its lifetime.

If the key is off, pressing the TRIP button temporarily illuminates the instrument panel to show the ODO display.

## Warning indicators

The following warning indicators light up for approximately four seconds when you turn the key to the ON position. They will then extinguish (unless the indicator is applicable to the current situation) and the gear buttons on the center console will light up, indicating the vehicle is ready to be driven.



Turn signals. Flashes green to indicate which turn signal is operating. Both indicators will flash green when the hazard warning lights are operating. If a turn signal indicator flashes quickly or irregularly, you may need to replace the associated turn signal bulb.



Seat belt warning. Illuminates red when the driver's seat belt is unbuckled and the key is in the ON position. Also, an audible sound will be heard for six seconds if the key is turned to the ON position and the driver's seat belt is unbuckled. If the car is driven more than a tenth of a mile (.16 km) with the driver's seat belt unbuckled, you'll hear an additional warning tone.





Regenerative braking off. Regenerative braking has been disabled temporarily. This occurs when the battery has been topped up to its maximum level and can not accept additional charging. For example, the Battery is full after being charged using the Range setting. It can also occur if the Battery has reached extremely high temperature or if a fault has occurred.





Power Limit. Illuminates amber when the vehicle's power is being limited. This could possibly be caused by overheating

of a component, or if the charge level of the Battery falls below 20%. Power will be restored automatically when conditions are appropriate.

 Rear fog lamp indicator. Illuminates yellow when the rear fog lamp is turned on. Although this indicator is briefly displayed upon start-up, it is not used in the North American version of the vehicle.

 High beam. Illuminates blue when the headlight high beams are selected.

 Charge indicator. Flashes amber when the vehicle is charging.

 Charge indicator. Illuminates red when the charging port door is open and the vehicle is not charging.

 Traction control disabled. Illuminates when the traction control has been manually disabled and will illuminate briefly in situations where traction control is in use.

 Security on. Flashes red when the vehicle is locked and the security system is enabled.

 Security off. Illuminates green when the vehicle is locked but the security system is not enabled. Occurs when the doors are locked and you are driving, or if the doors have been locked from inside the vehicle.

 Cruise control. Illuminates green when the cruise control system is operating.

 Brake indicator 1. Illuminates red when the hand brake is applied. If the indicator illuminates at any other time, a fault with the brake system has been detected or the brake fluid level is low.

 **WARNING:** Driving the vehicle with the brake indicator illuminated could result in fatal or serious injury. Stop the vehicle as soon as safety permits and rectify the problem immediately.▲

 Frost warning. Illuminates amber when the temperature outside the vehicle falls below 37° F (3° C). Extinguishes when the temperature rises again to exceed 41° F (5° C).

 Airbag warning. Illuminates red during the system check that occurs when the key is turned to the ON position. This indicator should extinguish within approximately six seconds. If the light fails to illuminate, or fails to extinguish after six seconds, a safety-related fault has occurred and you must contact Tesla Motors.

 **Warning:** If the airbag indicator is illuminated, the airbag system will be deactivated. Contact Tesla Motors immediately. In the event of an accident the airbags may not inflate.▲

 Traction control. Illuminates amber briefly in situations where traction control is in use.

 Brake indicator 2. Illuminates when the hand brake is applied (in addition to the *BRAKE* indicator located directly above it).

 ABS indicator. Illuminates when an ABS fault is detected.

 **FAULT** Non-critical fault. Illuminates amber when a non-critical fault is detected. The Touch Screen will display a message describing the fault. Contact Tesla Motors.

 **FAULT** Critical fault. Illuminates red when a critical fault is detected. This is usually accompanied by the inability to drive the vehicle and a shutdown of all electrical systems. The Touch Screen will display a message describing the fault. Stop the vehicle as soon as it is safe to do so, and contact Tesla Motors immediately.

 Tire pressure indicator. Illuminates amber when the pressure of a tire is out of range. If a fault with the Tire Pressure Monitoring System (TPMS) is detected, the warning indicator flashes. Check the Touch Screen for more information.

# Instruments

---

## Instrument panel lighting



The control for the instrument panel lighting is located on the left-hand side of the dashboard. When instrument panel lighting is turned on using the adjacent switch, you can adjust the amount of backlighting on the instrument panel, the Touch Screen, and the center console by turning this knob clockwise to increase the backlighting and counter-clockwise to decrease the backlighting.

# Comfort and convenience

---

<b>Power windows</b>	
Driver's door window controls	7-2
Operating the windows	7-2
<b>Rear view mirrors</b>	
Exterior rear view mirrors	7-3
Interior rear view mirror	7-3
<b>Interior temperature control</b>	
General information	7-4
Control panel	7-4
Operating the system	7-4
Ventilation	7-5
Windshield defrosting	7-5
Seat heaters	7-5
<b>Interior accessories</b>	
Interior light	7-6
Sun visors	7-6
Accessory power socket	7-6
USB Port	7-6
Cup holder	7-7
<b>Removable roof</b>	
Hard-top and soft-top	7-8
Installing the soft-top	7-9
Removing the soft-top	7-10
Installing the hard-top	7-12
Removing the hard-top	7-13
<b>HomeLink®</b>	
HomeLink® Universal Transceiver	7-14

# Power windows

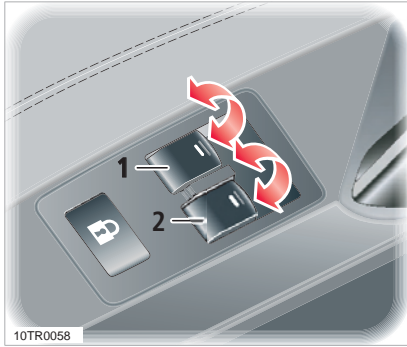

## Driver's door window controls

The windows can be operated whenever the key is in the ACC or ON positions:

1. Driver's window
2. Passenger window

**Note:** The passenger window can also be operated using the switch on the passenger door.

## Operating the windows

**!** **WARNING:** Closing power windows on fingers, hands or other vulnerable parts of the body may result in serious injury. Ensure that your passenger is familiar with the window controls and aware of the potential dangers.▲

**!** **WARNING:** To prevent the risk of injury, always remove the key if a child is to be left unattended in the vehicle.▲

**!** **WARNING:** Never leave a child or an animal unattended in the vehicle with the windows closed and the roof fitted. In hot weather conditions they could succumb to heat exhaustion and experience serious bodily injury or death.▲

Both windows are equipped with a one-touch opening switch. To lower a window, briefly press the switch down and release. The window will continue to lower until fully open. Pressing the switch again, while it is lowering, will stop the window.

To raise a window, pull the switch and hold until the window is fully raised.

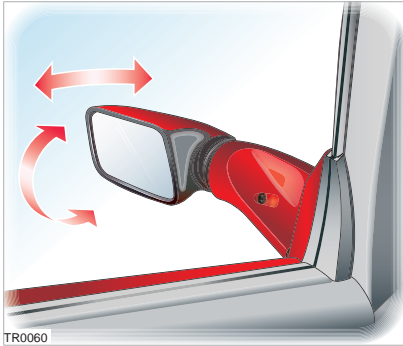

## Exterior rear view mirrors

**!** **WARNING:** The passenger side exterior mirror is fitted with a convex lens to improve the field of vision and reduce possible blind spots. Convex mirrors can make objects appear smaller and further away than a regular flat mirror. Always double-check the speed and position of vehicles around you, by looking in the interior mirror and over your shoulder, before changing lanes.▲

Adjust the position of the exterior mirrors by manually moving them to the desired position when seated in a correctly adjusted driver's seat. To adjust the mirror on the passenger side of the vehicle, it is helpful to get assistance from another person.

Adjust the position of the mirrors to give the best view of the road behind and to each side of the vehicle, while maintaining a view of part of the vehicle for reference.

## Mirror folding

The exterior mirrors are spring-loaded to reduce any possible damage in the event of accidental contact.

**!** **Caution:** The mirrors are not designed to be folded flat against the vehicle.

## Interior rear view mirror

The interior mirror can be manually dipped to reduce glare from a following vehicle's headlights.

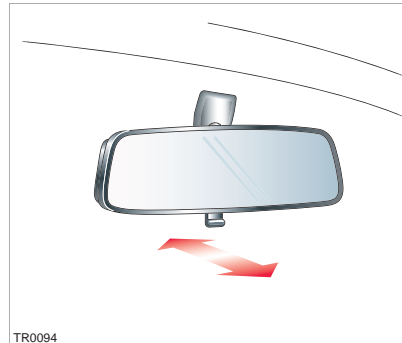

Push the lever on the underside of the mirror to dip the mirror. Pull the lever to restore normal visibility.

**!** **Caution:** Take care when using the mirror in the dipped position, the reflected view may distort the position of a following vehicle.

# Interior temperature control

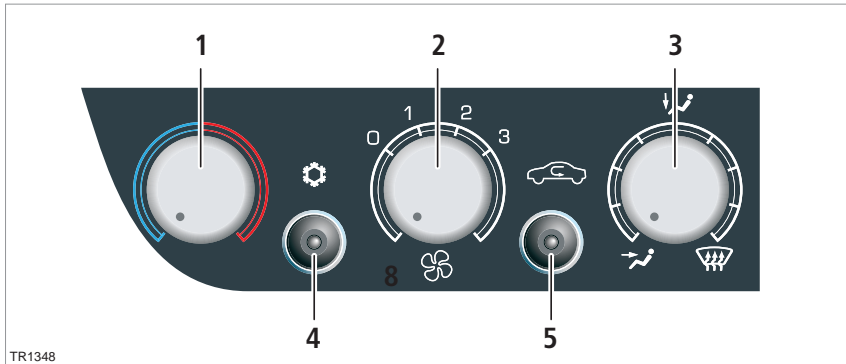

## General information

The temperature of the air inside the vehicle is controlled using the controls on the dashboard.

Heating is provided by a high voltage electric heater and cooling is provided by an all-electric air conditioning system. Both of these systems are located under the hood. In addition to cooling the cabin, the air conditioning system also cools the Battery.

## Control panel

1. Temperature
2. Fan
3. Air distribution
4. Air conditioning
5. Air recirculation

## Operating the system

**Note:** The fan, heating and air conditioning system are powered by the Battery. Prolonged use decreases the range of the vehicle.

### Temperature

Rotate the temperature control clockwise (warmer) or counterclockwise (cooler) to adjust the temperature of the air. The temperature of the air entering the vehicle changes only if the fan is operating.

### Fan

Rotate the fan control clockwise to increase fan speed. With the fan switched off, the amount of air entering the vehicle depends on your driving speed. To heat the vehicle, you must turn the fan on. To cool the vehicle, you must press the air conditioning button and turn the fan on.

## Air distribution

Rotate the air distribution control to change the location in which air enters the interior of the vehicle.



To allow air to flow from more than one vent location, position the control between two locations.

## Air conditioning

To cool the air inside the vehicle, turn the fan on, then press the air conditioning button. The button illuminates blue to indicate the system is operating. Rotate the temperature control to achieve the desired air temperature. To turn off, press the air conditioning button again.

## Air recirculation

Press the air recirculation button to recirculate the air inside the vehicle. The button will illuminate amber to indicate that air is being recirculated. Press again to switch off.

When air recirculation is operating, and the soft-top or hard-top is installed, 90% of the air inside the vehicle is recirculated, instead of being drawn from outside the vehicle. You can use this to prevent fumes from entering the vehicle or to effectively maintain a constant interior temperature.



**Note:** It is recommended that you switch off air recirculation for a short period each hour to refresh the air inside the vehicle, and to help prevent the windshield from fogging.

## Ventilation

Air is drawn into the ventilation system through the grill at the front of the vehicle. Keep the grill clear of obstructions (leaves, snow, etc.).

Press the thumb depression to open the vents and rotate to direct the air. You can adjust the vents closest to each door to direct air onto the side windows.

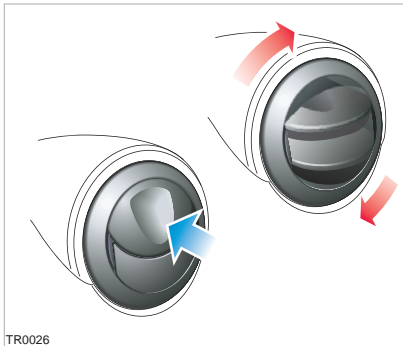

TR0026

**Note:** When you open the face level vents, airflow to the foot and windshield vents is reduced.

## Windshield defrosting

For maximum efficiency when removing frost or mist from your windshield, set the controls as follows:

- Rotate the air distribution control to windshield.
- Rotate the fan control fully clockwise.
- Switch on the air conditioning.
- Rotate the heating control for maximum heat.

When the windshield has fully cleared, adjust the controls as required.

## Seat heaters

The seat heaters operate only when the key is in the ACC or ON position.

**Note:** The seat heaters must be reselected each time the key is turned to the ON position.

Press the respective button to operate the required seat heater. The seat heaters can be operated at two different levels:

- Press once to operate at a high level. The switch indicator will illuminate amber.
- Press again to operate at low level. The switch indicator will illuminate green.
- Press again to switch off.

The seat heaters are thermostatically controlled to maintain a constant temperature. The indicator in the switch



TR1329

remains illuminated until either the seat heater is manually turned off or the key is turned to the OFF position.

**Note:** Although the seat heaters consume energy from the Battery, they require less energy than the interior heating system.

# Interior accessories

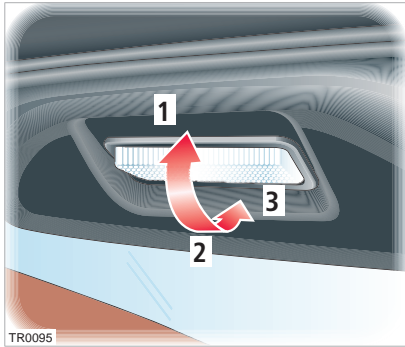

## Interior light

The interior light is located on the rear header rail. The light has three positions:

1. Light on.
2. Automatic operation. The light illuminates whenever the vehicle is unlocked or if a door is opened. The light turns off 30 seconds after the door is closed or when the key is turned to the ON position.
3. Light off. The light does not illuminate when a door is opened.

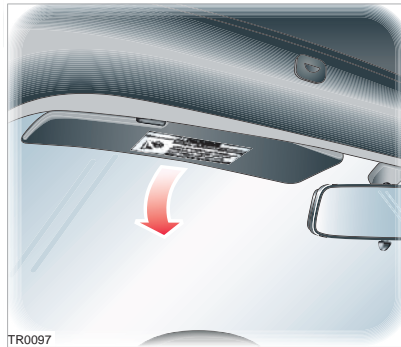

## Sun visors

To help reduce the glare from the sun, visors are provided for both the driver and passenger. Pull the visor down (towards you) when required.

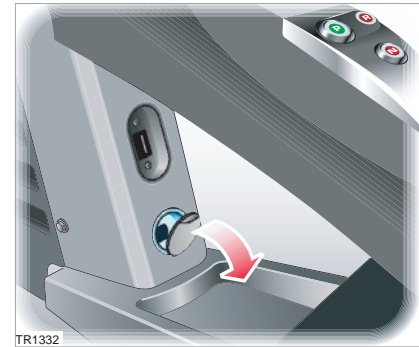

## Accessory power socket

The accessory socket has a hinged cover to prevent dirt from getting into the socket when not in use.

Power from the socket is available whenever the key is in the ACC or ON positions.

**Note:** The power socket is suitable for accessories requiring up to 10A or a maximum of 125 watts.

## USB Port

The USB port, located directly above the power socket, is for service use only. It is used to download your vehicle log file so you can send it to Tesla Motors, as requested by a Tesla service technician. This port is not designed to be used for personal devices such as an iPod®.

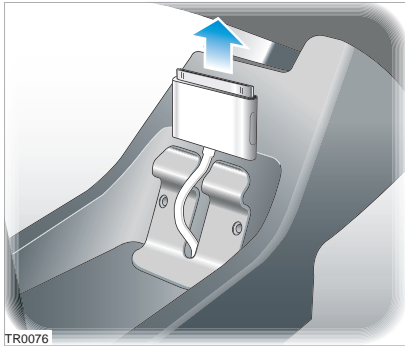

TR0076

### iPod® connector

The iPod® connector is used to connect your iPod® to the audio system and recharge it while in use. The connector is located below the center console, near the accessory power socket.

Release the connector from the retaining clip and withdraw the cable from the console. Connect your iPod® and select Aux on the audio system.

For details on how to use the audio system, refer to the audio system documentation.

**!** Caution: To prevent the connector from being damaged when not in use, return it to the retaining clip and ensure the cable is fully retracted.

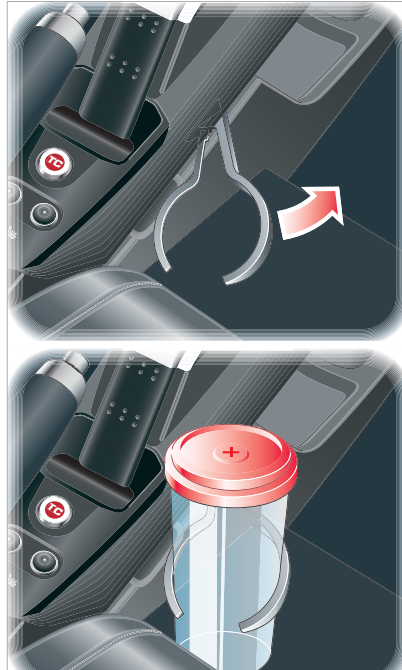

### Cup holder

**!** WARNING: Do not carry open drink containers. A spilled hot drink could cause personal injury as well as damage to upholstery, carpeting and electrical systems.▲

Pull the cup holder from the side of the center console to use. The fingers of the cup holder are spring-loaded to hold the cup securely. Open the fingers and insert the cup. The base of the cup should rest on the floor.

**!** Caution: After use, return the cup holder to the center console to prevent it being broken when occupants are entering or leaving the passenger side of the vehicle.

# Removable roof

---

## Hard-top and soft-top

In the Tesla Roadster, you can enjoy exposure to the natural environment and drive without the confinement of a cockpit roof. To provide weather protection in unfavorable conditions, you have the choice of installing either the soft-top or hard-top roof.

The Tesla Roadster is designed to accommodate changing loads and strains that constantly occur while driving. It also accommodates the tolerances needed to allow repeated removal and installation of the roof. As a result, wind noise and minor water leaks can occur and are considered normal.



**WARNING:** Never attempt to install or remove the soft-top or hard-top while the vehicle is moving.▲

Instructions for installing and removing the soft-top and hard-top are provided on the following pages.

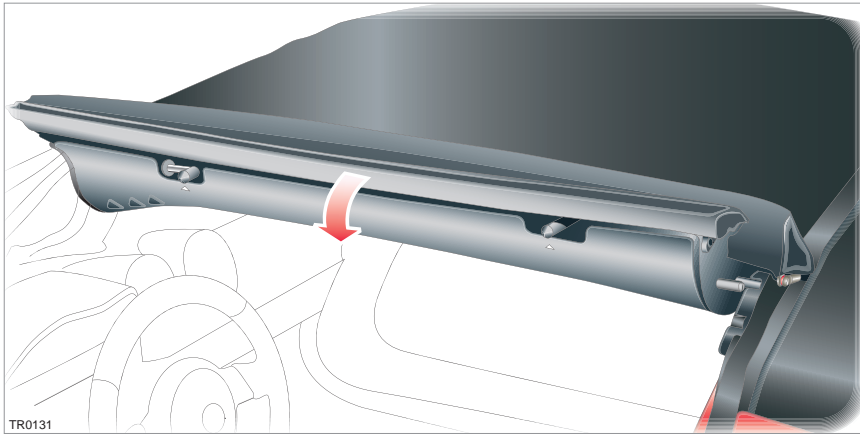

## Installing the soft-top

**⚠ WARNING:** Never attempt to install the soft-top while the vehicle is moving. This could cause an accident in which you or others may be seriously injured or killed.▲

Open both doors. Remove the soft-top and support stays from the bag.

**Note:** The support stays and the side rails of the soft-top assembly have arrows on them which should point to the front of the vehicle when installing.

1. Fit the two support stays between the header rails. The support stays need to be flexed to enable them to fit into the slots in the header rails.

2. Inspect the channels in the header rails and remove any debris (such as leaves) that may have accumulated.
3. Position the soft-top across the space between the two support stays. Ensure that the arrows molded on the side rails are pointing to the front of the vehicle.
4. Standing at the drivers side, unroll the soft-top. Starting at the drivers side minimizes potential damage to the roof seals.
5. Position the side rail so that the black locating pins are located in the uppermost slots on the front and rear header rails.

6. Ensure that the front and rear edges of the soft-top are correctly located in the channels on the header rails.
7. Rotate the side rail downwards until the side rail locking pins are correctly located in the lower slots and you can hear them 'click' into place.
8. Check that both locking pins are correctly engaged by attempting to rotate the side rail upwards.
9. Repeat steps 5 through 8 for the passenger side of the soft-top. You may need to pull on the side rail to engage the locating pins on the header rails.
10. Inspect the fitted soft-top to ensure that the front and rear edges are correctly located in the channels on the header rails. Incorrect fitment can result in damaged seals and water leakage.

**⚠ WARNING:** Before driving, check that both side rails are securely fitted. An incorrectly fitted or unsecured soft-top could result in an accident which could lead to serious injury or even death.▲

**Note:** Tesla Motors has set your windows to accommodate either the hard-top or the soft-top. To prevent water from entering the cabin when using the alternate type of roof, you will need to have Tesla Motors adjust your windows.

# Removable roof

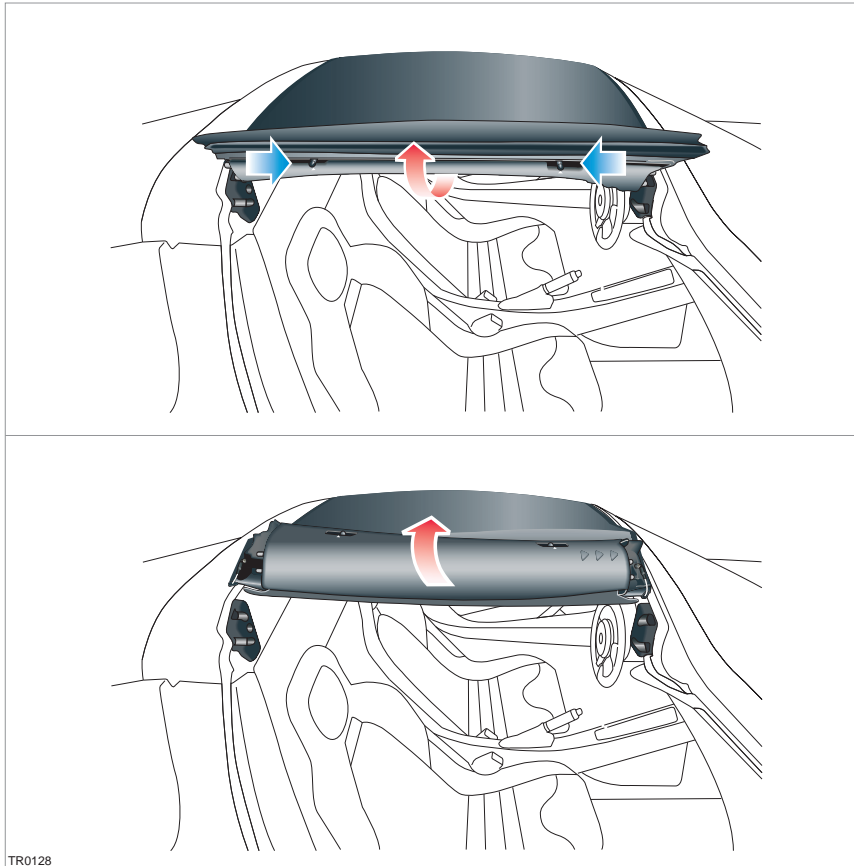

## Removing the soft-top

**WARNING:** Never attempt to remove the soft-top while the vehicle is moving. This could cause an accident in which you or others may be seriously injured or killed.▲

**Caution:** It is recommended that you release the side towards the front of the vehicle first to prevent the adjusters for the tensioning cables from damaging the seals.

1. With the vehicle stationary, open doors.
2. Locate the two release levers on the inside face of the side rail.
3. Press both levers inwards to release the side rail locking pins and rotate the rail upwards. You may need to push down on the side rail while pressing the levers.
4. Lift the side rail to disengage the two locating pins from the front and rear header rails.
5. Release the front and rear edges of the soft-top from the channels in the header rails and then roll the soft-top towards the center of the vehicle.
6. Repeat the above steps for the other side.
7. Remove the soft-top from the vehicle and store in the soft-top bag.
8. Remove the two soft-top support stays from the vehicle. Flex the ends of the stays inwards to release them.
9. Store the soft-top support stays in the bag with the soft-top.

**Note:** If the soft-top is damp when removed, it is recommended that it is unrolled or refitted at the soonest opportunity to allow it to dry completely. Prolonged storage of a damp soft-top can cause damage.

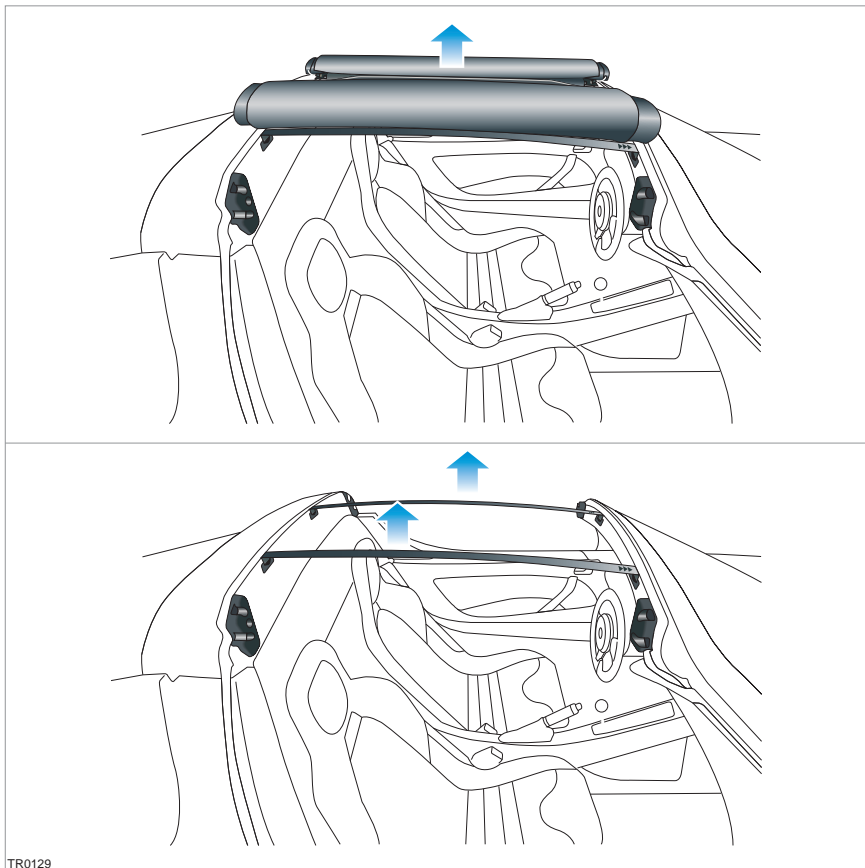

TR0129

# Removable roof

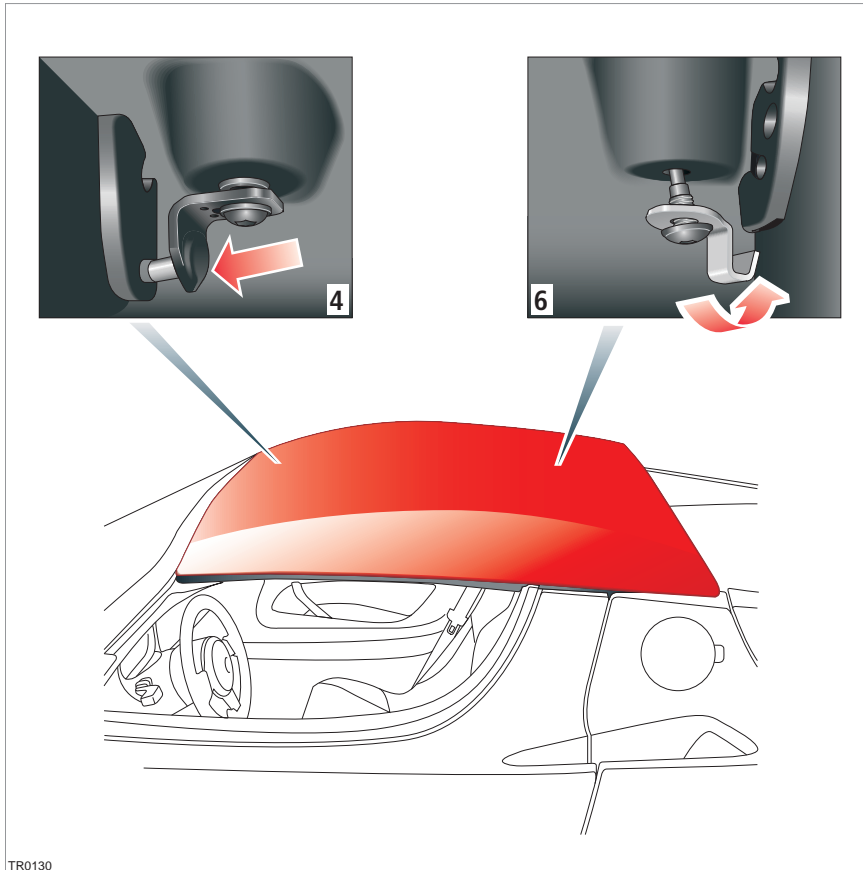

## Installing the hard-top

The hard-top has been designed to provide a seasonal alternative to the standard soft-top. To ensure proper installation, Tesla recommends that the hard-top be installed by a Tesla service technician.

**WARNING:** The mounting bracket bolts securing the hard-top to the vehicle should be routinely checked and tightened. An incorrectly fitted or unsecured hard-top could result in an accident.▲

**WARNING:** Avoid getting hands or fingers trapped when installing or removing the hard-top.▲

Use only the Torx® tool supplied in the toolkit to tighten or release the hard-top's bolts.

When storing the hard-top, care should be taken to avoid damaging its corners. If the hard-top must be stood on its end, use a suitable soft floor covering.

**Note:** Because of its size, the hard-top should only be removed or installed when a second person is available to assist.

1. If necessary, remove the soft-top. For instructions, see Removing the soft-top, page 7-10.
2. Open both doors.
3. With the aid of an assistant, lift the hard-top into position on the vehicle
4. Tilt the front of the hard-top to engage the locating pins into the lower most slots on the header rail. If necessary, loosen the locating pin bolts to ensure that the pins engage correctly on the header rail.



5. Push the hard-top into position on the front header rail and then lower the hard-top's rear edge.
6. Engage the hook on the rear mounting brackets with the fixings on the rear header rail.
7. Use the Torx® tool supplied in the toolkit to tighten the bolts just enough to keep the rear brackets engaged. Do not fully tighten.
8. Ensure the hard-top is correctly aligned on the vehicle.
9. Holding the rear mounting brackets to prevent them from twisting, tighten the bolts to secure the hard-top in place. Do not overtighten.
10. Check and tighten the bolts securing the front locating pins to the hard-top.

**WARNING:** Make sure that the **!** hard-top is securely fitted by trying to lift each corner in turn. If any movement is evident, check and tighten the hard-top fixings. Driving with a loose or incorrectly secured hard-top could result in an accident which could lead to serious injury and even death. **▲**

11. Check that both doors shut correctly with the windows in the fully raised position.
12. Position the front header rail trim panel and align the bolts to the holes in the hard-top, starting with the bolt in the center.

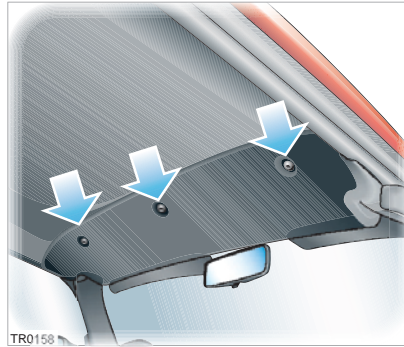

13. Starting with the bolt in the center, tighten the three bolts to secure the trim panel. Do not overtighten.

**WARNING:** Do not drive the vehicle **!** with the trim panel removed. In a collision, injury could result from contact with the brackets. **▲**

14. Return the Torx tool to the tool kit.

**Note:** Tesla Motors has set your windows to accommodate either the hard-top or the soft-top. To prevent water from entering the cabin when using the alternate type of roof, you will need to have Tesla Motors adjust your windows.

## Removing the hard-top

1. Open both doors.
2. Using the Torx tool supplied in the toolkit, loosen the three bolts securing the header rail trim panel to the hard-top.
3. Remove the trim panel.
4. Loosen the two bolts securing the rear of the hard-top to the vehicle.
5. Disengage the brackets from the rear header rail.
6. With the aid of an assistant, lift the rear edge of the hard-top and slide it towards the rear of the vehicle to disengage the front locating pins.
7. Store the hard-top in a safe place where it will not get damaged. If the hard-top must be stood vertically, use a suitable soft floor covering to protect its corners.
8. Return the Torx tool to the tool kit.

## HomeLink® Universal Transceiver

Your vehicle is equipped with a HomeLink® Universal Transceiver that you can use to operate most Radio Frequency (RF) devices such as garage doors, gates, lights and security systems. Your transceiver can be programmed using the Touch Screen to operate up to three individual devices. Devices can be operated by touching a button on the Touch Screen. You can also set up the third button on the key fob to operate a device. For details on how to program HomeLink, refer to the Touch Screen Users Manual, provided in your owners package.

For security purposes, when you sell your vehicle, you should erase your HomeLink settings.

 **WARNING:** Do not use the HomeLink Universal Transceiver with any garage door opener that lacks safety stop and reverse features as required by federal safety standards. A garage door opener which cannot detect an object in the path of a closing garage door and then automatically stop and reverse, does not meet current federal safety standards. Using a garage door opener without these features increases the risk of injury or death.▲

 Your vehicle should be turned off while programming the HomeLink Universal Transceiver.▲

 During programming, your garage door or gate may open or close. Make sure that people and objects are clear of the garage door or gate that you are programming.▲

### FCC Compliance

This device complies with Part 15 of the FCC rules and IC-RSS-210 Industry Canada. Operation is subject to the following conditions:

- This device may not cause harmful interference.
- This device must accept any interference received, including interference that may cause undesired operation.

Any changes or modifications to the device not expressly approved by the manufacturer or Tesla Motors could void the user's authority to operate the equipment.

# Maintenance and care

---

## **Maintenance**

General information	8-2
Routine maintenance	8-2
Owner maintenance	8-2
Opening the hood	8-3
Closing the hood	8-4

## **Fluid reservoirs**

Fluid reservoir locations	8-5
Brake fluid	8-5
Windshield washer fluid	8-6
Battery coolant	8-6

## **Windshield wiper and washer**

Checking the wiper blade	8-7
Replacing the wiper blade	8-7
Windshield washer jets	8-7

## **Cleaning and vehicle care**

Environmental precautions	8-8
Cleaning the vehicle exterior	8-8
Polishing the body	8-9
Using a car cover	8-9
Paint damage and rectification	8-9
Cleaning the vehicle interior	8-9

# Maintenance

## General information

Regular maintenance is the key to ensuring the continued reliability and efficiency of your vehicle.

Maintenance is the owner's responsibility and you must ensure that the appropriate maintenance is carried out when required and according to the recommendations specified by Tesla Motors.

## Routine maintenance

Take your vehicle to Tesla Motors at the regularly scheduled maintenance intervals of every 12 months, or every 12,000 miles (20,000 kms), whichever comes first.

Maintenance and service must be performed by Tesla-certified technicians. Damages or failures caused by maintenance or repairs performed by non-Tesla certified technicians are not covered under the New Vehicle Limited Warranty.



### Service interval indicator

When the key is inserted and turned to the ACC position, the Touch Screen momentarily displays how many miles you can drive before the vehicle is due for servicing.

This information can also be displayed by Touching the Info button on the Touch Screen's main Parked screen (which is displayed whenever the hand brake is engaged). For details, refer to the Touch Screen Users Manual provided in your owners package.

## Owner maintenance

**WARNING:** Any significant or sudden drop in fluid levels, or uneven tire wear should be rectified immediately.▲

In addition to the routine maintenance performed by Tesla Motors, a few simple checks must be carried out more frequently. Details are provided in the remainder of this section.

### Daily checks

- Check that all lights, horn, turn indicators, wipers, washers and warning indicators operate
- Check that seat belts and brakes operate
- Check for fluid deposits underneath the vehicle that might indicate a leak

### Weekly checks

- Check brake fluid level. Refer to Brake fluid, page 10-4.
- Check windshield washer fluid level. Refer to Windshield washer fluid, page 10-5.
- Check battery coolant. Refer to Battery coolant, page 10-5.
- Check condition and pressure of each tire. Refer to Wheels and tires, page 10-4.
- Check operation of the air conditioning system. Refer to Interior temperature control, page 7-4.

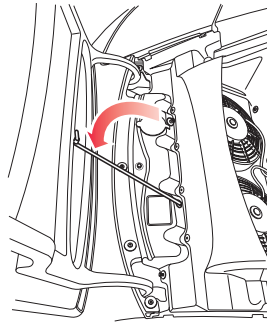
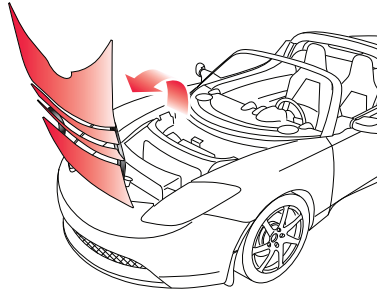
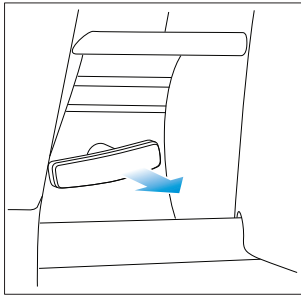

## Opening the hood

**!** Never work on a vehicle that is plugged in. Always remember to unplug the vehicle before working under the hood or the underside of the vehicle.▲

**!** **WARNING:** Make sure that the hood is in the fully open position before working in the area under the hood. In windy conditions, you may need to secure the hood stay to prevent the hood from being closed by the wind.▲

1. Pull the hood release handle located to the left of the steering column.
2. Raise the hood.
3. Insert the hood stay into the slot.

TR1352

# Maintenance

---

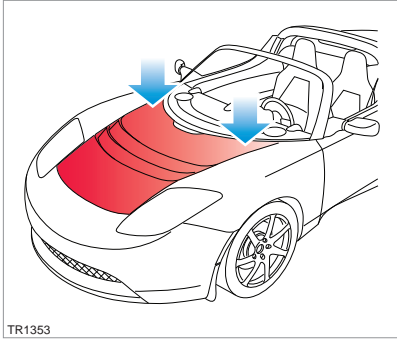

## Closing the hood

Return the hood stay to its original position and lower the hood to the closed position. Press down firmly on each side of the hood (see illustration) to engage the locks. You can hear the locks 'click' into place.

 Caution: Before driving, check that the locks on both sides of the hood are fully engaged by attempting to lift the hood. There should be no movement.

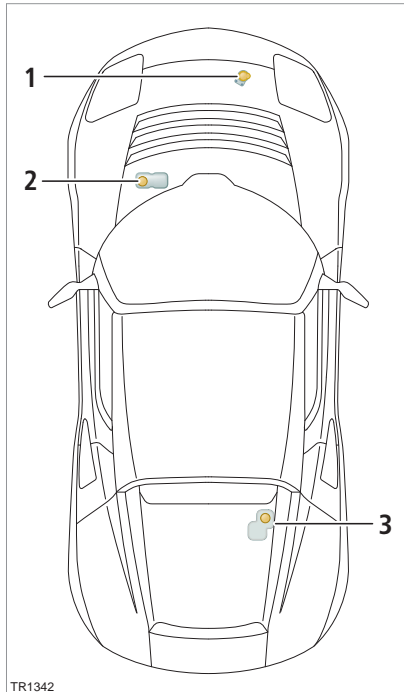

TR1342

## Fluid reservoir locations

1. Windshield washer fluid
2. Brake fluid
3. Battery coolant

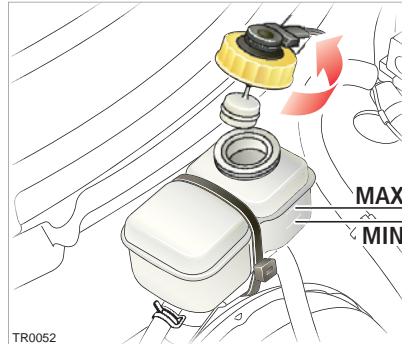

TR0052

## Brake fluid

**!** **WARNING:** Seek qualified assistance immediately if the movement of the brake pedal has increased, or if there is a significant loss of brake fluid. Driving under such conditions could result in extended stopping distances or complete brake failure.▲

## Fluid level check

Check the brake fluid level weekly with the vehicle on level ground. The fluid level can be checked visually through the side of the reservoir without removing the filler cap.

The brake fluid level should be between the MIN and the MAX marks.

## Topping up the fluid

**!** **WARNING:** Brake fluid is highly toxic. Keep containers sealed and out of the reach of children. In the event of accidental consumption, seek medical attention immediately.▲

1. Clean the filler cap before removing to prevent dirt from entering the reservoir.
2. Unscrew the cap and remove.
3. Top-up the reservoir to the MAX mark using brake fluid meeting DOT4 specification.
4. Replace the reservoir cap.

**!** **Caution:** Brake fluid will damage painted surfaces. Immediately soak up any spills with an absorbent cloth and wash the area with a mixture of vehicle shampoo and water.

**!** **Caution:** Only use new fluid from an air-tight container. Do not use fluid from previously opened containers or fluid that has been previously bled from the system. This fluid has absorbed moisture and will decrease braking performance.

# Fluid reservoirs

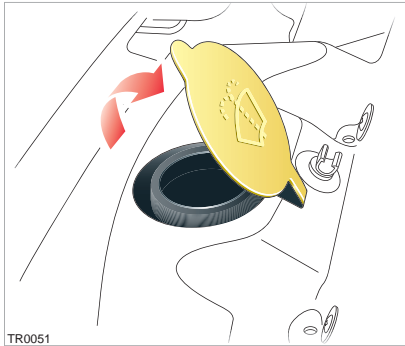

## Windshield washer fluid

To ensure proper cleaning of the windshield and to prevent freezing in cold weather, check the reservoir level weekly. If needed, top up with windshield washer fluid.

**⚠ Caution:** Always follow the directions provided by the windshield washer fluid manufacturer. If the windshield washer fluid requires dilution, carefully follow the manufacturer's directions and mix the recommended quantities of water and windshield washer fluid in a separate container before topping up the reservoir. Undiluted windshield washer fluid can discolor the vehicle's paint.

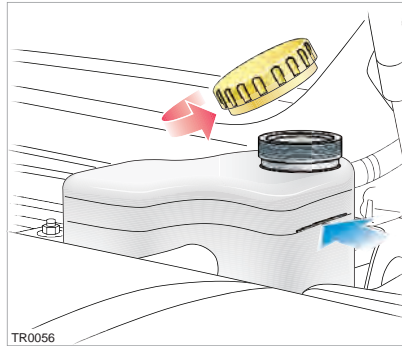

## Battery coolant

### Fluid level check

Check the fluid level weekly with the vehicle on level ground and when the vehicle is cool. The fluid level can be checked visually through the side of the reservoir without removing the filler cap. The fluid level should be between the MIN and the MAX marks.

If the level drops significantly, a leak may exist. Contact Tesla Motors before using the vehicle.

## Topping up the coolant

**♻** The cooling system for your vehicle contains a propylene glycol (PG) based antifreeze. Compared to conventional ethylene glycol based antifreezes, propylene glycol is less toxic, safer for children, pets and wildlife, and safer for the environment.

Top-up to the MAX mark with one of the following recommended solutions:

- a 50/50 mix of water and Havoline® Extended Life Antifreeze Coolant-PG
- pre-mixed Sierra Antifreeze Coolant-PG, or a 50/50 mix of water and full-strength Sierra Antifreeze Coolant-PG

**⚠ Caution:** Do not mix with any other type of antifreeze! In an emergency, top up with distilled water only and be aware of the reduced frost and corrosion protection.

Antifreeze contains important corrosion inhibitors. Maintain the antifreeze content of the coolant between 50% and 60% year round. Do not exceed 60% or cooling efficiency will be impaired.

Ensure cap is replaced and fully tightened after topping up.

**Note:** Change coolant every four years, regardless of mileage.



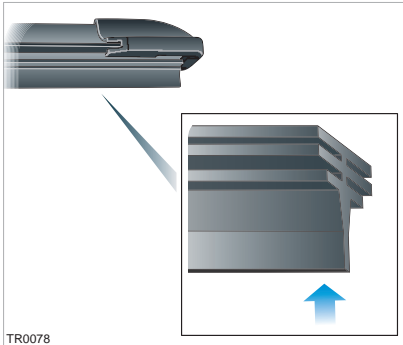

## Checking the wiper blade

Periodically check and clean the wiping edge of the wiper blade.

Check the blade rubber for cracks, splits and roughness. If any damage, wear or roughness is detected, replace immediately to prevent damage to the glass.

Clean the blade edge by wiping with a soft cloth or sponge, using warm soapy water.

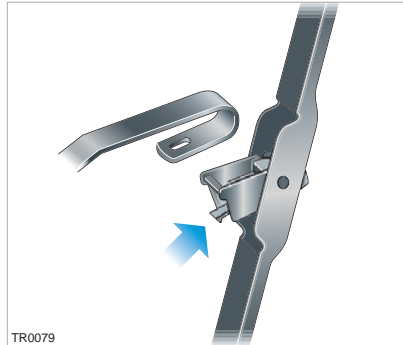

## Replacing the wiper blade

Install only a replacement wiper blade that is identical to the original specification.

1. Lift the wiper arm away from the windshield.
2. Turn the blade at right angles to the arm.
3. Depress the locking tab while sliding the blade down the arm.

To install the new blade, position the new assembly on the wiper arm and slide the blade towards the hooked end of the arm until it locks into place.

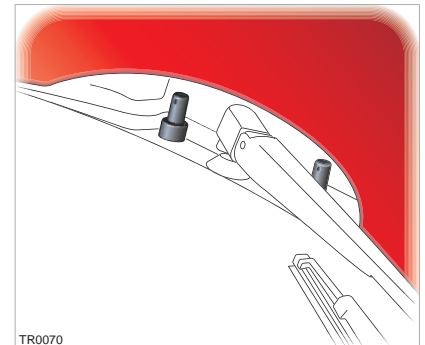

## Windshield washer jets

Washer jets are set when your vehicle is manufactured and should not need adjusting.

If necessary, use a needle to clear blockages, or lever gently to redirect the spray towards the center of the windshield.

# Cleaning and vehicle care

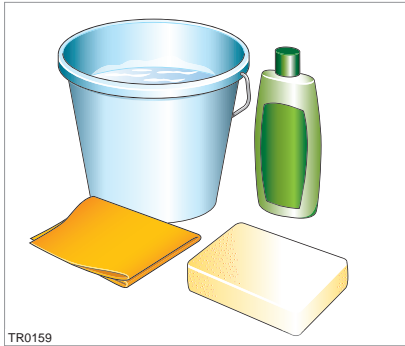

## Environmental precautions



Some cleaning products contain chemicals that are hazardous to the environment. Always take precautions to prevent fluids from spilling.

It is illegal to pollute drains, rivers and waterways. Used toxic chemicals must be disposed of at authorized waste disposal sites only.

## Cleaning the vehicle exterior

### Hand washing



Caution: Substances that are corrosive, such as bird droppings, tree resin, dead insects, tar spots, road salt and industrial fall-out can damage the vehicle's paint. Remove such deposits as soon as possible to prevent damage.

To preserve the paint finish, observe the following:

- Before washing, use a hose to remove heavy deposits of mud and dirt.
- Never wash a vehicle that is “hot to the touch” or during exposure to strong, direct sunlight.
- Wash the body using cold or lukewarm water containing a good quality wash and wax shampoo.
- Never use strong household detergents or soap. These products can discolor and spot painted surfaces.
- For best results, always use a clean sponge or car wash mitt with plenty of water.
- After washing, rinse with clean water and thoroughly wipe dry with a chamois. Do not allow cleaning agents to dry on the finish.

## Automatic car washers and pressure washers



Caution: Tesla Motors recommends that you hand wash your vehicle. Do not use an automatic car washer or pressure washer as these may damage your vehicle's paint finish, soft top, or other components. The use of a pressure washer to clean components in the Battery compartment may damage critical seals on the Battery and other electrical components.

**Note:** Vehicle or paint damage caused by using an automatic car washer or pressure washer is not covered under the New Vehicle Limited Warranty.

## Underbody maintenance

If salt has been used on the highways (such as during winter months), thoroughly remove all traces of road salt. Use a hose to rinse salt from the underside of the vehicle.

Flush away accumulations of mud in areas where debris easily collects (such as wheel arches and panel seams).

## Removing tar spots

Use denatured alcohol to remove tar spots and stubborn grease stains from paint. After cleaning, immediately wash the area with soapy water to remove the alcohol.

## Washing the soft-top



Caution: Scrubbing or brushing with a hard bristle brush will damage the fibers of the fabric, causing fabric deterioration and impairing its cosmetic appearance.

When washing the soft-top, follow these guidelines:

1. Before washing, vacuum the soft-top using a soft brush attachment to remove dust and dirt.
2. Soften encrusted dirt using soap and water, then rinse with clean water.
3. Wash using mild soap and water. Never use solvent, petroleum or chemical-based cleaners, detergents, or wash/wax compounds.

## Wheels

Wash wheels with warm, fresh water containing a good quality wash and wax shampoo. Thoroughly rinse the wheels to remove any soap residue.

## Windshield, windows and mirrors

Regularly clean all windows inside and out using a window cleaning solution. An automotive glass cleaner is recommended.

After washing the vehicle with wash/wax products, clean the outside of the windshield with glass cleaner.

Mirror glass is particularly susceptible to damage. Do not use abrasive cleaning compounds.

## Wiper blades

Clean wiper blades using mild soap and warm water only. Do not use petroleum or alcohol-based cleaners.

## Polishing the body

To preserve the cosmetic appearance of the body, occasionally apply a good quality polish. A good polish should contain a very mild abrasive that removes surface contamination without damaging the surface, a mild filling compound to reduce the appearance of scratches, and wax to provide a barrier between the cleaned body surface and airborne contaminants.

Do not use cutting paste, color restoration compounds, or polishes containing a harsh abrasive. These can scour the surface and permanently degrade the body.

## Using a car cover

To preserve the cosmetic appearance of the body, you may want to use a car cover. Only an approved Tesla Motors car cover should be used. **DONOT** use the car cover when charging the vehicle. Doing so can interfere with adequate cooling during charging.

## Paint damage and rectification

Treat chips and scratches to the paint using a paint touch-up pen. Use the touch-up pen after washing but before polishing or waxing.

More extensive repairs to the body should only be carried out by a facility approved by Tesla Motors. Contact Tesla Motors for a list of approved body repair facilities.

## Cleaning the vehicle interior

### Plastic materials

 Caution: Do not polish the upper surfaces of the dashboard. Polished surfaces are reflective and may interfere with the driver's view.

Clean with diluted upholstery cleaner, then wipe with a damp cloth.

### Carpet and fabrics

Clean with diluted upholstery cleaner. Test a concealed area first.

### Leather

Clean with warm water and a non-detergent soap. Dry and polish with a dry, clean, lint-free cloth.

### Seat belts

Extend the belts and clean with warm, soapy, fresh water only. Do not use any type of detergent or chemical cleaning agent. Allow the belts to dry naturally while extended, preferably away from direct sunlight.

### Instruments and display screens

Clean the instrument panel, Touch Screen, and audio system screen using a damp cloth. Do not use cleaning compounds or solutions.

# Roadside emergencies

---

## **Tool kit**

Tool kit location	9-2
Tool kit components	9-2

## **Energy Depletion**

Dealing with a low Battery	9-3
A few extra miles (kms)	9-3

## **Tire repair**

Tire sealant	9-4
Safety precautions	9-4
Repairing a tire	9-4
Replacing the tire sealant	9-5

## **Wheels**

Removing the wheel	9-6
Replacing the wheel	9-6

## **Fuse replacement**

Replacing a fuse	9-7
Fuse specification chart	9-8

## **Bulb replacement**

Replacing a bulb	9-9
Interior light	9-9
Trunk light	9-10
License plate light	9-10

## **Raising the vehicle**

Vehicle jacking points	9-11
Vehicle lifting points	9-12

## **Vehicle recovery**

Transporting the vehicle	9-13
Securing the wheels	9-15

# Tool kit

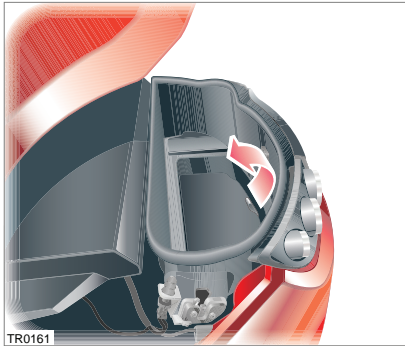

## Tool kit location

The tool kit is located in the storage space beneath the trunk floor. To access the storage space, pull the tab located at the rear edge of the floor covering.

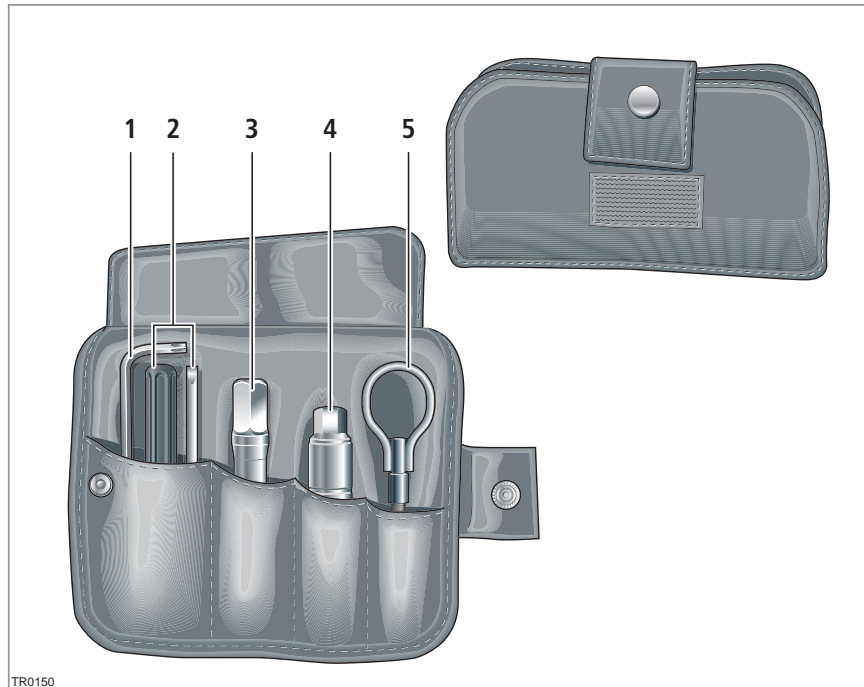

## Tool kit components

1. Hard-top Torx® tool
2. Screwdriver
3. Wheel bolt extension tool
4. Locking wheel nut adapter
5. Vehicle recovery eye

## Dealing with a low Battery

When driving the vehicle, the Touch Screen displays warning messages as the level of charge approaches a low level.

**Do not ignore the warnings. If you continue to drive the vehicle, the charge level will eventually reach 0% and the car will shut down. When you see the warnings, immediately pull over to a safe location and call Roadside Assistance.**

As the charge level approaches a low level, you'll also notice the color of the charge level graph turn yellow, then red, to alert you that you need to charge the vehicle.

## A few extra miles (kms)

If you are driving in Standard or Performance mode and your Battery is approaching a low level, you can drive a few extra miles by putting the vehicle into Range mode using the Touch Screen. To do so, select Range on the Charge Settings screen. For details on using the Touch Screen, refer to the Touch Screen Users Manual provided in your owners package.

If the vehicle is not in Range mode and it shuts down because the Battery's charge level has reached 0%, you'll see the following message on the Touch Screen:

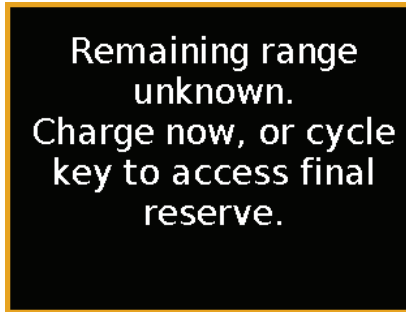

To access final reserve, turn the key to the ACC position then back to the ON position. When you use this feature, the Touch Screen no longer displays warning messages and no longer provides an estimated range.

Switching the vehicle to Range mode, or accessing final reserve, allows you to travel a few extra miles (kms) but should be used with caution. Failure to charge immediately could result in the battery level falling to a critically low level and it may not be possible to recharge it. These options are intended ONLY to allow you to travel just far enough to park the vehicle in a safe location. The distance you can travel depends on the age of your Battery, the amount of energy the vehicle requires (based on temperature, accessories being used, slope of road, etc). In the best case scenario, it could allow you to travel up to 20 more miles (32 kms) but it could also be as short as one mile (1.6 kms).

**Note:** If the Battery reaches 0% when driving in Range mode or after you've cycled the key to access final reserve, there is no reserve and you must charge the Battery immediately. **FULLY DEPLETING THE BATTERY WHILE IN RANGE MODE OR IN RESERVE, AND NOT CHARGING IT IMMEDIATELY, CAN DAMAGE THE BATTERY.**

 Caution: Damage to the Battery caused by failing to charge it immediately when its charge level falls to 0% is not covered by the New Vehicle Limited Warranty. If you are unable to charge the vehicle, contact Tesla Motors immediately.

# Tire repair



## Tire sealant

Your vehicle has no spare tire. Instead, you have been provided with a tire sealant aerosol located in the trunk (on the underside of the trunk lid).

You must repair or replace a damaged tire as soon as possible. Use of the aerosol is temporary and is designed only to allow you to drive the vehicle to the nearest repair facility. The aerosol repairs only small punctures in the tread. If damage is more severe (such as punctures larger than  $.2\frac{1}{2}$  mm, ripped tires, or tires that have separated from the rim), call Roadside Assistance to have the vehicle transported to a tire repair facility.

The tire sealant contains liquid latex and a propellant. When injected into the tire through the valve, the liquid latex penetrates the puncture site and cures to form a temporary repair. At the same time the

propellant inflates the tire, allowing you to drive the vehicle at low speed (less than 30 mph/48 kmh) to reach a tire repair facility.

 **Caution:** Do not drive on a deflated tire as this can seriously damage the wheel and the vehicle.

## Safety precautions

 **WARNING:** Never exceed 30 mph (48 km/h) when driving with a repaired tire.▲

 **WARNING:** Never drive with a deflated tire, vehicle handling and braking will be compromised.▲

 **WARNING:** Always read the directions and warnings on the tire sealant before starting a repair. Follow the directions on the aerosol exactly and pay attention to the following precautions.▲

 **WARNING:** Always keep the tire sealant out of the reach of children.▲

 **WARNING:** The tire sealant contains components which are harmful if consumed or inhaled:

- If swallowed, do not induce vomiting. Seek medical assistance immediately.
- If inhaled, breathe fresh air. If breathing is affected, seek medical assistance immediately.
- If the sealant comes into contact with the eyes, immediately flush the eyes with water. If irritation persists, seek medical assistance.

- Do not breathe gas, fumes, vapor or spray that may be emitted from the tire sealant. Inhalation can cause drowsiness and dizziness.▲

 **WARNING:** Store the tire sealant in its correct location in the trunk. Temperatures in other locations may exceed safe storage conditions. Never carry the tire aerosol in the vehicle's cabin area.▲

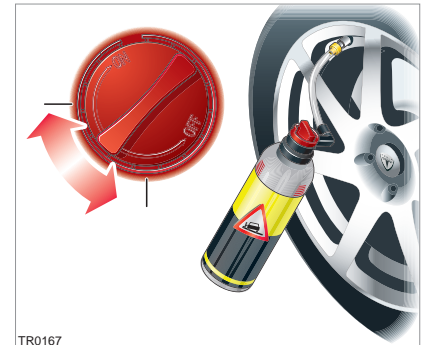

## Repairing a tire

If possible, stop in a safe place away from traffic. Always ask a passenger to wait in a safe area away from traffic. Switch on the hazard warning lights to alert other road users, then follow these steps:

1. Inspect the deflated tire for cause of puncture. If possible, remove foreign material (such as screws or nails) from the tread.
2. Remove the tire sealant from the trunk.

**Note:** In cold conditions, use the vehicle's heater to warm the aerosol.

3. Position the wheel (if possible) so that the puncture is at the bottom.
4. Remove the valve cap and clean the valve thread.
5. Vigorously shake the tire sealant for approximately 30 seconds.
6. Screw the filler tube onto the tire valve and break the safety seal.
7. Hold the tire sealant upright and turn the knob one-quarter turn clockwise. If you need to stop the process, simply turn the knob back to the 'OFF' position.
8. Empty the entire contents of the tire sealant into the tire. When the sealant stops flowing through the filler tube, turn the knob to the 'OFF' position and unscrew the filler tube from the tire valve.

**Note:** If tire sealant comes into contact with the vehicle's paint, immediately wash the area with water to avoid permanent damage.

9. If the wheel rim has lifted from the ground, drive immediately for 6 to 12 miles (10 to 20 km) to distribute the sealant evenly inside the tire. Then drive gently and do not exceed 30 mph (48 km/h).

 **WARNING:** If the wheel rim has not lifted from the ground, call Roadside Assistance to have the vehicle transported to a repair facility.▲

10. Drive to the nearest service station and inflate the tire to the correct pressure (see Specifications and tire pressures, page 10-4.) If the required pressure cannot be reached, then the tire is too severely damaged and you should have the vehicle transported to a tire repair facility. Do not drive!

**Note:** When adjusting tire pressures, you can display tire pressure values on the Touch Screen's tire pressure screen. However, the values displayed by the Touch Screen will not be updated until you place the car in drive long enough for the tire pressure monitoring sensors to take new readings. For details, refer to the Touch Screen Users Manual provided in your owners package.

11. If the correct tire pressure was achieved, continue driving. Drive carefully and do not exceed 30 mph (45 km/h). At the earliest opportunity, have the tire repaired or replaced and replace the used tire sealant.

**Note:** Tire sensors must be set up by Tesla Motors. If a non-Tesla service center repairs or replaces a tire, the tire pressure monitoring sensor will not provide tire pressure information until a Tesla service technician has performed a brief set-up procedure.

 **WARNING:** Always inform the tire repairer that tire sealant has been used. If the tire is to be subsequently deflated, only do so in a well ventilated area. The aerosol sealant can damage the

sensor that measures tire pressure. Therefore, the tire's sensor must be replaced.▲

## Replacing the tire sealant

Always replace the used tire sealant with one of the same type and capacity (13.5 ounces/400 ml). Tire sealants are available through most reputable automotive retailers.



# Wheels

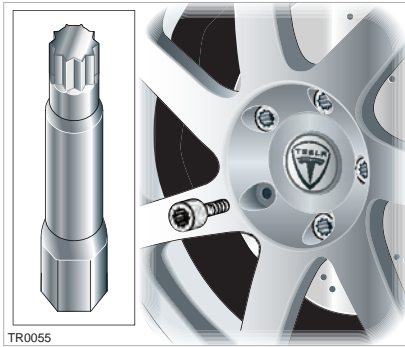

TR0055

## Removing the wheel

**!** **WARNING:** Never work under the vehicle with a jack as the only means of support. If the vehicle slips off the jack, you or someone else could be seriously injured.▲

1. Apply the hand brake and remove the key.
2. Loosen each lug bolt one turn using the wheel bolt extension tool, the locking wheel bolt adapter (located in the tool kit), and a 3/8" (17 mm) socket and/or a wheel wrench.
3. Position a jack at the jacking points identified on the vehicle (see Vehicle jacking points, page 9-11), and raise the vehicle.

**!** **Caution:** Jacking the vehicle from any point other than those specified can damage the vehicle.

4. Remove the lug bolts and store in a safe place.

5. Remove the wheel.

**!** **Caution:** Place the wheel face up to avoid scratching the surface.

## Replacing the wheel

**!** **WARNING:** Before replacing the wheel, inspect the mating faces of the wheel and hub. Remove any corrosion, dirt or foreign material. Fitting the wheels without correct surface-to-surface contact can cause the wheel bolts to loosen, resulting in a loss of vehicle control.▲

1. Position the wheel on the hub.
2. Fit the wheel bolts and tighten until the wheel is firmly seated against the hub.
3. Lower the vehicle and remove the jack.

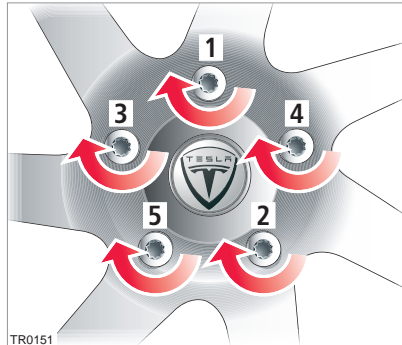

4. Using a torque wrench, fully tighten the bolts in the sequence shown to 77 lbft (105 Nm).

5. Return the wheel bolt extension tool and the locking wheel bolt adapter to the tool kit.
6. Check and tighten the wheel bolts every 1000 miles (1600 km).

# Fuse replacement

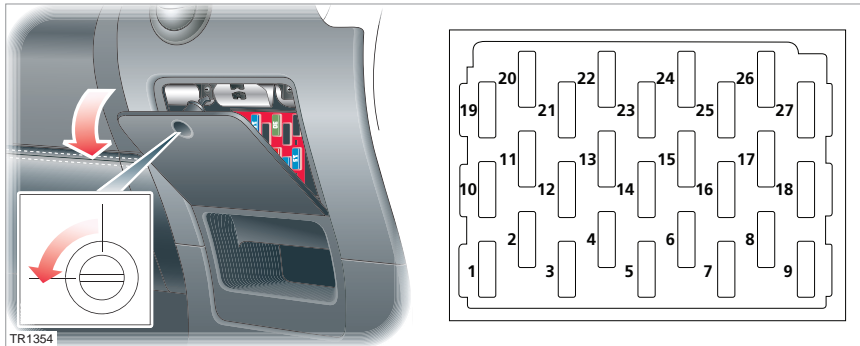

## Fuse colors

Fuse color	Rating (amps)
Orange	5
Brown	7.5
Red	10
Blue	15
Yellow	20
Clear	25
Green	30

## Replacing a fuse

**WARNING:** Use replacement fuses of the same rating and type or fuses of matching specification. Incorrect fuse ratings can overload a system and cause a fire or malfunction. Blown fuses should be replaced and no attempt should be made to repair a blown fuse. ▲

Fuses protect the vehicle's electrical systems from damage. The failure of any fuse will render the equipment it protects inoperative.

1. Before removing a fuse, turn off all electrical equipment and remove the key.
2. Locate the fuse box. The fuse box is located behind the access panel on the passenger side of the dashboard.
3. Open the panel to access the fuses. Remove the panel by using the screwdriver supplied in the toolkit to

rotate the fastener 90° counterclockwise, then release the panel from the dashboard.

4. Consult the fuse specification chart to determine which fuse is protecting the non-functioning electrical system.

**Note:** A label is also affixed to the inside of the panel.

5. Remove the appropriate fuse and replace with a fuse of the same amperage as the original. If in doubt, check the fuse specification chart on the following pages.
6. Re-install the fuse panel by aligning the hinges at the bottom of the panel with the slots on the surrounding dashboard area. Secure the panel by rotating the fastener 90° clockwise.

If a replacement fuse fails to solve an electrical failure, or the replacement fuse fails prematurely, contact Tesla Motors.

# Fuse replacement

## Fuse specification chart

Fuse number	Rating (amps)	Circuit protected
1	10	Anti-lock Braking System (ABS)
2	15	Auxiliary power socket
3	20	Heating and ventilation fan
4	15	Windshield wiper motor and washer
5	7.5	Electrical accessories, audio and navigation systems
6	10	Turn signals and side lights
7	10	Starter key in 'ON' position
8	5	Instruments
9	15	Horn
10	7.5	Interior and trunk lights
11	20	Interior lighting and seat heaters
12	30	Radiator cooling fans
13	7.5	Alarm
14	7.5	Starter key in 'ACC' position (Electrical accessories, alarm, audio and navigation system)
15	10	Left-hand headlight - low beam
16	10	Right-hand headlight - low beam
17	7.5	Left-hand headlight - high beam
18	7.5	Right-hand headlight - high beam
19	20	Passenger window
20	20	Driver window
21	10	Central door locking
22	7.5	Brake pump
23	15	Heating, ventilation, and accessory power socket
24	15	Audio system amplifier
25	30	Starter key in 'ON' position
26	5	Brake lights
27	7.5	Driver controls - heating and ventilation

## Replacing a bulb

Always check the operation of all exterior lights before driving the vehicle. Replace a bulb only with one of the same type and specification.

### Light Emitting Diode (LED) lights

The following lights on your vehicle use the latest LED technology and if any of these lights stop working, it must be replaced by Tesla Motors:

- Front side marker light
- Rear side marker light
- Reverse lights
- Tail/brake lights
- Rear turn signals

Unlike traditional filament bulbs, these lights have a long life and low power consumption while providing the same amount of illumination.

### Filament bulbs

The lights shown in the illustration and listed below have replaceable filaments that should be replaced by Tesla Motors:

- Front turn signal (1)
- Front side (2)
- Headlight high beam (3)
- Headlight low beam (4)

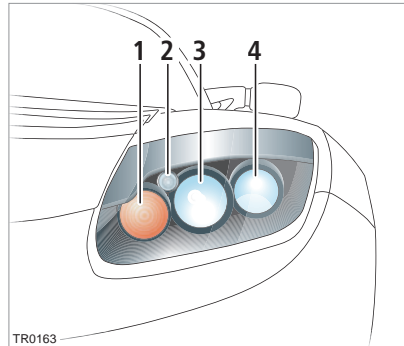

TR0163

Location	Watts	Type
Front turn signal (1)	21	PY21W
Front side (2)	5	W5W
Headlight high beam (3)	65	H9B
Headlight low beam (4)	60	HB3A

### Owner replaceable bulbs

The interior light, trunk light, and license plate lights are easy to replace. To replace these lights, refer to the following table and instructions.

Location	Watts	Type
Interior	5	W5W
Trunk	5	C5W
License plate	5	C5W

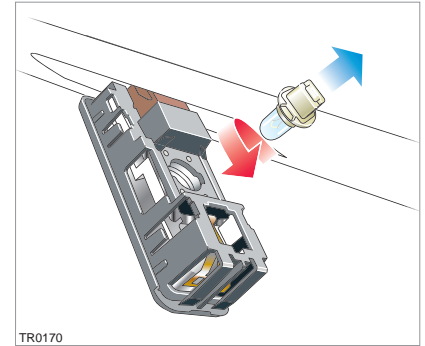

TR0170

## Interior light

To remove the bulb:

1. Using the screwdriver supplied in the toolkit, depress the retaining clips and carefully pry the light unit from the rear header rail.
2. Rotate the bulb holder 90° counterclockwise and remove.
3. Pull the bulb from the holder.

To install the new bulb, reverse the above steps.

# Bulb replacement

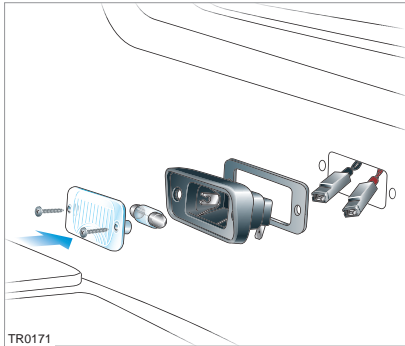

## Trunk light

To remove the bulb:

1. Using the screwdriver supplied in the toolkit, remove the two screws securing the light unit to the inside of the trunk.
2. Withdraw the light unit from the trunk and disconnect the two connectors.
3. Remove the lens from the light.
4. Spring the bulb holder clips apart to release the bulb.

To install the new bulb, reverse the above steps.

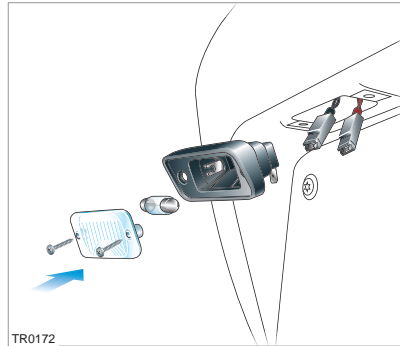

## License plate light

To remove the bulb:

1. Using the screwdriver supplied in the toolkit, remove the two screws securing the light unit to the rear bumper.
2. Withdraw the light unit from the bumper and disconnect the two connectors.
3. Remove the lens from the light.
4. Spring the bulb holder clips apart to release the bulb.

To install the new bulb, reverse the above steps.

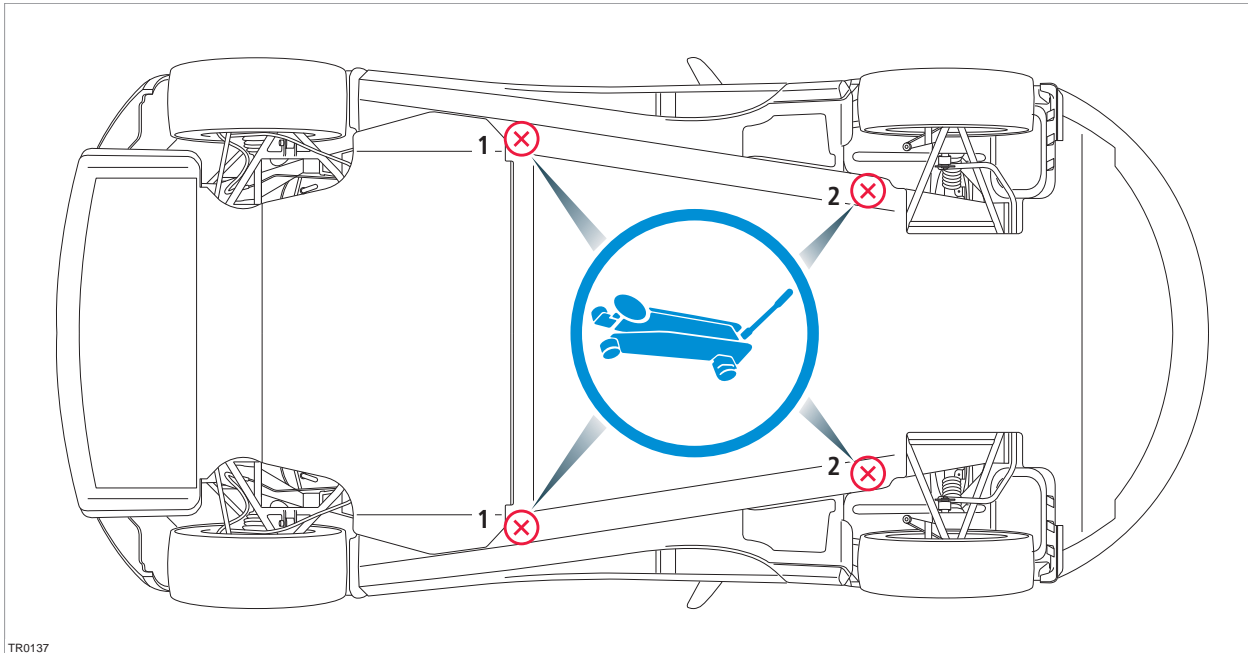

TR0137

## Vehicle jacking points

Refer to the illustration, and the labels on the vehicle, for correct jacking locations. If lifting the vehicle on a two-post lift, refer to the next page.

### 1. Side jacking point

This point will raise both the front and rear wheels.

### 2. Front jacking point

 Caution: Jacking the vehicle at any other point will damage the underside of the vehicle.

 Caution: Use a suitable rubber or wood pad to protect the chassis from surface damage. Do not lift from a body panel.

 **WARNING:** Never raise a vehicle when the charge cable is connected, even if charging is not in progress. Always disconnect the charge cable before raising the vehicle.▲

# Raising the vehicle

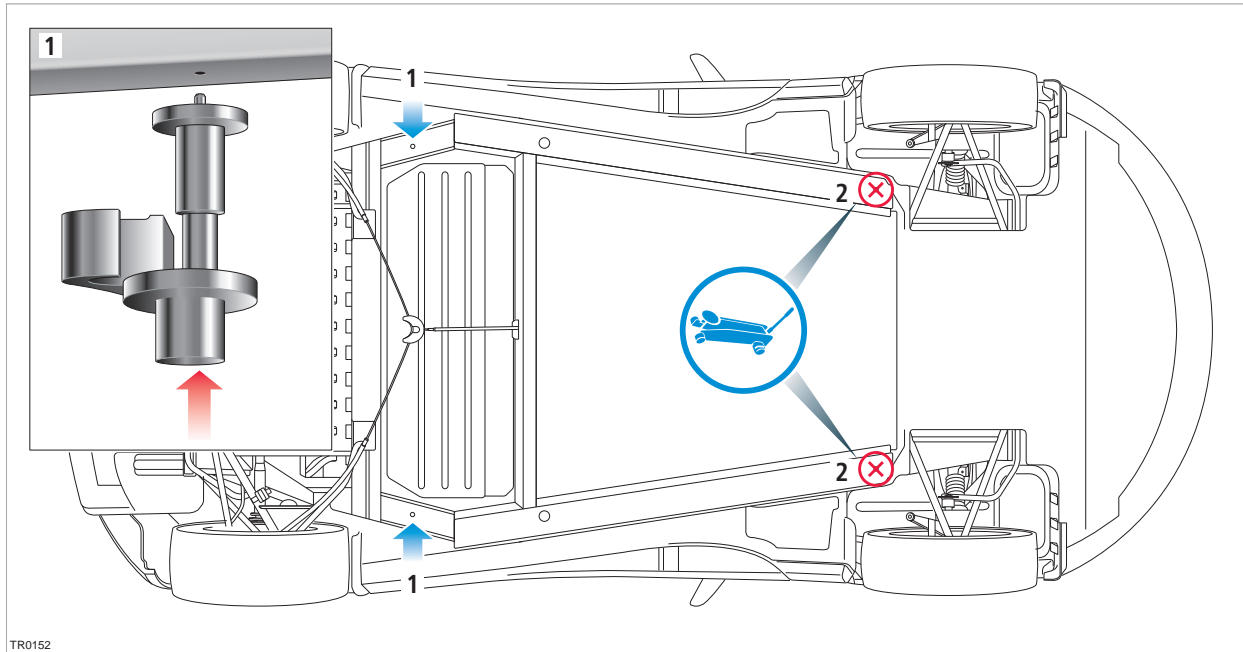

## Vehicle lifting points

Refer to the illustration, and the labels on the vehicle, for correct locations when lifting the vehicle on a two-post lift. If jacking the vehicle, refer to the previous page.

Before lifting on a two-post lift, you must remove the rear undershield and fit rear lift point adaptors 1 to the chassis. Rear lift point adaptors can be purchased from Tesla

Motors. Position the arms of the two-post lift under the rear lift point adapters and the front jacking points 2.

**!** WARNING: Death, serious injury or vehicle damage can occur if the vehicle is lifted on a two-post lift with the rear undershield still in place.▲

**!** WARNING: Never raise a vehicle that is plugged in. Always unplug the vehicle before raising it.▲

**!** Caution: Rear lift point adaptors must be used when lifting the vehicle on a two-post lift.

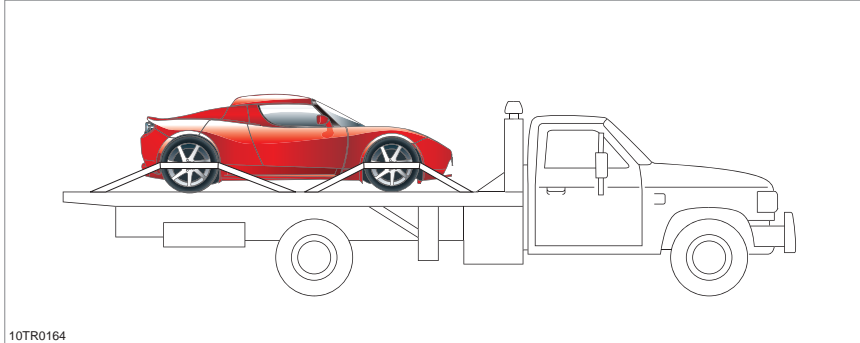

## Transporting the vehicle

The only approved method of transporting your vehicle is using a flatbed trailer or transporter. Towing the vehicle will cause serious damage to the power train. This damage will not be covered by the New Vehicle Limited Warranty.



Caution: Serious damage to the vehicle and transmission can occur if the vehicle is towed with the wheels on the ground or on a suspended lift.



Caution: The transmission lock will only retract when the vehicle is in Tow Mode or when the electrical systems are functional, the key is in the ON position and the Neutral gear is engaged.

Before pulling the vehicle onto a flatbed trailer or transporter, follow these steps:

- activate Tow Mode to disengage the transmission lock, or turn the key to the ON position and select the Neutral gear position
- attach the vehicle recovery eye

## Activating Tow Mode

Tow Mode disengages the transmission lock so the vehicle can roll freely.

**Note:** In the unlikely situation in which electrical systems are not functioning and therefore Tow Mode can not be activated, wheeled dollies or skid pads must be used.

1. Turn OFF the vehicle and apply the hand brake. The Touch Screen displays the main Parked screen.

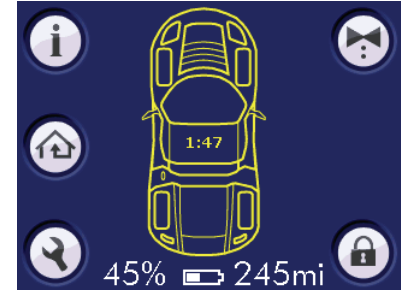

2. Touch  to display the first settings screen.

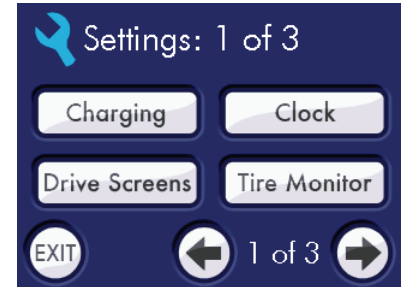

3. Touch  to display the third settings screen.



# Vehicle recovery

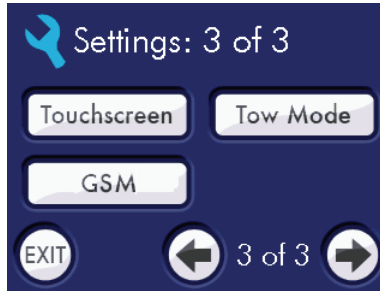

4. Touch **Tow Mode**, then touch **OK** to confirm.

The Touch Screen displays the following message indicating that the vehicle is in Tow Mode.

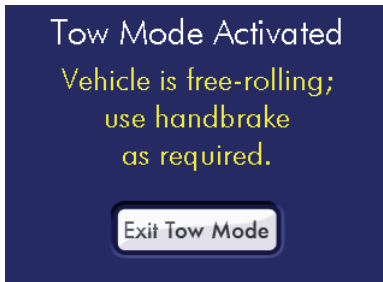

5. Release the hand brake, when appropriate.

**Note:** Although Tow Mode is activated, the steering column lock will be engaged. To disengage the steering column, turn the key to the ACC position. If it is difficult to turn the key, move the steering wheel slightly.

**Caution:** The car can roll freely when Tow Mode is active. If the vehicle is not on a flat surface, do not release the hand brake until the vehicle is ready to be pulled.

**Note:** You can not start or charge the vehicle until you exit Tow Mode.

## Attaching the vehicle recovery eye

A vehicle recovery eye can be attached to the front of the vehicle to allow the vehicle to be pulled onto a transporter in situations when the vehicle can roll freely.

**WARNING:** NEVER tow the vehicle using the vehicle recovery eye. Doing so can cause serious, even fatal injury to other motorists and can also cause significant damage to your vehicle.▲

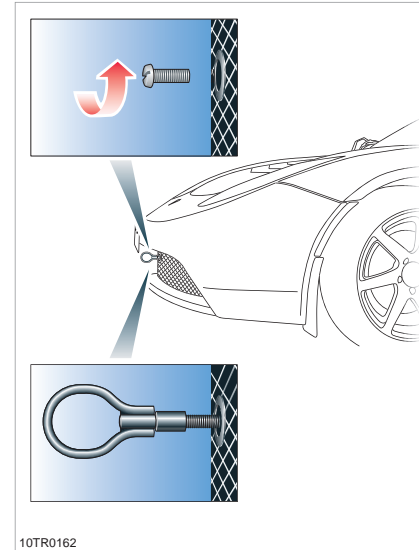

10TR0162

1. Retrieve the recovery eye from the tool kit located in the trunk. See Tool kit components, page 9-2.
2. Using the screwdriver (also supplied in the toolkit), remove the plug from the recovery eye mounting point behind the front grill. If a license plate has been installed on the front of the vehicle, it must be removed to access the recovery eye.

3. Insert the recovery eye through the hole in the front grill and screw into the mounting point. Ensure the recovery eye is fully tightened.

After use, remove the recovery eye and return it to the tool kit. Insert the plug back into the mounting point to prevent dirt from entering.

## Securing the wheels

When the vehicle is to be moved on a transporter or trailer, use chocks and tie down straps to secure the wheels. To avoid damage when doing so:

- Ensure that metal parts on the tie down straps do not contact the vehicle's painted surfaces or the face of any wheels.
- Do not place tie down straps over or through the vehicle's body panels.



Caution: Attaching straps to the chassis, suspension or other parts of the body can damage the vehicle.

# Technical specifications

---

## Vehicle identification

Vehicle Identification Number	10-2
Safety compliance certification label	10-3

## Wheels and tires

Specifications and tire pressures	10-4
Tire markings	10-5
Tire placard/label	10-7
Uniform tire quality grading	10-7
Tire care	10-8
Tire Pressure Monitoring System	10-11
Dynamic tire pressure monitoring	10-12
Wheels and tires glossary	10-13

## Approved fluids and capacities

Fluid specifications	10-14
----------------------	-------

## Vehicle dimensions and weights

Exterior dimensions	10-15
Vehicle weights	10-16

## Subsystem specifications

Motor	10-17
Transmission	10-17
Steering	10-17
Front suspension	10-18
Rear suspension	10-18
Brakes	10-18
Electrical	10-19
Battery	10-19

# Vehicle identification

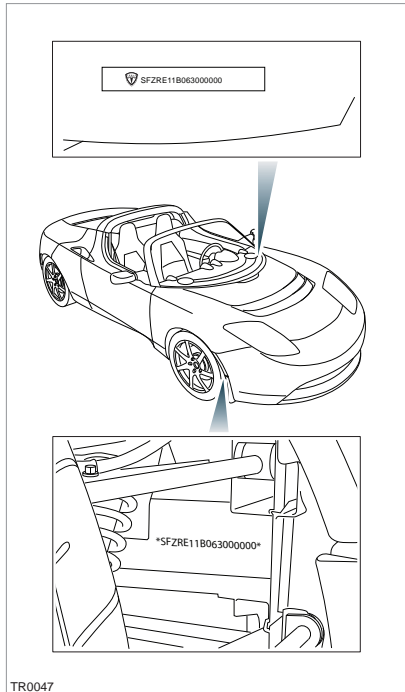

TR0047

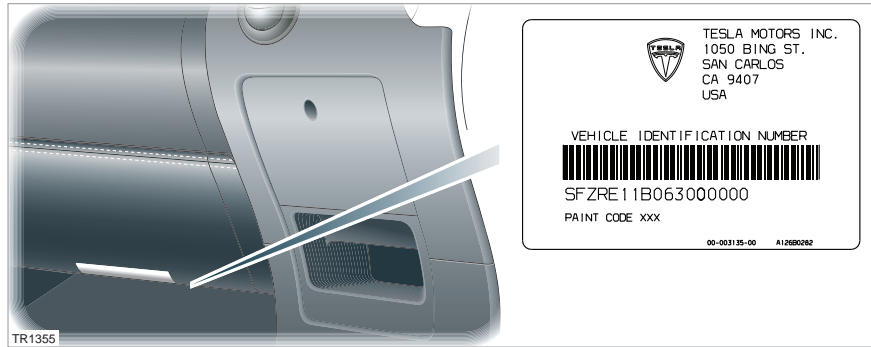

## Vehicle Identification Number

You can find the Vehicle Identification Number (VIN) in multiple locations:

- Top of Dashboard - the VIN is stamped on a plate which is visible through the lowest part of the drivers side of the windshield.
- Chassis - the VIN is stamped on the vehicle chassis, and is visible behind the passenger side front wheel.
- Underside of Dashboard - a VIN label is attached to the underside of the dashboard. This label also displays the vehicle paint code should repairs to the vehicle's painted surfaces be required.
- Touch Screen - the VIN can also be displayed on the Touch Screen when your vehicle is parked. For details, refer to the Touch Screen Users Manual provided in your owners package.

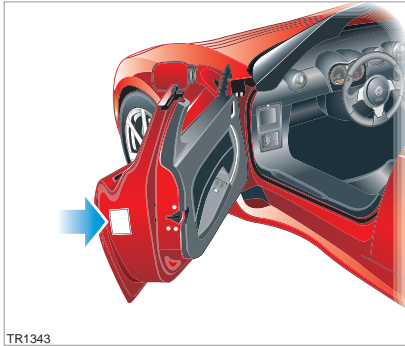

TR1343

### **Safety compliance certification label**

The National Highway Traffic Safety Administration (NHTSA) regulations require that a safety compliance certification label is affixed to the vehicle. This label is located on the opening face of the driver's door.

# Wheels and tires

## Specifications and tire pressures

Wheel type	Location	Size
Roadster - cast alloy, Roadster Sport - forged light alloy	Front	6J x 16
	Rear	7.5J x 17

Tire type	Location	Size
Roadster - Yokohama Neova AD07 LTS - Directional	Front	175/55 R16
	Rear	225/45 R17
Roadster Sport - Yokohama AD048 Performance - Directional	Front	195/50 R16
	Rear	225/45 R17

Road wheel bolt torque	77 lbf.ft	105 Nm
<b>Note:</b> For details on where to position a jack to lift the vehicle, see Vehicle jacking points, page 9-11.		

Tire	Tire Pressure	
	Recommended	Comfort setting
Front	30 PSI (207 kPa)	25 PSI (172 kPa)
Rear	40 PSI (276 kPa)	36 PSI (248 kPa)

**Note:** The recommended tire pressures have been calculated to provide the best combination of vehicle range, tire life, ride comfort and road handling.

Driving the vehicle with the tires inflated to the comfort setting will improve ride comfort and road handling, but will decrease vehicle range (the number of miles you can travel on a charge) and Battery life (see the New Vehicle Limited Warranty, provided in your owners package, for details on expected range of the Battery).

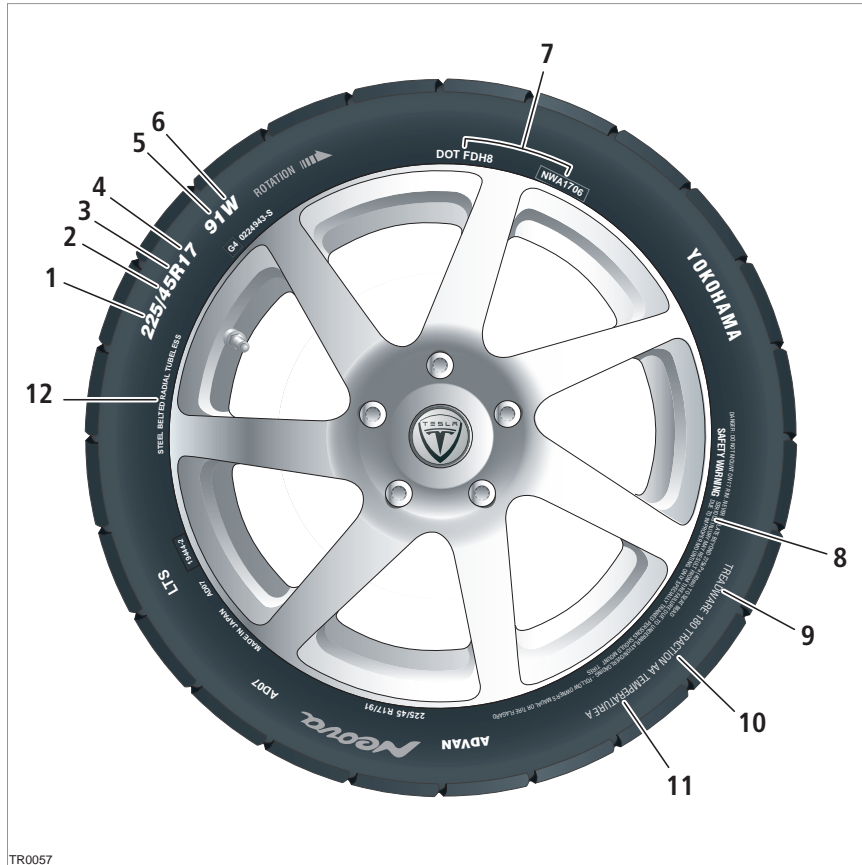

## Tire markings

### 1, Tire width

This three digit number gives the width in millimeters of the tire from sidewall edge to sidewall edge.

### 2, Aspect ratio

This two digit number, known as the aspect ratio or profile, gives the sidewall height as a percentage of the tread width. So, if the tread width is 205 mm, and the aspect ratio is 50, the sidewall height will be 102 mm.

### 3, Tire construction

R indicates that the tire is of Radial ply construction.

### 4, Wheel diameter

This two digit number is the diameter of the wheel rim in inches.

### 5, Load index

This two or three digit number is the tire's load index. It is a measurement of how much weight each tire can support. This number is not always shown.

### 6, Speed rating

The speed rating, when stated, denotes the maximum speed at which the tire should be used for extended periods. The ratings range from 99 mph to 186 mph. These ratings are listed in the following table.

TR0057

# Wheels and tires

Rating	Speed (mph)
Q	99
R	106
S	112
T	118
U	124
H	130
V	149
W	168
Y	186

## 7, U.S DOT Tire Identification Number (TIN)

This begins with the letters DOT and indicates that the tire meets all federal standards. The next two numbers or letters are the plant code where it was manufactured, and the last four numbers represent the week and year the tire was built. For example, the numbers 1706 means the 17th week of 2006. The other numbers are marketing codes used at the manufacturer's discretion. This information can be used to contact consumers if a tire defect requires a recall.

## 8, Maximum permissible inflation pressure

The maximum inflation pressure for the tire. This pressure should not be used for normal driving.

## 9, Treadwear grade

This number indicates the tire's wear rate. The higher the treadwear number is, the longer it should take for the tread to wear down. A tire rated at 400 for example, will last twice as long as a tire rated at 200.

## 10, Traction grade

This letter indicates a tire's ability to stop on wet pavement. A higher graded tire should allow you to stop your vehicle on wet roads in a shorter distance than a tire with a lower grade.

Traction is graded from highest to lowest as AA, A, B, and C.

## 11, Temperature grade

Heat resistance grading. The tires resistance to heat is grade A, B, or C, with A indicating the greatest resistance to heat. This grading is provided for a correctly inflated tire, which is being used within its speed and loading limits.

## 12, Tire composition and materials

The number of plies in both the tread area, and the sidewall area, indicates how many layers of rubber coated material make up the structure of the tire. Information is also provided on the type of materials used.



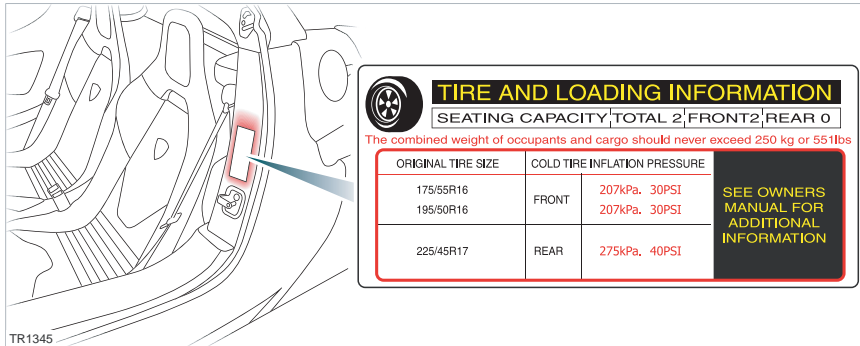

## Tire placard/label

The tire information label on the pillar behind the driver's door contains the following information:

- The maximum number of occupants for the vehicle.
- The vehicle capacity weight, which includes the weight of the driver, passengers and cargo.
- The size of the tires with which the vehicle was originally equipped.
- Cold inflation pressures for the front and rear tires.

**Note:** The label must not be changed, even if different wheels are fitted at a later stage.

## Steps for determining correct load limit

**!** **WARNING:** Do not exceed the vehicle capacity weight (the total weight of driver, passenger and cargo) given.▲

**!** **WARNING:** Overloading the vehicle will have an adverse affect on braking and handling characteristics, which could compromise your safety.▲

1. Locate the statement "The combined weight of occupants and cargo should never exceed 250 kg or 551 lbs" as shown on your vehicle's placard.
2. Determine the combined weight of the driver and passengers that will be riding in your vehicle.
3. Subtract the combined weight of the driver and passengers from 250 kg or 551 lbs (weight given on placard).
4. The resulting figure equals the available amount of cargo and luggage load capacity. For example, if there will be two 150 lb passengers in your vehicle, the amount of available cargo and luggage load capacity is 251 lbs: (551 - 300 (2 x 150) = 251 lbs).

5. Determine the combined weight of luggage and cargo being loaded on the vehicle. That weight may not safely exceed the available cargo and luggage load capacity calculated in Step 4.
6. Your vehicle should never be used to tow a trailer.

The number and weight of passengers will affect the cargo and luggage load capacity. In the example above, the cargo and luggage load capacity is 251 lbs. However, if only one occupant is in the vehicle, the luggage load capacity will increase. If the vehicle carries one 150 lb person, the luggage load capacity will increase to 401 lbs (551 - 150 = 401 lbs).

**Note:** If the passengers weigh more, the luggage load capacity will decrease.

## Uniform tire quality grading

The following information relates to the tire grading system developed by the National Highway Traffic Safety Administration (NHTSA) which will grade tires by tread wear, traction and temperature performance.

**Note:** Tires that have deep tread, and winter tires, are exempt from these marking requirements.

Quality grades, where applicable, can be found on the tire sidewall between the tread shoulder and maximum section width. For example:

TREADWEAR	TRACTION	TEMPERATURE
180	AA	A

# Wheels and tires

In addition to the marking requirements, passenger car tires must conform to Federal Safety Requirements.

## Treadwear

The treadwear grade is a comparative rating based on the wear rate of the tire when tested under controlled conditions on a specified government test course.

For example; a tire graded 150 would wear one and a half times as well on a government test course as a tire graded 100. The relative performance of tires depends on the actual conditions of their use, however, and may depart significantly from the norm due to variations in driving habits, service practices, and differences in road characteristics and climate.

## Traction

 **WARNING:** The traction grade assigned to this tire is based on straight-ahead braking tests, and does not include; acceleration, cornering, hydroplaning or peak traction characteristics.▲

The traction grades, from highest to lowest, are; AA, A, B, and C. These grades represent a tire's ability to stop on a wet pavement as measured under controlled conditions on specified government test surfaces of asphalt and concrete. A tire marked C may have poor traction performance.

## Temperature

 **WARNING:** The temperature grade for this tire is established for a tire that is properly inflated and not overloaded.

Excessive speed, under-inflation, or excessive loading, either separately or in combination, can cause heat buildup and possible tire failure.▲

The temperature grades are A (the highest), B, and C, representing the tire's resistance to the generation of heat and its ability to dissipate heat when tested under controlled conditions on a specified indoor laboratory test wheel.

Sustained high temperature can cause the material of the tire to degenerate and reduce tire life, and excessive temperature can lead to sudden tire failure.

The grade C corresponds to a level of performance which all passenger car tires must meet under the Federal Motor Safety Standard No. 109.

Grades B and A represent higher levels of performance on the laboratory test wheel than the minimum required by law.

## Tire care

 **WARNING:** Defective tires are dangerous. Do not drive if any tire is damaged, is excessively worn, or is inflated to an incorrect pressure.▲

Always consider tire conditions when driving, and regularly inspect the tread and side walls for any sign of distortion (bulges), cuts or wear.

The way you drive has a significant influence on your safety and on the life of your tires. Cultivate good habits for your own benefit:

- Observe posted speed limits.
- Avoid fast starts, stops and turns.
- Avoid potholes and objects in the road.
- Do not run over curbs or hit the tire against the curb when parking.



**Caution:** Avoid contaminating tires with vehicle fluids that can cause damage.

## Tire pressure information



**WARNING:** If the vehicle has been parked in strong sunlight or used in high ambient temperatures, do not reduce the tire pressures. Move the vehicle into the shade and allow the tires to cool before checking.▲

Correctly inflated tires will ensure that you enjoy the best combination of vehicle range, tire life, ride comfort and road handling.

Tire pressure should be checked when the tires are cold. Inflate each tire to the pressure recommended by Tesla Motors on the vehicle placard, or tire inflation pressure label.



As an added safety feature, your vehicle has been equipped with a tire pressure monitoring system (TPMS) that illuminates a tire pressure telltale when one or more of your tires is significantly under-inflated. Accordingly, when the low tire pressure telltale illuminates, you should stop and check your tires as soon as possible, and inflate them to the proper pressure.

Driving on a significantly under-inflated tire causes the tire to overheat and can lead to tire failure. Under-inflation also reduces Battery range and tire tread life, and may affect the vehicle's handling and stopping ability.

The TPMS is not a substitute for proper tire maintenance, and it is the driver's responsibility to maintain correct tire pressure, even if under-inflation has not reached a level to trigger illumination of the TPMS tire pressure telltale.

## Checking tire pressures

**⚠ WARNING:** Tire pressures should be checked using an accurate pressure gauge when cold. Under-inflation is the most common cause of tire failures and may result in severe tire cracking, tread separation or "blowout", with unexpected loss of vehicle control and increased risk of injury.▲

Check the pressures when the tires are cold. Be aware that it only takes 1 mile (1.5 km) of driving to warm up the tires sufficiently to affect the tire pressures. If it is necessary to check the tires when they are warm, you should expect the pressures to have increased. Do not let air out of warm tires in an attempt to match the recommended cold tire pressures.

**Note:** When adjusting tire pressures, you can display tire pressure values on the Touch Screen's tire pressure screen. However, the values displayed by the Touch Screen will not be updated until you place the car in drive long enough for the tire pressure monitoring sensors to take new readings.

Always inflate your tires to the Tesla Motors recommended inflation pressure even if it is different from the maximum inflation pressure information found on the tire itself. For the correct tire pressures, refer to Specifications and tire pressures, page 10-4.

The following procedure should be used to check and adjust tire pressures:

1. Remove the cap from the valve, then firmly press the tire gauge onto the valve and measure the pressure.
2. If required add air to reach the required pressure.
3. Check the pressure by removing the tire gauge and then re-attaching it.

**Note:** Failure to remove and re-attach the gauge to the valve could cause the gauge to show an incorrect reading.

4. If too much air is added, air can be released by pushing on the metal stem in the center of the valve.
5. Recheck the pressure with the tire gauge and adjust if necessary.
6. Refit the valve cap.

## Valves

Fit the valve caps securely to prevent dirt from entering the valve. Periodically check the valve for damage and leaks.

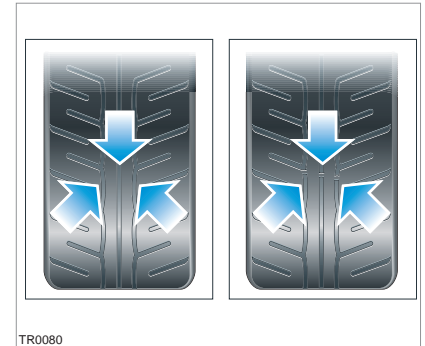

## Tire wear

**⚠ WARNING:** The tires should be regularly checked for wear and to make sure that there are no cuts, bulges or exposure of the ply/cord structure. Do not drive with tires which are worn or damaged. The safety of the vehicle and occupants will be adversely affected.▲

Tires fitted as original equipment have wear indicators moulded into the tread pattern.

When the tread has been worn down to 1/16", (1.59 mm) the indicators start appearing at the surface of the tread pattern, producing the effect of a continuous band of rubber across the width of the tire.

A tire must be replaced as soon as an indicator band becomes visible or the tread depth reaches the minimum permitted by legislation.

# Wheels and tires

**Note:** If tire wear is uneven (on one side of the tire only) or becomes abnormally excessive, the wheel alignment should be checked.

## Age degradation

Tires degrade over time due to the effects of ultraviolet light, extreme temperatures, high loads, and environmental conditions. It is recommended that tires are replaced every six years, or sooner if required.

## Punctured tires

Your vehicle is fitted with tubeless tires, which may not leak when penetrated, provided the object remains in the tire.

If, however, you feel a sudden vibration or ride disturbance while driving, reduce your speed and when safe to do so, stop and check for the cause of the vibration.

A puncture will eventually cause the tire to lose pressure, which is why frequent checking of tire pressures is important. Punctured or damaged tires must be permanently repaired or replaced as soon as possible.

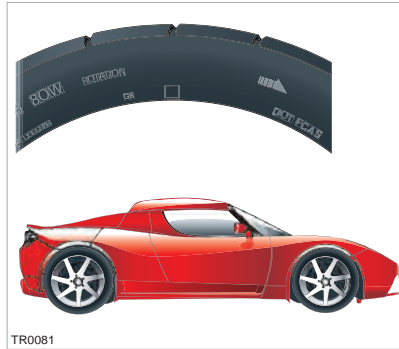

## Directional tires

**!** WARNING: Road holding will be seriously impaired if directional tires are incorrectly installed.▲

Your vehicle is fitted with directional tires. An arrow on the tire wall shows the direction of rotation. These tires must be fitted to rotate in the direction of the arrow when the vehicle is moving forward.

For this reason, tires must not be swapped from one side of the vehicle to the other, and replacements must be fitted with regard for axle/wheel rotation.

## Replacement wheels and tires

**!** WARNING: For your safety, it is recommended that only wheels and tires that match the original specification are used on the vehicle.▲

Wheel rims and tires are matched to suit handling characteristics of the vehicle. Always check that replacement tires comply with the original specification. If tires other than those specified are used, ensure that the load and speed ratings (shown on the tire side wall) equal or exceed those of the original specification.

For the specification of the original wheels and tires installed on the vehicle, refer to Specifications and tire pressures, page 10-4.

**Note:** Different sizes are specified for front and rear tires. Therefore, wheels must not be swapped from front to rear or vice versa.

## Winter tires and chains

**!** WARNING: For your safety, it is recommended that if winter tires or chains are needed, you use only those that are recommended by Tesla Motors.▲

Tesla recommends the following winter tires and tire pressure settings:

- Front: Pirelli 210 Snowsport 195/50/R16 84H at 25 PSI (172 kPa)
- Rear: Pirelli 240 Snowsport 215/45/R17 91H at 36 PSI (248 KPa)

If snow chains are necessary, Tesla recommends PEWAG Neon x3 Montage.

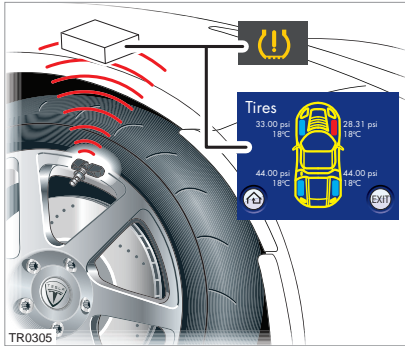

## Tire Pressure Monitoring System

**WARNING:** The TPMS is not a substitute for manually checking tire pressures. The TPMS only provides a tire pressure warning and does not re-inflate the tires.▲

**WARNING:** The TPMS cannot register damage to a tire. Regularly check the condition of your tires.▲

The Tire Pressure Monitoring System (TPMS) monitors the pressure of the tires using sensors located in each wheel and receivers located within the vehicle. The sensors communicate with the receiver using Radio Frequency (RF) signals.

**Note:** Installing accessories that are not approved by Tesla Motors may interfere with the TPMS system.

**!** Tire pressure warnings are displayed on the instrument panel using an amber warning indicator (telltale). A warning is also displayed on the Touch Screen.

If the tire pressure warning light illuminates, stop and check your tires as soon as possible and inflate them to the correct pressure. If the low pressure warning occurs frequently, the cause must be determined and rectified.

The tire pressure warning indicator will extinguish when all tires have been inflated to the correct pressure.

## TPMS malfunction

Your vehicle has been equipped with a TPMS malfunction indicator to indicate when the system is not operating properly.

The TPMS malfunction indicator is combined with the tire pressure indicator. When the system detects a malfunction, the indicator will flash. This sequence will continue upon subsequent vehicle start-ups as long as the malfunction exists.

When a malfunction occurs, the system may not be able to detect or signal low tire pressure as intended. TPMS malfunctions can occur for a variety of reasons, including the installation of replacement or alternate tires or wheels on the vehicle that prevent the TPMS from functioning properly. Always check the TPMS malfunction indicator after replacing one or more tires or wheels to ensure that the replacement or alternate tires and wheels allow the TPMS to function properly.

**Note:** If a tire has been replaced or repaired after using the tire sealant, and a low tire pressure is detected, it is possible that the tire sensor has been damaged. The aerosol sealant can damage the sensor. Therefore, whenever tire sealant has been used, the tire sensor must be replaced.

## Setting the tire pressures

Your vehicle allows you to use two sets of tire pressures, refer to Specifications and tire pressures, page 10-4.

## Replacing a tire sensor

If you are experiencing frequent low tire pressure warnings or the Touch Screen reports a “Tire Pressure Hardware Fault”, the system should be checked by Tesla Motors to determine if a tire sensor requires replacement. Tire sensors must be set up by Tesla Motors. If a non-Tesla service center repairs or replaces a tire, the tire pressure monitoring sensor will not provide tire pressure information until a Tesla service technician has performed a brief set-up procedure.

## Type approval

The TPMS devices comply with Part 15 of the FCC rules and RSS-210. Operation is subject to the following two conditions:

1. This device may not cause harmful interference.
2. This device must accept interference received, including interference that may cause undesired operation.

# Wheels and tires

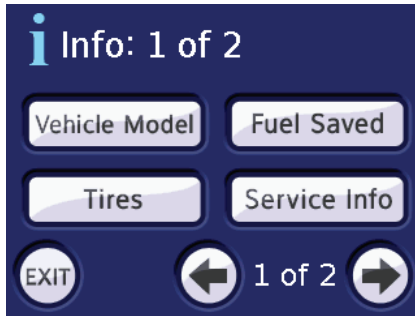

## Dynamic tire pressure monitoring

The Touch Screen can display the pressure and temperature for each tire.

 Touch the information icon on the main parked screen to display the 'Info' screen.

Touch the Tires option to display the data being received by the sensors adjacent to the respective wheel.

**Note:** When you turn on the vehicle, you may experience a delay of up to 8 minutes before tire pressures are displayed. To reduce the length of this delay, drive the vehicle for a short distance.

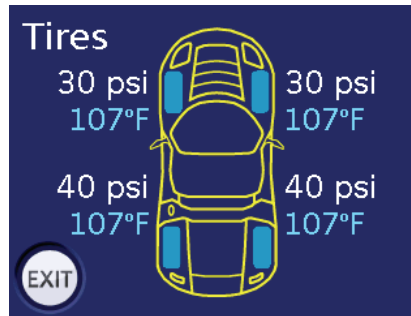

A blue wheel indicates an acceptable operating pressure for the tire.

A red wheel indicates that the pressure is below the recommended operating pressure, and that action must be taken to rectify the issue.

**Note:** If the vehicle has been driven, the temperature of the tires will have increased and hence the pressure of the air in the tire will also have increased. Tire pressures should only be checked when the tires are cold. See Checking tire pressures, page 10-9.

Touch EXIT icon to return to the previous screen.

## Wheels and tires glossary

### Accessory weight

The combined weight (in excess of those items replaced) of items available as factory installed equipment.

### Bead

The inner edge of a tire that is shaped to fit to the rim and form an air tight seal. The bead is constructed of steel wires which are wrapped, or reinforced, by the ply cords.

### Cold tire pressure

The air pressure in a tire which has been standing in excess of three hours, or driven for less than one mile.

### Curb weight

The weight of a standard vehicle, including any optional equipment fitted, and with the correct fluid levels.

### Gross vehicle weight

The maximum permissible weight of a vehicle with driver, passengers, load, luggage, and equipment.

### kPa (kilo pascal)

A metric unit used to measure pressure. One kilo pascal equals approximately .145 psi.

### Maximum inflation pressure

The maximum pressure to which the tire should be inflated. This pressure is given on the tire side wall in psi (lb/in<sup>2</sup>).

**Note:** This pressure is the maximum allowed by the tire manufacturer. It is not the pressure recommended for use.

### Maximum loaded vehicle weight

The sum of curb weight, accessory weight, vehicle capacity weight, and production options weight.

### Production options weight

The combined weight of options installed which weigh in excess of 3 lb more than the standard items that they replaced, and are not already considered in curb or accessory weights.

### PSI (lb/in<sup>2</sup>)

Pounds per square inch, unit of measure for pressure.

### Rim

The metal support for a tire, or tire and tube, upon which the tire beads are seated.

### Vehicle capacity weight

The number of seats multiplied by 150 lb plus the rated amount of load/luggage.

# Approved fluids and capacities

## Fluid specifications

Only use new fluid from sealed containers.

### Capacities

Battery cooling system*	7.4 quarts (US)	7.0 liters
Brake fluid*	1.6 quarts (US)	1.5 liters
Transmission fluid	1.4 quarts (US)	1.325 liters
Washer reservoir	2.3 quarts (US)	2.2 liters
Air conditioning refrigerant	1.76 lbs	800 g
*For instructions on topping up battery coolant and brake fluid, refer to Fluid reservoirs, page 8-5.		

### Battery Coolant

One of the following recommended solutions:

- a 50/50 mix of water and Havoline® Extended Life Antifreeze Coolant-PG
- pre-mixed Sierra Antifreeze Coolant-PG, or a 50/50 mix of water and full-strength Sierra Antifreeze Coolant-PG

### Brake fluid

Any proprietary brand of brake fluid (or brake and clutch fluid) meeting DOT 4 specification.

### Transmission fluid

Dexron VI ATF

### Air conditioning

The air conditioning system is filled with R134a refrigerant. If oil needs to be added to the system, only use Daphne Hermetic Oil FV Series.



# Vehicle dimensions and weights

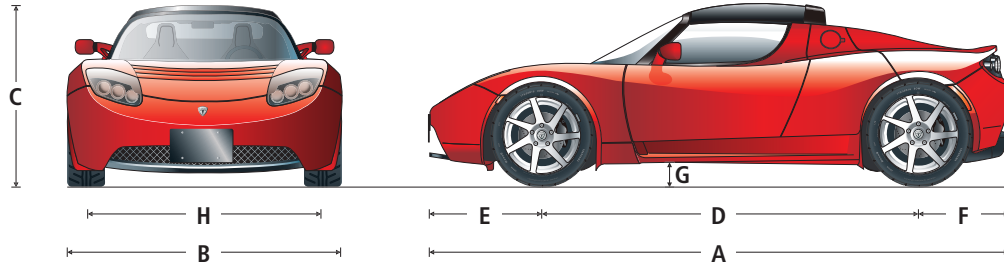

## Exterior dimensions

A	Overall length	155.4 in	3,946 mm
B	Overall width (including mirrors)	72.9 in	1,851 mm
C	Overall height (mid laden weight)	44.4 in	1,127 mm
D	Wheel base	92.6 in	2,351 mm
E	Front overhang	34.3 in	871 mm
F	Rear overhang	28.5 in	723 mm
G	Ground clearance (mid laden weight)	5.12 in	130 mm
H	Track - Front	57.7 in	1,455.6 mm
	Track - Rear	59.0 in	1,484.5 mm
	Approach (ramp) angle - Front		11°
	Approach (ramp) angle - Rear		18°
	Breakover angle		12.7°

# Vehicle dimensions and weights

## Vehicle weights

Curb weight (no occupants or cargo)	2,723 lb	1,235 kg
Mid laden weight *	3,053 lb	1,385 kg
Gross vehicle weight †	3,273 lb	1,485 kg
Maximum front axle load	1,144 lb	519 kg
Maximum rear axle load	2,147 lb	974 kg
Trailer towing	Not permissible	
* Mid laden weight is calculated with two 165 lbs (75 kg) occupants and no cargo.		
† Gross vehicle weight is calculated with two 220 lbs (100 kg) occupants and 110 lbs (50 kg) of cargo.		

## Motor

Type	AC induction motor, air-cooled, with variable frequency drive
Rating	375 Volts
Maximum speed	14,000 rpm
Maximum net power	248 HP (185 kW) @ 5500-6800 rpm
Maximum net torque	277 ft/lb (376 Nm) @ 0-4500 rpm
Efficiency	92% peak, 85% at max power

## Transmission

Type	Single speed fixed gear with electrically-actuated parking lock mechanism and mechanical lubrication pump
Overall final drive ratio	8.27:1
Reverse gear	Reverse direction of motor, limited to 15 mph
Final drive ratio	2.65:1

## Steering

Type	Rack and pinion
Number of turns lock to lock	2.8
Turning circle (curb to curb)	36' 3" (11.05 metres)

# Subsystem specifications

## Front suspension

Type	Roadster	Independent. Upper and lower unequal length wishbones. Co-axial coil spring/telescopic damper. Sway bar.
	Roadster Sport	Adjustable damping. Adjustable anti-roll bar.
Alignment	optimum	0.1 mm toe-in
	tolerance	0.5 mm toe-out to 0.7 mm toe-in overall Maximum side to side 0.3 mm
Camber	optimum	- 0.1°
	tolerance	+ 0.1° to - 0.3°. Maximum side to side 0.2°
Castor	optimum	+ 3.8°
	tolerance	+ 3.5° to 4.1°. Maximum cross castor 0.35°

## Rear suspension

Type	Roadster	Independent. Upper and lower unequal length wishbones. Co-axial coil spring/telescopic damper. Sway bar.
	Roadster Sport	Adjustable damping. Adjustable anti-roll bar.
Alignment	optimum	3.0 mm toe-in
	tolerance	2.4 mm toe-in, to 3.6 mm toe-in. Maximum side to side 0.3 mm
Camber	optimum	- 1.8°
	tolerance	- 1.6° to - 2.0°. Maximum side to side 0.2°

## Brakes

Type	Hydraulically operated. Tandem master cylinder with vacuum servo and Anti-lock Braking System.
------	--

## Subsystem specifications

Discs	Ventilated front and rear discs.
Hand brake	Cable operation of rear calipers. Self-adjusting for pad wear.

### Electrical

Type	Rechargeable Battery
Rating	13 V to 400 V DC, and up to 400 V AC
Polarity	Negative (-) ground

### Battery

Type	Lithium ion (Li-ion)
Number of cells	6,831
Weight	992 lb (450 kg)
Output	High voltage: 366V DC Low voltage: 13 V DC
Operating temperature	Driving: -1°F to 122°F (-17°C to 50°C) Charging: 32°F to 113°F (0°C to 45°C)

<b>A</b>		
Accessing your vehicle.....	4-2	
Accessory power socket .....	7-6	
Air conditioning.....	7-4	
Air distribution.....	7-4	
Air recirculation.....	7-4	
Air vents.....	7-5	
Airbags		
Deactivation.....	3-7	
Deployment effects.....	3-6	
Disposal information.....	3-8	
General information.....	3-6	
Obstruction of air bags.....	3-7	
Safety information.....	3-6	
Service information.....	3-8	
Warning indicator.....	3-7	
Warning labels.....	3-7	
Warnings.....	3-6	
Alarm system		
Indicator light.....	4-7	
Operation.....	4-7	
PIN code.....	4-7	
Switching off.....	4-7	
Ammeter display.....	6-11, 6-12	
Antifreeze.....	8-6, 10-14	
Anti-lock Braking System (ABS).....	6-5	
Anti-theft alarm.....	4-7	
<b>B</b>		
Battery.....	5-2	
Coolant.....	8-6	
Depletion.....	9-3	
Draining.....	9-3	
Environmental Note.....	5-2	
Fluid check and top-up.....	8-6	
Low Battery condition.....	9-3	
Preserving.....	5-3	
Range.....	6-3	
Specifications.....	10-19	
Battery Life		
Overview.....	5-2	
Body		
Cleaning.....	8-8	
Covering.....	8-9	
Polishing.....	8-9	
Removing tar spots.....	8-8	
Repairs.....	8-9	
Brake warning indicator.....	6-4	
Brake warning indicator light.....	6-12	
Brakes		
Anti-Lock Braking System (ABS).....	6-5	
Emergency braking.....	6-5	
Fluid specification.....	10-14	
Fluid top-up.....	8-5	
Foot brake.....	6-4	
Parking brake.....	6-4	
Regenerative braking.....	6-4	
Specifications.....	10-18	
Breakdown recovery.....	9-13	
Bulb replacement.....	9-9	
Bulb specifications.....	9-9	
<b>C</b>		
California Proposition 65.....	1-2	
Car covers.....	8-9	
Car washes.....	8-8	
Cargo capacity.....	10-7	
Central door locking.....	4-4	
Chains.....	10-10	
Change of ownership.....	1-2	
Charge level		
Low.....	9-3	
Charge level display.....	6-11	
Charging		
Charge level.....	5-2	
Charge settings.....	5-4	
Charge types.....	5-4	
Cost.....	5-5	
Current limit.....	5-5	
High Power Connector.....	5-6	
Performance setting.....	5-4	
Range setting.....	5-4	
Standard setting.....	5-4	
Storage setting.....	5-4	
Storing your vehicle.....	5-3	
Charging indicator light.....	6-12	
Charging port.....	5-6	
Child passengers.....	3-5	
Child restraints.....	3-5	
Child seat air bag hazard.....	3-7	
Child seats.....	3-5	
Cleaning		
Exterior.....	8-8	
Interior.....	8-9	
Removing tar.....	8-8	
Roof.....	8-8	
Underbody.....	8-8	
Wheels.....	8-9	
Windshield, windows and mirrors.....	8-9	
Wiper blades.....	8-9	
Climate control.....	7-4	
Contacting NHTSA.....	1-5	
Contacting Transport Canada.....	1-5	
Coolant		
Battery.....	8-6	
Specification.....	10-14	
Cost of charging.....	5-5	
Covering the vehicle.....	8-9	
Cruise control.....	6-9	
Cruise control indicator light.....	6-12	
Cup holder.....	7-7	
Current limit.....	5-5	

# Index

## D

Dashboard overview.....	2-5
Data recording.....	1-2
Defrosting.....	7-5
Dimensions.....	10-15
Doors	
Automatic locking when driving.....	4-5
Exterior door release.....	4-4
Interior door release.....	4-4
Locking.....	4-4
Mislocking.....	4-7
Unlocking with key.....	4-5
Driving.....	6-2

## E

Economical driving.....	6-3
Electrical current display.....	6-11, 6-12
Electrical specifications.....	10-19
Emergency braking.....	6-5
Emergency flashers.....	6-10
Emergency unlocking.....	4-5
Energy depletion.....	9-3
Exterior	
Dimensions.....	10-15
Overview.....	2-3
Exterior lights.....	6-6
Exterior mirrors.....	7-3

## F

Fan speed control.....	7-4
Fault indicator.....	6-12
Flat tire repair.....	9-4
Flatbed transporting.....	9-15
Fluid reservoirs.....	8-5
Fluid specifications.....	10-14
Front suspension specifications.....	10-18
Frost warning indicator light.....	6-12

## Fuse

Colors.....	9-7
Location.....	9-7
Specifications.....	9-8

## G

Garage door opener.....	7-14
Gear selector.....	6-3
Glove box.....	4-5
Ground clearance.....	10-15

## H

Hand brake.....	6-4
Hard-top	
Installing.....	7-12
Removing.....	7-13
Hauling your vehicle.....	9-15
Hazard warning.....	6-10
Hazard warning lights.....	6-10
Headlight high beam.....	6-7
Heated seats.....	7-5
Heater controls.....	7-4
Heating and ventilation.....	7-4
High beam headlights.....	6-7
High beam indicator light.....	6-12
High Power Connector	
Overview.....	5-6
High voltage.....	1-2
HomeLink.....	7-14
Hood closing.....	8-4
Hood opening.....	8-3
Horn.....	6-10

## I

Identification numbers.....	10-2
Instrument panel.....	6-11
Instrument panel lighting.....	6-14

## Interior

Door release handle.....	4-4
iPod.....	7-7
Light.....	7-6
Overview.....	2-5
Temperature.....	7-4
iPod.....	7-7

## J

Jacking the vehicle.....	9-11
--------------------------	------

## K

### Key fob

Battery replacement.....	4-3
Compliance.....	4-3
Programming.....	4-3
Replacing the battery.....	4-3
Using.....	4-2
Key fob battery.....	4-3
Key positions.....	6-2
Keys.....	4-2
Programming the key fob.....	4-3
Unlocking driver's door.....	4-5

## L

### Label

Airbags.....	3-7
Safety compliance certification.....	10-3
Tire.....	10-7
Lashing.....	9-15
LCD panel.....	6-11
License plate light bulb.....	9-10
Lifting the vehicle.....	9-12
Lights	
Bulb replacement.....	9-9
Exterior.....	6-6
Hazard warning.....	6-10

- Headlight high beam..... 6-7
- Instrument panel..... 6-14
- Interior ..... 7-6
- Replacing interior light bulb ..... 9-9
- Replacing license plate bulb ..... 9-10
- Replacing trunk light bulb ..... 9-10
- Warning indicators ..... 6-12
- Load limit calculation ..... 10-7
- Locking your vehicle ..... 4-2
- Low tire pressure indicator light ..... 6-12
- Lumbar support..... 3-2

## M

- Maintenance
  - Brake fluid ..... 8-5
  - Cleaning the exterior ..... 8-8
  - Cleaning the interior ..... 8-9
  - Daily checks ..... 8-2
  - Fluids..... 8-5
  - Owner maintenance..... 8-2
  - Paint repair ..... 8-9
  - Removing tar ..... 8-8
  - Routine maintenance..... 8-2
  - Service internal indicator ..... 8-2
  - Underbody ..... 8-8
  - Washer fluid ..... 8-6
  - Washer jets ..... 8-7
  - Weekly checks..... 8-2
  - Windshield wiper..... 8-7
- Master door locking switch..... 4-4
- Mileage..... 6-3
- Mirrors ..... 7-3
- Modifying your vehicle ..... 1-2
- Motor specifications ..... 10-17

## N

- NHTSA ..... 1-5

## O

- Odometer display ..... 6-12
- Opening the doors
  - Inside the vehicle..... 4-4
  - Outside the vehicle ..... 4-4
- Ownership change..... 1-2

## P

- Paint code ..... 10-2
- Paint damage..... 8-9
- Parking brake ..... 6-4
- Passenger airbag deactivation ..... 3-7
- Performance charge setting ..... 5-4
- PIN code ..... 4-7
- PIN lock..... 4-9
- Polishing the bodywork..... 8-9
- Power Limit warning indicator ..... 6-12
- Power meter display..... 6-11, 6-12
- Power socket..... 7-6
- Power windows ..... 7-2
- Pressure washers ..... 8-8
- Programming the key fob ..... 4-3
- Proposition 65..... 1-2

## R

- Raising the vehicle..... 9-11
- Range charge setting ..... 5-4
- Rear suspension specifications ..... 10-18
- Rear view mirrors..... 7-3
- Recovery eye..... 9-14
- Regenerative braking ..... 6-4
- Regenerative braking visual display 6-11, 6-12
- Regenerative braking warning indicator. 6-12
- Removing the hard-top ..... 7-13
- Replacement bulbs..... 9-9
- Reporting safety defects ..... 1-5

## Roof

- Hard-top ..... 7-12
- Soft-top ..... 7-10

## S

- Safety compliance certification label..... 10-3
- Safety defects..... 1-5
- Safety instructions
  - Child seats ..... 3-5, 3-7
  - Jacking the vehicle ..... 9-11
  - Lifting the vehicle ..... 9-12
  - Obstruction of airbags..... 3-7
  - Seat belts ..... 3-3
  - Tire repair ..... 9-4
  - Wearing seat belts when pregnant ..... 3-4
  - Windows ..... 7-2
- Seat belts
  - Care..... 3-4
  - Cleaning..... 8-9
  - General information..... 3-3
  - Pre-tensioners ..... 3-4
  - Reminder..... 3-4, 6-12
  - Safety instructions ..... 3-3
  - Testing ..... 3-4
  - Wearing ..... 3-3
  - Wearing when pregnant ..... 3-4
- Seat heater controls..... 7-4
- Seat heaters ..... 7-5
- Seats
  - Adjustment..... 3-2
  - Child seats and restraints ..... 3-5
  - Lumbar support..... 3-2
- Security ..... 4-7
- Security code..... 4-7
- Service data recording..... 1-2
- Soft top
  - Installing ..... 7-9
  - Removing..... 7-10



# Index

## Specifications

Antifreeze.....	10-14
Battery.....	10-19
Brake fluid.....	10-14
Brakes.....	10-18
Coolant.....	10-14
Electrical.....	10-19
Fluids.....	10-14
Front suspension.....	10-18
Motor.....	10-17
Rear suspension.....	10-18
Steering.....	10-17
Tires.....	10-4
Transmission.....	10-17
Wheels.....	10-4
Standard charge setting.....	5-4
Starter switch.....	6-2
Starting the vehicle.....	6-2
Steering column lock.....	6-3
Steering specifications.....	10-17
Storage charge setting.....	5-4
Storing your vehicle.....	5-3
Sun visors.....	7-6
Supplementary Restraint System (SRS).....	3-6

## T

Temperature control.....	7-4
Theft prevention.....	4-7
Tie Down Straps.....	9-15
Tire Identification Number (TIN).....	10-6
Tire placard/label.....	10-7
Tire pressure checking.....	10-9
Tire Pressure Monitoring System	
Malfunction.....	10-11
Operation.....	10-11
Tire repair.....	9-4
Tire sealant replacement.....	9-5

Tires.....	10-5
Care.....	10-8
Chains.....	10-10
Changing pressure settings.....	10-11
Degradation.....	10-10
Grading.....	10-7
Markings.....	10-5
Pressure monitoring.....	10-11
Pressures.....	10-4, 10-8
Quality.....	10-7
Replacement of.....	10-10
Replacing a tire sensor.....	10-11
Specification.....	10-4
Tire sealant.....	9-4
Wear.....	10-9
Winter.....	10-10
Winter specification.....	10-4

## Tool kit

Components.....	9-2
Location.....	9-2
Towing.....	9-13
TPMS.....	10-11
Traction control.....	6-5
Traction control indicator light.....	6-12
Transmission.....	6-3
Transmission specifications.....	10-17
Transporting.....	9-13
Trip display.....	6-12

## Trunk

Interior release handle.....	4-6
Light replacement.....	9-10
Opening and closing.....	4-6
Turn signal indicator light.....	6-12
Turn signals.....	6-7

## U

Uniform tire quality grading.....	10-7
Unlocking your vehicle.....	4-3

USB port.....	7-6
---------------	-----

## V

Valet mode.....	4-10
Vehicle Identification Number (VIN).....	10-2
Vehicle loading.....	10-7
Vehicle recovery eye.....	9-14
Ventilation.....	7-5
VIN (Vehicle Identification Number).....	10-2
Voltage warning.....	1-2

## W

### Warning indicator

ABS.....	6-5
Airbags.....	3-7
Anti-theft alarm.....	4-7
Brake.....	6-4
Cruise control.....	6-9
Fault.....	6-12
Frost.....	6-12
Headlights.....	6-7
Power Limit.....	6-12
Regenerative braking.....	6-12
Seat belt.....	3-4
Transmission control.....	6-6
Turn signals.....	6-7
Warning light summary.....	6-12
Washer fluid.....	8-6
Washing the soft-top.....	8-8
Washing the vehicle.....	8-8
Weekly checks.....	8-2
Weights.....	10-16
Wheel nut tightening.....	9-6
Wheel removal.....	9-6
Wheel replacement.....	10-10
Wheel specifications.....	10-4
Wheelbase.....	10-15

---

Windows .....	7-2
Windshield defrosting.....	7-5
Windshield washer	
Fluid top-up.....	8-6
Jets .....	8-7
Operation .....	6-8
Windshield wiper	
Checking blade .....	8-7
Operation .....	6-8
Winter tires .....	10-4
Wiper.....	6-8
Wiper blade inspection .....	8-7





[TESLAMOTORS.COM](https://teslamotors.com)

---