

39 LEAF ACORN·USER

BRITAIN'S BIGGEST MAGAZINE FOR THE BBC MICRO · ELECTRON · ATOM

OCTOBER 1984 £1

TRAILBLAZERS:
The origins of life
on a BBC micro

SCOOP REVIEW:
Elite - Acornsoft's
new blockbuster

CARTOON ANIMATION:
Move your characters
around the screen

UTILITY ROMS:
We pick the best
of six toolkits

UNCOVERED!
ACORN'S BUSINESS
COMPUTER

FREE GIFT
WITH THIS
ISSUE

DOUBLE MEASURE...

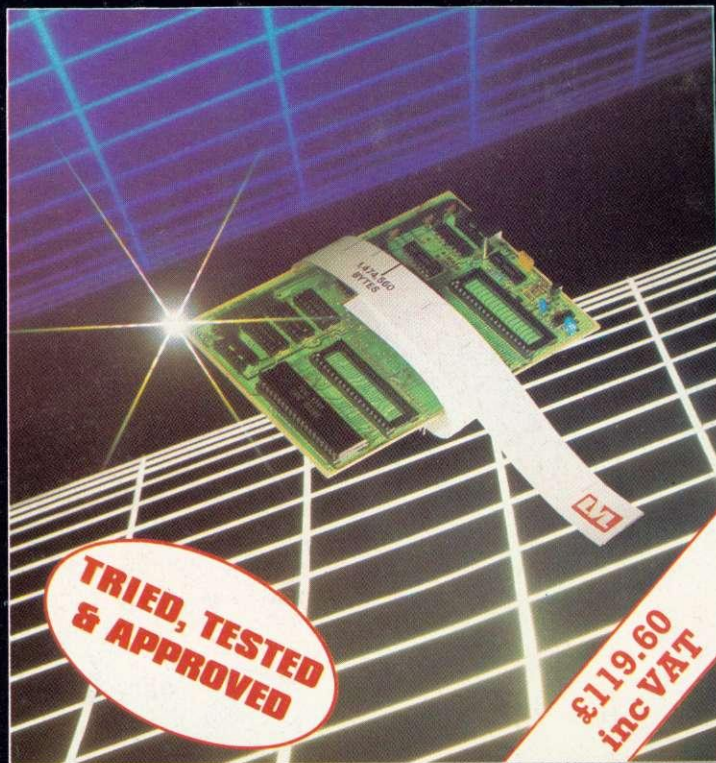

AVAILABLE FROM ALL LVL DEALERS. (FOR FURTHER INFORMATION TELEPHONE 0602 394000)

Twice as much storage capacity on your present or proposed discs.

The LVL *true double density* printed circuit board offers an amazing 1,474,560 Bytes of on-line storage, on a twin 80 track double density drive.

Removed is the 8271; (it is not capable of supporting double density). In it's place, a small printed circuit board with a new disc controller and support circuitry provides a much improved data retrieval. This drastically reduces read errors by using a phased locked loop data separator, which is superior to the standard window circuit.

Your BBC micro will now recognise the media density in the drive, and inform you if it is correct. You may define what density you require, 40 or 80 track, and which sides of the disc to use.

The device gives complete flexibility and comes with an Eprom containing firmware; manual, and a 40/80 track utilities disc. On a dual drive it is simplicity itself to copy existing software from single density to double density.

- Double Density
- Automatically checks for correct density
- No 8271 (Rare & expensive)
- Utilities provided
- Defaults to single density on power up
- 40 or 80 track
- Own PCB with separate 8Mhz clock
- Simple to fit
- User definable density
- Phase lock loop data separator circuit.



Scientific House,
Bridge Street, Sandiacre
Nottingham, NG10 5BA
Telephone (0602) 394000



20,000K Winchester Disc for your BBC Micro

INTEC MAKES THE BBC REALLY COMPETE WITH
SYSTEMS COSTING 2X AS MUCH!

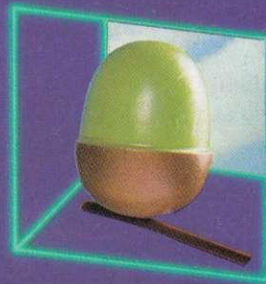

- ▶ Supports BBC and Acorn DFS.
- ▶ Full file handling and diagnostic software utilities.
- ▶ Data capacity from 5 Mb upwards.
- ▶ High speed accessing.
- ▶ UK manufactured.

The INTEC 505 gives all these benefits PLUS the removable hard disc cartridge providing a compact, secure and usable back-up or cartridge per application approach. Why pay more for less?

For full details on the INTEC range of hard discs for the BBC Micro, complete and post the tear-off slip or **phone INTEC now - 01-761 5999.**

INTEC
41A-45 Knights Hill
West Norwood, London SE27 0HS
Telex 8813271 GECOMS G

INTERFACE TECHNOLOGY
INTEC

Please Cut Out and Return
The INTEC Hard Disc Range
5-20 Mb Winchester and the fixed and removable 505.

NAME _____
ADDRESS _____
BBC _____

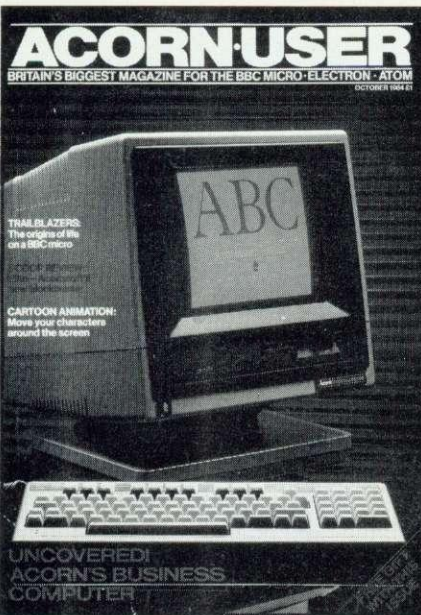

2

October 1984

No 27

Editor **Tony Quinn**
 Production editor **Keith Parish**
 Technical editors **Alex van Someren, Bruce Smith**
 Editorial assistant **Kitty Milne**
 Art editor **Nigel Wingrove**
 Art assistant **Frances King**
 Publishing director **Michael Potter**
 Editorial director **Christopher Ward**

Editorial
 Redwood Publishing,
 68 Long Acre, London
 WC2E 9JH. Tel: 01-836 2441

Advertising
 Computer Marketplace Ltd, 20
 Orange St, London WC2H 7ED.
 Tel: 01-930 1612

Subscriptions
 Jan Potter, Subscriptions manager.
 Tel: Nutfield Ridge (073782) 2957.
 Correspondence: Redwood Publishing, 68 Long Acre, London WC2E 9JH.

Annual subscription rates:
 UK £15
 Europe £25
 Middle East £30
 The Americas and Africa £30
 Rest of the World £35
 Prices include p&p for 12 issues

Acorn User welcomes submissions from readers. Articles should be typed, double-spaced text, with diagrams on separate sheets. Please enclose programs on disc or cassette, with a listing if possible. Photos should be 35mm, or larger, transparencies, or 5in by 7in black and white prints. Ensure your name is on everything. Please include a suitable stamped, addressed envelope for return. Articles are acknowledged on receipt.

Typeset and printed in Great Britain by Watmoughs Ltd, Bradford. Print production by Aquarius Print and Design, London. Distributed to the news trade by Comag, Tavistock Rd, West Drayton, Middlesex UB7 7QE. Tel: (0895) 44405.

© Redwood Publishing 1984
 All rights reserved. No part of this publication may be reproduced without prior written permission of the publisher. The publisher cannot accept any responsibility for claims or errors in articles, programs or advertisements published. The opinions expressed on the pages of this magazine are those of the authors and do not necessarily represent those of the publisher, Acorn Computers Ltd, or Acornsoft Ltd. Acorn, Acornsoft, and the Acorn symbol are the registered trademarks of Acorn Computers Ltd and Acornsoft Ltd.

New Users

- First Byte** **33**
Keyboard capers Start making music and other noises on your Electron, under the baton of Jeremy Vine
- Fly Killer** Tessie Revivis's asterisk turns into a full-blown fly that runs the gauntlet of the spray can. Design and move your own screen characters with deadly accuracy

- Hints & Tips** **51**
 Martin Phillips explains points that perplex readers: printing with daisywheel and dot matrix connected at the same time; outmoded operating systems; a scrolling text window; off-the-shelf procedures; and the ENVELOPE statement

- Letters** **59**
 What's on readers' minds? The 6502 second processor, professional typesetting from wordprocessors, high-scoring hit men, comparative reviewing

- Dear Kitty . . .** **62**
 What's the difference between ROMs and EPROMs? How do I know which software to buy?

Features

- Trailblazers** **27**
 In the first in our new series focusing on the more exotic uses that the Beeb is being put to, Chandra Wickramasinghe explains how his micro helped him advance a startling theory of life in space

Chipping in **81**

By programming the Beeb's 8271 floppy disc controller chip you can increase your data-handling power, says Richard Harris

All sorts **117**

See how sorting techniques work and you'll soon be able to pick the right one for the job. George Hill sorts them out

Self-diagnosis **123**

In the interests of cost-cutting and keeping your micro on the road, Paul Beverley helps you set up tests on the Beeb to diagnose its own ailments

Education

Primary scream **133**

The government claims success for its 'micros in primary schools' scheme, but is it of much help in practice? To Geoff Nairn the satisfied smiles look like smugness

Modules by Microtext **137**

Ian Birnbaum assesses Acornsoft's Microtext authoring system, which allows even inexperienced programmers to set up instructional quizzes and tests on the Beeb

Atom

Wordprint **143**

Alex Wilson provides Atom users with a wordprocessor that makes full use of all script facilities

Yellow listing pages

You'll find all the main listings of this issue in the yellow pages

First Byte	97
<i>Our fly gets its come-uppance</i>	
Hints & Tips	99
<i>Simple envelope generators</i>	
Animated sprites	100
<i>Move your character around</i>	
8271 programmer	102
<i>Disc copier</i>	
Beeb Forum	103
<i>Disc catalogue reader</i>	
Sorting	104
<i>Demonstrated in colour!</i>	
Self-diagnosis	107
<i>Choose a test routine</i>	
Atomic text	109
<i>Wordprocessing on a shoestring</i>	
Toolkits	112
<i>Sample utilities</i>	

Communications

Bulletin boards 167

The social side of communicating by computer is represented by bulletin boards, or free public access systems. Jeff Ashurst briefs you on how they operate, the equipment you'll need to become a registered user, and which BB to join

Reviews

Toolkit trials 157

Bruce Smith compares a fistful of Basic utility ROMs

Elite squad 165

Elite is Acornsoft's secret new space game. Tony Quinn is our test pilot...

Games 173

Blogger and *Bugblaster* from Alligata; *Horse Race*, *Pool*, *Corporate Climber* and *Lemming Syndrome* from Dynabyte; Screenplay's *Chickaroo*; First Byte's *Star Trader*; DACC's *Super 7* compendium; *Trench* by Virgin; *One to Nine* by Acornsoft; and *A Maze in Space* by Opus

Hardware 185

Sideways ROM sockets by Viglen and NMC give convenient and cheap expansion on the Beeb. Chris Drage compares them

Utilities 190

Bearsoft's Editor ROM; Watford's Buffer and Backup ROM; and Ampersand's Colour Module

Regulars

The News 7

Acorn's ABC - the specs, the facts; the Electron Plus 3, with 3in disc drive; instant program-entry with the MEP's bar-code reader; software on cable TV

Beeb Forum 113

Bruce Smith presents... NFS update; security for data files; testing the RS423; and finding the file-length

Top 20 software 155

Curse you, Caveman!

Free ads 201

Small ads 207

Acorn Abuser's Diary 184

Curried eggs and cabbages

IN THIS ISSUE...

Origins of Life 27

Chandra Wickramasinghe explains how he and Sir Fred Hoyle are using the humble BBC micro to help them research the origins of life on Earth and back up their theories on microbes coming from space



3

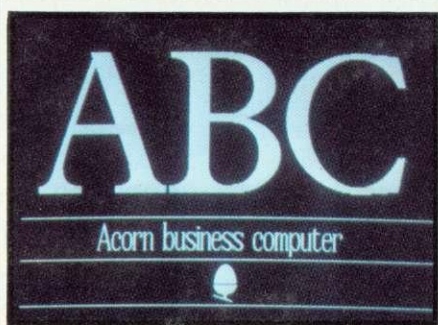

Cartoon time 65

How to move the sprites designed last month. Look out for the free demonstration to download on **Micronet** and **Viewfax**

EXCLUSIVE 7

Acorn's new computers
ABC is the name for the company's new range of business machines. Read the facts, not the guesswork

Acornsoft's Microtext 137

The National Physical Laboratory developed this language to help people who were new to programming write training and educational software. Ian Birnbaum reveals how well it succeeds



NEXT MONTH...

Bar codes come of age

We preview the MEP bar-code reader and present listings that can be input using this device

Buggies and Turtles

Six of these robots for schools and hobbyists are given a thorough going-over

Sideways ROMs

Joe Telford studies the popular chips and what will work with second processors

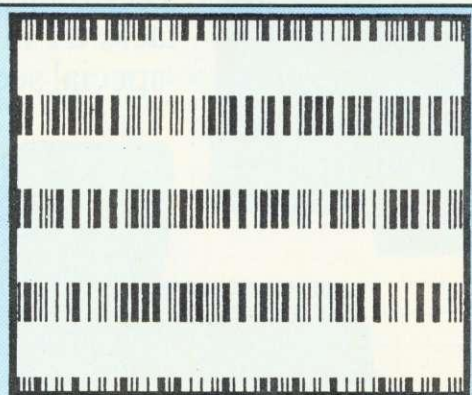

EUREK

A 100k BBC-drive for £99 + VAT

We've done it! We've built a mass storage system for your BBC Micro with the power and convenience of a floppy disk drive, but at a fraction the price. Get to know PHLOOPY, the remarkable new 100k drive that costs only £99 plus VAT, and a further £26 plus VAT for the interface to your BBC, operating system and connecting cables.

How PHLOOPY does it

PHLOOPY does not use disks to store data, but a 12-foot loop of professional-quality quarter-inch magnetic tape contained in a robust cartridge. The drive has only one moving part, the motor which drives the tape loop – hence the low price and high reliability. As the loop is driven round, each file of data it contains passes across the magnetic head which reads it or writes to it. Other people have produced tape loop micro-drives, but they've not been very reliable. They lacked PHLOOPY's special secret.

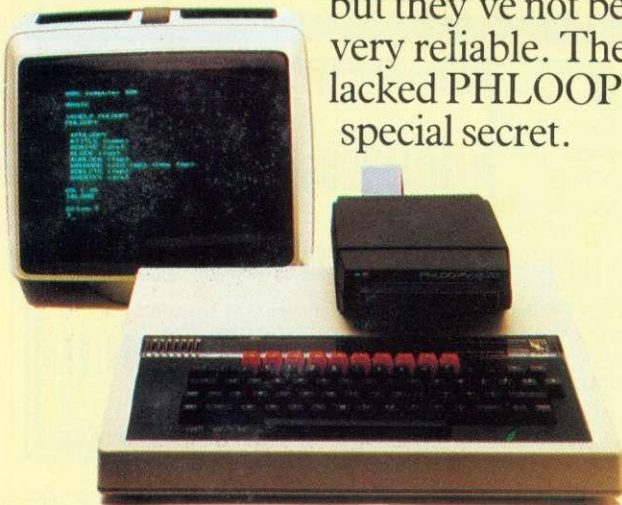

PHLOOPY's special secret



The heart of the invention is a brilliantly designed "byte-wide" magnetic head, made by Phi Magnetronics who build multi-track heads for professional use. PHLOOPY's head records and reads nine tracks across the width of a quarter-inch tape. That means the tape loop can be much shorter, so the typical time to access a file is reduced to a mere 3 seconds. If you're used to waiting for a cassette tape to trundle programs into your BBC, you'll be amazed at PHLOOPY's performance.

Getting it right every time

In addition, we've included a feature we know you will appreciate. PHLOOPY has full error detection and correction, so you can be certain you will get back what was originally written onto the tape.

Talking to your PHLOOPY

PHLOOPY's own software, contained in ROM, responds to standard BBC filing system and Basic commands. Most programs written to run on disk or cassette should run on PHLOOPY without problem.

And because PHLOOPY contains its own intelligent microprocessor – a second computer which does most of the hard work – PHLOOPY puts very

PHLOOPY

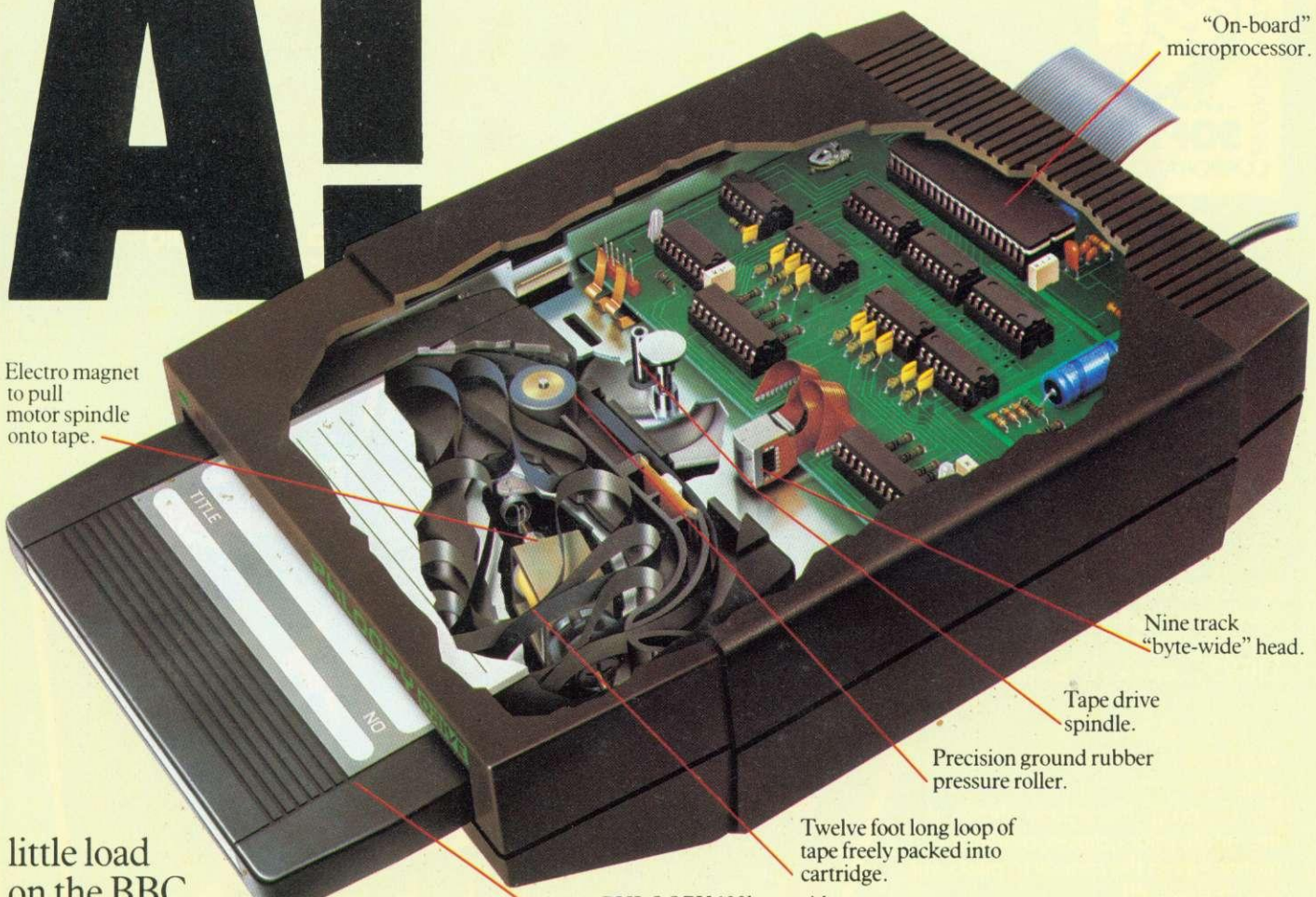

Electro magnet to pull motor spindle onto tape.

"On-board" microprocessor.

Nine track "byte-wide" head.

Tape drive spindle.

Precision ground rubber pressure roller.

Twelve foot long loop of tape freely packed into cartridge.

PHLOOPY 100k cartridge, shown not yet pushed fully home.

little load on the BBC and uses much less RAM than most disk systems.

Installing PHLOOPY on your BBC

You'll be amazed how simple it is to install PHLOOPY. Just plug in the interface cut two resistors (clearly marked in the instructions) and the job is done. If you should have problems our engineers are waiting to help you.

Making a PHLOOPY Library

PHLOOPY cartridges hold a full 100k of data or programs. Two of them come free with the drive and extra ones cost £3.75 each plus VAT. They are moulded of high impact polymers for protection and store easily on a bookshelf. Many programs will be available to purchase on PHLOOPY.



Phi Mag Systems Ltd.
 PO Box 21, Falmouth,
 Cornwall TR11 3TD.
 Telephone: (0326) 76040.

Order Form

- Please send me further details about the PHLOOPY 100k data storage system for the BBC Model B.
- Please send me _____ (qty) PHLOOPY starter pack(s) for my BBC Model B microcomputer, including PHLOOPY drive, BBC interface, leads, connections, operating system in firmware, manual, and two PHLOOPY 100k cartridges, at £147.75 each including VAT, postage and packing. Amount £ _____
- Please send me _____ (qty) packs of 5 PHLOOPY cartridges at £19.75 including VAT, postage and packing. Amount £ _____

I enclose a cheque/PO for £ _____ OR Please debit my Access card: Number: _____
 Your order will be acknowledged within 10 days, giving a delivery date.
 Name _____
 Address _____
 Town: _____ Post code _____

Send this coupon to:
 Phi Mag Systems Ltd, PO Box 21, Falmouth,
 Cornwall TR11 3TD. Telephone: Falmouth (0326) 76040.
 14 day money-back option.

TEACH YOUR COMPUTER SOME NEW TRICKS

Transform your computer into a letter writer, a chess master, a design aid—
with these high-quality programs from BBC Publications.

Word Mover

An easy-to-use text editor offering many of the facilities of a word processor—but none of the complications. It gives you a wide choice of display, editing and printing options.

£9.95 Cassette/booklet
For Model B or Electron

Game Core

This intriguing package shows you how to write your own computer board games. It includes three ready-made games, and a fourth one that is explained in detail as a tutorial model.

£10.95 Cassette/booklet

Astronomy

Vivid graphical demonstrations which bring astronomical subjects to life. The programs include phases of the moon, solar eclipses, planetary motion—even the chance to pilot your own spacecraft!

£13.80 Disc/booklet
£9.20 Cassette/booklet

Drawstick

This friendly program can produce elaborate high resolution pictures and patterns in four colours. It enables children to create pictures, charts, maps and diagrams, and can be used as a Computer Aided Design tool. It includes a fast 'save' routine.

£9.95 Cassette/booklet

White Knight Mark 11

This powerful chess program is now available for the Electron. It outclasses and outplays several well-known chess programs, and compels even experienced players to treat it with respect!

Cassette/booklet

Model B version £11.50

Electron version £9.95

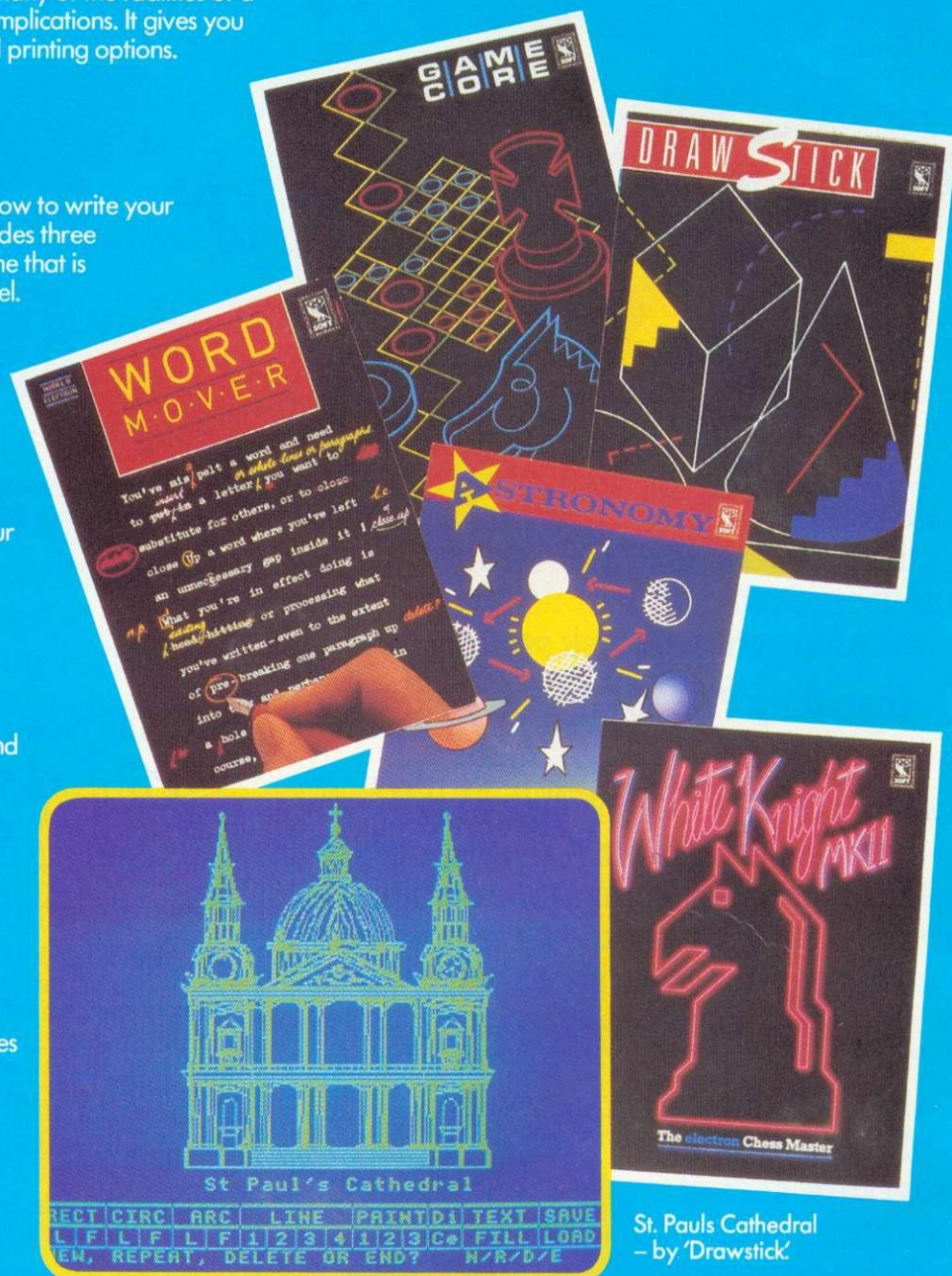

St. Pauls Cathedral
— by 'Drawstick'



Word Mover will run on your Electron. An Electron version of White Knight is now available

FROM BOOKSELLERS AND SOFTWARE DEALERS

All software is for the British Broadcasting Corporation Model B Microcomputer except where indicated. Every pack includes full documentation. Prices include VAT.

40813

New Acorn micro

ACORN'S new business range will be based around a repackaged BBC micro with two 16-bit second processors available. There will be eight variants under the generic name ABC - Acorn Business Computer.

Top of the range is the ABC310 running an Intel 80286 second processor giving IBM PC and XA (Popcorn) compatibility, with ikon software and high-resolution graphics.

The 16-bit operating system will be Concurrent, a development of version 3.1 from Digital Research. It is capable of performing several tasks at the same time and dividing the screen into windows.

As our picture shows, a full professional keyboard with separate numeric keys links to a box containing the 6502 processor used in the Beeb, topped by a monitor.

The monitor tips forward, giving access to internal sockets where second processor and hardware cards can be added.

The machines should be on view at dealers in November, with deliveries starting in the New Year. The whole range



SCOOP: first sight of Acorn's much-awaited business computer

EXCLUSIVE

should be available by Easter, says Acorn. Prices have yet to be released.

Bottom of the range is the Terminal, which is exactly what its name says. It will not be expandable, and comes with terminal emulator software and Econet as standard. The monitor is a 14in monochrome with 32k RAM and no disc drive.

Next up is the Personal Assistant wordprocessor. It

comes with one double density, 5.25in drive giving 700k of storage. A 12in monitor comes as standard, as do View and Viewsheet. Second processors and other hardware can be added, right up to the top of the range configuration.

The ABC100 includes the Z80 second processor running CP/M and two 700k drives as standard. The three Plan software packages are included, and have been enhanced (see June's AU). The ABC110 is similar, but with one drive replaced by a 10Mb Winchester

hard disc and colour monitor.

Whereas the 100 machines cover office productivity, the ABC200 and 210 are loosely described as 'academic workstations'. The 32016, the 16/32-bit chip is included with disc variations as above. Standard RAM is 256k. A choice of programming languages will include C, Modula2 and Pascal. The Xenix operating system comes with the Winchester on the 210.

Flagship of the series are the 'executive workstations' with the 80286 16/24-bit chip. The 300 will carry two 700k drives and monochrome moni-

page 9 ▶

Electron Plus 3 disc interface - page 9

Using your free function key strip

THE FREE gift on this month's front cover is designed as a re-usable function key strip for BBC micros and Electrons.

Using a chinagraph pencil (about 30p from art shops), you can mark in key definitions for your own programs. It slots under the BBC's clear plastic strip, or can be taped onto the Electron. We hope you find it useful.

30,000 flock to Acorn User show



THIS year's Acorn User show was the first to be held at the new Olympia 2 exhibition hall. More than 30,000 people passed through the turnstiles over four days, but with the new venue there was little of the overcrowding which dogged last year's show.

Acorn had the largest stand running 'live' demonstrations. Said Acorn's Graham Winnard: 'For the first time we're using technical people instead of sales staff to demonstrate the products. The demonstra-

page 9 ▶

QUALITY NEVER LOOKED SO GOOD -

Now everyone with a BBC or IBM PC will want to get their paws on CUB's sleek new D series plastic cabinet - a triumph of ergonomics and up to the minute design. Within it is the CUB 653 MEDIUM RESOLUTION colour monitor - the perfect mate for computer users who wish to combine the advantages of brilliant, low cost colour graphics with 80 column processing software.

CUB 653's remarkable depth of colour is enhanced by minimal screen glare thanks to a super high contrast CRT. Even in well lit environments the 653 (H) x 585 (V) resolution and 0.43mm dot pitch produces 80 column text which is pin-sharp and easy to read. Owners of SHARP, RML 480Z, APPLE Series, WANG and other leading computers needn't feel left out, because CUB 653's compatibility extends to these models and many more.



PICK ONE UP FOR JUST £299 inc. VAT

NEW LOW PRICE, NEW PLASTIC CABINET - THERE'S NEVER BEEN A BETTER TIME TO BUY.

Standard Resolution version also available in new cabinet. Both Standard and Medium resolution models produced in metal cabinets if required.



MICROVITEC 653
CUB
COLOUR DISPLAYS

Microvitec PLC, Futures Way, Bolling Road, Bradford, BD4 7TU, West Yorks
Tel: (0274) 390011 Telex: 517717

Available from High Street Computer Retailers and selected branches of W. H. Smith, Harrods, John Lewis Partnership, John Menzies with selected models available from larger branches of Boots.



1984



Bird's eye view: plenty of people with space to move

Show hit

◀ page 7

tions have been very successful and attracted a lot of interest.'

Three new 'add-ons' for View and Viewsheet were announced: a Printer Driver Generator at £9.95 (£11.50 disc); View Index, for producing an index of pages, at £14.95 on disc only; and Hi-View, a £59.80 version of View to use with the 6502 second processor.

Hi-View offers more free memory than the ordinary View but is only available on disc—the high price is to protect sales of the ROM-based View.

Torch, now part of Acorn, was showing off the Graduate, the add-on which makes the BBC IBM PC-compatible. 'We're getting a lot of interest from large companies, education and small businesses. If you put an order in now you could get one in November,'

promised Adam Lewis.

Making a debut was a £65 robot construction kit from Micro Robotic Systems. Using Fischertechnik parts (as used in the BBC Buggy) several different experiments can be built. With the addition of a £32 interface, the experiments can be controlled from the BBC micro. Experiments include: a plotter, a robot arm, Tower of Hanoi and a sorting system. Micro Robotic Systems is at 20 Penywern Rd, Earls Court, London SW5 9SU.

The first mouse for the BBC micro was on the AMS stand. The designer, Dave Brader, was still working on the software, but it appeared to provide a much quicker method of editing text and drawing graphics.

The device has been curiously renamed the AMX Mouse and will go on sale in October for £79.95. Dave was also promising an EPROM programmer—though it wasn't available in time for the exhibition.

Electron gets microdrives in Plus 3 box

ELECTRONS will not come down in price at Christmas says Acorn, and a big sales push will be headed by the Plus 3 add-on incorporating a 3.5in disc drive.

The machine will be promoted as the basis of an expandable system which will be around for a long time, with Plus 3 proving the point. Extra hardware can be plugged into the spare cartridge socket on the Plus 1 to add interfaces such as RS423.

No firm price has been announced for the Plus 3, but it is likely to be about £250. This includes the drive and interface in the add-on box.

Special deals will be offered on combinations of Electron and add-on boxes or software,

as with the Me and My Micro pack released last month.

The missing Plus 2 will supply Econet and won't be out until next year. View and Viewsheet will be released for the Electron before Christmas.

Acorn's choice of the 3.5in drive will no doubt anger the existing microdrive market for the BBC micro, which has plumped for the 3in version. However, Acorn decided the standard will be fixed by the big business companies going for the larger format.

The Plus 3 uses the newer 8272 floppy disc controller chip as in the ABC machines. The BBC micro uses the 8271, which is in short supply and cannot support double density discs.

Micros live on BBC TV

BBC TV's new computer magazine series, Micro Live, will go out monthly from Friday, October 5.

Leslie Judd, of Blue Peter fame, and Ian McNaught Davis will be up front, with special reports on America by Freff from June's Micro Live.

Producer Patrick Tittley explained that the shows will go out live and have a topical

flavour. 'It will be a fast moving magazine programme—like a printed magazine.'

There will be six programmes, each lasting 30 minutes on BBC2, probably at 6pm.

A bulletin board will be set up for viewers—and Patrick Tittley hopes Acorn User readers will contact them with news stories.

New micro

◀ page 7

for while the 310 will have a single drive plus Winchester and colour screen. Again 256k RAM is standard, but upgradable to 1Mb.

A mouse will be released next year for the 300 machines, along with a modem card for the range.

Interfaces are as on the BBC, but with no TV socket and some of the connectors will be changed.

Howard Fisher, ABC project leader, said: 'Our research shows people want computers that work, and this range has

been designed to meet needs we have identified. They match very specific requirements.'

On the question of performance, he declared: 'The 80286 machines are up to five times faster than the IBM PC on benchmarks.'

Tom Hohenberg, Acorn's marketing manager, added: 'The ABC range is a neater alternative for the BBC micro, aimed at business users. There is no conflict with the BBC itself.'

'We've gone for a modular technique to save space and make it a doddle for the engineers.'

Bar code listings aim to cut down typing

BAR codes are set to become more than just things on cans of beans with the launch of a reader pen for the BBC micro in October costing £50.

And *Acorn User* will be supporting the project by Addison Wesley, which has MEP backing, with program listings printed in bar code.

Schools will be the initial target, but a consumer pack will follow. The pen enables people to enter software without any typing and produce actual listings in the form of bar codes for distribution.

A pack consists of the reader pen, which measures 2x4x1/2in, cassette or disc with demonstration and driver programs, template for producing bar codes by hand and a user guide written by AU author George Hill.

The software will decode the bar system used in supermarkets and there is a music program.

For more details contact Addison Wesley at Finchampstead Rd, Wokingham, Berks RG11 2NZ.

See next month's issue!



TAXAN has released two centronics NLQ printers. Their main forte is the near letter quality print (NLQ) of the dot matrix head. The two models, the KP810 and KP910, feature 160cps bi-directional printing, a half speed 'quiet' mode, friction and adjustable tractor feed plus roll paper. Both are available at £229 for the KP810 and £399 for the KP910 from Data Efficiency, Maxted Road, Hemel Hempstead, Herts.

One winner from 8000 entries

THE competition set in May's *Acorn User* was the most popular ever. To say we were overwhelmed at the response would be a gross understatement—more than 8000 readers entered! The incredible response, with some excellent and thought-provoking solutions, has been the prime factor in the result being delayed and we thank you for your patience! Now to the competition.

You will remember that Simon Dally set the task of counting from 1 to 1,000,000 in the quickest time possible. The first task for most of you was to decide what was meant by 'counting from one to one million'—but that was all part of the competition.

Many entries were based around using the two user and two system VIA timers to 'count' in around 0.25 seconds. These entries were disqualified because they did not count to a million—they simply counted to 250,000 each. Although the sum of the four counters is indeed 1 million, the rubric clearly stated count from one to one million.

The second most common entry was based on the fact that the computer performs so many operations in so many cycles. With the Beeb operating at 2MHz it would be possible to determine when a million cycles had been performed simply by creating loops of machine code that contained a set number of cycles. The quickest time would therefore be 0.5 seconds. However, entries using this technique were discounted because, again, a physical counter incrementing from one to one million was not involved.

'After a final four-hour deliberation the winner was chosen'

The acceptable solution was to use 24 bits anywhere within the Beeb that would be loaded with 1 and then incremented to a total of one million. The three bytes needed to do this could have been the three processor registers, three memory locations or a combination of each.

After much sorting and sifting, the 8000 entries were whittled down to a final selection that all used the three-

byte counter and all gave results of one second, or fractionally over. After a final four-hour deliberation late one Friday night the winner was chosen; John Faris from Oakham in Leicestershire. John's time was a staggering 1.004856 seconds.

Now, all you readers who had times of 1.00 or 1.004 seconds—don't write in. The level of timing accuracy varied and all times of one second, plus a fraction, were considered in the final analysis.

John used the accumulator (least significant byte), X register (middle byte) and a zero page RAM location (most significant byte) to act as his counter. The program was written in assembler and used macros to assemble sets of the appropriate incrementing instructions. Extra speed was gained by turning off the system timers to inhibit the household interrupts issued every 10msecs, giving around a 5 per cent increase in speed.

So £1200 of wordprocessing equipment wings its way to John Faris with our hearty congratulations. Two second prizes of Acorn spark-jet printers go to Chris Wedge of Folkestone and Colin Edwards in Sussex. In addition, we are giving a special prize to the slowest entry. This is not intended as a booby prize, but as a reward for entering the competition in the spirit in which it was intended.

Finally, we are unable to enter into any correspondence regarding the competition. All decisions are final.

Once again, congratulations to all prize winners and thanks to everyone for entering.

Print from Japan



Disk Drives from Cumana



- High quality 5 1/4 inch Japanese disk drives
- Cabinet finished in hard wearing BBC beige
- 12 months warranty
- Fully assembled and tested



Like the beautiful prints from Japan, Cumana disk drives represent the very highest standards in design and production. Also like the prints, Cumana disk drives represent the highest state of the art; and they not only look beautiful, they perform beautifully as well.

Cumana disk drives for the BBC Microcomputer are available in slimline single, dual and dual switchable versions. They have 12 months warranty, are fully assembled and tested before packaging, and are available — at unbeatable value for money prices — from W. H. Smith, The John Lewis Partnership, Greens Leisure, Laskys, Spectrum UK, area distributors (see below) and Cumana's national dealer network.

Look out for the distinctive Cumana packaging in your high street, today!

Area distributors:

HCCS Associates (Gateshead) 0632-821924, Eltec (Bradford) 0274-722512, Basic Business Systems (Nottingham) 0602-819713, Walters Computer Systems (Stourbridge) 03843-70811, Microage Distribution (North London) 01-205 7688, J. S. Simnett Computers (South London) 01-541 1495, Gwent Computers (South Wales) 0633-841760, National Micro Centre (Stockport) 061-429 8080, Microworld (Edinburgh) 031-228 1111, Microtest (Cornwall) 0208-3171, DRG Business Machines (Weston-Super-Mare) 0934-415398, Kingdom Design (Belfast) 0232-643720, Hugh Symons (Bournemouth) 0202-26535, Audio & Computer Centre (Jersey) 0534-74000, Peco Electronic (London) 01-543 1030 (Brighton) 0273 688395/6, Clwyd Technics (North Wales) 035 283 766, + National Dealer Network.

The Highest State of the Art



Cumana Limited,
Pines Trading Estate, Broad Street,
Guildford, Surrey, GU3 3BH.
Telephone: Guildford (0483) 503121.
Telex: 859380.

For further information about Cumana disk drives for the BBC Micro, please complete and return this coupon.

Name _____

Address _____

Interests:

Home Use

Education

Dealer

Business

Tel. No. _____

AU10/84

Note: If dealer, please attach this form to your letterheading.

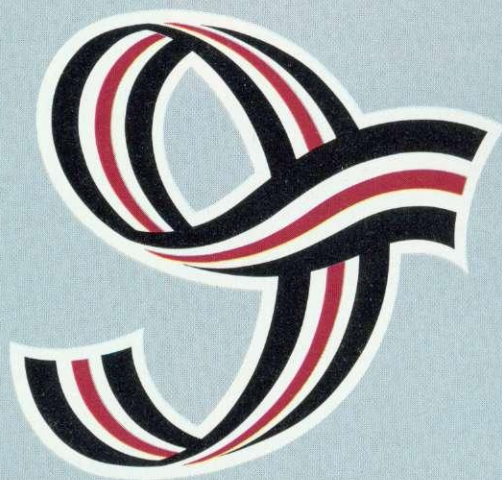

The Graduate.

**The first IBM PC
compatible upgrade
for the BBC model B micro.**

w
th
ra
M
c
a
ra
so
c
a
h

o
C
us
(
in
IB
T
do
dr
in

From only £764.00 the new Torch Graduate will upgrade your BBC Model B to a powerful 16 bit business computer

TECHNICAL SPECIFICATION



- 8088 16-bit processor running at 5 Mhz
- 128K or 256K RAM
- MS™-DOS operating system customised to IBM compatibility
- Model G400 – Single, double sided, high density disc drive (320K formatted)
- Model G800 – Twin, double sided, high density disc drives (640K formatted)
- Integral stabilised power supply
- 2 IBM PC compatible hardware expansion buses
- Software compatibility allows Lotus 1-2-3 and all popular IBM PC business programs to run without modification, subject to the constraints of the BBC keyboard and display
- Disc interface is not required
Keyboard text and graphics supplied by BBC Model B

• THE GRADUATE •

Disc and hardware compatible with the IBM PC, the Graduate is the latest addition to the Torch range of BBC upgrades. It's MS™-DOS operating system is customised to IBM compatibility allowing exploration of the massive range of IBM compatible business software, programming aids, compilers and languages universally available from most major software houses.

Introduction to MS™-DOS

The Graduate offers two levels of upgrade, the G400 and the G800, both with 128K on board user memory as standard (optionally 256K). This can be increased to 1.2 Mbytes with an IBM compatible expansion board. The G400, contains a single, double sided 320K formatted disc drive and provides the low cost introduction to MS™-DOS for the

user who wants real 16 bit power from his Model B.

More data storage

A step up from the G400 is the G800 which offers twin, double sided 320K disc drives for extra data storage. Both the G400 and the G800 provide the possibility of further expansion for networking, modems, etc., via the IBM compatible hardware slots provided

by the Graduate models. Each model comes complete with a well written user/technical manual and connecting leads.

Just plug it in

Unlike other add-ons there is no need to open the BBC to make the connection. The compact and tidy Graduate models simply plug in to the 1MgHz bus on the Model B. Within minutes you can be up and running with an IBM PC compatible system that really means business.

The range

Add 256K RAM, 640K disc storage and IBM PC compatibility to the BBC Micro for less than £1,000.

Graduate G400 (128K) £764 inc. VAT
Graduate G400 (256K) £815 inc. VAT
Graduate G800 (128K) £949 inc. VAT
Graduate G800 (256K) £999 inc. VAT

For further information complete the coupon today.



TORCH COMPUTERS

Lighting the way ahead.



Torch Computers Limited
Abberley House, Great Shelford, Cambridge CB2 5LQ.
Telephone (0223) 841000. Telex 818841 TORCH G.

The Graduate is manufactured by Torch Computers under licence from Data Technologies Ltd.

To: Torch Computers Ltd., Abberley House, Great Shelford
Cambridge CB2 5LQ. Telephone (0223) 841000
Please send further information on the Graduate and the
address of my nearest dealer.

Name _____

Address _____

Post Code _____

Telephone _____

AU10



MD 400
£155.65
+ VAT = £179

MD 800
£312.17
+ VAT = £359

MD 800P
£373.04
+ VAT = £428

BBC Compatible Mitsubishi Slimline Disc Drives

These are high capacity, precision drives with dynamic clamping and very low power consumption. All drives are supplied with cables, a very comprehensive utility/format disc and a manual.

MD 400 — 400K (800K double density) 40/80 track switchable double sided single drive.

MD 800 — 800K (1600K double density) independently 40/80 track switchable double sided dual drive.

MD 800P — 800K (1600K double density) independently 40/80 track switchable double sided dual drive unit with built-in power supply and monitor stand.

Opening Hours: Mon-Fri 9am-6.30pm
Sat 10am-5pm (ample parking)
We accept telephone orders on Barclay
and Access Cards.

Mail Order: Cheques or bankers draft
payable to Akhter Instruments.
Delivery free of charge (UK only)



COMPUTER GROUP

28/29 BURNT MILL, HARLOW, ESSEX CM20 2HU UK.
TEL. HARLOW (0279) 443521 TELEX 818894 AKHTER G

Dealer Enquiries
Welcome

Cable TV to transmit software for micros

A SPECIAL cable TV service aimed at home micro users is set for launch next year. Information and software will be transmitted as teletext by Thorn-EMI, one of the largest entertainment groups in the UK.

Adapters will be needed to download telesoftware, but the information pages will be accessible by anyone with a teletext television set. The service will be restricted to subscribers in major towns.

Unlike broadcasts by the BBC and IBA, where teletext information is transmitted between television frames, Thorn-EMI's service will be 'full-field'. This means that the whole cable channel is given over to teletext.

Richard Wolfe, who heads the project, said: 'The channel will transmit 5,000 different pages every second. Each month the subscriber will be able to download between 20 and 100 different programs.'

'This year we're still in an exploratory mode but we should have a commercial service running in autumn 1985.'

Thorn-EMI already transmits teletext with the Music Box cable service, but it's squeezed between the picture frames in the conventional manner. At the moment it runs to 20 pages of music-related material: the Top Ten, tour



Music Box logo

news and video reviews.

Music Box will be available in about 40 towns by September to potentially one million homes. For £5 a month you get Music Box and three other channels. Premium services—for feature films and the like—cost about £7 a month extra. The full-field teletext service will be a premium channel.

Richard Wolfe explained: 'We're waiting for full-field teletext chips to come out next year before deciding on the hardware. Obviously with the conventional teletext service we're looking for adapters for the popular home micros and certainly the BBC micro will be one of the machines we'll go for.'

A full-field teletext service can offer many more pages than the IBA's Oracle, so rather than trying to compete in the mass market the IBA is revamping Oracle to attract commercial customers. As revealed exclusively in *Acorn User* last month, the IBA

intends to add subscription-only pages of specialised information—the latest Stock Market prices for example.

As the Bill to permit this went through Parliament, John Gorst MP had suspicions that by charging for teletext pages, 'the IBA may now, in a back door way, be entering the interactive services of cable television.'

Douglas Hurd, the Home Office Minister set him straight: 'The IBA is talking about a one-way service, whereas interactive services are, by definition, two-way.'

When asked about whether the IBA had considered full-field teletext, Pat Hawker, a technical spokesman, commented: 'Unfortunately there are no spare channels for broadcasting full-field teletext. Instead we are expanding the conventional teletext service and will add some subscription-only pages for commercial users.'

'Using Oracle, you can't go much above 100 pages before the access time gets too long. Full-field teletext potentially offers 100,000 pages with similar access times to Oracle.'

The IBA was hoping to run a full-field teletext service using the now-obsolete VHF television channels. Unfortunately the proposal was turned down and the channels went to cellular radio.

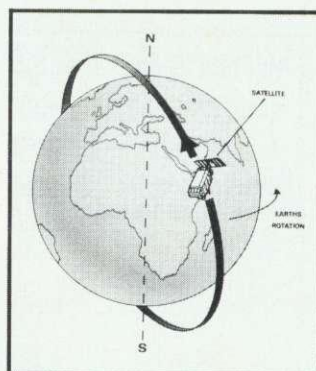

Aerial links to satellites

FOLLOWING on from August's article on downloading weather satellite pictures, Weston Developments is offering a suitable aerial for £31.75 (plus £4.50 p&p). Called WB6/Uosat, it is specifically designed for receiving satellite signals on the 136MHz band.

You need your own cable, but a filter box is available at £9.85 to match cable to aerial.

Further details from Roger Bunney, Weston Developments, 33 Cherville St, Romsey, Hants SO5 8FB.

Ultracalc boost

ULTRACALC, the BBC's spreadsheet chip, has been upgraded. All reported bugs have been fixed and it now works with any BBC screen mode. When running with a second processor, the program is automatically relocated and 45k of memory is then available in mode 0.

Owners of the existing version can get the new chip for a 'nominal' price when it becomes available at the end of this month.

Contact BBC Publications, BBC, 35 Marylebone High St, London W1M 4AA.

School challenge

BRITISH Gas is running a computer-based competition for secondary schools. Using a BBC micro program called Cedric, students have to conduct a survey in homes and suggest a plan for saving energy. The best school entry wins £1000, and there are prizes for individual students.

Teachers can obtain a free copy of Cedric from Mr R Wolfe, Education Liaison, British Gas, 326 High Holborn, London WC1V 7PT. Closing date is the end of the year.

15

Electron board runs BBC firmware

THE Electron can now use software on a chip intended for the BBC micro. Broadway Electronics' sideways card costs £29.95 and can hold four sideways ROMs.

The company claims it will work with about 60 per cent of BBC ROM software, but not View or Wordwise.

It plugs onto the Electron's edge connector and further expansion cards can then be plugged into the ROM card. Also available are a £45.95 user port/printer interface and a £39.95 analog interface.

These use the same chips

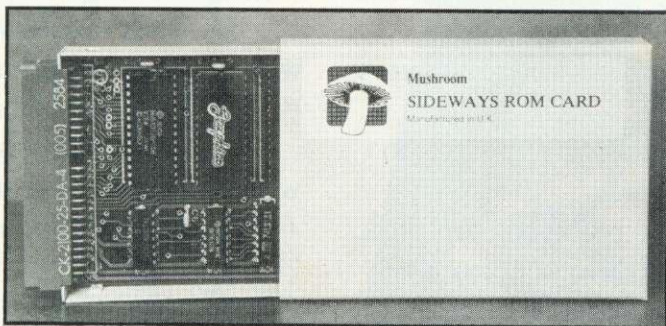

Electron sideways ROM card from Broadway

as the BBC micro and so have the same features.

Further details from Broad-

way Electronics at Aston Road, Bedford, Beds MK42 0LJ.

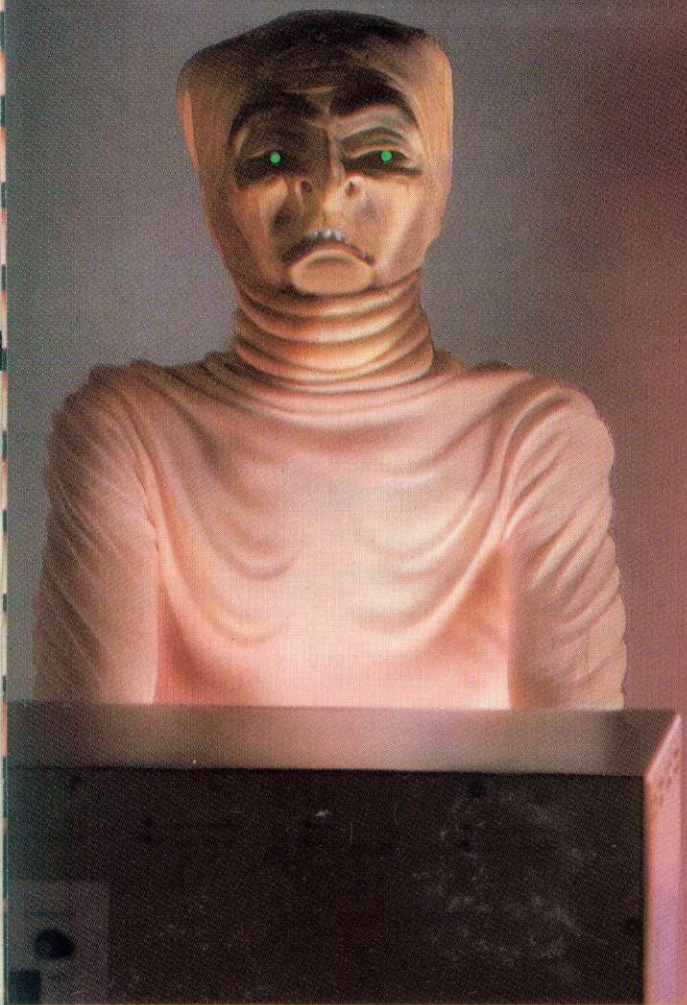

Will you be the first Earthling to win a ple

Acornsoft are issuing a nationwide challenge to all Acorn Electron and BBC Micro users.

It's the challenge to join a new and exclusive group of computer games players: The Elite.

With 3-dimensional graphics, Elite is a game which is light years ahead of any other.

It strictly defines the rank of each and every player.

As your prowess improves, you move into higher ranks.

But make no mistake, to reach the top rank, your performance must become exceptional.

Then, and only then, will you qualify to call yourself a member of The Elite.

From harmless, you must become lethal.

In Elite, all players start as equals.

With the initial rank of "Harmless," you will

embark upon an experience unlike any that you have known before.

You will be a space trader who roams the universe, making your living from buying and selling the cargo in your Cobra space craft.

On your travels, you will encounter aggressors who are eager to put an end to your dealings.

Only the fittest will survive.

As you establish yourself as a survivor, you will win the right to a higher rank.

In all, there are nine, from "Harmless" to "Elite." And your computer will continually tell you where you stand.

Trade with 2,000 planets in eight galaxies.

Besides survival, your success also depends on the rewards you reap from the cargo that you carry.



Elite among the Elite?

you That cargo can be anything from foodstuffs
to contraband. If you decide to trade in contra-
band, the rewards will certainly be higher. But so
and will the risks you take.

To ply your trade, you can dock at any of
2,000 planets in eight galaxies.

However, before you dock, you must use your
wits to assess the planet's political climate and the
perils which may be waiting for you.

Also, in any of the eight galaxies, you may
find yourself being asked to perform acts of con-
siderable heroism and selfless courage.

Although these will bring you into danger,
they can bring considerable rewards too.

We're waiting to recognize your skills.

Achieving higher status in Elite will tax your
skills to the limit. Which is why you must down-

load your game onto cassette or disc each time
you take a break from play.

When you reach the rank of "Competent"
or higher, you should send us the secret code
number revealed to you by your computer.

We will send you in return a special document
which certifies your achievement. And you stand
to win a valuable prize.

Are you ready to
accept the challenge?

Elite is available on
both disc and cassette
for the BBC Micro and
on cassette for the Acorn
Electron.



With either, you will get "Elite: The Dark
Wheel," a compelling novel which sets the whole
mood of your adventure. You'll also get a flight
training manual which will get you fit to roar into
the unknown in your Cobra spacecraft.

Your Acornsoft dealer now has the entire
package at £14.95 on cassette, or £17.65 on disc
(for the BBC Micro) and £12.95 for the Electron.
(For the address of your local stockist, call
01-200 0200.) Credit card holders can simply
telephone 0933 79300 during office hours.

Alternatively, you can order by post from:
Acornsoft, c/o Vector Marketing, Denington
Estate, Wellingborough, Northants NN8 2RL.

You can also get a free Elite poster by ringing
0933 79300.

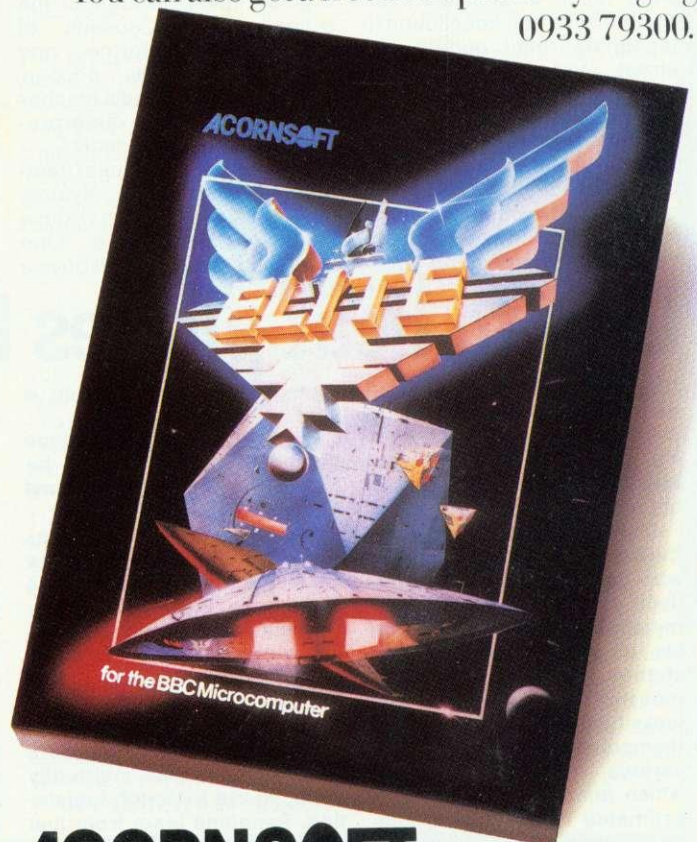

ACORNSOFT

Geoff Nairn reports on piracy and Bill Penfold looks at the pressure on MPs

Fighting talk on software piracy

TWO software companies have crashed this year and more could follow unless piracy can be stamped out. And it's not just down to a few big-time counterfeiters; if you have ever swapped games with friends then you too are a pirate in the eyes of the industry.

Nick Alexander, who chairs the Guild of Software Houses, claimed: 'For every legitimate tape sold, 10 or 12 copies are made'. Chris Holland of Salamander put the number nearer six but added that 'between £100m and £150m is lost in this country alone each year.'

Imagine collapsed in July and '50 to 60 per cent of the problem was due to copying', said Nick Alexander. He cited how Salford CID seized 10,000 counterfeit copies of Imagine games in one raid. GOSH has set up a £50,000 fund to enable its 34 members to take court action.

Pirates fall into two categories: commercial counterfeiters who make copies by the thousand and pass them off as the real thing; and home users who make just a few copies to sell or swap.

Quicksilva has started a civil action against one group of pirates after 30,000 copies were found in a single raid. Counterfeits had been found in legitimate retail outlets and street markets which were indistinguishable from the originals.

Amateur pirates can be just as destructive. One Blackburn doctor was selling £300-worth of copied Microdeal software for just £30. The company seized all his tapes and docu-

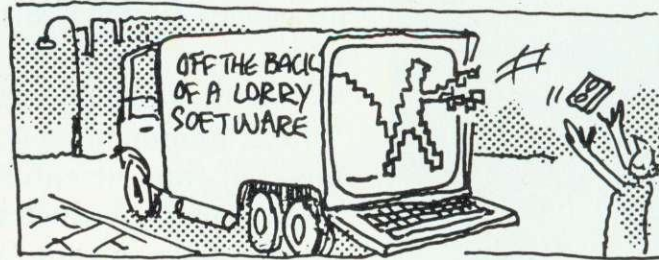

ments through the courts, and is now seeking damages 'of several thousand pounds so as to discourage others', according to John Symes of Microdeal. He added that similar actions were pending against a user group and a school.

Acorn's Chris Curry has claimed school computer classes harbour 'a den of thieves'. He told a Parliamentary committee: 'You provide the software to one person and it gets copied throughout the school'. Rod Cousens of Quicksilva goes further, and thinks teachers often encourage piracy: 'If we find a teacher doing this, we are quite prepared to take him to court.'

Retailers have similar feelings. Matthew Hyams, manager of the Lion House store in London said: 'One schoolkid comes in and buys a

program while five friends watch. They then all go out together, presumably to make five illegal copies. Some even have the cheek to bring the original back saying it's faulty!'

The user groups have been on the receiving end of criticism. Peter Hughes who runs the Format 40/80 group takes a clear stand: 'Our group is dead against copying. I have had to turn down many applications from people—usually kids—who were obviously only interested in copying software.' However, he admitted his group was probably in a minority as many exist solely to copy and swap games.

The Format 40/80 group caters for disc users and will copy any genuine program tape to disc for members. When it was suggested this be classified as piracy, Peter

Hughes replied: 'If you've bought a disc drive, why shouldn't you be allowed to get the benefits? Why should you have to buy a disc version of a program you already own?'

PSS, a Coventry software house, has adopted a policy of not advertising in any magazine which carries adverts for tape or disc copiers. Richard Cockayne, one of the directors, said he was 'fairly appalled' at the attitude of companies who sold copier programs.

He went on: 'In the longer term they are cutting their own throat. There's no need for such devices. We will replace any tape which doesn't load.'

He quoted the case of one 13-year old selling pirate copies of PSS games through the classified columns: 'He was using a commercial tape copier program and had master tapes for 34 titles.'

When it comes to solutions, Nick Alexander differentiated between commercial pirates and the home user. 'For the professional criminals we're trying to get legislation for tougher penalties.'

He drew an analogy with video tape pirates: 'A change in legislation and some well-publicised raids drove them away—to computer software instead.'

For the small-time pirates, technical measures do stop casual copying, but the determined can usually crack protection devices. Nick Alexander hopes to 'appeal to their better nature as he feels legal remedies are inappropriate.'

Let's hope his faith is justified.

Law to beat pirates hinges on lottery

ONE raffle in November could be worth £150 million to Britain's computer industry. It's the yearly 'Private Members' Ballot in the House of Commons.

The 20 names plucked out of the hat will be backbench MPs who get the chance to introduce their own private members' bill, but only the first six or eight have any real chance of seeing their measure become law. The lucky half-dozen or so will find themselves besieged to adopt various measures, one of which aims to outlaw pirates estimated to be costing soft-

ware houses £150 million a year.

Hoping to find a friendly face amongst the MPs will be FAST—the Federation Against Software Theft.

FAST, set up last July, has already got its draft bill on the stocks. In fact the measure has even been introduced in the Commons by Tory MP Nicholas Lyell, although it never had any chance of getting any further.

The situation is similar to video piracy two or three years ago. That was virtually stamped out by tough legislation. Penalties leapt from just

£50 on conviction to £2,000 for each offence, plus the possibility of jail.

The software industry hopes to repeat that success with a simple amendment to the video bill which amended the 1956 Copyright Act. The software measure proposes in turn amending the 1983 Act by simply adding after references to video films, the words 'or computer programme'.

Before any Beeb owner begins panicking at what is in their own software libraries, a word of reassurance. Though no one is condoning amateur pirates who borrow and copy

software that's not the target.

Ronald Robertson, chairman of the Computing Services Association's legal affairs group, insists FAST is not after the schoolboy pirate, unless he's selling his copies.

'It's the commercial pirates, the blokes who are selling stolen computer software for profit, that we're chasing,' he explained.

FAST's chairman, Donald MacLean, explained that come the day of the draw the Federation will be standing in the queue ready to pounce on the six or eight MPs heading the list.

TECHNOMATIC

BBC Computer & Econet Referral Centre
01-208 1177

OCTOBER 84'

ACORN COMPUTER SYSTEMS

BBC Model B Special Offer.....	£320 (a)
BBC Model B + Starter Pack.....	£348 (a)
BBC Model B + DFS.....	£409 (a)
BBC Model B + Econet.....	£389 (a)
BBC Model B + Econet + DFS.....	£450 (a)
BBC Dust Cover.....	£4 (d)
Pair of Joysticks.....	£14.50 (d)

UPGRADE KITS

A to B.....	£65 (d)	Installation.....	£20
ACORN DFS Kit.....	£95 (d)	Installation.....	£15
Econet Kit.....	£42 (d)	Installation.....	£25
Speech Kit.....	£47 (d)	Installation.....	£15

ECONET ACCESSORIES

Terminator (Two reqd per installation).....	£31 (c)	File Server Level II.....	£216 (c)
Clock with psu.....	£35 (c)	10 Station Lead Set.....	£26 (c)
Printer Server Rom.....	£42 (c)	Extra Econet cable.....	£1.50/m (d)
File Server Level I.....	£86 (c)	Econet User Guide.....	£10 (d)

ACORN BITSTICK

The Acorn adaptation of the renowned 'Bitstick' graphic CAD package — the "expensive joystick" that lets you exploit the powerful capability of the BBC micro to the full. The joystick is of a robust design which achieves remarkable precision without fiddliness. Total control is available from the joystick using the on-screen menu. It can draw freehand or follow lines of shapes chosen with high accuracy, and colours can be chosen from a palette displayed on the screen. Any part of a drawing can be magnified, by a virtually unlimited number of times, and upto 48 drawings can be saved on a single disc. The discs use a visual library system for easy identification. In spite of its powerful features, the Bitstick is extremely friendly and easy to use, due to menus being displayed on the edge of the screens.
£328.00 (a) FX80 dump routine for the bitstick available.

TORCH UNICORN PRODUCTS

The TORCH Unicorn system has been in the field for over two years and is now a proven Z80 system for the BBC. It gives you the potential to expand which no other system can currently offer. You can expand a single system with a 20Mb Hard Disc, have the processing power of a 32bit 68000 cpu with 256K ram and a UNIX operating system, or set up a network of upto 254 machines. All these capabilities are available NOW.

The TORCH UNICOMM Modem package is now available for the UNICORN range providing the benefits of the extensive TORCH communication packages. It offers three options: **Uniview** for viewdata services, **Uniterm** for terminal emulation, and **Unimail** which allows messages and files to be exchanged between Unimail/Torchmail/Torchmail-Plus users. Access to files can be controlled by heirarchical passwords which determine the extent of access.

Z80 Card ZEP100 with PERFECT Software Packages + Z80 Basic.....	£275 (a)
Z80 Disc Pack ZDP240 with software as above.....	£675 (a)
20Mb Hard Disc + 1 x 400K Floppy Drive.....	£1,950 (a)
UNICOMM Communications Package + modem.....	£161 (a)
Unicorn 68000, Unix OS/Z80B/256K, 20MB Hard Disc, 400K Floppy.....	£2995 (a)

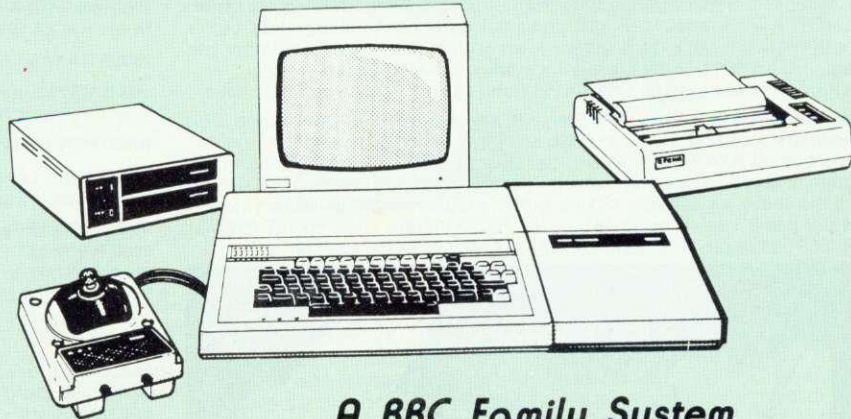

A BBC Family System

ACORN Z80 2nd Processor

This processor converts your BBC into a complete business micro with all the computing power a professional would need. The system is CP/M based and is supplied with a very extensive software package. The package includes three office productivity programs, (memoplan, fileplan and graphplan), Systems generator program, three programming languages plus the ACCOUNTANT business program. Software is accompanied by extensive manuals that not only get you started but also answers your whys and hows.

All for only **£299 (a)**

ACORN 6502 2nd Processor

This processor is designed for the serious computer user who wants to get even more out of his computer. This processor provides increased memory — allowing up to 44K for Basic programs and up to 60K for assembly language programs, regardless of screen mode in use. (ideal for VIEW). An increase in speed means that programs run up to 50% faster. The second processor/BBC combination offer computing power comparable to systems costing twice as much.

£175 (a)

TORCH GRADUATE SYSTEMS

This latest addition to the range of BBC upgrades will upgrade your BBC to a powerful 16bit business computer and make it disc & hardware compatible with the IBM PC. Its MS/DOS is customised to IBM compatibility allowing access to the massive range of IBM compatible software, programming aids, compilers and languages. It uses A8088 CPU at 5MHz, 128K or 256K ram, single or dual drive, software compatibility allows LOTUS 1-2-3, Flight Simulator and other popular IBM PC business programs to run. Connection of the Graduate is simple, with just a connection to the 1Mhz Bus. The disc drives can be used in both BBC and IBM PC mode without needing an Acorn Disc Interface in the computer. The top-of-the-market GRADUATE Model G800/2 will come complete with the superb Xchange suite of programs, comprising a full feature word processor, a financial planner, a database, and a business graphics package. Although these programs are in modular form, they can be linked together to form an integrated software system that allows you to switch instantly between various tasks and to exchange information between programs. G800/2 **£945 (a)** Full spec & prices on application.

PRINTERS

ALL PRINTERS HAVE A 12 MONTH GUARANTEE

DOT MATRIX

This month we are adding the new **KAGA** printers to our range of quality dot matrix printers. These printers, with their **EPSON** compatible control codes are available in 80 col & extra wide 156 col versions. Features include **NEAR LETTER QUALITY** print using a 23 x 18 matrix, Dot addressable graphics in 8, 9 & 16 pin modes. Text modes include Normal, Italic, Enlarged, Condensed, Super & Sub script, Proportional spacing. Defined characters can be placed in ROM to give personalised print. An intergral 3K buffer, both friction & adjustable tractor feeds with built in paper roll holder, etc. etc. makes these superb 'value for money' printers unique.

KP810 (80 cols) **£249 (a)** KP910 (156 Cols) **£375 (a)** (With free BBC cable). We continue to supply the ever popular, definitive **EPSON** range. This 'industry standard' range provide reliability and quality 'second to none'. The budget RX80FT Dot Matrix, has 100cps and all standard printing and graphic functions as well as friction and tractor feed. The deluxe FX80 has all the above, as well as a 160cps, buffer, programmable characters etc. For wider paper use — up to 16" — the RX/FX100 are ideal. RX80T **£225 (a)**; RX80FT **£240 (a)**; FX80 **£318 (a)**; RX100 **£345 (a)**; FX100 **£450 (a)**.

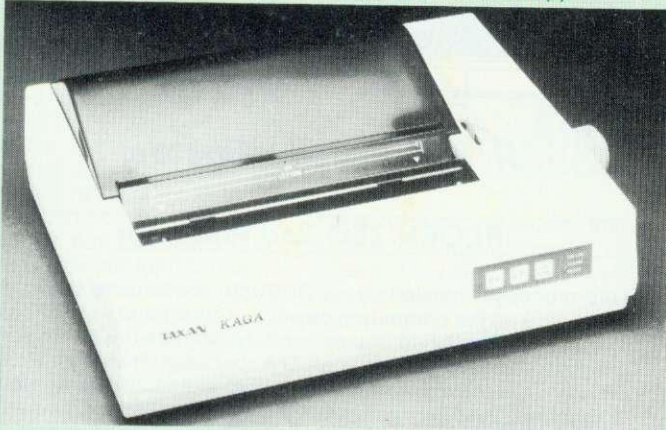

DAISY WHEEL

The Brother HR15 daisy wheel offers features normally found in printers costing far more. Features include: 14 cps, 3K buffer, proportional spacing, underlining, bold and shadow printing, two colour printing, super & subscript and many other features. Centronics parallel interface is fitted as standard.

BROTHER HR15 **£349 (a)** (With free BBC Cable).

The JUKI 6100 daisywheel with 20cps, 2K buffer, and switchable 10, 12, 15cps + proportional printing. A linear motor ensures optimum reliability. JUKI 6100 **£345 (a)**

GRAPHICS PLOTTER/WORK STATION

Equally at home in the artists studio, hobbyists workshop, science lab or a classroom, this system has something to offer for everyone. The 3 colour graphics plotter provides both precision and versatility. The carriage can be moved with an accuracy of 0.025cm over an A4 area — the plotter being able to accept paper and far thicker materials at sizes of up to A3. The basic plotter carries 3 colour pens each of which is software selectable. Additional accessories greatly enhance the versatility of the unit without loosing the accuracy. The servo controlled drill/router, and scriber can be used on various materials. A unique Opto Sensor (using a Hewlett Packard device) turns the plotter into a high-res scanning digitiser to read & store whole diagrams and photographs.

Workstation Complete **£490(a)**; Basic Plotter **£270(a)**; Software on disc **£3.00**; Power Supply: PS12V **£42**; PS24V **£78**; Drill/Router Attachment **£79**; Scriber **£7**; Opto Sensor **£72**

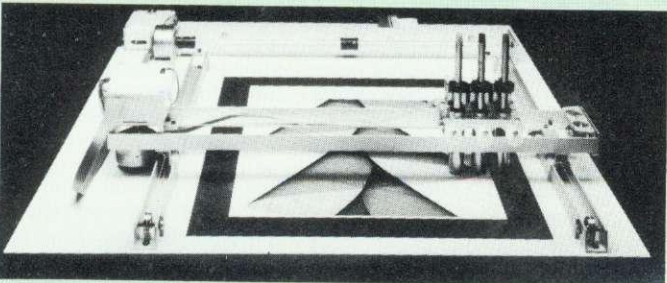

TECHNOMATIC

All prices exclude VAT

PRINTER ACCESSORIES

EPSON

Paper Roll Holder **£17 (d)** FX80 Tractor Attachment **£37 (c)**.
Interfaces: 8143 RS232 **£35(c)**; 8148 RS232 + 2K **£55(c)**; 8132 Apple II **£60(c)**;
8165 IEEE + Cable **£65(c)**.

Serial & Parallel Interfaces with larger buffers available.
Ribbons: RX/FX/MX80 **£5.00(d)**; RX/FX/MX 100 **£10(d)**; FX80
Dustcover **£4.50 (d)**

KAGA TAXAN: RS 232 Interface + 2K buffer £85(c); Ribbon KP810/910 **£6(d)**

JUKI: RS232 Interface £65(c); Spare Daisy Wheel **£14(d)**; Ribbon **£2.50(d)**
Sheet Feeder **£199(a)**; Tractor Feed Attachment **£99(a)**

BROTHER HR15: Sheet Feeder £199(a); Ribbons Carbon or Nylon **£3(d)**

BBC Printer Lead: Parallel (42") £7(a); Serial **£7(a)**
Printer Leads can be supplied to any other length.

Plain Fanfold Paper with extra fine perforation (Clean Edge):

2000 9.5" x 11" **£13(b)**; 200 15" x 11" **£18.50(b)**

Labels: 2-3/4" x 1-7/16" in quantities of 1000

Single Row: **£5.25/1000 (d)**; Triple Row: **£5.00/1000 (d)**

PRINTER SHARER BUFFER

A unique delux printer buffer/sharer providing a simple way to upgrade your computer system by allowing greater utilisation of existing equipment by reducing the waiting time for printing documents. Data from three computers can be loaded into the buffer which will continue accepting data until its 64K storage is full. The buffer will automatically switch from one computer to the next as soon as that computer has dumped all its data. The

computer is then available for other uses. A LED bargraph indicates the memory usage, with LED indication showing from which computer the data is being fed from. There is simple push button control for PAUSE, RESET, and COPY facilities. The copy facility is ideal for continually printing copies of a document without 'tying up' the computer. Built in mains psu.

SP110 BUFFER/SHARER
incl one cable set **£275(b)**

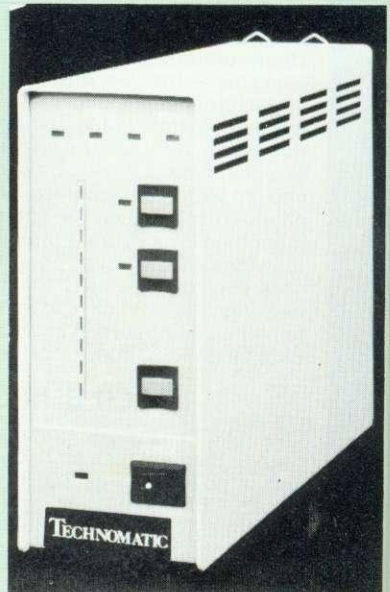

PRINTER SHARER

Three Computers to one printer (parallel).....**£65(b)**

Six Computers to One Printer (parallel).....**£129(b)**

Cables for Three Way Sharer.....**£25(c)**

Cables for Six Way Sharer.....**£38(c)**

COMPUTER SHARER

Two Printers to one Computer.....**£19(c)**

GRAFPAD

A low cost graphic tablet offering the performance & durability required by industrial and educational users. It is compact, accurate & reliable; working area 240 x 192mm + menu area. Comes complete with a CAD packag. **£120 (b)**. 'Microdraw' CAD Package **£21.70 (d)**.

VIEW PRINTER DRIVER FOR FX80/KP810

This driver allows the use of all FX80s fonts to be used in text written using the VIEW rom. If user defined characters are held in the printer buffer they can also be used within the text. Manual includes examples. Supplied on 40 or 80 Track disc.....**£7 (d)**.

01-208 1177

Please add carriage: (a) £8; (b) £2.50; (c) £1.50; (d) £1.

MONITORS

A choice of high quality RGB and Monochrome monitors are available. The British made **MICROVITEC** Std/Med/Hi Resolution 14" monitors offer a consistent reliable performance. Their resolution ranges from 452 pixels horizontal on the std res monitor to 895 pixels on the Hi res monitor. Std res monitors are also available with RGB/PAL/Audio inputs. Dual input versions also available.

1431 Std. Res. RGB **£175 (a)**; 1431AP RGB/PAL/AUDIO **£225 (a)**; 1451 Med. Res. RGB **£295 (a)**; 1441 Hi-res RGB **£420 (a)**.

2031 20" Std. Res. RGB **£260 (a)**.

Plinth for Microvitec 14" Monitors **£8.50 (c)**.

The **KAGA** Vision 3 12" RGB monitor offers a superb performance but in a smaller cabinet with a genuine etched anti-glare screen. **£358 (d)**. The Japanese made **SANYO** and the **KAGA** monochrome monitors provide an ideal answer for an 80 character hi-clarity display. A futuristic swivel base plinth with integral clock is available for the Kaga green monitor as an optional extra.

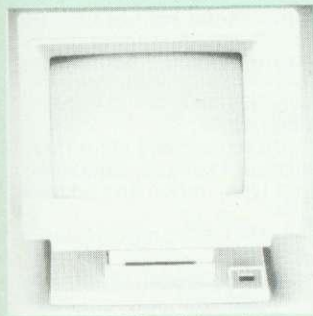

KX1201G with stand

SANYO DM 8112CX Hi Res Green Screen.....**£99 (a)**

KAGA KX1201G 20MHz Hi Res Green with etched screen....**£106 (a)**

Swivel Base for Kaga Green (fitted with digital clock).....**£22.50 (c)**

Note: All monitors are supplied with free BBC leads.

BBC Leads: Kaga RGB **£5**; Microvitec **£3.50**; Monochrome **£3.50 (d)**

VIDEO DIGITISER

A high quality yet cost-effective unit offering uses for the scientific, educational and home user. Feeding in a video signal (this can be from a camera, VCR etc) will output to the BBC a high quality picture, with eight different grey levels. This picture can be stored on disc, manipulated or dumped to a printer. The friendly, yet sophisticated menu driven software comes complete with an Epson printer dump. **£250 (a)**.

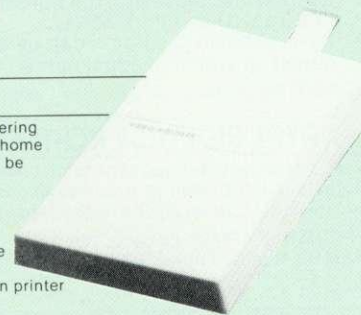

SANYO DRIOI DATA RECORDER

A high quality tape recorder with circuitry specifically designed for data recording. Having normal as well as data recording, as well as cue/review and a tape counter, it makes this recorder an ideal choice for anyone wanting a reliable tape storage device. **£30 (c)**. Cassette **£3.00 (d)**.

ACORN ANFO3 TAPE RECORDER

The official Acorn tape recorder recommended for the BBC. Has a counter, automatic record level, mains/battery and comes complete with a BBC cassette cable.....**£28.50 (c)**.

RH LIGHTPEN

A superior quality lightpen, features including: adjustable sensitivity, LED output to show data transmission, microswitch tip. Full software backup. **£39 (c)**. The 'Lightpen Colour Graphic Software' pack helps you to draw line drawings as well as more complex drawings. Colour fill, point plotting, line, square, triangle, circle XY rulers are all available with rubber banding facility. **£7** cassette, **£9** Disc. The 'Artfun' pack provides full interaction between pen and screen. Allows your initial design to be shrunk into a high res format, and these images can be stored for subsequent use. **£7** cassette. The 'Word Master' encourages the use of correct grammar and is an excellent aid. **£7** on cassette. The 'Ed Master' uses a quiz format, and up to 160 questions may be programmed by the teacher. **£7** on cassette (d).

DISC DRIVES



Technomatic Disc Drives offer the best value for money. They come fitted with high quality slimline Japanese mechanisms & represent the state of art in disc drive technology. They are built to highest standards in design and production, and are all tested to their full performance capability before packaging. All drives are available with or without integral power supply. Dual Drives with PSU are supplied with generously rated integral switched mode power supplies. All 80 track TEAC drives are fitted with 40/80 Track switching at no extra charge to the user. Attractively designed steel casings are painted in hard wearing BBC matching beige paint. All drives can operate in single or double density modes. Drives are supplied complete with necessary cables, manual and formatting disc and are ready to be connected to the computer.

Single Drives

100K 40T SS TEAC **£100(a)**;

200K 80T SS 40/80T TEAC **£155(a)**

400K 80T DS 40/80T TEAC **£185(a)**

3" 100K HITACHI Drive **£115(a)**

TEC with psu **£135(a)**

TEC with psu **£165(a)**

Mitsubishi with psu **£195(a)**

Dual Drives

2 x 100K 40T SS with psu: TEAC **£300(a)** TEC without psu **£225(a)**

2 x 200K 80T SS with psu 40/80T TEAC **£375(a)** TEC without psu **£275(a)**

2 x 400K 80T DS with psu 40/80T

TEAC **£400(a)** Mitsubishi without psu **£325(a)**

2 x 400K 80T DS with psu Mitsubishi **£400(a)**.

Our 40/80 Track Switching Module will take care of your frustration of not being able to read or write 40 Track software on 80 Track drives. No additional cables or accessories needed. Full fitting instructions supplied. All for only **£30 (c)**.

The FLOPPICLENE disc head cleaning kit is the ideal way to ensure the optimum performance of your drives. The use of disposable cleaning discs eliminate the risk of recontamination and abrasion of the sensitive disc heads and ensure continuously reliable data capture and transmission.

Floppiclene with 20 disposable cleaning discs. **£14.50 (b)**

OFFER

SCOTCH 3M DISCS

OFFER

This month we are offering these high performance discs at a bumper bargain price — not to be repeated again. The current offer will be valid for orders received until 15th October only. These discs are manufactured with advanced manufacturing techniques that have enabled 3M to set the industry standard. Their quality is such that their error free performance is guaranteed for life.

Discs in pack of 10 (c): 40T SSDD **£12.50(c)**; 40T DSDD **£17(c)**; 80T SSDD **£21(c)**; 80T DSDD **£22(c)**

DISC ACCESSORIES

Single Disc Cable **£6 (d)** Dual Disc Cable **£8.50 (d)**
 10 Disc Library Case **£1.90 (d)** 30 Disc Case **£8.00 (c)**
 Lockable Storage Boxes: 30/40 Discs **£14 (c)** 70/80 Discs **£18 (c)**

KENDA DMFS

This is an alternative to the Acorn DFS with several significant advantages. *Single/Double Density *Up to 379 Files per disc. *No user ram required i.e. PAGE=&EOO *CP/M compatible file structure *Can read DFS files *Can read most Acorn and other protected software. Simple plug-in installation — comes complete with utilities disc and manual.....**£120 (c)**

MODEMS

We stock a modem for every requirement, whether it is for the business, or private user, whether you require access to a public database or a mainframe, whether for local or international use. We also carry suitable software — see our section on ROMS.

TORCH UNICOMM

See our section on Torch for further details.

ACORN PRESTEL

The dedicated Prestel adaptor complete with integral, BT approved, auto-dial modem and software in ROM **£99(a)**.

BUZZ BOX

A full spec, BT approved, pocket size, direct connect modem with both originate & answer modes, full & half duplex, allowing access to many databases, bulletin-boards as well as intercomputer communications. It conforms to CCITT V21 300/300 Baud standard. Battery/mains powered. **£65(c)** BBC Lead **£3.50** External PSU **£8**.

WS2000

A world standard direct connect modem switchable between 75,300/300,600,1200/75,75/1200 baud, awaiting BT approval. It is compatible with Bell 103/113/108, 202 and CCITT V21 & 23 standards and allows you to communicate with virtually any computer system in the world. This is one of the new generation modems, that will probably cover any communications standards you would ever need. This is the modem that will cover Prestel, Micronet, Telecom Gold, Distel, Microweb, One-to-One, Bulletin Boards both in the UK and abroad, etc. etc. as well as user-to-user communication. It also has a rather useful facility of 'Reverse-Prestel' mode i.e. 75/1200 so that you can communicate with other users who only have a standard 1200/75 type modem. What possibly gives this modem its biggest advantage is its option of computer controlled switching between all modes of operation. In addition, separate auto-answer and auto-dial cards are available, giving this modem possibly the greatest potential of all. Mains powered. **£129(c)**. Please phone/write for details of optional extras.



TELEMOD-2

A BT approved modem complying with CCITT V23 1200/75 Duplex & 1200/1200 Half-Duplex standard, that allows communication with Viewdata services e.g. Prestel, Micronet etc., as well as using 1200 Baud for communicating with other computer users. Mains powered. **TELEMOD 2 £65(b)** BBC Lead **£3.50**

ACORN IEEE INTERFACE

This interface enables a BBC computer to control any scientific and technical equipment that conforms to the IEEE488 standard, at a lower price than other systems, but without sacrificing any aspect of the standard. The interface can link up to 14 separate IEEE compatible devices. Typical applications are in experimental work in academic and industrial laboratories, with the advantage of speed, accuracy and repeatability. The interface is mains powered and comes with cables, IEEEFS ROM, and user guide. **£282(a)**

ACORN TELETEXT INTERFACE

This interface enables a BBC Computer to receive and store teletext information transmitted by both BBC and ITV. In addition it allows the downloading of transmitted software. The unit comes with a ROM and user guide. **£195(b)**

TECHNOMATIC

All prices exclude VAT

EPROMER II

Our current version of the highly popular Eprom programmer is now being enhanced to provide more and better facilities for easy programming by the user. The software will maintain its superiority over all currently available similar programmers. The range of eproms handled has been widened to include the eproms with lower programming voltage and eproms which can be programmed using the fast algorithm. Control of all operations has been moved to the keyboard. The screen display has been improved to give more information. The screen editing facilities have also been modified to simplify the data entry.

Preliminary Information

- * The new Eprom Programmer will now program 2516, 2532, 2564, 2716, 2732, 2764, 27128 and 27256 + 5v eproms, and all but the 27256 in a single pass.
- * The programmer will be supplied with integral power supply, and interfaces with the BBC via the 1MHz bus. It is fully buffered and complies with Acorn protocols. There is no power drain from the computer.
- * No knobs or switches to fiddle with — total control from the keyboard.
- * Fully software driven with easy to understand instructions displayed on the screen.
- * Eprom type selectable from the keyboard.
- * Selectable programming voltage 25/21/12.5V.
- * Defaults to normal programming with high speed algorithmic programming selectable, for a device with suitable capability.
- * Continuous screen display of eprom type, option and address range selected.
- * Full screen editor with HEX or ASCII input. Constant display of logical eprom address.
- * Can read, blank check, program and verify at any address/addresses on the eprom.
- * Full Tape/Disc filing facility.
- * Several basic programs can be entered on a single eprom and called up with individual name.

ATPL SIDEWISE ROM EXPANSION BOARD

This is a well constructed expansion board that does not require soldering in its installation. It will give you an additional twelve sockets, with a 16K battery-backed RAM option. All the busses are fully buffered. **£39(d)**.

EPROMS 8K 2764-25 **£6.50(d)**; 16K 27128-30 **£21.00(d)**.

RAM 8K standard power 6264-15 **£35**; 8K low power 6264LP-15 **£41.00**.

SMARTMOUTH

The Original 'Infinite Speech' Synthesiser — Still the Best!

A ready-built totally self-contained speech synthesiser unit, attractively packaged with built in speaker, Aux. output socket etc. Optimum sound quality is achieved due to a tailored frequency response audio stage. It allows the creation of any English word with both ease and simplicity, while, at the same time, being very economical in memory usage. You can easily add speech to most existing programs. Due to its remarkable infinite vocabulary, its uses spread throughout the whole spectrum of computer applications — these include educational, industrial, scientific, recreational etc. — simply plugs into the User Port. No ROMs are needed. Smartmouth is supplied with demo and development programs on cassette and full instructions. **£37(c)**.

UV ERASERS

UVIT with built-in timer and safety switch **£59(b)**.

'TIME-WARP' REAL-TIME CLOCK CALENDER

A low-cost compact unit that opens up the total range of Real-Time applications, and adds a new dimension to the personal computer. Though built to exacting professional standards, it is at a price previously unattainable, and brings it within reach of all BBC Computer owners. With its full integral battery backup, possibilities include an Electronic Diary, continuous display of 'on-screen' time and date information, automatic document dating, precise timing and control in scientific applications, recreational use in games etc. — its uses are endless and are simply limited by ones imagination. Simply plugs into the User Port — no ROMs needed. Extensive applications software supplied on cassette (easily transferred to disc) and full instruction manual. Please phone for details. **£29(c)**.



01-208 1177

Please add carriage: (a) £8; (b) £2.50; (c) £1.50; (d) £1.

COMMUNICATION ROMS

TERMI This is a semi intelligent terminal emulator allowing the BBC to act as a dumb terminal, slave BBC graphics terminal, or VT52 terminal. The rates at which data is sent or received is easily set up with rates of up to 4800 Baud with 40/80 col. selectable. Allows files to be transmitted from disc, or a copy of incoming data to be sent to a file or to a printer. (Termi is not suitable for PRESTEL). **£28(d)**.

COMMUNICATOR This is a full 80 col VT100 terminal emulation program on 16K eprom. It is a more advance program than TERMI and features easy to follow screen menus. The rate at which data is sent or received is easily set up with rates up to 19200 Baud with 80 column text. Allows files to be transmitted from disc, or a copy of incoming data to be sent to a file or to a printer. (Communicator is not suitable for PRESTEL). **£59(d)**.

COMMSTAR This intelligent communication facility is extremely easy to use yet very versatile. It features a terminal mode, a full VT100 emulation mode and a special PRESTEL mode. In Terminal mode, all input may be copied into a buffer in memory over which full control is provided. Controls of protocols is very simple and any type of file (not just ASCII) may be sent using XModem protocols. The Emulation mode may be used using a disc based emulation file to emulate virtually any terminal type including VT100, within the capabilities of the BBC. In PRESTEL mode all normal Prestel features are available, including downloading of software, saving and retrieving of pages etc. etc. **£29(d)**

GEMINI DATAGEM

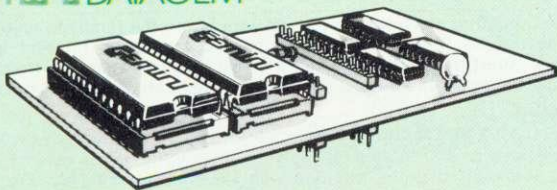

The Definitive Random Access, 24K ROM Based DATABASE MANAGEMENT SYSTEM.

Datagem is the first truly flexible database for the BBC Micro that can make your system really useful and efficient, saving you money in the long run. The system includes a carrier board containing two Eproms, demonstration applications disc in both 40/80T, professional documentation with quick reference card, and 'Trans' utility program. Features include: *almost unlimited file size (max 10MByte) *supports up to 4 drives *Max of 5000 records per file *max 6K record size *max of 62 fields *9 level hierarchical search system with facilities to store results of searches. Searches can be any one of the following: Search, Include, Exclude, Combine, Common or Difference *user defined variables *generates form letters from records. Please ask for leaflet. **£112(c)**.

ACORNSOFT/MIRLE Business software

Using this well designed, cost effective business system, the small businessman is able to reduce repetitive tasks significantly, and increase efficiency at the same time. Instead of making individual entries in stock records, VAT records, purchase records, sales records, and so on, the entry is made just once. As well as taking care of the production of all the paperwork, the system also allows for instant access to information and speedy analysis of recorded data. The beauty of the system is that packages can be purchased and used individually with the option of, possibly later, linking them with the other packages.

Invoicing: Stores details such as names & addresses of customers, products, VAT numbers, etc. **Order Processing:** You can confirm your customers orders, check on their requirements, prepare despatch notes, and get speedy order analysis of single orders, selected orders, or all the orders stored on the data disc. **Accounts Receivable:** Provides accurate maintenance of customer accounts, and instant access to customer account status. **Accounts Payable:** Provides accurate maintenance of supplier accounts, and instant access to supplier account status. **Stock Control:** allows you to keep an eye on product records, record stock receipts and issues, report on restocking requirements and to analyse stock for valuation and physical reconciliation as well as instant access to stock status and automatic analysis of stock by quantity and value. **Purchasing:** All names and addresses of suppliers can be retrieved instantly for the production and printing of orders. **Mailing System:** When sending a mailshot, you can specify criteria such as size of company, location, type of industry, value of business etc. Will print names and addresses on either gummed labels or printed paper. **£22(d)**.

BBC FIRMWARE

VIEW Word Processor Rom on special offer at £48(c).

This is the new version V2.1. Advantages include being able to print straight from memory, as well as editing in any mode. Complete with comprehensive manuals to Acorns usual high standard.

WORDWISE One of the most popular word processors for general use **£34(d)**. Wordwise SpellCheck Disc — A must for any serious word processor user. Normal price **£16.50(d)**. If bought with Wordwise: No p&p and only **£14**.

ULTRACALC From BBC Publications: The only spreadsheet ROM for the BBC that offers features found in the most sophisticated spreadsheet programs, like the handling of labels as well as numbers as values, and allowing a search by a meaningful full name instead of just a number etc. Efficient memory usage allows large spread sheets to be constructed. Facilities and commands include, variable width column, Sum, Replicate, Insert, Delete, & most mathematical functions. It helps to create and manipulate pricelists, balance sheets, payroll, c/flow forecasts, order entry, small databases, scientific calculations. **£69(c)**.

BCPL A full implementation of the BCPL compiler language from Acornsoft. It consists of the BCPL language ROM and a disc containing the BCPL Compiler, a Screen Editor, a 6502 Assembler, other utilities and program development aids, and some examples of BCPL code. A comprehensive 450 page user guide is included. It can be used to develop games programs and commercial packages, to develop system software, to write control systems, and to produce programs which otherwise would need to be written in assembler. **£86(b)**.

BCPL CALCULATIONS PACKAGE: supplied on disc, it supports floating point, fixed point and fast integer calculations. It includes the BCPL calculation files, example files and a comprehensive user guide. **£17.30(b)**.

UTILITY ROMS

DISC DOCTOR This general purpose ROM adds 20 commands to the DFS system. It includes a formatter, sector editor, tape-disc & disc-tape routines, a powerful disassembler, commands for listing function key definitions for editing etc. This ROM will obviate the need to go for non standard DFS systems (with their inherent disadvantages) as it overcomes many of the Acorn DFS's shortcomings. **£28(d)**.

GREMLIN Contains a full machine code monitor including features such as a disassembler, memory move and search routines. Also feature a full expression evaluator and an assembler. Can single step through ROM & RAM as well as any sideways ROM. Works in any mode with full status display. Up to 8 breakpoints can be used and it has a special mode for debugging graphic programs. **£28(d)**.

EXMON This extended machine code editor provides 35 new commands. Features include machine code relocater, single stepping, memory search and full assembler & disassembler. **£20(d)**.

TOOLKIT This ROM adds 27 new commands to the BBC BASIC. These include a full screen editor, merge, relocating data in memory, program compactor, listing of variables and memory search. **£23(d)**.

CARETAKER This adds 17 new commands to the BASIC which include: renumber, squash, exchange insert, single key entry of BASIC keywords etc. **£28(d)**.

GRAPHICS ROM This ROM includes over 28 new graphics related commands which can be used in BASIC programs. Features include: sprites, LOGO Turtle graphics, fill routines, shading, large characters, rotation, scaling and 3D plotting all using '*' commands. **£28(d)**.

PRINTMASTER This ROM features the most versatile screen dump for EPSON MX/RX/FX80 and Kaga 810 printers. It supports three types of dumps. The first allows any graphics on the screen to be dumped. Colours appear as shades of grey. Any part of the screen can be printed at any position on the paper in any one of four orientations. The screen dump may be magnified by any factor $\times 2$, $\times 3$, $\times 4$ etc. A special feature allows true MODE 7 screen dumps with TELETXT text & graphics. The second dump allows any text to be dumped whilst the third dump will print the contents of a file on disc whilst the computer is doing other things. This is not all. All printer functions can be called up using the * command. *DEFINE allows the user to define his own characters and store them. *GPRINT allows printing of enlarged text in any position, orientation, size & shade. *WINDOW allows windows to be defined in any size and position on the screen. In short this one ROM does it all. **£28(d)**.

SOFTWARE

TURTLE GRAPHICS

Ideal as an introductory package for teaching geometry, mathematics and graphics at an elementary level. **£17.30 on disk.**

MICROTEXT

This authoring system was developed by the National Physical Laboratories. It is a programming system designed to simplify the production of a wide range of man-computer dialogues. Using Microtext's simple commands, the user can draw up any number of 'frames', each containing text and/or graphics. A series of frames build up into a complete module. Each program can consist of more than one module. Using Microtext, an expert in any field can construct their own complete courses of computer-based instructional material. Applications include interviewing systems, teaching packages, training courses and interactive demonstrations and simulations. Available on Cassette and Disc. **£52(a) Disc; £43(c) Cassette.**

S-PASCAL

Contains a subset of Pascal — one of the most popular programming languages available today. The package contains the S-Pascal compiler on disc, several example programs and a comprehensive user guide. **£17.30(d)**

ACORN LISP

Lisp provides more flexibility in data and control structures than traditional languages. Is easy to learn, and is widely used for writing substantial and sophisticated programs, with practical applications. **£17.30(d) Disc; £14.35(d) Cassette.**

ACORN FORTH

Forth is a compiled language, so programs run very fast (typically five times faster than Basic). **£17.30(d) Disc; £14.35(d) Cassette**

DESIGN

Design is a screen processor which allows information to be displayed in a format suitable for demonstrations, slide projections, handouts or presentations. **£16.50(d) Disc; £8.50(d) Cassette.**

SUPERPLOT

Superplot is ideal for anyone interested in screen representations of mathematical functions. **£16.50(d) Disc; £8.50(d) Cassette.**

SPELLCHECK

The spelling checker available for both Wordwise and View. **£16.50(d) Disc; £8.50(d) Cassette each.**

MASTERFILE

A general purpose data base that is extremely useful, allowing vast amounts of information to be stored. The disc version allows up to 17 fields per record, and the only limitation as to the number of records, is the capacity of the disc. Typically, using 5 fields, about 2000 records may be stored on a 100K disc. **£16.50(d) Disc.**

PAINTBOX

A joystick drawing program for the BBC. You can use it to doodle or to design sophisticated full colour pictures. **£8.50(d) Cassette.**

VU-Type This is a powerful and versatile typing tutor developed and published in association with Pitmans. It is designed to enable you to acquire or enhance typing and keyboard skills. **£12(d).**

Record Keeper A personalised program for storing and retrieving data for a variety of purposes. Report facility lets you choose how to generate the layout of your data and display and print it. The program also contains alternative versions for transfer to disc. **£16.50(d).**

BOOKS

(No VAT p&p £1.50 per book)

Let your BBC Teach U To Program.....	£3.50	DIY Robotics & Sensors.....	£6.95
100 Programs for the BBC.....	£6.95	Disc Book.....	£3.50
30 Hour Basic.....	£6.95	Disc Systems.....	£6.95
35 Educational Progs.....	£6.95	Discovering BBC M/Code.....	£6.95
6502 Applications.....	£10.95	Essential Maths BBC/Electron.....	£5.95
6502 Assembly Lang Programming.....	£13.95	Forth.....	£7.50
6502 M/Code for Beginners.....	£15.95	Friendly Computer Book.....	£6.95
6522 VIA Book.....	£4.50	Graphics on the BBC Micro.....	£6.95
6809 Assembly Lang Programming.....	£13.95	Graphs & Charts.....	£7.50
Advanced Graphics with BBC.....	£9.95	Interfacing the 6502.....	£10.95
Advanced M/C for the BBC.....	£7.95	Intro BBC Micro.....	£5.95
Advanced Prog Tech for BBC.....	£8.95	LISP.....	£7.50
Advanced 6502.....	£11.75	Making Music on the BBC Computer.....	£5.95
Advanced User Guide.....	£12.50	Micro BBC Basic Sound Graphics.....	£7.95
Assembly Lang Prog on the BBC.....	£8.95	MOS Memory Data Book.....	£3.95
Assembly Lang for the BBC.....	£8.95	Prog the BBC Micro.....	£6.95
Assembly Lang Prog for Electron.....	£26.00	Programming the 6502.....	£10.95
Assembly Lang Programming Birnbaum.....	£8.95	Programming the 6809.....	£11.95
Basic Prog on the BBC Cryer.....	£5.95	Programming the 8086/8088.....	£11.75
Basic Rom User Guide.....	£7.95	Programming the BBC.....	£6.95
Basic II Rom User Guide.....	£4.00	Programming the Z80.....	£13.45
BBC Basic.....	£5.95	Start Prog with Electron.....	£5.00
BBC Basic for Beginners.....	£6.95	Step by Step Prog Book 2.....	£5.95
BBC Micro for Beginners.....	£6.95	Structured Programming.....	£6.50
BBC Micro Disk Companion.....	£7.95	The Electron Book.....	£5.00
BBC Micro Expert Guide.....	£6.95	TORCH Z80 Disc Pack User Guide.....	£10.00
BBC Micro Graphics & Sound.....	£7.95	TTL Data Book Vol-1.....	£9.00
BBC Micro in Education.....	£6.50	TTL Data Book Vol-2.....	£8.20
BBC Micro Revealed.....	£3.50	BBC User Guide.....	£15.00
BCPL User Manual.....	£15.00	Using BBC Basic.....	£10.00
Beyond Basic.....	£7.25	Using Floppy Disks.....	£6.95
Creating Adventure Progs.....	£6.95	Using the 6502 Assembly Lang.....	£14.50
Creative Graphics.....	£7.50	Z80 Applications Book.....	£13.45

EDUCATIONAL PROGRAMMES

A selected range of cassette based software for all the family to enjoy and at the same time arouse curiosity and create an interest in computers. Apart from providing hours of fun they will also help teach the young ones fundamentals of English and Maths without them realising it.

Mr T's Alphabet Games Watch how quickly the children learn to identify, name & match the letters and also write them correctly. Amusing sound effects and animated graphics make learning fun. **£7(d).**

Number Gulper A gripping fast moving game that helps develop arithmetic skills. 19 levels of skill to cater for all ability levels. Even parents might find upper levels embarrassing. **£7(d).**

Words Words Words A stimulating game to help young children with reading & spelling. Pictures are shown on the screen and the child has to type in the name of the object shown. If correct, the object takes its place in a scene. When all objects have been correctly identified the scene comes to life. **£7(d).**

Tree of Knowledge A interactive program that teaches categorisation. The computer is first educated about a group of objects — e.g. plants or birds. The database, or tree created in this way is then used in a guessing game. Two sample databases are supplied on the program. New databases are saved and loaded from within the programs. **£7(d).**

Royal Quiz Pit your knowledge of Royalty against Anthony Holden, the Royal Biographer. Do you know who told the queen that she didn't recognise her "without her crown on"? The quiz will tease, teach and entertain. **£7(d).**

Science Fiction Quiz A SF quiz in the widest sense, especially adapted from the Weidenfeld Quiz book that will provide hours of edification and amusement. **£7(d).**

TECHNOMATIC SERVICE

Our in depth stocks allow us to offer immediate deliveries on most items and our aim is to provide the best available products at competitive prices. In addition to the items listed above we carry extensive stocks of: connectors, connector assemblies, components including TTLs, CMOS, RAMS, EPROMS and CPUs. Spares for the BBC computers are normally available from stock. Orders from government departments, public bodies, hospitals, schools, colleges, universities and recognised PLCs welcome. We specialise in world wide exports. No VAT on exports. Our specially negotiated freight charges to many countries ensure the customer considerable savings on charges.

TECHNOMATIC LTD

MAIL ORDERS TO: 17 Burnley Road, London NW10 4ED
(Tel: 01-208 1177 Telex 922800)

SHOPS AT: NW London: 15 Burnley Road, London NW10 4ED
⊕ (Dollis Hill 2 mins walk, ample car parking space)

West London: 305 Edgware Road, London W2. Tel: 01-723 0233
(Near Edgware Road) ⊕

01-208 1177

All prices exclude VAT. Please add 50p carriage unless indicated as follows:

(a) £8; (b) £2.50; (c) £1.50; (d) £1.00.

add 15% VAT to the total order value. For fast delivery telephone your order quoting VISA or Access card or official order number.
(Minimum telephone order £5).

The Definitive 24K ROM based Random Access Database Management System for the BBC Micro.

DATA
GEM



DataGem is here! The most comprehensive Database Management System ever written for the BBC Micro, allowing up to 5100 user definable records. Facilities are also included for interfacing with 'Wordwise' and 'View' word processors.

DataGem will not work with cassette based systems and requires a model B BBC Micro computer fitted with at least one disk drive and operating system 1.2 or greater. Use of a printer is optional.

Write to or telephone Gemini for further information, or complete the coupon below. Stock subject to availability.

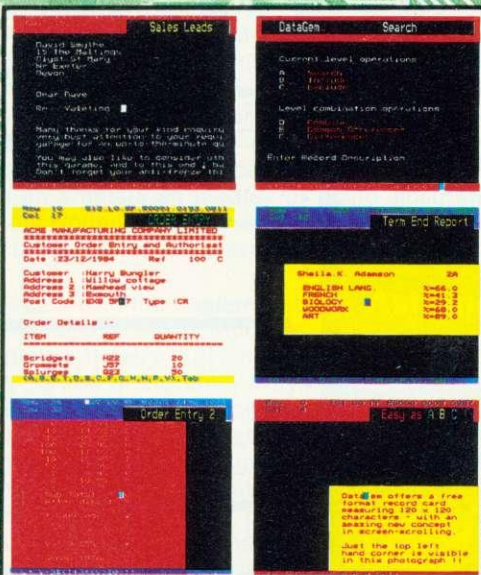

Gemini

18a Littleham Road, Exmouth, Devon EX8 2QG England

Available from:

Most good software dealers... or phone Gemini for immediate despatch quoting your Access, Visa or American Express card number. Telephone (0395) 265165/265832. Alternatively make your cheque or Postal Order payable to Gemini Marketing Ltd., and send to Gemini Marketing Ltd., 18a Littleham Road, Exmouth, Devon EX8 2QG.

Please send urgently.....DataGem(s) @ £129.95.
Prices stated include VAT and Post and Packing (UK only)

Name

Address

Signature

Credit Card No. Access/Visa/American Express

Gemini

Integrated Accounting

for the BBC Micro.

Designed for the small to medium sized business user, where speed and efficiency are vital, Gemini Integrated programs are suitable for sole traders, partnerships, or limited companies. All require a BBC B 32K microcomputer, and an 80 column printer. A double disk drive with an Acorn compatible DFS is required for integrated accounting purposes. A single disk drive may be sufficient where modules are used independently, although this is not recommended for the Sales Ledger and Invoicing module. The manuals indicate the system capacities for various disk drive combinations.

Why Integrated Accounting?

Because it will retrieve information stored in one program for use by another, and store data in one program which has been generated by another.

Why Gemini?

Because our business software for the BBC Micro is based upon the solid foundation of experience. Not only are three of our Directors Chartered Accountants, but we have also successfully written business software for the BBC Micro since it was first launched.

STOCK CONTROL

A program providing full control over every aspect of stockholding operations.

Inventory Master File holding details of part number, selling and cost price, sales and product code, current stock, location of stock, allocated items, re-order level, quantity on order, current period activity and supplier code.

Maximum 980 part numbers on 40 track disk and 1980 on 80 track disk per stock file.

NO SECOND PROCESSOR REQUIRED!

INVOICING & SALES LEDGER

Produces invoices and statements for customers and enables a tight control over credit procedures to be maintained by producing aged debtor reports.

Automatic updating of sales ledger.

Can hold up to 135 customers on 40 track disk system and up to 610 customers on 80 track disk system per Sales Ledger file.

Comprehensive analysis of invoices over unlimited, user definable sales codes.

Price £99.95 per Module VAT inclusive

NOMINAL LEDGER

This is the central module of the Integrated Accounting system and may also be used independently as a Cash Book or interfaced with the Sales and Purchase Ledgers and Payroll programs.

143 Nominal accounts all of which are user definable.

Full cash Book facilities.

Print out of full Trading and Profit and Loss Account and Balance Sheet together with notes to the accounts.

PAYROLL

Provides a full range of controls over the different aspects of Payroll Accounting including tax and other deductions.

Employee file containing Name, address, sex, marital status, National Insurance Number and contribution type, date of birth, personnel number, department, type date of employment commenced, all applicable tax codes, whether pay cycle, payment type (cash, cheque or direct transfer), PAYE reference number, previous name, bank details.

Maximum 50/98 employees on 40 track single/dual disk system and 140/198 employees on 80 track single/dual system per Payroll file.

PURCHASE LEDGER

Used independently or interfaced with the Gemini Nominal Ledger, the program maintains a complete file for each supplier, records amounts outstanding at any time, helps to determine which invoices are payable, and payment dates for the claiming of discounts.

Comprehensive analysis of invoices over unlimited, user definable expense headings.

Maximum number of suppliers on 40 track disk system of 135 and maximum of 610 suppliers on 80 track disk system per Purchase Ledger file.

Pre-Printed Stationery

The following Gemini two-part pre-printed continuous stationery forms are available by completing the order form in the manual: Invoices, Statements, Remittance Advices and Payslips.

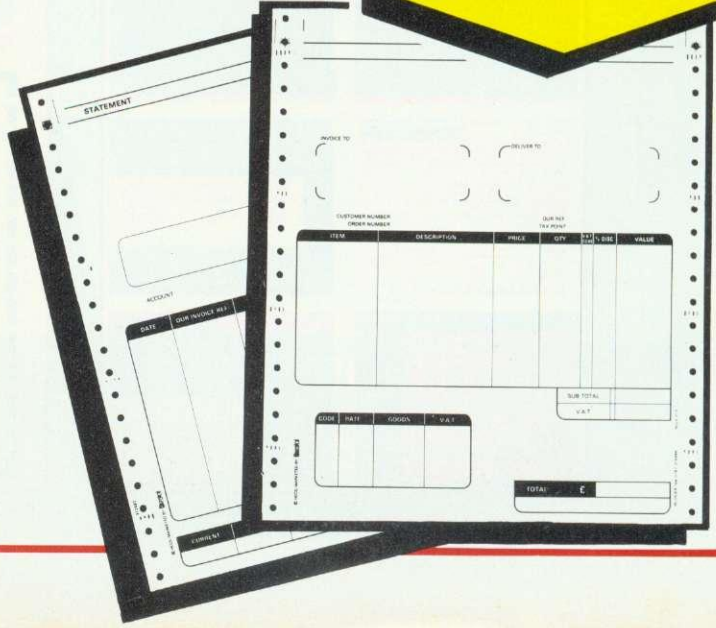

Available from:

Larger branches of Boots and W.H. Smith and most good software dealers... or phone Gemini for immediate despatch quoting your Access, Visa or American Express card number. Telephone (0395) 265165/265832. Alternatively make your cheque or Postal Order payable to Gemini Marketing Ltd., and send to Gemini Marketing Ltd., 18a Littleham Road, Exmouth, Devon EX8 2QG.

Please send urgently (specify 40 or 80 track)

.....

Prices stated in this brochure include VAT and Post and Packing (UK only).

Name

Address

Signature

Credit Card No. Access/Visa/American Express (delete)

A.U.

LIFE, THE UNIVERSE AND MY BEEB

Astronomer Chandra
Wickramasinghe
and his micro
pursue a theory of
organisms in space



Figure 1. The Trifid nebula in the constellation of Sagittarius

Courtesy Hale Observatories

27

COMPUTERS are now vital to space science and astronomy: first collecting information from space probes and satellite-borne telescopes, and then analysing and interpreting the results. Micros have also played a role, especially when linked to equipment launched in rockets.

However, I have a more personal story of working with micros. My research into the origins and evolution of life in the Universe is aided and abetted by my own BBC model B with Cumana disc drive, PL digitiser, Epson FX80 printer and Tandy graph plotter. It might seem an amateurish medley of equipment, but I found it better in some ways than a university mainframe computer!

My tale begins with the Lagoon and Trifid nebulae in the constellation of Sagittarius (figure 1). Here is a rich field of stars in a portion of the Milky Way, containing in addition to stars, clouds of hot glowing gas, with dark patches and striations silhouetted against a brighter background. The dark patches represent clouds of obscuring dusty material found in many galaxies and known to astronomers as "interstellar fogs".

Matter exists within these clouds in a variety of forms: single atoms, ions, molecules and, perhaps the most baffling component of all, 'dust'. These dust particles have radii in the range 1/100 to 1/3 of a micrometer and their space density by earthly standards is exceedingly low – the average distance between them is as much as 100 metres! Despite the tenuous nature of the clouds, their size – light years across – is so vast as to produce the fog patches shown in figure 1.

Light from distant stars in our galaxy is dimmed and reddened by scattering and absorption effects in interstellar dust particles. The effect is similar to

the dimming of a street light seen through a fog, caused by the water droplets scattering the beam of light. Since the 1930s, a succession of attempts have been made to determine in a quantitative way the dimming – or extinction, as it is called – of starlight due to cosmic dust. In fact, the intensity of visual starlight is reduced by a factor of about 100 for every 3000 light years travelled through interstellar space. It was also readily shown that this dimming could reasonably be attributed to tiny solid particles with average radii of about one third of a micrometer. Furthermore, the smeared-out density of dust made up one tenth of a per cent or so of

Astronomer in action

The author is an internationally renowned astronomer; a collaborator with Professor Sir Fred Hoyle, and co-author with him of books such as 'Lifecloud', 'Diseases from Space' and 'Evolution from Space'. Their latest book, entitled 'From Grains to Bacteria', is due to be published this month by the University College Cardiff Press.

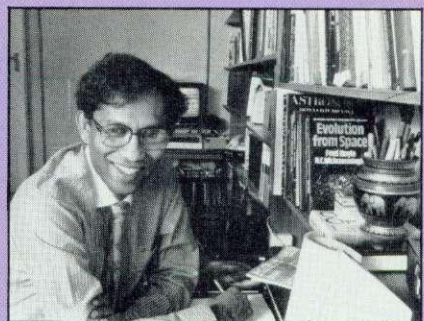

BBC AND ELECTRON
VERSIONS FOR CBM 64 & SPECTRUM SOON

SPACE STATION ALPHA

A GRAPHICAL SPACE BATTLE

The deadly cylon fleet has reached its destination. Their objective - destroy planet earth. Each ship in the fleet carries a single devastating lithium torpedo. Earth shields are up but their power is being drained. You, as commander of earth's last remaining space station are all that stands between the cylons and earth's total obliteration.

£7.95



SPACE STATION ALPHA



ZORAKK

THE CONQUEROR
A GRAPHICAL ADVENTURE GAME

Journey through the medieval lands of Ramagora in search of the three pieces of the long lost crown of Ultimate Darkness. Battle with vicious brigands, avoid the greed of the great dragon, suffer plagues and famine in pursuit of your ultimate goal.

This is a graphical adventure in which you play the part of Zorakk and take control of his loyal warriors.

£7.95

ICON

SOFTWARE

65 HIGH STREET, GOSFORTH, TYNE & WEAR, NE3 4AA.
TEL: (091) 2846966

AVAILABLE FROM ALL GOOD COMPUTER STORES,
OR DIRECT FROM US!

TRADE ENQUIRIES WELCOME

ATTENTION PROGRAMMERS!
WE PAY EXCELLENT ROYALTIES FOR ORIGINAL EXCITING PROGRAMMES ON BBC, ELECTRON, CBM 64 & SPECTRUM

Please send me the following items

ZORAKK.....ELECTRON BBC I enclose cheque for £

ALPHA.....ELECTRON BBC

Name _____ Address _____

all the stellar and non-stellar material in the immediate vicinity of the Sun.

Data on interstellar dust is being steadily added to from observations made by satellites such as the International Ultraviolet Explorer and IRAS. Much of the information has accumulated over the past two decades, and it was at the start of this period that my own work with Sir Fred Hoyle began. We set out in 1962 to find a composition of cosmic dust that could explain the available data, and we have continued in this endeavour unceasingly ever since. We first explored the possibility that the dust in space might have an icy composition, but had no success at all. Then we discussed the possibility of carbon dust grains and carbon grains overlaid with icy mantles. Here we had a limited measure of success in that observations using the latest satellites and rockets proved that at least a fraction of the dust in space was made of carbon in the form of graphite. Next we considered mineral grains and mixtures of minerals with graphite in attempts to match the full range of observational data, but woefully without luck. The precise composition of the interstellar dust stubbornly defied identification for 10 years.

Then, in 1973, we considered the possibility that cosmic dust had a predominantly organic composition. This model instantly led to a better – but not perfect – agreement with observational data than for purely inorganic grains. However, we felt that at long last we were approaching the correct solution. Then in 1979 a major breakthrough occurred. Sir Fred Hoyle and I considered the seemingly outlandish proposition that the cosmic dust grains were not merely organic, but biological; live, freeze-dried bacteria in space.

Within days of arriving at this heresy, a mathematical calculation was carried out on a BBC micro to determine the way in which such particles cause the dimming of starlight. The computation involved a solution of the well-known Maxwell's equations with the boundary conditions for spheres having the properties of biological particles. The BBC's highly versatile Basic language made this calculation relatively easy, and the resulting graphs were plotted on the Tandy plotter-printer. The calculated curve of the microbial model agreed almost precisely with the astronomical data (figure 2). This agreement, coming after almost two decades of failure, gave us confidence to embark further in the direction of cosmic microbiology.

Together with Mr S Al-Mufti and Dr A H Olavesen, Sir Fred Hoyle and I next set up a program of laboratory studies to look for diagnostic thumbprints of

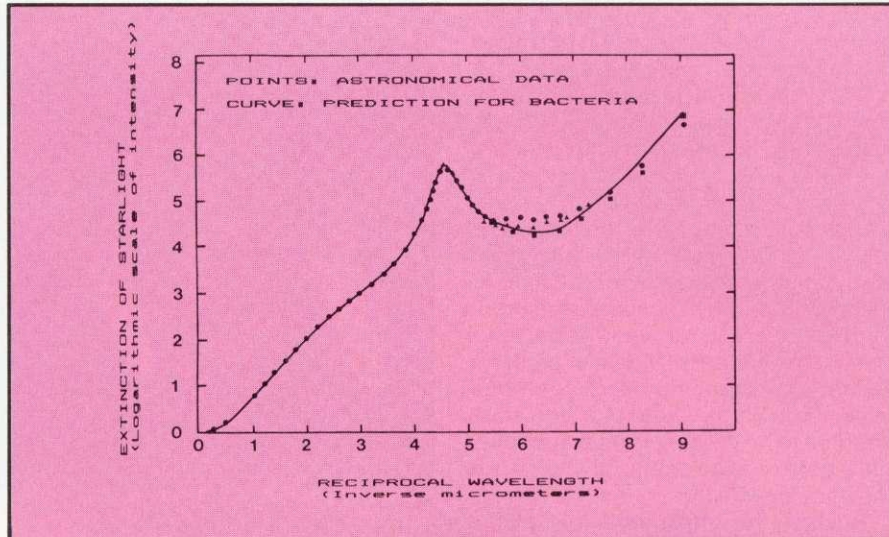

Figure 2. The dimming of starlight by cosmic dust

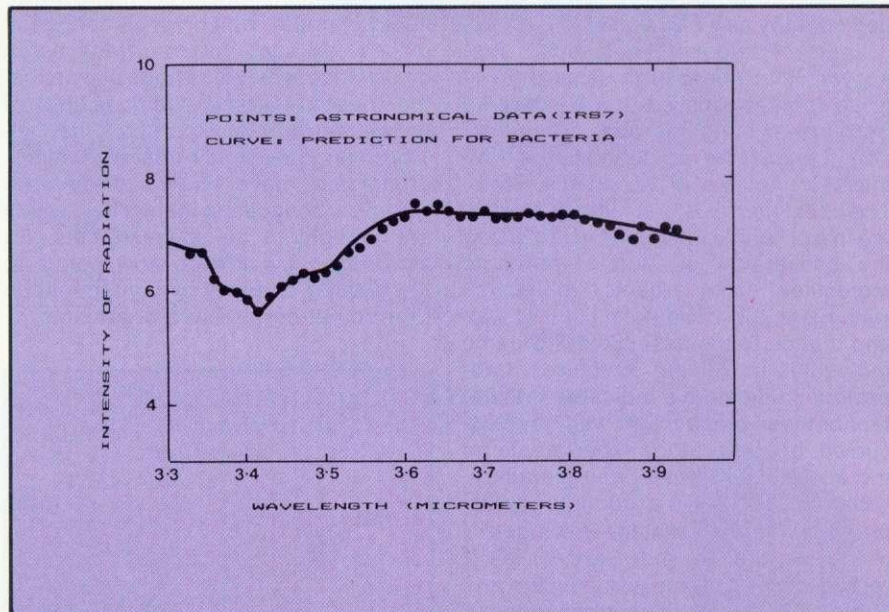
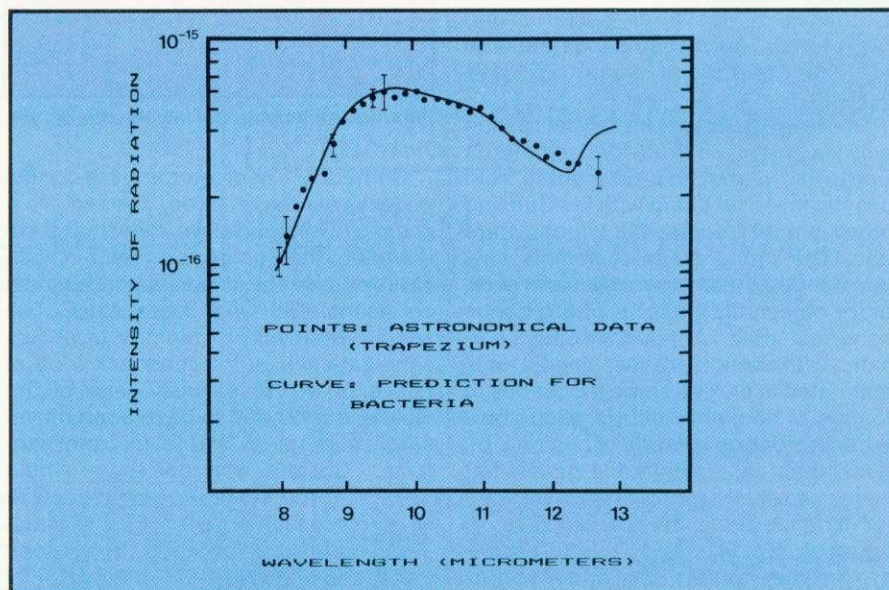

Figure 3a (above). Radiation from IRS7 showing effect of absorption by cosmic bacteria

Figure 3b (below). Radiation from hot bacteria in the Trapezium nebula in the constellation of Orion



biology at infra-red wavelengths. An infra-red spectrum of a dried out micro-organism over the waveband 2.9-5.5micrometers was compared using the digitiser with data for the infra-red source IRS7 located near the centre of our galaxy. The result, shown in figure 3, was plotted on the Tandy. Figure 4 shows a comparison between the biological model and astronomical data over another waveband, 8-12micrometers. The correspondences seen in figures 2-4 are in our view decisive for the identification of cosmic bacteria. Bacteria resembling terrestrial bacteria, but in a freeze-dried state, seemed to be present in vast quantities on a galaxy-wide scale, giving rise to the dark fog effects.

But how, you might ask, could such a situation arise, and how does this connect with other facts from astronomy and geology as well as biology?

Louis Pasteur (1822-1895) first showed that micro-organisms did not arise spontaneously, but were derived from pre-existing microbes. The question then arises as to how the first micro-organisms arose on the Earth. The usual theory is that flashes of lighting in a primitive atmosphere led first to the conversion of simple inorganic molecules into organic molecules which are the building blocks of life, and thence to the assembly of organic molecules into living structures. Laboratory studies have indicated that the first of these steps might well have occurred, but laboratory experiments on the second step have been singularly without success. An argument against the usual theory is that the first signs of microbial life in the Earth's fossil record occur far too abruptly for any chemical evolution to have preceded it. In fact, at the very first moment that life could have survived on Earth, about 3.8 billion years ago, we find evidence of microscopic fossils of bacteria and microfungi. There seems too little time for any 'primordial soup' to have brewed.

There is, of course, no logical reason why life should have started *de novo* on Earth. Our planet was assembled from cosmic material along with the Sun and other planets some 4.6 billion years ago. The entire solar system is now surrounded by tens of millions of cometary objects in the form of a gigantic spherical halo. Although direct collisions with comets are rare, the Earth is estimated to pick up some thousands of tonnes of cometary debris each year. What this debris is made of can only be guessed at by studying the gases that escape from the comet head as seen for instance in the fan-like structures of figure 4. Sir Fred Hoyle and I have argued that comets are in fact chock-

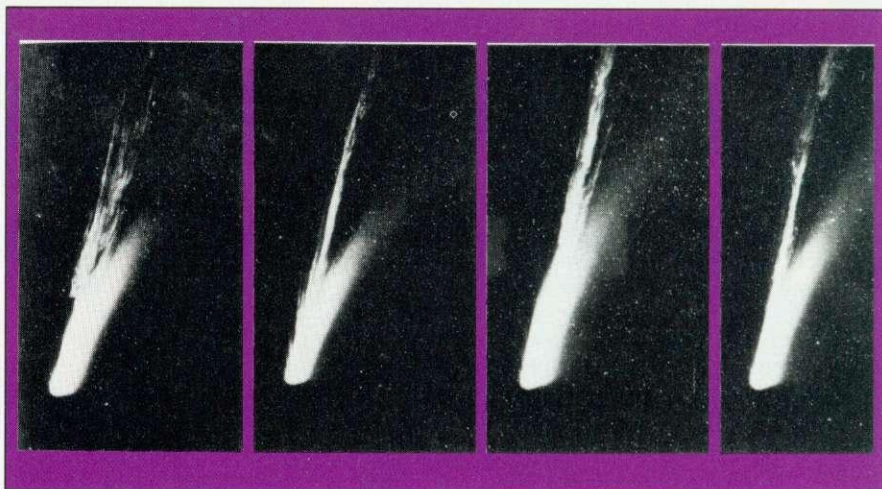

Figure 4. The Comet Mrkos photographed on several days in 1957

a-block with cosmic micro-organisms, and that their nuclei contain warm liquid ponds which are congenial places for such micro-organisms to breed. Indeed, studies have shown that the overall atomic composition of comet material is remarkably life-like. Moreover, fossilised remains of micro-organisms have been discovered within carbonaceous meteorites, which are thought to be spent comets. So astronomical evidence now points to life starting on Earth by contamination from comet-borne micro-organisms.

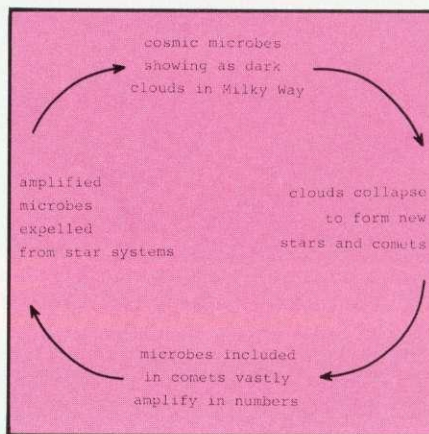

Figure 5. Amplifying Cosmic Feedback loop

Cometary micro-organisms must necessarily have been derived from cosmic dust clouds. We know that stars similar to the Sun are born within such clouds, and comets would undoubtedly be associated with these stars. The cosmic life-cycle of biology is shown schematically in the feedback loop of figure 5. In the earliest days of the Galaxy there need to have been only a small number of viable micro-organisms. Cosmic microbiology would become progressively amplified with every successive generation of stars. The great power of the feedback loop lies in the enormous replicative ability

of biology: a single bacterial cell can double in a matter of hours.

At the present stage in the evolution of our Galaxy some 100 billion circuits in the loop of figure 5 would have taken place, one for every sun-like star. The total mass of material that has been biologically processed would measure some 10^{33} tonnes.

At the time the Earth formed as a solid body, biological evolution in the galaxy would already have been well advanced, and this heritage of evolution would have been trapped in the comets of our solar system. Cometary micro-organisms would have been raining down on the Earth essentially from the dawn of its creation. At the beginning, however, hostile physical conditions would have prevented the survival of any incident organisms, in the same way that organisms would now perish at the surface of the airless Moon.

Cosmic life took root on our planet at the very first moment when survival was possible, when the Earth had acquired its oceans and atmosphere nearly four billion years ago.

According to the present point of view the influx of cometary microbes must have continued unabated to the present day, some causing epidemic diseases in plants and animals, others generally adding to the microbial flora of our planet. Furthermore, and perhaps most importantly, the evolution of living forms on our planet would seem to be primarily controlled by the entry of new genetic information from cosmic micro-organisms.

NEXT in our Trailblazers series:

Scientists are using a BBC micro to roast weeds and give cocoa plants the kid-glove treatment. Find out why in next month's issue

Introducing The New Epson Micro Printer At Only £99.95 inc.VAT

Ideal for use with the BBC Micro, and most popular home computers.
Parallel and RS232 versions available.

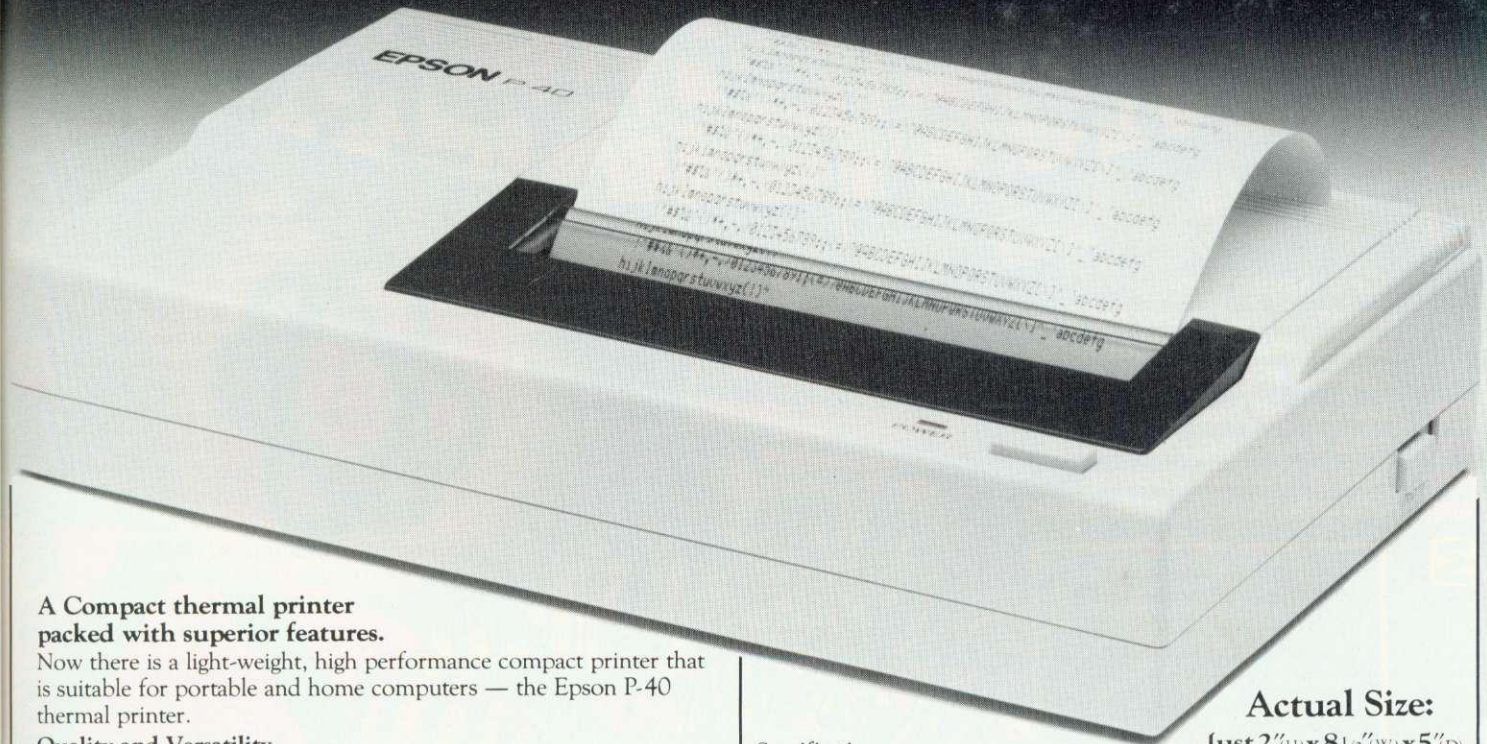

A Compact thermal printer packed with superior features.

Now there is a light-weight, high performance compact printer that is suitable for portable and home computers — the Epson P-40 thermal printer.

Quality and Versatility

The Epson P-40 is part of the new 'P' range, which offers a micro printer with print quality identical to that found in the Epson range of superior printers. The P-40 is the first low cost printer that can print 480 dots per line which means it can reproduce graphs, and pictures beautifully. The P-40 can offer three kinds of column capacities: 20 columns, 40 columns and 80 columns (condensed) — no other compact printer offers such a selection.

Light, Quiet and Cost Efficient.

Since the P-40 is a thermal printer, operation is particularly quiet and there's no ink ribbon to change. Maintenance is simple. In addition the P-40 portable battery-driven printer has four rechargeable NiCad batteries built into the printer which can be recharged in 6 hours. It's simple, economic and easy to use.

Top Quality Image and High Speed Printing.

The quality of printing in all Epson printers is unequalled and the P-40 is no exception. A superior Epson head design featuring nine dots together with its ability to express small letters ensures superior legibility. The compact P-40 also provides high speed printing with 45cps.

Self Test Function

The P-40 compact thermal printer has a useful self test function.

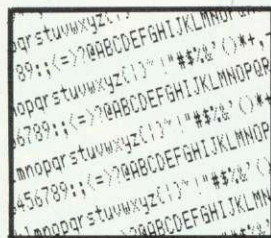

High Resolution Print - Actual Size

Actual Size:

Just 2"(H) x 8 1/2"(W) x 5"(D)

Specifications

Print Method	Thermal Dot Matrix
Print Speed	45 Characters per second (For 40 and 80 column setting)
Print Direction	Unidirectional (Left to Right)
Character Set	96 ASCII character, (Featuring English Capital Letters, English Lower Case Letters, figures, signs and graphics)
Character Size (mm)	2.4 (H) x 1.7 (W) Normal 2.4 (H) x .85 (W) Condensed 2.4 (H) x 3.4 (W) Enlarged
Paper	Epson Thermal roll paper P-40 TRP
Paper Feed	Friction Feed
Paper Width	112mm
Power Supply	NiCad Batteries, Internal

**WATCH OUT FOR
THE NEW EPSON P-80
COMING SOON**

**(0442)
60155**

ORDER BY PHONE OR BY POST



Please rush me _____ Epson P-40 Micro Printer/s for use with _____
and _____ boxes of Epson thermal roll paper. 11m roll

Name _____

Address _____

Tel No: _____

The Epson P-40 thermal printer costs £99.95 (inc VAT).
A box of Epson Thermal roll paper costs £9.95 (inc VAT) — 5 rolls.
Please add £3.00 for postage and packing. Please allow 28 days for delivery.

You can pay for your P-40 micro printer by cheque or by credit card.

I enclose a cheque for £ _____

My credit card no is _____



DE

To order your Epson P-40 now,
just phone 0442-60155
and ask for Angela.

**(0442)
60155**

Data Efficiency Ltd

Maxted Road, Hemel Hempstead, Herts HP2 7LE. Tel: Hemel Hempstead (0442) 60155. Telex: 825554 DATEFF G

FROM THE AUTHOR OF THE TOP SELLING FELIX IN THE FACTORY

PLUTONIUM PLUNDER

Clear a path through the vault and shove the Radioactive Plutonium canisters behind the safety barrier before all hell breaks loose and the Megapods and oscillating Nuclids appear. Casette: £6.95. Disk: £9.95.

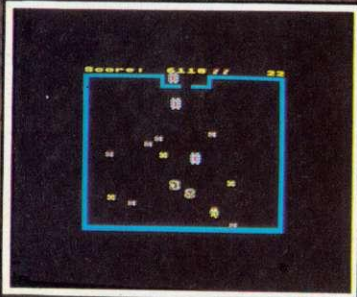

FOR THE
B.B.C. MICRO



**MICRO
POWER**

"WATCH OUT FOR THE FANTASTIC NEW PACKAGING!!"



MICRO POWER LTD.,
NORTHWOOD HOUSE, NORTH STREET,
LEEDS LS7 2AA TEL: (0532) 458800
MICRO POWER SOFTWARE IS AVAILABLE FROM
SELECTED BRANCHES OF WH SMITH, BOOTS, JOHN
MENZIES, CO-OP, WOOLWORTHS AND ALL GOOD
DEALERS.
AUTHORS! WE PAY 20% ROYALTIES!

bat

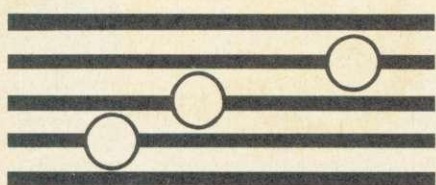

SCALING MUSICAL HEIGHTS

Jeremy Vine conducts a musical lesson on the Electron

33

IN THE August issue of *Acorn User* we published some musical listings but you may not have understood how the programs worked. This month we'll look at the SOUND command available on the Electron and BBC and show how easy it is to produce music. You may have already experimented and created the odd sound or two but creating music is more complicated – but not too difficult.

The SOUND command has four parts to it and we can best understand its use by looking at each part in turn. Type in the following line:

```
SOUND 1, -15, 100, 20
```

The sound you can hear is the C above middle C and it is playing for one second. The SOUND statement is followed by four sets of numbers, each there for a specific purpose and determining the actual noise you hear. This can be more easily understood if we name each part as follows: SOUND C, A, P, D.

The first parameter C refers to the **channel number**. The Electron has four SOUND channels but unlike the BBC only one channel may be played at a time. These channels are numbered from 0 to 3, channel 0 being reserved for noise and channels 1 to 3 for tone. To hear the difference type in the SOUND statement above but change 1 to 0. Whether you type C as 1, 2 or 3 the tone will be exactly the same. These three tone channels produce the same

effect and as only one can be used at any time we will use only the number 1 from now on when we need a tone. The other two channels (2 and 3) have been included to make the Electron compatible with the BBC micro.

The next parameter, A, is responsible for the **amplitude** of the sound and can represent one of three different things depending on the value assigned. If A is negative then the sound is 'on'; if set to 0 it is 'off'. However, if the number is from 1 to 16 inclusive an ENVELOPE of the same number will be selected. I won't cover the ENVELOPE command in this article but don't worry as we need not use it for the moment.

In my example I used -15 as the value. This means the sound is turned on. The reason for using this number is that it is the most common amplitude value used on the BBC on which you can alter the level of the sound. The sound level cannot be altered in the same way on the Elk but by using -15 we keep our programs compatible with the BBC.

The third parameter P stands for **pitch** and as the name suggests it controls the pitch of the sound output. This value can be in the range 0 to 255. Each step represents a change in pitch of a quarter-semitone and from this we can produce a range of pitches covering more than five octaves. Figure 1 shows these values and their corresponding pitches. Try changing the value of P to see how the pitch changes.

The final parameter, D, determines the **duration** of the sound and each step is equal to 50 milliseconds. In the example D=20 this is equivalent to keeping the sound on for 1 second. To work this out multiply D by 50 and divide by 1000.

Now we know how the SOUND command works, and the relationship between the pitch control numbers and the pitches they create, we can start to write music on the Electron.

Type in and run program 1. The program plays a chromatic octave of the 12 semitones from middle C. If we go back to my explanation of the pitch parameter, each unitary value is equal to a quarter-semitone. Therefore four units equal a semitone and octaves will therefore occur at intervals of 48 steps, because there are 12 semitones in an octave (ie, 12×4). To produce a different octave use figure 1 to look up the note of your choice and change the value 52 in line 20. Changing 52 to 68, for example, will play the chromatic octave from E instead of C.

Now you might be wondering how to

BUZZWORDS

Channel—The sound generator on a BBC micro can make up to four sounds at once, so it has four channels. Channel 0 produces specific noises, while the other three produce single notes. The Electron also has four channels but in effect only one channel can produce a sound at any one time.

Amplitude—The volume or loudness of a sound.

Pitch—The frequency of a sound.

Duration—The length of time a note plays.

Envelope—The volume (amplitude) and pitch of a sound rise and fall throughout the sound's duration, and both Beeb and Electron can use pitch and amplitude envelopes to give a sound 'shape'. These are set up with the ENVELOPE statement.

Note	Octave number						
	1	2	3	4	5	6	
B	0	48	96	144	192	240	
C	4	*52	100	148	196	244	*middle C
C#	8	56	104	152	200	248	
D	12	60	108	156	204	252	
D#	16	64	112	160	208		
E	20	68	116	164	212		
F	24	72	120	168	216		
F#	28	76	124	172	220		
G	32	80	128	176	224		
G#	36	84	132	180	228		
A	40	88	136	184	232		
A#	44	92	140	188	236		

Figure 1. Table of pitch values for each semitone

MAKE SURE YOUR HOME COMPUTER WORKS... FOR YEARS AND YEARS

Guarantee years of service from your home computer. Protect your investment by joining the MICRO REPAIR CLUB. After your warranty has run out can you afford the manufacturers' repair charges which can be as high as £60 minimum? THE MICRO REPAIR CLUB is a brand new organisation offering a unique scheme which guarantees that should your computer break down, it will be repaired at absolutely no cost. THE MICRO REPAIR CLUB has been formed to save you money and ensure that your computer is in tip-top working condition for years to come.

A one-year membership that guarantees all repairs to your micro costs only £24.95, with an annual renewal of £14.95.
A two-year membership costs £35.95, three years £46.95.
For incredible value for money a four-year membership costs only £57.95.

All prices are inclusive of VAT

THE MICRO REPAIR CLUB is backed by one of the world's largest insurance groups and the actual repair work will be carried out by Computeraid Services, a division of Thorn EMI Information Technology Ltd.

There can be no greater protection. So if you own a Sinclair, BBC, Acorn, Dragon, Commodore or any other home computer join the Club by ringing the HOTLINE on 01-946 7777 or clip the coupon below and send it to:

Micro Repair Club Limited, Swan Court, Mansel Road, Wimbledon, London SW19 4AA.

Members watch out for more great bargains in the future

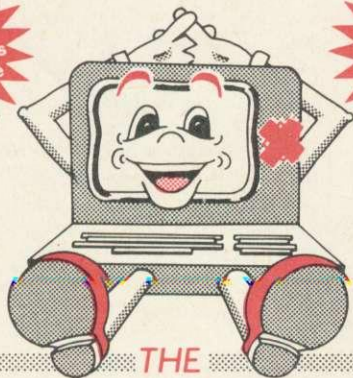

Teachers find out about our special offer for schools

THE
MICRO
REPAIR
CLUB

I would like to join the MICRO REPAIR CLUB for _____ years and look forward to receiving my full membership pack.

I enclose a cheque for **£24.95** One year's membership*
£35.95 Two years **£46.94** Three years **£57.95** Four years

Made payable to Micro Repair Club Limited *Please tick relevant box

Please debit my Visa/Access card No:

Card expires on _____ Signature _____

Name _____

Address _____

I own a _____ home computer and it is in working order.

MUSICSOFT

MUSIC SPECIALISTS FOR THE 32K BBC MICRO

★ THE SYNTH ★ (O.S.1.0+)

"A very flexible and inventive program that's highly recommendable." (Dr David Ellis, E&MM, Oct 83). This 'synthesizer' program has features which to our knowledge are unique. ALTER RHYTHM. The rhythm of a recorded melody may be altered by tapping on a single key. REPEAT. No need to play a phrase twice, great saving in space. REAL TIME PLAYING. With alteration of volume, envelope and octave pitch as you play a note. EDITING. Back and forwards whilst hearing the tune. INPUT. May be hesitant or in correct time. TIDY. 'Cleans up' inaccuracies of input on demand! NUMBER OF NOTES. From 3000 for 1 channel to 1000 for 3, etc. Plus all the other synthesizer programs do PLUS. IE sophisticated envelope editing (very easy), larger keyboard used (TAB to ↓ cursor). No secrets, user transparent. This is the program for the experimenter who wants to make HUMAN music rather than perform mathematical finger dexterity exercises. THE SYNTH. Cassette & instructions only **£8.75 inc. P&P.**

★ KEYBOARDS ★ (O.S.1.0+)

5 programs to turn your BBC into 5 real-time keyboards. 1.3 simultaneous voices (in Basic for easy understanding) 2. Single voice M/C with Pitch Bend. 3.3 simultaneous voice M/C with Envelope control built in. 4. Single finger Chord organ ranging over the whole keyboard, 2 variations for each chord. 5. Chord organ 2 with different chord configuration. These are all separate programs designed for you to use as they are or in your own programs. KEYBOARDS cassette & instructions **£5.75 inc P&P**

★ MUSICTOOLS ★ (all O.S.)

"Musicsoft also produce an excellent 'Musictools 1' cassette... all in all, rather good value" (E&MM, Oct 83)
 Five music utility programs on one tape. Tune Generator with dynamic graphic Keyboard & Stave display, Envelope Command Explorer (Very easy to use), Musical Symbols Graphic routine, Simple single line organ with sophisticated controls. Over 60 procedures for you to use in your programs already in working programs. MUSICTOOLS 1 cassette & instructions **£5.75 inc. P&P.**

★ PIEMAN ★ (all O.S.)

"The best version of Simon I've seen, it goes so much further than most" (Quote by a rival software firm!) Recommended for Primary & Middle Schools. Not as simple as Simon! It develops into a fun set of ear cleaning and musical concentration games. PIEMAN cassette & instructions **£5.75 inc. P&P.**

ALL PROGRAMS TRANSFER EASILY TO DISC.

Cheques and official orders to:
 MUSICSOFT, Dept N, 12 Fallowfield, Amthill, Beds.
 Telephone: 0525 402701

All 4 programs on 40 track disc - £26.00

ACORN APPROVED

ADD 32K TO YOUR BBC MICRO ONLY £49.95.

Opus Supplies offer you Rambank - a 32K sideways RAM board to really boost the capabilities of your Micro.

Unlike ROMs, each block is individually write selectable and can be write protected to ensure against accidental erasure.

If you're running short of ROM sockets, the RAM card allows you to load utilities as and when they are needed.









We'll give you software and utilities free of charge, so you can save ROM based firmware on disc.

- Uses low power 64K dynamic RAM chips.
- Simple to install.
- Consists of 2 x 16K blocks of sideways RAM.
- 2 year guarantee.

Opus.
Opus Supplies Ltd.

158 Camberwell Road, London SE5 0EE. 01-701 8668 or 01-703 6155.

Figure 2. Duration of the various notes

Note Name	Duration	Note Name	Duration
 Semiquaver	2	 Dotted crotchet	12
 Dotted semiquaver	3	 Minim	16
 Quaver	4	 Dotted minim	24
 Dotted quaver	6	 Semibreve	32

create a scale. So far we have played a series of semitones but a scale consists of both tones and semitones. Program 2 gets round this problem by inserting tones or semitones in the correct sequence. Line 70 holds the data for the tones (t) or semitones (s) and line 10 gives the user the choice of scale by entering the appropriate value of the starting note. If a tone is needed an extra value of 4 is added to the variable 'note' to extend the gap to 8 and therefore a whole tone.

Let's go one step further now and play a complete tune. Using the lookup table of figure 1 we now have enough information to convert musical notes into numbers that the micro will understand. That's one half of the conversion from a musical score to numbers; the second part is to tell the computer the duration of each note. Figure 2 shows the numeric values needed for note durations. We can therefore write each note as a pair of values, the first representing the pitch, the latter the note duration.

Program 3 follows such a method and a tune has been typed into the DATA statements in the form of pitch and duration values. By changing the numbers in the DATA statements you can write in your own tunes and the tempo can be altered by changing the value in line 10.

Entering music via DATA statements is fine but for the more enterprising composer there is no substitute for having a keyboard at the fingertips. Once more this is no problem to the Electron and with a bit of thought we can simulate a keyboard instrument. When playing a musical keyboard, notes can be short or sustained, depending on how long or hard a key is pressed. However, with the Electron pressing a key doesn't have the same effect—a note can be played long after the finger has been removed because it plays for a fixed length of time. To ensure that the note is played only while a key is pressed we have to repeat a note very fast instantly to ensure that no gaps occur and that when the finger is removed the sound stops. Program 4 does this. To hear the effect type in the listing and run it.

The important parts to note are the setting of the key delays *FX11 and *FX12, and the conversion of a note to a number. By using the INSTR function we can use the normal qwerty keyboard to represent notes. This is done by assigning all the notes to be used to a single variable 'note\$' and then using GET\$ to search for the occurrence of the pressed key within the string 'note\$'. The key to this is the INSTR function and INSTR works by searching for a match of the string input to the one

held in memory, in this case 'note\$'. If a match is found the position of the key pressed within note\$ is multiplied by four to give the numeric value for pitch (four being the starting point for the note C). For example if 'a' is pressed, the position within the string would be 1 and therefore C below middle C would be played. If the key pressed is 'f', the position returned would be 6 and $6 \times 4 = 24$. If you look this up in figure 1 you'll see the note to be played is F below

middle C. By these means we have reproduced a keyboard spanning two octaves, depending on whether the key is lower or upper case.

This is not, of course, all that you can achieve with the sound chip of your Electron or BBC. In a future article we will take the story further and consider the use of the ENVELOPE command. If you can't wait, though, Martin Phillips has something to say about the subject in his Hints & Tips column.

Program 1. Chromatic octave of the 12 semitones from middle C

```
10 FOR pitch =
  52 TO (52+48) STEP 4
20 SOUND 1,-15,pitch,5
30 NEXT
```

```
10 REM Set tempo
20 tempo=.75
30 REM Read each pair of pitch
40 REM and duration values
50 READ note,duration
60 REM If value = -1 then finish
70 IF note=-1 THEN END
80 REM Play selected note and duration
90 SOUND1,-15,note,duration*tempo
100 SOUND1,0,note,2
110 GOTO50
120 REM Pairs of pitch and duration
130 REM numbers
140 DATA 68,16,68,8,96,16,96,8,76,12
150 DATA 80,4,76,8,68,16
160 DATA 96,8,108,8,116,16,108,8,96,8
170 DATA 104,8,88,8,96,16
180 DATA 116,8,116,16,116,8,108,16
190 DATA 96,4,96,8,88,8,80,8,76,8
200 DATA 60,16,68,16,96,8,88,16
210 DATA 80,8,76,8,68,8,60,8,68,16
220 DATA -1,-1
```

Program 4. Micro keyboard as musical keyboard

These programs, around which Jeremy Vine has written his article, were devised by Joe Telford

Program 2. Tones and semitones to make up a scale

```
10 INPUT"Enter number
  to begin ie C=52",scale
20 FOR note = scale TO
  (scale+48) STEP 4
30 READ gap$
40 IF gap$="t" THEN note =
  note + 4
50 SOUND 1,-15,note,5
60 NEXT
70 DATA %.t,t,s,t,t,t,s
```

Program 3. Pitch and duration values combine to give a tune

```
10 ON ERROR GOTO 150
20 REM Chromatic order of keys over
30 REM 2 octaves.
40 note$="awsedftgyhujkAWSEDFTYGHUJK"
50 REM Set keyboard repeat rates
60 *FX11.1
70 *FX12.2
80 n$=INKEY$(0)
90 IF n$="" THEN GOTO 80
100 REM Conversion of note to number
110 pitch=INSTR(note$,n$)*4
120 SOUND &11,-15,pitch,2
130 GOTO 80
140 REM Reset key repeat rates
150 *FX11.50
160 *FX12.7
170 END
```

SOLIDISK SIDEWAYS RAM: 20,000 UNITS SOLD

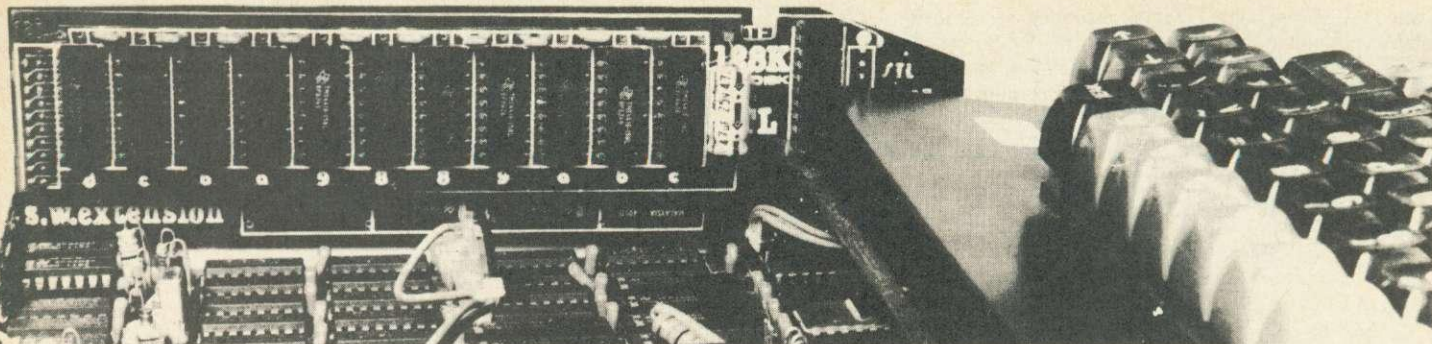

"Exciting" (ACORN USER JAN 84), "Power to your Beeb" (PCN 61, MAY 84), "Break the RAM Barrier" (A&B) HAS YOUR BBC COMPUTER GOT ITS SIDEWAYS RAM BOARD YET?

Not surprisingly many BBC computers have got their sideways RAM boards. Solidisk Sideways RAM can be completely integrated into the BBC computer system: with 6502 and Z80 second processors, Torch disk pack, teletext, Econet and Solidisk 8— sideways ROM expansion board.

Adding Sideways RAM to the BBC computer is simple. And it will multiply the machine's power. Here is how.

1 — HOW DOES IT WORK?

Occupying the same place as sideways ROMs (such as BASIC, DFS etc) it is treated like other sideways ROMs and therefore can replace them.

Sideways RAM can run any language, and filing system, wordprocessors, databases etc.

2 — WHAT SORT OF SOFTWARE DOES IT RUN?

Better than sideways ROM, sideways RAM can be written into. This property makes it not only possible to run the same programs as their ROM counterparts but sideways RAM can be used as Virtual Memory, RAM disc, printer buffer, Basic program store, 65-C-02 assembler, zero RAM, take DFS etc, etc...

3 — WHAT OTHER SERVICES DO YOU GET WITH ALL SIDEWAYS RAMS?

Solidisk sideways RAM comes with lots and lots of free software (see list on opposite page). As a sideways RAM user, you will be able to get updated disks*, free local expert advice and free bi-monthly newsletters to keep you informed. Solidisk spend more than 1,000 man hours every month to produce free software for all sideways RAM users. More and more free software will be available every month.

4 — WHO USES SIDEWAYS RAM?

Solidisk sideways RAM is widely used in schools for ECONET, by programmers to develop new software, in small business systems for wordprocessing and database** and now at home, even for games. New applications are being found every day, such as moving screen memory to Sideways RAM (essential for increasing memory for VIEW and VIEWSHEET), Colour Imaging System, Teletext page logger and generator, computer typesetting etc.

Sideways RAM is such a versatile and flexible instrument that it will renew your interest continually.

5 — WHICH SIDEWAYS RAM DO YOU NEED?

Solidisk sideways RAM is available in multiples of 16k, each replacing a sideways ROM. Units are in 16k, 32k, 128k and 256k.

The first step is to evaluate your needs.

You can buy a small unit to start with, and exchange it later for a larger one. Extra costs involved with upgrading are minimal. The SWR16, 16k sideways RAM is adequate for most simple tasks (running common programs or for Econet slave stations), including fast disk copying with a single disk drive.

For wordprocessor: using VIEW or WORDWISE, a SWR32 will do. Large documents (20 page plus) will require something like SCRIBE and the 128k or 256k Solidisk**.

For database, unless very high speed is required, a SWR32 will suffice for most popular databases such as Beebase, Fileplus, Starbase, Datagem. Otherwise use the 128k or 256k Solidisk**. For the 6502 and the BITSTIK you will need the 256k Solidisk.

Remember — the more memory you instal inside the BBC computer, the more power you will get out of the machine.

All sideways RAM units come complete with 60+ page Sideways RAM User Manual, 1 utility diskette and 1 year warranty.

**Solidisk recommends SCRIBE and STARBASE because they exploit perfectly the inherent speed of RAM disc. Quite often, some users try to solve a software problem (such as increasing the size of Wordwise) by a hardware solution (buying the 128k Solidisk). The better way is to buy Merlin's Scribe (or wait until we offer you one for free) and then increase its speed with the Solidisk. The situation regarding databases is much simpler as Solidisk works well with most of them (from 6 times speed increase with Beebug's Masterfile to 2 times with Starbase).

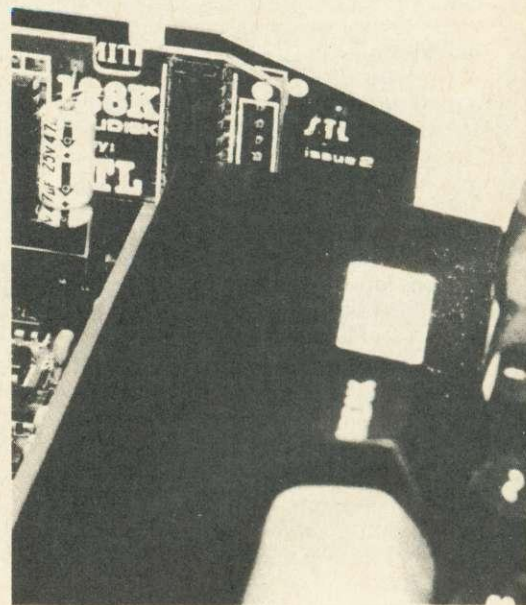

UVIPAC EPROM ERASER

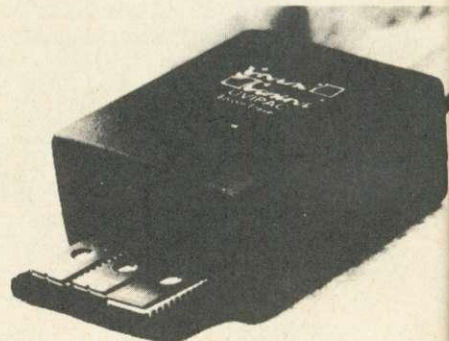

TEAC DISC DRIVES FD55 Series

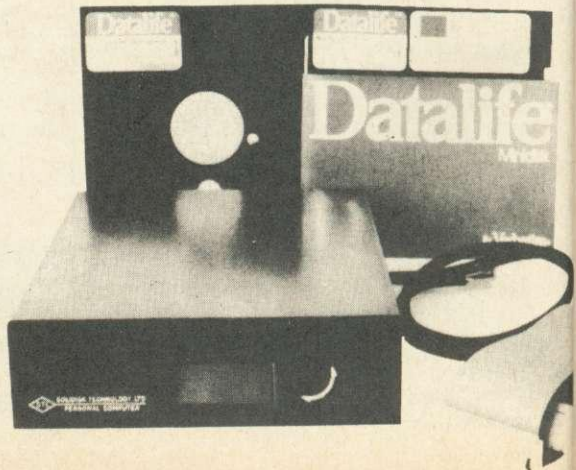

6
C
8
co
A
V
co

T
—
S
—
M
—
fo
—
—
—

—
(R
—

7 —
TH
aut
con
ST
The
disk

8 —
A li
of a
Pot

Soli
Disk
with
with
disk
Mits
num
insta

1 —
The
DFS
an in

2 —
STL
board
straigh

HOW
You
Acc
Edu
Nam
Add

Cre

Call

SO
17 S
SO
ESS

6 - SENDING FOR FREE SOFTWARE:

Our free software is divided into volumes and is available in single density, either 40 or 80 track 5.25" diskettes. 40 track diskettes contain only 1 volume, 80 track diskettes contain 2 consecutive volumes, (1+2, 3+4, 5+6, etc.)

All sideways RAM is supplied with 1 diskette, containing either VOL. 1 (40 tracks) or VOL. 1+2 (80 tracks) as requested. Extra volumes are charged for media and postage cost.

The following volumes are available at the present time:

- VOL. 1: General Utilities: Menu, STLDISC, STLOEOO, STLRFS, Printer Buffer, STLRFS, Quicky, Fastbackup, Keyboard, Word64, help!
- VOL. 2: English Spelling Checker: Silexicon and English dictionary (15000 words).
- VOL. 3: BASIC program generator: Macro Basic. Never Bad Mode again: Virtual Memory.
- VOL. 4: Database: Solidisk Datafile.
- VOL. 5: Foreign Language Dictionary Generator: Silexigen, Silexicon source code for programmers.
- VOL. 6: French spelling checker (15,000 words).
- VOL. 7: German spelling checker (13,000 words).
- VOL. 8: Machine code tools: Solimon, the finest machine code monitor with Disassembler, debugger, single step etc. for both 6502 and 65-C-02 (for second processor. 65 C 02 assembler (for second processor), UVIPROM control software, SPRITES and SPRITE generator (providing 60 sprites per 16k sideways RAM).
- VOL. 9: to be released in October: Solidisk Toolkit, Rubber band, and Z80 drive C (RAM disc facilities for Acorn Z80 second processor).
- VOL. 10 to 19: Source code for use with the Technical Manual.

7 - TECHNICAL MANUAL:

THE TECHNICAL MANUAL contains extensive program listings and notes by their authors. It also covers the MACRO language programming (part of Macro Basic), MOS conventions for sideways software. Solidisk conventions for sideways RAM software, STL DFS entry points, the 65C02 programming facilities and schematic diagram. The Technical Manual package consists of the Technical Manual and 3- 80 track diskettes containing VOL. 10 to 15 and costs £10.00.

8 - LOCAL EXPERT HELP:

A list of local Solidisk experts is printed in the Sideways RAM User Manual. For the cost of a local call, they can certainly help you with installation or software advice. Potential experts are warmly invited to contact us.

SOLIDISK DUAL DENSITY DISK FILING SYSTEM

Solidisk Disk Filing System (STL DFS) is based on the Western Digital WD1770 Floppy Disk Controller for the BBC computer. Solidisk DFS features an AUXILIARY PORT with the possibility of having up to 8 disk drives (4 Double Sided), numbered from 0 to 7 with 2 simple connections. Thus it is possible to connect 4 x TEAC 55F (or Mitsubishi's) with the same data cable, providing 2.8MB of storage for much less than having a fixed disk (and tape streamer or more floppy disks). The total cost of such a system (DDFS + 4 Mitsubishi) is around £650 inclusive. Quite a few users especially schools with a large number of pupils, will find that it is a much better choice and technically speaking, installation is much simpler.

1 - SINGLE OR DOUBLE DENSITY?

The difference is in the number of sectors per track you can get. With single density, STL DFS allows 10 sectors per track (Acorn format), with double density, this number is 16, an increase of 60% at no extra media cost.

2 - CONTENTS:

STL DFS consists of only 4 ICs to be plugged into existing sockets on the BBC computer board. They are labelled: IC 78, IC 79, IC 80 and the DFS ROM. Installation is quite straightforward and should not take more than a few minutes.

HOW TO ORDER?

You can order any item using the coupon. Post and packing is only charged once. Access and Barclay card holders can place their order by phone. Educational authorities, Acorn dealers and OEMs can obtain quantity discounts.

Name:
Address:

Credit Card Account:

Callers are requested to ring first for appointment.

Total: £

SOLIDISK TECHNOLOGY LIMITED
17 SWEYNE AVE
SOUTHEND-ON-SEA
ESSEX SS2 6JQ

SOLIDISK'S NEW TELEPHONE NUMBER:
SOUTHEND-ON-SEA (0702) 354674
(10 lines with automatic exchange)

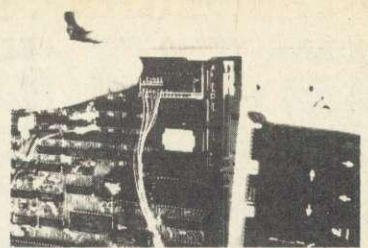

Push in the base unit

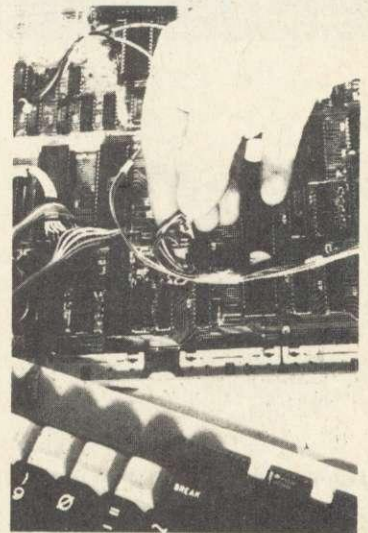

Connect the control wires

PRICE LISTS AND ORDERING (including P&P and VAT)

SIDEWAYS RAM:	
SWR16	£43.65
SWR32	£59.95
128K SOLIDISK	£150.95
256K SOLIDISK	£257.95

The following are upgrade prices for existing Sideways Ram Users:

16 - 32 (return complete item)	£19.00
16 - SOLIDISK (return item)	£110.00
16 - SOLIDISK 256 (return item)	POA
32 - SOLIDISK	£95.00
32 - SOLIDISK 256 (return item)	POA
128 - 256 (return item)	£125.00

DFS AND DISK DRIVES:

SDDFS	£39.95
DDDFS	£49.95
Chip upgrade S - DFS	£11.00
DDFS - 1MHz bus version	£59.95

MITSUBISHI 2 x 80 (incl leads+manual)	£163.00
MITSUBISHI TWIN (incl leads+manual)	£323.00

COMPLETE SYSTEMS: (i.e. DRIVES+DDDFS):

MITSUBISHI 2 x 80	£202.95
MITSUBISHI TWIN	£353.00

DISKETTES (Datalife Verbatim boxes of 10)

SS/DD 40	£17.00
DS/DD 40	£23.00
SS/DD 80	£24.00
DS/DD 80	£29.00

CPU CASE	£13.00
KEYBOARD CASE	£23.99

EPROM PROGRAMMER (use with Swr or Solidisk)	£20.95
UVIPAC EPROM ERASER	£20.95
2764 PACK OF 5	£36.00
Special offer: Eprom Programmer + 5 2764s	£51.00

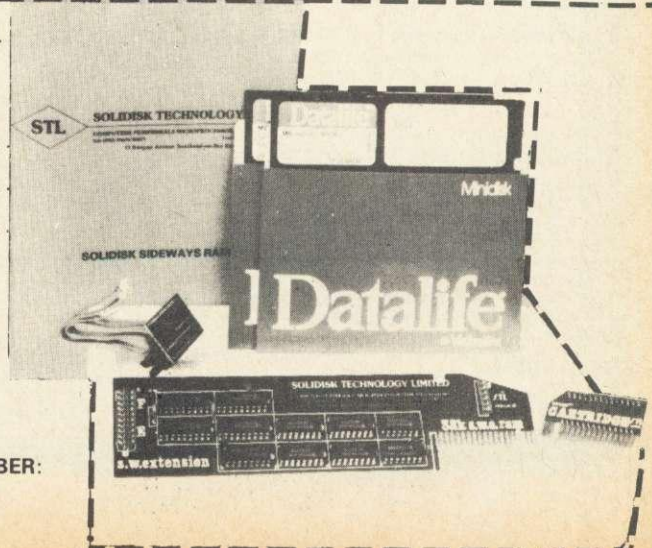



Watford Electronics



Dept. ACORN, CARDIFF ROAD, WATFORD, HERTS. ENGLAND

Tel: Watford (0923) 40588/37774 Telex: 8956095 WAELEC

ACCESS ORDERS Tel: (0923) 50234



SPECIAL OFFER

BBC Micro (Model B)

New Low Price Only: £326

Price includes a **FREE Data Recorder PLUS** five software programs worth £80.

(At Watford we give you a great deal for your money)

6502 2nd PROCESSOR **£175**
Z80 2nd PROCESSOR **£262**

TORCH Z80 DISC Pack **£695**
TORCH Z80 2nd Processor **ONLY £295**

BBC Micro with ECONET **£375**
ECONET Upgrade Kit **£55**
File Server Level 1 **£85**
File Server Level 2 **£215**
Printer Server EPROM **£41**
Clock Terminators (1 pair) **£95**
10 Station Lead Set **£25**
ECONET User Guide and Cable **£10**

Dust Cover for BBC Micro

Protects your expensive Micro from foreign bodies while not in use. **£3.50**

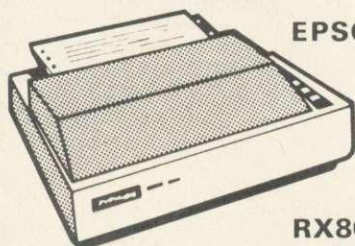

EPSON

RX80

One of the classic printers: 100 CPS, 9 x 9 dot matrix, dot graphics, condensed, double width, normal and italic. 10" carriage; bi-directional logic seek. Centronics parallel interface.

ONLY £229 (£7 carr.)

EPSON RX80 F/T PRINTER

As above but with friction feed capability built in. This allows the use of plain paper sheets.

£245 (£7 carr.)

PRINTER INTERFACE BUFFER

This neatly packaged, self-contained unit is supplied complete with all leads, operating manual and power supply. Computer output to the printer is stored in the buffer so that the computer can continue with other tasks while the printer works from the stored contents in the buffer. 16K holds approximately 10 pages of A4, close to the full memory of Wordwise. The 48K model is very useful for extremely large documents that otherwise tie the computer up for hours while being printed.

Price: 16K **£115**
Price: 48K **£149**

Epson FX80 Printer

The most popular printer in the Epson range. Features include 160CPS, 11 x 9 matrix, proportional spacing, superscripts, subscripts, graphics, many character fonts, user definable character set, margins. Tractor and Friction feed built in as standard. 10" carriage width with bi-directional logic seek for maximum speed. Centronics parallel interface standard.

ONLY £316 (£7 carr.)

Type	Ribbons	Dust Covers
MX80FT	£4.75	£4.50
MX100/FX100	£10.00	£5.25
FX80	£4.75	£4.95
RX80	£4.75	£4.50
GP80	£4.50	-
GP100	£4.95	£3.95
GP250	£5.95	£3.95-
GP700	£18.50	
KAGA KP810	£5.95	
CANON PW1080	£5.95	

RX & FX PRINTER INTERFACES

Epson interfaces fit inside the printer to allow connection using techniques other than Centronics.

RS232	£35	RS232 + 2K Buffer	£59
IEEE 488	£65	2K Parallel	£58

BROTHER HR-15

DAISY-WHEEL PRINTER

This is a high-quality daisy-wheel printer, for the price of a dot matrix. Daisy-wheel quality gives a professional look to your correspondence. Facilities include 18CPS, bi-directional print, 3K Buffer with clear facility, carriage skip movement, text copy switch, proportional spacing, underlining, bold, shadow, super and sub-script, printing in two colours. Impact control allows use of carbon paper. Connects directly to the BBC micro with centronics parallel interface. RS232 interface is an optional extra. Other options are a single sheet feeder that automatically feeds up to 150 single A4 sheets and a keyboard to transform the printer into a sophisticated electronic typewriter.

SPECIAL OFFER

ONLY £339 (carr. £7)

Single Sheet Feeder **£195**
Electronics KEYBOARD **£135**
TRACTOR FEED Attachment **£90**

RIBBON CARTRIDGES:
Fabric **£3**; Carbon **£3**; Multistrike **£6**
DAISYWHEELS (various typefaces) **£18**

LISTING PAPER (Plain)

1,000 Sheets 9½" Fanfold Paper	£7
2,000 Sheets 9½" Fanfold Paper	£13
1,000 Sheets 15" Fanfold Paper	£9
Teleprinter Roll (Econo paper)	£4

PRINTER LABELS

(On continuous fanfold backing sheet)

1,000 90 x 36mm	£5.50
1,000 90 x 49mm	£7.75
1,000 102 x 36mm	£6.25

Carriage on Printer Paper or Labels **£1.50**

NEW DPW1 120

DAISY WHEEL PRINTER

At last a low cost, high quality daisy wheel printer that everyone can afford, yet there are no compromise in facilities available - 20 CPS, bi directional, logic seeking, print 10, 12 & 15 pitch, proportional spacing, QUME Protocols, QUME Ribbon, QUME Daisywheel 96 characters, maximum characters per line: 180 at 1/15" pitch, copy capacity: 4 copies Centronics Interface, Supports all Wordstar features, paper width 13" max., Optional extras: RS232-C Interface, tractor feed attachment, single sheet feeder.

Amazing Introductory Offer:

£219 (£7 carr.)

KAGA KP810

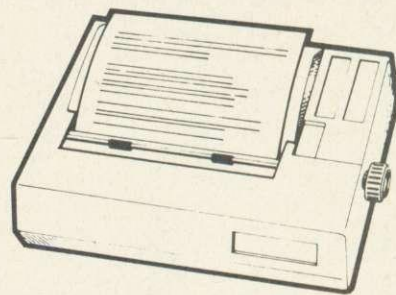

What do the press say:-

"At £269 this is an unbeatable product for what it has to offer." - Educational Computing.

"Offers excellent value for money." - Electronics & Computing.

This new Japanese printer has EPSON FX/RX compatible control codes and is functionally equivalent to an FX80 with the added advantage of its 'Near Letter Quality' mode. It is solidly built and features include: Normal, Italic, Enlarged, super/subscript, proportional spacing and user-defined character set. Extras over the FX80 included in the price are Near Letter Quality (NLQ) print ideal for correspondence, properadjustable tractor feed, half speed quiet mode and 3K buffer. The printer is bi-directional and logic seeking to give a speed of 140CPS for high throughput in conjunction with the standard 3K buffer. 8K RAM may be added to give more user-defined character sets. Centronics parallel interface + Watford's 12 month NO QUIBBLE WARRANTY.

Special Offer: **ONLY £235**

RS232 interface + 2K buffer to connect to other micros

£89

KAGA KP910 PRINTER

Very similar to the KP810 but with 17" carriage for really wide print. Gives 156 columns of normal print or 256 columns in condensed mode. This printer is ideal for printing out spreadsheets and can also be used for correspondence in NLQ mode.

ONLY £349

PRINTER LEAD 36"

Centronics lead to connect BBC micro to EPSON, KAGA, SEIKOSHA, NEC, STAR, JUKI, BROTHER, SHINWA etc. printers.

STANDARD (3 foot long)	£7
EXTRA LONG (5 foot long)	£10

EPROM PROGRAMMER

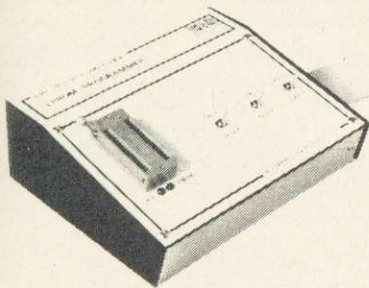

The Watford Electronics' EPROM programmer for the BBC micro is a high quality self contained package. Programs all popular EPROMs from 2K to 16K: 2716, 2516, 2532, 2564, 2764 and 27128. All manufacturers' specifications have been followed to program EPROMs at the correct speed - wrong timings could destroy your EPROMs. The unit has its own power supply so does not put heavy loads on the BBC power supply as do some other units. Connects directly to the 1MHz bus following all Acorn recommendations on addressing and bus loadings.

SOFTWARE PACKAGE

The software is supplied on an EPROM which plugs into the Micro and is instantly available with a single command (no time wasting as on Cassette/disc loading). It is a fully purpose designed and integrated package to simplify ROM development. The system is menu driven with many prompts to avoid any accidents.

Software facilities include:

Load File - Save File - Down Load EPROM - Program EPROM - Verify - Blank Check - Editing of memory contents prior to programming.

Also included is an automatic system to allow Basic programs to be put in EPROM and accessed through the *ROM filing system. More than one program may be put in an EPROM. All these facilities and more are explained in the comprehensive and clear 15 page manual.

ONLY £79 (£3 carr.)

**WATFORD - Always
a step ahead**

TEX EPROM ERASERS

EPROMs need careful treatment if they are to survive their expected lifetime. Over erasure of EPROMs very rapidly turns them into ROMs! The TEX erasers operate following the manufacturers' specifications to give the maximum possible working life by not erasing too fast. We use these erasers for all our own erasing work.

- **ERASER EB** - Standard version erases up to 16 chips. £28
- **ERASER GT** - Deluxe version erases up to 28 chips. Has automatic safety cut-off to switch off the UV lamp when opened. £30
- Spare UV tubes. £9

NEW DESIGN PLASTIC LIBRARY CASES

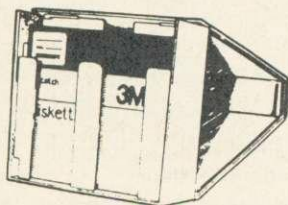

for Disc Storage 5 1/4" (holds 10) £2

DISC DRIVES

(All Drives are NEW SLIM-LINE Type)

NEW LOW PRICES

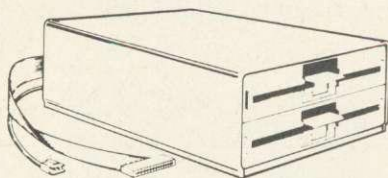

(DRIVES Cased with Cables; connects directly to your BBC Micro)

- **CLS 100** Single, TEC Single sided 40 track 100K, 5 1/4" Disc Drive **£112**
- **CLS200** Single Drive, Double sided 40 track, 200K, 5 1/4" **£129**
- **CLS400** Single, Mitsubishi Double sided 80 track 400K, 5 1/4" Disc Drive **£165**
- **CLS400S** Single, Mitsubishi Double sided 40/80 track Switchable, 400K, 5 1/4" Disc Drive **£199**
- **CLD200** TEC Single sided 40 track 200K, twin 5 1/4" Drives **£225**
- **CLD800** Mitsubishi Double sided 80 track 800K, 5 1/4" TWIN Drives **£325**
- **CLD800S** Mitsubishi Double sided 40/80 track switchable, 800K, Drives **£349**

P.S.

You do not require a formatting disc nor the expensive 40/80 track switchable drives if you use Watford's sophisticated Disc Filing System which has all these facilities in the ROM.

(CUMANA) DRIVES CASED WITH PSU & CABLES

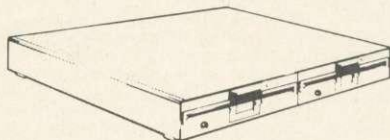
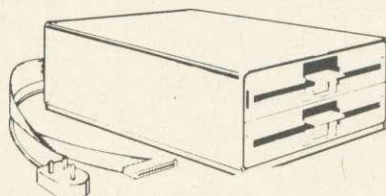

- **CS100** TEC Single sided 40 track 100K 5 1/4" Single Disc Drive **£129**
- **CS200** TEC Single sided 80 track 200K 5 1/4" Single Disc Drive **£175**
- **CS400** Mitsubishi Double sided 80 track 400K 5 1/4" Single Drive **£199**
- **CD200** TEC Single sided 40 track 200K 5 1/4" TWIN Disc Drives **£265**
- **CD400** TEC Single sided 80 track 200K 5 1/4" TWIN Disc Drives **£349**
- **CD800** Mitsubishi Double sided 80 track 800K 5 1/4" TWIN Drives **£399**
- **CD800S** Mitsubishi Double sided 40/80 track Switchable 800K TWIN Drives **£425**
- SPARE DRIVE CABLES, SINGLE £6; DUAL £8
- DFS Manual (comprehensive) £7.50 (No VAT)

DUST COVERS

(For our Disc Drives)

- Single (without PSU) **£3.20**
- Twin (without PSU) **£3.85**
- Single (with PSU) **£3.25**
- Twin (with PSU) **£3.90**
- Twin (side by side) **£3.95**

5 1/4" DISKETTES

Top quality 3M and XIDEX diskettes with a lifetime guarantee. These discs are quiet in operation and insert positively with their reinforced hub rings. Boxes of 10 supplied with disk labels and write protect tabs.

- 10 SCOTCH / 3M + labels S/S S/D **£15**
- 10 SCOTCH / 3M + labels S/S D/D **£17**
- 10 SCOTCH / 3M + labels D/S D/D **£24**
- 10 XIDEX + labels S/S S/D **£15**
- 10 XIDEX + labels D/S D/D **£24**

DISC ALBUMS

Attractively finished in beige leather-look vinyl, these conveniently store up to 20 discs. Each disc can easily be seen through the clear view pockets.

£4.25

LOCKABLE DISK STORAGE UNITS

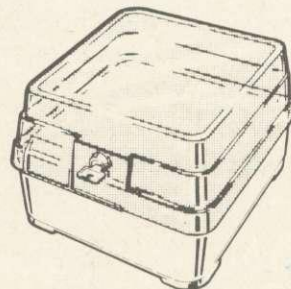

Strong plastic cases that afford real protection to your discs. The smoked top locks down. Dividers and adhesive title strips are supplied for efficient filing of discs.

- M35 holds upto 40 discs **£13**
- M85 holds upto 95 discs **£18**

FLOPPY HEAD CLEANER KIT

The heads in a floppy disc drive are precision made and very sensitive to dirt. Drive manufacturers recommend that you clean the heads approximately once a week. Unless your home or office is dust free one of these kits is a very sensible precaution against losing valuable data. A dirty head can destroy many disks before you realise the trouble. Very simple to use.

Only £14

BBC Micro WORD-PROCESSING PACKAGE

A complete word-processing package (which can be heavily modified to your requirements, maintaining the large discount). We supply everything you need to get a BBC micro running as a word-processor. Please call in for a demonstration.

EXAMPLE PACKAGE
BBC Model B, Watford Electronics' DFS upgrade, Twin 200k Teac drives in beige, Zenith 12" Hi-resolution monitor (Green or Amber), Brother HR15 daisywheel printer. Gemini software: BEEBCALC spreadsheet, analysis and DATABASE software on disc. 10 x 3M discs, 500 sheets fan-fold paper, 4way mains trailing socket, manuals, all leads and BBC carrying case.

ONLY £1,189 (£15 carr.)

ACCESS HOT LINE (0923 50234)

(24 hours)

Continued

MONITORS

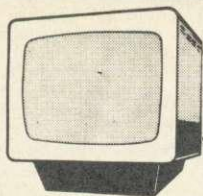

We stock a range of monitors to suit all needs. Choice of a monitor is a matter of personal taste so we recommend that whenever possible, you ask for a demonstration at our shop.

MICROVITEC

- 1431 – Medium resolution as used on the BBC television computer programme ... **£174**
- 1451 – High resolution, suitable for word processing in mode 0 ... **£295**
- 1441 – Super High res, exceeds the capabilities of the BBC micro ... **£389**

All Microvitec monitors are 14" RGB in their distinctive right angled case. They come with the connecting lead to the BBC and a mains plug.

KAGA

- Standard resolution with RGB and composite video inputs ... **£195**
 - High resolution colour ... **£259**
- Kaga monitors are 12" RGB colour with antiglare screen and user access to screen controls.

ZENITH

12" Ultra high resolution monochrome monitor. Ideal for word processing as its green or amber screen is very restful to read. The high resolution makes it good for games too – you can really see the detail that has been put into the graphics. ... **ONLY £75**

LEADS

- BNC for Zenith ... **£3**
 - RGB lead for KAGA ... **£5**
- N.B. Carriage on Monitors **£7** (securicor)

Versatile BEEB SPEECH SYNTHESISER Unit



SIMPLY the best! – An unlimited speech synthesis system. Complete with easy-to-follow manual. Controlling software is in ROM so no Cassette Loading problems!

PHONEMES for word synthesis – That means unlimited vocabulary! No extra speech dictionary chips to buy!

BUILT-in Library of approximately 500 words to get you started.

ENGLISH accent – Utilises inflexion techniques to produce highly comprehensible speech.

EASY to use system – Just plug the software ROM into a socket, the Speech unit into the User Port, and away you go! No specialised 'dealer upgrade' required!

COMPACT unit – The whole system is built into a small case – easily tucked behind the computer. Auxillary output socket provided for direct connection to an external amplifier.

HOURS of fun! – Suitable for any application – Games, Educational Programs, Specialised Packages.

We know this all seems too good to be true but **DON'T BE LEFT SPEECHLESS!** Order your Versatile Speech Unit now!

Only £44

Best cost less at WATFORD

WATFORD'S LAUNCH OF THE YEAR APEX

The ultimate expansion system for the BBC microcomputer. It enables you to increase memory capacity to 2+ MEGABYTES including BATTERY BACKED-UP RAM.

The system consists of a mother board which fits inside the BBC and further daughter cards can be connected externally. The internal card has the following features:

- 15 ROM/RAM sockets, 11 of which can be configured as 2716, 2732, 2764, 27128 EPROMS or ROM equivalent devices or as 6264 RAMs. Any RAM is Automatically battery backed-up and it's contents preserved when the power is turned off.

- The battery is recharged every time the machine is turned on and lasts several months, depending on the number of RAMs fitted.

- There is very little extra current drain, even with a fully loaded board as only the presently active ROM is powered up. In fact the fully populated board uses only 300mA.

- The board reduces micro bus loading by up to three ROM loads, which improves reliability and performance.

- Installation is extremely simple. There is no soldering required. The board is rigidly held by two 40 pin sockets and five support posts. A ribbon cable can be brought outside the computer and up to 8 external cards added. This enables the user to plug-in up to 142 paged ROMs. The cards have following features:

- Each card can accommodate up to 16 devices each of which can be configured as 2716, 2732, 2764, 27128 ROMs or 6264 8K RAMs.

- Battery backup is provided from the internal card.

- Only the active ROM is powered up permitting many external ROMs to be added with very little current loading (100mA per card).

The system comes with controlling software in ROM. The utilities supplied are as follows:

- ★ APEX – replies with the device number currently being accessed.

- ★ APEX C – toggles between the colour and standard black and white messages.

- ★ AL – loads from any device, regardless of the data type.

- ★ AS – saves memory to any specified RAM device.

- ★ AD – prints a directory of the devices present in the system, i.e. ROMs present and files stored. This also reports on the amount of free storage space.

- ★ AF – asks for the free RAM devices.

- ★ LA – repeats the last command to paged ROMs.

Continued

- ★ AT – enters a memory testing routine. This will write a test pattern into the memory and read it back out again. If a fault is found, it is reported to the user. This test continues until Escape is pressed.

- RDISC – activates APEX as a filing system which then treats all free APEX RAM in the system as a continuous 'RAM-DISC'. All commands have similar format to the DFS and transfer is possible between the two systems.

The complete computer system bus is available to the user, so that other cards/devices could be added such as EPROM programmers, second processors, Winchester disc drives, clocks, etc. By racking the cards you eliminate the tangled mass of cables that usually accumulates around the micro.

A comprehensive operating manual is supplied with every APEX Board. Please write in for further details and prices.

THE ULTIMATE DFS FOR BBC MICRO

by

Watford Electronics

Highly acclaimed at The ACORN and BBC MICRO USER Shows. What do the independent press say?

Good value for money – *Beebug Aug. '83*

A very worthwhile package – *The Micro User*

You'll be buying a very powerful package – *Personal Computer News*

Superior DFS; Excellent disc sector editor – *Computer Answers*

Without a doubt, the most sophisticated DFS Software yet written for BBC Micro Computer. This powerful new DFS is fully compatible with ACORN DFS yet has much increased power due to additions, carefully designed to make life easier in normal use. It consists of over 14K of efficiently written machine code. It is entirely self contained and so does not require a utilities disc to function.

Please write in for full technical specification.

PRICES:

DFS (Disc Filing System) ROM **£29**

Complete Disc Interface Kit including DFS ROM & Fitting instructions £99

Disc Filing System Manual. Comprehensive and clearly written **£7.50** (no VAT)

P.S. We will exchange your existing ACORN DFS or PACE (AMCOM) DFS for Watford's highly sophisticated 16K DFS ROM for **£25**

Watford's DFS is exclusively available from Watford Electronics. We do NOT retail through any dealers. Every ROM carries a label with our LOGO and a serial number.

Now available:

Acorn DFS Kit **£99**

EPROMs & CMOS RAMs NEW LOW PRICES

2764-250nS (8K ROM)	£5.25
27128-250nS (16K ROM)	£19
6116-150nS (2K RAM Low Power)	£5.25
6264-150nS (8K RAM Low Power)	£28

BEEB PRINTER ROM



This utility ROM is designed to simplify using all the facilities of your printer. It has many facilities:

- ★ Selection of printer modes such as underline, font and size is by 'Single Key' operations.
 - ★ From Wordwise, a single number following OC will select a mode rather than a long and incomprehensible string of control codes. This makes using your printer with Wordwise much more convenient.
 - ★ When using Basic (or other languages) you can have control over the formatting of the output to the printer in the style of a wordprocessor. You can define page top, bottom and side margins etc. with intelligent page skip for binders an option. All supported printers will now respond to form-feed etc. commands.
 - ★ User defined characters are printed as you see them on the screen so that non-standard characters are automatically printed out correctly.
 - ★ Commands select the options for the following printers:
GP100, STAR, NEC, MX/FX, KAGA, LP/VII/DMP100, DMP200.
- Operates with either parallel or serial interfaces.
- ★ Supplied with a 50 page manual that is very comprehensive and easy to follow. Please specify printer type when ordering so that we can send the correct function key strip.

Price: £24

DUMPOUT 3

A highly sophisticated screen dump ROM. This has to be the most flexible and powerful screen dump ROM yet produced for the BBC micro. It will put on paper anything you see on the screen, including all Mode 7 facilities etc. We have to admit that there is one facility that we cannot replicate - if anyone can supply flashing ink we would like to know!

The ROM also provides window setting facilities and two new OSWORD calls that allow mode 7 graphics pixels to be read and plotted using the standard graphic co-ordinate system. Two commands are used to operate the dump routines:

- *GIMAGE - This provides a full graphics dump of any Mode (including Mode 8). There are various optional parameters but you need only specify the parameters you wish to change.
 - V <scale>, H <scale> - These 2 byte numbers give fine control over the size of the dump from minute to enormous. Unlike other dump ROMs the scale does not change with mode.
 - R <0-3> - Print dump rotated by 0.90, 180, 270 degrees.
 - I <indent> - Set gap from left edge of paper.
 - X <min>, <max>, Y <min>, <max> - The whole of the screen graphics window area is dumped except when these parameters are given.
 - P - Physical colour values are used for plotting, otherwise a negative scale is used (white darkest).
 - T Two tone dump for maximum resolution.
 - M <mask> - 8 bit colour mask.
 - E - Contrast expansion to make mode 7 text and separated graphics stand out from the background.
 - C - All mode 7 graphics are printed as contiguous to improve the shading in graphic areas.
 - *TIMAGE <indent> - Does a fast, text only, dump of the contents of the text window in any mode.
 - *GWINDOW and *TWINDOW - These commands draw the graphics and text windows, respectively, on the screen and allow them to be changed with the cursor keys. N.B. GIMAGE and GWINDOW work fully in mode 7.
- Designed for use with the following printers:
CP80, GP80, GP100, GP250, STAR, KAGA/TAXAN, NEC, SHINWA, GEMINI, EPSON MX/RX/FX, LPVII, DMP 100/120/200/400, CANON.

Price including comprehensive manual

£22

APPROVED for use with telecommunication systems run by British Telecommunications in accordance with the conditions in the instructions for use.

MODEM 84 PRESTEL TERMINAL For the BBC Microcomputer

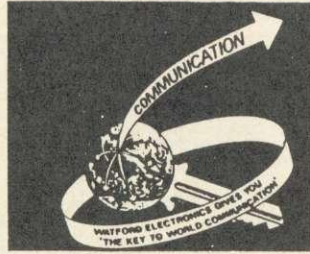

The Watford Prestel package allows B.T. approved connection to Prestel, Micronet and many other 1200/75 baud databases for about the cost of a good tape recorder. Prestel gives you access to an incomparable database covering almost every subject under the sun. There is Micronet with lots of free programs that you can download and run. Details of clubs and user groups, a diary of meetings and exhibitions, news and reviews, technical information etc. There is Homelink with online banking. And there is armchair shopping, travel information, entertainment, world news, sports news, weather information, electronic mail and lots more.

The basic Prestel subscription is only £5 per quarter and at off peak times there is no charge for access time. A local phone call facility means no long distance phone calls to Prestel (approx. phone cost is only 40p per hour).

The Watford Prestel package consists of the B.T. approved Watford MODEM 84 (1200/75 baud full duplex 1200 baud half duplex direct connect) and a very sophisticated Prestel Terminal ROM.

This totally machine code software:

- is fully compatible with not only the Modem 84 but also with the PRISM 1000 and most other modems that require a data link via an RS423/RS232 port making it a worthwhile purchase for those who already have Modems.
- supports full Prestel colour alpha and graphic characters including double height, flashing, conceal/reveal.
- called by simple *PRESTEL (*P.) command. Disc and tape configurations fully supported.
- includes a comprehensive telesoftware downloader for BBC and other programs with continuous on screen status report (an essential facility).
- has very powerful OFF LINE MAILBOX editor allowing colour flashing graphic mailboxes to be prepared without having to be on line to Prestel.
- auto logon sequence can be burnt into ROM if desired.
- a vital 'TAG' facility allows tagging and recall of interesting pages, avoids that common and annoying 'NOW WHERE WAS THAT PAGE' problem.
- includes simple page and program loading and saving functions for both disc and tape, automatically assigning frame and program directories.
- not one but TWO PRINTER DUMP ROUTINES are provided within the software allowing either full graphics dump (mode 7 to EPSON compatible printers) or ASCII characters only.
- a user function built into the software allows interface with specialist routines. (yours as well as ours).

EPSON DUMP ROM

This screen dump ROM is specifically designed for use with the Epson RX/FX printers and the Kaga KP810. It is extremely simple to use as there is only one command to remember. It will accurately dump any screen mode using multiple tones as required. Mode 7 is fully supported giving teletext graphics, double height etc. For those who like to keep life simple this EPROM is only £20.

FORTH ROM for BBC

This ROM provides a complete implementation of the FIG-FORTH standard (including editor). Supplied with a large tutorial manual at only £33

TINY PASCAL for BBC Micro £59

- All the above facilities are accessed via function keys. An overlay is provided to give comprehensive guidance to key functions.
- A 34 page comprehensive instruction/operating manual is supplied.

WATFORD'S 1200 BAUD FULLY AUTOMATIC USER TO USER SOFTWARE

Having purchased the WATFORD PRESTEL TERMINAL which includes the 1200/75 baud MODEM 84 the addition of the WATFORD user to user ROM based software enables you to discover a whole new world of data communication.

This software enables you to use the MODEM 84 very powerfully.

- Send and receive error checked programs and files (even WORDWISE files) to and from other users at 1200 baud.
- 8k file transfer in under 2.5 minutes (approx four times faster than with 300 baud modems).
- The transfer of data is totally AUTOMATIC which means that the modem is automatically switched between transmit and receive under software control.
- A chat mode is provided which also has this automatic switching for receive and transmit. (This mode is essential just before and after data transfer when both hand sets are replaced to reduce noise).
- A copy facility is provided which allows transmission of all screen output.
- A continuous on screen modem status report is included.
- The software is totally function key driven enabling easy transmission, reception, saving and loading of programs and files (Basic, Machine code or Data).
- A help menu is available from within the software as an aid to use.
- Full instructions are supplied.

PRICES

PRESTEL SOFTWARE ROM ONLY (incl. Comprehensive Manual) £20

PRESTEL PACKAGE comprising:
WATFORD MODEM 84, SOFTWARE ROM and Comprehensive Manuals £82 (carr. £2)

USER TO USER SOFTWARE ROM £14

VIEW

VIEW WORDPROCESSOR

We are supplying the new VIEW version 2.1 allowing printing of memory contents etc. . . . £49

FX80 PRINTER DRIVER Watford's own TWO Sophisticated PRINTER DRIVER for VIEW

To simplify using the full facilities of the Epson FX80 or Kaga KP810 use this printer driver. Full facilities are provided for selecting between fonts etc. The disc includes examples of use and instructions. Available on 40 or 80 track disc (please state which required). £6

WATFORD ELECTRONICS VIEW PRINTER DRIVER FOR SILVER REED

We are pleased to introduce a new range of printer drivers to complement the Silver Reed range of printers and typewriters and the View wordprocessor. These drivers have been officially approved by Silver Reed, for use with their printers and typewriters. The View driver allows access to all of the features supported by the range of daisy wheel printers (EXP 700/400/500/550). These include underlining, bold, shadow, superscript, and subscript printing. Additionally, you can use proportional spacing on the EXP 700. Owners of one of the typewriters in the range EXP 55/44/43, using it as a printer, can also access underlining with these drivers. The features of each printer/typewriter are accessible from the two highlight codes, which can be redefined at any point within the text. The printer drivers also extend the facilities in View to allow the use of pad characters. The printer driver on disk with a user manual is at a special introductory price of £7.50. Please specify printer type when ordering.

WATFORD ELECTRONICS

Continued

TWO DATABASE MANAGEMENT SYSTEMS

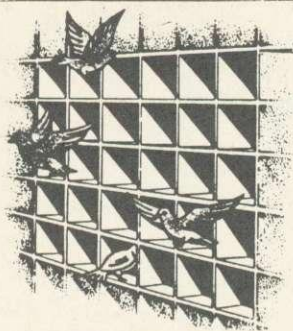

DISCDATA

Discdata is an entirely disc based database handling system. It is extremely easy to use through its comprehensive menu system. The simplicity is such that we do not feel the need to provide explanation on use in the written guidance supplied with the program. The first-time database user will rapidly become familiar with this package designed throughout to be simple and obvious.

Despite the ease of use this system provides all the facilities needed for complex data handling problems. The length of database that can be handled is only limited by the total space on the disc. You can have up to 20 fields with page length records up to 254 bytes in length. Adding and deleting records, amend titles, field names and records. Sort on any field and search for any record or group of records in any field. The database may be re-formatted after creation, the system will re-write all your files for you automatically. You may add extra fields and extend the length of existing fields freely. Output formatting is very powerful. You are allowed 40, 80 or 132 column output modes going to printer or screen. Selected fields can be put in any order on the screen or printer, either across the paper or down. Output can start or stop anywhere in the file. Decimal fields are automatically totalled and records output are counted. Version 2, now on sale has improved input and amendments procedures giving full record edit as well as the 3 extra features... String searching, Calculations on numeric fields, and the ability to create sub files from your main files.

On disc at

Only £17

(Please specify 40 or 80 track when ordering)

FILE-PLUS

The File-Plus package is even more powerful and flexible than Disc-Data. It is also largely menu driven but has its own command language for file searching. The 16K ROM contains all the normally required routines, with lesser used options supplied on the utilities disc. All input and output formatting is controlled through screen forms. A full screen editing system is used to define a form which allows tremendous flexibility in the format in which your data is displayed. It is very easy to change from form to form so that you can type in your data with one form, and examine it with others. You will typically design several forms before starting to access the database so that you can quickly and easily see the fields of each record that you want to appear in the layout you decide on. The form system is also used for output to your printer. File Plus has a unique file linking system that allows the entire on-line storage of your system to be used for one database. This can give around 1.5 Megabyte databases using dual drives and double density.

The built in FQL (File-Plus Query Language) can be used for searching the database. Presented in the form of a powerful command language with looping facilities etc. this allows the most flexible access to your data possible. Full arithmetic operations are provided to allow the system to be used for statistical analysis. Operations supported are -, +, *, /, +-9999999999.9999 and compare facilities = >, <, +, =, >=, <=, &. Many keywords are supported by the language: assign, compare, display, end, goto, iff, if, print, read, search, spool and update.

Supplied with a very detailed 70 page manual to explain all the facilities with many examples.

Only £43

(Please specify 40 or 80 tracks for the utilities disc)

BUFFER & BACKUP ROM

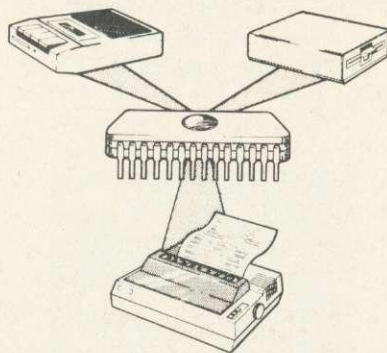

For those with sideways RAM fitted in their machines this utility ROM will make full use of this facility. By using the sideways RAM area for extra memory the following features are implemented:

- ★ 4K or 16K buffer for parallel printer.
- ★ Dumps selection of Disc files to Tape.
- ★ Makes backup copies of tapes on to tape and disc.
- ★ Displays contents of paged ROMs on screen.
- ★ Menu display of ROM filing system contents on Shift-Break.
- ★ Comprehensive manual.

Only £22

DATAGEM

Gemini's 24K ROM based DATABASE Management System
Special Introductory Offer: £99

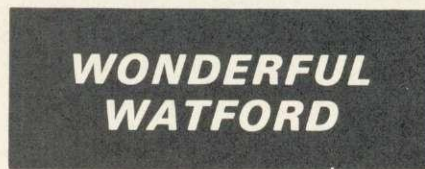

PEN PAL - VERSATILE LIGHT PEN SOFTWARE

Do you have a light pen that never gets used? Then this piece of software is for you. This package offers many useful facilities that make the light pen a useful device to own. Facilities included are:

- Pixel, Line and Character definition
- Free hand drawing
- All Colours
- Fill, Refill and stripes
- User defined "Brush strokes" plus character definer
- Grid, Scale and perspective aids 2 to 200 points palletable in one design with Circles and "rubber banding"
- Move design/character to any screen position
- Save and Load screens, User defined characters and line drawings for video titles, own programmes etc.

This program has many uses in education and at home. It is supplied with a comprehensive instruction manual.

Works with Watford, RH, Acorn User, DIY and many other Light Pens.

Prices

TAPE	£10
DISC (40 or 80)	£11

DISC EXECUTOR

Disc Executor is a sophisticated disc utility for the transfer of your cassette programs to disc. If you have difficulties transferring your cassette software to your disc system then this is the answer. It handles 'locked' files and full length adventures (up to &e blocks) and programs that load below &E00. It is very simple to operate with instructions supplied. It saves you time and money.

Price £10

(Please specify 40 or 80 track discs)

ADE

Complete program development package in a 16K ROM. Full assembling and debugging facilities provided.

SPECIAL OFFER ONLY £43

ROM MANAGER

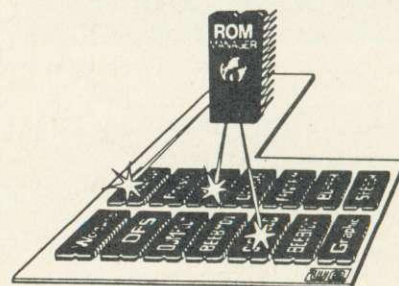

This ROM is unique in its capabilities. It allows you, the user, full control over the BBC Micro's sideways ROM paging system with simple to use commands. This ROM is essential for those with several ROMs. At a simple level ROM MANAGER can be used to remove the problem of clashing command names and allow full use of all the facilities of your ROMs. This is coupled with facilities to completely enable or disable various ROMs in the machine including ROM manager itself.

ROM MANAGER can also be used to develop sideways ROMs using the machine's standard memory. This is achieved by sending sideways ROM calls to your code in RAM, saving the expense of fitting sideways RAM for ROM development purposes. ROM status reports are also given by the ROM, including ROM lengths, checksums, entry points supported and current filing system title.

The ROM also provides facilities to examine ROMs, list function keys for editing, modify RAM (using a HEX/ASCII editor) and list ROM titles neatly and concisely.

The commands given in the ROM:

- **CHECKSUM** - Generates a CRC for a specified ROM (useful for testing suspected faulty ROMs).
 - **DIRECT** - Passes a command directly to a named ROM (overcomes command name clashes).
 - **EXAMINE** - Allows examination of a named ROM
 - **EXPLAIN** - Gives detailed explanation of the first 22 *FX codes.
 - **FILE** - Passes a command directly to the current filing system (which normally receives commands after all the ROMs).
 - **FUNCTION** - Lists the contents of the function keys in a form suitable for editing.
 - **INCLUDE** - Allows the main memory to be used for ROM development.
 - **MODIFY** - Memory editing in HEX/ASCII format.
 - **NAMES** - Lists the names and socket numbers of all resident ROMs.
 - **RAM** - Sends command directly to the RAM based ROM routine.
 - **REMOVE** - Removes RAM based ROM option.
 - **SPECIFY** - Selects the default ROM.
 - **DEFAULT** - Sends commands directly to the default ROM without having to give its name.
 - **STOP and START** - Disable and enable any named ROM to completely eliminate command word clashes.
 - **STATUS** - Information about all the ROMs fitted in the machine including socket number, name, length, whether it is enabled, whether it has service or language entries etc.
 - **VALUES** - Gives ROM MANAGER status information, such as its socket number, how many ROMs have higher priority, number of default ROM and the identity of the current filing system.
 - **VECTOR** - Same as *DIRECT, just in case *DIRECT clashes with another ROM.
- All selection between particular ROMs is by the name of the ROM and this may be abbreviated for convenience. ROM numbers can also be used if required. This ROM is very simple and obvious to use. All the facilities are explained in the clear and detailed manual.

Price £22

BEEB MON

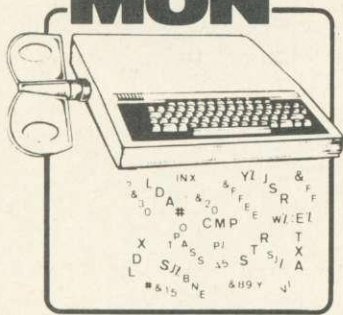

Watford's own Machine code Monitor ROM written by Andrew Bray (Cambridge), co-author of the BBC Micro Advance User Guide.

The most powerful and versatile machine code monitor ROM yet written for BBC Micro. It has all the normal memory editing, moving and relocating facilities, plus all editing is with a full screen editor allowing scrolling up and down memory, entering in Hex, ASCII or standard assembler mnemonics.

In use as a debugging tool, you run code under a total emulation system. Everfelt a desperate urge to set a breakpoint in ROM? No problem - you can even have breakpoint on reading or writing locations in memory and on register contents. The system fully supports debugging of sideways ROMs e.g. BASIC can fully and easily be run from within Beebmon and from there DFS and other sideways ROMs can be used in total emulation mode. Beebmon can even run itself. In so doing you can nest Beebmon up to a level limited only by the memory size. Beebmon uses 256 bytes of workspace, located anywhere in memory, even on the 1MHz Bus. Beebmon effectively uses no zero page workspace, so your program (e.g. BASIC) can use any or all of the base page. How does it achieve this? By providing a 6502 interpreter all programs running under it exist in a virtual BBC, so special memory locations like the ROM latch are not actually accessed by your programs, instead they alter a location in Beebmon's workspace. Emulation also allows immediate return to Beebmon command level by ctrl-escape no matter what code is being executed at the time. All this exceptional power and flexibility is complemented by a clear and detailed manual included in a value for money price of:

£22

Disassembler Rom



Discover the hidden secrets of BASIC and the OPERATING SYSTEM with this easy to use programmers tool.

A ROM based machine code Disassembler for the BBC micro. It enables machine code programs to be listed in BASIC/DUMP format and thus is the perfect complement to the built in assembler. It allows Sideways ROMs, files on disk or tape to be listed, and also has a comprehensive editor, allowing mnemonics to be altered directly, as well as HEX, DECIMAL, ASCII and BINARY memory editing. There is also a full set of labelling facilities available (up to 3,200 labels), with the major locations and routines already labelled.

Thus DIS-ASM enables any monitor program, such as BEEBMON to be used to much greater effect as it is not necessary to disassemble memory each time the display is altered.

ONLY £18

WATFORD - Always a step ahead

COMPUTER CONCEPT'S ROMS

CARETAKER Basic Utility	£28
Graphics ROM	£28
Disc Doctor ROM	£28

Wordwise

Without doubt a very sophisticated piece of software for the BBC Micro. It has all the features of a professional word processor yet is easy to use.

SPECIAL OFFER THIS MONTH: £32

BEEBFONT ROM

BEEBFONT is a remarkable and different concept in BBC software supplied on a 16K ROM. It allows you to display text on the screen in any of the following styles:

ABCDEFGHIJKLMNPO
 abcdefghijklmnop
 ABCDEFGHIJKLMNPO

ABCDEFGHIJKLMNPO
 abcdefghijklmnop
 ABCDEFGHIJKLMNPO

ABCDEFGHIJKLMNPO
 abcdefghijklmnop
 ABCDEFGHIJKLMNPO

ABCDEFGHIJKLMNPO
 abcdefghijklmnop
 ABCDEFGHIJKLMNPO

ABCDEFGHIJKLMNPO

It works in modes 0, 1, 2 and 4 using the full colour capabilities of each mode. Characters are printed in the same way as normal. Selection between the various fonts is very easily achieved with Ctrl-V - press this followed by a font number and the output will continue in the new font. Beebfont ROM is particularly useful in display work with the characters produced at twice the normal size.

You can create your own character fonts with the editor supplied. You can also print-out pre-formatted text files using the special characters with Epson FX, RX and NEC printers. The full range of character styles can be used, controlled from within the text. The editor and spooler program are supplied with the package, on cassette or disc. The spooler allows word processor (Wordwise & View) output to be printed in the new characters.

A twenty page manual is supplied. Please state printer type and media for the editor & spooler when ordering (cassette, 40 or 80 track disc).

ONLY £39

NEW LAUNCH

32K RAM EXPANSION BOARD

Now Watford Electronics brings you the latest state-of-the-art memory expansion board for your BBC microcomputer. This compact board which fits inside the computer does not just give you 16K or even 20K of extra RAM, but a massive 32K!!!

There are many useful facilities available with this board:

- The top 20K of the expansion RAM can be used as the screen display memory, leaving all the standard BBC RAM free for programs or data storage. This allows good graphics and long programs to be combined. For instance you could have MODE 0/1/2 GRAPHICS AND 28K OF PROGRAM SPACE. The extra memory can be used by virtually any language or utility such as BASIC, VIEW, WORDWISE, etc.

- The full 32K or the bottom 12K of the expansion RAM can be used as a buffer for the printer, sound channels, RS423, keyboard or speech synthesiser. This allows very long text files to be printed while you are using 27K of program and 20K of graphics!

- This board is the ideal complement to any word processing system. There is no need to wait for slow printers as you can type in long text in 80 column display mode while printing is going on - TWO JOBS DONE SIMULTANEOUSLY!!! (an equivalent printer buffer would cost you £115+).

- The board is compatible with a vast range of software and hardware available for the BBC microcomputer, including our ROM expansion board and double density DFS.

- The board is extremely easy to fit. It is supplied complete with a comprehensive manual and ROM based software with full *HELP messages.

SPECIAL INTRODUCTORY OFFER

Only: £69 (carr. £1)

GRAPH PAD

With this popular British Micro's Graph-pad, you can add new dimension to your computer enjoyment. It helps you to create your own application programs by the simple use of the Graphpad. Ideal for Educational use. Supplied complete with Cables, Manual and a two program cassette.

Price: £115

SURGE PROTECTOR Plug

Fitted in place of your normal mains plug, this device protects your equipment against mains surges. Nearby lightning strikes, thermostats switching and many other sources put high voltage transient spikes on to the mains. This can lead to data corruption in memory and on disc and can result in spuriously crashing machines. Suitable for computers, Hi-Fi, Fridge Freezers etc. Max. Surge current 2Kamp; max. Voltage 250. Essential for serious computer users.

Protection for only £8.50

WATFORD ELECTRONICS

Continued →

DOUBLE DENSITY DISC INTERFACE

We are proud to announce the launch of the Watford Electronics Double Density Board for the BBC micro. The DDFS supplied is a new version of the popular Watford Electronics DFS re-written to make full use of the capabilities of the new double density controller.

- Storage is increased by the maximum physically possible, 80%.
- Our system will use the whole of an 80 track drive. Inferior systems do not allow files longer than &3FFF bytes, but with our system files can be as long as one disc side.
- Discs may be created in either single or double density format with the built in formatter and in single density mode are fully compatible with normal Acorn format discs.
- The density of the disc you put in is automatically sensed by the system and you are informed of the density in the catalogue display.
- The double density system is of course faster than single density.

Worried about compatibility with single density discs? Don't. The Watford Electronics DDFS implements an extremely comprehensive 8271 emulator so that commands passed through OSWORD & 7F are correctly interpreted. Other manufacturers thought that read and write sector alone were sufficient - we decided to implement every command of the 8271 that was physically possible. We have allowed the use of all the special registers including bad tracks, allowed access to deleted data etc., etc. The emulator itself takes up around 1K of compactly written machine code. We reckon it will run the vast majority of protected discs now available. Gain all the advantages of the WE DFS together with much increased storage and compatibility with existing protected discs. The price is the same as for the standard single density system that we continue to sell so you can choose between the two options without financial worries.

NEW LAUNCH

SIDEWAYS ZIF

External sideways ROM socket

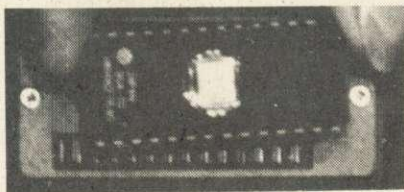

At Watford we haven't forgotten those of you with small budgets, so we've produced a ROM board which takes only one ROM! But don't stop reading - this ROM can be changed in under five seconds without taking the case apart. The SIDEWAYS ZIF eliminates the possibility of damage to your ROMs as zero insertion or extraction force is required when changing ROMs.

Included in the SIDEWAYS ZIF package is a specially designed see through storage container for your ROMs which protects them from mechanical and static damage when not in use. Consider the features:

- Very simple to install, no soldering or modifications to the BBC Micro are required.
- Uses a professional ZERO INSERTION FORCE SOCKET (ZIF) so no force is required changing a ROM.
- No further expense, ROMs are used as supplied without expensive specialised cartridges. The storage box included stores up to 12 ROMs in perfect safety.
- Fits neatly into the existing cartridge slot on the lefthand side of the BBC Micro keyboard.
- The low profile design of the socket gives unrestricted access to the keyboard, unlike other cartridge systems.
- Allows easy installation and changing of Sideways ROMs, all without dismantling your BBC Micro. Once locked in position in the ZIF socket the ROM behaves as a normal sideways ROM.
- No more problems of running out of socket space, simply unplug the ROM and plug a different one in!

A REAL MUST FOR PROFESSIONALS AND HOBBYISTS ALIKE
ONLY £16

BOOKS (No VAT on Books)

30 Programs - BBC Micro	£3.25
30 Hour BASIC (BBC Micro)	£6.95
35 Education Programs for BBC	£6.95
36 Challenging Games for BBC	£5.95
40 Educational Programs for BBC	£5.95
100 Programs for BBC Micro	£6.95
Cassette version of above	£10.00
6502 Application Book	£11.95
6502 Assembly Language Program ..	£13.95
6502 Assembly Language Subroutines	£14.25
6502 Machine Code for Beginners	£5.95
6502 Software Design	£10.50
A young persons guide to BBC Basic ...	£4.50
Advanced Machine Code Technique for BBC	£7.95

Advanced User Guide for BBC Micro	£11.95
Advanced Graphics with BBC	£9.95
Advanced 6502 Interfacing	£10.95
Advanced 6502 Programming	£12.45
Assembly Language Programming on BBC Micro	£7.95
Advanced Programming Techniques for the BBC Micro	£7.95
BBC Basic	£7.95
Assembly Lang. Prog. on BBC	£7.40
BBC BASIC	£5.95
BBC Basic for Beginners	£6.95
BBC DIY Robotics & Sensors	£6.95
BBC Forth	£7.50
BBC Lisp	£7.50
BBC Micro An Expert Guide	£6.95
BBC Micro Book BASIC Sound & Graphics	£7.95
BBC Micro Graphics and Sound	£6.95
BBC Micro Programs in Basic	£5.95
BBC Micro ROM PAGING System Explained	£2.00
BBC Micro Revealed	£6.95
BBC Micro Assembly Lang. Prog.	£7.95
BBC Micro Disc Companion	£7.95
BBC Micro in Education	£6.50
Basic Programming on BBC Micro	£5.95
Best of PCW Software (BBC)	£5.95
CP/M Users Guide	£13.95
Creating Adventure Programs on BBC Micros	£6.95
Creative Graphics Cassette (Acornsoft). Has 36 graphics programs	£8.95
Creative graphics on BBC Micro	£7.50
Complete Programmer for BBC	£5.95

DISC FILING SYSTEM (DFS) Operating Manual for BBC	£6.95
Discover BBC Machine Code	£6.95
Discover FORTH	£13.95
DIY Robotics & Sensors with BBC	£6.95
Further Prog. for BBC Micro	£5.95
FORTH Programming	£14.40
Functional Forth for the BBC Micro	£5.95
Games on your BBC Micro	£2.95
Games BBC Computer Can Play	£6.95
Graphs & Charts on BBC Micro	£7.50
Graphic Art for BBC Computer	£5.95
Graphs and Charts (Cassette)	£7.50
Graphics on BBC Micro	£6.95
Hobbit (Book and Cassette)	£14.95
Introducing the BBC Micro	£5.95
Introduction to FORTH	£9.30
Intro to Micro Beginners Book (3 Ed.)	£9.90
Let your BBC teach u to program	£6.45
LISP	£9.25
Logo Programming	£8.95
Mastering VISICALC	£12.45
Mastering CP/M	£13.65
Micros in the Classroom	£4.90
Programming the 6502	£11.95
Programming & Interfacing 6502	£16.00
Programming the BBC Micro	£6.95
PASCAL	£9.25
Programming for Education on BBC ..	£5.95
Structured Prog. with BBC BASIC	£6.50
The Complete FORTH	£6.95
The BBC Micro Book, BASIC, SOUND & GRAPHICS	£7.40
Using Floppy Discs with BBC Micro	£5.95
Using BBC Basic	£6.95
Using 6502 Ass. Language	£14.50
Wordstar & CP/M made easy	£6.95

PLINTHS FOR BBC MICRO AND PRINTERS

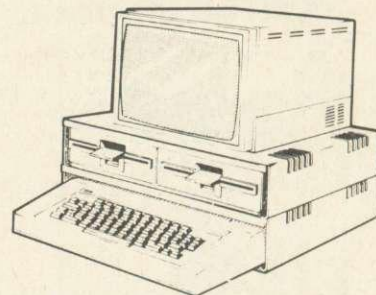

Protect your computer from the weight and heat of your monitor. BBC micro plinths have slots for maximum ventilation. Single height version is suitable for BBC and monitor. Double height version allows the disc drives to be used in the centre section or stationary, etc. The computer slides easily in to place, allowing easy access to remove the lid.

The printer plinth is equally sturdy but without the cooling slots. This allows the paper to be stacked under the plinth with the printer on top - a very convenient way to work as it does not require the usual very deep table.

SINGLE BBC PLINTH	£11 (carr. £1.50)
DOUBLE BBC PLINTH	£20 (carr. £2.00)
PRINTER PLINTH	10 (carr. £1.50)

4 WAY MAINS DISTRIBUTION SOCKET

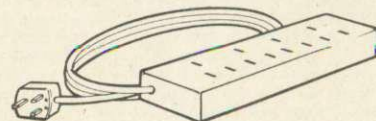

4 way top quality mains trailing sockets. Supplied wired up with mains plug ready for use. Can be screwed to floor or wall if required. Very useful for tidying up all the mains leads from your peripherals. Allows the whole system to be switched on from one plug.

£9.50

ASSORTED CONNECTING LEADS

(All ready made and tested)

CASSETTE LEADS 7 pin DIN Plug to 5 pin DIN Plug + 1 Jack Plug	£2.00
to 3 pin DIN Plug + 1 Jack Plug	£2.00
to 7 pin DIN Plug	£2.50
to 3 Jack Plugs	£2.00
6 pin DIN to 6 pin DIN Plug (RGB)	£2.50
MONITORLEADS	
Microvitec RGB leads 6 pin DIN to 6 pin DIN for colour monitors	£2.50
KAGA/SANYO Colour Monitor Leads Monochrome monitor leads	£5.00
BN Cto Phone	£3.00
DISC DRIVE POWER LEADS	
Supply from BBC power supply to standard Disc Drive connector. Single	£3.00
Dual	£3.75

MISCELLANEOUS CONNECTORS

	Plugs	Sockets
RGB (6 PIN DIN)	30p	45p
RS423 (5 pin Domino)	40p	50p
Cassette (7 pin DIN)	25p	65p
ECONET (5 pin DIN)	20p	30p
Paddles (15 pin 'D')	110p	215p
BBC Power Plug 6 way	80p	-
Disc Drive Plug 4 way	75p	-

ATTACHE CARRYING CASE for BBC Micro

The Attache carrying case is attractively finished in mottled antique brown leatherette. The case is made of tough plywood, providing a very solid and safe way to carry your BBC micro. There is room provided to fit all the leads necessary behind the computer and manuals in the front. Locks supplied with two keys. Price £12 (£2 carr.)

VOLTMACE DELTA 14 JOYSTICK SYSTEM

The Voltmace system provides full facilities for connecting the Delta 14 handset.
Delta 14 handset - On its own makes a high quality centre sprung analogue joystick with fire buttons **£12.50**
Adaptor Module allows use of two joysticks and provides hardware to access all the keys on the keypad of the joystick **£12.55**
Transfer program allows use of the keypad keys and joystick to simulate any key on the keyboard. This works by creating a machine code patch that stays in memory while another program is loaded in. Allows any game to be used with joysticks. Supplied on disc or tape.

Tape **£5.10**
Disc **£7.95**

STANDARD JOYSTICKS

These are standard analogue type with a fire button on each joystick. Twin joysticks go to a single moulded plug, long leads provided.

Single Player version **£7.00**
Two Players version **£12.00**

GAMES SOFTWARE

ADVENTURE QUEST (L.9)	£8.50
COLOSSAL ADVENTURE (L.9)	£8.65
CHESS	£6.95
CHUCKIE EGG	£7.90
CRAWLER (WESOFI)	£5.00
CROACKER	£6.95
DUNGEON ADVENTURE (L.9)	£8.50
Escape from MOONBASE ALPHA	£6.95
FELIX in the FACTORY	£6.95
GALACTIC COMMANDER	£6.95
KILLER GORILLA	£6.95
MUNCHYMAN	£5.95
MOONRAIDER	£6.95
MUSIC SYNTHESISER	£8.25
PENGO (Watford)	£5.95
SNOWBALL (L.9)	£8.50
SWOOP	£6.95
Twin Kingdom Valley	£8.25
747 FLIGHT SIMULATOR	£7.75

CRAWLER

A new challenge for your reflexes from Watford Electronics. Crawler is the best yet implementation on the BBC micro of the arcade game 'Centipede'. Blast the voracious caterpillar before it eats you, while avoiding the wandering spiders. Passing scorpions poison the mushrooms causing the caterpillar to fall straight on to you. Falling fleas also induce massive mushroom growth. This game is fast and fluent to play, suitable for all skill levels. The control system is cleverly arranged to give high speed movement AND precise control of position.

A SUPERB GAME FOR ONLY **£5**

LEVEL 9 ADVENTURES

Level 9 have the highest reputation for their adventure range. Each one is in itself a challenge that could take you months to crack. All feature the ability to save your current position on tape. These adventures understand many words and have vast numbers of rooms.

COLOSSAL ADVENTURE - The classic adventure as provided on most mainframe computers. Has all the original puzzles with 70 extrarooms. **£8.65**

ADVENTURE QUEST - Through forest, mountains, desert, caves, water, fire, moorland and swamp fight an epic quest against tyranny. **£8.50**

DUNGEON ADVENTURE - Cover 100 puzzles in the Demon Lord's dungeon. **£8.50**

SNOWBALL - Science Fiction adventure set in 2302 AD. Save a colony starship full of frozen people. 7,000 locations must make this the biggest adventure on the BBC micro. Has robots, flashing control panels, etc. etc. Really good fun! **£8.50**

SPECIAL OFFER

HITACHI EPROMs for BBC

2764(8K) **£4.95**
27128(16K) **£19**

HITACHI RAMs for BBC

6116L(2K) **£4.25**
6264L(8K) **£26**

MK 2 13 ROM SOCKET EXPANSION BOARD

Now all lines fully buffered - On board battery back-up facility - will now accept EPROMs 2716, 2732, 2764 & 27128 and ROMs 6116 & 6264.

Simply plugs into one of the four ROM sockets currently available in BBC Micro. There are only 5 solder connections to be made. Full

instructions are supplied. This board has been ergonomically designed to enable the user, easy further expansion inside the Micro, e.g. Double Density Board, Torch Board, etc. (At Watford, we think ahead.)

Our Mk2 13 ROM Socket Board enables the User to increase the sideways ROM capacity from the basic 4 sockets upto full 16 capable of being supported by current operating systems. In addition the board is designed with the facility to hold upto 16K RAM, which when switched into operation is automatically selected by any WRITE signal to the Sideways ROM area. This gives the User the ability to write a utility or language and upon pressing break have the utility or language up and running (new ROM software can be developed and tested in situ.)

The Board gives the User, plenty of freedom to explore the possibilities of the new paged ROMs due in the coming months and offers them the chance to develop their own.

All lines are fully buffered and the Board meets or exceeds all timings for operation in the BBC Microcomputer. When fully populated, the ROM Board consumes less than half the recommended maximum current limit.

Supplied ready-built and tested complete with fitting instructions.

ONLY £32.50 (carr. £1)

THE INVESTIGATOR

A utility program provided on disc to make security backup copies of all your valuable discs.

Makes full use of all 8271 facilities to discover the precise format of your protected disc so that an exact copy can be produced. Supplied with detailed instructions. Please specify 40 or 80 track disc when ordering.

Price **£25**

Prices subject to change without notice and availability.

MAIL ORDER AND RETAIL SHOP. TRADE AND EXPORT INQUIRIES WELCOME. GOVERNMENT AND EDUCATIONAL ESTABLISHMENTS OFFICIAL ORDERS ACCEPTED. CARRIAGE: Unless stated otherwise, please add 75p to all cash orders.

VAT: UK customers please add 15% VAT to the total cost incl. Carriage.

SHOP HOURS: 9.00am to 6.00pm. Monday to Saturday. (Ample Free Car Parking Spaces) ACCESS ORDERS: Simply phone: Watford (0923) 50234. (24 Hours)

LIGHT PEN



This Light Pen for the BBC micro is packaged in a neat pen shape with built in switch. Supplied complete with our sophisticated Pen-Pal software on cassette (see elsewhere in this ad).

Only **£20**

(For software on disc please add £2)

DATA RECORDER AND ACCESSORIES

Top quality slimline portable cassette recorder designed specifically for use with home computers. Mains/Battery operated with tape counter.

£24

DATA CABLE to connect recorder to BBC **£2.50**

DATA CASSETTES - Top grade tested C12 Data cassettes supplied in library cases **35p**

MISCELLANEOUS

28 pin DIN PLUG	
Solder type	£1.85
IDC Crimp type	£2.90
28 pin ZIP SOCKET (Textool)	£7.50
34 way Ribbon Cable	£0.60/foot
8 way DIP SWITCH	£0.87

ANTI GLARE MONITOR SAFETY SCREEN

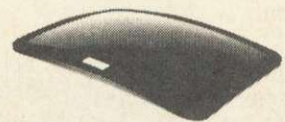

HEADACHES? TIRED EYES? Don't take pills - Use a Watford Electronics anti-glare filter! Considerable research into the possible health problems associated with monitor screens has shown that eye strain, blurred vision, watering, itching eyes and headaches can result after prolonged use. The problems are caused by extraneous reflections which force the eye to continuously re-focus to try to ignore them. The answer is our contrast enhancement, anti-glare filter which is similar to those which have been previously available on business systems, but at the low cost that you would expect for your personal computer. You will soon find the reduction in eye strain well worth your investment.

Features:

- Simple fitting with sticky Velcro pads.
 - Easily removed for cleaning.
 - Tinting improves colour quality and contrast.
 - Works on monochrome or colour monitors.
 - Curved instead of usual flat screen reduces edge distortion.
 - Made in Britain by a long established glass maker.
- Available in 12" or 14" versions - please specify when ordering.

Introductory offer price: **£14.95 (carr. £1)**



Watford Electronics

Dept. ACORN, Cardiff Road, Watford, Herts, England.
Telephone: 0923 40588/37774. Telex: 8956095

NOW IT'S IN THE CAN

Your graphics program comes to life – and death – as Tessie Revivis sets up the roving fly for the kill

46

LAST month in First Byte we used an asterisk to represent a moving fly in a simple buzzing game. Now we'll make our fly a little more realistic and put some action into the game by introducing a can of lethal fly spray.

The Electron has its own designing command, which allows the user to program a shape into a character so that it can be printed onto the screen in much the same way as our common or garden asterisk. The command is VDU23. But first we must design our fly.

To do this we use a sheet of paper marked into squares eight wide by eight deep. A suitable character planning sheet can be found on page 287 of the *Electron User Guide* (page 496 in the *Beeb User Guide*). The character itself is designed by filling in suitably positioned squares. Figure 1 shows my own effort at designing the fly – I hope you see some resemblance.

Once the character has been

designed it has to be converted into a form that the Electron can understand; as it's a computer that means numbers. If you study figure 1 you'll see that each column is assigned a value, termed its 'weight', starting with 1 on the right and then doubling as you move left along the columns. To convert the character into a computer-recognisable form each 'row' is turned into a numeric value by adding the weight of each column that contains a coloured square.

This process is shown in the figures to the right of the diagram, but just to make sure it is clear in your mind let's consider the top row. If we think of a clear square as a 0 and a coloured square as a 1 the top row can be represented as 00100100. The ones are often referred to as bits, so we can say that the two 'set' bits are in the 32 and 4 column. Adding these two together gives 36, thus the computer representation of

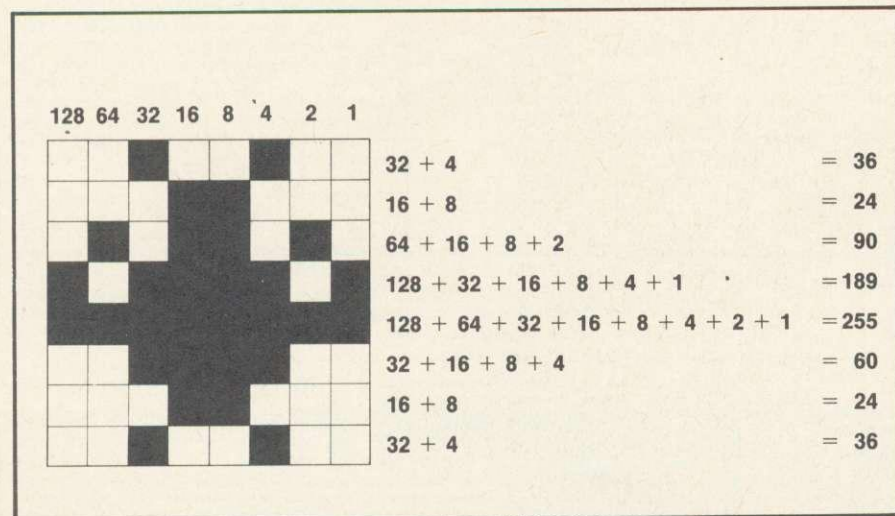
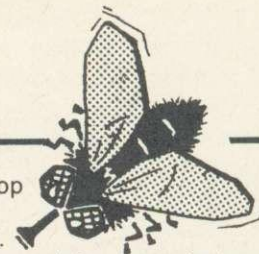

Figure 1. The fly is drawn on an 8x8 grid, each column of which is given a 'weight' (top row of figures). Each row is given a numeric value by adding the weights of each filled square (right-hand column) and a series of figures is produced that the computer can interpret.



the top row of the fly character is 36. Each of the remaining rows is treated in the same way, the net result being eight numbers.

Before working these eight values into the VDU23 statement we must decide which of the user-definable characters we wish to use to represent the fly. The basic set of user-definable characters are the ASCII characters 224 through to 255, so we can use any of these. Let's use the first ASCII character 224. Constructing the VDU23 statement is simple enough. It must be followed by the character code and then the eight definition values starting with the top one, each being separated by a comma. So the final statement looks like this:

```
VDU23,224,36,24,90,189,255,60,24,36
```

A simple two-line program shows how the fly can be printed onto a mode 4 graphics screen:

```
10 MODE 4
20 PRINT TAB (10,10); CHR$224
```

As the fly forms part of the ASCII character set it can be printed on the screen using the CHR\$ function, as illustrated in line 20 above.

Designing a fly spray can proceed in much the same way. The can will obviously need to be much larger than the fly but, as we have seen, the VDU23 command allows only set-sized characters. This can be overcome simply by using several character definitions together. For example, if we plan to start the fly spray can at character 225 and make it two characters wide



by three deep its layout might look like figure 2. The design of the spray can is done in sections and the complete picture produced by printing the correct sequence of characters using the PRINT TAB commands.

Figure 3 shows the top of the can designed across two character planning sheets. Calculating the numeric value is done as described above for each planning sheet. The complete definition need be only four VDU23 commands in length as the second and third rows can be identical, unless you fancy adding a base to the can or something extra that would make the third set of characters different.

The following short program illustrates how the can can be printed on the right-hand side of the screen.

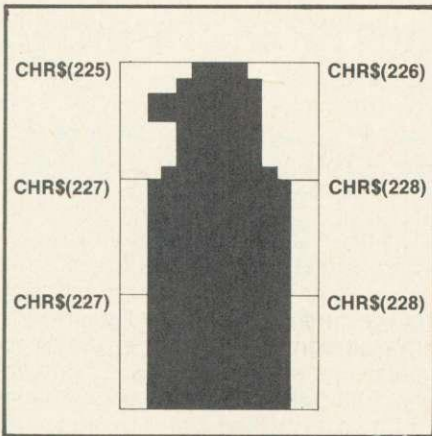
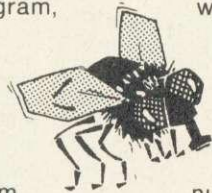

Figure 2. The fly spray can, being much bigger, cannot be represented on one 8 x 8 grid so it assembled from six 'characters'.

two stages: moving the fly to and fro across the screen and moving the spray can up and down the right-hand side of the screen. Moving the fly across the screen was discussed last month and indeed there are few changes from that section of the program, PROCfly. However, rather than moving the fly along a straight path an extra line (line 105) has been inserted into the procedure that will cause the fly to move up and down slightly as it proceeds across the screen. This is produced by adding a random number generating command to determine the Y tab position within a set range. The command is RND and this is followed by a value, 7 in the program, which causes



a random number in the range 1 to 7 to be 'found'. As we do not wish the fly to move too near the top of the screen 2 is added to this value, thus ensuring a random value in the range 3 to 10.

Creating movement with the fly spray can is done in much the same way except that movement is on the Y axis. Two keys are used by PROCfly to see if this is required, the up arrow to move the can up, and the down arrow to move it down. Normally these two keys will not return a value when tested with the INKEY\$ command, however, you can force them to return ASCII values by first turning them on using a *FX4, 1

command (line 505 in PROCsetup). The ASCII codes produced by these two keys are 138 and 139 and these are tested for by lines 140 and 145 in PROCfly. If either is detected the appropriate can-moving procedure is called.

To swat the fly it must be sprayed with a cloud of the killer potion. Once the can has been moved into position the space bar will press the top, the fly will freeze in fright as the spray cloud is propelled across the screen. If the fly is in the line of fire then it crashes to the floor with a thud - otherwise it lives to fight another day.

To see just how good you are a record of the number of sprays you use is kept at the bottom of the screen.

For the main listing, which is fully annotated, turn to yellow page 97. Study this and refer to your *User Guide* to find out more on the commands being used in each section. Then you might feel up to adding a couple more flies and perhaps even a mobile strip of fly paper.

If you think your fly program is better than mine send it in to *Acorn User*. We'll pay £20 for the best fly game we publish.



The annotated 'Flies 2' program is listed on yellow pages 97/98

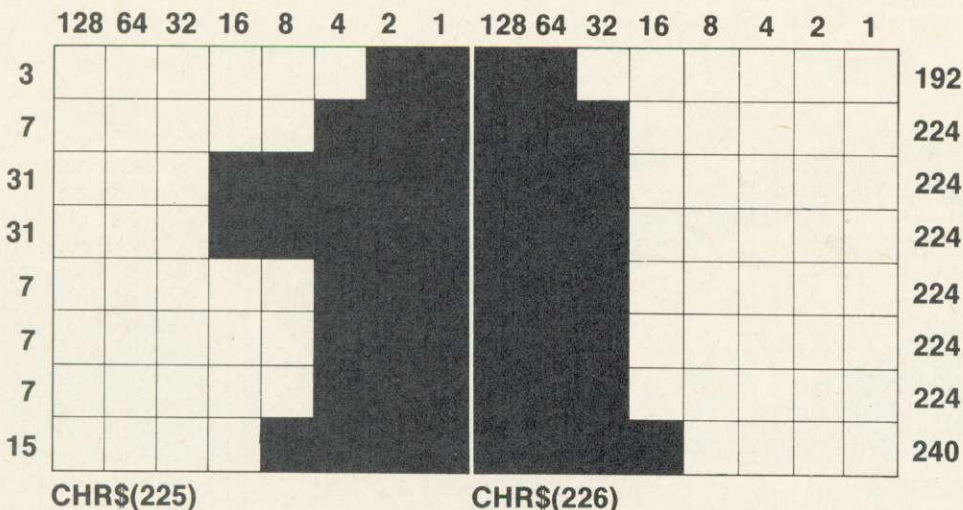

Figure 3. Detail of the can showing the top put together from two adjacent characters

PRINTERS

DOT MATRIX

All printers have centronic parallel interface unless otherwise stated. All printers have hi res dot addressable graphic mode. Please send SAE for full details.

EPSON

FX80 160CPS 10" wide friction & pin feed	£324 + VAT	£373
FX100 160 CPS 15" wide friction & tractor feed	£499 + VAT	£574
RX80 F/T 100 CPS 10" wide friction & tractor feed	£239 + VAT	£275
RX80 F/T 100 CPS 10" wide tractor feed	£199 + VAT	£229
RX100 F/T 100 CPS friction & tractor feed	£385 + VAT	£443
8143 RS 23 Interface for FX and RX printers	£39 + VAT	£45
8148 RS 232 Interface with 2K buffer x on x off	£60 + VAT	£69
Ribbon Cartridge for RX80 FX80 & MX80	£5 + VAT	£6
Ribbon Cartridge for FX100 & MX100	£7 + VAT	£8

STAR

Gemini 10X120 CPS 10" wide friction & tractor feed	£200 + VAT	£229
Gemini 15X120 CPS 15" wide friction & tractor feed	£295 + VAT	£339
Gemini Ribbon	£3 + VAT	£3

SEIKOSHA

BP 420 designed for the business world, 420CPS in draft mode, 110CPS in NLQ mode.	£1095 + VAT	£1259
---	-------------	-------

SMITH CORONA

Fastext 80: 80 col, 80CPS. Friction feed standard
£149 + VAT £171

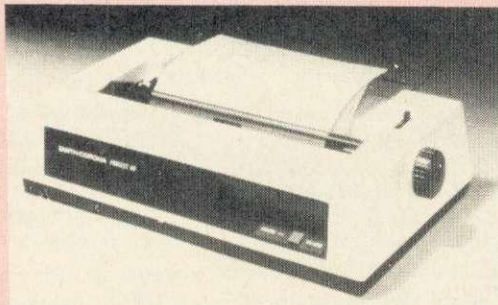

ENSIGN

1650 Standard, Correspondance and Graphics Modes; friction and tractor feed; 165 CPS; bi-directional logic seeking	£269 + VAT	£309
--	------------	------

TAXAN KAGA

160CPS 10" wide 27CPS NLQ 24 x 16 matrix	£259 + VAT	£298
160CPS 15" wide 27CPS NLQ 24 x 16 matrix	£349 + VAT	£401

COLOUR PRINTERS

Seikosha GP700A 7 colour 50CPS printer	£347 + VAT	£399
Canon PJ1080A 7 colour 40CPS ink jot printer	£391 + VAT	£449

All our printers have 1 year warranty

DAISYWHEEL

JUKI 6100/I PRINT

20 CPS Bi-Directional Logic seeking 10 12 15 CP1 + PS spacing 2K buffer best selling Daisywheel	£299 + VAT	£344
Singer sheet feeder unit	£217 + VAT	£249
Tractor Unit	£95 + VAT	£109
RS 232 Interface	£52 + VAT	£59
Spare Daisywheel	£14 + VAT	£16



BROTHER HR-15

13 CPS Bi-directional 10, 12, 15 CP1 + PS Keyboard Unit	£344 + VAT	£395
Single Sheet Feeder Unit	£139 + VAT	£159
Tractor Unit	£217 + VAT	£249
	£95 + VAT	£109

QUENDATA

20 CPS Unidirectional 10 12 15 CP1	£217 + VAT	£250
------------------------------------	------------	------

ACORN F

BBC MICROCOMPUTER SYSTEM

WE ARE AN OFFICIAL BBC COMPUTER DISTRIBUTOR

DEALER ENQUIRIES ARE WELCOMED

Acorn Electron £199 INC VAT

Free Cassette Recorder with every Electron

BBC is the best microcomputer currently on the market 32K RAM 32K ROM 8 modes of operation full colour full-size keyboard internal expansions such as disc interface speech synthesizer Econet interface — in short it is a personal computer capable of expanding into a small business system.

APPROVED ECONET SERVICE CENTRE

WE STOCK A LARGE RANGE OF SOFTWARE FOR BBC MICRO INCLUDING ACORNSOFT, BBC SOFTWARE, LONGMANS SOFTWARE, PLEASE SEND LARGE STAMPED ADDRESSED ENVELOPE FOR FULL DETAILS.



COMPUTER GROUP

28/29 BURNT MILL HARLOW, ESSEX CM20 2HU U.K.
Tel. HARLOW (0279) 443521 Telex: 818894 AKHTER G

DISC D

100% BBC COMPATIBLE MITSUBISHI AND TEAC SLIMLINE DISK DRIVES

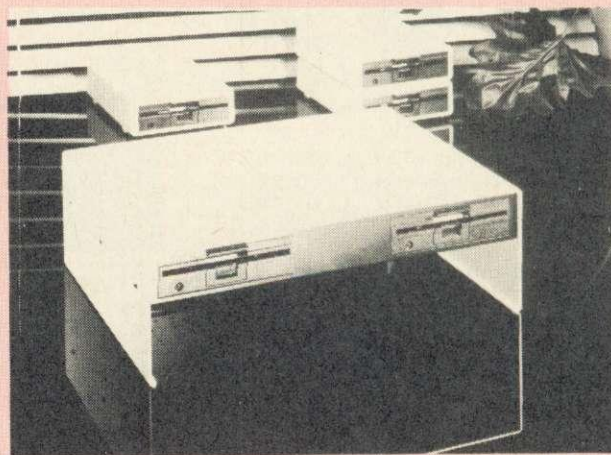

These drives are supplied ready cased with all the necessary cables formatting program and User Guide There are some very useful utilities included on formatting disc e.g.

- * DISASSEMBLER: This is 6502 machine code disassembler
- * DUP: To copy and rename a file on disc
- * FORMAT: Formatting program for 40 & 80 tracks

PRODUCTS

BBC Microcomputer Model B	£348	+ VAT	£399
BBC Mod B - disk interface	£409	+ VAT	£469
BBC Mod B - Econet interface	£389	+ VAT	£447
BBC Mod B - disk and Econet interfaces	£450	+ VAT	£517
BBC Compatible 100K disk drive	£86	+ VAT	£99
BBC Compatible dual 800K disk drive	£312	+ VAT	£359
Acorn Z80	£260	+ VAT	£299
Acorn 6502 Second Processor	£173	+ VAT	£199
Acorn Bit stick	£327	+ VAT	£375
Acorn IEE Interface	£282	+ VAT	£325
Acorn Electron plus 1 interface	£52	+ VAT	£60
BBC Prestel Adaptor	£115	+ VAT	£132
BBC Telex receiver (Aug)	£196	+ VAT	£225
BBC cassette recorder and lead	£35	+ VAT	£40
Disk interface kit (free fitting)	£84	+ VAT	£96
Mod A to Mod B upgrade kit	£70	+ VAT	£80
Fitting charge for A to B upgrade kit	£20	+ VAT	£23
16K memory upgrade kit	£30	+ VAT	£34
Games paddles	£11	+ VAT	£12
User Guide	£10		
Advanced User Guide	£12.95		
Econet Guide	£7.50		
Econet interface (free fitting)	£60	+ VAT	£69
Speech interface (free fitting)	£47	+ VAT	£54
BBC disk manual - formatting disk	£30	+ VAT	£34
Parallel printer cable	£10	+ VAT	£11
BBC word processor (view)	£52	+ VAT	£59
BBC Fourth language cassette	£15	+ VAT	£17
BBC Lisp language cassette	£15	+ VAT	£17

YOUR CONTACT AT AKHTER Tel: 0279 443521 (12 lines)

DEALER/BULK ENQUIRIES	HAMAYUN MUGHAL	EXT 202
TELEPHONE ORDERS	CARON ANDREWS	214
DEALER ORDERS	JULIA ALLUM	209
BUSINESS SYSTEM ENQUIRIES	TONY GLOVER	208
EXPORT ENQUIRIES	MOHAMAD EDIB	201
TECHNICAL SUPPORT	ALAN LAFFOLEY	207
ACCOUNTS	JULIE AMBLER	210
LITERATURE REQUEST	JOHN MAULE	215

ORDERING INFORMATION

We accept official orders from UK Government and Education establishments. Carriage is £2.50 + VAT (UK only) for normal delivery. If express delivery is required please add £8.00 + VAT per parcel. We accept telephone orders on Barclay and Access card please ring (0279) 443521 (10 lines). All cheques made payable to "AKHTER INSTRUMENTS".



N.B. All prices are subject to change without notice and are rounded up to the nearest pound

OPENING HOURS: MON-FRI 9am-6.30pm, SAT 10am-5pm.
We welcome callers, no parking problems.

C DRIVES

- * FREE: This utility provides a disk usage analysis
- * MDUMP: Enables you to display and modify any part of BBC memory
- * MERGE: Merge a number of text files into one file
- * RELOCATE: Downloads a basic program to &E00
- * SDUMP: Screen dump for EPSON in all graphic modes
- * VERIFY: Verifies every sector on a disk
- * MENU: A flexible menu program

Single drive 100K 40 trks single sided	£86	+ VAT	£99
Dual drive 200K 40 trks single sided	£164	+ VAT	£189
Single drive 200K 40 trks double sided	£138	+ VAT	£159
Dual drive 400K 40 trks double sided	£260	+ VAT	£299
Single drive 400K 80 trks double sided	£152	+ VAT	£175
Single drive 400K 40 80 trks switchable DS	£155	+ VAT	£179
Dual drive 800K 80 trks double sided	£303	+ VAT	£349
Dual drive 800K 40 80 trks switchable DS	£312	+ VAT	£359
Dual Drive 800K 40 80 trks + PSU + built in monitor stand	£373	+ VAT	£429

All above drives are low power slimline (0.3 A typ at + 12v and 0.4 at + 5v per drive) Normally extra power supply is not required. The BBC Computer power supply is designed to drive to the low power drive (IT IS NOT DESIGNED TO DRIVE INTERNAL ROM BOARD)

40 Track SS DD diskettes (10 Box)	£18	+ VAT	£20
40 Track DS DD diskettes (10 Box)	£23	+ VAT	£26
80 Track SS DD diskettes (10 Box)	£28	+ VAT	£32
80 Track DS DD diskettes (10 Box)	£30	+ VAT	£34

ALL ABOVE DISKETTS ARE CERTIFIED EITHER MEMOREX OR DETALIFE

BUSINESS SYSTEMS

COMPLETE BUSINESS PACKAGE

This system is based on 16 Bit 8088 Processor 128K RAM, 2X730K Floppy Disc Drives, High Res Monitor, fast (160cps) Dot Matrix Printer, Wordstar Wordprocessor, Calcstar Spreadsheet Program, complete integrated Accounts package consisting of Sales Ledger, Purchase Ledger, Nominal Ledger, Invoicing, Stock Control, Payroll and Pro-mail. Complete turnkey system at an unbelievable price.

Delivered Only
Delivered and Installed plus 1/2 day training

£1495 + VAT £1719
£1595 + VAT £1834

APRICOT PC

"Portable Executive Computer" 16 Bit Micro. 256K RAM up to 1.44 megabytes floppy disk storage. 3 1/2" Sony disks. Portable brief case styling. Modem with auto dialler (optional) hard disk optional. vast software library (compatible with Sirius 1).

Apricot with Double Drive, Monitor and Free Printer £1790 + VAT £2059

APRICOT XI

As above but with 10MB Winchester Drive and Single 315K Drive plus Superwriter. Supercalc and FREE JUKI 6100 Printer

£2995 + VAT £3444



SANYO PROFESSIONAL COMPUTER

SANYO 550

16 Bit Micro 128K RAM expandable to 256K. Single or Double Disk drive built in full colour graphics (640 x 200 pixels in 8 colours) IBM compatible. Free software. Sanyo MBC 550 128K RAM single drive and free software including Wordstar and Calcstar

£749 + VAT £862

SANYO 550-2

As 550 but with Dual Drive 2 x 160K

£849 + VAT £976

SANYO 550-360

As 550 but with 2 x 360K Drives

£999 + VAT £1149

SANYO 550-730

As 550 but with 2 x 730K Drives

£1049 + VAT £1206

SANYO 555

Sanyo MBC555 128K double drive and free software including Wordstar, Calcstar, Inforstar, Datastar etc

£999 + VAT £1149

SANYO 555-360

As 555 but with 2 x 360K Drives

£1249 + VAT £1436

SANYO 555-730

As 555 but with 2 x 730K Drives

£1299 + VAT £1494

SANYO SYSTEMS INCLUDE FREE HIGH RES GREEN MONITOR

WORD PROCESSING

COMPLETE SYSTEMS FROM £650 + VAT

BBC 1: BBC Micro Model B. View (or Wordwise) Wordprocessor. Quendata 20 CPS Daisywheel Printer. High Res Green Monitor. Cassette Recorder plus 10 cassettes and all the necessary cables £650 + VAT = £747.50

BBC 2: BBC Micro Model B + Disk Interface. View (or Wordwise) Wordprocessor. 100K Disk Drive. High Res Green Monitor. Quendata 20 CPS Daisywheel Printer. 1 Box of Disks and all the necessary cables. £799 + VAT = £803.35

BBC 3: Same as System BBC2 but with 400K Drive £875 + VAT = £1006.25

BBC 4: Same as System BBC 2 but with 400K Drive and JUKI 6100 Daisywheel Printer £975 + VAT = £1121.25

BBC 5: BBC Model B + Disk Interface. View (or Wordwise) Wordprocessor. 800K Dual Disk Drive (Mitsubishi). High Res Green Monitor. JUKI 6100 Daisywheel Printer. 1 Box (10) of 80 Track DS discs and all necessary cables £1145 + VAT = £1316.75.

If you require High Res Colour Monitor instead of High Res Green Monitor in Sanyo Systems please add £320 + VAT = £368 to the above prices.
*128K RAM Upgrade for all above Sanyo systems (makes a total of 256K RAM) £150 + VAT = £172.50 including fitting.

SAN 1: Sanyo MBC 550 Series 16 Bit Microcomputer. 128K Ram. Dual 160K drives (2 x 160K). High Res Graphics (600 x 200 pixels in 8 colours). JUKI 6100 Daisywheel Printer. High Res Green Monitor. 1 Box of 10 discs. Wordstar Wordprocessor. Calcstar spreadsheet and all the necessary cables £1175 + VAT = £1351.25

SAN 2: Same as SAN 1 but with Dual 360K Drives (2 x 360K) £1345 + VAT = £1546.75

SAN 3: Same as SAN 1 but with Dual 720K Drives £1395 + VAT = £1604.25

SAN 4: Sanyo MBC 555 Series 16 Bit Microcomputer. 128K Ram. Dual 160K Drives (2 x 160K). High Res Graphics (600 x 200 pixels in 8 colours) JUKI 6100 Daisywheel Printer. High Res Green Monitor. 1 Box of 10 discs. Wordstar. Wordprocessor. Calcstar spreadsheet. Mailmerge. Spellstar (dictionary). Datastar (database). Reportstar plus all the necessary cables. £1295 + VAT = £1489.25

SAN 5: Same as SAN 4 but with Dual 360K Drives £1475 + VAT = £1696.25

SAN 6: Same as SAN 4 but with Dual 730K Drives £1525 + VAT = £1753.75

MONITORS

PHILIPS

7001 High Res Green Screen with sound input £65 + VAT £75

GM1211

GM1211 18 MHZ High Res Monochrome Monitor with tilt and swivel stand available in green or amber etched antiglare screen (please specify colour) £86 + VAT £99
7001 High Res Green Screen with sound input £65 + VAT £75

SAMWOO

24MHZ High Res Monochrome etched antiglare green screen IBM/BBC Compatible £86 + VAT £99

SANYO

DM8112 12" Green screen 18MHZ Hi-Res £86 + VAT £99
DM2112 12" Green screen 15MHZ £66 + VAT £75

MICROVITEC CUB

1431 MS 14" RGB Normal Res Colour £173 + VAT £199
1451 MS 14" RGB Medium Res Colour £289 + VAT £332
1441 MS 14" RGB High Res Colour £417 + VAT £479

MICROVITEC FOR QL

1451 14" Medium Res Colour. Specially designed for Sinclair QL £239 + VAT £275

PERSONAL COMPUTER SOFTWARE
Proxima

Beeb-Text Features:
Width
Height
Italic

BIG Print
(c) Proxima Software
Very wide and tall text

THINK BIG*
A highly effective machine-code program for displaying any dimension text. Can be incorporated into other programs.

PIXEL PACKAGE*
Two programs are supplied for designing single colour and multi-colour characters and designs can be mirrored, inverted, rotated and duplicated. The programs even store the resulting data in program lines ready to be used.

TWO PLAYER GAMES*
Two 2-player Games including 4Line and Frustration, joystick compatible.

BEEB-TEXT
A sophisticated and unique machine-code program which allows virtually unlimited variation in the BBC's text display. The user has the option of varying character thickness, italic, character height, width, colour combinations, etc. Up to 8 different fonts can be displayed in one and including shadowed outlined types. Beeb-Text displays text in proportional spacing too however the user can also control, character and line spacing, independently.

Disc £15.00

▲Prices are fully inclusive, no extra to pay.
▲P&P on all orders is FREE!
▲Please make cheques/P.O.'s payable to PROXIMA SOFTWARE

DISC TOOLS The complete utility disc for twin 80 track drive users and includes a 40/80 or 40/40 or 80/40 backing up facility.
Disc £10.95

ROBRAIN Arcade fun. Disable the robot's positronic brain but watch out for its self defence.
Cassette £7.95
Disc £10.95

PROXIMA PERSONAL COMPUTER SOFTWARE, IGI10 1BT. Please specify 40 or 80 track or 3" types when ordering discs.

Our FREE program special offer continues. Contact us for details!



16 SOCKET ROM/RAM EXTENSION BOARD

Fully buffered the board offers the following features:

All 16 sockets may contain 8K or 16K roms.

Up to two pairs of sockets may be configured to accept 8K eproms to simulate a 16K eeprom without the expense of a 27128.

Up to 16K of CMOS RAM type 6116LP (made up of 8 2K ram chips) may be fitted to 8 of the available sockets leaving 8 free for roms.

or 2 8K Ram chips (6264) leaving 14 available sockets.

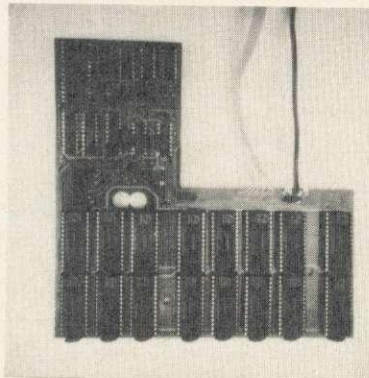

The advantage of sideways ram is twofold:

1. Programs can be assembled directly to hex 8000 and debugged before being committed to eeprom.
2. Programs intended for sideways roms may be stored on disc and downloaded into ram. Many more programs may be kept on disc allowing the extension board to be fitted only with roms that need to be resident.

This is a high quality PTH board and plugs into the extreme right hand rom socket. 4 wires to the paging register and one lead to the R/W line have to be connected.

Separate power leads for the board

are used to eliminate possible crashes that may occur due to trying to draw up to 650mA from a sideways rom socket.

Board fully assembled and tested complete with full installation and operating instructions.

Cost £34.50 + VAT, £1.00 P&P

HCR ELECTRONIC SERVICES
THE INDUSTRIAL UNIT, PARKER ROAD
CHELMSFORD, ESSEX CM2 6ES
Tel: Chelmsford (0245) 350188

EXTERNAL RAM/ROM CARD

THE NEW EXTERNAL 28 ROM EXPANSION SYSTEM FROM HCR ELECTRONICS

This extremely powerful but versatile machine has the capability of: 32K RAM & 24 sockets available for ROM or many various combinations to your personal requirements.

This machine has its own separate power supply which eliminates drain on the BBC's switched mode supply.

NO SOLDERING IS REQUIRED.

The unit consists of two modules:

1. An adaptor board to plug into the BBC sideways Rom socket 15.
2. The expansion case.

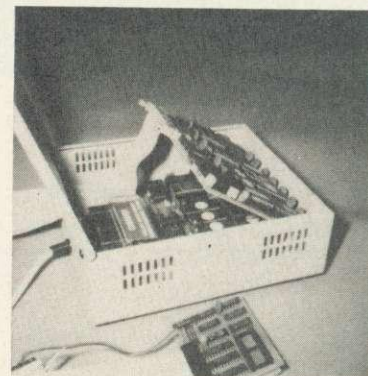

The case comes complete with an inbuilt power supply and one expansion card. This card will hold 12 Roms or a combination of Ram/Rom (Ram can be 6116's, 2016's or 6264's). This gives a total of 16 Roms (including four in machine).

A second board identical to the above can be fitted at a later date, giving a total capability of 28 available sockets for Rom or Ram.

The second board can be selected as an alternative to the first board, either by a switch on the case or via software control.

SOME ADVANTAGES

1. No soldering required.
2. No access into machine required after initial fitting.
3. No overheating problems.
4. Does not physically interfere with other internal expansion add-ons.
5. Built in power supply (does not overload BBC's supply).
6. Computer will still function with external box powered down or unplugged (using Roms resident in machine).
7. Will make available 32K Ram plus 24 Rom sockets at a varied combination to the customer's needs.

Cost unit complete with one board £70.00 + vat.
Second board £29.00 + vat. Postage & Packing £3.00





Dot and daisy

at the same time?

IS there any way of having a dot matrix printer and a daisywheel printer connected to a micro at the same time through the parallel printer port? This question was put to me by H L Malhotra of Radlett.

Indeed it is possible, and Keyzone of Unit 4, Regeneration House, School Road, Park Royal, London NW10 (tel: 01-965 1684/1804) makes a printer-changer designed to connect two or three printers to one micro. The device costs about £75.

Mr Malhotra would also like to know if his Watford disc filing system (DFS) will work with a second processor (6502 or Z80). New ROMs are provided with both second processors. For the 6502 second processor one is a new version of Basic and the second is a combined DFS and Econet Filing System (NFS). These two ROMs are installed in the BBC's sideways ROM sockets. The existing DFS needs to be removed and be replaced by the new one, but the new Basic ROM can be added without removing the existing Basic. For the Z80 a single new ROM is provided. This is the combined DFS and Econet ROM and the existing DFS needs to be removed.

Outmoded system

in operation

B J WOOLNOUGH, who lives in Jeddah, has an Acornsoft program that will not run on his BBC computer, although it runs perfectly well on another machine. On Mr Woolnough's micro the display 'freezes' after a short time and will not respond to the keyboard. It

Martin Phillips answers your queries on two-up printing, a 'freezing' screen, text and title display and the envelope statement

happens only with this program.

The problem, I suspect, is the operating system in his BBC. Many software houses are now producing software that will run only with the 1.2 operating system (1.2 OS). Early BBC machines were sold with a 0.1 OS, which had fewer features than the current one. If the software was designed to run with the 1.2 OS, it probably won't work correctly with the older 0.1 OS fitted. My advice to anyone still using an 0.1 OS is to return it to the Acorn dealer and have it replaced by the 1.2 OS. The cost is a little over £10.

To test which operating system is fitted, type *FX0 and press RETURN. A message will appear that will give the answer. A few of the first machines fitted with the disc or Econet filing systems were fitted with a 1.0 OS. This is almost the same as the 1.2 OS, but not quite, and if similar problems are experienced it would be worth getting it changed.

Text scrolling

in a window

THE following problem was encountered by Mr Macdonald of Stornaway when he was writing an index file for his cassettes.

He wanted mode 7; he wanted to reserve the top four lines to display a title; he wanted to reserve the bottom four lines for instructions; and he wanted the remaining lines to be used to display information and to be able to scroll without corrupting the title or the instructions.

It is useful to receive such an explicit request, and I'm sure this is a program that many will be able to put to good use. Mr Macdonald's requirements can be fulfilled by using a text window after printing the title and instructions. At the same time it is possible to alter the

background and foreground colours and incorporate other teletext codes to the left of the text window so that they will not be overwritten.

Listing 1 shows the technique. There are two procedures. PROCsetup contains the title strings and the four strings of instructions. PROCscreen is the procedure that performs the screen layout. Lines 180 to 220 set up the first four lines and print the title in double height. The background colour is blue (CHR\$132), and the foreground colour is cyan (CHR\$134). CHR\$157 changes the background colour, and CHR\$141 gives double-height printing. Line 200 adds extra spaces to the title to centre it.

Lines 230 to 250 similarly set the background colour to blue and the foreground colour to white for the middle

```

10 REM Listing 1
20 MODE7
30 PROCsetup
40 PROCscreen
50 END
60 :
70 DEFPROCsetup
80 DIM title$(1),instr$(3)
90 title$(0)="Title line 1"
100 title$(1)="Title line 2"
110 instr$(0)="1st line of
instructions."
120 instr$(1)="2nd line of
instructions."
130 instr$(2)="3rd line of
instructions."
140 instr$(3)="4th line of
instructions."
150 ENDPROC
160 :
170 DEFPROCscreen
180 FOR N=0 TO 3
190 PRINTCHR$132 CHR$157 CHR$141
CHR$134;
200 PRINTSPC(16-LEN(title$(N/2)
/2);
210 PRINTtitle$(N/2)
220 NEXT N
230 FOR N=0 TO 15
240 PRINTCHR$132 CHR$157 CHR$135
250 NEXT N
260 FOR N=0 TO 3
270 PRINTCHR$132 CHR$157 CHR$134;
280 PRINTinstr$(N);
290 IF N<3 PRINT
300 NEXT N
310 VDU28,3,19,39,4,14
320 ENDPROC
    
```

Listing 1. For the Beeb, text scrolling in a window, with title above and instructions below

IF YOU have a technical hitch or a programming problem let Martin Phillips give his diagnosis. We'll pay £5 if you raise a really interesting point. Please give full details of the system you're using and include a listing where appropriate, making your question as specific as possible. WRITE TO: Hints & Tips, Acorn User, Redwood Publishing, 68 Long Acre, London WC2E 9JH.

Computerama

the source

ROM SOFTWARE INC VAT

Starbase	59.00
Multiforth/83	51.75
Delux Version (inc. disc)	92.00
Toolkit	27.00
Toolstar	32.95
Comm Star	32.95
Wordwise	39.95
View	32.95
Printmaster	59.00
Caretaker	32.95
Disc Doctor	32.95
Termi (terminal emulator)	32.95
Graphics Extension	32.95
DFS, The Upgrade	27.95
Acorn Speech System Upgrade	55.00
HCCS Forth	39.95
HCCS Logo Forth	67.85
HCCS Pascal	57.00
HCCS Excal	74.75
ROM Expansion Board (ATPL)	
The Best!	43.70

BOOKS NO VAT

BBC Micro Disc Companion	7.95
Creative Graphics	7.50
Graphs & Charts	7.50
List Manual	7.50
Forth Manual	7.50
BCPL Manual	15.00
Discovering BBC Micro	
Machine Code	6.95
BBC Micro Disk Manual	1.95
Disk Systems For	
The BBC Micro	6.95

MICRO POWER INC VAT

Dune Rider	7.95
Killer Gorilla	7.95
Cybertron Mission	7.95
Cosmic Combat	7.95
Chess XB	7.95
Danger UXB	7.95
Escape Moonbase Alpha	7.95
Felix in Factory	7.95
Felix & Fruit Monsters	7.95
Nemesis	7.95
Bumble Bee	7.95
Wizards Challenge	7.95
Jet Power Jack	7.95
Postron	7.95
Demon Decorator	6.85
Alien Swirl	7.95
Alien Destroyers	7.95
Space Jailer	7.95
Ghoul	7.95
Moon Raider	7.95
The Mine	7.95
Hell Driver	7.95
Labyrinth of	
La Coshe	7.95
Zam	7.95
Blockbuster	7.95
Rubble Trouble	7.95
Frenzy	7.95
Stock Car	7.95

SUPERIOR SOFTWARE INC VAT

Mr Whizz	7.95
Wallaby	7.95
Smash and Grab	7.95
Starstriker	7.95
Hunchback	7.95
Overdrive	7.95
Battletank	7.95
Cosmic Kidnap	7.95
Star Battle	7.95
Moon Mission	7.95
Percy Penguin	7.95
Boris In The Underworld	7.95
Rocky	7.95
Spiffine Command	7.95
Crazy Painter	7.95
Road Racer	7.95
Twin Kingdom Valley	9.95

DYNABYTE INC VAT

Pool	7.95
Horseshoe	7.95
Lemming Syndrome	7.95
Corporate Climber	7.95
BBC/ACORN SOFT INC VAT	
Drogna	9.95
Volcano	9.95
Tetrapod	9.95
S. Pascal	19.50
Algebraic Manipulation	9.95
Business Games	9.95
Castle of Riddles	9.95
Creative Graphics	9.95
Countdown to Doom	9.95
Forth	16.85
Graphs & Charts	9.95
Hopper	9.95
Leap	16.85
BCPL (Rom + Disc)	99.95
Missile Base	9.95
Meteors	9.95
Kingdom of Hamil	9.95
Monsters	9.95
Planetoid	9.95
Rocket Raid	9.95
Snooker	9.95
Sphinx Adventure	9.95
Starship Command	9.95
Tre of Knowledge	9.95
Snapper	9.95
Shirley Conran's Magic Garden	9.95
Personal Money Management	9.95
Draughts and Reversi	9.95
Aviator C/D	14.95/17.25
J C B Digger	9.95
Free Fall	9.95
Carousell	9.95

ACORN SOFT EDUCATIONAL SOFTWARE NOW AVAILABLE

White Knight II	11.50
Vutrye	16.10
Tax Calc	17.25
Beyond Basic	11.50
Toolbox	21.00
Canyon	10.00
Record Keeper	15.00
ACORN SOFT MIRLE NOW IN STOCK	P.O.A.
IMAGINE INC VAT	
B.C. Bill	5.50
Padro	5.50
Cosmic Cruiser	5.50
SOFTWARE INVASION INC VAT	
Eagles Wing	7.95
Spooks and Spiders	7.95
3-D Bomb Alley	7.95
Gunsmoke	7.95
Vortex	7.95
Attack on Alpha Centauri	7.95

COMPUTERAMA SOLID STATE JOYSTICK INTERFACE

***with RAPID-FIRE feature**
 Now a totally new concept in joystick control for your BBC Micro. Simply plug into the analogue port, and connect ANY Atari type joystick for instant joystick control. FREE keyboard conversion programme allows joystick control with this one - keyboard-only games. No memory conflicts with this one - due to our unique Relocatable Code feature. **ORDER TODAY.** Only a few available. Demand is bound to be high.

£14.95 + 50p Carriage

EPSON FX80

A SUPERB PRINTER AT A SUPERB PRICE



The most popular of HIGH PERFORMANCE dot matrix printers, has all the features you could ask for:

- 160 cps 11 - 9 matrix, proportional spacing
- Normal, Elite & Italic Characters
- Tractor & Friction Feed 10" Carriage
- Bi-directional, Logic Seeking
- Centronics Interface Standard
- Down loadable Character Set
- User Defined
- Condensed & Double Width Printing
- Super & Subscripts
- Dot Addressable Graphics

NOW AT THE AMAZING PRICE OF £389 Inc VAT

RING FOR LATEST PRICES, MANY REDUCTIONS EXPECTED



TORCH Z80 DISC PACK WITH OVER £1,100 OF SOFTWARE FREE

INC. VAT Free carriage UK only

ORDER TODAY - Get the Z80 version of BBC Basic FREE (Was £125) runs BBC Micro programmes up to twice as fast, gives 32K for graphics AND 48K for Basic programming.

ONLY £789

NEW TORCH Z80 DISC PACK Add Torch Power to any 80 track drive. Complete 2nd Processor AND Free Perfect software worth £1000 ONLY.

£343 Inc VAT

QUICKSHOT II BBC MICRO JOYSTICK

Now with rapid fire Option and Solid State Interface. Optional Relocatable code feature - means that it WORKS with more games than any other similar interface. This SELF-CENTERING JOYSTICK, works even with keyboard-only programmes. A sensation at the Micro User Show. More fun - reaches the games other joysticks cannot. Limited supplies of this item.

£19.95 + £1.55 p&p

WE ACCEPT INSTITUTIONAL EDUCATIONAL ORDERS

ATPL SIDEWISE ROM EXPANSION BOARD

- Full sideways Rom
- Expansion to 16 Roms
- 16K Battery backed
- CMOS Ram option
- No soldering required to fit sideways
- Plug-in-and-go construction - Mounts neatly inside the BBC Micro
- Full buffering of address and data buses - prevents data bus loading problems associated with unbuffered boards
- Pin 1 of on-board sockets are connected properly - No spurious crashes due to this known fault on BBC Micro. Existing sockets on BBC Micro are usable, All Eprom sockets are accessible without removing sideways.

ONLY £43.70 + £1.00 carriage

24 HOUR DESPATCH ON STOCK ITEMS

MAIL ORDER No Stamp required
 Post your order today to **COMPUTERAMA DEPT. AU10 FREEPOST STAFFORD ST16 2BR**
 OR TELEPHONE OUR MAIL ORDER HOT LINE With your ACCESS or VISA number we will endeavour Micros, Monitors, Disc Drives, Printers £8/item.

MONEY SAVER!

50% OFF

MONEY SAVER!

FREE with every order, five pounds worth of moneysaving vouchers.

HARDWARE CORNER

VISIONS INC VAT	
Galaxy Raider	5.50
Snooker	7.95
Digger	7.95
Daredevil Dennis	7.95
Nifty Lifty	7.95
Demolisher	7.95
Pengi	7.95
PSION INC VAT	
Saloon Sally	6.95
VuCalc	14.95
VuFile	14.95

MELBOURNE HOUSE INC VAT

A Guide to Playing The Hobbit	4.95
The Hobbit	14.95
BBC INC VAT	
ACORN ELECTRON	185.00
+ 1 Electron Interface	59.95
BBC Model B	399.00
BBC Model B - DOS	469.00
BBC Micro Disc Upgrade	P.O.A.
BBC Micro A-B Full Upgrade	95.00
BBC Micro Teletext Receive	225.00
BBC Micro Z80 2nd Processor	299.00
BBC Micro B502 2nd Processor	199.00
Torch Graduate	P.O.A.
Torch Unicorn	P.O.A.

DISC DRIVES INC VAT

LV! Dual 100K	340.00
Pace Single 100K	169.95
Pace Single 40/80T D/Sided	282.90
Pace Dual 100K	338.00
Pace Dual 40/80T D/Sided	573.95
Torch Dual 400K Z80 Disc Pack	789.00
Pace 200K 40T D/Sided	243.00
HOBBIT FLOPPY DRIVES	99.95

MONITORS INC VAT

Microvites 14" Colour	229.00
Sanyo 14" Colour	269.00
Fidelity 14" Colour Monitor	199.00
Decca 14" Colour TV/Monitor	263.00
Sanyo 12" Green	189.00

PRINTERS INC VAT

Epson RX80	269.00
Epson RX50FT	299.00
Epson FX80	389.00
Epson FX100	569.00
Shinwa CP80	229.00
Riteman	286.00
Juki 6100 Daisywheel	399.00

MISCELLANEOUS INC VAT

Sanyo DR101 Data Recorder	39.95
Sanyo DR202 Data Recorder	44.95
Cassette leads - all types	2.80
Computerama Joystick interface	14.95
Quickshot Joystick (FOR BBC MICRO)	19.95
Printer Cable (Parallel) 1.2 m	9.95
BBC Micro Deluxe Cover	5.95
Light Pen	28.75
Data Cassettes 5 x C20/C15	1.95
The Plug Power Filter	14.95

DEDUCT £1.00 FROM SOFTWARE LIST PRICES

MICROBYTE INC VAT	
Pinball	7.95
CLARES INC VAT	
B-Base	25.00
Replica II (Disc Only)	12.00
Graph Disc	12.95
The Key (Disc Only)	12.95
Shadow/Inspector	7.95

DR SOFT INC VAT

3D Convoy	7.95
Jump Jet	7.95
747 Flight Simulator	8.95
Graph	7.95

AMCOM INC VAT

Fortress (C/D)	7.95/11.95
Space Highway	7.95

ADVENTURE INTERNATIONAL INC VAT

The Hulk	9.95
Adventureland	9.95
Voodoo Castle	9.95
Secret Mission	9.95
Pirate Adventure	9.95

H. SOFT (WATFORD) INC VAT

Penguin	7.95
ALLIGATOR INC VAT	
Uncle Claude	7.95
Spiritfire	7.95
Neanderthal Man	7.95
Blogger	7.95
HEWSON INC VAT	
Heathrow Air Traffic Control	7.95
ASF INC VAT	
Chuckie Egg	7.90
Cylon Attack	7.90
180 1 Darts	7.90
AARDVARK INC VAT	
Zalaga	6.90
Frak	6.90
ADDITIVE INC VAT	
Football Manager	5.90
MIRRORSOFT INC VAT	
First Steps With	
The Mr. Men	9.95
MICRO USER INC VAT	
Micro Olympics	6.90
MRM SOFTWARE INC VAT	
Artist	9.95
O-Man	5.70
O-Man's Brother	5.70
Diamond Mine	5.70
Guy in The Hat	5.70
3D Munchy	5.70
Castle Assault	5.70
Darts	5.70
MOSAIC INC VAT	
My Secret File	9.95
OCEAN INC VAT	
Mr. Wimpey	6.90

Computerama

STAFFORD 59 Foregate Street Tel: (0785) 41899	STONE-ON-TRENT 11 Market Square Arcade, Hanley Tel: (0782) 268620	SHREWSBURY 13 Castle Gates Tel: (0743) 60528
--	--	---

```

10 REM Listing 2
20 MODE1
30 PROCsetup
40 PROCscreen
50 END
60 :
70 DEFPROCsetup
80 DIM title$(1),instr$(3)
90 title$(0)="Title line 1"
100 title$(1)="Title line 2"
110 instr$(0)="1st line of
instructions."
120 instr$(1)="2nd line of
instructions."
130 instr$(2)="3rd line of
instructions."
140 instr$(3)="4th line of
instructions."
150 VDU19,0,4,0,0,0:REM Blue
background
160 VDU19,2,6,0,0,0:REM Colour
2 - cyan
170 ENDPROC
180 :
190 DEFPROCscreen
200 COLOUR 3
210 FOR T=0 TO 1
220 x=20-LEN(title$(T))/2
230 PROCdouble(title$(T),x,T*2)
240 NEXT T
250 COLOUR 1
260 PRINTTAB(0,28);
270 FOR N=0 TO 3
280 PRINTinstr$(N);
290 IF N<3 PRINT
300 NEXT N
310 VDU28,0,27,39,4,14
320 COLOUR 3
330 ENDPROC
340 :
350 DEFPROCdouble(A$,x,y)
360 X%=0:Y%=13:A%=10:D=&D00
370 C#=CHR$(240)+CHR#8+CHR#10+
CHR$(241)
380 FOR N=1 TO LEN(A$)
390 B#=MID$(A$,N,1):?D=ASC(B#):
CALL&FFF1
400 VDU23,240,D?1,D?1,D?2,D?2,
D?3,D?3,D?4,D?4
410 VDU23,241,D?5,D?5,D?6,D?6,
D?7,D?7,D?8,D?8
420 PRINT TAB(x+N-1,y)C#:NEXT
N
430 ENDPROC

```

Listing 2. Modified version of listing 1 for Electron owners

lines, which will be the scrolling window. Lines 260 to 300 print out the four instruction lines at the bottom of the screen. The background colour is set to blue and the foreground colour to cyan.

Line 290 is used to start a new line after each line of instructions except the last. This line appears at the bottom of the screen, and if the cursor goes to the next line the screen will scroll, losing the top title line.

Line 310 is the key to the whole program. It defines a text window in the middle of the screen four spaces in from the left to avoid the teletext characters placed down the left-hand three columns. VDU14 puts the text window into paged mode so that the screen will scroll only when the shift key is pressed. Once the program has

run, list it to see the effect. Title and instructions will remain in place while the rest of the program scrolls.

The colours can be changed by changing the teletext colour codes. You don't have to type in the CHR\$132 etc each time. Instead if the shift key and (in this case) function key f4 is pressed, it will give the blue character control code. This feature of the function keys is present only on a BBC with the 1.2 OS and not the Electron. It will not show up on printed out listings so the CHR\$ alternative has been used for the print-out.

Red	CHR\$129	SHIFT/f1
Green	CHR\$130	SHIFT/f2
Yellow	CHR\$131	SHIFT/f3
Blue	CHR\$132	SHIFT/f4
Magenta	CHR\$133	SHIFT/f5
Cyan	CHR\$134	SHIFT/f6
White	CHR\$135	SHIFT/f6

When typing in this program, you must ensure that all punctuation marks are

exactly as in the listing or some odd effects will appear on the screen. The display could consist of a series of black and white stripes, for instance, or the title or instructions could be lost. Readers interested in using text windows are reminded that this subject also occurred in the July Hints & Tips.

For Electron owners, a similar program (Listing 2) is included which uses mode 1 instead of mode 7 and the double-height procedure described elsewhere in this section.

Envelope

generators

SEVERAL readers have been trying to unravel the mysteries of the BBC's or Electron's sound system. The thing that most find confusing is the ENVELOPE statement. This statement is followed by 14 parameters, and trying all the

page 54▶

Off-the-shelf procedures

FOR several years I've been saying to myself that I must build up a library of simple procedures that I can quickly *EXEC onto the end of an existing program to save typing time. I still have not achieved this. I've included procedures in this column that can be used in such a way but it would be nice to receive short procedures that readers find useful when programming. Perhaps we could then assemble a library of these for publication and inclusion on the monthly cassette.

One procedure I use frequently is a double-height printing routine that works in any of the BBC or Electron's graphics modes. This is shown in listing 3. Once the procedure has been typed in it should be saved by typing *SPOOL "DOUBLE" and pressing RETURN. Then type list and the procedure will be transferred to tape or disc under the filename DOUBLE. To complete the process type *SPOOL again and press RETURN. This then

closes the *SPOOL file.

To show how the procedure can then be incorporated into a program type in the following short program:

```

10 REM Program to demonstrate
double height procedure
20 MODE 1
30 PROCdouble ("This is DOUBLE
height", 9, 5)
40 END
50 :

```

Then load in the procedure by typing *EXEC "DOUBLE" and pressing return. The procedure should load in line-by-line and at the end will give an error message. Don't worry, that is normal. Now list the program and the procedure will be added to the end of the listing. When the program is run the message should be printed in the middle of the screen five lines down from the top in double-height lettering.

The use of this procedure is also demonstrated in listings 2 and 4.

```

10 REM listing 3
20 REM Do not spool these two lines!
20000 DEFPROCdouble(A$,x,y)
20010 X%=0:Y%=13:A%=10:D=&D00
20020 C#=CHR$(240)+CHR#8+CHR#10+CHR$(241)
20030 FOR N=1 TO LEN(A$)
20040 B#=MID$(A$,N,1):?D=ASC(B#):CALL&FFF1
20050 VDU23,240,D?1,D?1,D?2,D?2,D?3,D?3,D?4,D?4
20060 VDU23,241,D?5,D?5,D?6,D?6,D?7,D?7,D?8,D?8
20070 PRINT TAB(x+N-1,y)C#:NEXT N:ENDPROC

```

Listing 3. Double-height printing in any of the BBC and Electron's graphic modes

combinations of these parameters is a slow and laborious task. It can be greatly simplified by using an envelope generator. This is a simple program that allows the parameters to be quickly and easily changed and the sound of the new envelope heard.

Two simple envelope generators are included this month. Listing 4 is an envelope generator for the BBC and listing 5 a simpler version for use on the Electron. The Electron doesn't have the full ENVELOPE statement and so needs a different program, although the full BBC version will run on the Electron.

The program is quite straightforward to use and understand, although it is worth reading the 'sound' chapter in the *User Guide* first. When an interesting sound is heard it is worth recording the parameters and a brief description of the sound. A collection of sound effects is useful when writing programs. Again, I would be interested to hear from readers who have discovered useful envelopes. Remember that an envelope will sound right only over a limited range of the pitch parameter, and this too should be varied to hear different effects.

See page 99 for listings 4 and 5

REMInder

WHEN de-bugging programs you often have to delete lines that are causing trouble. The easiest way to do this without forgetting the contents of the line is to edit the line, put a REM statement directly after the line number and then copy the rest of the line. Now when the program is run the rest of the line will be ignored once the REM statement is encountered. If the line is to be included again, the REM statement need only be deleted.

Word-blocked

MR KELLER of Weybridge has his BBC and *View* wordprocessor fitted up to a Silver Reed EX44 typewriter. When he tries to print out the text that he has saved on a cassette recorder the 'Block' error appears on the screen after a few lines. Mr Keller wonders if he needs a printer driver to cure the problem.

The answer is simple - use a cassette recorder with a motor control fitted. What is happening is that the

printer is taking so long to print out the first block of text saved on tape that by the time it is ready for the next block, the cassette had played on and was at the wrong block. With a motor control fitted, the cassette stops after the first block and restarts when the printer is ready for the next block.

Menu amendment

IN MAY's Hints & Tips a simple disc menu program was printed. A problem can occur with this menu if it is used to *LOAD a program that resides in a different place in memory from normal. What happens is that after loading the appropriate program the menu program will move onto the next line and load the following program too. To avoid this, insert a line after the offending line to end the program. Eg:

```
490 CHAIN"PROG1"
500 *LOAD"PROG2"3000
505 END
510 CHAIN"PROG3"
```

Notice that the line number ends in a 5 so that it doesn't upset the computed GOTO in line 390

GOLF DOCTOR

Computer software to keep your score, analyse your play and calculate your handicap - for the BBC Model B Microcomputer.



- * Stores a full year's play for most golfers (100 rounds on 10 courses)
- * Fairway and green strokes recorded separately.
- * Weather conditions included.
- * Comprehensive selective analysis of play.
- * Computer rating of performance.
- * Calculates handicap to latest CNGU rules.
- * Capacity for any number of golfers.
- * Well written user guide.

To: MICRO INVESTOR SOFTWARE, P.O. Box 16, Heswall, Wirral, L61 4YT.

Please send me the following:

Quantity	Product	Version	Price	Total
	Golf Doctor	Cassette	9.95	
	Golf Doctor	Disc	11.95	
	Overseas Postage - First Item		3.00	
	Overseas Postage - Each additional item		1.00	

My computer is a _____ Discs are 40/80 track.
I enclose a cheque/P.O. payable to: MICRO INVESTOR SOFTWARE.

Name _____

Address _____

Post Code _____

EPROM PROGRAMMER for the BBC micro

An exceptionally versatile unit, programs EEPROMs and EPROMs from 2K to 32K.

Powerful, easy to use software in a sideways ROM. Features full screen data editor, files, and softkeys.

Professionally designed hardware ensures reliable and safe programming, also detects badly socketed EPROMs.

Soundly constructed in a convenient flip-top box which protects unit when not in use. Supplied with a comprehensive manual.

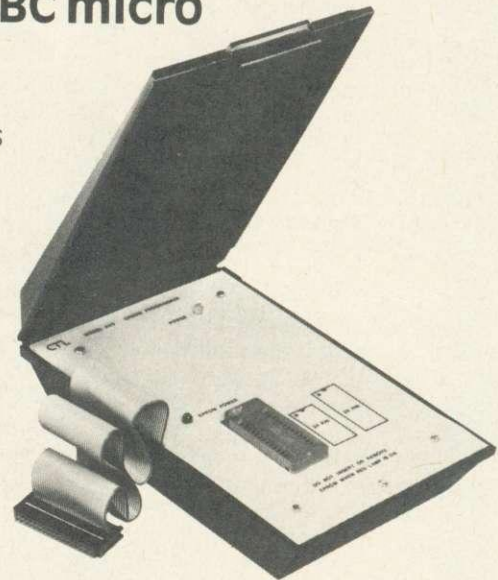

£95 (excl VAT, free P&P)

2 year guarantee. Detailed information on request

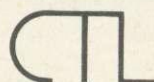

Control Telemetry of London
Unit 11, Burmarsh, Marsden St,
London NW5 3JA Tel: 01-482 2177

Low Prices



Phone your nearest dealer for the most competitive prices

Best Service



- ★ Europe's No. 1 Group of Retail Outlets
- ★ Check our multi-national network for your nearest dealer
- ★ Backed by an after-sales service second to none



Another Winner From the Big M Stable

The Electron – A thoroughbred from the manufacturers of the BBC, who have incorporated all their experience and knowledge to conceive another winning computer. Many BBC programs are compatible. This full colour 32K ROM and RAM computer with text and graphics includes a cassette input, and a multi-way connector for the addition of expansion units containing interfaces to additional hardware. It has a 56 key full travel QWERTY keyboard, 10 user-definable and 29 pre-defined keys enabling BASIC keywords to be entered in a single keystroke. The Electron comes with free introductory cassette containing 19 programs including a number of exciting games. £199.00

The Electron



Phone your nearest dealer for the most competitive prices

Low Prices

TORCH Z80 Disk Pack 800K

TORCH Z80 Disk Pack 800K
Dual disk drive with Z80 second processor and CPM for BBC. Gives BBC 64K of usable RAM.



48K Sinclair ZX Spectrum

Sinclair ZX Spectrum
48K basic, colour and text graphics.



Commodore 64
Colour sophisticated ROM/RAM user, UHF/Composite video, high resolution graphics.

Commodore 64

COMING SOON
Commodore Plus-4

Commodore 16 Starter Pack includes Cassette Unit,

Introduction to Basic and 4 Software Programs for only

BBC Model B



BBC Model B
Full colour 32K ROM Computer with text and graphics 80 column text screen, extended Microsoft basic, built in assembler 1MHz and tu interface, sideways RO RS 423, A/D converter.

MONITORS

RGB Colour Monitor STD/RES

RGB Colour Monitor H/RES

12" Green Monitor

12" Amber Monitor

RGB COLOUR MONITORS

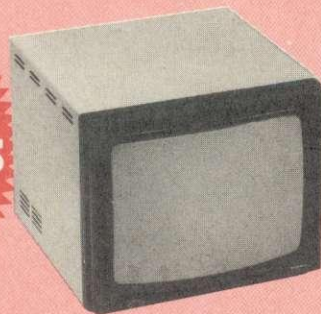

Double Density DFS
Disk controller for the BBC Micro. Up to 2MB on line storage. Auto internal format programs for 5 1/4" and 3" drives. Acorn compatible runs basic, wordwise, BCPL, view forth etc. 25% faster than Acorn DFS on file access. Auto 40-80 track switching. Compatible with .1 DFS view and sideways ROM.

Double Density DFS



The Big International

- | | | | | | | |
|---|---|--|---|--|---|---|
| <p>Bucks
Citybench
2/4 Eaton Place
Marlow
06284 75244</p> <p>Micro Land
Weatherburn Court
Brunel Centre
Bletchley
Milton Keynes
0908 368018</p> <p>Cambridge
G.C.C. Cambridge Ltd
66 High Street
Sawston
Cambridge
0223 835330</p> <p>Cornwall
Computavision
4 Market Street
St. Austell
0726 5297</p> | <p>Derby
First Byte Computers
10 Castlefields
London Road
Derby
0332 365280</p> <p>Devon
Computer Systems (Torbay)
35 Hyde Road
Paignton
0803 524284</p> <p>Roy Hart Computer Services
10 Fore Street
Tiverton
0884 253468</p> <p>Dorset
Solent Micro Systems Ltd
25 Bargates
Christchurch
0202 470468</p> | <p>Durham
General Northern Computing
8 Whitworth Road
South West Ind. Estate
Peterlee
0783 860314</p> <p>Essex
Essex Computer Centre
216 Moulham Street
Chelmsford
0245 358702</p> <p>Focus Computer Systems
140A Hathaway Road
Grays
0375 79717</p> <p>County Computer Stores
5a West Square
Harlow
0279 414692</p> | <p>The Home Computer Centre
261 Victoria Avenue
Southend-on-Sea
0702 43568</p> <p>Gloucs
The Model Shop
22 High Street
Stroud
04536 5920</p> <p>Sabre Consultants Ltd
103 High Street
Tewkesbury
0684 298866</p> <p>Herts
County Computer Stores
95a South Street
Bishops Stortford
0279 506801/2</p> <p>Hobbyte
153 Grove Road
Harpenden
0587 3542</p> | <p>N. Humberside
Beverley Computer Centre
1 Windmill Passage
55 Lairgate
Beverley
0482 881911</p> <p>S. Humberside
Ashby Computer Centre
247 Ashby High Street
Scunthorpe
0724 871756</p> <p>Kent
Tollgate Computers
249 Beaver Road
Ashford
0233 37187</p> <p>Data Store
6 Chatterton Road
Bromley
01-460 8991</p> | <p>Canterbury Software Centre
9 The Friars
Canterbury
0227 53531</p> <p>North Kent Computer Centre
52/54 Bellgrove Road
Welling
Bedley
01-301 2677</p> <p>Lancs
Amat Computing
67 Friars Gate
Preston
0772 561952</p> <p>London
Henry's Computer Shop
404 Edgware Road
London
01-402 6822</p> <p>Miracle Computers
249A Coldharbour Lane
London
01-274 7700</p> | <p>Greater
Entertain
88 The Ro
Bury
061 797 3</p> <p>Control T
184 Mark
Hyde
061 366 8</p> <p>Middles
Enfield C
135 High
Ponders E
Enfield
01-805 77</p> <p>Twilista C
17 Regina
Southall
01-574 52</p> <p>J.K.L. Co
7 Windsor
Uxbridge
0895 5181</p> |
|---|---|--|---|--|---|---|

Best Service

Phone your nearest dealer for the most competitive prices

DISK DRIVES



- ACORN AND BBC DISK DRIVES
- Disk Drive 100K Single
- Disk Drive 200K Single
- Disk Drive 400K Single
- Disk Drive 800K Dual

Two New Products from QUEN-DATA



DWP 20 Daisy Wheel Printer



Executive 80 Electronic Office Typewriter With 2 Line display

PRINTERS

- Astron JP80 (as ill.) MCP40 (Colour Printer)
- Epson RX-80 Printer
- Epson FX-80 Printer 160cps

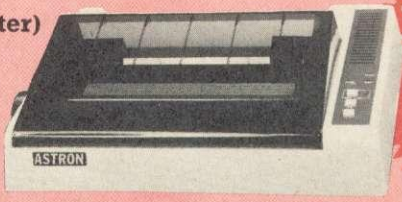

PRINTERS

Joystick & Cassette Players



Joystick & Cassette Players – Many joysticks and cassette players available from stock. Just in . . . The BBC Compatible Crack-Shot.

SOFTWARE

SOFTWARE all leading chart software available



This special complete pack contains:
 Apple IIe Personal Computer, disk drive and controller. TV Modulator (colour and sound) • £25 Apple Software rebate certificates
 £100 Training Voucher • £25 Apple Monitor rebate certificate • Micronet/Prestel discount voucher – £68 off • 'Windfall' Apple user magazine
 Apple Sports Bag • Software Certificates • Catalogue of Hardware and Software

APPLE HOME PACK



Personal Dealer Network

Greater Manchester
 Entertainment in Leisure
 88 The Rock
 Bury
 061 797 3463

Control Technology
 184 Market Street
 Hyde
 061 866 8223

Middlesex
 Enfield Communications Ltd
 135 High Street
 Ponders End
 Enfield
 01-805 7772/7434

Twilster Computers
 17 Regina Road
 Southall
 01-574 5271

J.K.L. Computers
 7 Windsor Street
 Uxbridge
 0895 51815

W. Midlands
 Impulse Computer World
 60 Hartford Street
 Coventry
 0203 27711

Wolverhampton Computer Centre
 17/19 Lichfield Street
 Wolverhampton
 0902 29907

Norfolk
 Abacus
 12a Pottersgate
 Norwich
 0603 61441

Viking Computers
 Ardney Rise
 Catton Grove Road
 Norwich
 0603 45209

Somerset
 Sinewave Computer Services
 Corporation Street
 Taunton
 0823 57526

Staffs
 Eric Reynolds Ltd
 86 High Street
 Burton-on-Trent
 0283 69086/65869

Town Computer Store
 30 Town Road
 Hanley
 Stoke-on-Trent
 0782 287540

Suffolk
 Brainwave
 24 Crown Street
 Ipswich
 0473 50965

Micro Management
 32 Princes Street
 Ipswich
 0473 59181

Surrey
 Concise Computer Consultants Ltd
 1 Carlton Road
 S. Croydon
 01-681 6842

E. Sussex
 Gamer
 24 Gloucester Road
 Brighton
 0273 698424

W. Sussex
 Orchard Business Systems Ltd
 34 East Street
 Horsham
 0403 68461

Worthing Computer Centre
 32 Liverpool Road
 Worthing
 0903 210861

Tyne & Wear
 Video & Home Computers Centre
 3 Roxburgh House
 Park Avenue
 Whitley Bay
 0632 534725

N. Yorkshire
 Skipton Computer Systems
 16 Swadford Street
 Skipton
 0756 68192

W. Yorkshire
 Thoughts & Crosses
 37 Market Street
 Heckmondwike
 0924 402 337

N. Ireland
 Everyman Computers
 80 Charlotte Street
 Ballymoney
 Co Antrim
 02656 62116/62658

Wales
 Automation Services
 42 Dunraven Place
 Bridgend
 Mid Glamorgan
 0656 3550

Scotland
 Micro Store
 38 The Arcade
 King Street
 Stirling
 Central Region
 0786 64571

For your nearest European Dealer telephone Belgium or Holland

Belgium
 Micro Management
 Belgium
 Ballaerstraat 75
 2018 Antwerp
 Belgium
 03-238 9284

Holland
 Micro Management
 Netherlands
 Raad Huisstraat 98 2406
 Ah Alphen-aan-den-rijn
 01720 - 72580

The last piece to make your BBC business system complete



Now, for the first time, you can realise the full potential of your BBC computer as a powerful **Business Management System**.

When developing this new range of business software, our programmers had one objective foremost in their minds – to design 'no nonsense' software for the busy, growing business. We knew that it would have to be easy to understand, efficient, flexible and fast. And the result, a product that will be of immediate value to any small, expanding business – it dramatically reduces the time spent on administration, and presents printed documentation, to the highest standards.

The Sales and Purchase Ledger Duo ensures that you are always in control of cashflow by providing a comprehensive record of ingoings and outgoings, keeping accounts up-to-date and issuing statements and reports on time.

Unique features are the automatic production of V.A.T. statistics for returns and the ability to provide year end accounts for your auditors.

The Stock Control and Invoicing Duo monitors and automatically adjusts stock levels, whilst issuing purchasing recommendations. Invoices are rapidly calculated and immaculately typed.

The unique feature is a free format invoice, which allows non-standard narrations to be used, a most important detail, and previously unavailable.

The two Systematics International Business Duo's are available at only £89.00 each, from selected Systematics International stockists or direct by using the coupon below.

Order with confidence from Systematics International, our reputation as the U.K.'s leading Software House – is your guarantee of satisfaction.

Systematics International

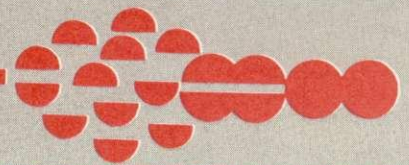

Systematics International
Microsystems Limited,
Cleves House, Hamlet Road,
HAVERHILL, Suffolk CB9 8EE

Telephone: (0440) 61121
Telex: 99431 SIG

Please send me by return the following Systematics International Business Duo's at £89.00 each on TAPE/DISC*

Sales/Purchase Ledger

Stock Control/Invoicing

I enclose a Postal Order/Cheque* made payable to Systematics International for £ _____
(add £1.50 towards carriage and insurance) OR

Please charge my Access/Barclaycard/Ammex/Diners* card number

Signature _____

Name: _____

Address: _____

Post code _____ Telephone number _____

Credit card customers may use our 24 hour Telephone ordering service S.T.D. 0440 61121

Orders normally despatched within 48 hours.

Tick this box for a leaflet and the address of your nearest S.I. Duo stockist.

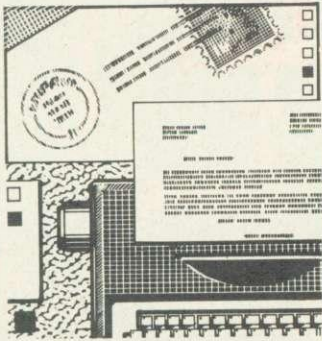

Clearing up

queries on

second processor

Sir, I am writing in response to the letter from I Crawford in your August edition concerning his 'problems' with the 6502 second processor. It seems to me he has not understood what happens when using a second processor.

The 6502 is an eight-bit processor and because of this can address 64k directly. As a result, any languages or machine code programs have to run in the second processor, hence the need to copy them across from the input/output processor (in this case the BBC micro). Some of the memory in the second processor is used to hold operating system software at location &F800. On start-up the default language is copied across the Tube to the same memory position as it occupied in the I/O processor - but this time in the memory space of the second processor.

HiBasic is a relocated version of Basic II and resides in the second processor at location &B800, giving approximately 44k for Basic programs. For machine code programs, 61k is available since the memory occupied by Basic and its workspace may be used.

Also with a second processor, HIMEM remains fixed at &8000 regardless of mode, since the screen is mapped into the I/O processor and not the second processor. Memory in the I/O processor that is not being used for display purposes can still be used - effectively by poking and peeking. This may be done using operating system calls as defined in the *User Guide* and *Advanced User Guide*. It is also possible to execute code in the I/O processor from the second processor.

Now to I Crawford's questions.

When using HiBasic the gain made is the memory below the operating system and above the default language location (ie, the location Basic occupies in an ordinary machine), this being about 14k.

When the machine is switched on, Basic is copied across to the second processor and any programs loaded will be run here. The original memory is now used only for display purposes. Part of this memory (depending of course on mode) may be used by peeking and poking via the correct operating system calls, but cannot be reclaimed.

As far as ROMs are concerned, all Acornsoft's will work across the Tube. Wordwise will not work because it pokes directly to the screen. The same is true for any ROM which pokes the screen directly.

I hope this clears up some of the problems and that my comments will be of use to potential purchasers of a second 6502.

Gary Jones
Manchester

Reviewers need to

compare products

Sir, As one who is involved with the BBC micro, both personally and professionally as a teacher, I must compliment you on the new format of your magazine, particularly the idea of compacting the listings into a separate section of the magazine. There seems, too, to be a greater variety of articles, and diversity of sections.

I find your magazine a tremendous reference point for new software that may be of interest to me at home, and for new developments in the field of education.

With particular reference to the educational software or developments in hardware I find it difficult to evaluate new material and have to rely on publications that concern themselves either with the BBC computer or with educational computing. I have found your reviews objective and fair, but could they be more comparative?

I suggest this because I do not have the facilities to compare new software, making a realistic judgment more difficult. Software houses are still reluctant to supply local authority education computer centres with software free for evaluation.

To take a case in point, this month (July issue) you reviewed *Edfax*. How much more relevant and useful it would have been if you had been able to take 'viewdata systems' as a theme and to compare the software available. *Edfax* certainly has strengths, but what are the qualities of Optima's *Datext* or Datapen's *Teletext Display Creator*. My own experience would put *Datext's* move, copy, cycling options in a different league to those of *Edfax*, yet *Edfax's* use of function keys is clearly more friendly. At the same time, the documentation of *Edfax* is extensive, that of *Datext* restricted to a fold-up pamphlet!

Similarly, there has been a need for a comprehensive database for schools that is menu-driven and accesses the disc rather than being an enhanced cassette version. Suddenly, they appear to be available in plenty, but again how can you evaluate them without purchasing each one?

I do not feel that I am a lone voice crying in the wilderness, there must be many 'non-experts' like myself in primary schools up and down the country who seek opportunities for evaluation of new materials. Schools do not have the money to make errors over choice of software.

David Powell
Rotherham

We couldn't agree with you more, and have already begun the task you suggest. The review, with bench tests, of four monitors in June's issue was very popular and in this issue we cover Basic toolbox ROMs (page 157).

To say these reviews are strictly comparative would be wrong, but they aim to give a series of test criteria that readers can apply for themselves. Already, there are dozens of databases and wordprocessors, making detailed comparison difficult. However, our reviews should enable you to decide what facilities you need and to make your choice. As you point out, most have strengths and weaknesses, and the opinions of a reviewer may not tally with yours.

In the next few months we shall consider databases, wordprocessors, machine code utilities, lightpens and joysticks. In November's issue, six turtles and buggies are put under scrutiny. Please let us have your comments.

Bar codes in

Acorn User

Sir, May I comment on a news item in the August issue of *Acorn User*, which said that Wordsmiths of Somerset were the first company to offer a professional typesetting service to Wordwise users. We have been offering this service for 12 months, having done work for, among others, Computer Concepts themselves (Disc Doctor manual) and more recently Clares Micro Systems (Beta Base manual).

We are also co-operating with John Coll and Mike Bostock of MEP in generating high-quality bar codes for their bar code reader. I believe *Acorn User* is to be the first magazine to publish bar code programs. We can generate typeset bar codes directly from a cassette/disc program or messages from Wordwise, etc. In fact, our service extends beyond Wordwise and we believe we are able to typeset directly from most BBC word-processors - including Wordwise, View and Wordsworth. An information booklet explaining our coding system is available.

Our ability to typeset from various disc formats enables us to offer an additional data conversion service of transferring data between different types of disc, ie accept a BBC disc and transfer the data to a Tandy 80, or Epson to a Torch, or Apple to a Sharp etc. This data conversion service normally involves a basic handling charge plus 25p per thousand for the first 500,000 characters and 20p per thousand for the remaining characters.

Ray Lumb
Quorum Technical Services
Sandford Park Trading Estate
Corpus Street
Cheltenham
Gloucs GL52 6XH

We don't think *Acorn User* will be the first magazine to publish bar code listings (*Byte* did it a few years ago in the US), but we are supporting the MEP with its project which will be launched in October.

Addison Wesley will be releasing the reader with software and documentation, while *Acorn User* will explain the ideas involved, and make software available in bar code format.

So, interested parties should keep their eyes peeled!

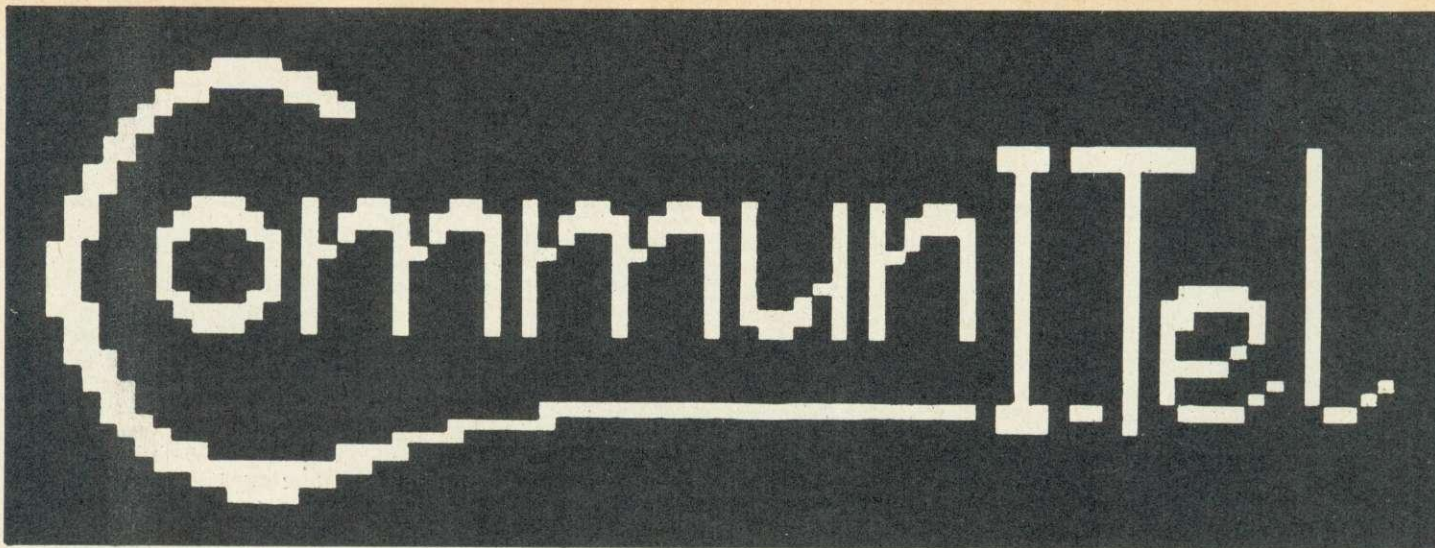

announces its complete local and wide area Viewdata communications system for the BBC micro.

The first system to unlock the full power of the BBC micro, it turns the BBC into THE Viewdata/communications machine.

Become your own 'micro-PRESTEL'.

Log on to any other Viewdata system.

Create your own Viewdata bases & telesoftware. Let others access them over the phone.

Explore the new world of electronic publishing & information services.

- * By far the most comprehensive and easy to use Viewdata system for the BBC micro.
- * Track tested since Nov. 83 in the national ITeC program.
- * Subset to be bundled by Acorn with their new Winchester file server.
- * Adapts itself to Disc or Econet Level II.
- * Up to 195 frames on a disc.
- * Multiple databases can be used simultaneously on a network.
- * Special Education licence (Single school, multi-machine, multi-site licence).

The complete package includes SOFTWARE, MANUALS, LEADS and MODEM.

Nothing further required beyond the BBC micro and the new 600 series B.T. phone socket.

THE SOFTWARE

- * **SYSTEM MENU** simple cursor driven selection used throughout, with powerful configuration facilities. Auto-booting.
- * **OFFLINE EDITOR** one of the best viewdata editors available for ANY machine, combining exceptional facilities with ease of use, enabling complete Viewdata bases to be created on disk or network.
- * **SEARCH** this enables a Viewdata base to be searched locally in exactly the same way as when on-line to PRESTEL.
- * **CAROUSEL** for exhibition and public display, frames can be left automatically displaying in a cycle.
- * **FRAME PRINTER** hard copy of frames, supporting parallel, serial or network printers, with graphics supported on Integrex colour inkjet, Epson FX80 & MX100 type III, Microline 80/82, Silver Reed EX43, and text on any other ASCII printer.
- * **TERMINAL** can log onto any other Viewdata system, single key auto-dialling, download frames to a local database, telesoftware downloading, full on-line editing, frame-load and send.
- * **HOST** enables a locally created Viewdata base to be accessed by any standard Viewdata over the phone. Also provides an on-line editor so that callers can enter messages or complete frames, saved in a private "in-tray".
- * **TELESOFTWARE FORMATTER** any file, text or data, as well as programs, can be turned into C.E.T. telesoftware frames and made available to callers via the HOST, providing machine independent secure file transfer through the C.E.T. standard.

REQUIREMENTS

BBC micro B, OS 1.0+, DFS 0.9+ &/or Econet level 2 / NFS 3.34+. Also B.T.600 series phone socket.

PRICES

FULL SYSTEM as outlined above.
£325.00 + VAT + pp

LOCAL MODE OFF-LINE SYSTEM (No communications).
Software: MENU, EDITOR, SEARCH, CAROUSEL, FRAME PRINTER, + full documentation, all as outlined above, working on disk or Econet level 2
£45.00 + VAT + pp.

HARDWARE

- INTELLIGENT AUTO-ANSWER / AUTO-DIAL MODEM** the first of the new generation of intelligent modems, it is far in advance of anything else in the field.
- * No buttons or knobs to set — it sets itself — and no understanding of bits and bauds needed.
- * Auto-dial software driven — needs no telephone handset, making phone costs controllable.
- * Auto-answer — handles incoming calls unattended.
- * **When calling another CommuniTel system in HOST mode, unique speed switching enables frames to be spent at high speed, creating a fast electronic mail system with dramatic phone cost savings.**
- * Robust, steel cased.
- * B.A.B.T approved (No. S/1397/3/E/450348) — legal to use on public B.T. phone lines.
- * All leads provided — just plug in and it's ready to go.

DOCUMENTATION

- * **TUTORIAL MANUAL** an excellent self-teach tutorial manual is provided. This is properly type-set in large type and heavily illustrated with colour photographs. Further copies of this are available separately. This covers every part of the system.
- * **REFERENCE MANUAL** a comprehensive reference manual covers the remaining aspects of the system.

SCHOOLS

Hatfield Advisory Unit for Computer Based Education have negotiated a special 'schools deal' and are selling the Local mode off-line system + the TERMINAL software + a book on Educational uses of Viewdata + sample database disk, under the extended schools licence for the same price: £45.00 + VAT. Enquiries to Hatfield AUCBE.

FURTHER INFORMATION

For further information and order form write to:

CommuniTel Ltd.
189 Freston Road,
London W10 6TH.

Searching for

robot projects

Sir, After seeing the BBC TV series 'Computers in Control', I am interested in the Fisher-technik models. How do I link them to my BBC micro?

Also, has anyone published any books on home-made robots?

Paul Dormer
Cheshire

There is a Fishertechnik robot kit which can be made up into six variants: a telescopic arm; graphics tablet; sorting machine; crane; plotter; and solar tracker. It costs £92 and links to the BBC through the user and analogue ports. Simple software is included.

The list is available from Micro Robotic Systems, 20 Penywern Rd, London SW5 9SU.

There is a magazine called *Practical Robotics*, and *Electronics and Computing Monthly* often carries articles on robots. Next month's *Acorn User* features a review of six turtle and buggy-type robots, with more on robotics to come in the New Year.

QL chance

Sir, The announcement that Acorn has obtained a renewal of the BBC contract for four years will be generally welcomed in our schools and colleges. This continuity should provide a much-needed element of stability in a field where there is, all too often, change for the sake of change, or so it appears.

Meanwhile, the fact that Sir Clive has, not for the first time, missed not only the Bus but also the Tube could allow more time for development of the QL as a genuine competitor to the Beeb.

Kenneth Swinburne
St James's University Hospital
Leeds

Joystick aid

Sir, I would be grateful if you could list the ADVAL commands that detect joystick movement in all directions as the 'Useless Guide', sorry, *User Guide* does not list them!

Robin Sasson
Slough

We think you're being a bit harsh on the *User Guide*, but

here's the information.

ADVAl (1) and ADVAl (2) are used to detect movement on one joystick and ADVAl (3) and ADVAl (4) on the other. ADVAl (1) and ADVAl (3) detect left-right movement, returning a low number when the joystick is right, and a high number when the joystick is across to the left. ADVAl (2) and ADVAl (4) return a low number when the joystick is back and a high number when the joystick is forwards. The number returned is in the range 0 to 65520.

Analogue joysticks will return a value even if the joystick is not being moved, the number returned indicating the position of the joysticks.

Elk insanity

Sir, I've been reading *Acorn User* for over a year now. It has always been an excellent publication and with the new printing format it's near perfect.

I say 'near perfect' because one thing is driving me mad! You keep on referring to Electron as an ELK (ugh!).

What idiot made that name up? It brings Acorn down to Sinclair standards. It even sounds like a Sinclair add-on!

So please, please help me keep my sanity. Call the Electron an Electron.

Jason Cann
Cardiff

Odd character

Sir, Congratulations on the recent improvements to *Acorn User*. I have a frustrating problem which I wonder if you could solve. What does '*' do! No error message is given and the filing system is not accessed.

Clive Maidment
Middx

The '*' character has a special meaning to the operating system. 'A' represents control A, 'B' represents control B and so on. Its main use is to allow the placing of control codes in a function key definition, notably 'M' representing a carriage return. It can be used with all the operating system commands, so a file can be saved with the name ':L' (clear screen code) resulting in the screen being cleared each time you get a directory.

The particular code you mention doesn't really do anything as it is incomplete.

Third 'first'

Sir, I am writing in response to a news item that appeared on page 22 in the May edition of *Acorn User*. The headline read 'Salamander first with m/c compiler', but I rather doubt that this is true. Jeremy Ruston produced a compiler that was marketed in 1983, and in Janu-

ary of this year we marketed a compiler written by Simon Parker. Our compiler comes on cassette for £17.95 or disc for £19.95, and is advertised in your magazine every two months. More than 50 BBC Basic keywords are catered for.

So it would appear that Salamander's compiler was in fact the third.

M Towle
ACK Data
21 Salcombe Drive
Nottingham
NG5 8JF

Keyboard query

Sir, I have three questions on BBC Basic. First, how do you clear the keyboard buffer? Second, how do you mix colours in user-defined graphics? Finally, what is the teletext control code for separated graphics, as in the title page on Acornsoft's programs for the BBC micro?

Timothy Lennon
Somerset

Here come the replies, in order. *FX15,0 will clear all the internal buffers, and *FX21,0 flushes the keyboard buffer. Further information on these calls can be found in chapter 42 of the BBC and Electron user guides, and in the *Advanced User Guide*.

In the September issue, Harry Sinclair showed how to produce full colour sprites. Also if you are printing at the graphics cursor (after VDU 5) then only points that are in the foreground colour are plotted, those pixels which are in the background colour are not so colours can be mixed by printing at the same position with different characters in different colours.

Finally, the teletext code for separated graphics is 154; it is turned off by code 153. All the teletext control codes are in the BBC User Guide on pages 486 to 489.

Unilab contact

Sir, I have already written in for details of the weather satellite project in August's magazine, but could you please let me have an address for information on the Unilab computer interface.

Jason Bryant
Gwent

The address for Unilab is: Clarendon Rd, Blackburn BB1 9TA.

Latest round-up of games high scores

Aviator	Acornsoft	450	Mark Bradshaw
Android Attack	Computer Concepts	602,590	Stephen Green
Arcadians	Acornsoft	48,760	Gerard Mulholland
Battletank	Superior	16,320	Damon Futter
Chuckie Egg	A&F	1,997,800	Gerard Mulholland
Crazy Painter	Acornsoft	13,700	Derek McDowell
Cybertron	Micro Power	26,460	Mark Bradshaw
Mission			
Fortress	Pace	87,000	Damon Futter
Free Fall	Acornsoft	1,188	Owain Griffiths
JCB Digger	Acornsoft	52,000	Owain Griffiths
Killer Gorilla	Micro Power	63,900	Mark Bradshaw
Meteors	Acornsoft	73,220	Robert Hirskeyj
Missile	Gemini	25,905	Mark Bradshaw
Command			
Monsters	Acornsoft	19,270	Owain Griffiths
Moonraider	Micro Power	320,000	Damon Futter
Overdrive	Superior	102,560	Daryl McClure
(BBC)			
Overdrive	Superior	707,010	Gerard Mulholland
(Electron)			
Painter	A&F	104,820	Mark Bradshaw
Pengo	Watford	173,000	Damon Futter
Planetoids	Acornsoft	488,900	Robert Hirskeyj
Rocket Raid	Acornsoft	61,560	Robert Hirskeyj
Snapper	Acornsoft	168,970	Mark Bradshaw
Space	Virgin	4,640	Gareth Dykes
Adventure			
Zalaga	Aardvark	171,430	Daryl McClure

Breaking

the barrier

Sir, While playing around at my Beeb I discovered a way of program protection, quite by accident. I typed in:

```
*KEY 10 A$ = GET$;M CLS:M
```

When typed in, any program already in the computer could not be tested and break would cause a 'Bad program' message to appear. I found this very interesting as I had not seen such a simple procedure as this before. I would like to know why this happens.

D Wolff
Llannelli

To understand why this works you must know a little about where the Beeb stores a Basic program and where it stores variables. Normally variables are stored in memory after the end of your program, the value of this location is held in the variable LOMEN.

When the Break key is pressed the old value of LOMEN is lost (OLD resets it), and it is set up with the value &1900, which is where Basic stores your program. So if before you OLD, you set up any variables they will overwrite the beginning of your program. You have programmed the Break key to set up a variable, this corrupts the beginning of your program, and hence a 'Bad program' error when you try to OLD.

If you only do a CTRL-Break then a program can still be recovered by typing 'OLD'.

Fortress cure

Sir, I had the same problems as your reviewer in running Amcom's *Fortress* (September), namely that, after the first three lives, the machine locks up solid, switching off being the only solution.

The solution turned out to be simple. Once the program is loaded, and *before* the craft is crashed, hit the escape key. This works for myself every time, and was discovered thanks to Reed Photography of Chesham.

ASK a silly question, pass a fair comment, stage an angry protest - we don't mind what you write to us about (or about us!). Keep 'em short, keep 'em sweet, but keep 'em coming! The address is: Letters, Acorn User, Redwood Publishing, 68 Long Acre, London WC2E 9JH.

Whether this is the fault of the machine (an Issue 3 board) or the superbly protected software could be debated until the cows come home. The moral of the story? First, don't panic; second, find someone who has played it before and watch them like a hawk!

Before I get condemned to Mad Alex's dungeon for life, dare I ask when *Acorn User* is going to review Skywave's Multi-Tasking Forth-83?

A Binns
Amersham

Thanks for the tip, and the Skywave review is underway.

Shinwa tip

Sir, I am writing with reference to the multi-tone screen dump presented in the July issue of *Acorn User*, for Epson-type printers. A simple way to alter the program to produce a proportional dump on a Shinwa CP80 printer (provided the occasional lost byte is not important), is to amend the following two lines:

```
180 VDU1,27,75,1,0,1,2  
710.print_bytes 1dx #1
```

Great magazine!

Stephen Wilcock
Bristol

Electron games

Sir, Your Electron readers might like to know about some BBC programs that will run on the Elk. Versions of *Aviator*, *Arcadians*, *3D Bomb Alley*, *Saloon Sally* and *The Mine* all worked when I tested them, although the sound effects aren't as good. Also *3D Bomb Alley*, *Saloon Sally* and *The Mine* are all slower, but in some circumstances *Arcadians* is faster!

Keep producing the magazine by which all others are measured.

N Wright
Lincs

Flashback

Sir, What on earth has the he/she/it silver painted graffiti'd asymmetrical-eyebrowed creature in a government surplus naval gunner's anti-flash hat got to do with computing?

R Taylor
Gwynedd

Kitty explains how to choose software and unravels ROMs



Q I've been very disappointed with some of the programs I've bought. What tips can you give to stop me making the same mistakes again?

Peter Brown
Liverpool

A Buying software is just like buying any product, for example a book, and you should look at the task in the same light.

Personal recommendation is the most reliable method, and then there are reviews. As with book reviews, you will learn to trust some people and magazines more than others. Look out in *Acorn User* for a series of comparative reviews where the major criteria in picking a particular type of software will be considered. We covered monitors in June, and this month it's Basic utility ROMs.

Make sure you know what machine you have (especially if it's an upgraded model A). Don't assume a program will work, and, of course, programs labelled for other types of computers will not work. Although the Beeb and Electron are similar, don't buy Electron software for the BBC and vice-versa, unless the seller can show it works on your machine.

Before you buy, ask for a demonstration in your local dealer's or shop. If they won't help, then go elsewhere. Build up a relationship with a dealer who will often be able to recommend software as he/she gets to know your tastes.

Packaging and documentation will be a good indication of quality and will be important to some people, but not others. Look out for screen shots, which many software houses are showing as standard on cassette boxes. Make sure the company prints an address for return if the program doesn't work, or that the shop will exchange.

Some shops will stock only the best-selling software, and these are usually a safe bet. Remember though that the games market is dictated by youngsters

whose tastes may not be the same as yours - and their reflexes may be a lot better.

Finally, Acornsoft is soon to produce a catalogue of software and products from other companies it recommends. Look out for news in *Acorn User*.

Q Everyone talks about ROMs and firmware, but I bought *Wordwise* and a friend told me it was on an EPROM, and that his View was on a proper ROM. What is the difference?

Helen Phillips
Birmingham

A A ROM (read-only memory) is a chip on which information is stored and cannot be easily wiped out. An EPROM is an erasable/programmable ROM, on which the information can be destroyed if the chip is exposed to ultra-violet light. If you remove the label from the EPROM, you will actually be able to see the silicon chip covered by plastic inside its casing. This means an EPROM can be wiped and then re-used, whereas a ROM cannot.

Acornsoft has put View on ROMs because they are cheaper - but only if they are ordered in very large numbers. Smaller companies use EPROMs because they can be produced in small numbers, giving more flexibility and costing less in the short term. Also, EPROMs can be recalled and exchanged more easily because they are valuable - costing about £8 each. ROMs just have to be thrown away.

The best example of this was Acorn's original 0.1 operating system. This was sent out on EPROM as it was a temporary system, whereas the 1.2 version is in ROM as it will be produced in large numbers over several years.

The term 'firmware' just means a piece of hardware on a chip, such as the BBC's ROMs and the Electron's cartridges.

BBC Microcomputer in the NORTH

CTECH Computers Telephone: 061-366-8223/7794

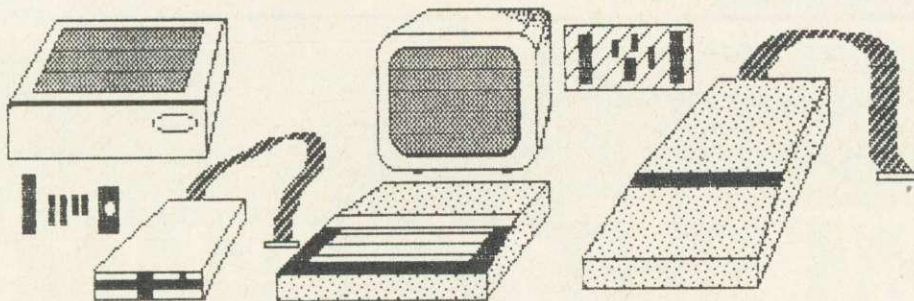

Computers	£ p	Acorn Equipment	£ p
BBC Model B	346.95	6502 2nd Processor	173.04
BBC Model B with DFS	407.82	Z80A 2nd Processor	260.00
BBC Model B with DFS & Econet	439.00	Telextext Adaptor	199.00
BBC Model B with DFS & Wordwise	433.92	Electron Computer	173.04

All computers come with Free Cassette Lead and Software Package. Most add-ons include free fitting and installation.

Monitors	£ p
Philips Hi Res	68.69
Microvitec Normal Res	199.00
Ferguson TX-90 RGB/TV	199.00

Light Pens and Joysticks	£ p
Add on Light Pen	21.70
JMB Full Analogue Joystick	13.00
Joystick Pairs	17.35
Hi-Fi Extension Cable	5.17
Atari-type joystick to BBC interface	13.00

Components and Cables	£ p
We stock everything e.g.:	
2764 Eproms	6.04
27128 Eproms Low	
8271 Eproms	POA
Printer Cables	12.99
Disk Power Cables	8.65

DISKETTES

Boxes of 10 diskettes
 BASF s/s d/d diskettes £13.00
 BASF d/s d/d diskettes £22.90
 XIDEX diskettes £15.22

Addons	£ p
ATPL ROM/RAM board	38.00
Light Pen	21.69
OEL 200 Prestel Terminal	87.39
Acorn Speech Synth	47.83
Chip Chat Speech Synth	26.04
Pace Grapevine	POA

ROM Software	£ p
Wordwise	34.74
Graphics ROM	28.65
Print Master	28.65
View 2.1	52.09
Ultra-Calc	56.48
1.2 O.S.	7.38
Disk Doctor	28.65
BCPL	86.09
Termi	28.65
Commstar	30.39

TEC SHINON
DISK DRIVES FROM £95.00 + VAT
 Bare CHINON FO51D, Slimline, 40 Track, Single Sided. 100K (200K Double Density). As above but complete with Cables, Utility Disk, Cables, Case and Manual. **£109.00 + VAT**
 Bare TEAC55F, Slimline, 40/80 Track, Double Sided 400K (800K at Double Density). **£169.00 + VAT**
 As above but complete with Cables, Utility Disk, Cables, Case and Manual. **£199.00 + VAT**
 TEC Disc Drives from **£109.00 + VAT**

TEC SHINON
DUAL DRIVES FROM £199 + VAT
 Dual CHINON FO51D, Slimline, 40 Track, Single Sided 2 x 100K (2 x 200K Double Density). Complete with Cables, Utility Disk, Cables, Case and Manual. **£369 + VAT**
 Dual TEAC 55F, Slimline, 40/80 Track, Double Sided. 2 x 400K (2 x 800K with Double Density). Complete with Cables, Utility Disk, Cables, Case and Manual. (With your drive you may need an interface). **£389.00 + VAT**

ACORN
DISK INTERFACES FROM £69.00 + VAT
 The Fabulous LVL Single and Double Density Interface. This will allow you to read and write to Acorn Disks see below. But also you can create your own Single OR Double Density Diskettes for extra online storage. Maximum capacity is 1.6 MB with 8 logical drives and 248 files. The standard Acorn Interface is available from us this uses the 8271 disk controller which gives very fast access to disk files. Acorn DFS is the standard for the BBC Micro it allows 31 files per disk and a maximum of 800K on 4 logical drives. **£85.00 + VAT**

CANON NEC QUEN
PRINTERS
 CANON PW 1080A. This is the latest state of the art in printer technology. This machine out performs the EPSON FX80. It will do everything the FX80 does and more besides and using the same control codes! What makes the PW1080A so special is not only its superb value for money but the near LETTER QUALITY mode. We include a free screen dump and our BBC Micro Instructions as well as the excellent manual. **£259 + VAT**
 QUEN 5100 Daisywheel. This British assembled printer has all the features that you would expect like Auto Bold, Auto Underline. Sheet Feeder option. Take Qume daisywheels and Ribbons. 20Cps Bi Directional. **£299 + VAT**
 NEC PC-8023N Dot Matrix Printer
 Bi-directional (120 cps), tractor and friction bed. **£199.00 + VAT**
 QUEN DATA Dot Matrix Printer—British assembled **£173.04 + VAT**

PRICES ...
 All our prices are constantly moving, so please ring us to check the latest price.
All prices plus VAT

FREE DELIVERY TODAY
(Orders over £90)
ASK ABOUT OUR INSTALLATION SERVICE
 If you are in Greater Manchester, Cheshire, Lancashire, Midlands, Merseyside, West Yorkshire or South Yorkshire, if you ring us now we can send one of our highly trained staff to install your computer equipment today.
(Now for business software too!)

C ★ TECH
COMPUTERS
184 Market Street,
Hyde, Cheshire
SK14 1EX
061-366 7794
061-366 8223

TO PHILIP GIBBS: Examine in detail all the Editor Assemblers, all the disassemblers and all the Monitors for the BBC Micro; choose their very best features - improve upon them then; add any other feature required to create the finest combined machine language programming utility on the market...

He did just that—producing the Kansas

EDITOR ASSEMBLER MONITOR AND DEBUGGER (Kmon)

The only Monitor with both the normal Single-Pass
AND a unique Two-Pass Assembler

In addition to interacting with the rest of the program, this Two-Pass Assembler stores the source code in a compressed format, which enables much larger programs to be assembled in memory at once, with the listing all neatly tabulated (in colour) with the minimum of memory usage. Another advantage over such as Beebug's Exmon and Watford's Beebmon is that KMON allows full disassembler labelling facilities. Neither of which have the important Two-Pass Assembler, as doesn't the Molimerx Micromon, which just does not rate.

Our normal return first class post service applies with orders despatched the same day if on credit card before 4pm.

This program also carries our full guarantee.

Remember, we are the longest established software publishers in the business...

UPGRADE to Kmon

As many people may wish to have all the facilities of Kmon

we will allow £8 on your Beebmon Exmon or Micromon in part exchange

**As well as the Two-Pass Assembler
and Disassembler labelling facilities there are over THIRTY Commands...**

Two-pass Assemble
Single-pass Assemble
Disassemble
Edit Memory
Examine Memory
Word Search
Byte Search
Relocate Program
Move Block
Compare Block
Insert to Source Code

Fill Memory Block
Overwrite Line
Pseudo-ops
Set Breakpoint
Clear Breakpoint
Display Breakpoint Table
Set Variable
Display Variable
Move User Table
Display User Table Extent
SPC Count

JSR to Address
List Source Code
Hexadecimal Dump
Select Printer
Delete Label
Kill Source Code
Select Paged ROM
Set Scrolling Speed
Save to Disk/Tape
Load from Disk/Tape

Supplied on ROM, KMON comes complete with a most extensive User Guide, which starts with a tutorial introduction to the use of the program, with detailed examples of the commands. This is followed by a reference section giving further details. This User Guide is extremely well written and could be easily understood by the beginner to machine language.

KMON is valuable to both beginners and the experienced machine code programmer since its use provides an excellent introduction to the use of assembly language, whilst the Two-Pass Assembler allows the experienced programmer to develop much larger machine code programs than the BBC assembler or other Monitors allow. The use of the KMON assembler also facilitates easier debugging than a separate assembler and monitor.

POWERFUL Relocator—anywhere in memory. Wide range of pseudo-ops, ORG, MEM, DFW, etc. Versatile editing facilities, can be altered by instruction RTS, LDA, etc., hex, decimal or Ascii. Source code stored in memory so available to cassette as well as disk users. Assembler will not allow you to overwrite—idiot proof!

KMON contains a full Disassembler with all O.S. calls labelled, vectors between &200 - &2FF correctly disassembled and user defined labels automatically substituted.

LABELS can be defined, erased and altered at any time. The two-Pass Assembler automatically accesses and alters user labels. Labels can be used instead of numbers in ALL Monitor functions. Numbers and addresses can be hex, decimal or a label (or Ascii). There is a full Breakpoint handler. Etc., etc., etc., etc...

Kansas

Supplied on ROM for the BBC model B at £34 all inclusive

Kansas City Systems, Unit 3, Sutton Springs Wood, Chesterfield, S44 5XF. Tel 0246 850357

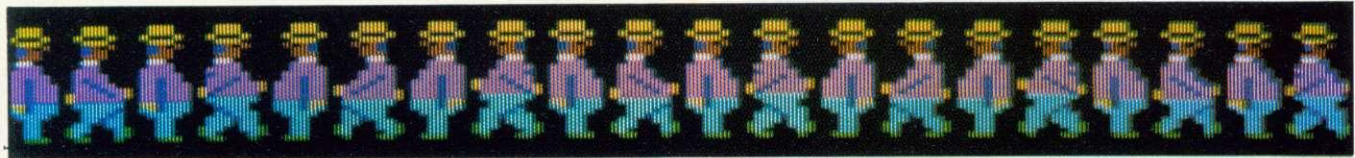

FATMAN ON THE MOVE

Harry Sinclair shows you how to animate your character

LAST month I presented a program that enables you to design multi-coloured mode 2 'sprites'. As promised, this month's article introduces a program which allows you to move your creations around the screen smoothly without disturbing any background, maintaining their original colours at all times. Not only that! If you want you can have cartoon-style animation.

You don't have to understand exactly what is going on, but it helps you to know the general picture, especially for the animation part.

Apart from its obvious job, last month's program performs three main functions:

- It organises your data into easily usable blocks.

- It sets up a table containing the start address of the data for each of your sprites and saves it with the rest of the data.
- It saves information about the width of your sprites so that this month's *Mover* program automatically knows how big to draw them.

The importance of these three things is that the *Mover* program can quickly put your data on the screen just by knowing which character you want to display and where you want to display it. If you aren't particularly interested in the details of how the program works, all you need to know is:

- It should be typed in and subsequently **LOAD**ed with **PAGE** set at &1900.
- You must save it before you run it.

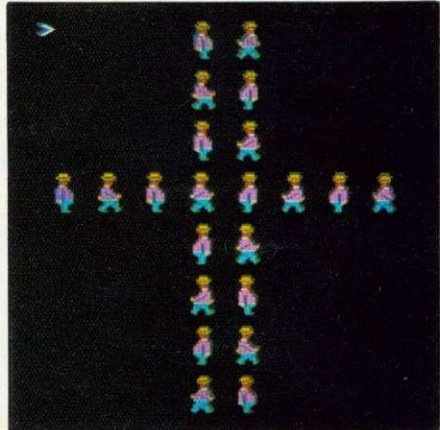

Fatman can be moved to any position on the screen

- When you want to move a set of characters around, ***LOAD** them first and then run the *Mover* program.

MOVING RIGHT SEQUENCE

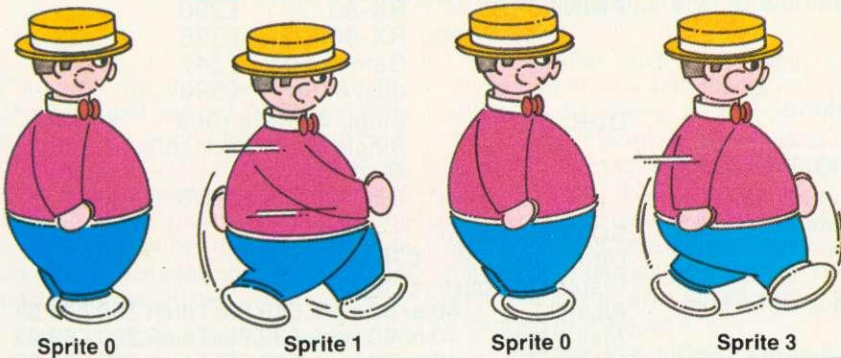

MOVING LEFT SEQUENCE



The animation sequence for walking Fatman in both directions, left and right. It takes six sprites, two being repeated

As I explained last month, the designer program allows six sprites to be defined at a time but it regards them as being 8. Sprites 0 and 2 are the same, as are sprites 4 and 6. This means that if you ran through them in sequence you would get sprites 0, 1, 0, 3, 4, 5, 4, 7.

In other words, if you want to produce animation effects—say, of a man walking right to left—sprite 0 should be of a man standing feet-together facing right. Sprite 1 would be man with left leg forward, right leg back, sprite 3, right leg forward, left leg back. That completes the moving right sequence. The moving left sequence is the same but with the man facing the other way. (I'm not sure whether I understand all that. It's a bit like describing Dolly Parton with your hands tied behind your back).

Anyway, when you're designing, you don't have to worry about duplicating sprites 0 and 4—the program does it for you. If you look at the screen shots accompanying this article you'll see

page 67 ▶

Harry Sinclair's 'Mover' program is listed on yellow pages 100 and 101

SPECIAL REDUCTION

**DISC DRIVES FOR
BBC COMPUTERS £129.95**



IBM Authorised Dealer

**BBC
MICRO COMPUTER**



IN STOCK

**6502 + Z80 SECOND
PROCESSOR · BITSTIK**

**WE ARE SPECIALISTS - WITH
OVER 400 ITEMS JUST FOR
BBC/ELECTRON ON
OUR PRICE LIST**

PHONE
BURGESS HILL
(04446)

45636

Ask about our Maintenance Agreement



**michael
Business Systems Ltd**

195 LONDON ROAD BURGESS HILL SUSSEX



PAWS



Each disk holds 1000+ hours of s/w engineering developed from our artwork systems. These programs fully exploit a disk-based BBC to stimulate long-term interest through exploration and experiment.

Prices inclusive. State 40tr or 80tr. £3 off total for 2 programs; £6 off for 3. Add £5 if backup reqd. Special terms for Schools/Colleges needing 3+ copies.

* **JIGSAW PICTURE & WORD PUZZLES (2 programs): £14.50**
JSPP takes any mode - 2 picture, 3 pictures supplied
JSWP has fun-to-use word-puzzle creator/editor
Random jumbles, 12 levels: toddler to top puzzler
Four sliding & teleporting cursor options
Helps: Tidy/Re-jumble keys, Save/Reload

* **TEX and PAM (2 programs): £14.50**
TEX creates/modifies/animates mode-7 pictures
Output options: spool, *save, *save 5 pic sequence
PAM runs TEX o/p as animated-film/slides/news-reel

Timed frames, Inner loops, 13 TV-type smart wipes
Shop/exhib users: please ask about pricing version

* **MUSIC MAESTRO (synth for non-musicians): £12.50**
Design pleasant/weird sound envelopes, MM autodraws
Play: 4oct, 8std + ownenvs, chords, arpeggios, loops
Record/edit/replay. Add rhythm after melody



Cheques/PO with order to:
**Promotional ArtWork Systems
9 Mayo Cl, Leeds 8 LS8 2PX**



BBC DUAL DISC PAYROLL PROGRAM

For 150 employees with 100K disc using random access operation.

Calculates most tax codes and national insurance rates.
Calculates up to 24 fixed deductions per employee including employer's and employee's pension contribution and S.S.P.

Prints payslips, cheques and cheque list.

Has coin and note analysis.

Has a complete end of year routine for tax returns.

BBC B DISC MAIL MERGE PROGRAM

Produces personalised versions of a standard letter by merging names and addresses held on a data disc with a standard letter produced on Wordwise or Merlinscribe word processors.

Prints letters, envelopes, two abreast labels and the complete file including telephone numbers.

Comprehensive facility for selecting and printing using any user definable criteria.

BBC B DISC MAILING LIST PROGRAM

Stores up to 350 names and addresses per 40 track disc or 700 per 80 track disc.

Incorporates comprehensive search facilities for selective printing of labels, envelopes and letter headings.

MICROS

BBC B £380 + DFS £460
Electron £199
Spectrum £125

MONITOR

Colour/Green Novex 1414 £220
Green Sanyo DM2112 £77

PRINTERS

RX-80 £290
RX-80 F/T £325
Gemini 10X £247
Juki 6100 £390.

DISC DRIVE

Single 40 track 100K £170
Single 40/80 track 100K £299
Dual 40 track £350
Dual 40/80 track DS £560

SOFTWARE

Ultra-Calc £78.00
Clares Database £26.00
Payroll :- 40 or 80 track £49.95; Torch Z80 £74.95
Mail merge :- 40 or 80 track £39.95; Torch Z80 £69.95
Mailing list :- 40 or 80 track £19.95; Torch Z80 £29.95
Carriage 50p.

Discs from £19.95, cassettes from £0.55 and joysticks from £17.50, leads from £2.50.

Just arrived hard covers for all micros.

Business systems customised to individual needs such as word processing, payroll, employment agencies and chemist.

All prices inc VAT. Postage extra.

SEND ORDERS TO

CYB COMPUTERS

**9 Crown Parade, Crown Lane, Morden,
Surrey SM4 5DA. 01 542 7662.**

WE ARE A FEW YARDS FROM MORDEN UNDERGROUND STATION



how Fatman is organised. He is eight pixels (four bytes) wide.

If you select the animation option, *Mover* runs through the sprite sequence 0-3 when the cursor right key is pressed and 4-7 when the cursor left is pressed. Up cursor and down cursor just move the currently displayed sprite in the appropriate direction. The key detect routine can tell if two keys are pressed at the same time, so you can give your sprites a headache if you're feeling evil.

That's all you need to know if you want to start typing. Incidentally, if you don't want to type it all in at once just stop when you're cheesed off and save what you've done. Then, suitably uncheesed, load the program, list it then type AUTO XXX where XXX is a number 10 higher than the last one. You can then carry on.

Right, now for the tricky bit - full screen addressing.

A mode 2 screen is composed of 32 (0-31) horizontal 'strips', each eight bytes deep and 80 bytes wide. Type in the following short program.

```
10 *TV255
20 MODE 2
30 screenstart = &3000
40 FOR I% = 0 TO 31
50 S% = screenstart + I%*640
60 IF NOT I% MOD 2 C% =
  &03030303 ELSE C% =
  &3F3F3F3F
70 FOR J% = 0 TO 639 STEP 4
80 J%!S% = C%
90 NEXT
100 NEXT
```

When you run this you will see the screen divided into red strips and white strips - 16 of each. Every strip represents 8 deep by 80 wide = 640 (&280) bytes. Screen memory in mode 2 starts at &3000. If you pick a location on the screen - say third down, 20th byte across within the fourth strip, you know that its address will be:

&3000 + (&280 * the number of complete strips above your chosen location - in this case 3) + (8 * 19) + 2

If you're puzzled as to why the last part of this equation is not (8 * 20) + 3, remember that numbering starts at 0, not 1. So the third byte down in a column is in position 2, and the 20th across in position 19.

Y co-ordinate DIV 8 * 640	= +	&3000	start of screen
X co-ordinate * 8	= +	&780	3 * &280
Y co-ordinate MOD 8	= +	&88	19 * 8
		2	
	=	&380A	

Figure 1.

To complete the example, the final address is shown in figure 1.

If you add an extra line to the above program:

110 ?&380A = 0

this will make that particular location black.

So calculating screen addresses is not very difficult. The only problem is that if you're using this method to draw a character to the screen and the character is 24 bytes deep and four bytes wide, the calculation has to be done 96 times - pretty time-consuming. Another way of doing it is to calculate the address of each of the leftmost bytes.

Let's take the above address as an example - &380A. The address of the location immediately to the right of that is just eight higher - &3812 - and the one next to that is eight higher again - &381A. Add the following line to your program:

120 ?&3812 = &F:?&381A = &30

When you run it you will have three bytes in a row in strip 4 - the first black, the second yellow and the third blue.

Calculating the left-hand address and then adding eight to it to get the next one is a bit more efficient, but not much. There are a few variations on this method but they all require a fair amount of calculation, and micro-processors, oddly enough, were not designed to perform arithmetic operations - logical operations are their forté.

Yet another way of doing it is by using a bit of lateral thinking. Say your sprite is 24 bytes deep - it doesn't matter how wide it is. This means that its depth is equal to that of three of the screen strips. If your sprite is to be drawn starting exactly at the top of one strip it will finish exactly at the bottom of the next-but-one strip beneath it. Bytes within a strip are consecutive and arranged as in figure 2.

As you can see, all we have to do is calculate the addresses of A, B and C. If the sprite is four bytes wide - 32 bytes in each strip - we can send our data to three lots of 32 consecutive addresses starting at A, B and C respectively, using the Y or X registers of the 6502 to increment the address relatively. This has the added advantage of not actually changing the base address. In

STRIP 1	A	A+8	A+16	
	A+1	A+9	A+17	
	A+2	A+10	A+18	
	A+3	A+11	A+19	
	A+4	A+12	A+20	
	A+5	A+13	A+21	
	A+6	A+14	A+22	
	A+7	A+15	A+23	
STRIP 2	B	B+8	B+16	etc
	B+1	B+9	B+17	
	B+2	B+10	B+18	
	B+3	B+11	B+19	
	B+4	B+12	B+20	
	B+5	B+13	B+21	
	B+6	B+14	B+22	
	B+7	B+15	B+23	
STRIP 3	C	C+8	C+16	
	C+1	C+9	C+17	
	C+2	C+10	C+18	
	C+3	C+11	C+19	
	C+4	C+12	C+20	
	C+5	C+13	C+21	
	C+6	C+14	C+22	
	C+7	C+15	C+23	

Figure 2. How bytes are arranged within a strip

fact it's even easier than that. Since each strip contains 640 bytes, address B = address A + 640 and address C = address B + 640, so we can generate addresses B and C by simple addition.

Well, that's fine for sprites that start exactly at the top of a strip, but what about ones that start within a strip?

Consider our 24-byte deep sprite. If it starts at the top of a strip it will appear in three strips. If it starts within a strip, parts of it will appear in four strips. We need one extra address - the top of strip 4 - which we get by adding another 640. All we have to do now is ensure that we write only to the bytes we want to.

The exact start point of a sprite within a strip is easy to calculate. Remember that the vertical axis (Y) has 256 possible values - 0 to 255. Y MOD 8 or Y AND 7 give the remainder of Y divided by eight - the start position. If this is subtracted from eight the result is the

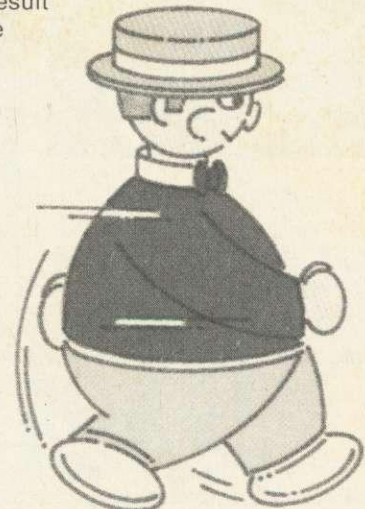

YOUR MOVE...

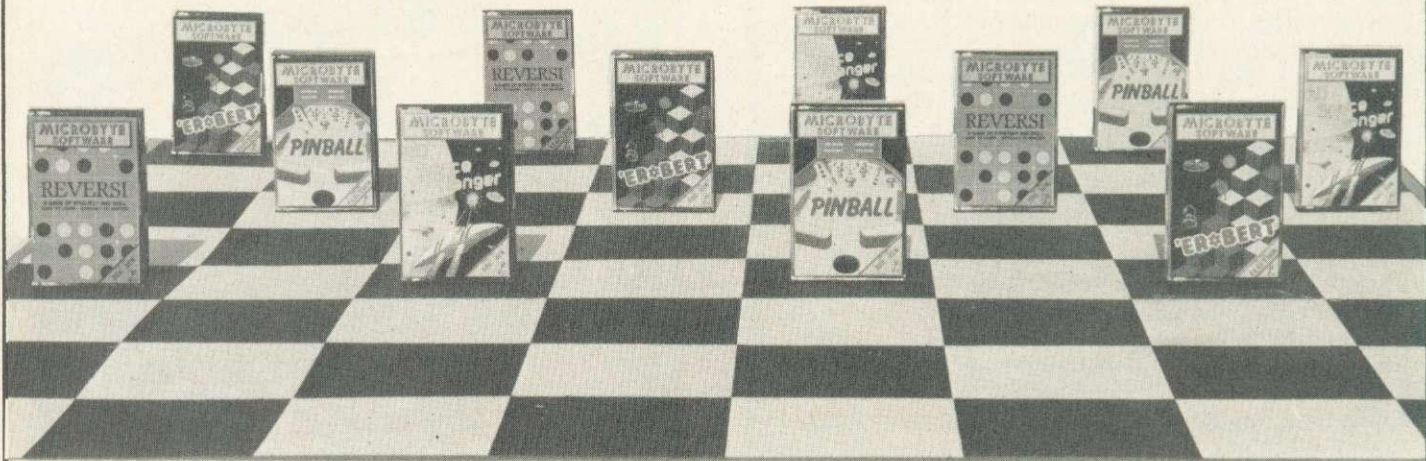

TAKE A PIECE OF OUR SOFTWARE!

SUPER GAMES

ONLY
£4.95
 INC VAT
 &
 p+p

SUPER VALUE

ERBERT

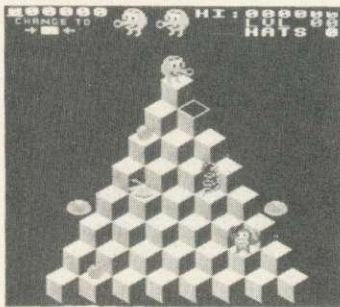

Electron & BBC 32K
 Join Erbert in his cubic domain—fast and funny. Avoid his unwelcome guests. Many features—alternative screen displays—addictive!

Machine code game.

3D SPACE RANGER

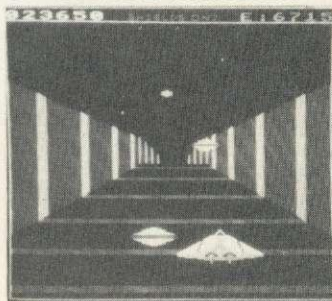

BBC 32K (O.S. 1.0 or 1.2.)
 Excellent 3D graphics four different scenes. Battle to the death star and destroy it.

Machine code game.

PINBALL

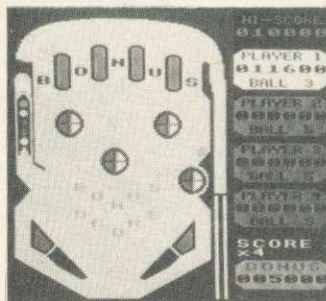

Electron & BBC 32K
 The classic arcade game up to four players with bonus features.

Machine code game.

REVERSI

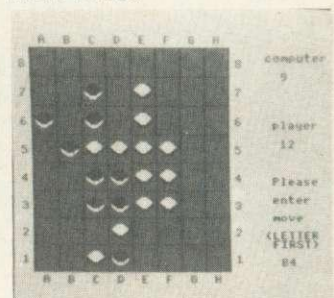

Electron & BBC 32K
 A game of strategy and skill—2 levels

MICROBYTE SOFTWARE

Games available now at many computer shops—or by fast mail order from Microbyte Software. S.A.E. for illustrated brochure. Trade enquiries welcome. Access 24 hour hot line 06373 6886.

Microbyte Software (Dept. A10)
 18 Hilgrove Road, Newquay, Cornwall TR7 2QZ

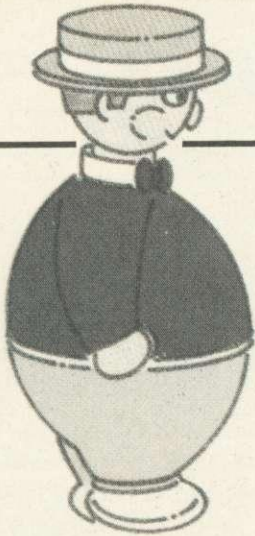

number of bytes in each column in strip 1 that should be written to, and the number of bytes in each column in strip 4 that should *not* be written to. In the program, this value is put into the X register each time a new column is to be drawn and is decremented each time a set of bytes (one to each strip) is sent. While X is positive, bytes will be written to strip 1 and not to strip 4. When X is negative the reverse is true. The value is also used to control the (negative) offset into the sprite data tables.

The only other thing you have to do is to ensure that other characters on the screen are not rubbed out as your sprite is moved about. A common way of doing this is to use what is called EOR (Exclusive OR) plotting. EOR is one of the logical operators and is very simple. If you EOR K with J to give you N, when you then EOR N with K you will get J, or if you EOR N with J you will get K. EOR works by taking two binary numbers and comparing pairs of bits. Each bit in no. 1 is compared with the corresponding bit no. 2.

If either (but not both) of the bits is set—ie = 1—the corresponding bit in the result is set. If both or neither of the pair is set, the result bit is zero—eg:

$$\begin{array}{r} 6 \text{ EOR } 3 = 5 \\ 6 = 0000110 \\ 3 = 0000011 \\ \hline \text{Result} = 0000101 = 5 \end{array}$$

$$\begin{array}{r} 6 \text{ EOR } 5 = 3 \\ 6 = 0000110 \\ 5 = 0000101 \\ \hline \text{Result} = 0000011 = 3 \end{array}$$

$$\begin{array}{r} 3 \text{ EOR } 5 = 6 \\ 3 = 0000011 \\ 5 = 0000101 \\ \hline \text{Result} = 0000110 = 6 \end{array}$$

So if you take the value (V) you want to write to a screen byte and EOR it with the value already there (S), you will get a new value (N)—and unfortunately a new colour unless the value already there is 0. When you want to move your sprite to a new position and replace the background you just repeat the operation. EOR V with the screen byte (now N) and you get the original screen byte S. On screens that are mainly black this is a very effective method.

The method I have used is different. Before any screen byte has a new value written to it, its original value is stored. The original values are written back before the sprite is drawn in a new position. This way your sprite's colourings are maintained at all times and there is absolutely no disturbance of any background.

Two other parts of the program may interest you—speed control and the keypress-detect routine.

Speed control is achieved by the use of an interrupt routine. The vertical sync. pulse event is enabled by the equivalent of *FX 14.4. This generates an interrupt every fiftieth of a second as the screen is about to be refreshed, and control is passed to a user routine whose address is contained in locations &220 and &221—the event vector. All this routine does is decrement location &77. When you run the program you are asked what delay factor you want to use. When the sprite is about to be written to the screen the delay routine is executed the number of times you have specified. The routine loads the contents of &77 into the

accumulator and then continues to compare the accumulator with the current contents of location &77 until they are different—ie the vertical sync. pulse event has occurred.

The key detect routine, which is very fast—it should only take 12 machine cycles out of 2 million per second to discover that no key has been pressed—examines locations &EC and &ED in the operating system workspace. If one key is being pressed, location &EC contains its internal key number + 128 and &ED contains 0. If two keys are being pressed location &EC will now contain the internal number of the *second* key pressed + 128 and &ED will contain the internal number + 128 of the *first* key pressed. If no keys are being pressed both locations contain zero. You may like to modify the routine for your own purposes.

Internal numbers are with very few exceptions easily generated from the negative INKEY numbers. Take the negative number, reverse the sign, and add 1. For instance, if you wanted to test for 'A' being pressed, in Basic you would use INKEY (-66). The internal number would be 65, coincidentally the ASCII code for 'A'. To use my routine you would check for 193 (65 + 128). Negative INKEY numbers are given on page 275 of the *User Guide*. The *Advanced User Guide* also gives the internal key numbers.

Well, I hope this has given you some ideas and that you get a bit of fun out of the two graphics programs. Next month I will give you some modifications for the *Design* program that allow you to edit previously designed sprites and produce mirror images so you only have to design your animation characters facing one way. I will also give you a procedure that will take the data for a sprite, shift it all over by one pixel and store the new image. You will then be able to move your sprites very smoothly—one pixel at a time—by alternating the images.

MOVER PROGRAM DESCRIPTION

20 If you want your sprite data to autoload make this line *LOAD followed by whatever you called your sprites.

80 to 120 Check to see if animation is required and set the flag (&74) accordingly. The machine code checks this location and if it is set it ensures that sprites are displayed in the sequence 0, 1, 2, 3 when moving right and 4, 5, 6, 7 moving left.

130 If animation not required and only one sprite is to be displayed, which one?

160 Gets the delay factor—see text.

170 to 210 Instructions.

240 Sets screen background.

250 to 270 Set control variables.

280 Calls routine to point EVENTvector to program interrupt routine.

290 Displays sprite for the first time.

300 Enters the main program.

310 Cleans up when Basic re-entered.

370 to 490 Leftpressed. Decrement X axis value unless it is already zero. Check if animation required—if so it sets left flag and gets next character in the sprite sequence from 'animation'. Pass control to *Mover*, which operates the delay mechanism and calls the display routine.

500 to 610 Rightpressed. Increment X axis value unless it is already 80—width of sprite (contents of &7A). Other actions as above.

620 to 760 Downpressed/up-pressed. Control Y axis value in similar manner except animation not used.

Where appropriate the above routines are called by the key detect routine, 'keycheck'.

page 70 ►

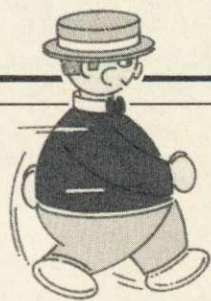

MOVER PROGRAM DESCRIPTION (cont)

70

770 to 910 Animation. Test the left/right flag (&75). If right has been pressed the X axis value is ANDed with 3 to give a sprite number in the range 0-3. If left has been pressed, 4 is added to make the range 4-7. Since the X axis is increased or decreased only by 1 at a time this routine is always able to pass the next sprite number in sequence to the display routines.

920 to 1040 Mover. If no delay is required &76 will be negative so the delay routine is skipped. Delay (see accompanying text).

1050 to 1090 Nv. This is the vertical sync. pulse event routine which decrements &77 each time the event occurs.

1110 to 1490 Cv. Change contents of the event vector at &220/&221 to point to above routine. Store old contents so they can be restored when Escape is pressed to give orderly return to Basic – not strictly necessary in this case but good practice. Also enable the vertical sync. pulse event. Set variable offset into data tables. Calculate maximum allowable X axis value given the width of the sprite, and store this in &7A. This enables use of variable-width sprites from designer program. The storage area for screen background is set up by inserting addresses based on the size of the sprite into the address fields in the 'replace' routine (see below).

1500 to 1740 Start. Put addresses of control routines into table so they can be accessed quickly by the keypress detect routine.

1750 to 1890 Keycheck. Executive section of program from which all other control routines are accessed. Arranged as an infinite loop which can only be exited by pressing Escape. See text.

1900 to 2180 Keyvalid. If a 'valid' key has been pressed (ie any of the cursor control keys or Escape) an appropriate value is returned in the accumulator. In the case of Escape being pressed, the return address of the routine calling keyvalid is pulled off the stack and a jump is made to the escape routine. This ends with RTS so with no

other address to return to control is passed back to Basic. See text for explanation of values tested.

2190 to 2270 Getaddress. The value returned in the accumulator by 'keyvalid', if non-zero, is multiplied by 2 and transferred to the Y register, which is then used to get the address of the appropriate control routine. This address is inserted in place of the dummy operand in 'gotomover', which is then called by the main control section.

2310 to 2410 Escape. Replaces original contents of the event vector, flushes the keyboard buffer and returns to Basic.

2420 to 2450 Tbl. Storage area for addresses of the up/down/right/left control routines. Those with Basic 2 can replace NOP with EQU etc to define zero bytes, but it isn't necessary. Note that 10 bytes are needed since the first two bytes cannot be accessed by 'getaddress'.

2460 to 2470 Olv. Two-byte storage area for original contents of event vector.

2480 Display. Loads Y register with number of bytes to be written to each strip, contained in &78.

2510 to 2640 Replace. Return the original contents of screen memory to location where last sprite has been drawn – ie delete it before drawing sprite in new position. The low bytes of the storage addresses are dummies and vary according to the width of the sprite.

2650 First. When a sprite is first drawn it is unnecessary to call 'replace' since there is nothing to replace, so the drawing routine is entered here. The start addresses of the strips are calculated and the calculation is simplified a little by accessing the *640 table in the OS ROM starting at &3C75. Start addresses of the sprite data are obtained from the table at &12F0 (lines 3270 and 3440), are modified by the offset contained in &73 and inserted into their zero page locations (&88 onwards).

3520 Loads Y register with the number of bytes to be written to each strip.

3530 to 3540 X register set up to control writing.

3550 Start of the main drawing routine.

3850 to 4170 Sh. This is what actually puts your sprites on the screen and also what saves the background. The low byte of all addresses shown as &C00 is a dummy which is changed by the routine 'cv' above, to accommodate sprites of different sizes. The sections that write to the separate strips are 'b2', 'b3' etc.

ZERO PAGE LOCATIONS USED

&70 = Number of sprite to be displayed.
 &71 = X axis value – 0 to 79.
 &72 = Y axis value – 0 to 255.
 &73 = Y MOD 8 at first then 8 – (Y MOD 8) + 1 to control display routine.
 &74 = Animation flag. 0 = no animation
 1 = animation.
 &75 = Left/right flag if animation selected
 1 = leftpressed 0 = rightpressed.
 &76 = Number of vertical sync. pulse interrupts to occur before sprite is drawn to the screen = delay factor – 1, so negative (&FF) if no delay required.
 &77 = Used to sense if vertical sync. pulse has occurred. Is decremented at each such interrupt.
 &78 = Width of sprite in bytes * 8 = block size.

&79 = (Width of sprite * 8) – 8 = additional offset into sprite data tables.
 &7A = Maximum X axis value allowable (80 – width of sprite in bytes).
 &80/&81 Start screen address for strip 1.
 &82/&83 " " " " " 2.
 &84/&85 " " " " " 3.
 &86/&87 " " " " " 4.
 &88/&89 Start address of sprite data for strip 1.
 &8A/&8B " " " " " " 2.
 &8C/&8D " " " " " " 3.
 &8E/&8F " " " " " " 4.

*&12EF is part of the sprite data tables and contains the number of bytes in each block = 8 * width (in bytes – not pixels).*

M I C R O P O W E R M I C R O P O W E R M I C R O P O W E R M

\$wag

B.B.C. MICRO electron

A two player game of dexterity set in Hazard County. Beat your opponent to the jewels and gold with the help of your band of cronies. Includes police cars and one player practise option.

(BBC version: joystick & keyboard control).
Cassette: £6.95.
Disk: £9.95.

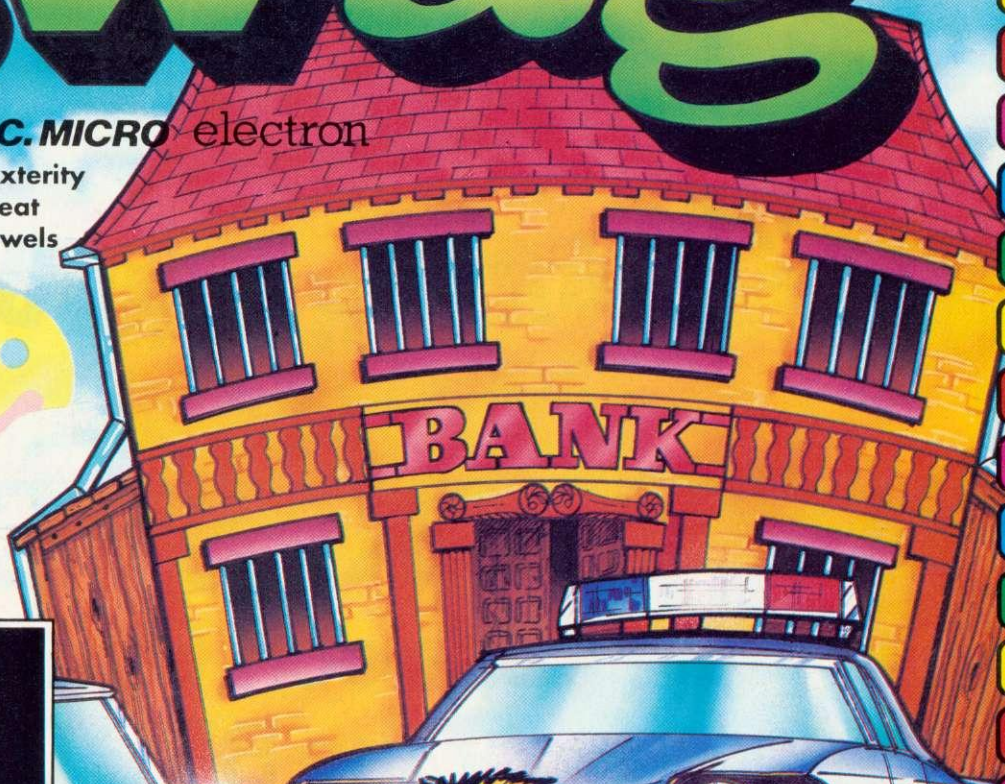
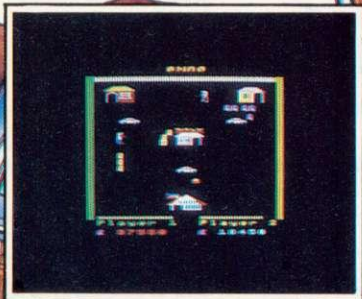

"WATCH OUT FOR THE FANTASTIC NEW PACKAGING!!"

MICRO POWER LTD.,
NORTHWOOD HOUSE, NORTH STREET,
LEEDS LS7 2AA TEL: (0532) 458800
MICRO POWER SOFTWARE IS AVAILABLE FROM
SELECTED BRANCHES OF WH SMITH, BOOTS, JOHN
MENZIES, CO-OP, WOOLWORTHS AND ALL GOOD
DEALERS.
AUTHORS! WE PAY 20% ROYALTIES!



MICRO
POWER

M I C R O P O W E R M I C R O P O W E R M I C R O P O W E R M

£24.⁹⁵

PRICE BREAKTHROUGH

BBC SPEECH

Speech Synthesizer for the BBC Computer



- Totally unlimited vocabulary is now possible with the revolutionary "SWEET TALKER" Speech Synthesizer for the B.B.C. A or B Microcomputer, any series.
- The CHEETAH "SWEET TALKER" simply plugs into speech socket IC99 within the computer. No soldering, no cutting of tracks, no headaches.
- Based on an allophone system you can easily program any word, sentence or phrase and incorporate speech into your software games.
- Fully tested and guaranteed. Complete with demonstration cassette and full instructions.

Price includes V.A.T.

Postage and Packing

Delivery normally 14 days

Export orders at no extra cost

Dealer enquiries welcome

Send cheque/PO now to -

Cheetah, products available from branches of

John Menzies Boots WHSMITH and Rumbelows

Cheetah

Marketing



Cheetah Marketing Ltd, Dept. A/U 24 Ray Street,
London EC1R 3DJ. Tel: 01 833 4909.
Telex: 8954958.

Organised by
The Micro User
and Electron User

Come to our great pre-Christmas bonanza!



Everyone who is anyone in the exciting world of the BBC Micro and Electron will be at our greatest ever autumn show.

Waiting for you will be more than 150 stands, packed with hardware, software and peripherals – some of which will be on show for the first time.

And everything will be for sale – much of it at really low, show prices!

Once again our team of experts will be on hand to give you free advice – an ideal opportunity to find out all the facts on the latest computing techniques.

Thursday to Sunday, October 25 to 28

Yes, we're back once more at the spacious **ALEXANDRA PALACE**... where there's plenty of room to move around and inspect all the latest micro goodies at your leisure!

This voucher is worth £1 per head

Reduced prices for School/College Groups

Entry only £1 per student if bookings are made in advance. Send your cheque (made payable to Database Publications) and SAE to:

Electron & BBC Micro User Show
68 Chester Road, Hazel Grove,
Stockport SK7 5NY
Tel: 061-456 8383

Valid for a minimum of 10 people

SAVE MONEY with our Special Travel and Hotel Offer

Visitors to the Show can obtain cut-price rail tickets from ANY station in the United Kingdom – plus special reduced prices at London hotels. Write to:

Travel Offer, P.O. Box 1, St. Albans AL1 4ED with SAE or Telephone: St Albans 34475 quoting: The Electron & BBC Micro User Show.



By handing in this voucher at the door you save £1 off the normal admission price of £3 (adults) and £2 (children).

(Valid for a maximum of 4 people)

10am-5pm, Thursday, October 25
10am-5pm, Friday, October 26
10am-5pm, Saturday, October 27
10am-4pm, Sunday, October 28

Alexandra Palace
Wood Green, London N22.

Number attending 1 2 3 4

NEW RELEASES

**BBC
MICRO**

SPECIAL OFFER!

Order both directly from us and deduct £1 from each.

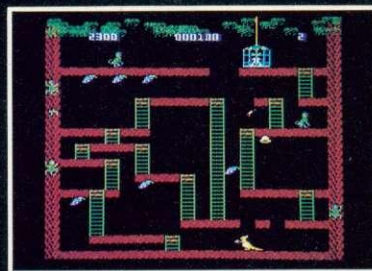
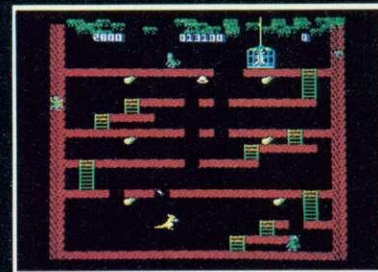
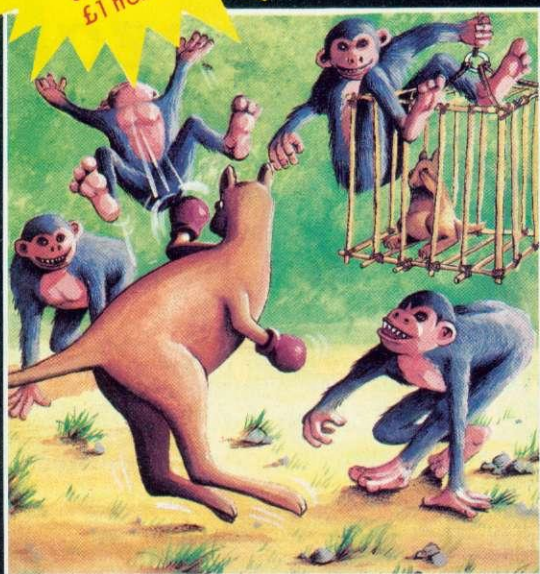

WALLABY (32K)

From the author of Overdrive comes another superb arcade-action game. You must guide Wally the Boxing Wallaby up the ladders to rescue the baby wallaby from its cage. The evil monkeys will try to stop Wally in his tracks; he can kill the monkeys by a swift upper-cut, but watch out for the apple-cores which they hurl at him without compassion. Five screens of increasing difficulty with bonus fruit on each level. Yet another winner from Superior Software!

●●●NEW RELEASE●●●

£7.95



Many of our titles are available in Boots, W.H. Smiths, John Menzies, Rumbelows, Laskys, Currys, HMV, Greens at Debenhams and Spectrum Shops. Also at all major computer dealers - Eltec Computers, Micro Management, West Coast Personal Computers, Microstyle, Electronequip, 3D Computers, Computerama, GTM Computers, etc. Our software is also available through all the major distributors, and directly from us by mail-order.

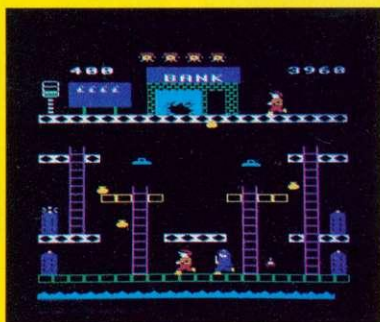

SMASH AND GRAB (32K)

An excellent and original arcade-style game in which you take the role of a robber aiming to snatch bags of gold from the bank. A policeman is after you ... he is able to jump at you or squat down and try to hit you with his truncheon. You must also keep clear of the flying police cones and floating dustbin lids. There are 3 fascinating screens of action including play streets with bouncing balls, one-way streets, conveyor belts, traffic lights and police-boxes. A novel and amusing game.

(KEYBOARD OR JOYSTICKS)

●●●NEW RELEASE●●●

£7.95

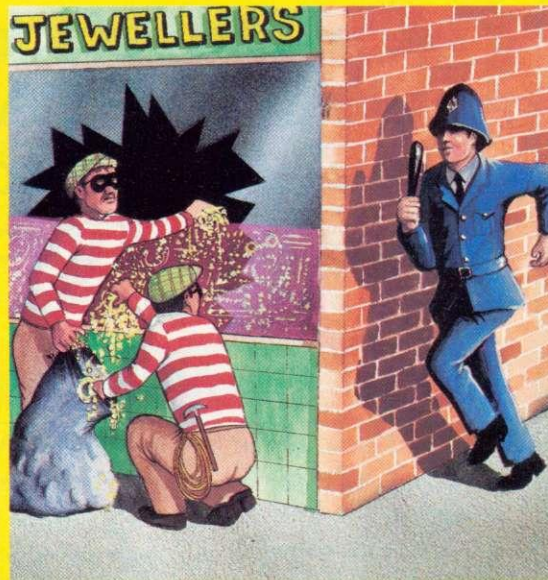

WE PAY UP TO 20% ROYALTIES FOR HIGH QUALITY BBC MICRO AND ELECTRON PROGRAMS.



SUPERIOR SOFTWARE LTD.

Dept. AU10, Regent House,
Skinner Lane, Leeds 7
Tel: 0532 459453

OUR GUARANTEE

- (1) All our software is available before we advertise.
- (2) All our software is despatched within 48 hours by first-class post.
- (3) In the unlikely event that any of our software fails to load, return your cassette to us and we will immediately send a replacement.

SYSTEMS



ADVANCE 86
IBM compatible, 128K RAM,
2 x 320K Drives. Price includes:
Perfect Writer, Perfect Speller,
Perfect Filer and Perfect Calc,
plus 12 months on site warranty
(monitor available at extra cost).

£1437 inc. VAT.

SANYO 555
80% IBM compatible, 128K RAM,
2 x 160K Drives. Price includes: Wordstar,
Mailmerge, Info-Star and Calc-Star.
Limited number of SAGE Accounts still
available.
(Monitor available at extra cost)

£1148 inc. VAT.

Electron £199 inc. VAT.
Includes free software tape

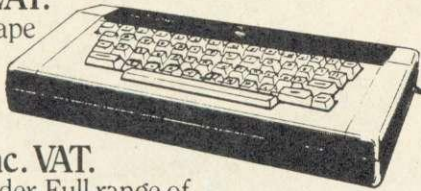

BBC-B from £399 inc. VAT.
Includes free tape recorder. Full range of
Software and Disk Drives available.

PRINTERS

Brother Printers
Juki Daisywheel
Daisystep

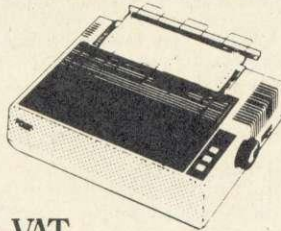

Epson Fx 80
Including lead for BBC. **£399 inc. VAT.**

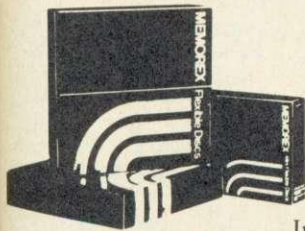

Diskettes

Memorex, in packs of 10
SS 40tk.....£18.00
DS 40tk.....£23.00
SS 80tk.....£26.00
DS 80tk.....£29.00

Including VAT, p&p.

Stay tuned to Microware for further discounts

DRIVES

Epson 400K-200K-800K
plus new 3½" Epson Drives
and 100K Superdrive from

£329 inc. VAT.

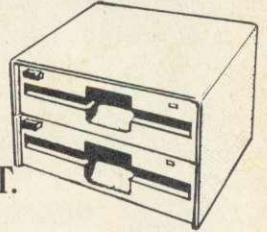

200K

62 file names including cable and power lead.
Send £215 to include VAT, p&p,
inc. formatting disk & manual.

40 Track
Single & Double

400K

124 file names including all necessary leads.
Send £399 to include VAT, p&p,
inc. formatting disk & manual.

80 Track
Single & Double

800K & 800K Switchable

124 file names including cable & power lead.
Send £490 to include VAT, p&p.
Send £499 for 800K Switchable.

MONITORS

Sanyo/BMC **£110 inc. VAT.**

12" amber or green screens.

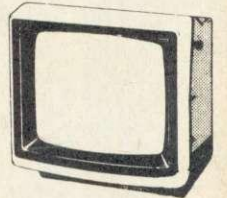

Full range Microvitec colour from £199.
Call for our full price list.

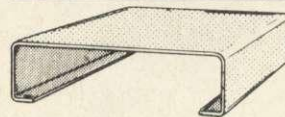

ACCESSORIES

BBC Stands.....£15.00
Dust covers.....£5.60
(for BBC,
Drives and
Printers)

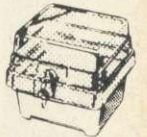

Disk storage boxes.....
£17.00 (takes 35)
Disk storage boxes.....
£25.00 (takes 80)
Prices include VAT, p&p.

Product	Price	Qty.	Total
			£
			£
			£
			£
			£
			£
			£
			£
			£
			£
			£
			£
			£
			£
			£
			£
			£
			£
			£
			£
			£
			£

SEND DETAILS ON

TOTAL SUM ENCLOSED (Cheque or credit card no.) £

ALL PRODUCTS ARE BRAND NEW, BOXED AND OFFERED WITH FULL
MANUFACTURERS WARRANTY. ALL QUERIES WILL BE ANSWERED BY MAIL.

MICROWARE

14 Charles Street Hanley Stoke-on-Trent
(0782) 269 883
44 Westow St. Upper Norwood London SE19
01-771 5123
637 Holloway Road London N19 5SS
01-272 6398

I enclose my order for the above products.

Name _____

Address _____

Signed _____

SCILUK

EPSON LOW PRICE SPECIALS FROM £199.00

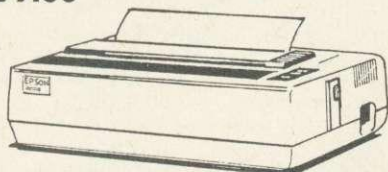

EPSON RX 80	100 cps	£249	£199.00
EPSON RX 80 FT	100 cps	£285	£229.00
EPSON FX 80	160 cps	£428	£324.00 PLUS
EPSON MX 100	100 cps	£475	£369.00 VAT
EPSON RX 100	100 cps	£458	£385.00
EPSON FX 100	160 cps	£569	£499.00

JUKI 6100 — ~~£399~~ **£349.00** + VAT

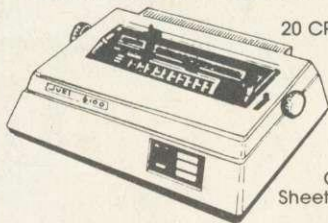

20 CPS: Bidirectional & Logic 10, 12, 15 & Proportional Spacing; Wordstar compatible; 2K Buffer; 13 inch Platen; Underline; backspace & lots more; Centronics Interface Standard. Optional RS232, Tractor and Sheet Feeder

SHINWA CP80 — ~~£299~~ **£179.00** + VAT

Friction and tractor feed as standard. 80cps. Bi-directional logic seeking 13 x 9 dot matrix giving true descenders, sub and superscripts. Italic printing and auto underlining. Condensed, emphasised, expanded and double strike (can be mixed in a line). Parallel interface fitted as standard.



ADMATE DP80 — ~~£229~~ **£169.00** + VAT

The Admate DP-80 has a large range of features and a low price. Ideal for the first time user. 80 cps; 80 column; Bi-directional logic seeking; block and dot addressable graphics; sub/superscript, auto underline, condensed, emphasised, expanded and italic print.

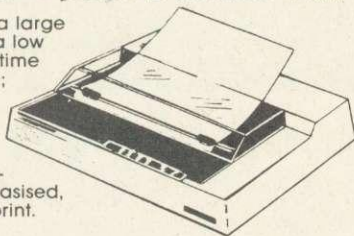

QUEN DATA — ~~£299~~ **£199.00** + VAT

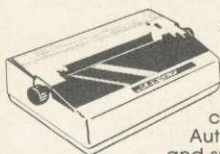

A wonderful opportunity to purchase a daisy wheel printer at a price you can afford! Features include: 16CPS; Bi-directional; Logic seeking; Proportional spacing; WordStar compatible; 13" platen — 12" print line; Autoscore; Bold and shadow printing; Sub and superscripts; QUME compatible ribbons; QUME compatible daisywheels; 4 level impression control; Prints original + 4 copies; Low noise.



CANON PW1080A
THE NEW NEAR-LETTER
QUALITY MARVEL!

£289
+ VAT

APPLE TAUGHT MACINTOSH ABOUT MAN. NOW MAN WANTS MACINTOSH.

Introducing Macintosh. Macintosh's brain is the same blindingly-fast 32 bit MC68000 micro-processor that powers the Lisa personal computer.

Its heart is the same Lisa technology of windows, pull-down menus, mouse commands 32-bit power more useful by making Macintosh far easier to use.

Now for some small talk

If the problem won't come to Macintosh, you can always take Macintosh to the problem — it weighs 9 pounds less than the most popular portable computer.

Just pick Macintosh up by its built-in handle, and carry it. A miracle of miniaturisation is Macintosh's built-in 3 1/2" drive. Its discs store 400K — more than conventional 5 1/4" floppies.

Programs.

There are already plenty of remarkable programs available to keep Macintosh busy. Like MacPaint a program that, for the first time, lets a personal computer produce virtually any image that the hand can create.

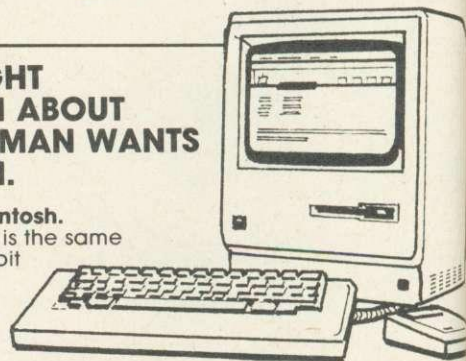

**7 DAYS
A WEEK**

*** MACINTOSH AND PRINTER DEMONSTRATIONS
DAILY AT OUR SHOWROOMS ON THE HOUR**

- * SUNDAY OPENING**
- * 24 HOUR DELIVERY SERVICE**
- * COMPREHENSIVE TECHNICAL SUPPORT**

**Phone for a Quote
0730-68521
Anytime**



CANON PW1080A
or KAGA TAXAN 810 — £329 £289.00 + VAT
 80 cols; High speed printing, 160 cps; bi-directional logic seeking; fantastic 27 cps near letter quality; 23 x 18 matrix; very quiet — less than 60 Db; 4, 5, 6, 8, 10, 12, 17 cpi; down loading for user-optional characters; high resolution graphics; handles various forms, roll paper, fan fold, single sheet and multipart copy paper. Also available — wide bodied Canon PW1156A or KAGA TAXAN KP910 — New low prices!

DAISY STEP 2000 — £299 £249.00 + VAT



18 cps; Bi-directional logic seeking; 10, 12, 15 cps; Wordstar compatible; 13 inch platen; 12 inch print line; auto underscore; bold and shadow printing; subscripts and superscripts; Qume compatible daisy wheel; optional tractor and sheet feeder; optional RS232C serial interface; low noise; low cost; high reliability.

There's more software on the way from developers like Microsoft, Lotus and Software Publishing to mention a few. And with Macintosh BASIC, Macintosh PASCAL and our own Macintosh Toolbox for writing your own mouse driven programs, you could turn a few bob in your spare time.

All the right connections
 On the back of the machine, you'll find built-in RS232 and RS422 Applebus serial communication ports for connecting printers, modems, and other peripherals without adding expensive cards. If you wish to double Macintosh's storage with an external disc drive, you don't have to pay for a disc controller card — that's built in too.

Talking of extras
 Macintosh has a built-in polyphonic sound generator capable of producing high-quality speech and music.



Macintosh automatically makes room for illustrations in text. MacPaint — virtually any image the human hand can create. Microsoft's Multiplan for Macintosh.

THE GRAPPLER — £148 £102.00 + VAT

Your Commodore 64 can print like a pro!

The Grappler offers a complete answer to printer interfacing, with many capabilities unique in the Commodore market place. Complete signal transmission allows many popular name brand printers to operate perfectly with the Commodore 64. Even Commodore's graphic character set can be reproduced on Epson, Star, Oki, Brother.

- Prowriter and other popular printers.
- Prints screen graphics without software.
- Graphics screen dump routines include rotated, inversed, enhanced, and double sized graphics.
- Complete emulation of the 1525 printer for printing Commodore special characters.
- Text screen dump and formatting commands.
- 22 unique text and graphics commands.

CANON PJ 1080A — £459 £399.00 + VAT

Seven colour printer ideal for the BBC, Sirius, Apple, etc. Seven colours print on demand ink jet printer; 70 cps bi-directional; high resolution graphics; will print on acetate sheets for overhead projection; long life ink cartridges 3.5 million characters per cartridge; eight bit parallel interface; Epson compatible; easily replaced colour cartridges; accepts single sheets; interchangeable character sets.



24 hour nationwide delivery by Securicor £9.50 + VAT Bankers orders; Building Society Cheques; Postal Orders; same day despatch. All orders covered by the Mail Order Protection Scheme.

**MANY MORE PRINTERS AVAILABLE
1,000s OF BARGAINS
— SEND NOW FOR
THE FAMOUS SCI
(UK) CATALOGUE**



**FAST Mail Order
SCI (UK) Unit 16, Inmans Lane, Sheet,
Petersfield, Hants GU32 2AN**

**Freepost Mail Order
SCI (UK) Freepost, Petersfield,
Hants GU32 2BR.
Tel. 0730 68521.
Telex 88626 MYNEWS G**

**PERSONAL CALLERS WELCOME
AT OUR MAGNIFICENT NEW
SHOWROOMS AT
12 High Street, Petersfield,
Hants GU32 2JG.**

We wish to acknowledge the several well known trade marks used in this advertisement

URGENT ORDER
 SCI (UK) FREE POST,
 PETERSFIELD, HANTS GU 32 2BR.

PLEASE RUSH ME _____

Name _____

Address _____

Credit Card _____

Number _____

THREE NEW PROGRAMS FROM MICROTEST

DAIRYFILE FOR DAIRY FARMERS

Keep on that economic line between over and under feeding!

Save time recording milk yield and calculating feed amounts!

Quickly decide feeding policy with the 'Monthly Calving Group' Performance Graph!

Print out a recording sheet with cows in numerical order. Print out graphs or tables of individual cows or Monthly Groups showing serving and pregnancy details, illness record, Calving Index, weekly and running total Margin over Concentrate. See at a glance cows due for serving, pregnancy diagnosis and drying off. Keep track of weekly total feed cost and milk sale price.

All this and more with DAIRYFILE.

Predict cow or Monthly Group total lactation yield. Compare with Standard Lactation Curves. All old data preserved—compare Monthly Groups over the years. Which is the most profitable month?

Find out with DAIRYFILE—for up to 200 lactating cows.

£69.00 inc. VAT (disc only) + p&p 50p

2 x 40 Track Drives Required or 1 or more 80 Track Drives. Please state which when ordering.

SATAN'S CHALLENGE or (Nevil Rides Out)



A Black Magic Adventure

Dare you take up the challenge laid down by the most evil and sinister of all beings... the devil himself. If you do you will find yourself alone and at the mercy of the twisted fancies and whims of a cold and calculating mind.

Occult forces are threatening the lives of those near and dear to you. Their only salvation rests in your hands but in accepting the challenge your own existence is put in severe peril.

In taking up the challenge you have to find The TALISMAN and locate a pentagram which then has to be prepared for the final rite. In the meantime dark forces will be opposing you making a difficult task almost impossible.

Do not allow yourself to be lulled into a sense of security for it will be short lived. Many have gone before only to swell the ranks of the damned.

This is the latest adventure from the stables of Microtest and has been written with the acclaimed features of other adventures in mind eg save facility, quick response, simple but extensive commands, a mixture of logical and friendly problems to solve.

Be warned this is an easy adventure to get into but devilishly difficult to end.

Cassette £7.95 inc. VAT Disc £9.45 inc. VAT + p&p 50p Disc 40 or 80 Track.

MICROTEST FONT ROM

This exciting new ROM from Microtest will enable you to get all sorts of new characters and fonts from your BBC Computer. Once you have produced your masterpiece on the screen, all you have to do is use the inbuilt screendump utility to produce a hard copy on to paper.

Typing *HELP FONTS gives you a list of available fonts and the blocks of characters which they replace.

Available fonts are:

- *Accents Accents and miscellaneous.
- *Block Small capitals.
- *Data Like the bottoms of queues.
- *Greek It's all Greek to me too!
- *Joined Standard capitals with joined up lower case.
- *Maths A mix of until now unobtainable Mathematical symbols.
- *Miscellaneous A few oddities which often are very necessary.
- *Thick Thick text (for MODEs 0&3) to enhance 80 column mode.
- *Thin Thin text (for MODEs 2&5) which makes modes 2 & 5 much more readable or perhaps "READABLE".
- *Vertical For labelling graphs in a vertical plane.
- *Mode 8 10 column multi colour, memory miserly mode.
- *S Dump A Dump facility which will produce a screen dump of any mode from 0 to 8 (including a text only dump in mode 7) on an Epson, Star, CP80, MT80 or JP80 etc etc....

The dump utility will produce negative or positive product, can magnify, and will also rotate the picture through 90 degrees as well as being able to position the picture anywhere laterally across the paper.

The ROM uses absolutely no user memory and can be used with word processors etc, as well as with normal word programs.

£17.50 inc. VAT + p&p 50p

Microtest Starstick ROM & Joystick Package

Now available the Starstick ROM and Joystick. This comes in three forms:



Enables you to use our joysticks even on programs that do not offer joystick capability.

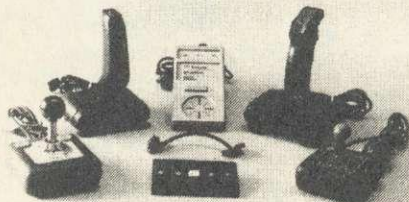

- (A) The Starstick ROM and Quickshot I Joystick
Price 17.95 + VAT = 19.84
- (B) The Starstick ROM and Quickshot II Joystick
Price 19.25 + VAT = 22.14
- (C) The Starstick ROM and patch lead, choose your own Spectrum/Atari style joystick
Price 15.25 + VAT = 17.54

Post and Packing £1.00 inc. VAT per item

This enables you to plug the Rapid action self centring joysticks until now only available for the Spectrum/Atari/CBM machines into the user port of the BBC. Model A users please note NO ANALOGUE INTERFACE REQUIRED.

Disc Users Note—pressing BREAK, SHIFT-BREAK or CONTROL BREAK does not modify or destroy the STARSTICK software so Disc Users please feel free to Boot!

The software patch provided in the ROM is interrupt driven and adds the following commands to your computer.

- * STICK turn on the STARSTICK ROM
- * NSTICK turn off the STARSTICK ROM
- * SETSTICK set up joystick to users spec
- * SAVE "NAME" 140 160 saves your user-key protocols
- * ADVAL emulate standard analogue joysticks
- * PAUSE define key to Freeze game
- * NPAUSE turn off ability to freeze game
- * "NAME" predefined key protocols set up for software houses programs
- * HELP KEYS displays currently selected key protocols
- * REPEAT enables auto-repeat fire
- * NREPEAT disables auto-repeat fire

DEALER ENQUIRIES
and
EXPORT ORDERS
WELCOME

available from

MICROTEST LTD

18 Normandy Way, Bodmin, Cornwall PL31 1EX

Telephone: 0208 3812

OR ANY GOOD DEALER

Large picture shows BBC Computer System and a Quickshot II Joystick. Small inset just a few of the joysticks that will work with the patch lead. Screenshot by kind permission of SUPERIOR SOFTWARE

All microtest ROMs are fully TUBE® compatible. (TUBE® is a reg trademark of Acorn Computers.)

VISA



ANNIVERSARY ANSWERS

Simon Dally separates the winners from the wallies among the entrants to our 20-question birthday quiz featured, complete with tie-breaker, in the July issue

OUR July competition celebrating the second birthday of *Acorn User* was the easiest ever (thanks to the generous nature of our editor). Many of the 250-odd entrants pointed this out. But, alas, only about a third of all entries proved to be correct!

The commonest mistake made was to think that the first computer to be sold for less than £100 was the ZX81. In fact, it was its predecessor, the ZX80, though not a few of the entries thought it was the Atom. Also, an enormous number thought the Basic statement DIM A\$(20,2) produces an array of 40 elements: in fact it creates 63 – remember the first element will be A\$(0,0)!

A few entries even managed to get the date of the original issue of *Acorn*

User wrong – despite the fact that all over the magazine were plastered the words 'second anniversary issue'! Ah well, if there's one thing queerer than folk, it's *Acorn User* competition entrants...

The correct answers were:

- 1)b; 2)a; 3)c; 4)b; 5)b; 6)b; 7)b; 8)b; 9)c; 10)a; 11)b; 12)a; 13)b; 14)b; 15)a; 16)a; 17)c; 18)b; 19)a.

Judging tiebreakers ('I like *Acorn User* because ...') is never easy (sob ... now I know how washing-powder manufacturers feel) but in the end, we felt the best two were from M Fulker of Hungerford, Berks, who wrote: '*... it gives a profusion of solutions to Basic confusions and programming illusions*

...', and Charles Williams of Coventry, whose slogan was: '*... because it is Authoritative, Clarifying, Outstanding, Relevant, Necessary, Useful, Sensible, Educational, Recommendable, and very good value for money...*'

A consolation prize goes to Nick Evans of Grimsby, who appended his corny pun with the message, 'Well, what do you expect for a T-shirt?'. The duffer's prize goes to C M Hempzell of Hitchin, Herts, whose slogan was 'I like *Acorn User* because the competitions are so easy' – but he got no fewer than three of his 19 answers wrong...

The 20 winners of the first prizes (five packs of software) and the 10 winners of the second prizes (*Acorn User* sweatshirts) have all been notified.

HARD DIAMOND

This month's gem: a palindromic puzzle

THIS month's problem is taken from the shortly-to-be-published *Century/Acorn User Book of Computer Puzzles*, which is the result of the competition we set you earlier this year, inviting you to send in your own puzzles. This one was submitted by J Oldroyd of Batley.

Look at the diamond of letters. The object is to find as many ways that the palindromic sentence RISE TO VOTE SIR can be read (a palindrome, just in case you don't know, is something which reads the same both backwards and forwards).

You may move in any direction to an adjacent letter and you can use the same letter twice or more.

Incidentally, J Oldroyd's program goes on to solve all palindromic puzzles of this nature.

Answers on a postcard, please, to October Competition, *Acorn User*, Red-



wood Publishing, 68 Long Acre, London WC2E 9JH, to arrive not later than Friday November 2, 1984. Prizes of two Acornsoft packages (worth £20) will go to the first five correct solutions taken from the bag. *Century* is offering six copies of the book to the runners-up.

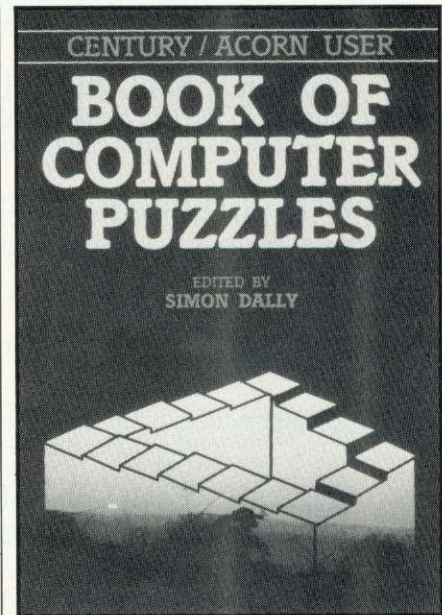

Remove your weary fingers from the fire buttons and climb aboard your magic carpet to enjoy this delightful and original game.

£7.95

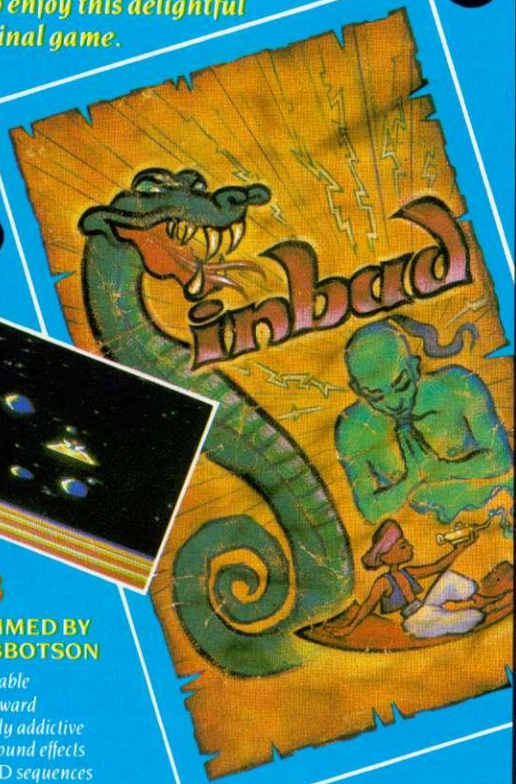

BBC B
PROGRAMMED BY
DENNIS IBBOTSON

- Hi-Score Table
- Surprise reward
- Infuriatingly addictive
- Fantastic sound effects
- Amazing 3D sequences
- A time test of skill and agility
- Refreshingly original family game

VGA 2014

Something new from CMC...

... books ...

Our highly successful Advanced User Guide for the BBC has now been joined by the Advanced Basic ROM User Guide, which delves deep into the BBC micro BASIC 1 and BASIC 2 ROMs. At £7.95, it's essential for the serious user. We have also introduced hard-back ring-binders for the Acorn User Guide and our Advanced User Guide: available at £4.50 each.



... type 'n' talk ...

Simply connected to any micro, this is a powerful speech computer with sophisticated software: it will convert any text into speech faster than it can be spoken. This is our own product, developed and manufactured in Cambridge.



£171.35.

and disk drives ...

The new generation of TEAC 5 1/4" slim-line disk drives offer high performance at incredibly low prices.



Single drives: 100K £120; 200K £140; 400K £180.
Dual drives: 2x100K £295; 2x200K £325; 2x400K £450.
Disk with power supply extra £30.

All drives are fully cased and complete with cables and format disk—ready to use.

We offer a number of complete packages for word-processing, from £658 to £1860. Pictured here is a BBC-based system: BBC 'B' + DFS, Philips green monitor, 100K disk drive, Wordwise, dot matrix printer, leads—ready to use, at £875 including VAT.



and systems ...

We stock a vast range of micros, printers, monitors, joysticks... phone or write for our complete price list. All prices listed include VAT. Credit terms available for orders of £500 or over—ask for details. See our full stock on Prestel 377550875/76A—updated weekly.

Cambridge Microcomputer Centre

The Peripheral Centre of East Anglia
153-4 East Road, Cambridge CB1 1DD, U.K.
Telephone (0223) 355404 Telex 817445.

EDWORD

Educational word processor for the BBC microcomputer

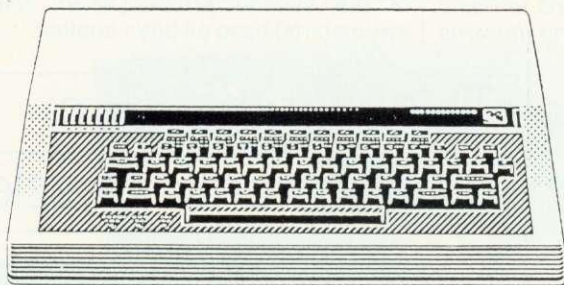

BBC INTERFACING COURSE

Introduction to the use of microcomputers as controllers of external equipment

DIGITAL ELECTRONICS TASTER COURSE

Introduction to microelectronic digital circuitry

KEYMASTER

Keyboard emulator for the BBC microcomputer

These and other educational/computing products are available from:

Dept AU10, CLWYD TECHNICS LTD
Antelope Industrial Estate, Rhydymwyn
Mold, Clwyd
Tel: Hendre (035283) 751

ORDER FORM

To: Cambridge Microcomputer Centre, 153-4 East Road, Cambridge CB1 1DD

Please supply the following items, as described above:

_____	@ £ _____
_____	@ £ _____
_____	@ £ _____
Delivery charge (free delivery on books)	£5.00
TOTAL	£ _____

I enclose a cheque for £ _____ or please debit my Access/Barclaycard/Diners/Amex* card number _____

Please send me your price list and catalogue.

Name _____

Address _____

Signature _____

*delete where inapplicable.
Please allow 21 days for delivery. Prices valid in UK only—please telephone or write for overseas rates.

AU1084

TAKE COMMAND OF THE 8271 CHIP

By programming the floppy disc controller you can out-perform the DFS. Richard Harris has the details

81

THE 8271 floppy disc controller (FDC) chip is a complex piece of electronics, allowing relatively easy control of up to four disc drives. This article will try to explain how to program the 8271: it will not cover the circuitry of the disc interface since there is no benefit from altering this. The circuit itself can be found in the *User Guide* and *Advanced User Guide*.

Why bother with programming the 8271, since the disc filing system (DFS) does it all for you? There are several reasons. First, simply to know more about how your computer works, especially as little information has been made available on the disc interface. Once mastered, it is possible to write your own data handling routines which for some applications are more efficient and quicker than those in the DFS. You will also discover some of the tricks to protect your discs and, possibly, to make backup copies of other discs. It is also possible to modify protected programs: at the end I'll show you how a simple change in *Aviator* can be made to alter the keys used.

Figure 1 shows the overall structure of the 8271, and details of the control logic and registers are listed in figure 2.

The value obtained from the Result register gives the following information about the command just processed:

- Bit 7,6 Not used
- Bit 5 Set if deleted data found (see below)
- Bit 4,3 Completion types:
 - 0,0 = good completion
 - 0,1 = system error, may be recoverable if retried
 - 1,0 = 'fatal error'
 - 1,1 = 'fatal error'
- Bit 2,1 Completion code (see below)
- Bit 0 Not used

TypeCode Meaning

- 0,0 0,0 good completion
- 0,0 0,1 scan result - see later
- 0,0 1,0 scan result
- 0,1 0,0 clock error
- 0,1 0,1 late DMA - see later
- 0,1 1,0 ID CRC error - see later

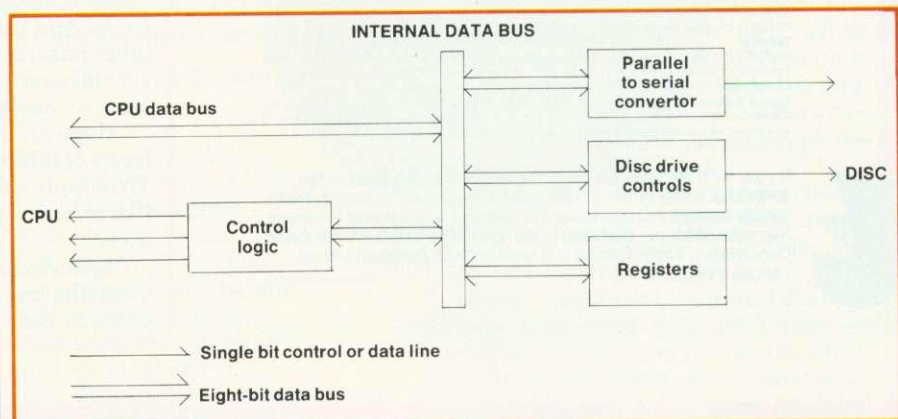

Figure 1. Overall structure of the 8271 chip

Register	Address in BBC	Type	Comments
COMMAND	&FE80	Write	The various commands are entered here Commands take up to five parameters, entered here
PARAMETER	&FE81	Write	
RESULT	&FE81	Read	
STATUS	&FE80	Read	
RESET	&FE82	Write	

All data transfers occur at address &FE84, both reading from the disc and writing to it

Figure 2. Details of the 8271's control logic and registers

- 0,1 1,1 data CRC error - see later
- 1,0 0,0 drive not ready
- 1,0 0,1 write protected disc
- 1,0 1,0 track zero not found
- 1,0 1,1 write fault
- 1,1 0,0 track/sector not found

Incidentally, these are the values given in the Acorn DFS errors 'Disc fault at ...' and 'Drive fault at ...'.

The Status register gives information about the 8271's internal working:

- Bit 7 Command busy; set to 1 if processing command.
- Bit 6 Command full; set to 1 when command written to 8271 and

- cleared when begins processing.
- Bit 5 Parameter buffer full; if set to 1 further parameters should not be written.
- Bit 4 Result ready; after a command is completed bit 7 goes low and this bit is set to 1. It is cleared by reading the result register.
- Bit 3 Interrupt request; reflects state of interrupt line. Cleared by reading result register.
- Bit 2 Non-DMA data request; if DMA is not being used, set to 1 if interrupt is for data transfer rather than end of command

Game for a song ... VIRGIN GAMES at £2.99

The **LAUGHING SHARK** told us that it won't be long till **CHRISTMAS** and it was time we did something about it so, until the end of **NOVEMBER**, we will be selling most of our **BEST GAMES** at the **SPECIALLY REDUCED** price of **£2.99** instead of the usual prices of **£5.95** and **£7.95** - that's a **SAVING** of between nearly **£3.00** and **£5.00** per game!

These titles **ONLY £2.99** each -

	NORMAL PRICE	SAVING		£7.95	£4.96
ELECTRON			Noc A Bloc	£7.95	£4.96
Bugs	£7.95	£4.96	Chieftain	£7.95	£4.96
Jungle Jive	£7.95	£4.96	Plankwalk	£7.95	£4.96
			Microbe	£7.95	£4.96
BBC B			Trench	£7.95	£4.96
Brainstorm	£7.95	£4.96	Bug Bomb	£7.95	£4.96
Sea Adventure	£7.95	£4.96	Landfall	£7.95	£4.96
Check Out	£7.95	£4.96	Space Adventure	£7.95	£4.96
			Jungle Jive	£7.95	£4.96

Brainstorm - TWO PLAYERS'... on a parallel with chess if not more complicated... great for a game which needs thought' *Home Computing Weekly* **Checkout** - RECENT RELEASE 'Superb graphics and sound and originality combine to make a wonderful game' *Home Computing Weekly* **Noc-a-bloc** - '... good game with clear, smooth graphics and plenty of colour' *Personal Computer Games* **Plankwalk** - 'Highly recommended' *Personal Computer Games* **Microbe** - 'The game is a great example of what can be done on the BBC. I'm addicted' *Personal Computer News* **Trench** - '... an excellent game which will certainly keep your fingers dancing on the keys of your Beeb' *TV Gamer* **Bug Bomb** - 'This game is wonderful and is a great example of what can be done on the BBC. I'm addicted' *Personal Computer News* **Landfall** - 'Virgins Landfall is a sophisticated flight simulator' *Your Computer* **Space Adventure** - 'The only problem I had with Space Adventure was prising my friends away from it' *Home Computing Weekly* **Jungle Jive** - RECENT RELEASE 'If you enjoy wholesale slaughter then you'll probably have a good time' *Personal Computer Games*

If your local **RETAILER** does not stock these **GAMES** at the **SPECIAL LOW** prices, simply send a cheque or PO for **£2.99** for **EACH GAME** you want plus 50p postage and packing (however many **GAMES** you **ORDER**) to the '**GRAB IT WHILE YOU CAN**' Department, Virgin Games, 2-4 Vernon Yard, Portobello Road, London W11 2DX.

Offer subject to availability.

Stake your survival on Spaceman Sid.

Another great challenge from English Software

Survival on Earth depends on 'Spaceman Sid'. And that means YOU! Get behind the controls of your laser-armed combat rover - and start the battle.

The Martians have taken over our dilithium mines on the planet Tribos and re-capturing those essential mines is your tough challenge.

But watch those Martians - they're loaded with dirty tricks. And watch out for the other hazards of space travel... you won't have to wait long, we can guarantee!

There are 3 progressive levels of difficulty of play. That applies to both Acorn Electron and BBC Model B users.

'Spaceman Sid' is available on cassette for just £7.95, so beam yourself into



your local dealer today.

Tomorrow itself could be at stake!

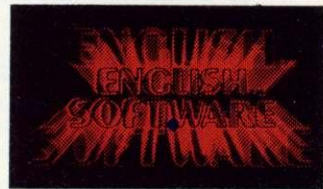

THE POWER OF EXCITEMENT

The English Software Company,
Box 43, Manchester M60 3AD
Trade Enquiries Tel: 061-835 1358

IS PAPER WORK GETTING ON TOP OF YOU ?

ABACUS

BUSINESS SYSTEMS

CAN BE YOUR STEPPING STONE

TO EFFECTIVE FINANCIAL AND ADMINISTRATIVE CONTROL

- | | |
|-------------------------|--------|
| 1 PAYROLL | £29.95 |
| 2 PURCHASE/SALES LEDGER | £29.95 |
| 3 STOCK CONTROL | £17.95 |
| 4 NON VAT ACCOUNTS | £17.95 |
| 5 CASH PLANNER | £12.95 |
| 6 MAILING LIST | £17.95 |

ALL PROGRAMS AVAILABLE AS A BUSINESS STARTER PACK FOR THE SPECIAL PRICE OF £99.50

THE PRICES ABOVE ARE FOR THE CASSETTE VERSION OF THESE PROGRAMS, DISC VERSIONS USING RANDOM ACCESS FILES ARE AVAILABLE FROM OCTOBER 1ST 1984.

ALL SOFTWARE PROVIDED BY ABACUS, IS FULLY SUPPORTED BY THE COMPANY.



21 UNION STREET
RAMSBOTTOM, LANCS
PHONE: 0204 52726



AVAILABLE FROM ALL GOOD COMPUTER SHOPS
BBC MODEL B, SHARP MZ700
COMMODORE 64
AND DRAGON 32
AND 64

Bit1,0 Not used

A reset is initiated by writing 1 and then 0 to the reset register. All drive control signals go low, commands in progress are aborted, status register flags are cleared, and an idle state occurs until the next command is entered. This mimics a hard reset via the reset pin.

The operation of the 8271 falls into three phases.

1 Command phase.

This starts with the issue of a command after checking the status register to ensure the 8271 is not busy. If parameters are needed these are then issued, checking before each one that the parameter buffer is empty. Failure to check may result in loss of a parameter.

2 Execution phase.

During this phase the computer can ignore the 8271 until the command is completed. This will be signalled by an interrupt. For this to occur a special chip is used to handle data transfer: a direct memory access device (DMA). The DMA can address, load and write to memory during part of the clock cycle not used by the central processor; the only information the DMA needs is the start address in memory for the data transfer. However a DMA is not used in the BBC micro, so any data transfers needed (each byte) are signalled by an interrupt and processed by the 6502. Because of the importance of this data transfer and the high speed at which it occurs, the high-priority non-maskable interrupt (NMI) is used, overriding any interrupts from internal timers, analogue to digital converters, keyboard and so on which use the interrupt request (IRQ). In the BBC micro the routine to handle NMI interrupts is based at &D00 and only very urgent needs are allowed to use it. These are the disc and Econet interfaces so far.

3 Result phase.

This notifies the successful completion of the command, or an error occurring during the operation.

Fortunately, the Acorn DFS provides a routine to carry out most of the complex control of the 8271: OSWORD routine with A=&7F which performs 'read/write a sector' as detailed in the DFS manual. In fact it will do much more than just read or write a sector.

As with all OSWORD routines, the 6502 accumulator (or A% if called from Basic) indicates which routine, while the X and Y registers (or X% and Y%) hold the address of the parameter block (X=low byte, Y=high byte). The call address is &FFF1.

The parameter block is as follows:

Offset from base address	
0	Drive number
1-4	Address in memory where data is to be sent to or from disc
5	Number of parameters needed by the 8271 command
6	8271 command
7	1st parameter
8	2nd parameter
9	etc

This routine handles all three phases of the 8271 operation. On completion the byte above the last parameter will contain the value in the result register and should contain zero if successful.

In Basic a simple routine would be:

```

10 DIM block 20, data 256
.
1000 A% = &7F:X% = block MOD 256:Y% = block DIV 256
1010 block? 0 = drive
1020 block! 1 = data
1030 block? 5 = noofpar
1040 block? 6 = command
1050 block? 7 = param 1
1060 block? 8 = param 2
1070 CALL &FFF1
1080 IF block? (7 + noofpar) < > 0 THEN PRINT "error!"
    
```

Before detailing the various 8271 commands, the layout of data storage (or 'format') on a disc must be understood.

Data is stored in concentric 'tracks' around the disc, there being 35, 40 or 80 tracks depending on which type of 5¼ in disc drive is in use. The 8271 will also support 8 in drives. Each track is subdivided into a number of 'sectors', which consist of an identification (ID) field and a data field. The number of bytes of data per sector depends on the number of sectors per track. The 'first' sector on a track is identified by the 'index hole',

the small hole in the disc which allows a photocell to detect a pulse of light once per revolution of the disc. The first sector is the one that immediately follows the light pulse.

The general layout on each track is shown in figure 3 and the ID fields in figure 4.

The 'gaps' are fixed or variable numbers of bytes that prevent sectors overwriting each other if the disc revolution speed should vary slightly.

Both the ID field and the data field have additional bytes called the Cyclic Redundancy Check (CRC) bytes. The value of these depends on the value of the rest of the bytes in the field and allows a check on the accuracy of subsequent reading of the field. While reading in the bytes, the CRC value is recalculated and compared to the original CRC; if these are not equal an error must have occurred and one of the error codes is generated.

The relationship between number of sectors per track, sector size, sector length (number of bytes of data) and gap size is set out in figure 5.

Gaps 1 and 3 can be varied if desired; 2 and 4 are fixed. 1, 2 and 3 have six additional bytes, always present, which act to synchronise any reading or writing operations. This gives a total of 3125 bytes per track, with a maximum of 2560 bytes of actual data. The format command (see below) also expects details of Gap 5; this is used only with 8 in discs and should be set to zero with 5¼ in discs.

It might be useful to describe some tricks that can be done with the format. With a 40-track disc one can command the drive head to be stepped to any of these, ie 0 to 39. However, one can number the track in the ID field anything from 0 to 255. One could step out to track 5 and then fool the 8271 into thinking that the current track is 78, for

Index									
Gap 4	Gap 1	ID	Gap 2	Data, sector 0	Gap 3	ID	Gap 2	Data, sector 1	Gap 3

Figure 3. Layout of a disc track

Track	Drive	Sector	Sector length
-------	-------	--------	---------------

Figure 4. The ID fields

No. of sectors	Size/length	Gap 1	Gap 2	Gap 3	Gap 4
18	0 128	16	11	11	24
10	1 256	16	11	21	30
5	2 512	16	11	74	88
2	3 1024	16	11	255	740
1	4 2048	16	11	0	1028

Figure 5. Relationship between number of sectors per track, sector size and length and gap size

PROFESSIONAL SOFTWARE FOR THE BBC MICRO

EASIPLOT

EASIPLOT is a sophisticated AND user friendly graph package for the BBC Micro, placed 14th in the top 20 Educational packages by the leading Educational Computing Magazine. EASIPLOT has also come to be regarded as an 'outstanding business package' and 'excellent value for money'.

Note:- EASIPLOT 3 comes complete with the number charting program DATA PLOTTER with graph magnification, colour and moving average facilities. SUPERB VALUE AT £22.95.

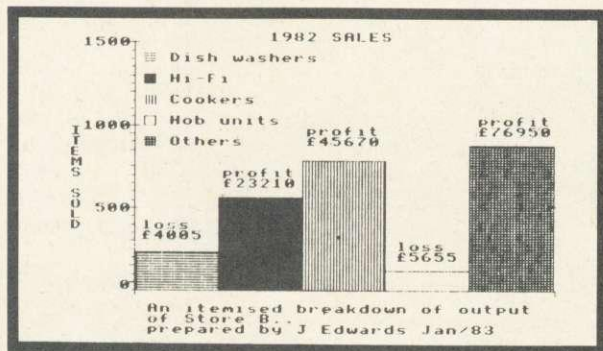

EASIPLOT FACILITIES

Line, Bar and Pie Charts
Auto & Manual Scaling
Grid & Scatter Options
No of simultaneous graphs
Overwrite memory
Screensave facility
Screendump facility
Fixed description per graph (char's)
Full plot and axis editing
Save, Load & *CAT facilities
Single file selection
Operating Manual (pages)

DISK CASSETTE

YES YES
YES YES
YES YES
5 3
YES NO
YES YES
YES YES
up to 200 100
YES YES
YES YES
YES NO
52 52

All our programs will produce hard copy on the following printers:- EPSON (entire range), Shinwa CP80, Star DP 510, Seikosha (GP80A & GP100A). Share Analyser will produce reports on any BBC compatible printer.

PLEASE NOTE:- Our programs CANNOT BE OBTAINED FROM YOUR LOCAL DEALER so send for details NOW.

PROGRAM	PRICE
Data Plotter (cassette) . . Model B & Electron	£7.00
Data Plotter (disk) . . Model B	£8.00
Easiplot 1 (cassette) . . Model B & Electron	£15.95
Easiplot 2 (disk only) . . Model B	£19.95
Easiplot 3 (including Data Plotter-disk only)	£22.95
Share Analyser (cassette) . . Model B & Electron	£14.95
Share Analyser (disk only) . . Model B	£19.95

Disk orders . . please state 40 or 80 track (add £1 for 80 track and £1.50 for overseas orders). We will upgrade Easiplot 1 to Easiplot 2 for £7 (£10 to Easiplot 3).

Write for full details of all our programs or leave your name and address with our Answerphone service (Luton 33858). All programs are normally despatched within 24 hours.

SHARE ANALYSER

SHARE ANALYSER is a sophisticated portfolio reporting and share analysis package designed for the small investor. The disk version has a capacity of 20,000 SHARE PRICES and up to 320 buy/sell deals covering 20 share names. Share Analyser has facilities for profit flexing and multiple merging of graphs and a variety of selectable indicators. **SHARE ANALYSER IS A MUST FOR THE INVESTOR AT A BARGAIN PRICE.**

PROFIT STATEMENT

NAME BRITISH PETROLEUM		
DEALINGS		
Bought	Av Price	Cost
600	338	2028
Sold	Av Price	Income
300	426	1278
Held	Curr Price	Mkt Valn
300	438	1314
	Gross Profit	564
	Income	257
	Expenses	101
	Net Profit	720
		% Gain = 36

SHARE ANALYSER FACILITIES

No of prices stored
Max no' of Holdings
Transactions per holding
Range adjuster
File Manager
Printer Manager

DISK CASSETTE

20,000 Appx 1700
20 20
16 16
YES NO
YES NO
YES NO

REPORTS PRODUCED:-

Portfolio Valuation	YES	YES
Portfolio Profit Analysis	YES	YES
Share Profit Analysis	YES	YES
Share Movement Analysis	YES	YES
Transaction Record Report	YES	NO
File Status Report	YES	NO

GRAPHICS FACILITIES:-

Magnification option	YES	YES
Grid	YES	YES
Autoscale	YES	YES
Screenwrite	YES	YES
Screendump	YES	YES

SELECTABLE GRAPHICAL INDICATORS:-

Lagged Moving Average	YES	YES
Centred Moving Average	YES	YES
Rise and fall indicator	YES	YES
Weekly/Daily Low indicator	YES	YES
Superimpose Facility	YES	YES

Send cheque/P.O. etc to
Synergy Software, 7 St Andrews Close, Slip End, Luton, LU1 4DE.

instance, whereas the usual DFS commands would simply report a disc error with this format. Thus one can talk about 'physical track numbers' and 'logical track numbers' (ie, that in the ID field). Logical track numbers do not have to follow any particular sequence; they can even be in reverse order (normal is 0 outermost).

The same applies to sectors; with a 10-sector format, the physical numbers would be 0 to 9. They can be given any logical number between 0 and 255, in any order, not necessarily sequential. There are, however, advantages to using sequential addresses in ascending order. The 8271 can be ordered to load into memory more than one sector at a time – for example start at sector 3 and load in four sectors. This will occur only if sectors 3, 4, 5, 6 are on the current track and it will be much quicker if they are in ascending order.

Interestingly, most efficient operation of the normal DFS occurs if physical sector 0 does not have logical number 0 on each track.

Thus if track 0 has sectors

0, 1, 2, 3, 4, 5, 6, 7, 8, 9

track 1 should be

7, 8, 9, 0, 1, 2, 3, 4, 5, 6

and track 2 should be

4, 5, 6, 7, 8, 9, 0, 1, 2, 3

Consider loading a program which covers more than one track on a disc without these sector offsets. The sectors on the first track will be loaded to sector 9, then the head will be stepped out to the next track – to just miss sector 0, as stepping is not instantaneous. A complete revolution of the disc then has to occur before sector 0 reappears. The offset described above ensures that the first sector encountered after stepping is 0. The actual offset needed will depend on the disc drive characteristics.

8271 commands

The general format of the command byte is for bits 6 and 7 to select which drive is in use, and bits 0-5 to specify the command. OSWORD &7F sorts out which drive (specified as the first parameter); so bits 6,7 of the command appear irrelevant. The DFS manual suggests they are set to 1,0, ie &40. This value should be added to the command value given below (eg, 'read data' &13 becomes &53 for the OSWORD parameter block).

SPECIFY

Command byte = &35

Uses four parameters

This command is used to initialise the 8271 with the physical properties of the

drive in use. It can also be used to tell the 8271 of any 'bad tracks' (ie, ones that will not format correctly). Once notified of these, the 8271 will automatically step over them as though they did not exist. This saves a disc being unusable simply because one or two tracks are faulty.

This facility is not used in the Acorn DFS, though modern discs are of very high quality and 'bad tracks' are a rarity.

The parameters are listed in figure 6.

Before expanding on the initialise parameters, a brief note about disc drive mechanisms. The disc itself is rotated at a constant speed by a motor, each rotation being detected by the index pulse. Data is read off the disc by the 'head'. This has two controls: a stepper motor that moves the head across the disc in a series of steps, these being the tracks; second, the head can be 'loaded' – that is, brought into contact with the disc, allowing reading/writing of data. There is in addition a micro-switch to detect when the head is stepped outwards as far as it can go – that is, when it is at track zero.

The speed of stepping between tracks varies with different makes of drive; parameter 2 defines this as 0 to 255ms (milliseconds) in 1ms steps. Likewise the time it takes for the head to settle after loading varies and can be set by parameter 3 (0 to 510ms in 2ms steps). Parameter 4 allows two features to be set. Bits 4 to 7 set the index count; this is the number of disc revolutions that occur after the last command before the 8271 unloads the head (0 to 14; 15 keeps head loaded). Bits 0 to 3 specify head loading time (0 to 120ms in 8ms steps).

The Acorn DFS can set up parameters for several makes of drive using the links on the keyboard or *FX255 – see DFS manual and *Advanced User Guide* for further details. Unless you have an unusual make of drive, little will be gained by varying these values.

READ DRIVE STATUS

Command byte = &2C

No parameters

Issuing this command puts the drive status into the results register which then can be read:

Bit 7	Not used
Bit 6	Drive 1 ready
Bit 5	Write fault
Bit 4	Index pulse detection
Bit 3	Disc write protected
Bit 2	Drive 0 ready
Bit 1	Track 0 detected
Bit 0	Count pin (used by 8271 for stepping)

'Drive not ready' is cleared by this command and should be issued during any initialisation.

READ/WRITE SPECIAL REGISTERS

Command bytes = &3D (read), &3A (write)

Uses one parameter

The parameter determines which register is involved:

&12	Drive 0 current track
&1A	Drive 1 current track
&17	Mode register
&23	Disc control output port
&22	Disc control input port
&10	Drive 0 Bad track 1
&11	Bad track 2
&18	Drive 1 Bad track 1
&19	Bad track 2

There are also three registers involved in scanning for data – see below.

The current track registers are the means to having different physical and logical track numbers.

The mode register has the following features: bits 6, 7 must be 1, bits 2-5 must be 0. If bit 1 is set, then the two heads on a double-sided disc move together (ie, always have some physical track number). If bit 0 is clear this means a DMA is in use, if 1 the CPU is used for data transfer.

Drive control input port is the same as reading the drive status, but does not clear 'drive not ready'.

Drive control output port gives the status of various lines between 8271 and drive:

Bits 6, 7	Drive select lines
Bit 5	Not used

Parameters	Initialise	Bad tracks	
		Drive 0	Drive 1
1	&0D	&10	&18
2	Step rate	Bad track no. 1 (physical address) Bad track no. 2	
3	Head settling time		
4	Index count/ load time	Current track	
Declaring all bad tracks as &FF implies no bad tracks			

Figure 6. The four parameters of the Specify command, useful in informing the 8271 of any 'bad tracks'

Bit 4	Writing to tracks near centre of disc
Bit 3	load head
Bit 2	step direction
Bit 1	step
Bit 0	write enable

SEEK

Command byte = &29

Uses one parameter

The parameter is the *physical* track address required. The head is then stepped to the appropriate point using the current track register as the starting point. Bad tracks will be skipped. The track number is not confirmed by reading the ID field.

A 'seek track zero' is different; here the head is stepped outwards until the track zero signal from the drive micro-switch is detected. If this fails after 255 steps an error occurs. A seek track zero should be performed whenever the current physical position is unknown, eg at power-up.

FORMAT

Command byte = &2C

Uses five parameters

This command formats one track at a time. The parameters are:

1	Track address (physical)
2	Gap 3
3	Bits 5 to 7 = sector size (0 to 4) Bits 0 to 4 = number of sectors
4	Gap 5
5	Gap 1

It also requires data for the ID field of each sector, ie four bytes times number of sectors. Each block of four follows the pattern previously described: track number, drive number, sector number, sector size. Thus using the OSWORD routine a block of 40 bytes (for 10 sectors/track) would be pointed to by parameters 1 to 4 of the OSWORD control block.

The track number is the logical number and need not be the same as the physical number. The drive number can be anything from 0 to 255. Sector number can again be any value (see above) but sector size should be the correct value. The first set of values in the data block will be the ID of the first physical sector and so on.

Each byte of the data in the sectors is set to a value of &E5 during formatting. Formatted tracks can be checked with the 'Verify' command (see below).

READ ID FIELDS

Command byte = &1B

Uses three parameters

This command transfers a specified number of ID fields into memory from a track, starting with the one immediately

after the index pulse (ie, physical sector 0). The parameters are:

1	Track number (physical)
2	Must be set to zero
3	Number of ID fields to be read

Note that a seek to the specified track occurs, though this is not confirmed by checking with the ID field. Thus if the logical track number is different an error does not occur when reading the ID fields.

Data processing commands

All the following commands seek the specified track and confirm it is the correct one by checking the ID field. If it is not correct the 8271 will try the next two tracks before causing an error ('Track not found').

128 BYTE SINGLE SECTOR

Two parameters

&12	Read data
&16	Read data and deleted data
&0A	Write data
&0E	Write deleted data
&1E	Verify data and deleted data

The parameters are:

1	Track number (logical)
2	Sector number (logical)

If the logical number is not the physical number, the command must be preceded by a 'seek track' command, and then change the current track register to the logical number with the special registers command.

'Verify' data reads the data and checks the CRC values, but does not transfer the data to memory.

'Deleted data' refers to sectors that have a special code and are ignored by the usual read commands, ie it is effectively wiped off the disc. However, the data is still present and can be read or restored if desired later on. It is another way of protecting discs; the usual DFS commands will see only a blank disc!

VARIABLE LENGTH/MULTI-SECTOR

Uses three parameters

&13	Read data
&17	Read data and deleted data
&0B	Write data
&0F	Write deleted data
&1F	Verify data and deleted data
&00	Scan data
&04	Scan data and deleted data

The parameters are:

1	Track number (logical)
2	Sector number (logical);

3	first if more than one) Bits 5 to 7 = sector size Bits 0 to 4 = number of sectors to be processed
---	---

See notes on previous command, and earlier notes on formatting regarding multi-sector processing. Processing multiple sectors is much quicker than doing them one at a time. Commands not processing deleted data will skip them and process the required number of normal sectors.

If an error occurs during multi-sector processing the sector at fault can be found by reading one of the 'scan special registers', number &06.

The scan command enables the 8271 to search for a byte pattern on a disc, but is of real value only when used with a DMA.

I hope this article has been some help to those wishing to know more about the disc system. I recommend reading it twice (if you can face it!), as some bits are more easily understood in conjunction with information presented later in the article.

Finally, a disc copying program (listing 1) that will make back-up copies of most discs if not all. Some copies will have to be made onto fresh, unformatted discs. This program is not written in a sophisticated way but in a manner that I hope is easy to follow in conjunction with the article. Many improvements are possible, for example to transfer all the sectors on a track at once.

With some minor changes it can also be used to change protected discs. Omit the 'format' procedure, and read and write to the same disc. In between reading and writing, CALL a machine code monitor and the data can then be examined, disassembled and changed as desired before being written back to the disc. The position of the data in memory can be found by having 'PRINT data' in the first few lines.

One change I've found useful is to alter the keys in *Aviator*. As set up it is impossible to use the joystick and the rudder keys (A and +) together effectively. In logical track number 72 (physical track 8), logical sector number 125 (physical sector 3) will be found a block of data holding the INKEY values (negative numbers) of the keys and used when flying. This includes &FF, &BE, &DD, &DA &C8, &BC, &CA and &A8 etc. If the &BE and &A8 are changed to &9E and &BD then keys Z and X will control the rudder - now one hand can operate these and fire with shift, while the other uses the joystick.

Richard Harris' disc copier is listed on yellow page 102



Choosing a printer is a lot easier than choosing a computer.

THERE are dozens of quality printers from which to choose. With quality price tags of around £250.

The Brother M-1009, however, breaks all the rules.

Stays defiantly below the £200 barrier.

Though it has far more than its fair share of features, it maintains the extraordinarily low price of £199.95.

Travels at a steady fifty.

In the speed stakes, the M-1009 is certainly no slouch, being fully capable of up to 50 characters per second.

Providing bi-directional and logic seeking printing for normal characters and uni-directional printing for super and sub script and graphics.

Prints on any paper.

Being an impact printer, the M-1009 will print on virtually any paper, including letter headings, invoices and standard office stationery.

It will even print two copies together with your original.

A superb character recommendation.

In its price range, the M-1009 has a great deal more character than many printers.

96 no less, plus international type and graphic characters.

Reliability comes as standard.

Built to the same exacting standards as Brother's elite office

printers, the Brother M-1009 already has faultless credentials for reliability.

Its 9 x 9 dot matrix head, for example, has an astonishing 20 million character service life.

One printer that doesn't block out the light.

Many home computers tend to be a little on the large side.

In contrast, the compact M-1009, at only 7 cm high, keeps a discreet profile.

Well designed, reliable – and conscientious.

The Brother M-1009.



The future at your fingertips.

DEPT P, BROTHER OFFICE EQUIPMENT DIVISION, JONES + BROTHER, SHEPLEY STREET, GUIDE BRIDGE, ALDENS HAW, MANCHESTER M34 5JD.
TEL: 061-330 6531 (10 LINES) 061-330 0111 (6 LINES) 061-330 3036 (4 LINES) TELEX: 669092 BROTHER INDUSTRIES LIMITED, NAGOYA, JAPAN.

— AVAILABLE FROM —
BOOTS, W. H. SMITH, WILDINGS, SPECTRUM U.K. MAJOR DEPARTMENT STORES AND BROTHER OFFICE EQUIPMENT RETAILERS.

TOOLKIT ROM from BEEBUGSOFT

BASIC Programmer's Aid for the BBC micro



©BEEBUGSOFT 1984

- 27 new commands to make life easier
- Saves hours in program development and debugging
- Supports both cassette and disc systems
- No command name conflict with other Roms
- Ideal for expert and novice alike
- Fitting instructions and a 32 page manual supplied
- You'll wonder how you ever managed without it

SPECIAL FEATURES INCLUDE

SCREEN EDITOR An extremely powerful editor, allowing the use of cursor keys to list a program line-by-line in either direction and move to any part of a program to overwrite or insert new code and corrections.

ERROR DETECTION Powerful facility to trap an error in a Basic program as it runs. It will then automatically enter the Screen Editor, display the line in error and position the cursor close to the statement at fault.

"TOOLKIT is an essential utility for all Basic programmers using the BBC Micro. . . . The range is enormous. . . . an indispensable aid packed full of powerful utilities."

EDUCATIONAL COMPUTING MARCH 1984

"... highly recommended."

PCN MARCH 17 1984

"The Beebugsoft Toolkit costs £27 and in my opinion is worth every penny. Since it has been installed in my BBC it has been used extensively and I can find no fault with it. Highly recommended to lazy programmers!"

COMPUTING TODAY JUNE 1984

COMMANDS

- *CHECK Verify a program or data in memory with disc/cassette.
- *CLEAR Clear all variables including integers.
- *EDIT Enter full screen editor.
- *FREE Display free memory and pseudo variables.
- *HELP INFO Display a screenful of useful system information.
- *MEMORY Display memory contents.
- *MERGE Merge a program in memory with one on disc/cassette.
- *MOVE Move program to run at specified address.
- *NEW As NEW, but can be issued from within a program.
- *OFF Cancel enhanced error handling.
- *OLD As OLD, but can be issued from within a program.
- *ON Auto error handling—enters editor at line in error.
- *PACK Efficient program compactor.
- *RECOVER Intelligently recover bad programs.
- *RENUMBER Allow partial renumbering.
- *REPORT Extended error reporting facility.
- *SCREEN Screen dump to cassette or disc.
- *UTIL Display utilities menu.
- *UTIL 1 String search.
- *UTIL 2 String search and replace.
- *UTIL 3 Move Basic program lines.
- *UTIL 4 List procedures and functions.
- *UTIL 5 List values of A% to Z%.
- *UTIL 6 List numeric variables.
- *UTIL 7 List string variables.
- *UTIL 8 List names of arrays.
- *UTIL 9 Set up range for utilities 1 and 2.

BEEBUGSOFT, PO BOX 109, HIGH WYCOMBE, BUCKS HP10 8HQ

Please send me.....Toolkit(s) at £27.00 each

Name

Address

.....
Send Cheque/Postal Order to BEEBUGSOFT,
DEPT 13 , PO BOX 109, HIGH WYCOMBE, BUCKS HP10 8HQ
(Distribution agents for BEEBUG Publications Ltd.)

Available from your dealer
and selected branches of
W.H. Smiths

£27.00

Including
VAT & P&P



SEE ALSO BEEBUGSOFT DOUBLE COLOUR ADVERT IN THIS ISSUE.

SERIOUS SOFTWARE from BEEBUGSOFT.

Design (C.A.D. Pack)

DESIGN is a screen processor which allows information to be displayed in a format suitable for demonstrations, slide projections, handouts or presentations.

Graphs, Pie Charts and Bar Charts are quickly produced on automatically drawn and scaled axes.

Text may be written anywhere on the screen and may be displayed normally, enlarged, underlined or sideways.

Twenty user-defined characters and four large macro characters are supplied, and may be placed anywhere on the screen or redefined as required. Additionally a set of characters for circuit diagram generation is also included.

Machine code screen dumps are included for Epson, Seikosa, Shinwa and Star printers and details on how to load dumps for other printers are also included.

Screens may also be saved and reloaded to cassette or disc.

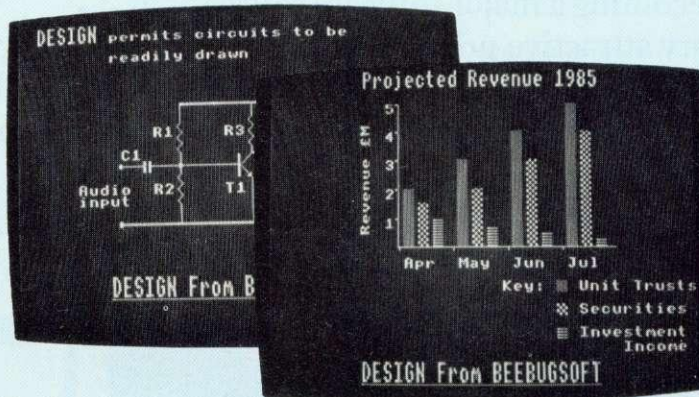

".... A first rate screen processor.... immense value to schools and colleges ideal tool for preparing display material...."

EDUCATIONAL COMPUTING APRIL 1984

Sprite Utilities

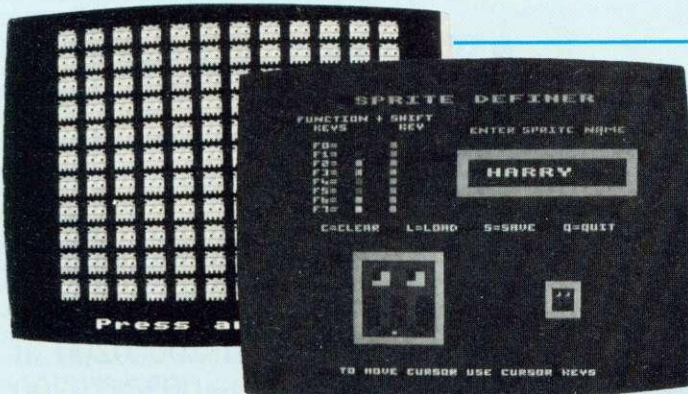

".... Definitely recommended...."

ELECTRONICS & COMPUTING MAY 1984

".... For my money Sprite Utilities wins through...."

ACORN USER MAY 1984

SPRITE UTILITIES A game writers utility pack which allows high speed arcade games to be written in Basic.

This is achieved by using the set of supplied machine code sprite routines to move multi-coloured characters (sprites), of your own design, around the screen at high speed.

Control of the sprites' movements is by user written Basic program. Specific commands to the sprites are very simple.

Sprites are generated in mode 2 on a 8 x 16 grid and may include any of the available 16 colours.

Up to seven sprites may be displayed and controlled on the screen at any one time. A special super sprite facility enables clones of each sprite to be created, to provide animation.

BEEBUGSOFT, P.O. BOX 109, HIGH WYCOMBE, BUCKS. HP10 8HQ

Please send me Design Disc(s) at £19.00 each Design Cassettes at £10.00 each

Please send me Sprites Disc(s) at £12.00 each Sprites Cassettes at £10.00 each

Name

Address

All BEEBUGSOFT products are available from leading dealers including larger branches of **W.H. Smith**



Send Cheque/Postal Orders to BEEBUGSOFT DEPT. 13 P.O. BOX 109, HIGH WYCOMBE, BUCKS. HP10 8HQ (Distribution agents for BEEBUG Publications Ltd.)

Hey Prestel. A new dimension for the BBC Micro.

Add the new Prestel Adaptor to a BBC Micro and you can download all programs available on the Prestel service.

Which considering Prestel is fast becoming a major software source, is a very attractive proposition indeed.

You can, for example, connect it to the growing Micronet 800 database. This



gives you an extensive choice of educational and business programs. Other 'closed areas' for private company communications are also available.

And that's in addition to games that range from simple to sophisticated. Plus electronic shopping and banking facilities, and an extremely useful personal 'mailbox' service.

But that's only the beginning. The Adaptor

also enables you to access Prestel information on any TV or monitor. And store the data so that it can be displayed or manipulated how and when you require it.

What's more, the Prestel Adaptor turns your BBC Micro into a terminal that can link with other dial-up computers with 1200/75 baud interface.

So you can, for example, have access to the British Telecom Gold electronic mail and telex service.

In fact, the enormous potential of our Prestel Adaptor, coupled with a surprisingly modest

price of £99 + VAT, make it a most exciting not to mention economical way to get more from your Micro.

The BBC Prestel Adaptor is currently only available via mail order.

You can order it on your credit card by ringing 01-200 0200 at any time, or 0933-79300 during office hours.

Alternatively, send off the coupon below.



Technical Specifications

For use with any BBC Micro 'B' with 1.2 MOS or later issue.

Prestel Language ROM supplied.

Dealer will install ROM together with MOS update if required in the BBC Micro.

Interfaces to any BT connection attached to 1200/75 baud dial up system (eg. Prestel, Micronet, Telecom Gold).

A BT socket outlet of the latest type will be required.

Connection via RS423 serial port.

Height 70mm. Width 210mm. Depth 350mm.

Colour: BBC Computer Cream.

Power in 240v, 50HZ, 15w.

Operating Temperature 10°-35°C.

To: BBC Microcomputers, c/o Vector Marketing, Denington Estate, Wellingborough, Northants NN8 2RL.

Please send me _____ BBC Prestel Adaptor at £113.85 each, inc. VAT and delivery. I enclose PO/cheque payable to Readers A/C, Acorn Computers Ltd, or charge my credit card.

Card Number _____

Amex/Diners/Visa/Access (Delete)
Name _____

Address _____

Postcode _____

Signature _____

AC10
Registered No. 140 3810 VAT No. 215 400220

The BBC Microcomputer System.

Designed, produced and distributed by Acorn Computers Limited.

"I COULDN'T BELIEVE THE SPEED..... YOU'RE THE BEST BY FAR"

(Paul Singleton, Cheshire)

We've played hundreds of BBC programs to try and choose the best (like the ones on this page.) Details are in our catalogue - free with your order. It's the ONLY catalogue to list the best, omit the rest and quote all the reviews. All programs for 32K BBC.

All programs work with keyboard control - or joysticks as shown. WE TRY TO SEND YOUR PROGRAMS THE SAME DAY WE GET YOUR ORDER. All games in stock - and tested by us - BEFORE we advertise them.

Access/Visa card holders phone 01-789 8546 24hrs, from any country where your own laws allows this. We have satisfied customers in over 40 countries: UK prices include UK vat. Export prices are the same - this 15% surcharge on export orders enables us to get them to you fast.

FRAK "FRAK is going to be a BBC classic... Frak is one of the biggest fully-animated computer heroes yet." (PC Games).

A platform game, with amazing graphics, from your hero - Frak - armed with yo-yo, to the fact that each screen scrolls to become many screens. Good tunes, great sound - and it's difficult enough to keep you trying. Written by Nick Orlando, "the best games programmer for the BBC" - according to PCGames! NO STIX (Aardvark) £8.90

THE FALL OF ROME "A refreshing change... a gripping game... you won't want to leave it" (HomeCompWkly).

Can you reverse history as you command the Roman Empire for its last sixty years? Defeat the 11 barbarian tribes, the two Eastern Empires as you buy legions, auxiliaries, cavalry. Good screen-prompts lead you through helpful up-dating on hi-res map of your Empire. NO STIX (Asp) £5.99

FOOTBALL MANAGER "The BBC version is the most impressive yet... the action is fast and the animated football sequences most impressive" (PopCompWkly).

"The combination of graphic action and informed decision-making distinguishes this from many other strategy games... entertaining and absorbing" (AcornProgs). Simply the best BBC football simulation. 3D animated colour graphics: 4 divisions: 7 skill levels. CUSTOMIZE feature: you can even be sacked as well! £7.95

SWORDS AND SORCERY is an

adventure where you have helpers: in this case 3 you name yourself as they are released from prison to help you! The characters you meet have varying moods: every object has a use: and there's a different scenario every time you play - each one totally logical. 9 SKILL LEVELS (the easy one is a good introduction to adventuring: soothing music while you play! Map Routine shows where you are - and where you've been. It is very good indeed. NO STIX (Kansas) £10.35

MYSTERY OF THE JAVA STAR

New 4-part adventure with 100K of program, 3 skill levels and a score table! You must complete each part to get to the next - but you can SAVE the first two parts to help you! Otherwise each time you play, the adventure will be different. And part 4, when you have found the wreck and dived for the treasure, is a real-time search as your air runs out. HELP available from the authors if you get stuck too! NO STIX (Shards) £7.95

WHEEL OF FORTUNE "Quite simply the best adventure I have seen for the BBC Micro... the advances in programming that have been made are amazing, this has to be THE ADVENTURE OF 1984" (Micronet 800).

250 locations: EVERY ONE WITH HALF-SCREEN GRAPHICS! Commands of up to 254 characters! Moving cast with varying moods! Save your position to tape or disc! Very fast response. NO STIX (Epic) £9.95

BLAGGER "DEFINITELY A BEST BUY FOR THE BEEB. A game to beg, borrow or blag" (PCGames).

20 SCREEN fully animated game that's quite a lot like M*N*C M*N*R. Each of the 20 screens is a different puzzle with a different solution. Will your burglar collect the keys to all the safes? You'll certainly make him try for weeks! NO STIX (Alligata) £7.95

FORTRESS "An absolutely magnificent piece of programming. In many respects, the feel of the game is even better than that of 'ZAXXON.'" (PCGames)

"The game is thrilling, the diagonally scrolling graphics superb and the sound effects excellent...in a class of its own." (Micro User) "Deserves a place in any self-respecting software collection." (C&VG) The classic arcade game, arguably better on your Beeb than it ever was in the arcades. All the features, plus Hall of Fame. STIX OK (Pace) £8.95

OVERDRIVE "The best race simulation I've seen on this machine, it's excellent value for money."

(PCN) You are in a multi-stage 3D race for the World Drivers Championship/ 5 stages - day, night, snow, desert, riverside. To qualify for the next stage, you must finish in the first 12. On-screen score, time, speed and bonus. You can actually feel how fast you're going - and the graphics are great! NO STIX (Superior) £7.95

SAVE £££s ON ROMS

Computer Concepts ROMs have been widely praised - we use them all the time! And we sell them to you cheaper than anyone else we know! As Home Comp Wkly said "Installation is easy, providing you have a spare sideways ROM socket or an expansion board".

GRAPHICS ROM "Good value for money... will provide anyone interested in graphics with a whole new field of possibilities" (Beebug) £27.50 YOU SAVE £5.85

PRINTMASTER ROM "If you have an Epson printer, there is no better choice at present than Printmaster... (Beebug) £27.50 YOU SAVE £5.85

DISK DOCTOR "If you use discs or write assembler programs, then you must have this chip" (HomeCompWkly) £27.50 YOU SAVE £5.85

WORDWISE "Probably the most useful word processor on the market" (YiCromp) £36.00 YOU SAVE £10.00

SAVE £40 ON PROGS!

All 20 of these programs have appeared in our catalogues of Beeb best. Now, you can save £2 on each of them. Offer limited to supplies available. Please state second choice.

THE MINE	(Program Power)	£5.95	YOU SAVE £2.00
GHOULS	(Program Power)	£5.95	YOU SAVE £2.00
PIMANIA	(Automata)	£8.00	YOU SAVE £2.00
TRAFALGAR	(Squirrel)	£6.00	YOU SAVE £2.00
ALIEN DROPOUT	(Superior)	£5.95	YOU SAVE £2.00
LUNAR RESCUE	(Alligata)	£5.95	YOU SAVE £2.00
MOON RAIDER	(Program Power)	£5.95	YOU SAVE £2.00
ROAD RUNNER	(Superior)	£5.95	YOU SAVE £2.00
MICROBE	(Virgin)	£5.95	YOU SAVE £2.00
WORLD TRAVEL GAME	(Hessel)	£3.95	YOU SAVE £2.00
DICTATOR	(dk tronics)	£4.95	YOU SAVE £2.00
DANGER UXB	(Program Power)	£5.95	YOU SAVE £2.00
CYBERTRON MISSION	(Program Power)	£5.95	YOU SAVE £2.00
FRUITY FREDDY	(SoftSpot)	£5.95	YOU SAVE £2.00
HUNCHBACK	(Superior)	£5.95	YOU SAVE £2.00
KILLER GORILLA	(Program Power)	£5.95	YOU SAVE £2.00
3D-MUNCHY	(MRM)	£3.95	YOU SAVE £2.00
CRAZY PAINTER	(Superior)	£5.95	YOU SAVE £2.00
O MAN	(MRM)	£3.95	YOU SAVE £2.00
TRANSISTORS REVENGE	(SoftSpot)	£5.95	YOU SAVE £2.00

To: SOFTWARE SUPERMARKET, 87 Howards Lane London SW15 6NU.

If you do not want to cut this magazine, write your order out carefully on plain paper and quote this number: **ACU4**

I own a 32K BBC computer. I enclose a cheque/PO made payable to Software Supermarket OR Charge my VISA/ACCESS/EUROCARD/

MASTERCARD number:

Signature

Please write clearly. If we can't read it, you won't get it.

Name

Address

Postcode

Phone, if any, in case of query

PROGRAM NAME		Price
		£
		£
		£
		£
		£
		£
POSTAGE	U K Add 55p only per order	£0.55p
AND	EUROPE Add 55p for each program	£
PACKING	OUTSIDE EUROPE Add £1 for each program airmail	£
OUTSIDE EUROPE ADD £1 TO TOTAL FOR REGISTERED MAIL		TOTAL £

SOFTWARE SUPERMARKET

VISA/ACCESS CALL 01-789 8546 (24hrs)

Electronequip

(Authorised BBC Model Dealer, and service centre)

	BBC Cassette Software	Exc VAT	Inc VAT
BAAFOOT	Addictive Football Manager	5.87	6.75
BAAFOUN	A & F Software Bounce	5.92	6.80
BAAFCIC	A & F Software Chuckle Egg	5.84	6.72
BAAFCYL	A & F Software Cylon Attack	5.84	6.72
BAAFFROG	A & F Software Frogger	5.92	6.80
BAAFHORR	A & F Software Horror Castle	5.92	6.80
BAAFHOWS	A & F Software Howzat	5.10	5.87
BAAFPAIN	A & F Software Painter	5.92	6.80
BAAFPHAR	A & F Software Pharaohs Tomb	5.92	6.80
BAAFLIAN	A & F Software Planes	5.92	6.80
BAAFSHRY	A & F Software Shrinking Professor	5.92	6.80
BAAIADVE	Adventure International Adventureland	7.35	8.46
BAAIPIRA	Adventure International Pirate Adventure	7.35	8.46
BAAISECR	Adventure International Secret Mission	7.35	8.46
BAAIVOOD	Adventure International Voodoo Castle	7.35	8.46
BAAKCHIL	ASK Children from Space (XBE1B)	7.35	8.46
BAAKCRAN	ASK Franky (XBE17)	7.35	8.46
BAAKFACE	ASK FaceMaker (XBE10)	7.35	8.46
BAAKHIDE	ASK Hide & Seek (XBE11)	7.35	8.46
BAAKLETS	ASK Let's Count (XBE12)	7.35	8.46
BAAKNUMC	ASK Number Chaser (XBE15)	7.35	8.46
BAAKNUMG	ASK Number Gunner (XBR13)	5.82	6.70
BAAKNUMP	ASK Number Puzzle (XBE13)	7.35	8.46
BAAKTABL	ASK Table Adventures (XBE19)	7.35	8.46
BAAKWORD	ASK Words, Words, Words (XBE19)	7.35	8.46
BAAKLABM	Altagata Software ABM (Laser Command)	4.39	5.05
BAAKLABG	Altagata Software Blagger	6.61	7.60
BAAKBLUG	Altagata Software Bug Blaster	5.88	6.76
BAAKCDAM	Altagata Software Cosmic Asteroids	4.39	5.05
BAAKCDOSM	Altagata Software Dambusters	5.87	6.75
BAAKLEAG	Altagata Software Eagle Empire	5.87	6.75
BAAKLFRI	Altagata Software Fruit Machine (BOB6)	4.39	5.05
BAAKLNAL	Altagata Software Luan Rescue (BO07)	5.87	6.75
BAAKALGE	Ampsoft Chesshire Cat Algebra 0 level	5.13	5.90
BAAKAMRT	Ampsoft Chesshire Cat Arithmetic 0 level	5.13	5.90
BAAKCALC	Ampsoft Chesshire Cat Calculus 0 level	5.13	5.90
BAAKCONGS	Ampsoft Chesshire Cat Construction 0	5.13	5.90
BAAKGRAP	Ampsoft Chesshire Cat Graphs 0 level	5.13	5.90
BAAKMMAT1	Ampsoft Chesshire Cat Maths 0 level 1	11.05	12.71
BAAKMMAT2	Ampsoft Chesshire Cat Maths 0 level 2	11.05	12.71
BAAKMTIG	Ampsoft Chesshire Cat Trigonometry 0	5.13	5.90
BAAK100P	Ampsoft 100 Programs for BBC Micro	8.50	9.78
BAAKSACT	Acornsoft Arcade Action (SBG06)	8.80	10.12
BAAKARCA	Acornsoft Arcadians (SBG14)	7.35	8.46
BAAKASAVIA	Acornsoft Aviator flight simulator SBG02	11.05	12.71
BAAKASBUSI	Acornsoft Business Games (SBEO3)	7.35	8.46
BAAKASCARO	Acornsoft Carousel (SBG24)	7.35	8.46
BAAKASCAS	Acornsoft Castle of Riddles (SBG17)	7.35	8.46
BAAKASCHAN	Acornsoft Chemical Analysis (SBF12)	10.20	11.73
BAAKASCHES	Acornsoft Chess (SBG10)	7.35	8.46
BAAKASCHSI	Acornsoft Chemical Simulations (SBF13)	10.20	11.73
BAAKASCHST	Acornsoft Chemical Structures (SBF14)	10.20	11.73
BAAKASCOLL	Acornsoft ICL Collectors Car SBX05	7.35	8.46
BAAKASCOUN	Acornsoft Countdown to Doom (SBG19)	7.35	8.46
BAAKASCRAZ	Acornsoft Crazy Tracer (SBG26) (B)	7.35	8.46
BAAKASCREA	Acornsoft Creative Graphics (SBX01)	7.35	8.46
BAAKASDESK	Acornsoft Desk Diary (SBB01)	7.35	8.46
BAAKASDRAU	Acornsoft Draughts & Reversi (B) (SBG20)	7.35	8.46
BAAKASXAAM	Acornsoft Examiner Cassette (SBE17) (B)	7.35	8.46
BAAKASFORE	Acornsoft Forecast (SBB02)	8.80	10.12
BAAKASFORT	Acornsoft Forth Cassette (SBL01)	12.45	14.32
BAAKASFREE	Acornsoft Free Fall (SBG28)	7.35	8.46
BAAKASFREN	Acornsoft French (Linkword) (SBX13)	11.05	12.71
BAAKASGERM	Acornsoft German (Linkword) (SBX16)	11.05	12.71
BAAKASGRAO	Acornsoft Graphics on the BBC	8.50	9.78
BAAKASGRAP	Acornsoft Graphs & Charts (SBX02)	7.35	8.46
BAAKASHOOK	Asoft ICL Hooked on Numbers (SBX08)	7.35	8.46
BAAKASHOPP	Acornsoft Hopper (SBG23)	7.35	8.46
BAAKASITAL	Acornsoft Italian (Linkword) (SBX14)	11.05	12.71
BAAKASJARS	Acornsoft Jars (SBE15)	8.83	10.16
BAAKASLCBO	Acornsoft JCB Digger (SBG09)	7.35	8.46
BAAKASLISD	Acornsoft Lisp Demo Progs SBL09	7.35	8.46
BAAKASLISP	Acornsoft Lisp Cassette (SBL02)	12.45	14.32
BAAKASMAGI	Acornsoft Magic Garden (B) (SBX04)	7.35	8.46
BAAKASMEMB	Acornsoft ICL M-ship Manager (SBX06)	7.35	8.46
BAAKASMETE	Acornsoft Meters (SBG13)	7.35	8.46
BAAKASMICR	Acornsoft Microtext (SBL04)	36.85	42.37
BAAKASMSB	Acornsoft Missile Base (SBG18)	7.35	8.46
BAAKASMISS	Acornsoft Missing Signs (SBE09)	8.83	10.16
BAAKASMOMS	Acornsoft Monsters (SBG03)	7.35	8.46
BAAKASNUMB	Acornsoft Number Balance (SBE08)	8.83	10.16
BAAKASONEF	Acornsoft One to Nine (SBX07)	7.35	8.46
BAAKASPEEK	Acornsoft Peeko Computer Pack (SBE02)	7.35	8.46
BAAKASPEPS	Acornsoft Personal Money M'ment SBB5	8.80	10.12
BAAKASPHIL	Acornsoft Philosophers Quest (SBG01)	7.35	8.46
BAAKASPICT	Acornsoft Picture Maker (SBX03)	7.35	8.46
BAAKASPLAN	Acornsoft Planetoid (Defender) (SBG15)	7.35	8.46
BAAKASROCK	Acornsoft Rocket Raid (SBG05)	7.35	8.46
BAAKASSENT	Acornsoft Sentence Sequencing (SBE07)	8.83	10.16
BAAKASINV	Acornsoft Super Invaders (SBG16)	7.35	8.46
BAAKASISID	Acornsoft Sliding block puzzles (SBG12)	7.35	8.46
BAAKASSNAP	Acornsoft Snapper (SBG04)	7.35	8.46
BAAKASNOO	Acornsoft Snooker (SBG21)	7.35	8.46
BAAKASSPAN	Acornsoft Spanish (Linkword) (SBX15)	11.05	12.71
BAAKASSPAS	Acornsoft S Pascal (SBL08)	12.45	14.32
BAAKASSPHI	Acornsoft Sphinx Adventure (SBG07)	7.35	8.46
BAAKASSTAR	Acornsoft Starship Command (SBG22)	7.35	8.46
BAAKASTREE	Acornsoft Tree of Knowledge (SBE04)	7.35	8.46
BAAKASWORH	Acornsoft Word Hunt (SBE05)	8.83	10.16
BAAKASWORD	Acornsoft Word Sequencing (SBE06)	8.83	10.16
BBAVMFL	BES Animal Vegetable Mineral (XBE03)	6.63	7.62
BBAVHAPL	BES Happy Numbers (XBE07)	6.63	7.62
BBAVHAPN	BES Happy Numbers (XBE04)	6.63	7.62
BBAVHAPP	BES Map Rally (XBE08)	6.63	7.62
BBAVHBTM1	BES Timeman One (XBE05)	6.63	7.62
BBAVHBTM2	BES Timeman Two (XBE06)	6.63	7.62

	BBC Cassette Software	Exc VAT	Inc VAT
BCEWORTH	BES Wordhug (XBE02)	6.63	7.62
BCEWORWP	BES World Wide (XBE02)	6.63	7.62
BCBSBEYO	BBCsoft Beyond Basic Cassette (B)	8.50	9.78
BCBSBANY	BBCsoft Canyon (B)	7.39	8.50
BCBSDRAW	BBCsoft Drawing	7.40	8.50
BCBSDRWH	BBCsoft Dr Who - The First Adventure (B)	7.39	8.50
BCBSSEARL	BBCsoft Early Learning	7.40	8.50
BCBSFUNG	BBCsoft Fun Games	7.40	8.50
BCBSGAMS	BBCsoft Games of Strategy	7.40	8.50
BCBSHOMF	BBCsoft Home Finance	7.40	8.50
BCBSMAKM	Making the most of your Micro (Inc book)	9.57	11.01
BCBSMOTO	BBCsoft Motorists Log	7.40	8.50
BCBSMUSI	BBCsoft Music	7.40	8.50
BCBSPAIN	BBCsoft Painting	7.40	8.50
BCBSPRO1	BBCsoft Programs Vol 1	7.40	8.50
BCBSPRO2	BBCsoft Programs Vol 2	7.40	8.50
BCBSRECO	BBCsoft Record Keeper (B)	10.20	11.73
BCBSTAXC	BBCsoft Taxcalc (B)	8.16	9.38
BCBSTOOL	BBCsoft Tool Box (B)	15.52	17.85
BCBSVUT	BBCsoft VU Type (Typing Tutor) (B)	11.90	13.69
BCBSWHIT	BBCsoft White Knight Mark Eleven (B)	8.50	9.78
BCBUTWIN	Bug-Byte Twin Kingdom Valley	7.02	8.07
BCCANDR	Computer Concepts Android Attack	6.61	7.60
BCCASTE	Computer Concepts Asteroid belt	5.87	6.75
BCCCHES	Computer Concepts Chess	6.61	7.60
BCCCGAME	Computer Concepts Games Galore 1	6.61	7.60
BCCCHTC	Computer Concepts Hitch Hiker	4.93	5.67
BCCCLOGO	Computer Concepts Logo II	8.50	9.78
BCCSNAK	Computer Concepts Snake	5.87	6.75
BCCSPAC	Computer Concepts Spacehawks	6.61	7.60
BCCSWAR	Computer Concepts Swarm	6.61	7.60
BCDAUPE	DACS Super 7 (Arcade games compend.)	6.61	7.60
BCDS747	Ductor Soft 747	5.87	6.75
BCFSPAD	First Byte Space Adventure One	5.87	6.75
BCFBSTFD	First Byte Star Force Lander	5.14	5.91
BCFBSTR	First Byte Star Trader	5.87	6.75
BCFBVAPH	First Byte Valley of the Pharaohs	5.87	6.75
BCGACHE	Garland Software Chemical Equations	9.57	11.01
BCGACHEI	Garland Sware Chemistry Inorganic Ana	9.57	11.01
BCGACHES	Garland Sware Chemistry Symbol/For/VA	9.57	11.01
BCGAHUMA	Garland Sware Human Body Heart & Kid	9.57	11.01
BCGAPHYC	Garland Sware Physics Cathode Ray Osc	9.57	11.01
BCGEBEEB	Gemin Beebeak (Spreadsheet)	14.75	16.96
BCGEBEEP	Gemin Beebeplot (Graph Plot)	14.75	16.96
BCGECASB	Gemin Cash Book Accounts	44.31	50.96
BCGECATE	Gemin Caterpillar	7.35	8.46
BCGEDATA	Gemin Database	14.75	16.96
BCGEASIS	Gemin Easi Ledger	14.75	16.96
BCGEFINA	Gemin Final Accounts	44.31	50.96
BCGEGHMA	Gemin Home Accounts	14.75	16.96
BCGEGINV	Gemin Invtst (Invoices & Statements)	14.75	16.96
BCGELIBE	Gemin Liberator	7.35	8.46
BCGEMAIL	Gemin Mail List	14.75	16.96
BCGEMISS	Gemin Missile Control	7.35	8.46
BCGEPAYR	Gemin Payroll	29.53	33.96
BCGESLEI	Gemin Sleighbells	7.35	8.46
BCGESTOC	Gemin Stock Control (ICS)	14.75	16.96
BCGETRAD	Gemin Traditional Games (B) (E)	11.05	12.71
BCGFWORD	Gemin Word Processor	14.75	16.96
BCGGAIFF	Griffin & George Fairshare	7.35	8.46
BCGGGETS	Griffin & George Getset	7.35	8.46
BCGGNUMF	Griffin & George Numberfun	7.35	8.46
BCGGTABL	Griffin & George Tablesums	7.35	8.46
BCGGWORD	Griffin & George Wordgames	7.35	8.46
BCGGWORS	Griffin & George Wordspell	7.35	8.46
BCGHTALP	Good Houseke g Mr T's Alphabet	9.57	11.01
BCGHTFME	Good Houseke g Mr T's Measuring Games	9.57	11.01
BCGHTNUM	Good Houseke g Mr T's Money Box	9.57	11.01
BCGHTNUM	Good Houseke g Mr T's Number Games	9.57	11.01
BCGHTSHA	Good Houseke g Mr T's Shape Game	9.57	11.01
BCGHTTEL	Good Houseke g Mr T Tells the Time	9.57	11.01
BCGRMINE	Graphic Research Minefield	5.13	5.90
BCGRORBI	Graphic Research Orbit 0	7.35	8.46
BCHOADVB	Honeyfold Advanced Basic course	12.10	12.71
BCHOBEGA	Honeyfold Beginners Assembly Language	12.10	12.71
BCHOBEGF	Honeyfold Beginners Basic course	12.10	12.71
BCHSPENG	Hot Penguin	6.59	7.58
BCIBCRIM	Ivan Berg Crime & Detection Quiz (XBX02)	9.35	10.75
BCIBDATT	Ivan Berg Dating Game (XBX08)	9.35	10.75
BCIBHIST	Ivan Berg History Quiz (XBX04)	9.35	10.75
BCIBIDIO	Ivan Berg I Do (XBX07)	9.35	10.75
BCIBMUSI	Ivan Berg Music Quiz (XBX03)	9.35	10.75
BCIBROYA	Ivan Berg Royalty Quiz (XBX06)	9.35	10.75
BCIBSICF	Ivan Berg Science Fiction Quiz (XBX05)	9.35	10.75
BCIBTHEAT	Ivan Berg Theatre Quiz (XBX01)	9.35	10.75
BCLJ3DMA	IJK 3D Maze for BBC (17)	3.32	3.82
BCLJFLAG	IJK Flags for BBC (12)	3.32	3.82
BCLJHYPE	IJK Hyperdrive for BBC (13)	4.80	5.52
BCLJINVA	IJK Invaders for BBC (14)	5.54	6.37
BCLJUSTRA	IJK Stratobomber for BBC (11)	5.54	6.37
BCLJYSTI	Joystick Utility program for BBC	5.06	5.82
BCKAGALA	Kansas Galactic Firebird	7.01	8.06
BCKAPINE	Kansas Pmball Arcade	7.01	8.06
BCKDPASS	Kay Dee Software Pass Go	7.23	8.31
BCKDFREA	Kosmos Software French Mistress A	7.35	8.46
BCKDFREB	Kosmos Software French Mistress B	7.35	8.46
BCKDGERA	Kosmos Software German Mistress A	7.35	8.46
BCKDGERB	Kosmos Software German Mistress B	7.35	8.46
BCKOSPA	Kosmos Software Spanish Tutor A	7.35	8.46
BCKOSPAB	Kosmos Software Spanish Tutor B	7.35	8.46
BCL9CDOL	Level 9 Colossal Adventure (B)	7.32	8.42
BCL9DUNG	Level 9 Dungeons (B)	7.32	8.42
BCL9LORD	Level 9 Lords of Time (B)	7.32	8.42
BCL9SNOW	Level 9 Snowball (B)	7.32	8.42
BCMHOOBB	McMourne House Hobbit	11.05	12.71
BCMSFIRS	Mirrorsoft First Steps with the Mr Men	6.61	7.60

	BBC Cassette Software	Exc VAT	Inc VAT
BCMSOUCI	Mirrorsoft Quick Thinking (B)	5.13	5.87
BCOCMRWI	Ocean Mr Wimp	5.10	5.87
BCPAFDRT	Pace Software Fortress	6.61	7.60
BCPPADVE	Program Power Adventure (B)	5.87	6.75
BCPPALID	Program Power Alien Destroyers (Invader)	5.91	6.76
BCPPALIE	Program Power Alien Swirl	5.13	5.87
BCPPASTE	Program Power Asteroid Storm (B)	5.87	6.75
BCPPASTR	Program Power Astro Navigator	4.21	4.85
BCPPBAND	Program Power Barrage at 3 o'clock	5.14	5.87
BCPPBARR	Program Power Barrage for BBC	5.13	5.87
BCPPBEEB	Program Power Beeb Tote (B)	4.40	5.14
BCPPBUMB	Program Power Bumble Bee (B)	5.87	6.75
BCPPCAVA	Program Power Caveman Adventure	5.06	5.87
BCPPCH16	Program Power BBC Chess 16K	3.66	4.21
BCPPCHEM	Program Power Chemistry	5.13	5.87
BCPPCHES	Program Power Chess	5.87	6.75
BCPPCNS	Program Power Constellation	5.87	6.75
BCPPCOSM	Program Power Cosmic Combat (B)	5.14	5.87
BCPPCOWB	Program Power Cowboy Shoot-out	5.06	5.87
BCPPCROA	Program Power Croaker	5.87	6.75
BCPPCYBE	Program Power Cybertron Mission (B)	5.87	6.75
BCPPDANG	Program Power Danger UXB	5.87	6.75
BCPPDEMO	Program Power Demon Decorator (Painter)	5.06	5.87
BCPPDIS	Program Power BBC Disassembler	5.06	5.87
BCPPDLDD	Program Power Eldorado Gold (Adventure)	5.06	5.87
BCPPESCA	Program Power Escape from M base Alpha	5.87	6.75
BCPPFFAC	Program Power Felix in the Factory	5.87	6.75
BCPPFFRU	Program Power Felix & the Fruit Monsters	5.87	6.75
BCPPFOOT	Program Power Footer	5.87	6.75
BCPPGALA	Program Power Galactic Commander	5.87	6.75
BCPPGHOU	Program Power Ghoul	5.87	6.75
BCPPHELL	Program Power Hell Driver (B)	5.87	6.75
BCPPHINT	Program Power Intergalactic Trader (B)	6.61	7.60
BCPPJETT	Program Power Jet Power Jack	5.87	6.75
BCPPKILL	Program Power Killer Gonilla	5.87	6.75
BCPPLABC	Program Power Labyrinths of La Coshe	5.87	6.75
BCPPLEASE	Program Power Laser Command	5.87	6.75
BCPPMART	Program Power Martian Attack (B)	5.87	6.75
BCPPMASM	Program Power Mastermind for BBC	3.36	3.82
BCPPMAZE	Program Power Maze Invaders (B)	4.40	5.14
BCPPMINE	Program Power Mine (B)	4.87	5.61
BCPPMOON	Program Power Moon Raider	5.87	6.75
BCPPMOME	Program Power Nemesis (B)	5.87	6.75
BCPPPOKE	Program Power Piker Dice (B)	4.40	5.14
BCPPPOSIS	Program Power Positron (B)	5.14	5.87
BCPPREVZ	Program Power Revers (32K)	4.21	4.85
BCPPROUL	Program Power Roulette for BBC	4.21	4.85
BCPPSEEK	Program Power Seek	5.06	5.87
BCPPSPAC	Program Power Space Jailer (B)	5.14	5.87
BCPPSTAR	Program Power Startrek	4.21	4.85
BCPPSWOO	Program Power Star Trek Plus	5.87	6.75
BCPPPTMT	Program Power Timetrek (Star Trek Plus)	5.87	6.75
BCPPWALL	Program Power Wall (B)	4.40	5.14
BCPPWHER	Program Power Where (B)	5.14	5.87
BCPPWHIC	Program Power Wich Salt?	5.14	5.87
BCPPWORLD	Program Power World Geography (B)	5.14	5.87
BCPPZARM			

Electronequip

(Authorised BBC micro Dealer, and service centre)

*** SPECIAL OFFERS**
Mail order only

*** EPSON**

RX-80FT £225.25 + VAT

FX-80 £320.88 + VAT

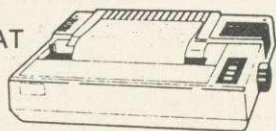

Printer price includes cable for BBC and screen dump rom is available for £11.50

SIDEWISE

SIDEWISE FITTED

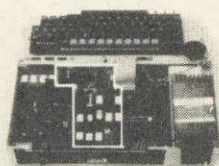
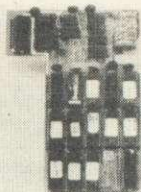

"SIDEWAYS" rom board for BBC Micro.
No soldering required £38.00 + VAT

VOLTMACE JOYSTICKS

*** 10% off list prices**



Discounted price

JSVOLT 14	Voltmace Delta 14B Joysticks	13.46
JSVOLTAD	Voltmace 14B/1 Adaptor Box	13.36
JSVOLT3B	Voltmace Delta 3B Twin Joysticks	18.09

Prices subject to variation without prior notification

TRADE ENQUIRIES WELCOME
Access & Barclaycard Accepted
Large Stocks - 24 Hour Despatch
Carriage 46p

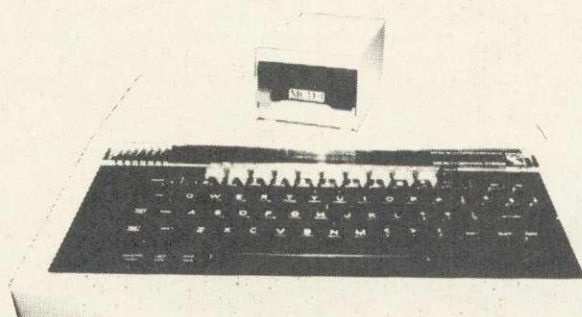

Electronequip is an authorised Acorn service centre and has been an Acorn dealer since the introduction of the Atom. Our demonstration facilities include 20 station Econet and Torchnet systems.

Ref.	BBC Micros	Ex VAT	Inc VAT
ANB01	BBC Model B Micro Computer	348.26	399.00
ANB02	BBC Model B with Econet Interface	389.14	446.00
ANB03	BBC Model B with Disc Interface	409.14	469.00
ANB04	BBC Model B with Disc & Econet Interface	450.01	516.00

NOW REDUCED TO £89 (incl VAT)

£89
3" Micro Disc £129.95
(inc. VAT)

Disc Interface & Drive
£185 (inc. VAT)



Micro Disc Drive for the BBC Micro

The Micro disc drive offers a method of low cost quick access to programs. The drive is essentially a small version of a 5¼" disc drive and offers similar features to the larger drive. The data is stored on a 3" disc, this is enclosed in a protective hard plastic cassette which features a write protect switch. The micro drive requires the standard Acorn disc interface, but a new disc filing system rom. Acorn DFS may be exchanged for the micro DFS for £12.00. The new micro disc filing system can read and write to Acorn DFS discs. Thus if a 5¼ inch and a micro floppy were connected on the same cable files could be transferred between them.
Capacity: 80.64 K bytes Transfer Rate: 125k bit/s.

BRANCHES

FAREHAM: 59 WEST STREET (0329) 230670
KINGS LYNN: 17 TENNYSON AVE. (0553) 3782
MAIL ORDER: 36-38 WEST STREET
FAREHAM, HANTS. (0329) 230670



Electronequip

36-38 West Street, Fareham, Hants (0329) 230670



BACK ISSUES £1.25

6. January 1983 MEP school launch. *FX commands for sound. Second BBC TV series. Machine code 3—two pass assembly. Disc drives for the Beeb. Programming forum. Program protection. Micros in schools—new series. Commodore Pet printer used with Beeb. BBC programs written on an Atom. Extra Atom memory.

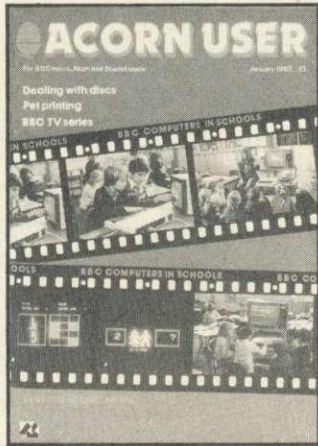

7. February 1 MHz bus examined (4). 3D Atom graphics (3). Atom BBC Board reviewed (3). Machine code 4—memory (5). BBC Computer Literacy update (1). Atom error handling (2). Micros in schools 2—getting organised (6). Hints and Tips (4). Beeb Forum (3). Reviews of *Wordwise* (2) and the Amber printer (1). ***

8. March Chess on the BBC micro (3). Sound on the Beeb (4). Printers for beginners (4). Atom analogue converter (2). Schools 3—micros and maths (6). Machine code 5—indirect addressing (3). DIY lightpen (5). MEP's *Microprimer* review (2). Atom Ross toolkit review (1). Beeb Forum (2). Assembly language and Pascal book reviews (2). ***

9. April *Hexangle* game listing (4). Bach on the Beeb (4). Hints & Tips on disc drives (4). Machine code 6—the CALL statement (4). Interfacing the 1 MHz bus (3). Schools 4—young children and micros (6). Graphics listings (2). Printers for beginners 2 (4). Reviews of BCPL, educational software and Atom software (3). ***

10. May Review of Basic II. Graphics listings. New *FX calls in OS1.2. Colour mixing on the Beeb. Jazz, blues and folk on the BBC. Schools 5—language development. DIY Beeb interface box. Atom sound board. A to Z of printing: how to get going. Hints and Tips: PROCs, discs and FNs. Printer, software and book reviews.

11. June Techniques series—sorting. Hints and Tips: 50p network. Drawing techniques and CAD. Machine code: interrupts. Schools 6—information technology. Atom Forum. Beeb Forum. Printers—write your own graphics dumps. Comparative review of *View* and *Wordwise*. Three graphics packages reviewed. Test of *Acorn User's* interface box.

12. July Techniques—hash tables. Hints and Tips: logic made easy. Recursion and graphics. Handling strings. Two ideas for passing variables. Beeb aids the blind. DIY second keyboard. Beeb Forum. Sounds on the Atom. Hardware, firmware, software and book reviews. Atom Forum.

13. August Printer graphics and dumps. Techniques—Tree structures and sorting. All the fun of the fair. 40/80

disc copier. Colour painting. Basic II: random access files. Screen dumps for Olivetti, Centronics and Seikosha. Atom strings. Reviews of Tandy CGP115 printer, five educational packs, A to D converter.

14. September Techniques—ink-blots and mazes. Painting by lightpen. DFS space explored. Beeb Forum. *Mega Monsters* game listing. Machine code graphics dumps. Atom Forum. Atom cassette recorder check. Reviews of Atom RAM boards, Cumana disc manual, *Logo* for schools, Hobbitt floppy tape and books.

15. October Women and computing. Techniques—random numbers. Review of Computer Concepts' *Beebcalc*. Fractal graphics. 57 files on 40 & 80 track discs. *Vampire* game listing. Beeb Forum. Assembly code controls tab key. Osfile merging. Atom future. Atom verify routine. Reviews of *Vu-Type*, *Procyon* Atom book, Epson FX80, Teletext adapter, disc drive, software.

16. November Techniques—impossible problems. Contour graphics. Connecting two Beebs together. XREF: sorts & lists variable, function and procedure names. Assembler utilities in Basic II. OS, VDU, *FX, OSBYTE calls—pull-out poster. Disc overlays. Adding extra Atom commands. Reviews of 7 educational packs, Atom ROM, books, games.



17. December Random graphics. Animated graphics in colour. Techniques—graphs. Hints & Tips. Universal printer dump. 6522 connected to the Electron. Saving machine code. Beeb Forum. Graphics pull-out poster. Index: July 82—July 83. Forum Extra: EQUUS. BBC helps the disabled. Schools—data processing. Transfer-

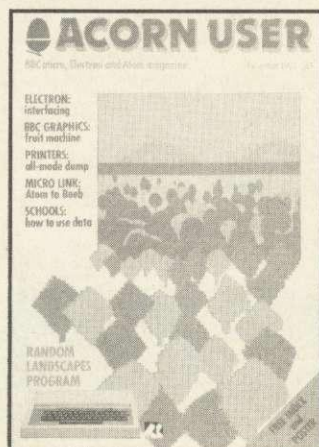

ring data between Beebs, Atoms... or Pets. Atom block demolition utility. Atom disassembler program. Reviews of software, books, educational programs from Chalksoft.

18. January 1984: Games special issue Techniques—graphs part 2. Stacks and queues, Basic and languages. Hints & Tips. Voice chip revealed. How to write games. Electron interfacing. Beeb Forum. Life graphics routines. *Defencecom* game listing. *The Train Game* listing. Machine code graphics. Where to put machine code. Schools—handling data. Juki daisywheel printer examined. Atom Forum and adventure. Reviews of utilities, software, *Beeline* wordprocessor, educational packages, two chess programs.



19. February: Adventures special issue Techniques—efficient sorts. PROC for a numeric keypad on the Beeb keyboard. 12 graphics listings. Random access filing on disc. Locking files. MCP40 printer/plotter looked at. Hints & Tips. Beeb Forum. Make discs readable on 40 and 80 track drives. Screen memory organisation. Hints on adventure design. Adventure action. Adventure ideas in computer language. Text compression. Word-crunching. VIA chip on Electron to drive a parallel printer. Atom Forum. Schools—simulation packages. Reviews: *Disc Doctor*, Leasalink's DFS upgrade, Hitachi's microdrive system, Solidisk's sideways RAM board, software.

20. March Utility: timing routine. Fractals. Teletext and mode 7 dump. ROMs reviewed. Hints & Tips. Beeb Forum. Add sounds to your games. Learn Lisp 1. Cube graphics. Printer driver for View. Basic II from Basic I. Beeb's ADC chip. Atom Forum. Listing formatter for

the Atom. Atom 'bytes free' routine. Schools—test of *Factfile*. Keyboard skills. Amcom DFS v Acorn DFS. Reviews: *Beebpen* wordprocessor, Atom expansion system, software, books.

21. April Beeb graphics on TV. 6845 chip explored. Advanced filing systems. Lisp 2. Hints & Tips. Beeb Forum. Choose disc tracks to copy. Function key editing. Teletext dumps. CES scrutinised. Passing variables. Computer Concepts' graphics ROM. Schools—simulations. Calculating Easter dates. Better programming. Atom Forum. Atom ROM routines. Converting BBC to Atom Basic. Three printers compared. Reviews: software, Aries B20 RAM board, *Toolkit*, Monitors.

22. May Bitstik graphics system. Hints & Tips. 6502 second processor examined. Lisp 3. Beeb Forum. Disc utility to keep track of available space. Statistics. Pattern graphics. OSWORD explained. 4 colour graphics listings. Second-hand disc drives. Education—do girls get a fair deal? Atom Forum. BBC to Atom Basic 2. Reviews: British Micro's Grafpad, *Edword* wordprocessor, 4 sprite generators, Opus micro-drive, *Beasty*, software.

23. June Acorn Z80 second processor. Forth. Graphics to brighten up your games. Soft Pottery graphics. Go faster and save memory space. Rapid search and load routine for tapes. How the Beeb and Electron work 1. Business: reviews and how to gently enter office computerisation. Education—adult literacy. Dumping Atom programs on the BBC. Atom Forum. Software copyright laws. Hints & Tips. Techniques—B-Trees. Beeb Forum. Reviews of monitors, printers, books, software, adventures, EPROM programmer.



*** Sold-out copies

Four issues of Acorn User are not available—July 1982, February, March and April 1983. Photocopies of articles are available at 18p a page (minimum charge 50p, inclusive of postage). Orders should be addressed to AU Photocopies, Redwood Publishing, 68 Long Acre, London WC2E 9JH. Figure in brackets indicate the number of pages for each article.

HOW TO ORDER

Fill in the order form opposite and send with your cheque or postal order for £1.25 per issue (made payable to Redwood Publishing) to Acorn User Services, PHS Mailing Ltd, PO Box 14, Horley, Surrey.

ACORN USER

SUBSCRIPTIONS

Please start my subscription to Acorn User from the next available issue as indicated:



	12 months	24 months
01: UK	£15 <input type="checkbox"/>	£30 <input type="checkbox"/>
02: Europe	£25 <input type="checkbox"/>	£50 <input type="checkbox"/>
03: Middle East	£30 <input type="checkbox"/>	£60 <input type="checkbox"/>
04: The Americas and Africa	£30 <input type="checkbox"/>	£60 <input type="checkbox"/>
05: All other countries	£35 <input type="checkbox"/>	£70 <input type="checkbox"/>

Name

Address

Please answer these questions to help us improve your magazine.

- Do you use your micro for?:
 school business hobby
 - Do you have, or intend to buy, any of the following?:
 monitor disc drive second processor
 printer modem
 - How many software packages do you think you will buy in the next 12 months?:
 0-5 6 to 10 10 or more
- I enclose my cheque/postal order/sterling bank draft payable to Redwood Publishing for £.....
- Please debit my Access/American Express/Barclaycard
 Account no.
- Signed..... Date.....
- Send this form, with your remittance, in an envelope, to Acorn User Subscriptions, Redwood Publishing, 68 Long Acre, London WC2E 9JH.

EXPRESS ORDER FORM

EXPRESS ORDER FORM

EXPRESS ORDER FORM

ACORN USER

SERVICES

SPECIAL OFFERS ON SWEAT SHIRTS

QUANTITY	DESCRIPTION	PRICE
<input type="checkbox"/> RP01	Binders	@ £4.75 £.....
<input type="checkbox"/> RP02L	Sweat shirts (large)	@ £5.00 £.....
<input type="checkbox"/> RP02M	Sweat shirts (medium)	@ £5.00 £.....
<input type="checkbox"/> RP02S	Sweat shirts (small)	@ £5.00 £.....

BACK DATED ISSUES @ £1.25 per copy

	MONTH	YEAR	
<input type="checkbox"/> AU	<input type="text"/>	<input type="text"/>	issue £.....
<input type="checkbox"/> AU	<input type="text"/>	<input type="text"/>	issue £.....
<input type="checkbox"/> AU	<input type="text"/>	<input type="text"/>	issue £.....
			Total £.....

Please add £1.00 each for overseas items.
Please allow 28 days for delivery.

Name.....

Address.....

I enclose my cheque/PO payable to Redwood Publishing for £.....

Please debit my Access/Barclaycard
 Account no.

Signed..... Date.....

Send this form, with your remittance, in an envelope, to Acorn User Services, PHS Mailing Ltd, PO Box 14, Horley, Surrey. All the above prices include postage and packing.

ACORN USER

SOFTWARE

DISC EXCHANGE SERVICE

Send in your copy of Trek or Sword Master with a cheque for £3.50 and we will exchange it for a disc. (Which runs on 40 or 80 tracks).



..... Tape(s) in exchange for disc @£3.50 each £.....

Please send me:

	Tape	Disc
..... Copies of Sword Master for BBC (32k series 1.0 OS) for Electron	£7.95	£10.95 £.....
..... Copies of Trek for BBC (32k series 1.0 OS) for Electron	£7.95	£10.95 £.....
.....	£7.95	£.....

MONTHLY PROGRAM LISTING CASSETTES

Please send me a cassette of all major BBC Micro and Electron program listings (October issue) as advertised on page 96



@ £3.75 £..... Total £.....

Name.....

Address.....

I enclose my cheque/PO payable to Redwood Publishing for £.....

Please debit my Access/Barclaycard
 Account no.

Signed..... Date.....

Send this form, with your remittance, in an envelope, to Acorn User Software, PHS Mailing Ltd, PO Box 14, Horley, Surrey. All the above prices include postage and packing.

24 HOUR PHONE SERVICE (02934) 72208

Please add £1.00 each for overseas items.
Please allow 28 days for delivery.

ACORN USER SOFTWARE

FOR THE BBC MICRO AND ELECTRON ON DISC AND CASSETTE

Two quality, full colour games to test your skill, nerve and cunning.

Each £7.95 per cassette or £10.95 per disc (40/80 track).

Price includes VAT and postage.

Both games need OS1.0, or later, and 32k.

Developed, produced and tested by Micrograf.



SWORD MASTER is one of the few two-player games around, and is designed for joystick or keyboard.

Sword Master by Ken Worrall is based on the fencing rules written in 1190 by Herman von Salza for the Deutscher Ritterorden of Teutonic Knights. It features full-colour machine code animation of a sword duel between two knights.

'A quality game with high class graphics . . . one of the most enjoyable games I have played' - Home Computer Weekly

'An immensely entertaining game with excellent graphics and animation' - Personal Computer Games

'Sword Master is a unique game' - Personal Computer News

'Slickly animated and suitably medieval' - Popular Computing Weekly



TREK was the first game to take advantage of voice synthesis on the BBC micro - and uses joystick or keyboard.

Trek puts you in charge of a Starship with the task of wiping out an alien fleet. It's an excellent adaptation of the classic game with 7 screen displays, 3 on-board computers and 2 weapon systems.

Versions have been written for BBC micro and Electron to use both machines to their full. The BBC tape uses voice synthesis (if the chips are fitted).

The game has been extensively developed from Tim Heaton's famous Trek III. It barely fits into 32K.

DISC UPGRADE SERVICE

Return your cassette of Trek or Swordmaster, and we will exchange it for a disc (which will run on 40 or 80-track drives) for just £3.50. Please specify Amcom, Watford or Acorn DFS.

PLUS

ARTICLE LISTINGS ON CASSETTE

Yes, at last, the tape you've been crying out for! Save the wear on your fingers by sending for one of our cassettes giving all the major listings in this issue.

Each cassette costs £3.75 (inclusive) for the Electron and BBC micro. This includes a menu and disc transfer routine to help you find your way around - and use on your own programs.

The tapes come with BBC programs on one side and Electron programs as the other, so it shouldn't be possible to mix the two.

Order form on page 95.

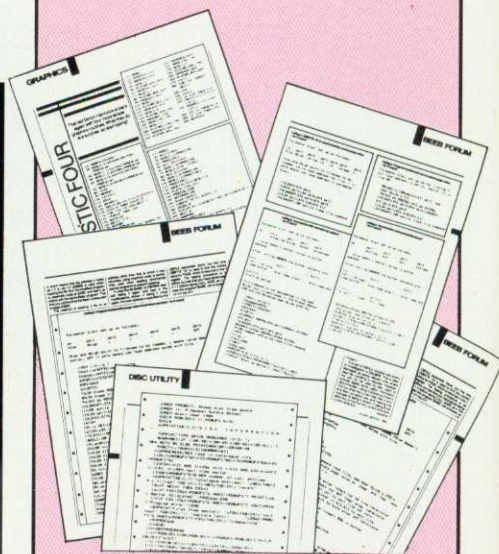

Save yourself the time and bother of typing in Acorn User listings

ORDER FORM ON PAGE 95



```

10 REM *** FLIES 2 ***
15 REM ***(c) Acorn User Oct.84***
20 MODE 4
25 VDU 19,0,4;0;
30 PROCsetup
35 PROCcanister
40 REPEAT
45  start=0 : finish=24 : step=1
50  PROCfly
55  IF dead_flag=0 THEN END
60  start=24: finish=0 : step=-1
65  PROCfly
70  IF dead_flag=0 THEN END
75 UNTIL 0
80 :
85 *** procedures here ***
90 :
95 DEF PROCfly
100 FOR pos=start TO finish STEP step
105 xpos=RND(7)+2
110 *FX19
115 PRINTTAB(pos,xpos);CHR$(224)
120 SOUND0,-15,2,1
125 key$=INKEY$(0)
130 *FX19
135 IF key$=" " THEN PROCfire
140 IF key$=CHR$(139) THEN PROCcanup
145 IF key$=CHR$(138) THEN PROCcandown
150 *FX21
155 FOR delay=0 TO 50 : NEXT
160 PRINTTAB(pos,xpos);" ";
165 IF dead_flag=1 NEXT
170 ENDPROC
175 :
180 :
185 DEF PROCdie
190 P=pos;pos=finish
195 dead_flag=0
200 *FX21,4
205 PRINTTAB(P,xpos);" ";
210 FOR down=3 TO 28
215 SOUND0,-15,3,1
220 PRINT TAB(P,down);CHR$(224)
225 FOR delay=0 TO 50 : NEXT
230 PRINT TAB(P,down);" ";
235 NEXT
240 *FX21,4
245 SOUND0,-15,6,10
250 PRINTCHR$(230);"Uhg!"
255 ENDPROC
260 :
265 :
270 DEF PROCcanister
275 PRINTTAB(xcan,ycan);CHR$(225);CHR$(
(226)
280 PRINTTAB(xcan,ycan+1);CHR$(227);CH
R$(228)
285 PRINTTAB(xcan,ycan+2);CHR$(227);CH
R$(228)

```

- Select graphics mode 4 with a blue background
- Initialise screen display
- Fly moves right. If dead END
- Fly moves left. If dead END
- Move fly across screen and at random X position. *FX19 stops screen judder
- Make buzzing noise and test keyboard
- If space or ↑ or ↓ key pressed call correct procedure. *FX21 flushes keyboard buffer
- After a delay rub out fly with a space
- Fly dead. Clear flag and stop buzzing noise with *FX21, 4
- Start 'move fly down the screen' routine
- Do dying noise
- Complete 'fly moving down the screen' and turn sound off
- Make a 'thud' and print dead fly
- Print fly spray can on right of screen



Continued ▶

◀ Continued

```

290 ENDPROC
295 :
300 :
305 DEF PROCcanup
310 IF ycan=2 THEN ENDPROC
315 PRINTTAB(xcan,ycan+2);" "
320 ycan=ycan-1
325 PROCcanister
330 ENDPROC
335 :
340 :
345 DEF PROCcandown
350 IF ycan=11 THEN ENDPROC
355 PRINTTAB(xcan,ycan);" "
360 ycan=ycan+1
365 PROCcanister
370 ENDPROC
375 :
380 :
385 DEF PROCfire
390 *FX21
395 PRINTTAB(pos+1,xpos);"help!"
400 FOR shot=xcan-1 TO pos STEP -1
405 PRINTTAB(shot,ycan);CHR$(229)
410 FOR wait=0 TO 10 : NEXT
415 PRINTTAB(shot,ycan);" "
420 NEXT
425 squirts=squirts+1
430 PRINTTAB(10,30);squirts
435 PRINTTAB(pos+1,xpos);" "
440 IF ycan=xpos THEN PROCdie :END
445 ENDPROC
450 :
455 :
460 DEF PROCsetup
465 VDU 23,1,0;0;0;0;
470 VDU 23,224,36,24,90,189,255,60,24,
36
475 VDU 23,225,3,7,31,31,7,7,7,15
480 VDU 23,226,192,224,224,224,224,224,224
,224,240
485 VDU 23,227,31,63,63,63,63,63,63,63
490 VDU 23,228,248,248,248,248,248,248,248
,248,248
495 VDU 23,229,160,84,170,85,168,80,16
0,0
500 VDU 23,230,0,0,0,0,36,24,60,126
505 *FX4,1
510 xcan=32 : ycan=11 : dead_flag=1
515 squirts=0
520 PRINTTAB(2,30);"Squirts:";squirts
525 PRINTTAB(10,0);"*** Flies Two ***"
530 ENDPROC
    
```

— If can at Y tab 2 do nothing, otherwise rub out bottom of can and print it one position up

— If can at Y tab 11 do nothing, otherwise rub out top of can and print it one position down

— Move spray across the screen until at position of fly

— Update squirt count and erase 'Help!'

— If spray hits fly then kill fly

— Turn cursor off
— Define fly

— Define fly spray can

— Define spray and dead fly

— Make cursor keys produce ASCII codes and initialise variables

— Print headings



Listing 4. Envelope generator for the BBC

```

10 REM Listing 4
20 ON ERROR RUN
30 MODE1
40 PROCinitialise
50 REPEAT
60 PROCscreen
70 PROCsound
80 PROCinput
90 UNTIL 0
100 :
110 DEFPROCinitialise
120 VDU19,0,2,0,0,0:REM Green background
130 VDU19,2,0,0,0,0:REM Colour 2 - black
140 VDU19,3,4,0,0,0:REM Colour 3 - blue
150 @%=4
160 T=2:PI1=0:PI2=0:PI3=0
170 PN1=0:PN2=0:PN3=0
180 AA=127:AD=-1:AS=0:AR=0
190 ALA=126:ALD=0:P=100:D=50
200 ENDPROC
210 :
220 DEFPROCscreen
230 CLS
240 PROCdouble("ENVELOPE DESIGNER",10,1)
250 COLOUR2:PRINT
260 PRINT " T=Step length          1/255 = "T
270 COLOUR 1:PRINT
280 PRINT"PI1=Pitch Increment 1  -128/127 = "PI1
290 PRINT"PI2=Pitch Increment 2  -128/127 = "PI2
300 PRINT"PI3=Pitch Increment 3  -128/127 = "PI3
310 PRINT"PN1=Pitch Step No. 1    0/255 = "PN1
320 PRINT"PN2=Pitch Step No. 2    0/255 = "PN2
330 PRINT"PN3=Pitch Step No. 3    0/255 = "PN3
340 COLOUR 3:PRINT
350 PRINT" AA=Amplitude Attack      1/127 = "AA
360 PRINT" AD=Amplitude Decay     -127/127 = "AD
370 PRINT" AS=Amplitude Sustain    0/-128 = "AS
380 PRINT" AR=Amplitude Release    0/-128 = "AR
390 PRINT" ALA=Amp. Attack Level   0/126 = "ALA
400 PRINT" ALD=Amp. Decay Level    0/126 = "ALD
410 COLOUR 2:PRINT
420 PRINT" P=Pitch                  0/255 = "P
430 PRINT" D=Duration              -1/255 = "D
440 COLOUR 129:COLOUR 3:PRINT
450 PRINT"ENVELOPE1,";T",";PI1",";PI2",";PI3",";
460 PRINT;PN1",";PN2",";PN3",";AA",";AD",";AS",";
AR",";ALA",";ALD
470 COLOUR 132
480 ENDPROC
490 :
500 DEFPROCsound
510 ENVELOPE1,T,PI1,PI2,PI3,PN1,PN2,PN3,AA,AD,
AS,AR,ALA,ALD
520 SOUND &11,1,P,D
530 ENDPROC
540 :
550 DEFPROCinput
560 COLOUR 1:PRINT
570 PRINT " Press return for repeat note"
580 COLOUR 3:PRINT
590 INPUT"Change which parameter? "Q$
600 IFQ$="T" THEN INPUT"Value for T "T
610 IFQ$="PI1" THEN INPUT"Value for PI1 "PI1
620 IFQ$="PI2" THEN INPUT"Value for PI2 "PI2
630 IFQ$="PI3" THEN INPUT"Value for PI3 "PI3
640 IFQ$="PN1" THEN INPUT"Value for PN1 "PN1
650 IFQ$="PN2" THEN INPUT"Value for PN2 "PN2
660 IFQ$="PN3" THEN INPUT"Value for PN3 "PN3
670 IFQ$="AA" THEN INPUT"Value for AA "AA
680 IFQ$="AD" THEN INPUT"Value for AD "AD
690 IFQ$="AS" THEN INPUT"Value for AS "AS
700 IFQ$="AR" THEN INPUT"Value for AR "AR
710 IFQ$="ALA" THEN INPUT"Value for ALA "ALA
720 IFQ$="ALD" THEN INPUT"Value for ALD "ALD
730 IFQ$="P" THEN INPUT"Value for P "P
740 IFQ$="D" THEN INPUT"Value for D "D
750 ENDPROC
760 :
770 DEFPROCdouble(A$,x,y)
780 X%=0:Y%=13:A%=10:d=&D00
790 C$=CHR$(240)+CHR$8+CHR$10+CHR$(241)
800 FOR N=1 TO LEN(A$)
810 B$=MID$(A$,N,1):?d=ASC(B$):CALL&FFF1
820 VDU23,240,d?1,d?1,d?2,d?2,d?3,d?3,d?4,d?4
830 VDU23,241,d?5,d?5,d?6,d?6,d?7,d?7,d?8,d?8
840 PRINT TAB(x+N-1,y)C$:NEXT N
850 ENDPROC

```

99

Listing 5. Envelope generator for the Electron

```

10 REM Listing 5
20 ON ERROR RUN
30 MODE1
40 PROCinitialise
50 REPEAT
60 PROCscreen
70 PROCsound
80 PROCinput
90 UNTIL 0
100 :
110 DEFPROCinitialise
120 VDU19,0,2,0,0,0:REM Green background
130 VDU19,2,0,0,0,0:REM Colour 2 - black
140 VDU19,3,4,0,0,0:REM Colour 3 - blue
150 @%=4
160 T=2:PI1=0:PI2=0:PI3=0
170 PN1=0:PN2=0:PN3=0
180 AA=126:AD=0:AS=0:AR=-126
190 ALA=126:ALD=126:P=100:D=50
200 ENDPROC
210 :
220 DEFPROCscreen
230 CLS
240 PROCdouble("ENVELOPE DESIGNER",10,1)
250 COLOUR2:PRINT
260 PRINT " T=Step length          1/255 = "T
270 COLOUR 1:PRINT
280 PRINT"PI1=Pitch Increment 1  -128/127 = "PI1
290 PRINT"PI2=Pitch Increment 2  -128/127 = "PI2
300 PRINT"PI3=Pitch Increment 3  -128/127 = "PI3
310 PRINT"PN1=Pitch Step No. 1    0/255 = "PN1
320 PRINT"PN2=Pitch Step No. 2    0/255 = "PN2
330 PRINT"PN3=Pitch Step No. 3    0/255 = "PN3
340 COLOUR 2:PRINT
350 PRINT" P=Pitch                  0/255 = "P
360 PRINT" D=Duration              -1/255 = "D
370 COLOUR 129:COLOUR 3:PRINT
380 PRINT"ENVELOPE1,";T",";PI1",";PI2",";PI3",";
390 PRINT;PN1",";PN2",";PN3",";AA",";AD",";
AS",";AR",";ALA",";ALD
400 COLOUR 132
410 ENDPROC
420 :
430 DEFPROCsound
440 ENVELOPE1,T,PI1,PI2,PI3,PN1,PN2,PN3,AA,
AD,AS,AR,ALA,ALD
450 SOUND &11,1,P,D
460 ENDPROC
470 :
480 DEFPROCinput
490 COLOUR 1:PRINT
500 PRINT " Press return for repeat note"
510 COLOUR 3:PRINT
520 INPUT"Change which parameter? "Q$
530 IFQ$="T" THEN INPUT"Value for T "T
540 IFQ$="PI1" THEN INPUT"Value for PI1 "PI1
550 IFQ$="PI2" THEN INPUT"Value for PI2 "PI2
560 IFQ$="PI3" THEN INPUT"Value for PI3 "PI3
570 IFQ$="PN1" THEN INPUT"Value for PN1 "PN1
580 IFQ$="PN2" THEN INPUT"Value for PN2 "PN2
590 IFQ$="PN3" THEN INPUT"Value for PN3 "PN3
600 IFQ$="P" THEN INPUT"Value for P "P
610 IFQ$="D" THEN INPUT"Value for D "D
620 ENDPROC
630 :
640 DEFPROCdouble(A$,x,y)
650 X%=0:Y%=13:A%=10:d=&D00
660 C$=CHR$(240)+CHR$8+CHR$10+CHR$(241)
670 FOR N=1 TO LEN(A$)
680 B$=MID$(A$,N,1):?d=ASC(B$):CALL&FFF1
690 VDU23,240,d?1,d?1,d?2,d?2,d?3,d?3,d?4,d?4
700 VDU23,241,d?5,d?5,d?6,d?6,d?7,d?7,d?8,d?8
710 PRINT TAB(x+N-1,y)C$:NEXT N
720 ENDPROC

```

See 'Fatman on the Move', page 65

Harry Sinclair's 'Design' program last month enabled you to create your own sprite cartoon characters. This program, 'Mover', lets you move them about the screen and animate them

```

10*TV255
20REM*LO.DATANAME
30*T.
40MODE2
50PROCASS
60COLOUR138:PRINTTAB(6,1) "          ":COLOUR0:PRINTTAB(6,2) " MOVER ";TAB(6,3) "
   ":COLOUR128
70COLOUR6
80PRINTTAB(4,7)"Do you want:";:COLOUR8:PRINT"1.":;COLOUR6:PRINT"8 frame ani
mation";:COLOUR15:PRINT"2.":;COLOUR6:PRINT"Single character";:TAB(2)"movemen
t"
90*FX15
100COLOUR3:PRINT""Please choose.":;REPEAT PRINTTAB(16,22)CHR#127;:INPUTTAB(1
4,22) " G:UNTILG=1 OR G=2:COLOUR6
110*FX15
120IF G=1 ?&74=1 ELSE ?&74=0
130IF G=2 PRINT""Character number?":;REPEAT PRINTTAB(18,26) "   ":INPUTTAB(17
,26) " G:UNTIL G>=0 AND G<9: ?&70=G
140CLS
150*FX15
160PRINTTAB(4,12)"what delay ?":INPUTTAB(3,15)"(0 = no delay)"del%
170CLS
180VDU23,1,0;0;0;0;0;
190PRINTTAB(0,8)"Cursor keys control""character movement."
200COLOUR2:PRINTTAB(0,15)"ESCAPE to exit."
210COLOUR5:PRINTTAB(0,22)"SPACE to continue...":COLOUR12
220REPEAT UNTIL GET=32
230CLS
240FORI%=0 TO 200:Q%=RND(20000)+&3000: ?Q%=&2A:NEXT:PRINTTAB(6,14) "MOVER!!"
250IF ?&74=1 ?&70=0
260 ?&71=40: ?&72=100
270 ?&76=del%-1      720BEQ limit          1190STA&221          1630INY
280CALL cv           730SEC              1200CLI              1640LDA£Downpressed
                       740SBC£4         1210LDA£f14           MOD256
                       750STA&72        1220LDX£4            1650STA tbl,Y
                       760JMP draw       1230JSR &FFF4         1660INY
                       770.animation    1240LDA&12EF         1670LDA£Downpressed
                       780LDA&75        1250STA&78           DIV256
                       790BEQ right      1260SEC              1680STA tbl,Y
                       800LDA&71        1270SBC£8            1690INY
                       810ANDE3         1280STA&79           1700LDA£Uppressed
                       820CLC           1290LDA&78           MOD256
                       830ADC£4         1300STA Rblock2+1   1710STA tbl,Y
                       840STA&70        1310STA b2+3        1720INY
                       850BNE finished   1320CLC              1730LDA£Uppressed
                       860.right        1330ADC&78           DIV256
                       870LDA&71        1340STA Rblock3+1   1740STA tbl,Y
                       880ANDE3         1350STA b3+3        1750.keycheck
                       890STA&70        1360CLC              1760LDA&£D
                       900.finished     1370ADC&78           1770BEQ checkEC
                       910RTS           1380STA Rblock4+1   1780JSR keyvalid
                       920.mover        1390STA b4+3        1790BEQ checkEC
                       930.speedcontrol  1400LDA&78           1800JSR getaddress
                       940LDX&76        1410LSRA             1810JSR gotomover
                       950BMI fast       1420LSRA             1820.checkEC
                       960.delay        1430LSRA             1830LDA&£C
                       970LDA&77        1440STA&7A           1840BEQ keycheck
                       980.check        1450LDA££50          1850JSR keyvalid
                       990CMP&77        1460SEC              1860BEQ keycheck
                       1000BEQ check     1470SBC&7A           1870JSR getaddress
                       1010DEX           1480STA&7A           1880JSR gotomover
                       1020BPL delay     1490RTS              1890JMP keycheck
                       1030.fast        1500.start           1900.keyvalid
                       1040JMP display   1510LDY£2           1910CMP££F0
                       1050.nv          1520LDA£Leftpressed  1920BNE checkleft
                       1060PHP          MOD256                1930PLA
                       1070DEC&77       1530STA tbl,Y       1940PLA
                       1080PLP          1540INY              1950JMP escape
                       1090RTS          1550LDA£Leftpressed  1960.checkleft
                       1100.cv          DIV256                1970CMP££99
                       1110LDA&220      1560STA tbl,Y       1980BNE checkright
                       1120STA olv       1570INY              1990LDA£1
                       1130LDA&221      MOD256                2000RTS
                       1140STA olv+1    1590STA tbl,Y       2010.checkright
                       1150SEI          1600INY              2020CMP££F9
                       1160LDA £nv MOD256 1610LDA£Rightpressed 2030BNE checkdown
                       1170STA&220      DIV256                2040LDA£2
                       1180LDA £nv DIV256 1620STA tbl,Y       2050RTS

```

RUNNING 'MOVER'

THE listing can be broken down into two sections: Basic and assembler. A prior knowledge of the latter is not necessary for entering the program—just type it in exactly as you see it. Before starting ensure that PAGE has been set to &1900, whether you have tape or disc. To do this type:

```
PAGE = &1900 <return>
NEW <return>
```

You'll find it much easier to enter the assembler listing first. For tips on doing this see yellow page X in last month's issue. Enter lines 330 to 4200 and then save what you have entered so far to tape or disc, just in case of accidents. Change line 340 to read:

```
FOR I% = 0 TO 3 STEP 3
```

Now add the following two lines:

```
1 PROCASS
2 END
```

Run the program and correct any syntax errors that occur, then add the following lines to your program:

```
1 PROCASS
2 Z% = 0
3 FOR N% = &E00 TO &1084
```

```
4 Z% = Z% + ?N%
5 NEXT
6 PRINT "CHECKSUM IS ";Z%
7 END
```

Now re-run the program and after a short delay the result

```
CHECKSUM IS :73536
```

should be displayed. If this is not the case you have made a mistake in entering the assembler—so check again carefully!

If all is well re-enter line 340 as:

```
340 FOR I% = 0 TO 2 STEP 2
```

Now delete lines 1 to 7 inclusive and enter the rest of the listing, and you're ready.

CONVERTING FOR THE ELECTRON

MOVER will run on the Elk if a few alterations are made to the listing. The alterations are in the assembler as follows:

```
1970 CMP £&88
2020 CMP £&84
2070 CMP £&89
2120 CMP £&8D
2790 LDA &C36D,Y
2820 LDA &C36D,Y
```

The checksum value will be 73310.

2060.checkdown	2590STA(&B4),Y	3130LDA£&80	3670STA&8B,X
2070CMP£&A9	2600.Rblock4	3140CLC	3680DEX
2080BNE checkup	2610LDA&C00,Y	3150ADC&84	3690DEX
2090LDA£3	2620STA(&B6),Y	3160STA&86	3700BPL hi
2100RTS	2630DEY	3170LDA£2	3710.sa
2110.checkup	2640BPL replace	3180ADC&85	3720LDX&73
2120CMP£&B9	2650.first	3190STA&87	3730.mi
2130BNE invalidkey	2660LDA£0	3200LDA£8	3740DEX
2140LDA£4	2670STA&80	3210SEC	3750BNE sh
2150RTS	2680STA&82	3220SBC&73	3760LDX£6
2160.invalidkey	2690LDA£&30	3230STA&73	3770.lo
2170LDA£0	2700STA&81	3240LDA&70	3780LDA&8B,X
2180RTS	2710LDA&72	3250ASLA	3790SEC
2190.getaddress	2720AND£7	3260TAY	3800SBC&79
2200ASLA	2730STA&73	3270LDA&12F0,Y	3810STA&8B,X
2210TAY	2740EOR&72	3280CLC	3820DEX
2220LDA tbl,Y	2750LSRA	3290ADC&73	3830DEX
2230STA gotomover+1	2760LSRA	3300LDX£0	3840BPL lo
2240INY	2770TAY	3310STA&8B,X	3850.sh
2250LDA tbl,Y	2780INY	3320CLC	3860DEY
2260STA gotomover+2	2790LDA&C375,Y	3330.loop	3870LDA(&80),Y
2270RTS	2800STA&80	3340ADC&78	3880STA&C00,Y
2280.gotomover	2810DEY	3350INX	3890TXA
2290JSR&8000	2820LDA&C375,Y	3360INX	3900BMI b2
dummy address	2830CLC	3370CPX£8	3910LDA(&8B),Y
2300RTS	2840ADC&81	3380BCS ex	3920BEQ b2
2310.escape	2850STA&81	3390STA&8B,X	3930STA(&80),Y
2320SEI	2860LDA&71	3400BCC loop	3940.b2
2330LDA olv	2870LDX£3	3410.ex	3950LDA(&82),Y
2340STA&220	2880.LOOP	3420CLC	3960STA&C00,Y
2350LDA olv+1	2890ASLA	3430INY	3970LDA(&8A),Y
2360STA&221	2900ROL&B2	3440LDA&12F0,Y	3980BEQ b3
2370CLI	2910DEX	3450LDX£0	3990STA(&82),Y
2380LDA£15	2920BNE LOOP	3460.loop2	4000.b3
2390LDX£0	2930ADC&80	3470STA&89,X	4010LDA(&84),Y
2400JSR&FFF4	2940STA&80	3480INX	4020STA&C00,Y
2410RTS	2950LDA£0	3490INX	4030LDA(&8C),Y
2420.tbl	2960ADC&82	3500CPX£8	4040BEQ b4
2430NOP:NOP:NOP	2970ADC&81	3510BCC loop2	4050STA(&84),Y
2440NOP:NOP:NOP	2980STA&81	3520LDY&78	4060.b4
2450NOP:NOP:NOP	2990LDA£&80	3530INC&73	4070LDA(&86),Y
2460.olv	3000CLC	3540LDX&73	4080STA&C00,Y
2470NOP:NOP	3010ADC&80	3550.m1	4090TXA
2480.display	3020STA&82	3560TYA	4100BPL mle
2490LDY&78	3030LDA£2	3570BEQ co	4110LDA(&8E),Y
2500DEY	3040ADC&81	3580AND£7	4120BEQ mle
2510.replace	3050STA&83	3590BNE mi	4130STA(&86),Y
2520LDA&C00,Y	3060LDA£&80	3600TXA	4140.mle
2530STA(&80),Y	3070CLC	3610BPL sa	4150JMP ml
2540.Rblock2	3080ADC&82	3620LDX£6	4160.co
2550LDA&C00,Y	3090STA&84	3630.hi	4170RTS
2560STA(&82),Y	3100LDA£2	3640LDA&8B,X	4180J
2570.Rblock3	3110ADC&83	3650CLC	4190NEXT
2580LDA&C00,Y	3120STA&85	3660ADC&79	4200ENDPROC

See 'Take Command of the 8271 Chip', page 81

Listing 1. Disc copying program by Richard Harris. It will make back-up copies of most – if not all – discs. With minor modification (see page 86) it can also be used to change protected discs

```

10 DIM SIZE%(4),gap%(4),block% 30,dat
a% 2200
15 MODE7
20 PROCsetblock:PROCsetup
25 FOR K%=0 TO 39:REM for 40 track dr
ive
40 PROCseek(0,K%):PROCseek(1,K%):IF F
Nid(0,K%) THEN 110
50 PROCsettr(?data%):PROCformat
60 PROCvalues
65 FOR S%=S% TO S%+s%-1:REM for all s
ectors on track
66 REM assumes consequetive numbered
sectors; may need changing for some disc
s
70 D%=FNload(0,T%,S%):REM load from d
rive 0
80 PROCsave(1,T%,S%,D%):REM copy onto
drive 1
85 NEXT
90 PROCsettr(K%)
100 J%=FNid(1,K%)
110 NEXT
980 STDP
990
1000 DEF PROCsetblock:REM set up OSWORD
parameters
1010 ?block%=0:block%!!1=data%
1020 X%=block%MOD256:Y%=block%DIV256
1030 ENDPROC
1040
1200 DEF PROCseek(dri%,tr%)
1210 ?block%=dri%:block%?5=1:block%?6=&
69
1220 block%?7=tr%
1230 PROCdisc(8)
1240 ENDPROC
1250
1400 DEF PROCdisc(J%):REM call OSWORD
1410 A%=&7F
1420 CALL &FFF1
1430 IF block%?J% PRINTTAB(10,22)"&Erro
r number ";block%?J%:PRINTTAB(10,24)"iPR
ESS SPACE":VDU7:REPEAT UNTIL GET=32
1435 REM ignore deleted data and track
not found (may not be on disc): other er
rors probably fatal
1440 ENDPROC
1450
1600 DEF FNid(dri%,tr%):REM reads one t
hen all ID fields on track
1610 block%?5=3:block%?6=&5B:block%?7=t
r%:block%?8=0:block%?9=1
1620 ?block%=dri%
1630 PROCdisc(10):IF block%?10<>0 =1:RE
M escape if track not present
1640 size%=data%?3:s%=SIZE%(size%)
1650 block%?9=s%
1660 CLS:PROCdisc(10)
1670 FOR J%=0 TO (s%-1)*4 STEP 4
1680 PRINT"track ";data%?J%:" sector ";
data%?(J%+2):" size ";data%?(J%+3)
1690 NEXT
1700 =0
1710
1800 DEF PROCsettr(J%):REM change curre
nt track registers
1810 block%?5=2:block%?6=&3A:block%?7=&
12:block%?8=J%
1820 PROCdisc(9)
1830 block%?7=&1A:PROCdisc(9)
1840 ENDPROC
1850
2000 DEF PROCformat:REM formats with sa
me ID fields as read in from first disc
2010 block%?0=1:block%?5=5:block%?6=&63
:block%?7=?data%:block%?8=gap%(size%):bl
ock%?9=(size%*32)+s%:block%?10=0:block%?
11=16
2020 PROCdisc(12)
2030 ENDPROC
2040
2200 DEF PROCvalues
2210 T%=?data%:S%=255
2220 FOR J%=2 TO (s%-1)*4+2 STEP 4
2230 IF data%?J%<S% S%=data%?J%
2240 NEXT
2245 REM sets T% to logical track, S% t
o lowest logical sector number
2250 ENDPROC
2260
2400 DEF FNload(F%,G%,H%)
2410 ?block%=F%:block%?5=3:block%?6=&57
2420 block%?7=G%:block%?8=H%:block%?9=(
size%*32)+1
2430 PROCdisc(10)
2440 IF block%?10=&20 =1:REM if deleted
data found
2450 =0:REM if normal data
2460
2600 DEF PROCsave(F%,G%,H%,I%)
2610 ?block%=F%:block%?5=3
2620 block%?7=G%:block%?8=H%:block%?9=(
size%*32)+1
2630 IF I% block%?6=&4F ELSE block%?6=&
4B
2640 PROCdisc(10)
2650 ENDPROC
2660
5000 DEF PROCsetup
5010 FOR J%=0 TO 4
5020 READ SIZE%(J%),gap%(J%)
5030 NEXT
5040 DATA 18,11,10,21,5,74,2,255,1,0
5050 ENDPROC
5060

```

Listing 2. Alan Crabb's program reads a disc's catalogue and prints the load/exec/length values of all the files

```

10 REM *****
20 REM **      READ FILES      **
30 REM **
40 REM ** Copyright (C) A.M.CRABB **
50 REM **      23 July 1984      **
60 REM **      for ACORN USER    **
70 REM *****
80
90 REM Reserve workspace
100 DIM cli 6,space &11,files &D8
110 REM Define array for filenames
120 DIM file$(30)
130
140 REM Define OS call addresses
150 oscli=&FFF7
160 osword=&FFF1
170 osfile=&FFDD
180 osgbpb=&FFD1
190
200 REM Read disc 'cycle number'
210 ?space=0 :REM Drive number
220 X%=&7D
230 X%=space MOD 256
240 Y%=space DIV 256
250 CALL osword
260 REM returned in space?0
270
280 REM No files yet
290 numfile=TRUE
300
310 REM Read on all directories as
320 REM osgbpb reads only current
330 REM directory
340 FOR dir=33 TO 96
350
360 REM Check for " and : - illegal
370 IF dir=34 OR dir=52 GOTO 770
380
390 REM Perform *DIR
400 $cli="*DIR "+CHR$ dir
410 X%=$cli MOD 256
420 Y%=$cli DIV 256
430 CALL oscli
440
450 REM Set up parameter block
460 space!1=files
470 space!5=31 :REM Max no. files
480 space!9=0
490 REM Call reads files on directory
500 A%=0
510 X%=space MOD 256
520 Y%=space DIV 256
530 CALL osgbpb
540
550 numofiles=30-space!5
560 REM No files on directory
570 IF numofiles=TRUE GOTO 770
580
590 REM Read each file, stored as
600 REM length of name, name
610 point=files
620 FOR file=0 TO numofiles
630 length=?point
640 A$=""
650 FOR char=1 TO length
660 A$=A$+CHR$(char?point)
670 NEXT
680
690 REM 1 more file, store in array
700 numfile=numfile+1
710 REM Add directory character
720 A$=CHR$(dir)+"."+A$
730 file$(numfile)=A$
740 REM Move pointer to next file
750 point=point+length+1
760 NEXT
770 NEXT
780
800 REM Print all file names
810 FOR file=0 TO numfile
820 PRINT file$(file);
830 PRINT~FN!dad(file$(file));
840 PRINT~FN!xad(file$(file));
850 PRINT~FN!len(file$(file))
860 NEXT
870 END
880
890 REM *****
900
1000 REM Returns load address of file
1010 DEF FN!dad(A$)
1020 LOCAL AX,X%,Y%
1030 PROCread
1040 =space!2
1050
1060 REM Returns exec address of file
1070 DEF FN!xad(A$)
1080 LOCAL AX,X%,Y%
1090 PROCread
1100 =space!6
1110
1120 REM Returns length of file
1130 DEF FN!len(A$)
1140 LOCAL AX,X%,Y%
1150 PROCread
1160 =space!10
1170
2000 REM Performs read addresses
2010 DEF PROCread
2020 !space=files
2030 $files=A$
2040 A%=5
2050 X%=space MOD 256
2060 Y%=space DIV 256
2070 CALL osfile
2080 ENDPROC

```

See 'See How They Sort', page 117

Program 1. Select a sort from the menu and watch the sorting process, colour-coded to make it easy to follow

```

10 REM *** ALLSORT ***
20 REM G.B.HILL 1984
30 REM version 6
40 ON ERROR GOTO 340
50 MODE 7
60 REM*** MAIN PROGRAM ***
70
80 PROCsetup
90 REPEAT
100 FOR I=1 TO max:dest$(I)=source$(I):NEXT
110 PROCmenu
120 IF choice=1 THEN PROCbubble
130 IF choice=2 THEN PROCshuttle
140 IF choice=3 THEN PROCinsertion
150 IF choice=4 THEN PROCselection
160 IF choice=5 THEN PROCshell
170 IF choice=6 THEN PROCquick(1,max)
180 IF choice=7 THEN PROCtree
190 IF choice<num_of_sorts THEN PROCwait
200 UNTIL choice=num_of_sorts
210 VDU26,12,23,1,1;0;0;0;
220 PRINT"RETURNED TO""BASIC"
230 END
240
250 REM *** DATA ***
260
270 DATA BUBBLE,SHUTTLE,INSERTION,SELECTION,SHELL,QUICK,TREE,END.
280
290 DATA FRED,GEORGE,ALEX,JOE,BERT,BERNARD,HARRY,ZEBIDEE,PETER
300 DATA JEREMY,GEORGE,PETER,JIM,SIMON,TONY,JOHN
***
310
320 REM *** PROCEDURES ***
330
340 REM ERROR ROUTINE
350 IF ERR=17 THEN RUN
360 REPORT
370 PRINT" at line ";ERL
380 END
390
400 DEFPROCsetup
410 waittime=100
420 T=TRUE:F=FALSE
430 nothing=128:red=129:green=130:yellow=131:blue=132:magenta=133:cyan=134:white=135
440 DIM source$(100),dest$(100),sort$(20)
450 RESTORE 270
460 I=0
470 REPEAT
480 I=I+1
490 READ sort$(I)
500 UNTIL sort$(I)="END."
510 num_of_sorts=I
520 RESTORE 290
530 I=0
540 REPEAT
550 I=I+1
560 READ source$(I)
570 UNTIL source$(I)="***"
580 max=I-1
590 ENDPROC
600
610 DEFPROCmenu
620 PROCdouble("MENU for")
630 FOR I=1 TO num_of_sorts
640 PRINTTAB(4,I+2);STR$I;" ";sort$(I)
650 NEXT
660 VDU23,1,1;0;0;0;10,13
670 choice=FNchoose("1 to "+STR$num_of_sorts)
680 IF choice=num_of_sorts THEN ENDPROC
690 VDU23,1,0;0;0;0;
700 PROCdouble(sort$(choice))
710 FORI=1 TO max:PRINTTAB(8,I+1);source$(I):NEXT
T
720 PROClist
730 ENDPROC
740
750 DEFPROCdouble(d$)
760 LOCAL d
770 d=(40-LENd$-9) DIV 2
780 VDU26,12:PRINTTAB(d,2);CHR$cyan;CHR$141;d$;CHR$yellow;"SORT"
790 PRINTTAB(d,3);CHR$cyan;CHR$141;d$;CHR$yellow;"SORT"
800 VDU28,0,23,39,4
810 ENDPROC
820
830 DEFPROCwait
840 PROCsection(1,max,white)
850 PRINTTAB(0,19);CHR$133;"Press SPACE bar to continue.":REPEAT:UNTIL GET=32
860 ENDPROC
870
880 DEFFNchoose(M$)
890 REPEAT
900 PRINT
";:VDU13
910 PRINT"Type ";M$;" then <RETURN> ";
920 INPUT"n$
930 In=VAL(LEFT$(M$,1))
940 IF VAL(RIGHT$(M$,3))=0 THEN rn=VAL(RIGHT$(M$,2)) ELSE rn=VAL(RIGHT$(M$,3))
950 ok=ASCn$<58 AND VALn$>=In AND VALn$<=rn AND VALn$=INT(VALn$)
960 IF NOT ok THEN VDU7,11,13:FOR I=1 TO 39:VDU32:NEXT:VDU13
970 UNTIL ok
980 =VALn$
990
1000 DEFPROCswap(i,j)
1010 sorted=FALSE
1020 spare$=dest$(i)
1030 dest$(i)=dest$(j)
1040 dest$(j)=spare$
1050 PRINTTAB(21,i+1);dest$(i);" "
1060 PRINTTAB(21,j+1);dest$(j);" "
1070 PROCmark(i,j,cyan,T)
1080 ENDPROC
1090
1100 DEFPROClist
1110 LOCAL II
1120 FOR II=1 TO max
1130 PRINTTAB(21,II+1);dest$(II);" "
1140 NEXT
1150 ENDPROC
1160
1170 DEFPROCmark(i,j,colour,pause)
1180 PRINTTAB(20,i+1);CHR$colour;TAB(20,j+1);CHR$colour
1190 IF pause THEN PROCpause:PROCmark(i,j,nothing,F)
1200 ENDPROC
1210
1220 DEFPROCpause
1230 Z=INKEY(waittime)
1240 *FX15,1
1250 ENDPROC
1260
1270 DEFPROCsection(i,j,colour)
1280 FOR II=i TO j
1290 PRINTTAB(18,II+1);CHR$colour;CHR$colour;CHR$colour
1300 NEXT
1310 ENDPROC
1320
1330 DEFPROCbubble
1340 FOR I=1 TO max-1
1350 sorted=TRUE
1360 FOR J=max TO I+1 STEP -1
1370 PROCmark(J-1,J,green,T)
1380 IF dest$(J-1)>dest$(J) THEN PROCswap(J,J-1)
1390 NEXT
1400 IF sorted THEN I=max-1 ELSE PROCpause
1410 NEXT
1420 ENDPROC
1430
1440 DEFPROCshuttle
1450 I=0
1460 top=0:bottom=max:inc=1:sorted=TRUE
1470 REPEAT
1480 sorted=TRUE
1490 REPEAT

```

```

1500 I=I+inc
1510 PROCmark(I,I+1,green,T)
1520 IF dest$(I)>dest$(I+1) THEN PROCswap(I,I+1)
1530 IF I+inc=top THEN top=top+1:inc=1
1540 IF I+inc=bottom THEN bottom=bottom-1:inc=-1
1550 UNTIL I=top OR I=bottom
1560 UNTIL bottom<=top+1 OR sorted
1570 ENDPROC
1580
1590 DEFPROCinsertion
1600 FOR I=2 TO max
1610 PROCpause
1620 PRINTTAB(19,I);" ";TAB(19,I+1);"J"
1630 FOR J=I TO 2 STEP -1
1640 PROCmark(J-1,J,green,T)
1650 IF dest$(J-1)>dest$(J) THEN PROCswap(J,J-1)
ELSE J=2
1660 NEXT
1670 NEXT
1680 ENDPROC
1690
1700 DEFPROCselection
1710 FOR I=1 TO max-1
1720 lowindex=I
1730 PRINTTAB(19,I);" ";TAB(19,I+1);"J";CHR$yellow
w:
1740 FOR J=I+1 TO max
1750 PROCmark(O,J,green,T)
1760 IF dest$(J)<dest$(lowindex) THEN PROCmark(O,
lowindex,white,F):lowindex=J
1770 PROCmark(O,lowindex,yellow,F)
1780 NEXT
1790 IF lowindex<<I THEN PROCswap(I,lowindex) ELS
E PROCmark(O,I,white,F)
1800 NEXT
1810 ENDPROC
1820
1830 DEFPROCshell
1840 inc=max DIV 2
1850 REPEAT
1860 IF inc<=0 THEN 1920
1870 PROCpause
1880 FOR I=inc+1 TO max
1890 PROCpair(I,I-inc)
1900 NEXT
1910 inc=inc DIV 2
1920 UNTIL inc<=0
1930 ENDPROC
1940
1950 DEFPROCpair(i,j)
1960 IF j<=0 THEN ENDPROC
1970 PROCmark(i,j,green,T)
1980 IF dest$(i)<dest$(j) THEN PROCswap(i,j):PROC
pair(j,j-inc)
1990 ENDPROC
2000
2010 DEFPROCquick(i,j)
2020 LOCAL pivotindex,partitionpoint,I
2030 pivotindex=FNfindpivot(i,j)
2040 PROCsection(1,max,white)
2050 PROCsection(i,j,blue)
2060 PRINTTAB(30,2);CHR$red;dest$(pivotindex);"
"
2070 PROCpause
2080 IF pivotindex=0 THEN ENDPROC
2090 partitionpoint=FNpartition(i,j,pivotindex)
2100 PROCquick(i,partitionpoint-1)
2110 PROCquick(partitionpoint,j)
2120 PRINTTAB(30,2);" "
2130 PROCsection(1,max,white)
2140 ENDPROC
2150
2160 DEFFNfindpivot(i,j)
2170 LOCAL I
2180 I=1
2190 IF I=j THEN =0
2200 IF dest$(I)>dest$(I+1) THEN =I
2210 IF I+1=j THEN =0
2220 IF dest$(I)<dest$(I+1) THEN =I+1
2230 I=I+1:GOTO 2190
2240
2250 DEFFNpartition(i,j,k)
2260 pivot$=dest$(K)
2270 L=i:R=j
2280 REPEAT
2290 PROCswap(L,R)
2300 PROCmark(O,L,yellow,F):PROCmark(O,R,green,F)
:PROCpause
2310 IF dest$(L)<pivot$ THEN PROCmark(O,L,nothing
,F):L=L+1:PROCmark(O,L,yellow,F):PROCpause:GOTO 23
10
2320 IF L=R THEN 2340
2330 IF dest$(R)>pivot$ THEN PROCmark(O,R,nothin
g,F):R=R-1:PROCmark(O,R,green,F):PROCpause:IF R>L
THEN 2330
2340 UNTIL L>=R
2350 =L
2360
2370 DEFPROCtree
2380 PROCcolour_tree
2390 FOR I=2 TO max
2400 PRINTTAB(18,I);" ";TAB(18,I+1);"J":PROCpause
2410 PROCbackup(I)
2420 NEXT
2430 PROCcolour_tree
2440 FOR I=max TO 2 STEP -1
2450 PROCpause
2460 test$=dest$(I)
2470 PROCmove(I)
2480 dest$(I)=" ***"
2490 PROCswap(1,I)
2500 PROCsection(I,max,white)
2510 PROCpause
2520 PROCputback(1)
2530 NEXT
2540 ENDPROC
2550
2560 DEFPROCbackup(J)
2570 REPEAT
2580 PROCmark(J,J DIV 2,green,T)
2590 IF dest$(J)>dest$(J DIV 2) THEN PROCswap(J,J
DIV 2)
2600 J=J DIV 2
2610 UNTIL J=1
2620 ENDPROC
2630
2640 DEFPROCputback(J)
2650 LOCAL swapindex
2660 swapindex=2*J
2670 IF swapindex>=I THEN PROCswap_test:ENDPROC
2680 IF dest$(swapindex)<dest$(swapindex+1) THEN
swapindex=swapindex+1
2690 IF swapindex>=I THEN PROCswap_test:ENDPROC
2700 IF test$>=dest$(swapindex) OR swapindex>=I T
HEN PROCswap_test ELSE PROCmark(J,swapindex,green
,T):PROCswap(J,swapindex):PROCputback(swapindex)
2710 ENDPROC
2720
2730 DEFPROCswap_test
2740 dest$(J)=test$
2750 PROCmark(O,J,cyan,F)
2760 PRINTTAB(30,I+1);CHR$cyan;
2770 PRINTTAB(20,J+1);CHR$cyan;dest$(J);" "
2780 PRINTTAB(31,I+1);" *** "
2790 PROCpause
2800 PRINTTAB(20,J+1);CHR$nothing;
2810 PRINTTAB(31,I+1);" "
2820 ENDPROC
2830
2840 DEFPROCmove(i)
2850 LOCAL II
2860 FOR II=20 TO 31
2870 PRINTTAB(20,i+1);CHR$nothing;" ***";TAB(II,i
+1);CHR$nothing;test$
2880 Z=INKEY(10)
2890 NEXT
2900 PRINTTAB(II,i+1);CHR$white;test$
2910 PROCpause
2920 ENDPROC
2930
2940 DEFPROCcolour_tree
2950 PROCsection(1,1,magenta)
2960 PROCsection(2,3,red)
2970 PROCsection(4,7,yellow)
2980 PROCsection(8,15,blue)

```

See 'See How They Sort', page 117

Program 2. Sort procedures unadorned

```

>LIST
10 DEFPROCswap(i,j)
20 sorted=FALSE
30 spare#=dest$(i)
40 dest$(i)=dest$(j)
50 dest$(j)=spare#
60 ENDPROC
70
80 DEFPROCbubble
90 FOR I=1 TO max-1
100 sorted=TRUE
110 FOR J=max TO I+1 STEP -1
120 IF dest$(J-1)>dest$(J) THEN PROCsw
ap(J,J-1)
130 NEXT
140 IF sorted THEN I=max-1
150 NEXT
160 ENDPROC
170
180 DEFPROCshuttle
190 I=0
200 top=0:bottom=max:inc=1
210 REPEAT
220 sorted=TRUE
230 REPEAT
240 I=I+inc
250 IF dest$(I)>dest$(I+1) THEN PROCsw
ap(I,I+1)
260 UNTIL I+inc=top OR I+inc=bottom
270 IF I+inc=top THEN top=top+1:inc=1
280 IF I+inc=bottom THEN bottom=bottom
-1:inc=-1
290 UNTIL bottom<=top+1 OR sorted
300 ENDPROC
310
320 DEFPROCinsertion
330 FOR I=2 TO max
340 FOR J=I TO 2 STEP -1
350 IF dest$(J-1)>dest$(J) THEN PROCsw
ap(J,J-1) ELSE J=2
360 NEXT
370 NEXT
380 ENDPROC
390
400 DEFPROCselection
410 FOR I=1 TO max-1
420 lowindex=I
430 FOR J=I+1 TO max
440 IF dest$(J)<dest$(lowindex) THEN l
owindex=J
450 NEXT
460 IF lowindex<>I THEN PROCswap(I,low
index)
470 NEXT
480 ENDPROC
490
500 DEFPROCshell
510 inc=max DIV 2
520 REPEAT
530 IF inc<=0 THEN 580
540 FOR I=inc+1 TO max
550 PROCpair(I,I-inc)
560 NEXT
570 inc=inc DIV 2
580 UNTIL inc<=0
590 ENDPROC
600
610 DEFPROCpair(i,j)
620 IF j<=0 THEN ENDPROC
630 IF dest$(i)<dest$(j) THEN PROCswap
(i,j):PROCpair(j,j-inc)
640 ENDPROC
650
660 DEFPROCquick(i,j)
670 LOCAL pivotindex,partitionpoint,I
680 pivotindex=FNfindpivot(i,j)
690 IF pivotindex=0 THEN ENDPROC
700 partitionpoint=FNpartition(i,j,piv
otindex)
710 PROCquick(i,partitionpoint-1)
720 PROCquick(partitionpoint,j)
730 ENDPROC
740
750 DEFFNfindpivot(i,j)
760 LOCAL I
770 I=i
780 IF I=j THEN =0
790 IF dest$(I)>dest$(I+1) THEN =I
800 IF I+1=j THEN =0
810 IF dest$(I)<dest$(I+1) THEN =I+1
820 I=I+1:GOTO 780
830
840 DEFFNpartition(i,j,K)
850 pivot#=dest$(K)
860 L=i:R=j
870 REPEAT
880 PROCswap(L,R)
890 IF dest$(L)<pivot# THEN L=L+1:GOTO
890
900 IF L=R THEN 920
910 IF dest$(R)>=pivot# THEN R=R-1:IF
R>L THEN 910
920 UNTIL L>=R
930 =L
940
950 DEFPROCtree
960 FOR I=2 TO max
970 PROCbackup(I)
980 NEXT
990 FOR I=max TO 2 STEP -1
1000 test#=dest$(I)
1010 dest$(I)="
1020 PROCswap(1,I)
1030 PROCputback(1)
1040 NEXT
1050 ENDPROC
1060
1070 DEFPROCbackup(J)
1080 REPEAT
1090 IF dest$(J)>dest$(J DIV 2) THEN PR
OCswap(J,J DIV 2)
1100 J=J DIV 2
1110 UNTIL J=1
1120 ENDPROC
1130
1140 DEFPROCputback(J)
1150 LOCAL swapindex
1160 swapindex=J#2
1170 IF swapindex>=I THEN dest$(J)=test
#:ENDPROC
1180 IF dest$(swapindex)<dest$(swapinde
x+1) THEN swapindex=swapindex+1
1190 IF swapindex>=I THEN dest$(J)=test
#:ENDPROC
1200 IF test#>=dest$(swapindex) THEN de
st$(J)=test# ELSE PROCswap(J,swapindex):
PROCputback(swapindex)
1210 ENDPROC

```

Paul Beverley's program for the signature analysis unit

```

10 CLS
20 PROCinitialise
30 REPEAT
40   PROCmenu
50   UNTIL X%=0
60 END
70
80 DEF PROCmenu
90 REM *****
100
110 VDU26,12
120 INPUT TAB(0,2)"Test number? "X%
130 VDU28,0,24,30,5
140 IF X%=0 ENDPROC
150 N%=32
160
170 REPEAT
180   IF N%=13 OR N%=-1 N%=INKEY(5)
190   IF N%=32 PROCprompt
200   IF N%>32 UNTIL TRUE:ENDPROC
210 *FX19
220 CALL test
230 PROCprint
240 UNTIL N%>32
250 ENDPROC
260
270 DEF PROCprompt
280 REM *****
290
300 PRINT
310 N%=GET
320 IF N%=13 ENDPROC
330 IF N%=47 ENDPROC
340
350 REPEAT
360   PRINT CHR$(N%);
370   N%=GET
380   UNTIL N%=13
390 N%=32
400 ENDPROC
410
420 DEF PROCprint
430 REM *****
440
450 @%=1
460 PRINT TAB(8)^(A% AND &F000)
   DIV &1000;
470 PRINT^(A% AND &F00) DIV &100;
480 PRINT^(A% AND &F0) DIV &10;
490 PRINT^A% AND &F
500 ENDPROC
510
520 DEF PROCerr_handle
530 REM *****
540
550 VDU26,12
560 REPORT
570 PRINT" at "ERL
580 ENDPROC
590
600 DEF PROCinitialise
610 REM *****
620
630 ON ERROR PROCerr_handle:END
640 ?&FE6B=8 : REM S.R. to input
650 ?&FE62=&81 : REM PB0 & PB7 as output
660
670 FOR opt% = 0 TO 2 STEP 2
680   P% = &C00
690   [OPT opt%
700
710   .test
720   \****
730
740   SEI
750   LDY #0
760   LDA #&80
770   STA &FE60
780   LDA #&81
790   STA &FE60
800
810   JSR testX%
820
830   .read_SR
840   \*****
850
860   LDX #&01 \ Disable clock input.
870   STX &FE60 \ i.e. enable CB1 clock.
880
890   LDX &FE6A \ Dummy read of S_R.
900
910   LDA #&04 \ To check S_R flag.
920
930   .ready%
940   BIT &FE6D \ Has new value
950   BEQ ready% \ shifted in yet?
960
970   LDX &FE6A \ Read shift register.
980   STX &405
990
1000  .again%
1010  BIT &FE6D \ Has new value
1020  BEQ again% \ shifted in yet?
1030
1040  LDX &FE6A \ Read shift register.
1050  STX &404
1060
1070  LDX #&81
1080  STX &FE60
1090
1100  CLI \ You can interrupt now!

```

Continued ▶

◀ Continued

```

1110   RTS
1120
1130   .testX%
1140   \*****
1150
1160   CPX #2
1170   BCS test2%
1180
1190   .test1%
1200   \*****
1210
1220   STA &8AAA,Y \ Low ROM
1230   DEY
1240   BNE test1%
1250   RTS
1260
1270   .test2%
1280   \*****
1290
1300   CPX #3
1310   BCS test3%
1320
1330   .next2%
1340   LDA &CFA5,Y \ High ROM
1350   DEY
1360   BNE next2%
1370   RTS
1380
1390   .test3%
1400   \*****
1410
1420   CPX #4
1430   BCS test4%
1440
1450   .next3%
1460   LDA &C00,Y \ Low RAM
1470   DEY
1480   BNE next3%
1490   RTS
1500
1510   .test4%
1520   \*****
1530
1540   CPX #5
1550   BCS test5%
1560
1570   .next4%
1580   STA &7800,Y \ High RAM
1590   DEY
1600   BNE next4%
1610   RTS
1620
1630   .test5%
1640   \*****
1650
1660   CPX #6
1670   BCS test6%
1680
1690   .next6%
1700   LDA &FE40 \ Internal VIA
1710   LDA &FE41
1720   DEY
1730   BNE next6%
1740   RTS
1750
1760   .test6%
1770   \*****
1780
1790   CPX #7
1800   BCS test7%
1810
1820   .next7%
1830   LDA &FE80 \ Disc Controller
1840   LDA &FE81
1850   LDA &FE82
1860   LDA &FE84
1870   DEY
1880   BNE next7%
1890   RTS
1900
1910   .test7%
1920   \*****
1930
1940   CPX #8
1950   BCS test8%
1960
1970   .next7%
1980   LDA &FE20 \ Video ULA
1990   LDA &FE21
2000   DEY
2010   BNE next7%
2020   RTS
2030
2040   .test8%
2050   \*****
2060
2070   LDA &FE08 \ ACIA
2080   LDA &FE09
2090   DEY
2100   BNE test8%
2110   RTS
2120
2130   ]
2140   NEXT
2150   ENDPROC

```

Alex Wilson's 'Wordprint' wordprocessing program for the Atom with Star Gemini X10 printer connected

```

10 G.z
19 REM SAVE
20sF.I=0 T09:I?#2984=32;N.;IN."FILENAME"$D;L=LEND
22 I=0;D0;I?#2984=I?D;I=I+1;U.(I=L ORI=9)
24 ?#8202=?#80;?#8203=?#81
26 *SAVE"1234567890"8200 8202 8200
27 S=#8202;T=!#80;F=FOUT"";WAIT;BPUTF,#AA;WAIT;PUTF,T;F.N=S TOT
28 BPUTF,?N;N.
30 R.
39 REM LOAD
401P."LOAD DATA TAPE PRESS CTRL WHEN NAME SHOWS"
41 *CAT
44 S=#8202;F=FIN"";D0;U.BGETF=#AA;F.N=S TO(GETF);?N=BGETF;N.
46 ?#80=?#8202;?#81=?#8203
50 R.
52b0=0;IN."O.K."$D;IF?D=78;0=1
53 R.
55 REM WRITE TEXT
56aS=#8204;P.$12"TEXT"
58dIN.$B;G0S.b;K=LENB;IF?B=90;IFB?1=90;G.62
59 IFQ=0;I=0;D0;S?I=B?I;I=I+1;U.I=K;S=S+K;?S=13
60 IFS>#9700;IN."TEXT SPACE FULL"$D;G.62
61 G.d
62 R.
71 P.$17;P.$3;G.y
72 999 aNYSTREET,*aNYTOWN,*aNYCOUNTY,*aNYCODE*01 999 9999*
73 REM REMOVE ALLSPACES AND REMS UP TO LINE 71
80cI=0;D0;B?I=S?I;I=I+1;U.I=29
82 B?29=13;P." "$B';L=LENB;S=S+L;J=J+1
86 IFS>=!#80;E=0
88 R.
89 REM INSERT CONTROLS
91 B?X=52;R.
92 B?X=45;X=X+1;B?X=1;R.
93 B?X=53;R.
94 B?X=87;X=X+1;B?X=1;Y=2;?#86=1;R.
123 B?X=83;X=X+1;B?X=0;R.
124 B?X=45;X=X+1;B?X=0;R.
125 B?X=83;X=X+1;B?X=1;R.
126 B?X=84;R.
127eS=#8204;U=S;REM EDIT
128nJ=0;T=S;P.$12" 1 2"
129 P." 01234567890123456789012345678"?';E=1
130 @=0;P.J;G0S.c;U=T
131 IFE=1;IFJ>9;G.133
132 IFE=1;G.130
133 IN."A,B,D,I,N,Z"$D;F=?D;IFF=90;R.
134 IFF<65 ORF>90;P.$11;G.133
135 IFF<>66;G.138
136 IFU>#8204;U=U-290;S=U;T=U;G.n;REM BACK
137 P."CAN'T GO BACK"?'#11#11;G.133
138 IFF<>78;G.m
140 IFE=0;P."END OF TEXT ""?'#11#11;G.133
141 U=T;G.n
142mIN."WHICH LINE"$D;C=VALD;IFC<0 ORC>9;P.$11;G.m
144oIN."WHICH COLUMN"$D;A=VALD;IFA<0 ORA>28;P.$11;G.o
146 S=T+29*C+A;R=!#80
148 IFF=68;G.160
149 P."TEXT";REM INSERT,AMEND
150 IN.$B;L=LENB;G0S.b;IFQ=1;G.150
151 IFF=65;G.154

```

Continued ►

◀ Continued

```

152 V=R+L; !#80=V; DO; ?V=?R; V=V-1; R=R-1; U.R=S-1
154 I=0; DO; S?I=B?I; I=I+1; U.I=L; S=T; G.n
160 IN."DELETE HOW MANY"#D; G=VALD; IFG<0; P.$11$11; G.160
162 DO; ?S=S?G; S=S+1; U.(S+G)=R; ?S=13; !#80=S
164 S=T; G.n
189 REM SINGLE/DOUBLE STRIKE, EMPHASISED
190u?#8D=0; ?#92=0; P."OUTPUT TO PRINTER"? "1 SINGLE"
192 IN."2 DBLE.STRIKE"? "3 EMPHASISED"#D; R=VALD; IFR<1 ORR>3; Q=1
194 IFR=2; ?#8D=1
195 IFR=3; ?#92=1
196 R.
199 REM PRINT STYLE
200p?#85=0; ?#88=0; ?#8B=1; Q=0; GOS.u; IFQ; G.p
210 IN."1 10CPI"? "2 12 CPI"? "3 17CPI"#D; P=VALD; IFF<1 ORP>3; G.210
212 ?#90=P; IFF=1; ?#87=80; G.r
214 IFF=2; ?#87=96; G.r
216 ?#87=136
230r IN."LEFT HAND MARGIN"#D; M=VALD; IFM<0 ORM>20; G.r
232 IFM=10; M=9
240 ?#8A=M; P."DEFAULT IS 60 LINES"
242 IN."MAX.NO.OF LINES PER PAGE"#D; L=VALD; IFL=0; L=60
244 ?#89=L
250 P."MAX.NO.OF LETTERS PER LINE IS"?#87-2*M
252 IN."NO.OF LETTERS PER LINE"#D; C=VALD; IFC=0; C=?#87-2*M
254 IN."DOUBLE SPACED Y/N"#D; IF?D=89; ?#8B=2
260 ?#8C=C; IN."DATE REQUIRED Y/N"#D; IF?D=89; ?#88=1
270 IN."DO YOU WANT ADDRESSED HEADING Y/N"#D; IF?D=78; R.
272 IF?D=13; G.270
280 ?#85=C-M; GOS.f; R.
299 REM PRINT TEXT
300qL=?#89; M=?#8A; K=?#8B; C=?#8C
302 IN."SET UP PAPER"? "PRESS RETURN TO START"#D; IF?D<>13; G.q
310 P.$2; GOS.x; U=0
314 IF?#85=0; G.321
316 Z=9; P.$9; U=0; S=#2B63; GOS.g; U=U+4*K
321 IF?#88=0; G.330
322 S=#97E0; GOS.v
330 Z=0; IF?#85=0; G.h
332 S=#28A0; GOS.g; P.???; U=U+3*K
350hS=#8204; T=?#80+?#81*256; C=C+1
360j IFU<L; G.k
364 P.$19$3; IN."END OF PAGE"? "ADJUST PAPER"#D; U=0
366 P.$2$17
370k IFS>=T; G.400
380 GOS.v; S=S+V+2
390 G.j
400 P.$19$3$12; IN."ANY MORE COPIES WANTED Y/N"#D
410 IF?D=78; R.
420 GOS.u; G.q
430 GOS.f
434 IN."INSERT ENVELOPE, PRESS RETURN"#D; ?#93=M; ?#92=1; K=1; M=20
436 P.$2; GOS.x; S=#28A0; C=20; GOS.g; M=?#93; P.$27$70$19$3; R.
449 REM OUTPUT STRING
450vV=0; X=0; Y=1; W=0; IF?#86=1; Y=2
452 DO; E=S?V; IFE<64; G.w

```



```

453 IFE>64; IFE<91; E=E:#20; G.w
454 IFE>96; IFE<123; E=E:#20; G.w
456 IFE>90; IFE<95; B?X=27; X=X+1; GOS.E; G.i
457 IFE>120; IFE<127; B?X=27; X=X+1; GOS.E; G.i
458 IFE=96; B?X=27; X=X+1; B?X=87; X=X+1; B?X=0; Y=1; ?#86=0; G.i
460w B?X=E; W=W+Y
461i V=V+1; X=X+1
462 U.(W>=C OR E=42 OR E=13)
463 IFE=42; X=X-1; V=V-1
464 IFW>=C; DO; V=V-1; U.V?S=32; DO; X=X-1; U.B?X=32
465 B?X=13; IFZ>0; P.$9
466 F=B; DO; A=?F; LINK#FF10; F=F+1; U.A=13
467 U=U+K; IFK>1; P.'
468 V=V-1; R.
469 REM SET UP PRINTER
470xP.$17$27$64; IF?#85>0; T=?#85; P.$27$68$(T)$0
472 IF?#8D=1; P.$27$71; REM DBLE. STRIKE
474 P.$27$77$(M); IF?#92=1; P.$27$69; ?#90=1; REM MARGIN, EMPHASISED
476 F.I=#8E TO#91; A=?I; LINK#FF10; N.
478 P.'$27$55$0$27$61; R.; REM USA, MSB=0
479 REM ENVELOPE
480f IN."NEW ADDRESS Y/N"$D; IF?D=78; R.
482 S=#28A0; P."TYPE NAME AND ADDRESS"; GOS.d; S=S+1
484 ?S=13; R.
490g GOS.v; S=S+V; IF?S=13; R.
492 S=S+2; G.g
499 REM START
500zD=#2800; S=#8204; !#80=S; ?#8200=13; ?#8201=-1; B=#2810
505 ?16=#51; ?17=#2B; P=100; !#8E=#1421B
510 F=#97E0; IN."DATE"$F
520yP.$12"1 WRITE TEXT""2 EDIT TEXT""3 PRINT TEXT"
522 P."4 SAVE TEXT""5 LOAD TEXT""6 REVIEW TEXT"
523 P."7 ENVELOPE""8 END"
524 IN.$D; C=VALD; IFC<1 ORC>8; G.y
526 G.(530+20*C)
550 IN."1 NEW TEXT""2 ADDITIONAL TEXT"$D; C=VALD
552 IFC<1 ORC>2; G.550
554 G.(556+C)
557 GOS.a; !#80=S; G.y
558 S=!#80; GOS.d; !#80=S; G.y
570 GOS.e; G.y
590 IFP=100; GOS.p
592 IN."CHANGE PRINT STYLE Y/N"$D; IF?D=89; GOS.p
594 GOS.q; G.y;
610 GOS.s; G.y
630 GOS.l; G.y
650 S=#8204; E=1
651 J=0; P.$12
652 GOS.c; IFE=1; IFJ>9; GOS.680; IFE=1; G.651
656 IFE=1; G.652
660 GOS.680
664 G.y
670 GOS.430; G.y
680 IN.$D; IF?D=90; E=0; R.
682 IF?D=69; U=S; GOS.n
684 R.
690 E.

```

See 'Toolkits on Trial', page 157

Listing 2. Program compactor utility in machine code

```

10 REM *** SPACE REMOVER ***
20 before=&70
30 after=&72
40 count=&74
50 FOR pass=0 TO 3 STEP3
60 P%=&900
70 LOPT pass
80 LDA #0
90 STA after
100 STA before
110 STA count
120 STA count+1
130 LDA &18
140 STA after+1
150 STA before+1
160 .outer
170 LDY #1
180 JSR transfer
190 CMP #&FF
200 BEQ all_done
210 JSR transfer
220 JSR transfer
230 .inner
240 LDA (before),Y
250 CMP #ASC" "
260 BEQ space
270 JSR transfer
280 BEQ end_of_line
290 CMP #&22
300 BEQ inside_quote
310 BNE inner
320 .space
330 INC before
340 BNE update
350 INC before+1
360 .update
370 INC count
380 BNE inner
390 INC count+1
400 BNE inner
410 .end_of_line
420 DEY
430 TYA
440 PHA
450 CPY #3
460 BEQ clear
470 LDY #3
480 STA (after),Y
490 CLC
500 ADC after
510 STA after
520 BCC clear
530 INC after+1
540 .clear
550 PLA
560 CLC
570 ADC before
580 STA before
590 BCC outer
600 INC before+1
610 BNE outer
620 .inside_quote
630 JSR transfer
640 BEQ end_of_line
650 CMP #&22

```

Listing 1. Utility in Basic to list the values assigned to all the resident integer variables in decimal and hexadecimal

```

10 REM ** INTEGER DUMP **
20 REM ** (c) Acorn User **
30 FOR loop=&404 TO &468
40 !loop=RND
50 NEXT
60 PROCvar_dump
70 END
80 :
500 DEF PROCvar_dump
510 CLS
520 PRINTCHR$(131);SPC(5);"Integer Var
iable Dump"
530 PRINT"Var          Hex          Deci
mal"
540 VDU 28,0,24,39,3
550 ascii=ASC"A"
560 FOR loop=&404 TO &468 STEP4
570 PRINTCHR$(ascii);"% ";
580 PRINT"!loop;" ";
590 PRINT!loop
600 ascii=ascii+1
610 NEXT
620 VDU 26
630 ENDPROC

```

```

660 BNE inside_quote
670 BEQ inner
680 .transfer
690 LDA (before),Y
700 STA (after),Y
710 INY
720 CMP #13
730 RTS
740 .all_done
750 LDA after
760 CLC
770 ADC #2
780 STA &12
790 LDA after+1
800 ADC #0
810 STA &13
820 LDA #ASC"&"
830 JSR &FFEE
840 LDA count+1
850 BEQ zero
860 JSR hexout
870 .zero
880 LDA count
890 JSR hexout
900 BRK
910 EQUW &0B0B
920 EQUW &09090909
930 EQUW " spaces removed"
940 EQUW 13
950 BRK
960 RTS
970 .hexout
980 PHA
990 LSR A: LSR A
1000 LSR A: LSR A
1010 JSR digit
1020 PLA
1030 .digit
1040 AND #15
1050 CMP#10
1060 BCC over
1070 ADC #6
1080 .over
1090 ADC #48
1100 JMP &FFEE
1110 J:NEXT

```



Update on the NFS chip, better security for data files, testing the RS423 port, finding the file length – presented by Bruce Smith

The NFS chip:

more differences

SINCE writing the DNFS review (Beeb Forum, August), Robin Newman brings to our attention two further unpublished differences from the existing DFS and NFS chips. He writes...

The first concerns the use of the *DESTROY and *BACKUP commands. When using DFS 0.9 these have to be preceded immediately with a *ENABLE command, due to their potentially drastic effects. With DNFS this *ENABLE can be omitted, in which case the prompt 'GO (Y/N) ?' follows the issuing of the command. A 'Y' sends it on its merry way, and any other key aborts the command. This is particularly useful with the *BACKUP command because the information 'copying from :0 to :2' (or whatever the relevant drives are) is printed before the prompt 'GO (Y/N) ?' is issued. This gives a chance for the command to be aborted if the source and destination drives have been typed in the wrong order.

The second difference concerns the NFS half of the chip. Recently I have written a Network version of the 'BUILD fname' command contained in the DFS chip. This is useful for forming !BOOT files etc for use on the network. To extract the filename 'fname' from the end of the command line, I have used OSARGS with A=1 (see my example in Beeb Forum, May 1984, listing 1). The 'old' NFS 3.34 incorrectly returns the address of the START of the command line, ie the byte containing the B of BUILD in this case. NFS360 (contained in DNFS) correctly returns the address of the f of fname.

The problem is that one has to accommodate both protocols. Listing 1 shows how I have done this. It is not very elegant, requiring a direct peek at the NFS ROM to determine which version it is. Does anybody know a call that returns the NFS version running in the local machine?

I hope this information will be of use to DNFS users, and that the second one

```

10 REM excerpt from Net #BUILD command utility by R.Newman
20 osargs=&FFDA:pb%=&70
.
.
80 .start LDA#1:LDY#0:LDX#pb%:JSR osargs \ get command line pointer
90 LDA &8004:CMP#&AF:BNE not334 \ check if NFS3.34
100 LDY#0 \ NFS3.34 so search for first space after BUILD
110 .nextchar LDA(pb%),Y:CMP#13:BEQ error \ error if end of line found
120 CMP#32:BEQ nextchar2 \ branch if space found
130 INC pb%:BNE nextchar \ increment pointer and force branch back
140 .nextchar2 LDA(pb%),Y:CMP#32:BNE not334 \ now search for first
non-space character; branch if found
150 INC pb%:BNE nextchar2 \ increment pointer and force branch back
160 .not334 \ rest of program follows. pb% now points to f of fname
.
.

```

Listing 1. Code showing how both protocols can be accommodated when it is entered at start by typing *BUILD fname

will prevent others wasting time finding a bug not of their own making. It is good that Acorn has made the new NFS and DFS versions compatible as far as this OSARGS call is concerned. It would have been even better had they let everyone know about it!

Confuse the

illicit copier

ELLIS THOMAS's ideas on cursor editing from within a running program (Beeb Forum, August) stimulated some thought. Adrian Robson of Hexham, Northumberland, writes...

The method described could be very useful for some applications but, in the case of file copying, it has a major failing in that it does not obtain the true file name. Let me explain...

A method of providing your programs and data files with greater security is to use non-alphanumeric ASCII codes in the file name. For example 240, which is 'p' in mode 7. To

do this you must use an OSFILE call to create the file. Anyone subsequently using LOAD or *LOAD on the file will find that the file name prints on the screen with '?' for the non-alphanumeric ASCII codes. They will be unable to save the file using SAVE or *SAVE, with the correct file name. Even if they knew the file name, they would be unable to enter it directly from the keyboard.

In operation two methods are available for providing the required security: the program could be executed by using CHAIN"", thus avoiding the non-ASCII characters in the file name. The program checks that bytes &3B2-&3BD contain the expected file name and refuses to run correctly if it does not. OSBYTE &A0 can, of course, be used to access the name.

The second method, applicable to data and machine code files, is to load the file via an OSFILE call using the correct name in the control block. However, the former method is recommended as it causes greater confusion to the illicit copier.

This technique can also, of course,

Beeb Forum is a platform for ideas, tips and applications relating to the BBC micro and the Electron, intended for experienced programmers to share their thoughts. For every reader's tip published we pay £5 – or more for something special. Contributions should be typed or printed, with substantial listings on cassette. WRITE TO Beeb Forum, Acorn User, Redwood Publishing, London WC2E 9JH.

be used for data or machine code files.

Now we obviously require a method of taking legitimate back-ups of our protected files and it is equally obvious that the cursor editing method will not work in this case. The only method available involves access to page three and using an OSFILE call to save the file. This has the additional advantage of simplicity compared with the cursor editing method.

The comment that cursor editing will minimise problems with new OS releases is valid. However, it is more likely that the screen format of the *OPT 1,2 load message will change on future releases rather than the internal header block format or location. Anyway, the risk and consequences of either is so minimal that they can be only a minor consideration when deciding on the best method for arranging for automatic file backup for your own programs and data.

In conclusion, the cursor editing method is a sophisticated means of arranging file copying, but sophistication is not an end in itself, no matter how well it is justified. To coin a phrase, the cursor editing method when applied to file copying is equivalent to using a hammer to crack a nut and then missing the nut!

£10 423 ... testing the serial port

ONE aspect of the Beeb not often touched on is the RS423 serial port. Perhaps this is because the pin-out diagram in the *User Guide* is incorrect, as John Gallagher of Carlow, Ireland, points out...

The diagram of the five-way DIN plug on page 406 of the *User Guide* is incorrect in that the indentation representing the plug case earth should be at the top of the diagram. The connections are otherwise correct...

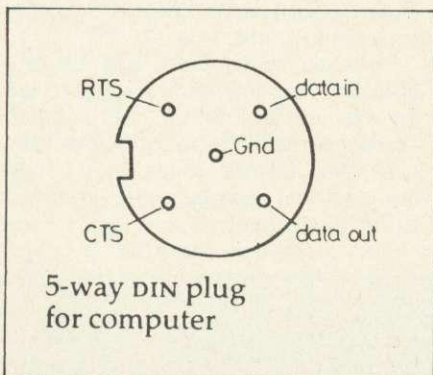

Diagram of the five-way DIN plug as printed in the *User Guide*. The indentation should be at the top

Alan Crabb's disc catalogue reader program is printed on yellow page 103

John also offers testing techniques...

A simple test of the operation of the RS423 output is the following. Connect pins A and B together and pins D and E together (Data out to Data in and CTS to RTS). Type in the following series of commands.

- *FX7,1 <CR>
- *FX8,1 <CR>
- *FX3,5 <CR>
- *FX2,1 <CR>

Now press any letter on the keyboard and if the serial port is operating properly the screen will print 'Syntax Error' continuously at a slow rate. The screen will also display multiple prompts. If the DIN plug is removed the screen display will halt. The test is crude but effective...

Finally, John provides serial connections for an Epson printer...

- a) Connect data out line to pin 3 of the printer.
- b) Connect data in line to pin 2 of the printer.
- c) Connect ground to pin 7 of the printer.
- d) Connect RTS to CTS.

The printer will now print in the serial mode in response to the printer-type command *FX5,2 and the switch-on command Control B or VDU2. Note that the baud transmission and reception rates may require setting using *FX8,n and *FX7,n if the default values do not match.

£10 Get the measure of your files

ALAN CRABB of Shaftesbury took up the challenge to write a program that will read a disc's catalogue and return the length of each file on it (Beeb Forum, August). Alan wins the promised £10 note. Let him explain...

The program (listing 2) as it stands will print all the files and their load/exec/length values on the disc in drive 0. The program is completely Tube compatible and uses only 'legal' methods (routines can be written legally, not accessing the DFS catalogue directly).

The listing is fairly well documented but a few extra notes might help.

The OSWORD call with A=&7D returns the disc's 'cycle number' (the number of times the disc contents have been altered). X and Y point to a single

byte which contains the drive number and returns the cycle number.

The checks in line 370 for illegal directories test for ' ' and ':'. The Acorn DFS seems to interpret the ' ' in a funny way and the colon is used for drive selection.

The OSGBP (get block, put block) may be new to most readers. It is documented on page 339-42 of the *Advanced User Guide* (I do not have an Acorn DFS manual - anyone got one for sale?). The call with A=8 is used to 'read file names from the current directory' - hence the loop through all normal directories at line 340. The parameter block pointed to by XY is set up as follows:

- 0 Cycle number
- 1-4 Pointer to block for return of names
- 5-8 No. of files to be read decremented by DFS
- 9-C Initially 0, incremented in eights by DFS

The data is returned in the format:
length of filename1
filename 1
length of filename2
filename2 ...

The length is always 7 and filenames end in spaces if they are shorter.

Finally, lines 800-860 print all the information using functions returning the load, exec and length of each file. The functions may be extracted but be sure to define some workspace for them.

£5 Neat toggling

READERS may be interested to see the assembler routine in the Beeb Forum suggestion for August, 'Printer on, printer off', page 65, reduced from 67 to 14 bytes, writes Robin Tracy of Sutton, Surrey.

```

10 REM Printer toggler - Utility
20 P% = 5A00
30 T OPT 0
40 LDA #126 : JSR 2FFF4
50 LDA &7D : EOR #1 : STA &7D
60 JMP 2FFEE : I
70 %220=&0 : REM Interrupt Address
80 %221=&A
90 %270=&C : REM Printer Off
100 *FX14 6 : REM Enable ESC event
    
```

In general, Exclusive OR (EOR) does not seem to be as widely applied as it might be. EOR can be used to toggle between any two integer values. There is usually a saving in space too.

Suppose you wish to toggle between 'n' (ASCII 110) and 'y' (ASCII 121) then Exclusive OR does it neatly.

```

105 X = 110
110 REPEAT
120 X = X EOR 23 : REM Will toggle
    X between 121 and 110
130 VDU X
140 UNTIL FALSE
    
```

To discover '23' enter the line P. 121 EOR 110.



HIGH RESOLUTION THAT COMES HIGHLY RECOMMENDED.

"There is no doubt that the JVC range of ECM colour monitors is excellent value for money . . . there is no loss in quality of picture after long periods . . . and remember, as more and more resolution is available with new micros, the need for a better display will be that much greater."

High recommendation indeed from Personal Computer News. Meanwhile Acorn User said:

"It seems that all 'normal' and 'medium' resolution monitors, including the Sanyo, are simply inadequate to deal with the Beeb's graphics and text output . . . The JVC was excellent, giving clear, legible results . . . Was the JVC better than the Microvitec? * Would I buy one? Yes to both questions."

Our RGB high resolution colour monitor (580 x 470 pixels) sells for £229.95 (excluding VAT) – that's a saving of over £100 compared with other leading monitors of similar specifications.

The unit has a 14" screen and is suitable for the BBC Micro, Electron, Sinclair QL, Lynx, Oric, Apple, IBM and most other leading micros.

MODEL REFERENCE	1302-2 High Resolution
RESOLUTION	580 x 470 Pixels
C.R.T.	14"
SUPPLY	220/240v. 50/60Hz.
E.H.T.	Minimum 19.5kv Maximum 22.5kv
VIDEO BAND WIDTH	10MHz.
DISPLAY	80 characters by 25 lines
SLOT PITCH	0.41mm
INPUT: VIDEO	R.G.B. Analogue/TTL Input
SYNC	Separate Sync on R.G.B. Positive or Negative
EXTERNAL CONTROLS	On/off switch and brightness control

And naturally there's a year's full guarantee. If you order your monitor by post, you'll receive it within ten days by courier service.

Simply post the coupon below to: Opus Supplies Ltd., 158 Camberwell Road, London SE5 0EE. Or telephone 01-701 8668 quoting your credit card number. Or, of course, you can buy at our showroom between 9.00–5.30pm, Monday–Friday, 9.00–1.00pm, Saturday.

*Microvitec Cub 14" monitor.

To: Opus Supplies Ltd., 158 Camberwell Road, London SE5 0EE.
Please send me:

- _____ High Resolution Colour Monitor(s) at £229.95 each (ex. VAT).
 _____ Medium Resolution Colour Monitor(s) at £179.95 each (ex. VAT).
 _____ Connection lead(s) at £6.00 each.

I understand carriage per monitor will cost an extra £7.00. (N.B. A High Resolution Monitor including VAT, lead, and carriage costs £279.39. A Medium Resolution Monitor including VAT, lead and carriage costs £221.89).

I enclose a cheque for £_____ Or please debit my credit card account with the amount of £_____. My Access/Barclaycard (please tick) no. is _____

Please state the make of your computer _____

Name _____

Address _____

Telephone _____

AC28
Opus.
Opus Supplies Ltd.

We've MOVED

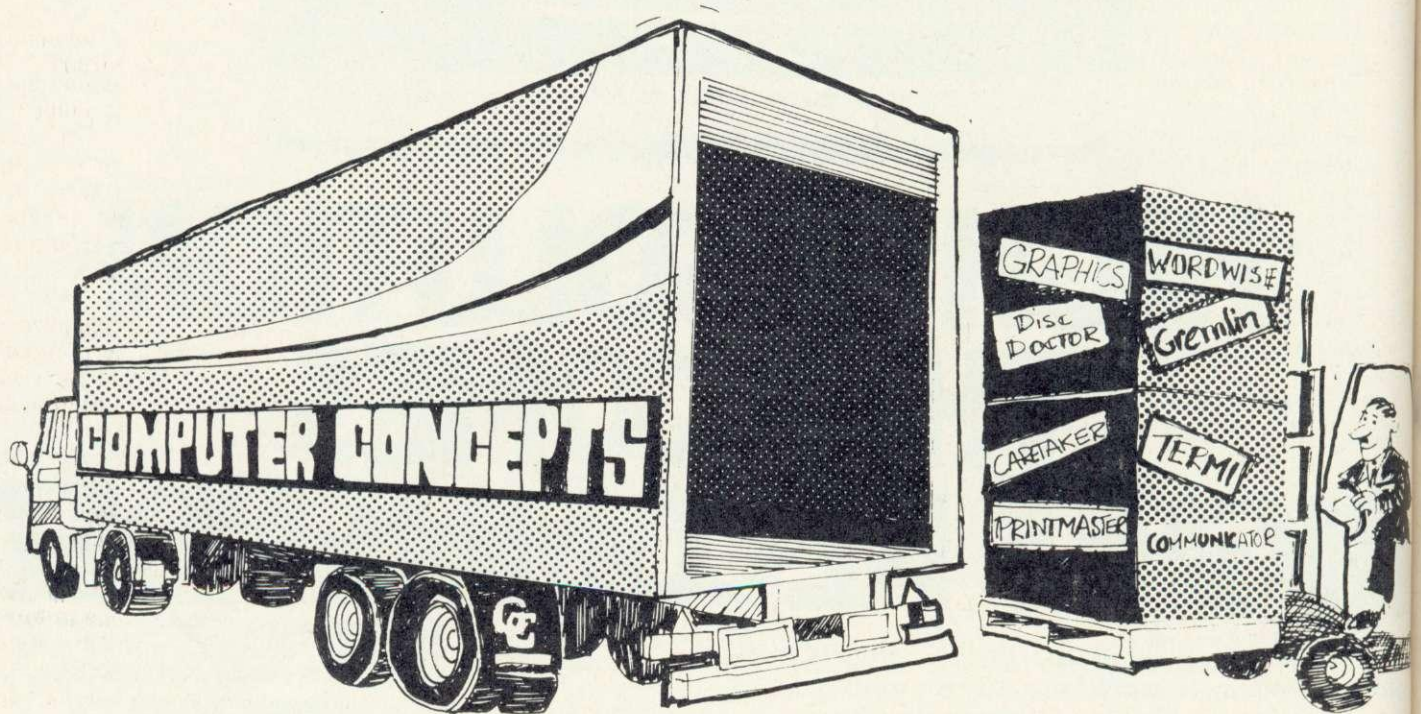

To Gaddesden Place, Hemel Hempstead, Herts HP2 6EX
Telephone: (0442) 63933
On the 1st August 1984

*Computer Concepts are still expanding and require more machine code
programmers with experience of Z80/6502 processors.*

For further details of vacancies write to:

*The Manager
Computer Concepts
Gaddesden Place
Hemel Hempstead
HERTS HP2 6EX*

|| SEE HOW THEY SORT

A colourful demo by George Hill shows how data is put in order

ONE OF the most frequently performed tasks in computing is sorting, but there are many different methods, as the accompanying programs illustrate. This article will assess their advantages and disadvantages, and compare their performance in various situations.

What items are to be sorted? The example programs use lists of boys and girls names, stored in an array. The sorting algorithms, however, can be applied to virtually any data which can be put in order – integers, floating-point numbers, strings, records with a key, for example.

Two words there need explaining. First, what is an algorithm? It is difficult to define precisely, but if you describe your method for doing something without recourse to any specific computer language, then you have probably stated the algorithm.

Second, what is a record? It is a collection of pieces of information, all of which 'belong' to a single item – for example, a person's name, address, telephone number, age, sex, etc. Basic does not recognise records, but they are a fundamental concept in languages that deal conveniently with data processing. Most important sorting methods must be able to deal with records, and some must be able to sort records from disc or tape files.

There are two programs. Program 1 allows the various sorts to be operated by selection from a menu. Sixteen assorted names will be sorted slowly, with colour coding to help you follow the sorting process as it occurs. Program 2 consists of the sorting procedures only. They are shorn of all the frills of program 1 that allow the sorts to be watched in action. It serves two purposes: first, to allow you to see how the sorting algorithms are translated into Basic; second, to allow you to copy and adapt them for your own use, should you need to sort some data in a program of your own.

Bubble sort

The first and most commonly understood and used sort is the 'bubble' sort. There are many variations of it, but the simplest and most obviously 'bubbling' algorithm is as follows:

The starting list has n items.

Compare the bottom two items (n and $n-1$).

If the lower one is smaller, swap them, otherwise do nothing.

Now compare the next two items ($n-1$ and $n-2$).

Swap, or don't swap as before, so that the smaller item ends up higher. Repeat the process until the smallest item in the list reaches the top.

Now start at the bottom again, and repeat the swapping procedure until the next smallest item is in position 2. Go on until the list is in order.

The procedures required for this are PROCbubble and PROCswap(i,j). PROCswap simply swaps the array items $dest$(i)$ and $dest$(j)$, and sets the flag 'sorted' to FALSE. This latter is a simple way of avoiding retesting already sorted items. If no swaps take place in any pass up the list, then the items must already be in order, so we should exit from the procedure.

Program 1 uses a number of conventions. Items being compared are indicated in green. When they are swapped they are shown in cyan (pale blue). When the program is run and 'bubble' is selected you will see the source list of names on the left and the destination list on the right. The items will be bubbled up from the bottom and will reach their appointed places as described above.

There are pauses generated by INKEY(waittime). These stop the program running so fast that you cannot follow it. If you still find it too fast, 'wait-time' is set in PROCsetup. Increase it to 200 for a two-second pause, 300 for three seconds, and so on. If you want to 'single-step' the program, set it to

100,000 (or higher), then you will get the next step on hitting any key.

This seems an appropriate moment for a quick skim through program 1.

The main program is very simple. A number of variables and arrays are set up (PROCsetup), and a sorting method chosen from the menu. The sort then takes place, and you are returned to the menu after pressing any key. The last choice terminates the program. Any sort can be aborted by pressing the ESCAPE key, which returns you to the menu.

The sort names ('BUBBLE', etc) and the names to be sorted are in data statements and can be added to simply by adding items to the data statements. The number of sorts is limited to 20, and the last one must be 'END'. The number of items in the arrays is limited to 128 – though this could easily be increased – and the last one must be '****'. If you increase the number of names beyond 18 it will not be possible to use the 'before your very eyes' element of the program. An adaptation of the program, using the sorting procedures of program 2 but no display, was used with various numbers of data items to produce the timings in table 2, of which more anon.

The display is in mode 7 and the teletext colour characters are defined as variables (eg, red = 129) in PROCsetup. This makes the subsequent colouring easier to follow. The total number of items in the array is 'max', while the number of sorts is 'num_of.sorts'. The unsorted array is source\$() while $dest$()$ is the array that is sorted by the various procedures.

PROCmenu is straightforward.

FNchoose(M\$) is a useful general-purpose function that allows you to pass a string of the form '1 to 20' or '1,2,3,4 or 5' to it, and to select only valid numbers in the stated range. Its limitations are that the left number must be between 0 and 9, and the right number must be between 1 and 999.

PROCdouble produces a heading and sets the text window.

PROCwait clears any residual colours on the destination list, and waits while you check that the sort has worked.

PROClst simply lists the destination array.

PROCsection($i,j,colour$) colours a section of the array in the chosen colour.

George Hill's colour-coded sort demo and procedures are listed on pages 104-106

CARE ELECTRONICS

UNIT 14, PEERGLow INDUSTRIAL ESTATE, OLD'S APPROACH, TOLPITS LANE, RICKMANSWORTH, HERTS.
 TELEPHONE: 0923 777155 01 950 0195

CARE ELECTRONICS presents: CPX2 "X" SWITCHER

Changing leads becomes a thing of the past!!!

- ★ 26pin (As BBC) 2 Micros driving 2 Printers at the same time.
- ★ Can be used as a 'T' Switcher.
- ★ All outputs BUFFERED enabling longer leads between units.
- ★ No strain on your BBC power supply, as the 'CPX2' comes complete with its own internal power supply.
- ★ Easy to install and operate.
- ★ Colour Finished to match BBC.
- ★ Supplied with moulded mains plug.
- ★ 12 Months Guarantee.

"ONLY" £97.75 Inc VAT.

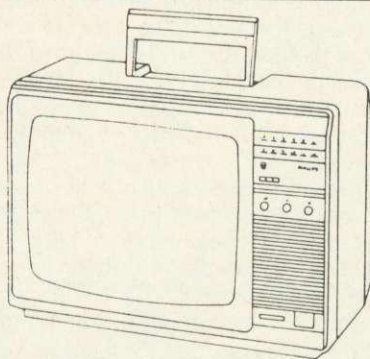
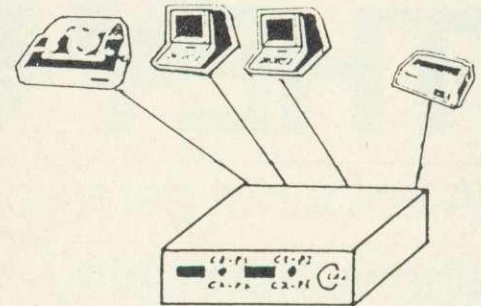

DON'T BUY A COLOUR MONITOR!!

HAVE YOUR PHILIPS 14" COLOUR TV CONVERTED TO A TV/MONITOR

"ONLY" £49.95 each inc VAT.

- ★ Image clarity comparable to leading monitors.
- ★ Includes RGB lead for connecting with BBC.
- ★ Conversions carried out at our workshops within 2/3 days.
- ★ 12 Months Guarantee.

"VIGLEN" ROM CARTRIDGE SYSTEM BBC B:

Complete Set	@ 18.95 inc VAT
Spare Cartridge	@ 6.75 inc VAT
5 Cartridges	@ 26.75 inc VAT
10 Cartridges	@ 47.25 inc VAT

"VIGLEN" TEAC 55 SLIMLINE DRIVES:

SINGLE DRIVES CASED:		Inc VAT
40/80 Track 200K Switchable		@ 165.00
40/80 Track 400K Switchable		@ 199.95
DUAL DRIVES CASED:		
40/80 Track 400K Switchable		@ 330.00
40/80 Track 800K Switchable		@ 399.90
INTEGRAL POWER SUPPLY:		
Fitted to any of the above drives		@ 28.75 25.00
FLOPPY DISCS:		
(Boxes of Ten)		
Fuji D/Sided D/Density 5.25"		@ 27.50 23.95
"VIGLEN" PRINTER STAND		@ 12.95 11.26

Full Twelve Months Guarantee

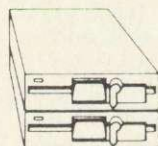

CARE
 ELECTRONICS
 TEL: 0923 777155
 01 950 0195

RS232 "T" SWITCHER : @ 55.00 inc VAT
 25pin "D" type Connectors

RS232 "X" SWITCHER : @ 65.00 inc VAT
 25pin "D" type Connectors

LEADS "READY-MADE":

6 pin DIN to 6 pin DIN plug (RGB) 1.5mt	Inc VAT
6 pin DIN to 6 pin DIN plug (RGB) 2mt	@ 2.95 ea
6 pin DIN to 6 pin DIN plug (RGB) coiled cable	@ 3.40 ea
6 pin DIN plug to 6 pin DIN skt (RGB) extension	@ 6.85 ea
BBC Power 6 way to Disc Drive 4 way 1.5mt	@ 2.95 ea
BBC Power 6 way to Disc Drive 4 way 2mt	@ 3.40 ea
BBC Power 6 way to 2 Disc Drive 4 way 1.5mt	@ 4.00 ea
Monitor lead BNC to PHONO 1.2mt	@ 4.50 ea
Monitor lead T.V. to PHONO 1.2mt	@ 4.40 ea
	@ 2.95 ea

RIBBON LEADS:

Disc Drive single	1.2mt	Inc VAT
Disc Drive dual	1.2mt	@ 6.85 ea
Printer	1.2mt	@ 10.30 ea
Printer	1mt	@ 7.99 ea
Parallel 26-26 pin	1.5mt	@ 11.25 ea
Parallel 26-26 pin	1mt	@ 7.65 ea
Parallel 26-26 pin	1.5mt	@ 8.65 ea
Serial 25 pin D type plug each end	2mt	@ 9.50 ea
Serial 25 pin D type plug each end	2 mt	@ 12.95 ea
	5 mt	@ 15.25 ea

CONNECTORS:

BBC Power 6 way housing	Plugs	Sockets
BBC Crimp Terminals	@ 0.35	0.40 ea
Disc Drive 4 way housing	@ 0.08	0.09 ea
Disc Drive Crimp Terminals	@ 0.29	0.24 ea
Various Din Connectors	@ 0.10	0.09 ea
	@ 0.40	0.48 ea

DISC INTERFACE PARTS:

E'Prom HITACHI HN482764G	Inc VAT
Low power Schottky 74LS10	@ 9.20 ea
Low power Schottky 74LS38	@ 0.48 ea
Low power Schottky 74LS123	@ 0.48 ea
Low power Schottky 74LS123	@ 1.21 ea
C'Mos 4013BCP	@ 1.43 ea
C'Mos 4020BCP	@ 0.70 ea
	@ 1.00 ea

HOW TO ORDER:

By Post. Enclose your Cheque/P.O. made payable to: **CARE Electronics.**
 Or use your ACCESS. Allow 7 days for delivery. Please add carriage.

- A) Disc Drives and CPX2 Switcher @ 8.00
- B) All other items @ 3.00



Apologies to all our customers who have experienced problems in contacting us via the telephone.
 This problem has now been rectified by British Telecom.

PROCmark(i,j,colour,pause) marks two items in the chosen colour, and if pause is TRUE (T is TRUE, F is FALSE), a pause is generated by PROCpause for 'waittime' hundredths of a second.

PROCswap(i,j) swaps two items of the destination array, and adjusts the display.

Shuttle sort

The second sort, called 'shuttle', is a variation of the bubble sort. It pushes the biggest item down to the bottom, bubbles the smallest up to the top, then pushes down the next biggest and bubbles up the next smallest. It is attractive in concept but takes the same number of passes as the bubble sort and, due to the cumbersome coding necessary, is much slower.

Insertion sort

The third sort is an 'insertion' sort, whose algorithm is as follows:

Start with the top two items and swap them if necessary to get them in order.

Now take the third item and *insert* it (by bubbling it up) into its correct place among the items already sorted.

Now take the next item, and insert it in its correct place.

Repeat till you get to the bottom item in the list.

Selection sort

The fourth sort is a selection sort. Many sorting algorithms can be adapted to be a selection sort. The principle of selection is as follows:

Do all the comparisons necessary to decide where an item goes *before* actually doing any swapping. Swap only when you know the item's destination.

This has enormous advantages in large-scale sorting operations, where the items to be sorted are complicated records and moving them is time-consuming.

Taking this principle to its extreme, we can often avoid moving the items. We could have a set of 'pointers' to the records and carry out comparisons on the 'key' field - eg the surnames. Instead of moving the records, we move the pointers. We finish with a sorted set of pointers, which in many cases is just as good as a sorted set of records. We can recall them in alphabetical order, for example, and if it is necessary to sort the records themselves, we know where they have to go before we start moving them about - an obvious advantage which lets us minimise the number of moves necessary.

The selection sort here uses the same basic method as the bubble sort. It works as follows:

Start at the top, and 'remember' item one.

Compare it in turn with each of the items below it.

If an item is smaller, then 'remember' it instead.

Go on comparing and 'remembering' until the bottom of the list is reached. The 'remembered' item is now the smallest.

Swap it with item one (unless it was already there).

Repeat this with item two, three, etc until the items are sorted.

The program marks the position for replacement in red, and the remembered item in yellow. The countdown is followed by a green marker.

The disadvantage of these methods is that items tend to move up the list rather slowly. The bubble sort operates much faster on a partially sorted list than on a random one, and has its 'worst case' when the items are in reverse order. (Every time a comparison is made a swap has to be carried out, and the 'sorted' getout flag never

gets set.) If only one item is out of order, then only one pass will be necessary to place it, and the 'sorted' flag is set on the next pass. The Shell sort is a brilliant method of making the items move more rapidly, and cutting down drastically on the time needed.

Shell sort

In the shell sort items are first compared which are separated by half the list.

For an array with 16 members we compare (and swap as necessary) items 1 and 9, 2 and 10 etc.

Return to the top of the list, and halve the comparison interval, ie, compare items 1 and 5, 2 and 6 etc. If an item is swapped, it must be swapped up as far as it will go at this interval. (Thus if we have to swap items 13 and 9, we must compare the new 9 with 5, and then (if swapped) 5 with 1, otherwise an item might get 'stuck' in the bottom half.)

Now compare items 1 and 3, 2 and 4, etc. Items must be 'back compared' if swapped as before.

A single pass down the list will eventually produce the sorted order.

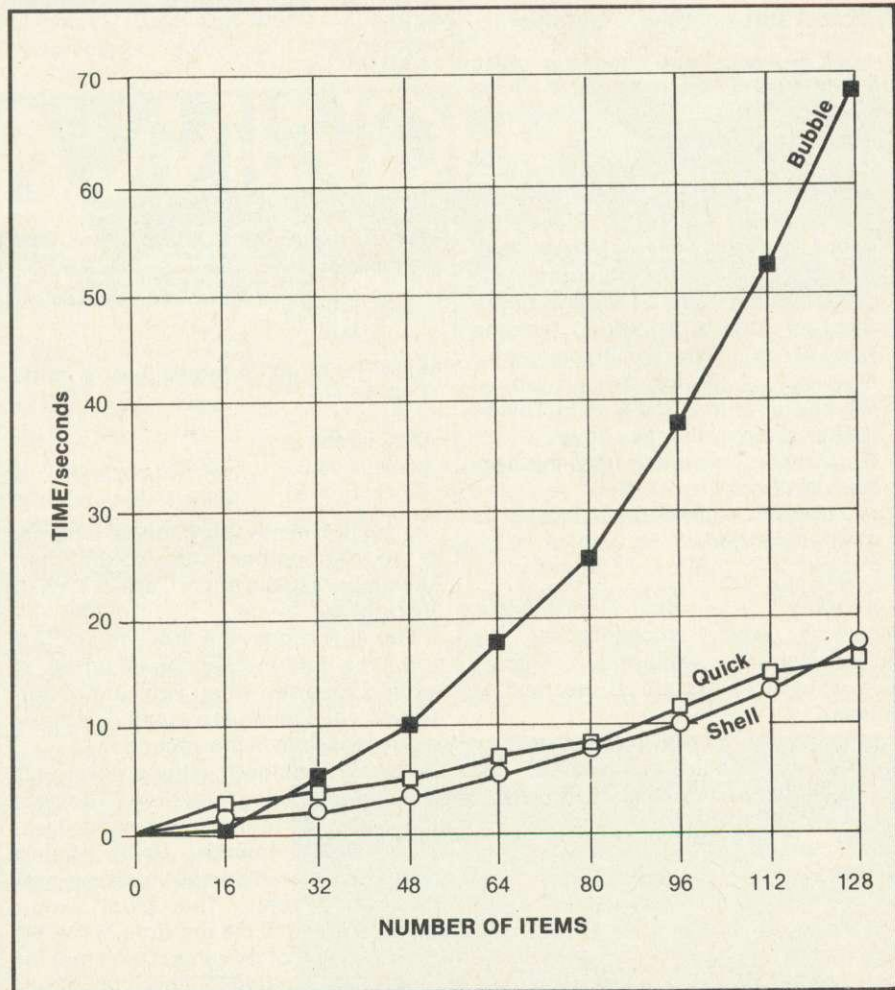

Figure 1. Graph of sorting times for bubble, shell and quick sorts

METHOD OF SORTING	NUMBER OF ITEMS, timed in seconds							
	16	32	48	64	80	96	112	128
Bubble	0.83	4.21	9.83	17.87	26.67	38.23	52.32	69.2
Shuttle	1.08	5.8	12.63	23.36	33.69	47.13	63.69	86.01
Insertion	0.68	3.43	7.92	14.4	20.68	29.44	40.4	53.83
Selection	0.61	2.06	4.31	7.43	11.29	15.91	21.38	27.66
Shell	0.67	2.21	4.0	6.12	8.26	9.88	12.12	16.75
Quick	1.43	3.04	4.96	7.1	8.78	11.73	13.69	15.57
Tree	1.56	3.93	6.91	9.95	13.29	16.91	20.42	24.18

Table 1. Time trial results for each sort

The mathematical reasons for the efficiency of this method are not clearly understood, but it produces remarkably consistent results, and is the method I would recommend if you want to sort medium amounts of data (50 to 500 items, say).

The last two methods in this brief survey are the most difficult to understand, and are valuable if large amounts of data must be sorted (from 200 to many millions of items).

Quick sort

The quick sort algorithm is as follows:

Look at the list and choose a 'pivot' value. Don't be too fussy, but it will be better if the pivot is somewhere near the middle of the list.

Now sort the list so that a 'partition' appears, above which all items are smaller than the pivot, and below which all items are less than or equal to the pivot. (It is not implied at this point that the items in either half are in order, nor is it implied that the pivot value is at the partition point.)

Now look at the top section (above the partition) and find a pivot. Divide it around a partition as above.

Repeat this sequence until the section partitioned is in order.

Go on until each sub-section left is similarly sorted.

Horrible, isn't it?

Actually it is an ideal algorithm for recursion, which accounts for my rather awkward explanation. Recursion is hard to explain at the best of times.

Let's look at one bit of quick sort to get the idea. We are trying to sort the numbers 4,2,9,7,1,3. Choose a pivot. I choose 4. (At least it is not the smallest, as the next number (2) is less, so it is somewhere near the middle.)

Let's call the first item 'left', and the last the 'right'. Imagine pointers (L and R respectively) pointing at each. Swap the L and R values. This ensures that there is one item in the bottom half

which is less than or equal to the pivot. So the order now is:

```
3,2,9,7,1,4
L   R
```

Move the left pointer along until it hits a value greater than or equal to the pivot (4):

```
3,2,9,7,1,4
L   R
```

Now move the right pointer until it either coincides with the left, or hits a value less than the pivot (4 - remember?):

```
3,2,9,7,1,4
L   R
```

Swap the values at L and R:

```
3,2,1,7,9,4
L   R
```

Move L right until it hits a value > = pivot:

```
3,2,1,7,9,4
L   R
```

Move R left until it meets L, or a value < pivot:

```
3,2,1,7,9,4
L   R
```

The section is now partitioned. L points to the first number in the bottom half. All numbers to the left of L are < 4, all to the right are > = 4.

You now repeat the process on 3,2,1 and 7,9,4 until the section is sorted. A section is sorted when you cannot find a pivot - all values are equal - or there is only one item in the section.

When you follow it using program 1, I recommend a long 'waittime'! The section being partitioned is turned blue. Cyan again marks items being swapped. The left pointer is yellow, and the right green. The pivot value appears in red to the top right of the list to remind you of its value. Don't feel inadequate if you don't follow it first time. I didn't, and I wrote it! Check each time

that, at the end of each section, the values above the yellow or green marked value are less than the pivot, and those below are greater or equal.

Tree sort

The final sort is the tree sort or heap sort. The values are treated as a binary tree. This may become clearer if you look at the examples below. The algorithm is as follows:

Sort the tree out so that the biggest value is at the top (or root - computing trees are upside-down) of the tree, and so that all 'children' are smaller than their 'parents'. This is called a 'partially ordered tree'.

Now extract the value at the bottom of the tree (its rightmost 'leaf' - upside-down tree, remember).

Replace it by the 'root', which must have been the biggest value, and so belongs at the bottom.

Now find the right place to replace the removed leaf by swapping the larger values up towards the root, until the leaf slots in.

Repeat with the next leaf, and continue until sorted.

Confused? Let's watch it in action for the same six numbers as before, 4,2,9,7,1,3.

As a tree they are:

```
      4
     / \
    2   9
   / \
  7  1  3
```

Start at the 2, and follow it up to the root 2,4. For the partially ordered tree every parent must be bigger than its children: 4 is bigger than 2, so leave them.

```
      4
     / \
    2   9
   / \
  7  1  3
```

Move on to 9, and follow it up - 9,4 - 9 is greater. Swap them. Move on to 7 - 7,2,9. Needs changing to 2,7,9, and the tree is now

```
      9
     / \
    7   4
   / \
  2  1  3
```

Move on to 1 and follow it up - 1,7,9. No change needed.

Move on to 3 and follow it up - 3,4,9. No change needed. Note that 9 is bigger than 7 or 4, 7 is bigger than 2 and 1, 4 is bigger than 3.

To sort the tree, extract the 3, and put the 9 to the bottom:

```
      *
     / \
    7   4
   / \
  2  1  9
```

Where does the 3 go? Look for the larger child of the empty root. This is the 7. Compare it with the 3. If it is bigger, move it up to the root, and look

at its children:

```

    7
   * 4
  2 1 9
  
```

Look at the larger child (2). It is smaller than 3, so replace 3 where the * is:

```

    7
   3 4
  2 1 9
  
```

The subsequent stages in the sort are:

```

    4
   3 1
  2 7 9
  
```

```

    3
   2 1
  4 7 9
  
```

```

    1
   2 3
  4 7 9
  
```

and the tree is now sorted!

In program 1 the tree's 'generations' are coloured. The root is magenta, first generation is red, second generation yellow, third generation blue, fourth generation (one item only) magenta again. Items being compared are green, and items being swapped are cyan. When an item reaches its correct slot it is white.

Pros and cons

What are the advantages and disadvantages of these methods? Let's ignore the shuttle sort, which seems to have no advantages. The bubble, insertion and selection sorts are all reasonably easy to code, and for small amounts of data there is little to choose between them, though the selection method is clearly faster, as it avoids unnecessary swapping - comparisons are much quicker than swaps.

The shell sort becomes more efficient in the medium range, though it takes a little more careful coding.

The quick sort and tree sort come into their own only on larger amounts of data. Even with 128 items the quick sort has caught up and overtaken the other methods, but the tree sort is still behind shell. On larger amounts quick and tree get well ahead. The great and unreadable authority Knuth suggests that the quick sort should be used to partition down to about nine items, and then the final sort should be done with one of the simpler algorithms. The tree sort has one advantage over the other methods. It always takes the same number of comparisons to carry out the sort whatever order the data was in initially. It has no 'best' and 'worst' case, except for minor variations in the number of

swaps necessary, which could be got over by the selection method suggested above. Its disadvantage is that it has to sort the data twice.

Timings of the various methods on varying numbers of random names are summarised in table 1. This clearly illustrates the folly of trying to stick to the simpler algorithms for large numbers of data items, and the equal folly of writing complex recursive procedures to sort small numbers of data items.

Notice how the time taken by the simple algorithms is proportional to n^2 . (If the number of data items double, the time taken is multiplied by 4). The quick sort is an $O(n \log n)$ method, while the tree sort is an $O(2n \log n)$ method. Their times increase much less rapidly as the number of data items increase (for further information I refer you to Stan Froco's article in the February 1984 issue).

One more type of sort needs to be discussed. These are sorts that can be applied to large files. The problems arise when the data cannot all be held in memory at once. Two important sorts which can deal with this situation are the merge sort and the tournament sort, or a combination of the two. These will be illustrated in a later article.

DATA MINDER

THE DATABASE MANAGER FOR YOU

WILL USE ALL DRIVES AS A SINGLE UNIT

Dealer inquiries welcomed.

DATAMINDER is a powerful and flexible truly disk based database management system. It is designed to minimise the thought and effort required to set-up, maintain, organise and use large collections of data.

Three screen editors are included. The first provides for easy definition of new files or restructuring of existing files. The second functions like a worksheet for the writing and recall of records. A wide variety of record display formats are available some allowing immediate editing of disk contents. A third screen editor opens-up a wide variety of possibilities for producing customised reports containing information selectively drawn from a file and mail merged letters or circulars. Reports can be structured in standard essay format with the bulk of the text sandwiched between an introduction and conclusion.

For rapid access any or all of the fields can be indexed with a balanced B-Tree structure ensuring optimal record searching and retrieval times. These are typically 3-4 seconds to locate one record from a 1000. Search requests can be specific and include as many fields as you wish. Selection can even be made on the results of commands temporarily manipulating field data.

ADDITIONAL FEATURES INCLUDE

- ☆ Up to 26600 records in each file, disk capacity and record size allowing.
- ☆ Maximum of 150 fields per record, containing in total a maximum of 1200 bytes of text.
- ☆ Sup-

- port for string, numeric, integer and date fields.
- ☆ 5 date formats and strings of up to 150 characters long allowed.
- ☆ Automatic allocation of disk space for files and extension of this as and when necessary.
- ☆ Rapid switching between use of separate files.
- ☆ Batch updating and deleting of records.
- ☆ Optional program monitor enabling, among other things automatic checking to warn you beforehand of duplicated record entry.
- ☆ Fields can be inserted, deleted, moved or renamed, indexed or de-indexed.
- ☆ Field types and entry lengths are also alterable.
- ☆ Up to 10 files each with any or all of the fields redefined in any of the above variety of ways can be processed in a single batch operation.

The package includes a comprehensive manual introducing you to the system and furnishing dedicated users with all detailed information they could wish for.

ONLY £ 29.50 + £ 2 p&p ex.VAT

Send now for our information leaflet, or order direct by writing to

Access welcome



COMPUTERWISE
DAMBRUGGESTRAAT 60
2008 ANTWERPEN BELGIUM
or phone (except sundays)
(010-323) 234 31 54



THE PRINTED WORD

LOW PRICES TOP SERVICE

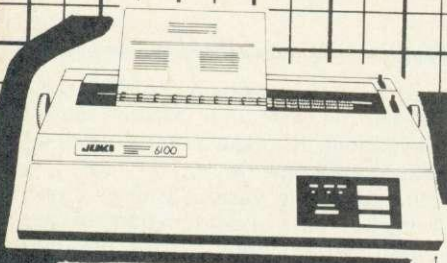

JUKI 6100

One Year Warranty
 20 CPS : BiDirectional & Logic Seeking
 10, 12, 15 & Proportional Spacing
 Wordstar Compatible
 2K Buffer : 13 Inch Platen
 Underline : Backspace + Lots more
 Centronics Interface Standard
 RS 232 Interface £54.00 + VAT Extra
 Tractor Feed £99.00 + VAT Extra
 Single Sheet Feeder £238.00 + VAT Extra

JUKI 6100 £330.43 + VAT = £380.00

BBC/ORIC or DRAGON Package
 JUKI 6100 + C.J.E. PRINTER PACKAGE
 £400.00 inc. VAT



CANON PW-1080A

Near letter Quality Printer

NLQ Mode 23 x 18 Matrix: 27 cps
 Draft Mode 11 x 9 Matrix : 160 cps
 Full range of Epson FX 80 Print Codes
 Friction & Tractor Feed
 Centronics Interface Standard
 CANON PW-1156A (Accepts 15" Paper) Available

CANON PW-1080A £278.26 + VAT = £320.00
 CANON PW-1156A £360.00 + VAT = £414.00

PACKAGE PRICE for BBC MICRO/DRAGON/ORIC
 CANON PW-1080A C.J.E. PRINTER PACKAGE £345.00 inc. VAT
 CANON PW-1156A C.J.E. PRINTER PACKAGE £439.00 inc. VAT

Special RS 232 Printer Bargain

STAR DP8408 (8" Printing) £187.00 inc. VAT
 Ideal for BBC/Newbrain/HX20 & Spectrum Int. 1
 Phone for full specification

C.J.E. Micro's BBC Printer Packs

For Star, Canon & Juki Printers include:

1. The Printer
 2. Delivery by Securicor
 3. Cable to the BBC 1.3 Metres
 4. Screen Dump Program (M/C Source)
 5. Text Dump Program
 6. Function Key set up Program. For use with WORDWISE
 7. Function Key Label Printing Program. For use with above.
 8. VIEW Printer Driver
 9. 100 Sheets of Paper
 10. Mains Plug with 3 Amp Fuse
 11. Booklet giving details of using the printer with a BBC.
 12. Character Defining Program for Downloadable-character-set
- C.J.E. Printer Packs for other micro's include:-
 Printer, Cable, Paper, Mains Plug & Delivery

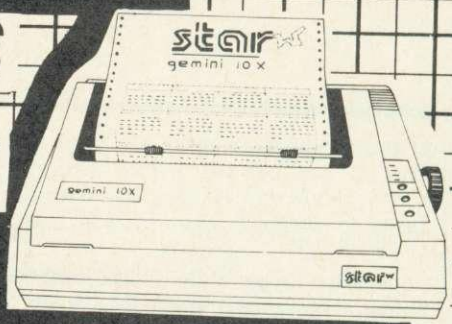

STAR GEMINI 10X

One Year Warranty
 True Descenders 9 x 9 Matrix
 120 CPS Bidirectional & Logic Seeking
 40, 48, 68, 80, 96, 136 cpl
 Italics, Emphasized, Double strike,
 Super & Sub Scripts
 Downloadable Character Set
 Hi-Resolution & Block Graphics
 Friction or Tractor Feed
 10 X 10" Carriage, 15 X 15" Carriage
 Centronics Interface Standard
 RS232 Int. £52.00 + VAT Extra

Gemini 10X £235.00 inc VAT
 Package for BBC/DRAGON/ORIC
 GEMINI 10X + CJE Printer Pack £255 inc. VAT
 Star Gemini 15X £380 inc. VAT

STAR DELTA 10
 SPEC. AS FOR 10X PLUS:-
 160CPS: 8K BUFFER
 CENTRONICS + RS232 INT'S STD
 £311.30 + VAT = £358.00

BBC MICRO MODEL B £399.00

Electron £199.00

BBC Micro Model B with Disc Int. £469.00

Large Range of Accessories including Disc Drives, Printers, Monitors always in stock

Printer Cables

BBC to 36 Way Centronics Type Connector £15.00
 Dragon to 36 Way Centronics Type Connector £15.00
 Oric to 36 Way Centronics Type Connector £15.00
 Torch to 36 Way Centronics Type Connector £20.00

Serial Printer Cables

BBC to 25 way D type £9.50
 EPSON HX20 to 25 way D type £9.50
 NEWBRAIN to 25 Way D Type £12.00
 25 way D type to 25 way D type £15.00

Blank C15/C30 Cassettes Ten for £4.50 ANY MIX
 Send SAE for Full Price List

VAT INCLUDED WHERE APPLICABLE PHONE/CREDIT CARD ORDERS WELCOME

Postage 50p per order or as stated
 24 Hr Securicor Delivery
 for Printers/Disk Drives £8.00
 (SHOP/WORKSHOP CLOSED MONDAYS)

C.J.E. Microcomputers

DEPT (AU), 78 Brighton Road, Worthing
 W. Sussex BN11 2EN (0903) 213900

EXPORT ORDERS WELCOME

RING FOR SAMPLE PRINTOUT, FULL SPECIFICATIONS & LATEST PRICES
 BEST PRICES & BACKUP ON THE STAR JUKI & CANON PRINTERS

INTERNAL EXAMINATION

The Beeb can be programmed to self-diagnose its own ills. Paul Beverley wields the stethoscope

WHAT do you do if you suspect your computer has a hardware fault? If you have a dealer near at hand and your machine is still under warranty there's no doubt as to the best course of action. But if your machine is out of warranty and if you don't have a good dealer nearby, you have a problem!

Now, assuming you have some idea about electronics—for example, you know one end of a soldering iron from the other and you are bold enough to tinker with your machine—where do you start? The problem is that it's a complex piece of hardware and most of the test techniques available involve expensive pieces of equipment. Suppose you haven't even got an oscilloscope. Is there anything you can do? Well, in this article I hope to show you a technique that is used in industry for fault-finding microprocessor systems.

The commercial test units are not cheap, but we can take advantage of the versatility of the BBC micro-computer and use the technique with minimal external hardware that can be made up fairly cheaply on an old bit of Veroboard.

The technique, 'signature analysis', involves actually running a program in the computer under test to check whether the computer is functioning properly. This means that it cannot be used for testing a totally dead machine, but despite this it is a useful technique with the major advantage that it can be done cheaply.

The basic principle

While the test program is running a probe is used to pick up a data stream from one point in the circuit. The hardware compresses this data stream into a 16-bit number, which is read into the computer itself. The number produced by testing any given point (referred to

as its 'signature') doesn't have any particular significance in itself, but it will be characteristic of the data stream that produced it. Thus, by comparing it with the expected signature for that point, you can tell whether or not that part of the computer hardware is working properly.

The test routines are tried out on a known working system and the signatures obtained at various test points, such as address and data lines, are noted. These can then be compared with the signatures obtained on a suspect system and, when false signatures appear, it becomes clear that there is a fault. It is important, however, that no interrupts are allowed to occur during the test period as these don't happen at the same time in any given test run and will thus give a different signature each time the test is tried.

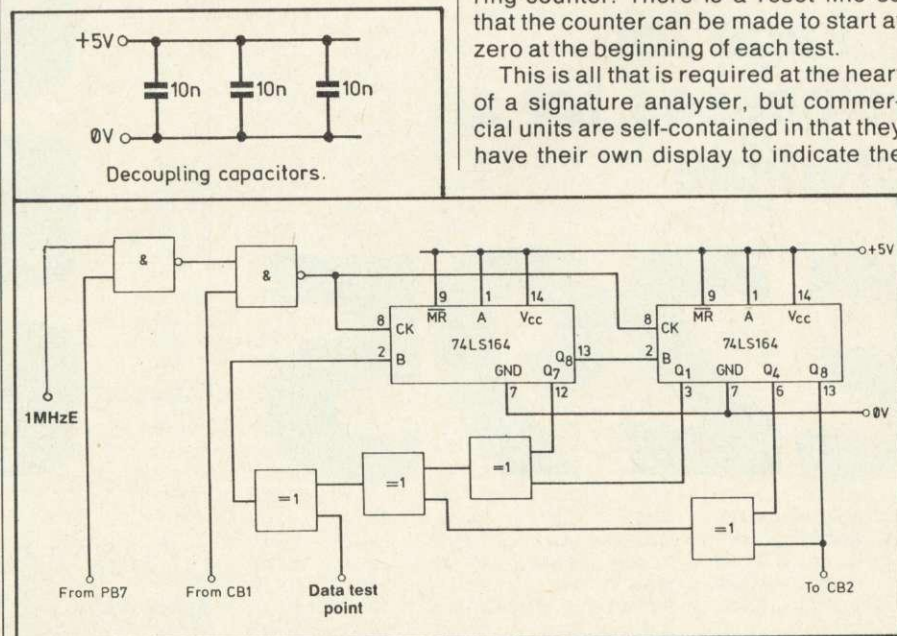

Figure 1. Hardware of the self-test signature analysis system

If the test routine is changed in any way all the signatures will be different, so the routines, once set up, must not be changed. If you want to use the test routines they must be copied faithfully from the listing, then you can use the signature values given in tables 1 and 2. If you want to use different routines, they need to be tried out first on a computer known to be working properly and the signatures recorded. By using different routines you can 'exercise' different parts of the circuit such as the keyboard, display and printer interface.

A number of faults occur commonly in digital systems, and many can be detected by the signature they produce. For example, if a line is permanently low the signature will be 0000, and if the line is permanently high the signature will have a particular value depending on the duration of the test. This value can be found by putting the data probe on the +5v line. If two lines come up with the same, but incorrect, signature the chances are there is a short-circuit somewhere between those two lines.

Hardware

The circuit used is shown in figure 1, and if you read last month's article, which dealt with hardware random number generators, you will probably recognise part of the circuit. The hardware of the analyser consists of a 16-bit shift register connected to form what is known as a 'ring counter' or 'chain-code generator'. This generator is used as a data-compressor to produce the signature of the incoming data. The data, as it comes in, is Exclusive ORed with the other feedback lines of the ring-counter. There is a reset line so that the counter can be made to start at zero at the beginning of each test.

This is all that is required at the heart of a signature analyser, but commercial units are self-contained in that they have their own display to indicate the

It's a British product,
it's versatile, it's
powerful and it's

Cutting the cost of business software in half.

EASY
— junior —

An easy to use,
all-in-one software
package for
businesses for an
incredible

£295

plus VAT

Please Note: While Microstyle will endeavour to maintain sufficient stocks of items currently or previously advertised we regret that all items are offered for sale subject of availability from manufacturers.

If you've delayed making the change to a business computer system on the grounds of cost or complexity **THINK AGAIN...THINK EASY!**

'Easy junior' is a complete, accounts management package designed for use with the top selling BBC microcomputer and TORCH Z80 disk drive package* award winning. Developed wholly in the UK. The 'Easy junior' system has been created to fulfil the needs of users with little or no computer experience and to grow and develop in time with your business needs.

*Also available for APRICOT **Written in CIS Cobol**

'Easy junior' has been designed with the user in mind. Even the 'Easy junior' manual is the result of careful and far reaching research into the needs of individuals and businesses who will be using the system. 'Easy junior' allows you to control your accounts, your stock and your invoicing and to provide up to the minute management information from a choice of over 20 printed reports and screen enquiry facilities. Even those with no computer experience will quickly be able to provide a valuable and cost effective accounts management service.

'Easy junior' is not only powerful, and simple to use but is flexible too! As your business grows your accounting facilities need to expand and 'Easy junior' is designed to grow with you. All the central programs featured in the 'Easy junior' package are the same as those featured in the 'Easy' or 'EASYplus' systems for larger businesses. If you outgrow 'EASY junior' all you have to do is advance to the next EASY system with almost no retraining and no loss of fixed data.

EASY junior: Truly professional business software at a truly business like price.

Designed to conform to the accepted standards demanded by sales taxation authorities in most countries and your auditors.

Featuring:

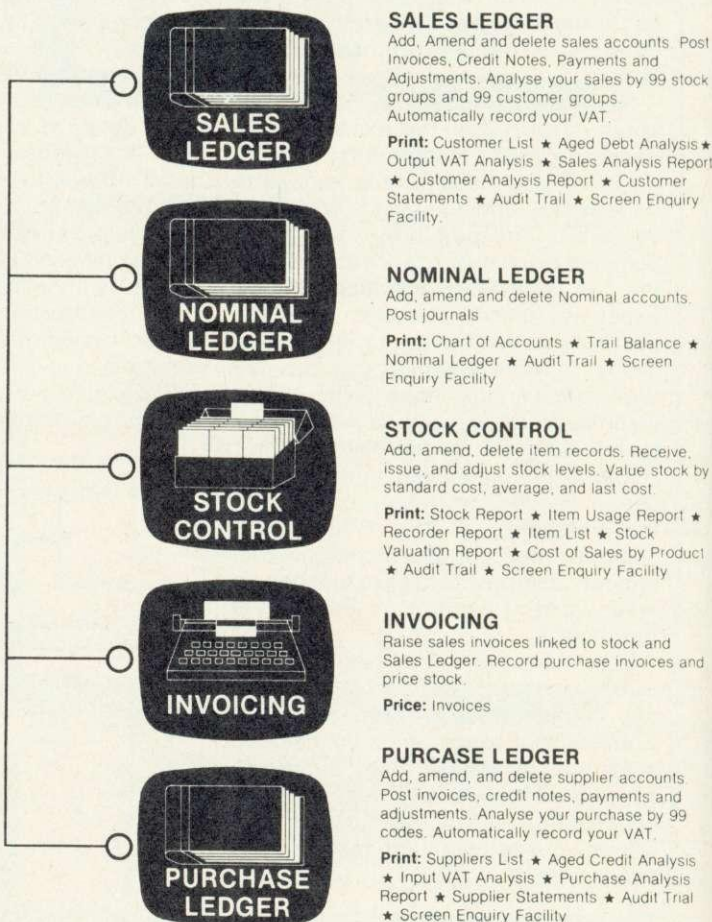

**CONTACT YOUR NEAREST
MICROSTYLE BRANCH
FOR FURTHER INFORMATION**

MICROSTYLE YOUR NO.1 FOR CHOICE, VALUE & SERVICE

Dealer Information update

Microstyle have been appointed as an official, regional distributor for EASYJUNIOR business software.

'BUSINESS SOFTWARE AT ITS BEST' contact us now for more information and DEALER DEMONSTRATION PACKS.

Easyjunior software available for BBC + TORCH DISK PACK and Apricot

The network is spreading..

Every month more and more retailers countrywide are discovering Microstyle value and service. So contact us now and find out more about what you could gain from joining the Microstyle dealer network!



DEALER HOTLINE

Trade Enquiries Only

0635 - 35384

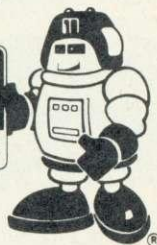

Branches:

The Aylesbury Computer Centre
52 Friar's Sq., Aylesbury.
Telephone: Aylesbury (0296) 5124

The Bath Computer Centre
29 Belvedere, Lansdown Road, Bath.
Telephone: Bath (0225) 334659

The Newbury Computer Centre
47 Cheap Street, Newbury.
Telephone: Newbury (0635) 41929

HARDWARE

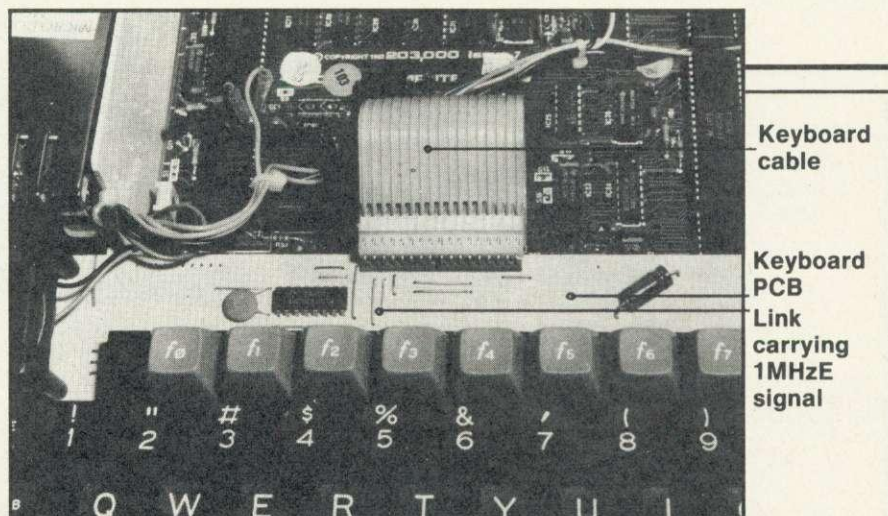

Figure 2. The wire link on the keyboard PCB that carries the 1MHz signal

signature obtained – usually a modified seven-segment display. In our case, to cut the cost down, we use the computer itself to read and display the signature. The number held in the two eight-bit registers is read into the micro by using the shift register on the 6522 VIA. To do this, the PB7 line is used to disable the normal clock pulses and allow the pulses coming out of CB1 to clock the registers as the data is read into the VIA on CB2. PB0 is used to reset the registers.

Care should be taken to keep leads as short as possible and adequate decoupling should be provided as suggested on the circuit diagram. The clock signal used during the analysis is the 1MHzE line, which is easily available on the keyboard PCB as shown in figure 2. This line is used in preference to the 2MHz line because much of the

input/output, both internal and external, takes place at 1MHz. Thus if a 2MHz clock is used it is difficult to obtain a stable signature.

Even when the 1MHz clock is used problems are caused by the dual-speed clock that the Beeb uses (1MHz/2MHz). You will find there is an occasional variation in the signatures produced on the data lines, usually only of 2 or 4 in the least significant hexadecimal digit – ie, there's some variation in one of the last three bits of the data stream. This takes place as the 6502 is reading the value held by the VIA. Such variation should not, of course, be taken as an indication of a fault in the circuit.

Apart from having the test leads as short as possible, it is a good idea to screen them. If they are not screened and the lead carrying the 1MHz clock

TEST	1	2	3	4	5	6	7	8
+5V	EDC7	B752	DB66	C7A2	8593	B4B8	29DD	B279
A0	515C	B40C	51B0	B747	FD31	D453	A5DB	F071
A1	5329	6159	A24B	B1B2	CFDA	7A1B	92B2	12B7
A2	3373	30D2	3B57	4289	57DC	E8E4	5E0E	64CF
A3	7E20	2C72	FEFE	051F	95A3	30CC	68D8	C03C
A4	ACAS	EF96	4A33	273E	02C5	5284	2E19	04D8
A5	ECEB	2B91	155F	8AA9	73BF	135E	788C	5851
A6	BF3A	3A25	0185	E74A	4FB8	FDB4	A110	339B
A7	9463	516C	0DB3	90B4	A3ED	8068	F03D	5D5B
A8	0DF2	AC41	1B0A	9279	A3ED	3732	5EF9	75E2
A9	B5E1	9A5E	0002	0006	4F6F	B7E4	E81C	EB2C
A10	55D6	814F	C06C	E038	267E	838A	7724	C79B
A11	E035	814F	C06C	55DB	267E	838A	7724	C79B
A12	0002	0002	0002	B5E5	4F6F	B7E4	E81C	EB2C
A13	0002	0002	0002	B5E5	4F6F	B7E4	E81C	EB2C
A14	0002	9A5E	0002	B5E5	4F6F	B7E4	E81C	EB2C
A15	B5E1	9A5E	0002	0006	4F6F	B7E4	E81C	EB2C
D0	2AB5	2C74	75DA	CFD0	769A	B935	AD51	FC97
D1	2BAB	1EF3	5898	9214	BB14	107A	4082	9D34
D2	F41B	A219	B515	DBC2	6135	F004	7B1A	E4CF
D3	EEE4	FB7F	7216	BC38	13D0	6E42	771D	BF7E
D4	9856	06CC	A26E	B60B	CC6F	788C	7BE7	466E
D5	3C1E	7DB8	6E0A	E417	83D0	C230	E0EA	8006
D6	131F	3A15	1FC6	8329	78EB	CAD3	C6EB	9116
D7	EABC	B57D	70BC	1337	83D4	9A2C	0A67	15DC
R/NW	E057	B12D	C00E	E07E	2638	83CC	7746	C7DD
sync	B710	BA46	DBAD	2790	70AB	056C	D7BE	DCD9

Table 1. Signatures on the main processor bus lines for each of the eight tests

<u>Test 5</u>		
VIAA (IC 3)	pin 23	CAFA
<u>Test 6</u>		
8271 (IC78)	pin 7	9EFA
	pin 9	0007
	pin 24	035A
<u>Test 7</u>		
Video ULA (IC 6)	pin 17	A053
	pin 18	A89C
	pin 19	9305
	pin 20	9F02
	pin 21	93F9
	pin 22	E0EB
	pin 23	2EF5
	pin 24	E279
pin 28	29DC	
<u>Test 8</u>		
ACIA (IC 4)	pin 9	08D7

Table 2. Signatures for various test points on specific ICs

signal is brought anywhere near the data input lead, you may find the signature becoming unstable.

Software

The operating program (yellow page 107) is written in a reasonably structured way and should be more or less

self-explanatory. The display it produces is a line of text asking for the number of the test to be carried out. This information remains on the screen, while the results are shown in a text window underneath. After selecting the test required and pressing return, you can either have that test running repeatedly, displaying the results on a scrolling screen, or do the test once at each test point. For a continuous output, press Return again.

If any other text is typed in it will be displayed on the screen and then, when you press return, the test is carried out once and the result displayed opposite the text that you entered. This enables you to type in the name of the test point and then do the test. For example, you could put the test probe on the first address line, type in A0 and then Return, and the signature for the A0 line would then be displayed. You can use CTRL-B to switch on the printer and CTRL-C to switch it off, so you can produce a printout of the signatures for the various test-points on each of the tests.

If you want to change to a different test, press Return followed by N (for Next) and it will go back to displaying the prompt, which asks for the test

number. If you are using a printer, switch it off before you do this. The sequence is 'CTRL-C, return, return, N'.

As it stands, the program offers eight different tests covering the lower half of the RAM, the upper half of the RAM, the upper and lower halves of the ROM, the internal VIA (VIA-A, IC 3), the disc controller chip (IC 78), the video ULA (IC 6) and the ACIA (IC 4). Any further tests can be added to the end of the existing tests, simply using the same format. The signatures resulting from these eight tests are given in Table 1, and some of the signatures at particular points on the ICs in Table 2.

These signatures should be the same whatever machine you are using as except that, as already mentioned, you tend to find that the signatures on the data lines are different by either 4 or 2 in the least significant hex digit. Having said that, you may find certain variations and, considering the amount of data in table 1, there's more than likely to be one mistake or more.

Ideally you should make up this unit before your computer goes wrong. You can test out the routines on your machine and make any necessary changes to the list of signatures.

Why buy two when one will do?

The INFRASCOPE COMMUNICATOR II is an electronic typewriter AND a computer printer
ALL IN ONE



- ★ RS 232 Compatible KSR and Parallel RO interface.
- ★ Approved interface for the SCM 1100 Typewriter.
- ★ Interface cables available for BBC/B, Commodore 64, Sinclair QL, Spectrum, or virtually any other micro computer with an RS232 or Centronics interface.
- ★ Choice of 2 or 8K character buffer.

ALL THIS FOR ONLY £458 Incl. VAT and Delivery
(Interface Cable Extra) VISA/ACCESS Accepted

The new KSR COMMUNICATOR II is now available for immediate despatch. Using the popular Smith Corona EC 1100 typewriter we have created a high quality computer printer by fitting our new INFRASCOPE interface.

But don't take out word for it, write or phone for our free comprehensive data sheet.

INFRASCOPE LIMITED

Longbeck Road, Marske, REDCAR, Cleveland. TS11 6HQ. Telephone 0642 470121

OUR DOUBLE-SIDED 3" DISC DRIVE. A TRIUPLE OFFER.

Opus have a triple offer of 3" disc drives for those who wish to improve their micros.

The disc drive is compatible with the BBC Micro, has a direct drive mechanism, is double-sided and comes with a comprehensive manual.

And with every purchase, a 3" utilities cartridge will come free.

Our offer also includes VAT, all necessary leads

and carriage along with a two year guarantee—which is a year more than any other company can offer.

You can order by posting off the coupon below or calling at Opus Supplies Ltd., 158, Camberwell Road, London SE5 0EE. 01-701 8668 or 01-703 6155.

We are open 9–5.30 Monday to Friday and 9.00–1.00 p.m., Saturdays.

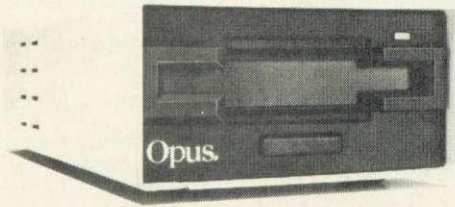

3" DISC DRIVE

You can buy this 500K (Unformatted) double-sided disc drive for the same price that other companies sell single drives for. The drive heads read and write to and from both sides of the disc cartridge, giving you twice the on-line capacity of single 3" drives.

Normally ~~£229.95~~

Now **£199.95**

SAVE £30

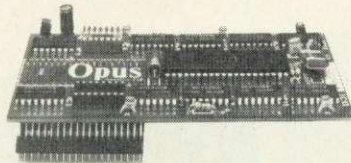
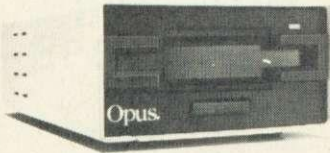

3" DISC DRIVE AND DOUBLE DENSITY INTERFACE

If you currently run your program on a cassette recorder, you'll need to upgrade your micro in order to use a disc drive. This offer not only gives you an interface, but it effectively doubles the capabilities of the drive—giving you 350K of usable capacity instead of the 200K normally achievable.

Normally ~~£359.95~~

Now **£299.95**

SAVE £60

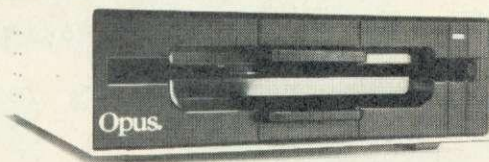

3" DISC DRIVE AND 5 1/4" DISC DRIVE

Both drives come 'daisy-chained' (or linked) together. They're completely compatible and will allow you to down load all those programs you made on 5 1/4" floppy discs onto a robust 3" cartridge.

Normally ~~£379.95~~

Now **£329.90**

SAVE £50

Quantity	Description	Price

Enclose a cheque for £_____ TOTAL

or please debit my credit card account with the amount of £_____

My Access/Barclaycard (please delete)

No. is _____

To: Opus Supplies Ltd., 158 Camberwell Road, London SE5 0EE. Please rush me the following: **(ALL PRICES INCLUDE VAT & CARRIAGE.)**

Name _____

Address _____

Telephone _____

AC29
Opus.
Opus Supplies Ltd.

ELBUG FOR THE ACORN ELECTRON

JOIN NOW FOR A FREE CASSETTE

Join the Electron User Group

Members receive 10 copies of the magazine **ELBUG** each year. **ELBUG** is devoted **EXCLUSIVELY** to the **ELECTRON MICRO**. It is packed with News, Reviews, Hints, Tips, Programming ideas, Major articles, plus Regular program features including games and useful utilities.

ELBUG is produced by **BEEBUG** Publications Ltd., publishers of **BEEBUG**, the magazine of the National User Group for the BBC Micro. **BEEBUG** now has some 20,000 members and has achieved a high reputation both in this country and abroad.

The formula which makes **BEEBUG** an invaluable companion for users of the BBC micro, has been applied to **ELBUG**.

By subscribing to **ELBUG** you gain all the advantages of a single-micro magazine, with

no space wasted on programs and articles for other computers.

BENEFITS OF MEMBERSHIP

ELBUG MAGAZINE

Ten copies a year mailed free of charge.

DISCOUNT SCHEME

Extensive discount scheme with major retailers.

SOFTWARE LIBRARY

A growing range of software titles at budget prices for members.

SOFTWARE CLUB

Substantial discounts on software from major software houses.

LOCAL USER GROUPS

Lists of local affiliated user groups.

SPECIAL OFFER 8 FREE PROGRAMS

Subscribe now, and get a free introductory cassette containing 8 tested programs for the Electron.

1. **SPACE CITY.** Defeat the invading Aliens with your laser, and save the city
2. **3D NOUGHTS AND CROSSES.** Pit your wits against the **ELECTRON** on a 4x4x4 board
3. **RACER.** Guide your racing car to victory, avoiding other cars and obstacles on the track
4. **3D MAZE.** In this challenging game, you must escape from the maze – The screen displays a 3D view from inside the maze
5. **PATCHWORK.** A multicoloured display of continuously changing patterns
6. **KEY SET ROUTINE.** A program to set up the user function keys
7. **MEMORY DISPLAY.** An efficiently written utility to display the contents of memory (ROM and RAM)
8. **CHARACTER DEFINER.** Define individual graphics characters with this useful utility for use in your own programs.



SPACE CITY

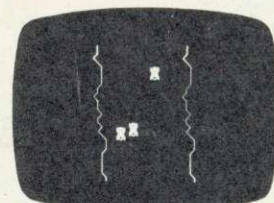

RACER

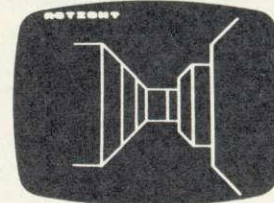

3D MAZE

HOW TO JOIN

To subscribe for one year, and get your FREE CASSETTE send £9.90 (payable to Orbit) plus a strong stamped addressed envelope (for the cassette)

SUBSCRIPTIONS TO: ELBUG, DEPT 13, PO BOX 109, HIGH WYCOMBE, BUCKS

Six months trial subscription (5 issues) UK only £5.90—FREE CASSETTE OFFER STILL STANDS.
Membership outside UK (one year only): Eire and Europe £16.00. Middle East £19.00, Americas and Africa £21.00, other countries £23.00.
Editorial Address: ORBIT, PO BOX 50, St Albans, Herts.

STAR ATTRACTIONS

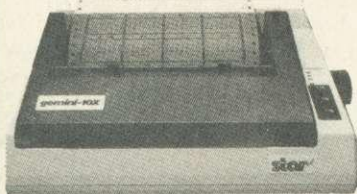

GEMINI-10X

FIDELITY

12 MHz Video Bandwidth
RGB and Composite Video

£169.95 + VAT
= £195.44

Also available in TV/monitor
version at £195.95
(+ VAT) = £225.34

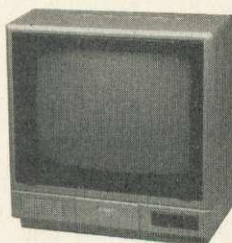

14 INCH COLOUR MONITOR

£189.95
+ VAT = £218.44
120 cps ● Bi-Directional
Logic Seeking ● Friction
Tractor and Roll Holder
Standard ●
Downloadable Characters
● Ultra High Resolution
● 80 cols ● IBM PC
version now available.

LOOK! NEW LOWER PRICES ON EPSON STAR & BROTHER

DAISYWHEEL PRINTERS

BROTHER HR 15 CALL FOR BEST PRICES
JUKI 6100 £325 + VAT = £373.75
DAISYSTEP 2000 £225 + VAT = £258.75
EPSON DX 100 £369.95 + VAT = £425.44

DOT MATRIX PRINTERS

EPSON RX 80 £198.95 + VAT = £228.79
EPSON RX 80 F/T £228.95 + VAT = £263.29
EPSON RX 100 £384.95 + VAT = £442.69
EPSON FX 80 £319.95 + VAT = £367.94
EPSON FX 100 £498.95 + VAT = £573.79
STAR GEMINI-10X £189.95 + VAT = £218.44
STAR DELTA 10 £319.95 + VAT = £367.94
STAR RADIX 10 £498.95 + VAT = £573.79

THERMAL MATRIX PRINTERS

STAR STX 80 £129.95 + VAT = £149.44
BROTHER HR5 CALL FOR BEST PRICES
BROTHER EP 44 CALL FOR BEST PRICES

Cables - Paper - Ribbons - Sheet Feeders
Tractor Feeds - Interfaces - Call for Best Prices



**CREDIT CARD
HOT LINE**
01-482 1711



PLEASE ADD £10 + VAT FOR DELIVERY
POST YOUR CHEQUES/P.O.'s TO:
DATASTAR SYSTEMS UK
UNICOM HOUSE, 182 ROYAL COLLEGE STREET
LONDON NW1 9NN
Telex 295931 UNICOM G

TAX-FREE EXPORT & DEALER ENQUIRIES WELCOME
Personal callers welcome. We are situated at the junction of
Camden Road, near the railway bridge.

keyzone

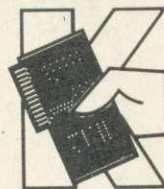

**SOLID STATE DESK TOP
SWITCHING DEVICES**

THE PRINTERSHARERS

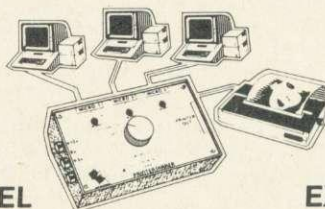

PARALLEL

26 PIN (AS BBC) 3 MICROS TO 1 PRINTER	EX. VAT
26 PIN (AS BBC) 6 MICROS TO 1 PRINTER	£65-
36 PIN (AMPHENOL) 2 MICROS TO 1 PRINTER	£129-
36 PIN (AMPHENOL) 3 MICROS TO 1 PRINTER	£85-
	£105-

SOLID STATE SWITCHING

- * Solid State Switching
- * Extra cable lengths
- * No plugging/unplugging
- * Easy to operate
- * Simple installation

SAVES TIME & MONEY

- * Saves time
- * Saves money
- * Connect in multiples
- * No limit to sharers
- * 12 months warranty

THE PRINTERCHANGERS

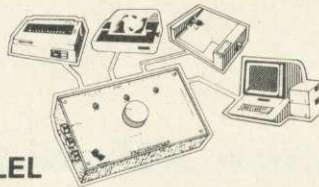

PARALLEL

26 PIN (AS BBC) 1 MICRO TO 3 PRINTERS	EX VAT
36 PIN (AMPHENOL) 1 MICRO TO 2 PRINTERS	£75-
36 PIN (AMPHENOL) 1 MICRO TO 3 PRINTERS	£95-
	£115-

KEYZONE SOLID STATE "PRINTERSHARERS" AND
"PRINTERCHANGERS" ARE THE ONLY SWITCHING
DEVICES TO INCORPORATE THE 26 PIN BBC PRINTER
PORT CONNECTIONS.

OPTIONAL

MP1 - DC mains power pack for sharer/changer £6.50

LEADS - PARALLEL

26-26 PIN 2 MTS	£9- Each pack of 3	£25-
26-36 PIN 1 MT	£10- Each	
26-36 PIN 1.5 MT	£12.50	
26-36 PIN 2 MT	£15-	

Any cable can
be made to order

SERIAL - RS232

3 way 25 pin Printersharer/Changer	EX VAT
	£75-

LEADS - SERIAL

25 pin D type plug on each end - 2MT	EACH	PACK OF 3
25 pin D type plug on each end - 5MT	£12-	£34-
	£14-	£39.50

KEYZONE LTD

U 14, Regeneration House, School Road, Park Royal, London
NW10 6TD. Telephone: 01-965 1684/1804 Telex: 8813271

All products carry a full 12 months guarantee
All prices are exclusive of postage & VAT
P&P Switches £1.50 each. MP1 & Leads £0.50
All Keyzone products are designed and manufactured in
the UK and are supplied fully tested to the highest standards.

Take the mountain to Mohammed for less than £300

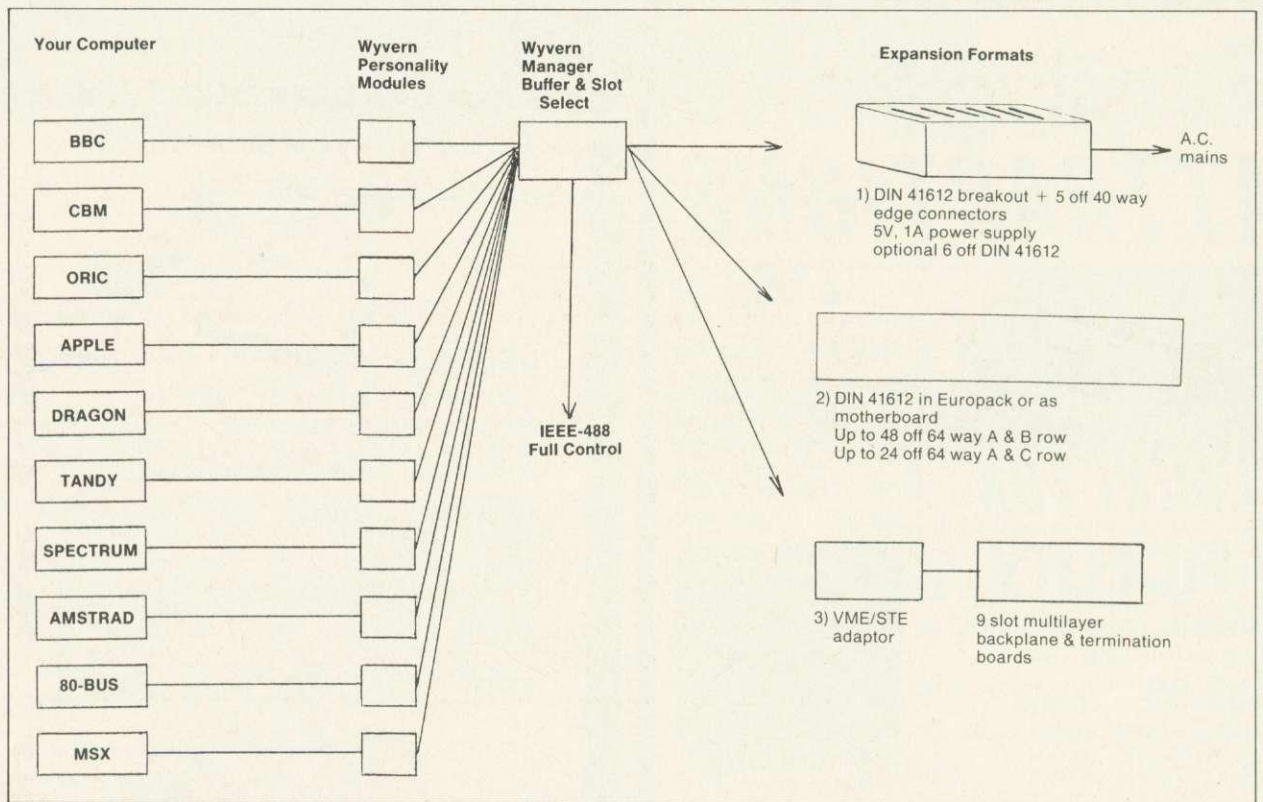

TRANSPORTABLE GENERAL PURPOSE INTERFACE *plus* IEEE—488 FULL CONTROLLER

Memory Expansion?
I/O and Peripheral Expansion?
CPU Development?
Instrumentation/Process Control?

Industrial, Educational
Commercial, Personal
applications across all
common microcomputers

Full range of supporting P.C.B.'s for DIN 41612 and edge connectors plus limited stocks of low cost pre-production boards and wyvern units.

WESSEX MICROCOMPUTERS

9 Hopkins Court,
Bennetts Field Trading Estate,
Wincanton,
Somerset BA9 9DT

Telephone: 0963-33509



Accepted

SYSTEM SOFTWARE

•ROMS FOR THE BBC MICROCOMPUTER•

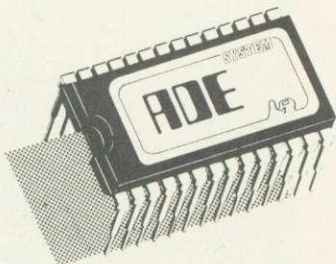

The complete program development package for assembly language programmers. ADE is the de facto industry standard for professional software writers using the BBC microcomputer. The 16k ROM contains a full 6502 MACRO assembler, a dynamic text editor, a front panel debugging monitor and disassembler. ADE comes complete with a 160 page comprehensive reference manual and a utility/macro library disc. ADE can also be used with tape based machines.

The ASSEMBLER features macros with library facilities; nestable conditional assembly; flexible listing options (with or without macro expansion); hex, decimal, binary and ASCII data formats; dummy section; full range of arithmetic and logical operators; symbol table sort and dump; file chaining and 29 powerful pseudo ops. Source and object files are kept on disc so there is no limit on program size or location.

The EDITOR is designed with the programmer in mind for writing both programs and documentation. The editor includes a very powerful command language (including macros) that enables much editing to be done on a semi-automatic basis. It features full screen editing and deferred edit modes; no limit to document size; edit with backup facilities and a versatile text formatter.

The DEBUGGER is instantly accessible for inspecting, modifying and disassembling machine code programs. Features include full 64 byte display in hex, ASCII and disassembled format; registers; stack; single step; breakpoints; memory search and much more.

Price £60 inc vat. Please specify 40 or 80T utility disc.

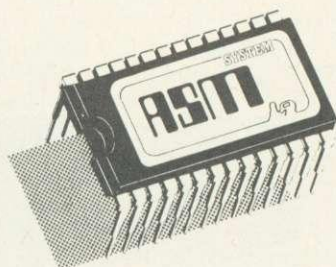

ASM provides all the superb features of the ADE macro assembler on its own ROM.

The program source file may be written using any editor (even Wordwise or View!). Complete with reference manual and utility/macro library disc. Use the assembler that professional software writers use.

Price £35 inc vat. Please specify 40 or 80T utility disc.

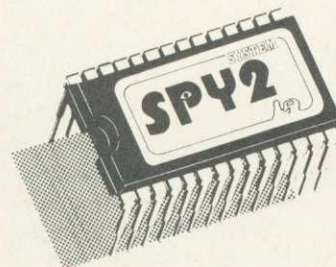

SPY2 is a front panel debugging monitor, disassembler and disc utility ROM. SPY2 is instantly accessible to the programmer for inspecting, modifying, debugging and disassembling machine code programs. SPY2 also features a relocater and program trace facilities. SPY2 will access any ROM either in the sideways ROM sockets or on an extension board. ROM memory may be displayed, single-stepped through or disassembled.

SPY2 includes a set of powerful disc recovery commands for interrogating, editing and retrieving data stored on a floppy disc. SPY2 also includes a disc formatter as well as a non-destructive single track reformatter.

In all SPY2 has a comprehensive set of 23 utility commands. These are supported by an excellent Reference Manual.

The SPY2 front panel encompasses all the superb, easy-to-use facilities of the renowned SPY debugging monitor PLUS additional commands for toggling and finding breakpoints; relocating machine code programs; single stepping through subroutines in one go and facilities for accessing the front panel from programs in RAM or ROM with breakpoints, OSBYTE or CTR-F.

SPY2 features a versatile disassembler with hex dump, full and intelligent disassembly. This identifies data areas in the program; these being displayed as a hex/ASCII dump. Operating system calls are labelled creating very readable code. The powerful trace facilities enable program instructions and register contents to be traced to printer whilst the program is running. Indispensable for graphics programs as they can be stepped through whilst observing the effects on the screen.

SPY2 features a disc sector editor displaying the contents of a whole sector; disc search facilities for finding byte patterns or strings and free disc space. Files may be recovered by creating a directory entry with all the data concerning the deleted file. Directory entries can be easily amended using the *AMEND command. The *FORMAT command formats discs with any number of tracks. A verify command checks discs. The *REFORMAT command is extremely useful for recovering information from a bad track, reformatting it and restoring the data. Commands are included for loading files at \$1900 and automatically downloading (and running) them.

The most comprehensive of all debugging/disc utility ROMs.

Price £30 inc vat.

SYSTEM

Dept. A 12 Collegiate Crescent, Sheffield S10 2BA



For little Acorns Mighty SHARDS Grow

SHARDS

Software

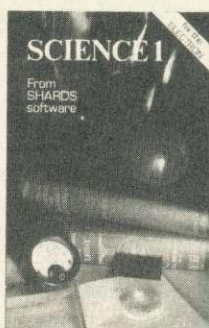
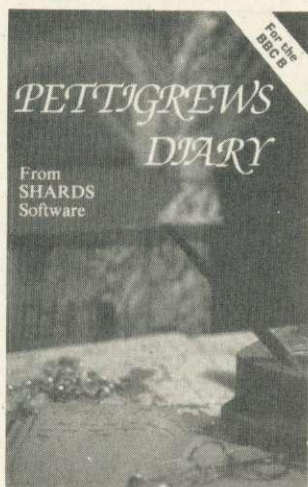

If you want well written and presented software for your Acorn computer then take a look at Shards. Shards can offer you entertainment and educational software that really is a cut above the rest.

Take a look at Shards.

Adventure and Strategy Games

Pettigrews Diary – A massive 90K graphic/text adventure with a difference. Can you solve it? (BBC & Electron)

"Complete original and highly intriguing ... (it will give your grey matter a thorough workout)". *Your Computer* £7.95

Empire – A superb graphic strategy game against the computer. 8 levels of difficulty. Played on a world map. Win at level 7 or 8 and you deserve a pat on the back! (BBC & Electron) £6.95

"I thoroughly enjoyed this game ... graphics are excellent (100% rating)". *Home Computing Weekly*

Mystery of the Java Star – A graphic adventure for all the family. Utilises 100K of memory. Gripping stuff! (BBC & Electron) £7.95

"Exceptional value for money ... well done Shards (100% rating)". *Home Computing Weekly* (BBC & Electron) £7.95

Educational

Fun to Learn, the definitive educational series – written by teachers and used in schools nationwide. All programs are menu based and make superb use of graphics. 100% user friendly and error trapped.

"This is how educational software should be written..."

Fun to Learn – A comprehensive program for 6-12 year olds.

"This is how educational software should be written". *Home Computing Weekly*

Monster Maths – Helps develop basic maths and logical skills for 6-14 year olds.

"A sound program that will maintain children's attention, for £6.95 it's cheap too". *Educational Computing*

Laser Letters – Educational word games for 6 year olds to teenagers. Three separate 500 word vocabularies. (BBC)

"You get a lot for your money ...". *Educational Computing*

Frac Attack – Fun with fractions for 8-14 year olds.

"A real winner ... lots of colourful screen action". *Popular Computing Weekly*

Science 1 – Science education for 11-16 year olds. Covers the use of lenses, meters, thermometers and balances.

Super graphics. (BBC & Electron) £6.95

"For fundamentals of balances, meters or lenses, this program is a must". *Popular Computing Weekly*

Selected titles available at larger branches of Boots and W. H. Smith and all good stockists or by sending a cheque/P.O. direct to us

at: Suite G, Roycraft House, Linton Road, Barking, Essex. Tel: 01-591 7666 (4 lines)

Home Computing Weekly

(BBC)

£6.95

(BBC)

£6.95

(BBC)

£6.95

(BBC)

£6.95

(BBC & Electron)

£6.95

Please send me a copy of:- (please tick)

Pettigrews Diary Fun to Learn

Empire Monster Maths

Mystery of Java Star Laser Letters

Science 1 Frac Attack

Please indicate which version required:-

BBC B Acorn Electron

To (Name)

(Address)

Please debit my Access/Visa account.

A/C No.

I enclose a cheque/P.O. remittance for £

(Signed)

All cheques/P.O. to be made payable to
Shards Software

* All orders despatched within 24 hours of receipt.

COULD DO BETTER

Despite the government's micros scheme progress is patchy in primary schools, argues Geoff Nairn

IN A BLAZE of publicity Prime Minister Margaret Thatcher announced the Micros in Primary Schools Scheme in July 1982. By the end of this year every primary school in the country should have a microcomputer, which should be making a valuable contribution to all areas of the primary curriculum. Well, that's the theory. With just three months to go, it's worth examining how successful the scheme has been to date and whether the Government is on target.

Under the scheme, a school can buy a single micro for half price, with the Department of Trade and Industry footing the rest of the bill. The machine has to be British, hence the choice of a Sinclair Spectrum, a Research Machines 480Z or the BBC model B. To date 20,000 of the 27,000 primary schools in England and Wales have taken up the offer, and 80 per cent of these have plumped for the Beeb. The Electron arrived too late for the scheme.

As a comparison, the earlier Micros in Schools scheme for secondary schools boasted a take-up figure of 100 per cent when it closed in 1983. In fact their pound-for-pound subsidy has been extended so secondary schools can upgrade their Beeb with a disc and Econet interface, and buy both a Walters dot-matrix printer and a Microvitec monitor – all British makes again. For the more ambitious schools, a BBC Buggy and a Vela instrumentation kit can also be bought for half price.

For the primary school the situation is rather different. Once you've bought your Beeb, apart from a monitor and cassette recorder, that's your lot. No follow up scheme is planned – in the words of Kenneth Baker, the Minister



One computer per school is unlikely to make much impact but it is all government funding allows. For extra machines, school must rely on their LEA or on parents

for Information Technology: 'The DTI is yet to decide whether further schemes of support are necessary.' If no further support is forthcoming, then it is difficult not to see the primary scheme as anything more than political propaganda.

That may seem a rather harsh view, but one solitary micro in a school of 350 children is unlikely to make much impact, especially if precious time has to be wasted loading programs in on cassette. Just from talking to teachers around the country, the one thing they really want is a disc drive. And although some local education authorities (LEAs) have set up their own disc drive subsidy schemes – Nottinghamshire and Walsall for example – there is clearly a case for a nationwide initiative. The one argument that there are no British drives available no longer applies, for a company, Dual Track Technology, now make such a thing.

The Department of Education and Science (DES) oversees the primary scheme through the Microelectronics Education Programme (MEP). The MEP, to quote the blurb, 'aims to help schools to prepare children for a life in society where computers are commonplace.' But the MEP has less than two years to finish the job; the group is due to be wound up in March 1986. Of

course, the MEP sees itself very much in a 'pump-priming' role, the idea being to provide the initial hardware, software and training, and after that the LEAs should take over. The trouble with that argument is that different LEAs have different priorities: the much-publicised 'league table' of LEA spending shows that on something as mundane as textbooks the 'top' authority spends six times as much per pupil as the one at the 'bottom'. It is difficult to make a case for more computers if the schools in your county do not have enough money for textbooks. With the current financial restraints facing all LEAs, what may seem like pump-priming to Sir Keith Joseph to others can seem like an abdication of responsibility.

In fact, this theme of self-reliance and 'hoping' that LEAs take up the challenge seems to permeate the whole primary scheme. With training, for example, the DES makes it a requirement of the subsidy scheme that two teachers go on a two-day course on using their micro. In two days, a teacher who has never used a computer before can just about get the hang of operating the Beeb – plugging it in, using the cassette recorder etc. To expect that teacher to then start using the computer in a challenging way, or



Kenneth Baker: 'DTI yet to decide on further schemes'

THE OLYMPIA RANGE OF DAISYWHEEL PRINTERS

A RANGE OF DAISYWHEEL PRINTERS DESIGNED BY OFFICE EQUIPMENT LEADERS

OLYMPIA INTERNATIONAL

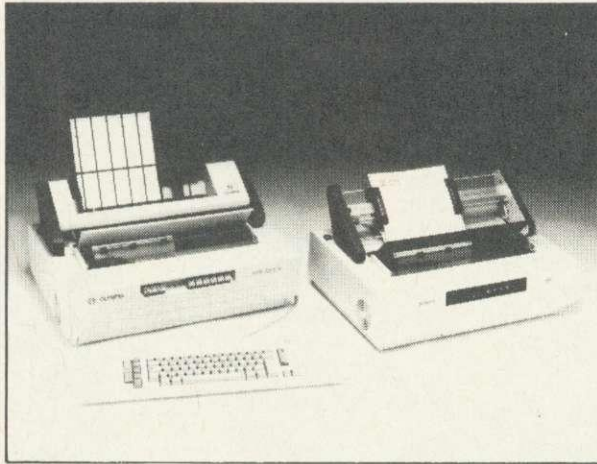

OLYMPIA 3000 SERIES

Method of printing: Dypewheel interchangeable 100 characters.

Print speed: 50 cps maximum. (40 cps Shannon)

Form width: 17" **Width of printline:** 15".

Tabulation: Variable, 60 positions/inch (optional 120) bi-directional, horizontal tabulation direct to column address, halfspace forward.

Pitch: 10, 12, 15 characters per inch and proportional spacing.

Line length: 150 characters with 10 pitch. 180 characters with 12 pitch. 225 characters with 15 pitch.

Method of printing: Automatic bi-directional printing with shortest path seeking logic. Automatically skips over blank fields.

Paper feed: Variable, 96 positions/inch, bi-directional.

Buffer: 4 K Buffer. Keyboard option. Qume/Diablo. Code option.

Function control led: ON/OFF-Line. Paper out. Ribbon out.

Cover open. Error.

Printing mode: Bold printing (1/120"). Expanded printing. Double strike.

Interface: RS232 IEEE, Centronics.

OLYMPIA 103 SERIES

Method of printing:

Dypewheel, exchangeable, 96 characters

Print speed: 17 characters per second, Bidirectional.

Form width: 17" (431.8mm)

Width of printline: 14.2" (360.6mm)

Tabulation: Variable, 60 positions/inch, Bidirectional

Pitch: 10, 12, 15 characters/inch proportional spacing

Line length:

141 characters with 10 pitch

169 characters with 12 pitch

212 characters with 15 pitch

Paper feed: Variable, 96 positions/inch, Bidirectional, indexing one half space up/down.

Printing: Automatic bold, (1/120"), expand and double print. Automatic

bidirectional printing with shortest path seeking.

Automatically skips over blank fields.

Buffer: 4 k byte.

Keyboard option. Qume control code. Option for Wordstar.

Function controls led:

102 ON/OFF-Line. Error.

103 ON/OFF-Line. Error.

Bold print.

Expand print. Double print.

Interfaces: RS232, Centronics IEEE.

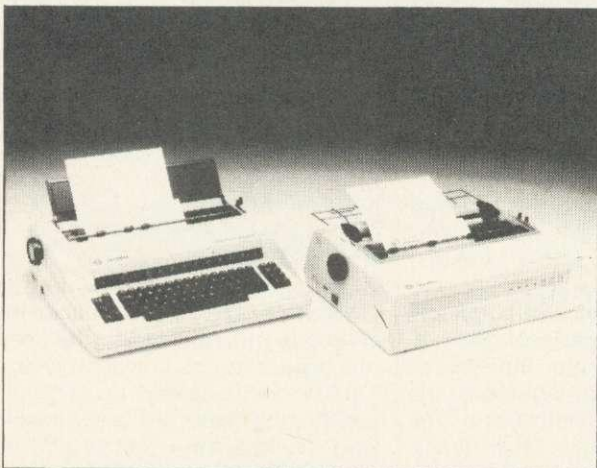
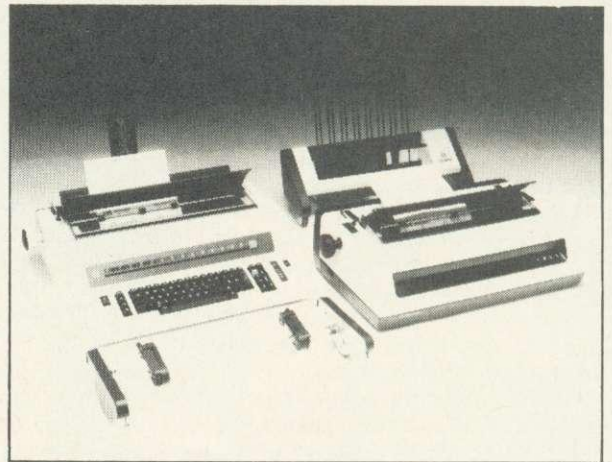

OLYMPIA COMPACT SERIES

Method of Printing: Daisywheel 100 characters. Interchangeable.

Print Speed: 14 cps

Form Width: 14.3" **Width of Printing:** 11.5"

Pitch: 10, 12, 15 characters per inch.

Line length: 10 pitch - 115 char. 12 pitch - 138 char. 15 pitch - 172 char.

Instruction code: Diablo compatible (compact R0)

Built in Tractorfeed - Compact R0

Built in Keyboard - Compact 2.

RS232 or Centronics Interface (Compact 2)

Both interfaces as standard (Compact R0)

ACCESSORIES

Olympia Single Bin Sheet Feed £398. Double Bin Sheetfeed £598.

Olympia Tractor Feed £150. (All Prices exclude VAT)

A full range of Daisywheels and ribbon types are available.

Distributor: Intelligent 43B Wood Street, Stratford upon Avon, Warwickshire CV37.
Interfaces Tel. 0789 296879 London 01-311 7981 TL. 312242.

even to pass on precious knowledge to other teachers, is a mite ambitious. Many education authorities do go beyond this minimum level and set up excellent in-service training courses – Walsall, for example, runs 25 different computing courses for teachers. But many do not.

One criticism levelled at the MEP by the NUT (the teachers' union) especially is that they have tended to concentrate on developing software rather than training courses. There is little point in producing educational software if there aren't the teachers who know how to use it, says the NUT. To meet such criticism, the MEP set up a small primary project team in September 1983, to assess the needs of primary schools in both teacher training and resources. They still don't actually train teachers though, rather they train computing advisors who then go out into the regions and train the teachers.

On the question of training, you would naturally imagine that the colleges of education, who after all are responsible for training tomorrow's teachers, would be at the forefront in this area. Again, a few colleges do run courses in educational computing for all their potential teachers, but sad to say they are the exception rather than the rule. Two primary school teachers I talked to, who had both graduated within the last two years, emphasised this point. One said that computers had not figured on the syllabus of her college at all, while for the other his computing experience was confined to one afternoon's demonstration of arcade-type games.

And so we come to the all-important software. In 1982, when the scheme first started, BBC micros were a bit thin on the ground, as was educational software to run on them. The MEP helped to spawn several software groups such as Netherall, Five Ways, the Chelsea Science Project and ITMA who did – and still do – come up with some sound educational software, although most of it is for secondary school subjects. Since that time a variety of software houses have started producing Beeb software for primary schools. Now, the problem is not one of a lack of software, but rather how does a teacher find out what's available and whether it's any good? Still worse, where does the money come from to buy software – educational software invariably costs more than the average 'arcade' game.

Talking of software, the MEP is the body responsible for the Microprimer pack, which comes with every Beeb bought under the DTI subsidy scheme. It aims to be an introductory 'self study' course for teachers, so that they can at least get started using the Beeb in their



There's plenty of educational software available now but most is for secondary schools. Educational programs cost more than 'arcade' games and there's no government money to buy software

classroom. Unfortunately it is often the only software a school has – apart from the Beeb's Welcome tape that is. As the MEP is the first to admit, the Microprimer pack was developed in a hurry and to meet a specific need. It would be a shame if teachers judged all primary software on the basis of one package.

Is the primary scheme a success? Well, I do not doubt that by the end of this year pretty well every primary school will have its very own micro – and most of them will be Beebs. Quite a few will be locked away in store cupboards because no one in the school knows how to use them. On the other hand others will be in use every day, with children of all ages and abilities

feverishly tapping away. And a good few more will be wheeled out on Friday afternoons for the 'computer lesson', which consists of teacher typing and children watching.

And so, what for the future? Number one priority: every teacher should at least know how to use their Beeb. A disc drive would be nice as well. Oh, and a few more Beebs wouldn't go amiss. A tall order? Not if the Government is serious in preparing children for the future. As a spokesperson for the DES said, 'It's very easy to criticise the scheme, but no other country has done anything similar.' It's also very easy to be complacent and make political capital.

GSL Computers

More Hard Disk Developments for BBC Micro

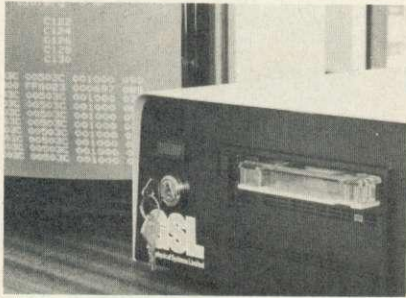

Hard Disk Drives

Range from 5 – 232 MBytes
5 MBytes removable cartridge drives

Tape Streamer

Efficient backup of Winchester units (standard tape backup of 45 MBytes in 9 mins.).

WFS

Comprehensive Winchester filing system Rom – stand alone use.

Networking

Amcom's E-Net provides a simple to use, yet flexible system for linking up to 255 BBC microsto a Winchester file server.

* Large Capacity Winchester Drives

* Removable Cartridge

* Tape Streamer Backup

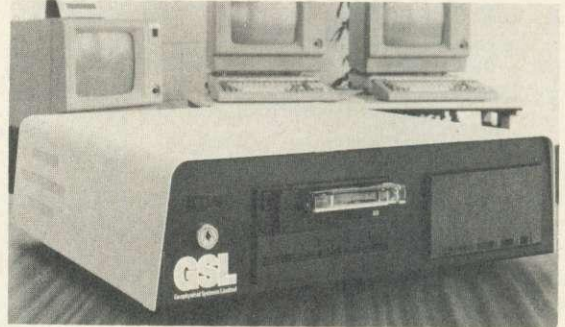

GSL Hard Disk Systems have been well proven in educational, factory and office environments, for stand alone or networking applications.

Other GSL products include:-

Printer Buffer
LCD Display
Floppy Disk Drives
Monitors
Printers

(We are also an Acorn dealer).

For further information on any of our products contact:-
Lea Wyatt at
GSCL



Geophysical Systems Computers Limited

West Portway, Andover,
Hampshire SP10 3SG.
Tel: (0264) 59633
Telex: 47166 GSLG.

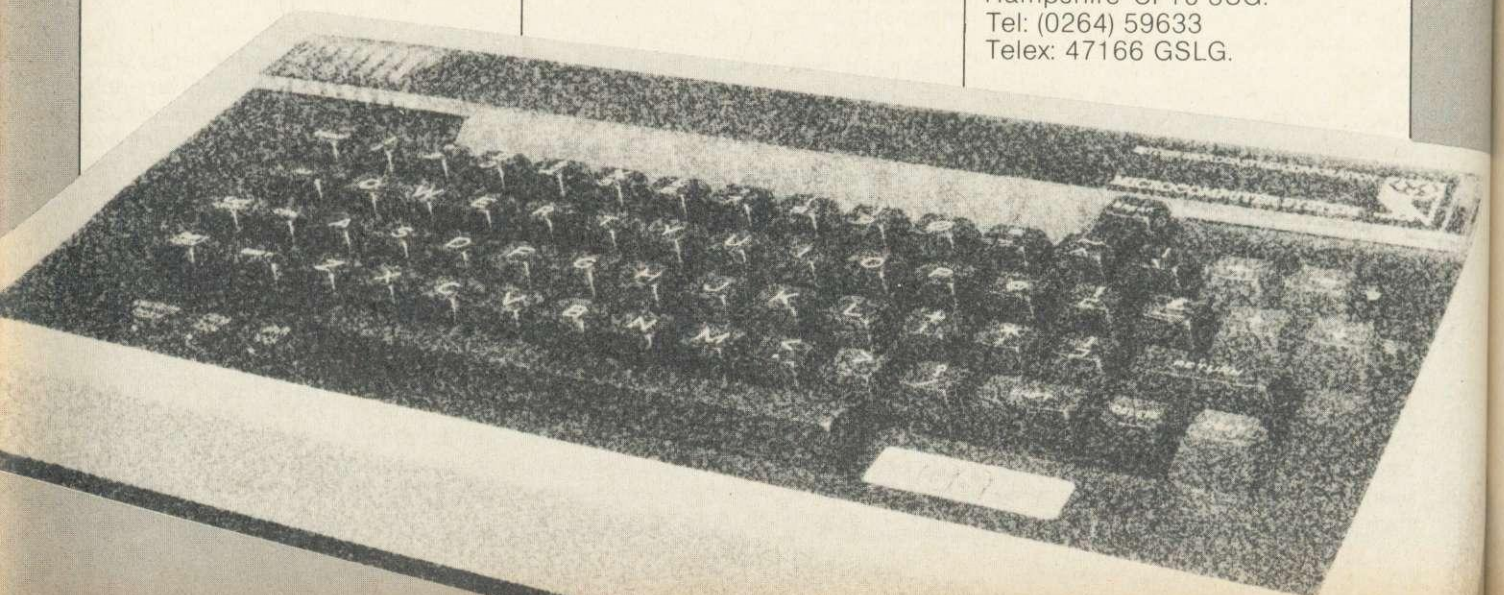

FRAMING THE ? ? RIGHT QUESTIONS ?

Ian Birnbaum reviews Acornsoft's Microtext system,
a powerful aid in programming instructional modules

137

MICROTEXT is an authoring system. It was designed by the National Physical Laboratory, implemented on the BBC micro by Ariadne Software, and is published by Acornsoft in cassette and disc form. My comments are based on the disc version.

An authoring language aims to allow the programmer to implement training and instructional programs easily and efficiently by providing special facilities for dealing with common situations. For example, scanning a student's answer for one or more keywords and then branching if they are present is complicated in Basic, but easy in an authoring language. Indeed, Microtext claims to be so easy to use that, for some cases at least, the designer and encoder of the module need only have a cursory knowledge of programming.

Microtext has its origins in a computer system called Mickie, a medical interviewing computer, developed in the 1970s. It used a language called Questext which allowed doctors to set up modules without extensive programming knowledge. Questext was extended to cater for more varied training on (non-micro) computers, and became Edutext. However, Edutext in Basic was slow and bulky, so it was rewritten in assembly language and implemented on micros; this is Microtext.

Advantages

The easiest way to describe Microtext is by considering the advantages it offers over Basic. This gives the correct context because the system stands or falls on its ease of use for the purpose of creating instructional programs.

There are many advantages to the system in this respect. First, Microtext is **frame-oriented**, ie the essential unit is a screenful of information, a frame. In this sense it is very like viewdata systems. However, it is more sophisticated in that control information is part of the frame itself. It therefore combines the ease of use of viewdata with

the flexibility of a programming language.

In Basic, the relationship between a screenful of information and the instructions required to produce that frame and to branch to another is exceedingly opaque. The programmer has to project from language to screen to provide the link: Basic offers no real assistance in itself. As a consequence, debugging by frame – the natural approach – is not easy. In Microtext, it is simple because the programmer creates one frame at a time by placing characters on the screen in the position they are to appear when the program is executed. In the frame, control information is included that instructs the computer which frames to branch to next and on what criteria.

Microtext allows simple **debugging** as it is simple to switch from running or testing to editing a module. If the frame layout is not correct, or an unexpected branch is made, pressing the escape key followed by S (for Stop) switches to a full-screen editor. The system offers single-stepping through the frames if required.

When most instructional programs are run – in Basic or any other language – errors that occur are usually observed at the frame level or at the link between frames. In Basic, this does not assist debugging, but in Microtext the link is absolutely clear, so errors are easily remedied.

Microtext offers exceptional facilities for accepting **user responses**. The programmer can specify whether spaces are to be ignored between words; whether an exact match is required or whether a response should contain, begin with, or end with a set of characters. The programmer can combine separate criteria using 'or', 'not' and 'and' (ordered or unordered) to produce complex branching decisions. Both textual and non-textual data are supported, and with the latter numeric-range tests are available (eg, less than and greater than).

There is no need to compare these

facilities with Basic: there is no contest!

A programmer can **design a form** on the screen with headings, and when the frame is run the cursor will move from heading to heading as the user responds. In this way complicated forms can be set up with minimum trouble.

Microtext allows a **complete summary** of the user's responses to be created. In instructional programs, it is very useful to store these for later analysis. This might be used to give the student or teacher a record of achievement, or to record in variables information required for future modules (a module is a collection of frames, all loaded into memory at one time, which constitute the file being run). Microtext implements both these approaches, the first simply, although the latter is rather more complicated.

In Basic none of these facilities is provided, and the programmer must save the relevant information, and generate appropriate screen displays.

If the user types **Help** (or even just ?) in Microtext when responding to a prompt, the system automatically branches to a help routine, if one exists. Typically, the first help frame will be a menu with a variety of choices (eg, start again; get help on this topic or on this question). Each frame can contain a different destination frame if required: this is achieved by putting HELP followed by the frame required.

In Basic, it is possible to create a similar system by using a common input routine which always branches when Help is entered. However, this is by no means a trivial task.

There are two sorts of **variables** in Microtext: system variables and user-defined variables, ie reserved words which hold specific information. These

The Microtext system (including manual) costs £49.85 for the cassette version and £59.80 for the disc, available from Vector Marketing, Dennington Industrial Estate, Wellingborough, Northants NN8 2RL. Tel: 0933 79300. (Acornsoft is on 0223-316039).



MICROMAN Computers

ACORN SPECIALIST COMPUTER CENTRE

Z80 SECOND PROCESSOR

With the addition of the Z80 second processor the BBC becomes a business machine fully compatible with CP/M software. The Z80 comes complete with word processing, database, spreadsheet, graph plan and accounts programs as well as CIS COBOL, Nucleus System Generator, Z80 Professional Basic and GSX Graphics.

PRICE £299.00

TELETEXT RECEIVER

Converts your BBC into a Teletext Terminal giving normal reception of Teletext pages and enabling you to download a large range of free software.

PRICE £225.00

ACORN PRICES

Acorn Electron	199.00
Electron Plus 1 Interface	59.90
BBC Model B	399.00
BBC Model B + DFS	469.00
BBC Model B + Econet	446.00
BBC Model B + DFS + Econet	516.00
Acorn Teletext Receiver	225.00
Acorn Prestel	113.85
Acorn 6502 2nd Processor	199.00
Acorn Z80 2nd Processor	299.00
Acorn IEEE Interface	325.00
Bitstick	375.00
Econet System	P.O.A.
A-B Upgrades	95.00
DFS Upgrade	95.00
Econet Upgrade	70.00
Speech Synthesizer	55.00
View ROM	59.80
Viewsheet ROM	59.80
BCPL ROM	99.65

6502 SECOND PROCESSOR

The 6502 second processor will allow the BBC to run faster with greatly increased memory especially in high resolution graphics modes giving users more power when writing their own programs and access to a range of exciting new programs such as the programs that drive the Bitstick.

PRICE £199.00

BITSTICK

This superb menu driven graphics package allows high quality CAD at a very modest price allowing the user to create shapes on the screen and produce outstanding graphics, architects drawings etc.

PRICE £375.00

IEEE INTERFACE

A full implementation of the IEEE standard, providing computer control compatible scientific and technical equipment.

PRICE £325.00

ACORN APPROVED SERVICE CENTRE

Our workshop offers a comprehensive service including Repairs and Upgrades by our own engineers

EDUCATIONAL & INDUSTRIAL ENQUIRIES WELCOME

All prices include VAT, Post & Packing £9 (Large items) £1 (Small items ROM's etc)

RAINFORD INDUSTRIAL ESTATE, MILL LANE, RAINFORD, ST HELENS, MERSEYSIDE

PHONE 074488 5242

TO MICROMAN COMPUTERS, RAINFORD INDUSTRIAL ESTATE, MILL LANE, RAINFORD, ST HELENS, MERSEYSIDE WA11 8JL. Please send me a copy of your full price list and newsletter.

NAME
ADDRESS

NAME
ADDRESS

Datapen

BBC Lightpen Programs

Datapen

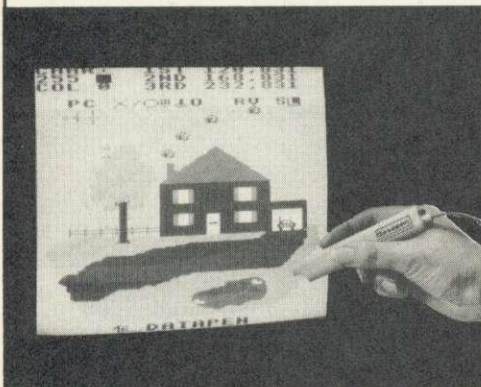

BEEB PEN DRAWING PROGRAM

A comprehensive Mode 2 colour drawing program allowing plot commands, painting, circles, text, character defining, saving and loading to tape or disc, all to be selected and used with the lightpen.

PRICE £11.95 Introductory Offer £9.95

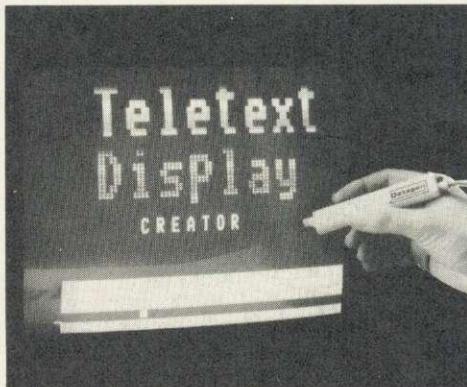

TELETEXT DISPLAY CREATOR/EDITOR

Allows the busy programmer to quickly create Mode 7 colour graphics and test screens for combination into his or her own programs. Movable on screen menu allows use of complete screen for graphics. Full instructions and a discussion on teletext features are provided.

PRICE £9.95 Introductory Offer £7.95

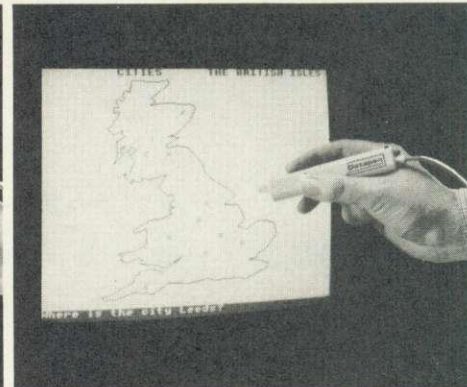

BRITAIN

The first in a series of educational Geography and Geology programs. Britain comes complete with three sets of tests, and these may be very easily changed by adding DATA statements in the Basic program. Full instructions and grid map supplied.

PRICE £6.95 Introductory Offer £5.95



SUPERIOR PERFORMANCE

- Insensitive to ambient lighting
- Responds to different colours
- Program accessible LED lamp readout
- Switch for program control

SUPERIOR PROGRAMS

- Tape storage of your work
 - Good documentation
 - User routines provided on tape and on printout

The Datapen Lightpen itself comes complete with handbook, software on tape including two drawing programs and a printed listing showing useful routines.

PRICE £25.00

Two drawing programs, SKETCH and SHAPE-CREATE are included with the lightpen and the programs shown above may be ordered additionally, or separately as required.

All prices above include VAT, postage and packing.

Please send your cheque/P.O. to:-

Dept. AU3, Datapen Microtechnology Ltd., Kingsclere Road, Overton, Hants. RG25 3JB

are ANS (holds the last answer given), TIME (contains the elapsed time since last initiated) and RANDOM (generates and holds a random number). User-defined variables are similar to Basic's, but it is not necessary to differentiate between string and numeric variables. The contents of a variable may be displayed by use of angled brackets; for example, if NAME contains the user's name, then:

```
Are you ready, <NAME> ?
```

will give a personalised question. Moreover, a list of variables can be created using something like =PLAYER <NUMBER>, where NUMBER is a variable incremented elsewhere, giving separate variables PLAYER 1, PLAYER 2 etc. This powerful feature is not available in Basic.

All * commands in the BBC's operating systems (and so all *FX commands)

between packages on the BBC micro and between machines. In the former case, a wordprocessor could be used to set up a frame: each frame is stored in ASCII (although text compression is used). In the latter case, it is important only to use graphics commands which exist in all systems (eg for Commodore systems there is no point using teletext colour and graphics).

Microtext contains **error checks** to ensure material is not overwritten. Thus, if you edit a module and then attempt to load another without saving the first, a message appears. A simple safeguard, but important.

Disadvantages

No system is perfect, and there are some disadvantages to Microtext when compared to Basic, but they by no means overshadow the advantages. Let us consider them briefly.

Microtext supports only integer arithmetic. This clearly presents some restrictions, which is a pity with, for example, maths.

Microtext is not structured. All control in a program is achieved via conditional or unconditional branches (ie the equivalent in Basic of GOTO, or IF...THEN statements. I don't regard this as a handicap because, as a frame-oriented system, the structure is already incorporated.

Memory is rather short with cassette and disc versions: about 14k and 11k left for mode 7 programs respectively. This leaves room, just, for a 30-frame module in the disc version and 40 frame with cassette (lots of variables will cut these down). On a disc version this is not problematic, since one module can call another.

The memory problem can be solved by a second processor or the ROM. These options are essential in a graphics mode: mode 4, for example, allows just six frames. Modes 0, 1 and 3 are impossible without the second processor or the ROM (modes 2 and 5 are never supported).

At present, the Microtext package is needed to run any module. However, a delivery system (without the editing facility) will be available which sits securely with the module and is loaded with it. This is produced by a publishing system, and will be very valuable for, say, education authorities that wish to produce packages in a resource centre for schools. Questions of copyright have yet to be fully resolved.

There is no simple access to the contents of the analogue port from Microtext, except by using *FX128 and getting the values of the X and Y registers. Nor is there access to a printer from within a module (ie no VDU2 or VDU3). The only access is at command level to

print copies of frames, or to dump the summary (these may be activated at RUN time by preceding them by \$). However, I'm sure someone will find a solution.

The COPY key is not available for normal use in edit mode; instead it

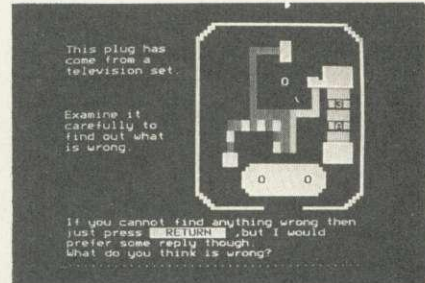

Figure 3. Pressing 'N' at figure 1 takes us to this, frame number 51. NB This is NOT the correct way to wire up a plug



Figure 4. This next frame is where the problems begin with free range of response. NB This is NOT the correct way to wire up a plug

pushes a space into a line and moves the rest of the text to the right by one character without wrap-around. This is a pity, especially when one considers the eighth disadvantage—there is no teletext graphics editor. This makes creation of double-height characters tricky, and mode 7 graphics laborious. All teletext control codes need two function key presses to make them active (in other modes these produce foreign characters eg ê): this is also tedious. However, inclusion of a full teletext graphics editor would have left less space for modules. There are two solutions: use a graphics editor on a chip which can be used via a * command, or a separate package to create a frame and then load it in ASCII into Microtext. However, to do this it will be necessary to incorporate it within the existing module in some way, because Microtext does not allow subsets of modules to be loaded. Again, someone is bound to find a way round this.

Microtext in use

Microtext comes with a 120-page manual, a reference card and a demonstration package. The manual is comprehensive, though not that easy for beginners. I think Microtext is accessible to newcomers, but I suspect a



Figure 1. Student's view of first frame in example module testing knowledge of plug wiring

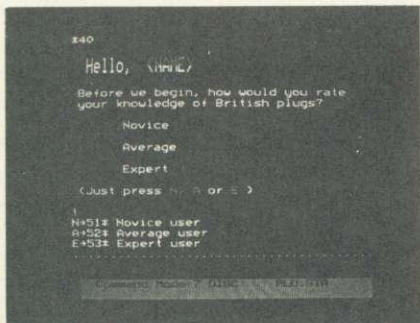

Figure 2. The whole of the first frame showing the hidden commands and branching to further frames

and some VDU commands (including sound and graphics) are available directly within Microtext. (Although not documented, the cursor can be turned off and on with \$CH1,0,0,0,0,0,0,0 and \$CH1,1,0,0,0,0,0,0 respectively.)

Microtext offers easy control of input/output at the **user port**. The programmer can set a specific line high or low, or wait for the line to go high or low; particularly useful for slide and video control.

Microtext modules (eg, a self-contained lesson) are **portable** both

New available now!

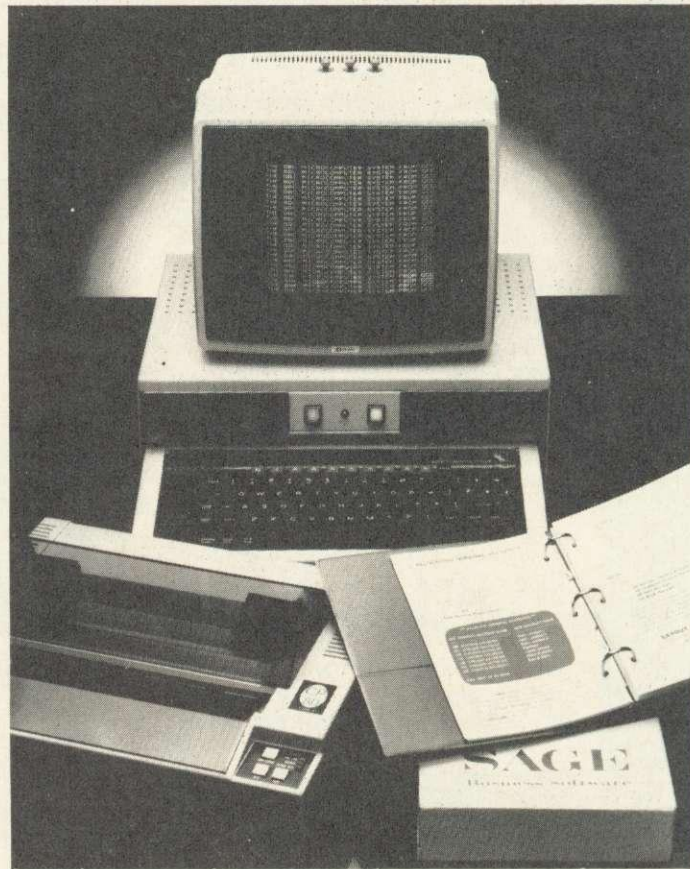

Z80 second processor for
BBC Microcomputer with
SAGE integrated
accounts program

£375

+ VAT

Trade and local authority enquiries welcome
Prices correct at time of going to press.



GCC (Cambridge) Limited
66 High Street, Sawston, Cambridge CB2 4BG
Telephone: Cambridge (0223) 835330/834641
Telex: 81594 SAWCOM

course may be necessary to help them.

As an example of Microtext in use, let us look at the PLU.STA module supplied which tests the student's knowledge of 13 amp plug wiring. It is an interesting attempt to allow a very free range of response, and I think it almost succeeds.

The module is loaded from Microtext by typing RUN PLU.STA. After the title, the student's name is asked, and he/she is then asked to rate their knowledge of plugs (figure 1). Let us see what set of program instructions produce this page. We press Escape and then S (for Stop) - we get figure 2. The ! indicates that only a single key press (with no carriage return) is allowed. On pressing N, the program will continue from frame 51, and the statement 'Novice user' will be saved to the summary; similarly for A or E. If any other letter is pressed, the statement 'Not understood - try again' is displayed in red. We could generate our own response on another frame (say on frame 55) by putting →55 at the end. Notice finally the use of <NAME> to display the contents of the variable NAME (in this case IAN).

Frame 51 sets up appropriate text, initialises a variable which limits the number of wrong answers allowed, and then, after a few prompts, directs the student to a picture of the plug with a question (figure 3). Typing 'earth wrong' produces the response 'I would like a more specific answer. Precisely what is wrong?' If, on the other hand I type 'Wires crossed' I get 'Yes, two of the wires have been crossed but I would like to know which ones. Which wires have been crossed?'. If, now, I type 'Earth and neutral' I am judged correct. This is a nice sequence, and easily implemented.

We continue now to plug B (figure 4). I type '3 amp too small' and get the response 'It seems that you don't know what is wrong with the plug...'. If instead I type 'Fuse too small' I get 'What is wrong with the fuse?'. But if I had put 'Fuse wrong' as my answer, it would have marked it correct and said 'Well done'. Clearly there is something wrong! Let's edit the program.

The relevant frame for our purpose is 210 (figure 5). This says that any combination of the word fuse and one or more of blown, low or wrong are accepted as correct: the word fuse with any other words goes to a prompt at frame 270; otherwise we are told we are not correct and allowed to try again. (Incidentally, the system does not differentiate between upper and lower case.)

We shall change the first line to:

```
(< FUSE >) & BLOWN/LOW/SMALL/  
13 AMP > 280
```

and the second to

```
< FUSE > > 270
```

At *210 we define the variable FUSE by (FUSE = "FUSE/3 AMP").

This solves our problems, and also allows 'Fuse should be 13 amp' and similar answers. Moreover, it treats 'Fuse is wrong' as only partly right and responds with 'What is wrong with the fuse?'. Notice, finally, that Microtext will treat both 3 amp and 3amp as the same.

We see from this how easy it is to edit, but we haven't perfected the program. We need to edit other frames to be consistent with the changes we've made, and more crucially, we still

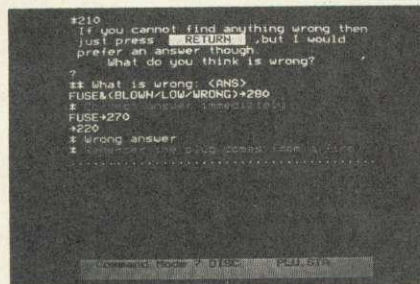

Figure 5. Looking behind the scenes shows responses that are allowed, and the prompts given

haven't caught all the right answers. The moral from this is that even the simplest module that uses free format responses will need considerable testing and editing.

Microtext makes editing easy, but there is no substitute for careful educational design and thorough testing: indeed, the powerful facilities of Microtext make this even more important.

In this example, we have been examining the program in RUN mode. When editing, we momentarily entered COMMAND mode and directed the system into EDIT mode. Then back through COMMAND mode to RUN mode again. This process is adequate for testing and debugging, but Microtext provides one further mode precisely for testing: TEST mode. Without too much detail the essential differences are that it is more difficult in TEST to delete or overwrite an edited module without saving it, also the Escape key always fully interrupts a program.

Most of the other facilities are available in RUN or COMMAND modes, though some are slightly more convenient to use in TEST mode. It may seem then that TEST adds virtually nothing new, but this is not so. Most programs will consist of a whole series of modules and it will often happen that one module will call another. When

testing a system, we don't want to lose our edited module in this way - hence the need for TEST.

On balance, the introductory package of modules is well-thought-out and reasonably varied. The average user will gain much from working through the modules, examining how they were programmed and - most importantly - altering the modules as we have done here.

Educational implications

Used with the right application, Microtext is very valuable. I believe it is possible to teach relative beginners how to program with the system, thus opening the way to program designers implementing their own code. However, more advanced uses (eg, creative uses of variables) and the implementation of complex teletext screens will require a more professional approach. There is no doubt, though, that the use of Microtext will make the professional programmer far more efficient, given the right application.

The great danger with Microtext, however, is that its very ease of use will encourage teachers and LEAs to program with it, and thus restrict the types of program available. Microtext can only be used to implement programs which are susceptible to frame-by-frame analysis. This is a wider range, certainly, than straightforward instructional and training packages - for example, adventure games are possible, although there would be severe memory constraints - but it is a distinct subset of educational software. Packages that use animation will not be viable, as far as I can tell; and, of course, no more than four colours will be available; moreover, as we have seen, only integer arithmetic is possible. And, more generally, not all educational design intentions can be accommodated by a frame-oriented language.

However, this said, Microtext clearly points the way, and with Microtext Plus on the horizon, which should allow floating point arithmetic, a full interactive graphics editor and some expert system techniques incorporating generative rules, I think we will see the decline of Basic as a language for computer-assisted material in education and training.

Microtext is a superb technical achievement for a 32k machine, and I look forward to seeing what creative educators can do with it. I regard it as a tremendously important development, and quite possibly the shape of things to come in the construction of instructional and training packages, especially in conjunction with video disc technology.

HIGH QUALITY COMPUTER DESKS AT HIGHLY COMPETITIVE PRICES.

THE ORGANISER DESK.

- Top shelf for monitor/printer.
- Large desk top area.
- Lower shelf for paper/book storage.
- Teak finish • On castors.
- Self assembly.
- Ample room in front of the shelf for you to sit comfortably.
- Assembled Dimensions: H.31" W.40¼" D.26"



Only **£59.95.**



THE APOLLO RANGE OF BUSINESS DESKS.

- 10 models available to suit leading computer systems. • Immediate delivery.
- Sturdy steel underframes.
- Scratch resistant surfaces.
- Lockable castors. • Prices from **£100.**

All are on display in our showroom and are available from us or dealers throughout the U.K. All prices include VAT and delivery.

For further details contact us at:

158 Camberwell Road, London SE5 0EE. Telephone: 01-701 8668.

Opus.
Opus Supplies Ltd

Draw with the BBC micro and show the true potential of your machine

Fill shapes in one of 23 colours (Mode I)
 Draw points, lines, rectangles ellipses and circles
 Smooth curves
 Wire frame diagrams
 Hidden line removal
 Draw in perspective
 Measure scaled distances
 Ekta sketch lines, Half tone facility
 Mirror images
 Repeat images, SS, enlarged, reduced, stretched
 Actual colour displayed
 Store up to 10 ellipses or circles in memory
 Redraw any one of these at cursor position
 Change any actual colour for one of 8 others
 Clear screen, load screen, save screen
 Print characters or numbers at any pixel point
 Error messages for incorrect input
 Fully comprehensive manual

356 496 • □ •••

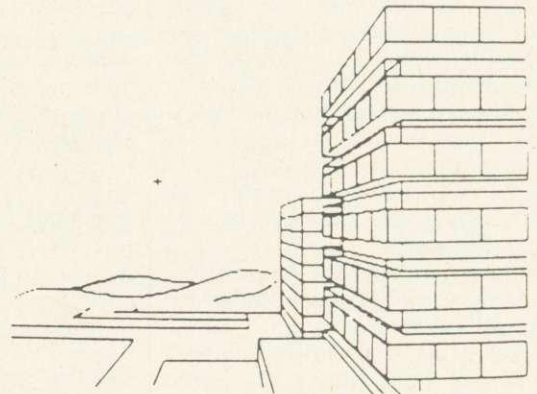

This programme has been purpose designed by professional Graphic Designers for simplicity and ease of use, and is undoubtedly the most versatile drawing programme on the market at this time. There is no need to input any numerical data, as all judgements are made visually. The BBC Micro is the finest drawing machine in its price range. Find out what it can do.

The A. B. Designs drawing programme costs only £36 for over 70 functions (model B). New AB2 Program, available on disc (price £61) and cassette (price £51). When ordering send Cheque/PO and VAT at 15%. Please include phone no. with all correspondence. For further information send SAE and phone no. to A. B. Designs, 81 Sutton Common Road, Sutton, Surrey. 01.644 6643 (closed all day Thursday).

ATOMIC TEXT

Alex Wilson cures writer's cramp with 'Wordprint'

SELDOM is the inexperienced owner of a printer offered help in the manual that comes with the peripheral. It's no longer a matter of attaching a cable and off you go - there's a lot more to a printer than an electric typewriter. For a start, different type-styles are available at the press of a few keys. Yet working from the manual produced the following comment from one newcomer to printing: 'I eventually worked out how to use the printer in text mode from the single example of how to enter control codes given in the



Other controls can be sent directly with say, PRINT \$27\$61, which sets bit eight to 0, or as part of a string. For example, if a string is ABCDEF, sent to the printer as /27/53/A/B/C/27/52/D/E/27/87/1/F, then the first control sets standard ASCII, and ABC would be printed in normal print, the second control sets italics and DE would be in italics. The further control sets enlarged mode so that F will be enlarged italics. Note /N/ is to indicate that we are talking about a single byte number, not to be confused with 27 which would

Epson booklet.' Try the Star Gemini 10X booklet (reputed to be better written than previous ones)! It doesn't even have one example. Many users are therefore unlikely to get value from the machines they buy.

My program will, I hope, tender a guiding hand to frustrated beginners. *Wordprint* is a wordprocessor program written for domestic use on a 12k RAM Atom driving a Gemini 10X printer, and it should cause little trouble with a Beeb (the cable is the same as on an Atom) or an Epson (if George Hill is right about the control codes). It is offered for those who do not have the money to spend on a commercial word-processor.

So how do you get at all those extras you've paid for - italics, variable characters per inch, underlining, subscripts and so on? (Forget about screen dumps and downloading characters - time enough for them when you find out how to include the others in your programs.) Master the control codes first then it must be easier. These are shown as CHR\$(27) CHR\$(n) . . . , or ESC n . . . but how do you get them into your program? You can't stop and press Escape-this or that, so it's as well to understand what is required. Those

who already know can skip over the next few paragraphs.

The printer expects items in binary form from the computer. Some in ASCII will be numbers and some letters. Then there will be control codes, which will not be printed. The escape code is the most frequently needed and on receipt of a byte containing 27 the printer interprets this as a change of instruction.

The difficult codes are \$2 and \$3 or CHR\$(2) and CHR\$(3), as these enable and disable the printer, in particular \$27\$66\$2 and \$27\$66\$3, which set 12 characters per inch and 17 CPI.

Try entering

```
PRINT $2; PRINT $27$66$1; PRINT "HELLO";
```

Your printer should print HELLO as you expected it. Now change it to read PRINT \$27\$66\$2 and then \$27\$66\$3. In theory these ought to change the print to 12 and 17 characters per inch respectively. Instead it is probable that HELLO was printed out exactly as before and then nothing at all for the instruction with \$3 in it. These can be dealt with successfully by putting the value into A then applying LINK #FF10, for this enters the printer driver after the switch.

normally be sent and printed as 2 followed by 7, i.e. ASCII 50 and 55.

If you are unsure of this try

```
B = 2800; ?B = 27; B?1 = 66; B?2 = 3; I = 0; DO; A = B?1; LINK#FF10; I = I + 1; UNTIL I = 3; PRINT " HELLO";
```

This should get HELLO printed at 17 CPI. Alternatively, start a new program at #2900 with

```
10 REM31221;
```

This will list just as you typed it. Now type 10 REM and three spaces and return. Poke 0 into each of the spaces (#2906-#2908) and LIST. This will appear to be 10 REM and little else. Follow this with

```
?#2906 = 3; ?#2907 = 12;
```

These are Atom control codes. Listing will switch off output to the printer and will clear the screen. You have just done PRINT \$3 \$12. Alter the last 0 with ?#2908 = 21; then you have the equivalent of PRINT \$3\$12\$21 which also

page 146 ▶

The 'Wordprint' program is listed in the yellow pages section on pages 109-111

Put an end to inefficient, slow cassette tape storage



Speed your data access with a TEAC disk drive from Viglen

Comprehensive, fact-filled, 53 page manual including techniques of loading from cassette to disc. Not available elsewhere

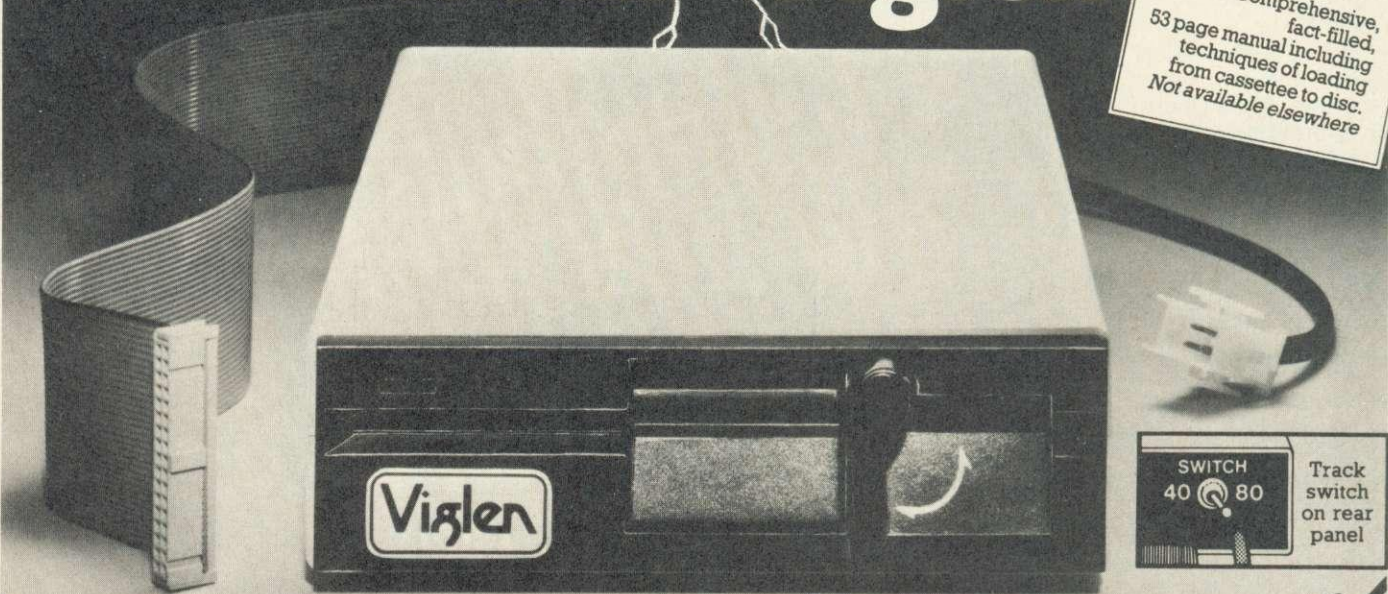

Replacing your cassette with a disk drive means data access in seconds! VIGLEN TEACS *unlike others* have been specially modified to operate successfully with ACORN and other filing systems, over coming RANDOM accessing problems normally experienced with these disk drives. Prices include VAT, Formatting Disk, User Manual, Case and Leads.

When ordering Dual Drives, please state which layout you prefer. A or B.



TEAC 55 Slimline Drives		DUAL DRIVES		Inc.	Excl.
SINGLE DRIVES	Inc.	Excl.	CASED	VAT	VAT
CASED	VAT	VAT	400 TRACK 200K	£240.00	£208.69
40 TRACK 100K	£119.00	£103.48	40/80 TRACK	£280.00	£243.48
40 TRACK 200K	£160.00	£139.13	SWITCHABLE 400K		
40/80 TRACK	£140.00	£121.74	40/80 TRACK	£378.00	£328.70
SWITCHABLE 200K			SWITCHABLE 800K		
40/80 TRACK	£189.00	£164.35	Integral power supply for dual drives	£45.00	£39.13
SWITCHABLE 400K	£25.00	£21.74	Power supply in dual case	£45.00	£39.13
Integral power supply for single drives	£25.00	£21.74			

All prices correct at time of going to press and all offers subject to availability.
 ● Utilities disk includes 13 useful utilities including: ● formatting ● verifying ● screen dump ● disassembler ● generating 62 files, etc.
 Please telephone 01-843 9903 for latest prices
 ● Orders welcomed from Educational Establishments and Government Departments.



Full Twelve Months Guarantee

How to order
By post: To purchase any of the items simply fill in the coupon with your requirements. Enclose your Cheque/P.O. or use your Access/Barclaycard. Please make cheques payable to: VIGLEN COMPUTER SUPPLIES and post to above address. Allow seven days for delivery and add £8.00 carriage, package and insurance on all items.
By telephone: Ring (01) 843 9903. Credit Card holders (Access/Barclaycard only) can purchase by telephone. Please give Card No., Name, Address and the items required.

Viglen

COMPUTER SUPPLIES

Unit 7 Trumplers Way
 Hanwell W7 2QA
 Tel: (01) 843 9903

EASY ON-THE-SPOT PARKING. AND IT'S FREE!

Post to: VIGLEN COMPUTER SUPPLIES UNIT 7, TRUMPERS WAY, HANWELL, W7 2QA

Please send me the following items:

I enclose Cheque/P.O. for £

I prefer to pay by ACCESS/BARCLAYCARD* . Card No.

Signature

Name

Address

Layout A or B*

Add £8 carriage. *Delete as necessary

AUTOH

Switchable 40/80 Track 200K Disk Drive & Acorn DFS



THE TEC DISK DRIVE

(AS USED BY CUMANA)

COMPLETE DISK SYSTEM FOR THE BBC MODEL B

• Package assumes you own a BBC Model B with switched mode power supply plus 1.2 operating system.

OFFER INCLUDES:

- Disk Interface (call at factory for free fitting)
- 200K 40/80 track single sided TEC FB502 Slimline Disk Drive including case and all leads
- User Guide
- Utilities Disk including formatting, verifying, BASIC program comparator, disassembler, Epson screen dump, dual catalogue (giving 62 files), large printing and others

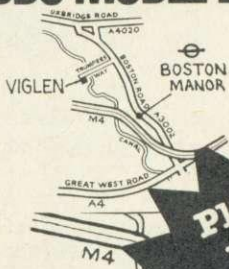

Please Ring 01-843 9903 for LATEST PRICES

SWITCHABLE DISK DRIVE & ACORN INTERFACE
£239
INC VAT

Viglen
COMPUTER SUPPLIES
Unit 7 Trumplers Way
Hanwell W7 2QA
Telephone: (01) 843 9903
AMPLE ON-THE-SPOT
CAR PARKING -
AND IT'S FREE!

Prices correct at time of going to press - offer subject to availability

Post to: VIGLEN COMPUTER SUPPLIES UNIT 7, TRUMPERS WAY, HANWELL, W7 2QA

Please send me _____ (Qty) TEC 200K + DFS

I enclose Cheque/P.O. for £ _____ made out to VIGLEN COMPUTER SUPPLIES (please add £8 for carriage)

I prefer to pay ACCESS/BARCLAYCARD Card No. _____

(Delete whichever not applicable)

Signature _____

Name _____

Address _____

YES

Order only when you have a card in the name of our bank. Please show this on your order.

AUTO2

switches off the screen. Compare this with the results from the first REM, and you have the difference between printing a number and a control code.

To show this in a working program is the best way to make the point. Written in Basic, *Wordprint* is slow in parts but more understandable than assembler. It is a restricted wordprocessor that uses #2800 as working storage and #2900 for the program. It stores the text from #8200, in the graphic space. It is not excessively user-friendly so an explanation of the program as well as the controls is needed to make it accessible. A sheet of instruction was originally written as an aide-memoire for the program and this is included below. With the exception of lines 27, 28 and 44, which were taken from *Atomic Theory and Practice*, the program is original material.

Starting with the printer controls, these are in lines 91-126, 456-458, 470-478 and odd lines between 300 and 440. Several control characters can be embedded in the text and these are searched for in lines 456-458. Lines 91-126 are combined with these to insert the controls into the string B(\$B), using X as the index. \$B has the code 27 entered in the first lines and has the rest dealt with in 91-126. (These line numbers are taken from the ASCII values of the embedded control characters.) After this B is free for further text input. The codes are to set up italics, underline, enlarged, super and subscript and to cancel them.

The routine at line 470 is entered every time a print request is made so that it is immaterial if the printer is switched off in the meantime. A routine such as this is needed in any program that requires printed output, to initialise the printer and to set some print style. It starts by putting the printer 'on line' with PRINT \$17, and follows by initialising it, PRINT \$27\$64. If a headed address is wanted, T takes a value near the right-hand side and inserts it in the tab instruction PRINT \$27\$68\$(T)\$0 as the only tab. The default is that tabs are set at 10, 20 and so on up to 60.

Line 472 sets double-strike printing, if required.

Line 474 uses M to set the left-hand margin at the Mth position. M=10 causes a tab to 10 and then a margin of 10, thus line 232 to avoid this. The right-hand margin is not used, though there is an instruction for it.

Line 476 reads the values from locations #8E to #91. These are put there in line 505 and #8E holds 27, #8F has 66, and #90 has 1. Lines 200-220 can alter the value of #90 to give 12 characters per inch or 17 CPI instead of 10 CPI.

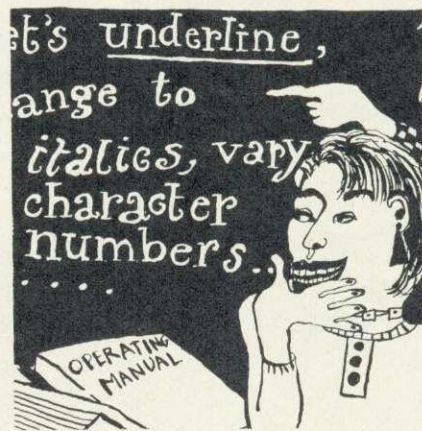

Line 478 ensures that the eighth bit (most significant bit) is 0. The printer sets this randomly which can be frustrating.

PRINT #27\$55\$0 is to obtain the US set so that the hexadecimal sign is shown as #. This can be altered to give foreign language types. The lines between 300 and 440 have PRINT statements: PRINT \$2 and \$3 are Atom commands. PRINT \$17 and \$19 are Star commands. These enable and disable the printer driver and put it 'on line' and 'off line'. (Both sets are included to show the order of use.) PRINT statements do not have to be separate; PRINT \$2\$27\$66\$1\$27\$61 is acceptable to the Atom and the printer instead of PRINT \$2, PRINT \$27\$66\$1, PRINT \$27\$61.

Now for the operating instructions.

The screen shows DATE. Type date or return. Anything input here will be kept as date.

The screen shows Options 1-8:

1 WRITE TEXT subdivides into 1-New

```

1          2
01234567890123456789012345678
0 THIS IS AN EXAMPLE OF HOW THE
1 TEXT EDIT ROUTINE LOOKS ON TH
2 E atom SCREEN. TYPING IS DONE
3 IN REVERSE, WITH LOWER CASE B
4 EING USED AS CAPITALS AND REV
5 ERSING THEM IN LINES 453 AND
6 454 BY EXCLUSIVE OR-ING WITH
7 #20. THIS STOPS THE SCREEN F
8 ROM BECOMING WHITE AND GLARIN
9 G.
A, B, D, I, N, Z?
```

How the Text Edit routine appears on the screen

Text and 2-Additional Text. New Text will start again and all previous text will be lost. Additional Text adds text at the end of current text. ZZ will return to option point. Text can only be added in the middle using EDIT.

2 EDIT displays text in lines 0-9; in columns 0-28. Available options are A, B, D, I, N, Z.

A - Amend, change letters one for one

B - Back, moves back to previous screen

D - Delete, deletes a stated number of letters starting from a given point

I - Insert, inserts a piece of text and moves up the remainder

N - Next, displays the next screen

Z - end of edit

Edit errors

'CAN'T GO BACK' - BACK requested but screen showing start of text.

'END OF TEXT' - NEXT requested at end of text.

Print control characters

Left square bracket (ASCII 91) - Italics

Backslash (92) - Underline

Right square bracket (93) - Cancel italics

Up arrow (94) - Enlarged print

Shifted (SH) At (96) - Cancel enlarged

SH left square bracket (123) - Superscript

SH backslash (124) - Cancel underline

SH right square bracket (125) - Subscript

SH up-arrow (126) - Cancel super/subscript

Star (42) - Linefeed

Place PCC immediately before the first letter to be changed. Cancel PCC just after the last letter - ie, before the blank. Include a space after commas and stops. The program automatically left-justifies and looks for the final space in the line.

3 PRINT TEXT (sub-option CHANGE PRINT STYLE). Three print styles can be selected: 10 CPI, 12 CPI and 17 CPI. Left-hand margin, lines per page, letters per line, and letter-heading are included in print style routine.

4 SAVE TEXT A name up to ten letters is asked for, two Record Tape messages are printed and there's a 10-second delay before the second.

5 LOAD TEXT Start tape before the recording. Each file name will be displayed. Press CTRL when the correct one shows.

6 REVIEW TEXT shows text as in the edit mode but without line and column numbers.

7 ENVELOPE to address envelope.

8 END of run.

At the end of each text input 'O.K.' is printed. If 'N' is typed in, the line is not accepted. The screen editing facility is still available in the usual way.

An asterisk during text input will be translated as a new-line indicator. Star-space-star will linefeed twice.

If it is necessary to end the run or ESC or BREAK is used, restart with G.y. Unless this method is used, there may be a loss of data.

UNBEATABLE VALUE!

£115
inc VAT
+ £8 carriage

CANON 200K DOUBLE SIDED

Model No. MDD210
40k track 200k
DOUBLE SIDED

★ low power consumption
(unlike full height drives)

All disc drives come complete with Professional Case – Ribbon cable to connect to BBC Micro – Power cable to connect to BBC Micro – Comprehensive Manual – Formatting and utilities disc.





Viglen
COMPUTER SUPPLIES

VIGLEN COMPUTER SUPPLIES, UNIT 7 TRUMPERS WAY, HANWELL, LONDON W7 28A. Telephone 01-843 9903. Personal Callers Welcome.

Post to: VIGLEN COMPUTER SUPPLIES, UNIT 7, TRUMPERS WAY, HANWELL, LONDON W7 2QA.

Please send me ____ (qty.) CANON MDD210 DRIVES at £115 each + £8 carriage. I enclose Cheque/P.O. for £ _____ made out to

VIGLEN COMPUTER SUPPLIES or debit my ACCESS/BARCLAYCARD No. _____

Name _____   Signature _____

Address _____

AU10/3a

NEW!

from

Viglen
COMPUTER SUPPLIES

A PRINTER STAND

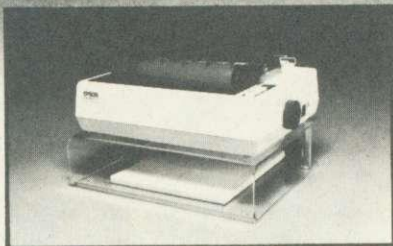

Printer Stand

£12.95 INC. VAT

Carriage & Packing £3.00

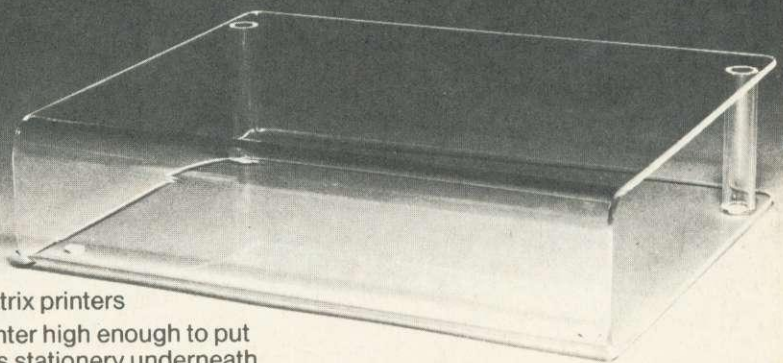

- For dot matrix printers
- Raises printer high enough to put continuous stationery underneath
- Beautifully finished in clear perspex • Viglen quality every time
- Will accept paper up to 12½" wide • Non slip rubber pads

Dimensions: 15" (380mm) wide 12½" (320mm) deep 4" (90mm) high



COME TO VIGLEN FOR A FAST, FRIENDLY, PERSONAL SERVICE

DEALER ENQUIRIES WELCOME

Post to: VIGLEN COMPUTER SUPPLIES, UNIT 7, TRUMPERS WAY, HANWELL, LONDON W7 2QA.

Please send me _____ (qty) PRINTER STANDS at £15.95 each. I enclose Cheque/P.O. for £ _____ made out to

VIGLEN COMPUTER SUPPLIES or debit my ACCESS/BARCLAYCARD No. _____

Name _____   Signature _____

Address _____

AU10/3b

Text input uses the normal Atom input so that strings are restricted to 64 characters. The request for a headed address in line 270 uses the WRITE TEXT routine and must also be ended with the string "ZZ". All text input is in upper case. The output to the printer reverses this with: #20 (Exclusive OR 32). This arrangement has been found to be better than locking into lower case and shifting for upper case, because it avoids filling the screen with white-background letters.

Edit falls into two parts: the edit options and the print control characters (PCC). Having edited the English, it is possible to operate on the PCCs using the same options. Each PCC can be entered immediately before or after any other, giving say, italics, enlarged and underlined until each is cancelled. If none is entered then printing is done in standard print. There are about 40 options for the Gemini, some duplicated, but these were selected as being the most useful. If some machine code is introduced to speed up the program then twice as many PCCs can be used by recording the first occurrence as 'on' and the second as 'off', instead of using different signs for each.

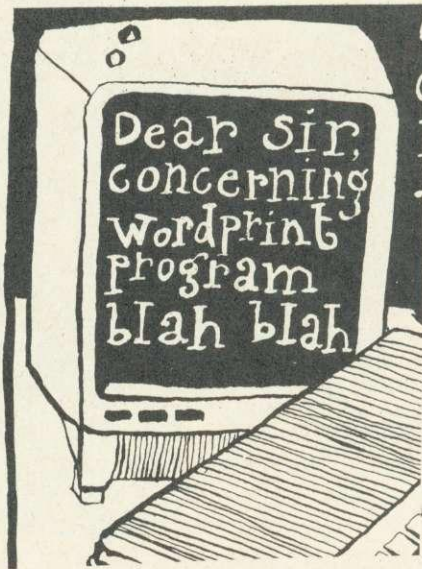

The program up to line 71 should be typed without the leading space or REMs. Line 71 is then at #2B57 as required in line 505, which sets the error-handler. The text in line 72 should be re-written to show your address. One leading space is required here, for line 316 needs this to start at #2B69. In line 26 the address of the first character

after the quotation mark has to be #298A to make lines 20 and 22 work correctly.

Within each main option, all variables are local. To list all the variables would take too much space. The print options set in lines 200-282 are held in locations #85-#8D. They are unpacked when required in line 300.

S and T are used throughout as string pointers for text. B is the text string and D is used as a general-purpose string.

#8200 holds 13 and #8201 has -1, for use in the dummy file in the Save routine. The text starts at #8204 and each file carries its end address in #8202, #8203.

The strings can be dimensioned if you prefer and BBC converters can carry the print options forward in suitably named variables. They may also find the articles on Beeb to Atom conversion (*Acorn User*, from April 1984) a help. The hardest parts to recognise are the abbreviated statements F., N., IN., G., GOS., U., R. These stand for FOR, NEXT, INPUT, GOTO, GOSUB, UNTIL, RETURN. It would be nice to see this program followed up shortly with a BBC version. Meanwhile, try your luck with the *Wordprint* editor.

HACKERS!



HERE, NOW, AN ADVANCED MODEM ESPECIALLY DESIGNED FOR YOU AND THE BBC MICROCOMPUTER. ONLY THE LOCO SYSTEMS SCM-100 OFFERS ALL THESE ADVANCED FEATURES:

- MULTI STANDARD - V21, V23; BELL 103, 202 - gives access to Bulletin boards home and abroad and Prestel
- FULL SOFTWARE CONTROL of all modes plus: orig/ans; line seize; carrier detect etc., using BBC micro user port
- AUTO ANSWER/AUTO DIAL - software monitoring facilities give automatic mode selection on answer
- OPERATING SOFTWARE in ROM gives 12 new O.S. commands for easy control
- COMPATIBLE WITH standard comms software including TERMI etc.
- EXPANSION PORT in modem allows for future developments. These include telephone answering capability using BBC speech synthesiser and tone dialler
- POWERED FROM BBC MICRO - splitter available for use with discs if required
- B.T. APPROVED ISOLATION COMPONENTS - BABT approval applied for
- INCLUDES ALL CONNECTING LEADS

THERE IS ONLY ONE CHOICE

LOCO SYSTEMS

As this modem represents the latest in technology, BABT approval is still awaited.



LOCO SYSTEMS, PO BOX 9, TWICKENHAM, MIDDX.
Please send me _____ SCM-100 software controlled modems @ £149.95 each. _____ Disc power adaptor @ £5.95 each

I enclose a cheque/PO order for £ _____ made payable to Loco Systems
Please send me further details (enclose S.A.E) _____

Name _____

Address _____

please allow 28 days for delivery

Buy from the specialists.

VIGLEN offer of TEC drives

(As used by Cumana) beats all comers

Replacing cassettes with disc drives means programme loaded and data accessed in seconds not minutes.

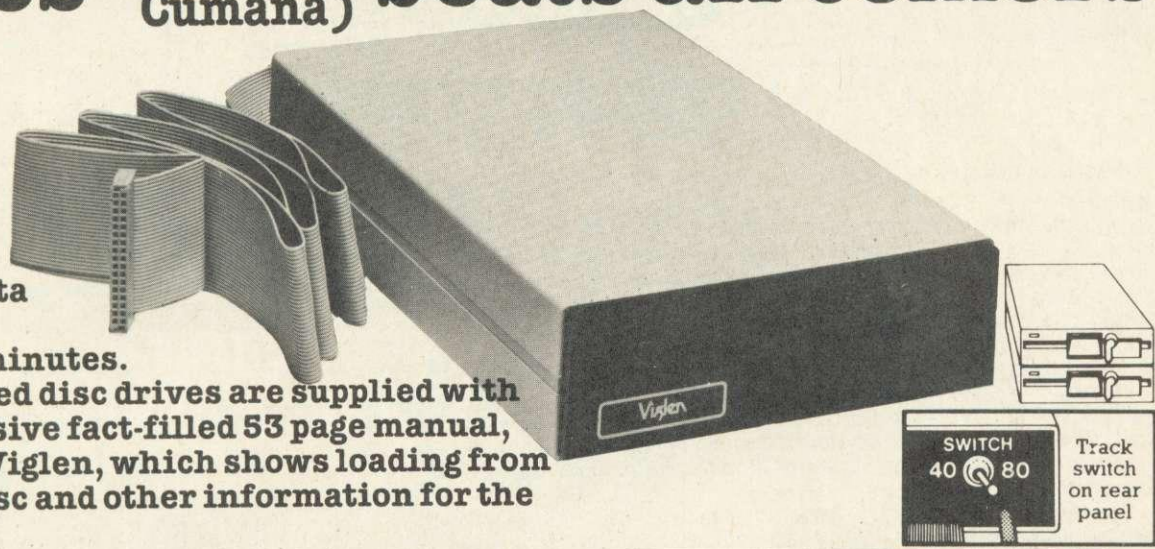

Our guaranteed disc drives are supplied with a comprehensive fact-filled 53 page manual, exclusive to Viglen, which shows loading from cassette to disc and other information for the BBC Model B.

TEC 55 SLIMLINE DRIVES

Single Drives	Incl VAT	Excl VAT	Dual Drives	Incl VAT	Excl VAT
40 Track 100K 5 1/4"	£119.00	£103.48	40 Track 200K	£238.00	£206.96
Single sided 40/80 track 200K switchable 5 1/4"	£139.00	£120.87	40/80 Track Switchable 400K	£278.00	£241.74
Double sided 40/80 track 400K switchable 5 1/4"	£179.00	£155.65	40/80 Track Switchable 800K	£358.00	£311.30
Integral Power supply for single drive	£25.00	£21.74	Integral Power supply for dual drive	£45.00	£39.13
			ACORN Disc Filing System	£105.00	£91.30

Please Ring 01-843 9903 for LATEST PRICES

Viglen

COMPUTER SUPPLIES

Unit 7 Trumpers Way
Hanwell W7 2QA
Telephone: (01) 843 9903

All prices correct at time of going to press and all offers subject to availability. All disk drives are supplied complete with Professional Screened Case - Ribbon Cable to connect to BBC Micro - Power Cable to connect to BBC Micro - Comprehensive Manual - Formatting and utilities disc, which includes 13 useful utilities including * formatting * verifying * screen dump * dis-assembler * generating 62 files, etc.

Orders welcomed from Educational Establishments and Government Departments.



Full Twelve Months Guarantee

How to order

By post: To purchase any of the items simply fill in the coupon with your requirements. Enclose your Cheque/P.O. or use your Access/Barclaycard. Please make cheques payable to VIGLEN COMPUTER SUPPLIES and post to above address. Allow seven days for delivery and add £8.00 carriage, package and insurance on all items.

By telephone: Ring (01) 843 9903. Credit Card holders (Access/Barclaycard only) can purchase by telephone. Please give Card No., Name, Address and the items required.

AMPLE ON-THE-SPOT CAR PARKING - AND IT'S FREE!

Post to: VIGLEN COMPUTER SUPPLIES UNIT 7, TRUMPERS WAY, HANWELL W7 2QA

Telephone: 01-843 9903. Personal Callers Welcome.

I enclose Cheque/PO. for £ _____

I prefer to pay ACCESS/BARCLAYCARD (Delete whichever is not applicable)

Card No. _____

Signature _____

Name _____

Address _____

Incl. £8 carriage. Cheques payable to Viglen Computer Supplies.

Credit cards valid if signed by card holder. Address below must be the same as on card holder.

AUTO/3

What the competition hasn't been waiting for.

Latest version of Forth for the BBC (Is not rehashed Forth 79 Code)

Unique Stack Display Utility



16k Eprom type 27128

Multi-tasking operating system for Real-Time use.

Here's the Forth Eprom for the BBC Micro that makes all others out of date.

It's Multi-Forth 83 from David Husband who has built his reputation for Quality Forth products with his ZX81-Forth ROM, Spectrum Forth-I/O Cartridge and now New Multi-Forth 83 for the BBC Micro. This is not rehashed Forth 79 Code, but a completely new version of the Forth 83 Standard. It's unique in that it Multi-tasks, and therefore the user can have a number of Forth programs executing simultaneously and transparently of each other.

Multi-Forth 83 sits in the sideways ROM area of the BBC along with any other ROMs in use. It is compatible with the MOS, and specially vectored to enable a system to be reconfigured. It contains a Standard 6502 Assembler, a Standard Screen Editor, and a Unique Stack Display Utility.

With this Forth, David Husband has provided the BBC Micro with capabilities never before realised. And being 16K rather than 8K is twice the size of other versions. Multi-Forth 83 is supplied with an

extensive Manual (170 pages plus) and at £45+VAT it is superb value.

Order it using the coupon adding £2.30 p&p (£5 for Europe, £10 outside) or if you want more information, tick that box instead. Either way, it will put you one step ahead of the competition.

Please send me Multi-Forth 83 for BBC Micro. £45+VAT. De-luxe System inc. Disc £80+VAT. Cheques to Skywave Software Readers' A/C (or enter Visa No.)

Name _____ Address _____ Post code _____

Multi-Forth 83
 ZX81-Forth ROM **Au**
 Spectrum Forth-I/O Cartridge

Skywave SOFTWARE

SUBJECT TO AVAILABILITY. FOR I.O.S. ONWARDS. Send to Skywave Software, 73 Curzon Road, Bournemouth, BH1 4PW, Dorset, England. Tel: (0202) 302385

MULTI-FORTH 83 FOR THE BBC MICRO



£54.95

'ROM/RAM EXPANSION BOARD



THE ULTIMATE ROM/RAM EXPANSION SYSTEM FOR THE BBC MICRO

- ★ 12 extra ROM sockets complement those already provided by the micro to allow up to 256K ROM space.
- ★ Four of these sockets can support either ROM or Static RAM (up to 16K maximum RAM).
- ★ The Model 2 board allows switching between multiples of 2K, 4K, 8K or 16K ROM/RAM.
- ★ Compatible with most other add-ons including TORCH, 2nd processors.
- ★ Additional features include the ability to transfer paged firmware to disc, and then load back into sideways RAM for future use - giving you no limit to the number of effective ROMs accessible!
- ★ NO soldering, plug-in design.
- ★ Fits easily inside BBC case.
- ★ Plugs into CPU socket via short flexible connector.
- ★ Improved plug design allows the Model 2 board to connect securely to any type of BBC CPU socket with no harm to micro or board.
- ★ Board is held in place by sturdy supports.
- ★ Full instructions provided.

All our prices are inclusive of VAT unless specified otherwise.
Postage and Packing: Please add £1 for small items (ROM/RAM Boards, software, etc.) £2.50 for medium items (disc drives, BBC Computers), £10 for larger items (monitors, printers, etc.).
 (Postal rates apply within U.K. only. Please telephone for export rates)
 Access/Barclaycard Telephone orders welcome.

SIR BUSINESS & COMMUNICATIONS

We announce our appointment as TORCH UNICORN Dealers, at a time when Acorn & TORCH are joining forces...

THE TORCH UNICORN RANGE:

- CP/M compatible extensions to the BBC Microcomputer System:**
- ZEP 100:** Z80 2nd processor card; 64K RAM; FREE SOFTWARE (see below) **£299 + VAT**
 - ZDP 240:** Z80 Disc Pack comprising ZEP 100; 2 x 400K floppy disc drive; FREE SOFTWARE (see below) **£799 including VAT.**
 - HDP 240:** As ZDP 240 but with one 400K drive replaced by a 20MB Winchester Hard Disc unit ... **around £1,995 + VAT.**
 - HDP 68K:** As HDP 240 but with twin (Z80B and 68000) "second" processors; provides an extra 256K RAM! ... **around £2,495 + VAT.**
- THE UNICORN:** Top of the range. The TORCH UNICORN comprises HDP 68K plus FULL UNIX III Operating System ... **around £2,895 + VAT.**
- TORCH C-500:** Complete self-contained unit (NO BBC MICRO REQUIRED) comprising BBC Micro system, ZDP, hi-res colour monitor & British Telecom-approved communications card. **Price available on application.**
- FREE SOFTWARE:** BBC BASIC (Z80) [allowing almost 48K User Memory!]; 'Perfect' Writer (word processor); 'Perfect' Calc (spreadsheet); 'Perfect' Filer (database filing system); Complete software package normally worth about £1,000!!

BBC MICROCOMPUTER		MONITORS	
BBC Model A	£289.00	Sanyo B/G	£85.00
BBC Model B	£379.00	Microvitec RGB	£219.00
BBC Model BD	£469.00		
DISC DRIVES		SOFTWARE	
Single 100k	NOW £139.00	We have a range of BBC and Electron titles currently in stock including ROM based programs such as VIEW (£59.80) , New 2.1 version	
Dual 100k	NOW £279.00	Computer Concepts' GRAPHICS ROM (£32.00), WORDWISE (£39.95) and DISC DOCTOR (£29.95).	
Dual 400k (40/80 Track Switchable)	NOW £399.00	Please telephone for full details of software range and current stock.	
PRINTERS			
Dot Matrix:			
Shinwa CP-80	£219.00		
Epson RX-80 F/T	£275.00		
Epson FX-80	£389.00		
Daisywheel:			
Juki 6100	£389.00		
ACORN BBC SECOND PROCESSORS			
6502 2nd Processor	£199.00	Z80 2nd Processor	£299.00

SIR COMPUTERS LTD, 91 Whitchurch Road, Cardiff CF4 3JP. Telephone: Cardiff (0222) 621813

VIGLEN

gives you the best value
in monitors, printers
& BBC Micros

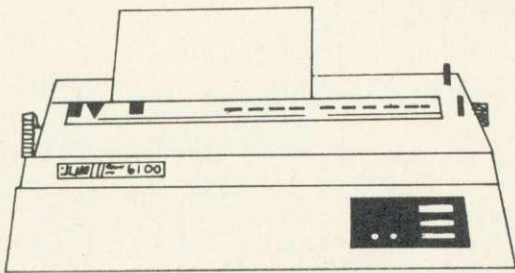

**NEW
SPECIAL
OFFERS**

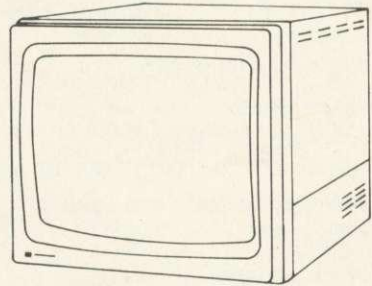

Dot Matrix Printers

Epson RX 80/FT Brand leader. A reliable well established printer with friction and tractor feeds. 80 cps **£275** (inc VAT)

Epson FX 80 The upmarket printer from the Epson range. 160 cps. All other facilities you would expect.

Competitively priced at **£379** (inc VAT)

Canon PW 1080 A - KAGA - TAXAN.

New printer recently reviewed shows near letter quality printing from dot matrix printer. Friction and tractor feeds. 160 cps. Highly recommended.

£289 (inc VAT)

Shinwa CP80 **£119** (inc VAT)

Daisywheel Printers

Juki 6100 **£375** (inc VAT)

SAN PLE 2000 **£229** (inc VAT)

Please add £8 for 1½ mm printer lead for the BBC Micro.

Please add £8.00 for carriage.

We also stock other computer peripherals, accessories and complete work processor systems at unbelievable prices.

Please call for our latest offers.

You may also purchase these items direct by calling at our factory/showroom in Hanwell, London.

Prices correct at time of going to press and offers subject to availability.

Colour Monitors

Microvitec standard 1431 **£189** (inc VAT)

Microvitec medium 1451 **£305** (inc VAT)

Microvitec high 1441 **£442** (inc VAT)

Philips 14" TV/monitor **£235** (inc VAT) (RGB Input)

Monochrome Monitors

Philips 12" Green V2001 **£75** (inc VAT)

BBC Micros

Model B **£369** (inc VAT)

Model B + DFS **£459** (inc VAT)

**Please Ring
01-843 9903
for LATEST
PRICES**

AMPLE ON-THE-SPOT CAR PARKING - AND IT'S FREE!
 Post to: VIGLEN COMPUTER SUPPLIES UNIT 7, TRUMPERS WAY, HANWELL W7 2QA

Please send me (state number required)
 I enclose Cheque/PO. for £
 I prefer to pay ACCESS/BARCLAYCARD (Delete whichever is not applicable)

Card No. _____

Signature _____

Name _____

Address _____

Credit cards valid if signed by card holder. Address below must be the same as on cardholder.

AUTO4

A J SOFTWARE for BBC

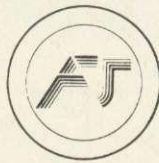

'The Record Changer'

32K £19.95 Cass. £24.95 Disc.

for indexing, membership lists, directories, inventories, budgeting, etc, etc.

don't buy a database in the dark—
check the spec!

'The Wordsmith' 32K for Centronics 737/739

AND NOW FOR EPSON FX80:

£19.95 Cass. £24.95 Disc.

Options Timetable 32K

£14.95 Cass. £19.95 Disc.

Simple Word Processor 32K

£9.95 Cass. £14.95 Disc.

Picture Maths

£9.95 Cass. £12.95 Disc.

An arithmetic practice program for primary schools.

Character Definer £9.95 Cass.

Enlarge, reduce, etc, etc.

Tape Catalogue £5.95 Cass.

Catalogue all your tapes using this program and never lose one again

Copy Disc £9.95

Copy disc to tape, tape to disc, M/C, Data or Basic.

ROM Read

£8.95 Cass. £11.95 Disc.

A machine code program to read the contents of any ROM socket and copy to RAM, tape or disc. Not to be used for illegal copying.

Machine code Disassembler

£5.95 Cass. £7.95 Disc.

Open Evening Timetable 32K

£14.95 Cass. £19.95 Disc.

Utility Eprom £19.95

for basic programmers

Mitsubishi Disc Drives

Dual 80 Track 800K £380 + VAT

Single Track Drives

Dual Sided 200K £199 + VAT

Double Density Disc Interface £85 + VAT

The best there is.

Epson Printers

FX80 £370 + VAT

RX80 £270 + VAT £8.00 Carr

BBC Epson Cable £15 + VAT

Normende

Not only the cheapest, but the best

Switchable 14" RGB Monitor/Colour TV £250 inc. VAT and cable, £8.00 carr.

Royalties for quality software

All prices VAT inclusive except where shown

AJ Vision Service Ltd, 61 Jeddo Road

London W12 9ED

SCOTLAND

	£ inc VAT
ACORN ELECTRON	£199.00
BBC MODEL B	£399.00
BBC MODEL B + DISK INTERFACE	£469.00
Z80 2nd PROCESSOR	£299.00
CUMANA DISK DRIVES FROM	£160.00
EPSON FX80 PRINTER	£420.00
EPSON RX80 F/T PRINTER	£295.00

ALSO WIDE RANGE OF
SOFTWARE AND ADD-ONS FOR
BBC AND ACORN ELECTRON.

All prices Include VAT.
CARRIAGE £8.00 per unit.

WEST COAST
PERSONAL COMPUTERS
47 Kyle Street, Ayr KA7 1RS
Telephone (0292) 285082

BBC MICRO REPAIRS by MICROFIX

ACORN AUTHORISED SERVICE CENTRE

"Cumana Disc Drive and Acorn DFS
supplied and fitted at low prices"

We will repair your faulty BBC micro, disc
drive or monitor quickly and at a
reasonable charge. Most repairs cost
between £10 and £20.

We can also offer extended warranties on
all your equipment.

Send S.A.E. for full price list.

Phone 01-968 9214

or call in at

191 Freston Road,
(Latimer Road Tube)
London W10

and ask for

Mark Duffill or Derek Mullings.

NEW!

FROM Viglen

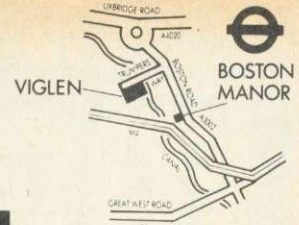

— Full Twelve Months Guarantee —

COMPUTER SUPPLIES

Unit 7 Trumbers Way Hanwell W7 2QA Tel: (01) 843 9903

DISK STORAGE

No. 1

This diskette storage holds 70 diskettes

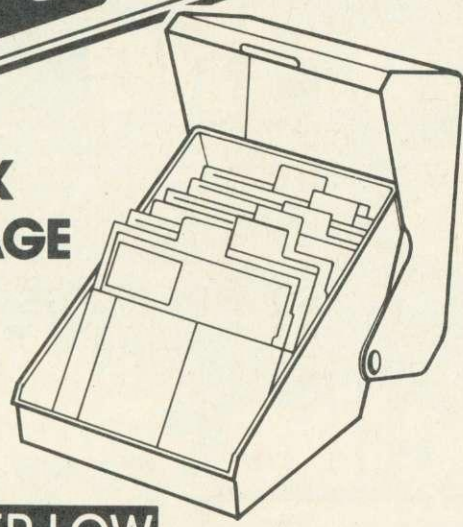

Our **SUPER LOW**

price **£18.00** Including VAT

DISK STORAGE

No. 2

This lockable diskette storage holds 80 diskettes

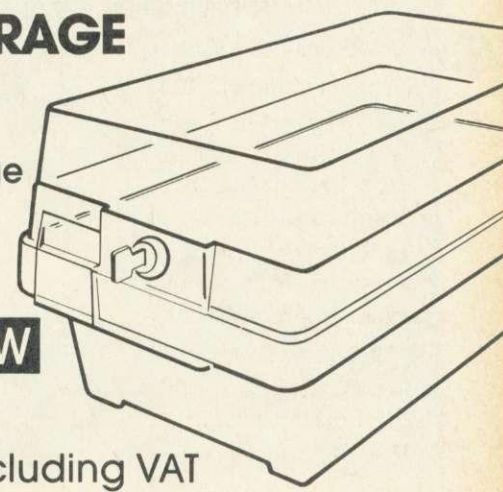

Our **SUPER LOW**

price **£18.00** Including VAT

3M SCOTCH DISCS

5 1/4" diskettes single sided



Our **SUPER LOW**

prices Inc.VAT

Per boxes of 10

boxes	1-2	3-9	10+
SS 40 TRACK	£15.00	£13.50	£13.00
DS 40 TRACK	£20.00	£18.40	£17.70
SS 80 TRACK	£23.00	£20.70	£20.00
DS 80 TRACK	£26.70	£24.00	£23.00

PERSPEX KEYBOARD STOWAWAY & VDU STAND

Our **SUPER LOW** price

£14.95

Inc VAT

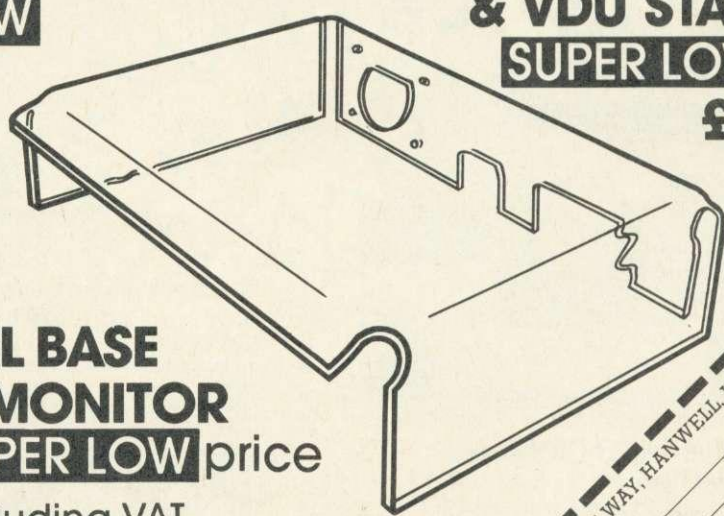

SWIVEL BASE FOR MONITOR

Our **SUPER LOW** price

£16.00 Including VAT

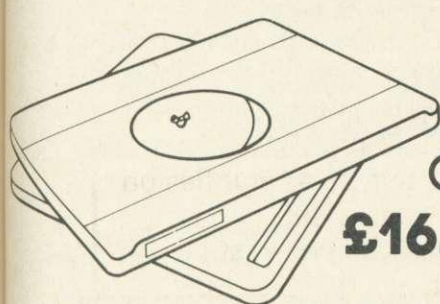

GRAFPAD Our **SUPER LOW** price

£143.75 Including VAT



This remarkable Grafpad from British Micro allows you to input information into your computer - very accurate and high resolution, not to be confused with other models which are both more expensive and less accurate. Supplied with all necessary cables, manual and sample programs, to allow you to develop your own application programmes.

AMPLE ON-THE-SPOT PARKING. AND IT'S FREE!
 Post to: VIGLEN COMPUTER SUPPLIES, UNIT 7, TRUMPERS WAY, HANWELL, W7 2QA. Tel: 01-843 9903

Please send me the following items:

I enclose Cheque/P.O. for £ _____

I prefer to pay by ACCESS/BARCLAYCARD* Card No: _____

Signature _____

Name _____

Address _____

All items £2.00 only for p & p. *delete as necessary

153

FOOTBALL MANAGER

It's here for the BBC Model B

- Some outstanding features of the game**
- Matches in 3D graphics
 - Promotion and relegation
 - Injury problems
 - Pick your own team for each match
 - Managerial rating
 - Financial manipulations
 - Transfer market
 - F.A. Cup matches
 - Full league tables
 - As many seasons as you like
 - 7 skill levels
 - 64 teams and customising feature
 - You can even be sacked!

Prices:

BBC Model B	£7.95
Commodore 64	£7.95
Spectrum 48K	£6.95
ZX81 16K	£5.95

(N.B. 3D GRAPHICS ARE NOT INCLUDED IN THE ZX81 VERSION)

Overseas orders add £1.50

Strategy Game of the Year, 1983
(Nominated)

Golden Joystick Awards



Addictive

Available from computer software stockists nationwide, including



and

John Menzies



£7.95

Addictive Games

7A RICHMOND HILL, BOURNEMOUTH BH2 6HE

To order by mail (p&p free) send cheques or postal order to:

THE SIR COMPUTERS' PRINTSTICK



ADVANCED SPECIFICATIONS include:

PRINTER FEATURES

Compatible with any Centronics-type printer.
Uses BBC Microcomputer operating commands - VDU 2, *FX5, 1.
Built-in command (*SCREENDUMP) allows colour graphics to be copied to any Epson-compatible printer.

JOYSTICK FEATURES

Provides connections for two Atari-type joysticks, allowing the use of two-player games.
Compatible with 99% of Electron software.
Built-in command (*DEFINEKEYS) allows joysticks to be used even with programs not normally providing joysticks options!

ADDITIONAL FEATURES

Only Acorn-approved memory addresses are used, ensuring compatibility with all current and future expansion devices. All operating software is held internally in a 'sideways' ROM. There is no need to load any additional software from cassette, unlike inferior interfaces.
Housed in a slimline plastic case.

ELECTRON ROM/RAM EXPANSION UNIT

PRICE £59.95

Provides 12 extra sockets which support a variety of ROM and RAM configurations up to a max. of 192K for ROM and 16K for RAM.
ROM and RAM is normally paged in 16K blocks but is easily switchable to 2K, 4K or 8K blocks.

Easy to install - just plugs in.
Professional styled casing bolts to rear of computer.
Fully buffered design.
Permits use of most BBC ROM-based software including utility ROMs, wordprocessors & languages.

THE SIR ELECTRON ADC/PRINTER UNIT PRICE £64.95

NOT JUST ANOTHER JOYSTICK PORT - FULL ANALOGUE-TO-DIGITAL CONVERTER provides fully proportional control, essential for use with graphics packages, digitizers, etc; ideal for scientific & educational applications; usable with a wide variety of BBC Micro-compatible analogue and switched Joysticks/Paddles. No need to load software from tape.

CENTRONICS PRINTER INTERFACE - allows use of a wide variety of parallel printers including entire Epson range; complete firmware support included.

HIGH-QUALITY MOULDED CASE - attractively styled plastic unit bolts securely to the back of the computer.

EASY TO FIT - no soldering, simply plugs straight into computer's rear edge-connector and is held in place by twin bolts; edge-connector on back of unit provides for further modular expansion if necessary.

NEW

COMBINE
SPECIAL PRICE £99.00

BOTH THE ABOVE UNITS (ROM/RAM Expansion Board and Printer/ADC Interface) IN ONE CASE! A complete and comprehensive Electron expansion - ideal for word-processing applications among many other uses.

—ALL PRICES THIS PAGE INCLUDE VAT—PLEASE ADD £1 P&P PER ITEM ORDERED

SIR COMPUTERS LTD
91 WHITCHURCH ROAD, CARDIFF CF4 3JP
Tel: Cardiff (0222) 621813



SOFTWARE CHART

TITLE	PUBLISHER	PRICE	MICRO	REVIEWED
1 (—) Frak!	Aardvark	£7.50	B	September '84
2 (2) Fortress	Amcom	£8.95	B	September '84
3 (3) Blagger	Alligata	£7.95	B/E	October '84
4 (5) Twin-Kingdom Valley	Bug-Byte	£9.50	B	
5 (9) Football Manager	Addictive	£7.95	B	
6 (13) Chukkie Egg	A&F	£7.95	B/E	September '84
7 (—) Micro Olympics	Database	£6.95	B	
8 (1) Aviator	Acornsoft	£14.95 (£17.95)	B	May '84
9 (17) The Hobbit	Melbourne House	£14.95	B	
10 (8) 737 Flight Simulator	Salamander	£9.95	B/E	December '83
11 (10) Overdrive	Superior	£7.95	B	September '84
12 (—) Spitfire	Alligata	£7.95	B	
13 (—) Felix and the Fruit Monsters	Micro Power	£7.95	B	
14 (—) Hopper	Acornsoft	£9.95	B/E	August '84
15 (4) Battletank	Superior	£7.95	B	September '84
16 (20) Ghouls	Micro Power	£7.95	B/E	June '84
17 (15) Hunchback	Superior	£7.95 (£11.95)	B	September '84
18 (—) Countdown to Doom	Acornsoft	£9.95	B/E	
19 (—) Snowball	Level 9	£9.90	B	
20 (7) Mr Wimpey	Ocean	£6.90	B	

B=BBC E=Electron Prices in brackets are for disc version

BUBBLING UNDER

Quick Thinking (Mirrorsoft)
Brainstorm (Virgin)
Java Star (Shards)
Sea Adventure (Virgin)

Compiled by RAM/Computer

Jet-power Jack (Micro Power)
Lords of Time (Level 9)
System 15000 (Ferranti)
Nifty Lifty (Visions)

Cosmic Cruiser (Beau Jolly)
Hulk (Adventure International)
Eagle Empire (Alligata)

FRAK! has done it. Straight into pole position. Visitors to the AU Exhibition will have seen why it's up there, and what happens when you get to the later stages. Our Editor (who's appalling at games) barely managed to scroll past the first screen, but the real players can get to the end of the trail when the screen is repeated, upside-down!

Aviator has stalled after its No 1 entry last month, but Acornsoft's fortunes will no doubt be revived by the newcomer *Elite*, reviewed in this issue.

Other releases to look out for are Micro

Power's *Dune* and a Grand Prix racing game from Software Invasion (complete with bends) to rival Atari's *Pole Position* and Superior's *Overdrive*. Quicksilva also has a racing game under way produced with Atari's blessing.

Football Manager's progress can expect to be given a helpful boot upwards by the start of the new season, probably from Everton fans hoping to repeat their team's success over awe-inspiring Liverpool in the Charity Shield. *Micro Olympics* will no doubt continue going for gold but will have a job

overhauling the yo-yoing *Frak!* No doubt the Olympic game will be boycotted by our Eastern-bloc readers because of its commercialism in featuring advertising on background hoardings.

Adventure fans are making their presence felt with four placings, two of them, *TKV* and *The Hobbit*, showing a lot of staying power in the chart.

Our tip for next month's top match? Still *Frak!* But watch out for *Elite* jumping in and a major campaign from Software Invasion with its *3D Grand Prix*.

microFAST LATEST BARGAIN PRICES

colour MONITORS

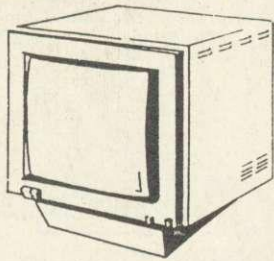

Microvitec 1451
£239.13
 + VAT = £275
 inc VAT

Amstrad CTM640	£169
Microvitec 1431	£195
1431 (RGB/PAL/AUDIO)	£225
Taxan Vision EX	£215
JVC 1302-1 (QL/BBC)	£195
Microvitec 1451/QL	£255
Microvitec 1451	£275
1451 (RGB/PAL/AUDIO)	£340
Taxan Vision II	£270
JVC 1302-2 (QL/BBC)	£253
Microvitec 1441	£499
Taxan Vision III	£370

DISK DRIVES

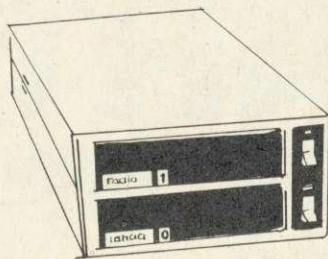

100K 40T
£86.09
 + VAT = £99*

Single	inc VAT
100K ALPS 40T	£99*
100K Chinon 40T	£145
200K Sankyo 3" 40T	£185
400K Mitsubishi 40/80T	£199
400K Cumana 80T	£215

Double	inc VAT
400K Sankyo 3" 40T	£369*
800K Cumana 80T	£419
800K Mitsubishi 40/80T	£439
800K Cumana 40/80T	£499

mono MONITORS

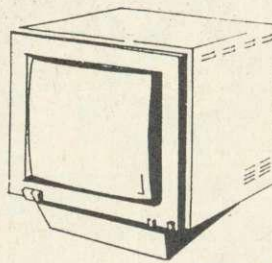

ISL 18
£53.91
 + VAT = £62
 inc VAT

Amstrad GT64	£69
Sanyo DM2112 (15 MHz)	£75
Sanyo DM8112CX (18 MHz)	£103
ISL 18 (18 MHz)	£62
ISL 20 (Swivel 80 col)	£73
Teco with Zoom	£105

DOT MATRIX

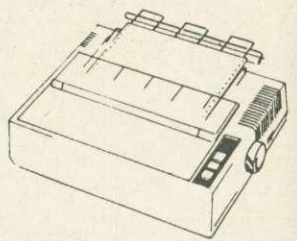

Epson RX80 F/T
£221.73
 + VAT = £255

Star Gemini 10	£249
Star Delta 10	£365
KDC FT-5001	£234
Epson RX80	£219
Epson RX80 F/T	£255
Epson FX80	£379
Epson FX100	£588
Mannesman	£225

VARIOUS

Torch Ext. Processor	inc VAT
+ Software	£299
Torch Ext. Processor + software	
+ twin drives	£749

Computer Concepts ROMs from	£32
Acorn Business Software	£24
Acorn Data Recorder	£32
Computer Work Station	£57
Holds Micro *, Monitor, Printer with Storage Space.	
Printer Stands	£17
Desk Stacking Unit	£23
(Lockable version available)	

PROCESSORS

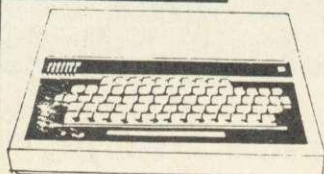

BBC Model B
£320.87
 + VAT = £369*
 inc VAT

BBC 'B' + Recorder & s/ware	£369*
BBC 'B' with DFS	£459
Acorn Z80 Ext. Processor	£299
Torch Unicorn Package	P.O.A.
Amstrad CPC464	£160
6v power + UHF	£28
ISL 8083 (IBM Comp)	£1350
DEC 11/23 + 40 MB	£7000
DEC 11/73 + 170 MB	£1200
LVL DD/DOS	£119

Phone for quotation on
*bespoke Accounting
 Software Invoicing/
 Ledgers/Payroll*

★ SPECIAL OFFER WHILE STOCKS LAST

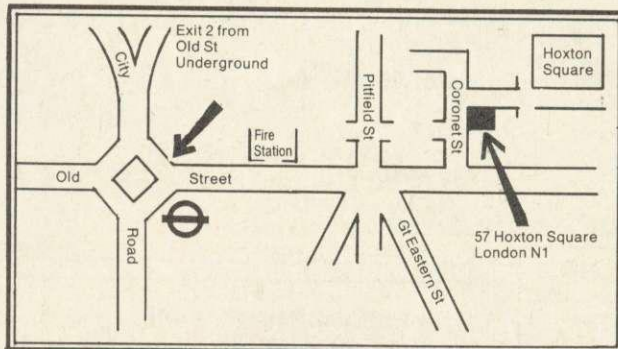

ALL PRICES INCLUDE VAT

Prices shown are for cash & carry sales and are correct at time of going to press in August.
 Export price list available
 Mail order and credit cards accepted
 OPEN 9-6 Monday to Saturday

57 Hoxton Square, London N1
 Tel: 01-729 1778

microFAST

THE EXPERTS

DAISYWHEEL

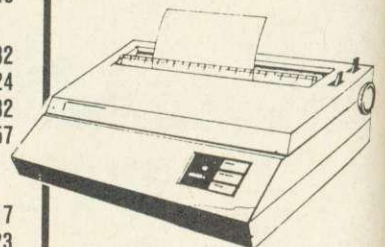

Juki 6100
£326.08
 + VAT = £375

JUKI 6100	£375
Daisy Step 2000	£249
Plus	
JUKI Sheet Feeder	£239
JUKI Tractor Feed	£109
Serial Interface Conversions	
8143—Epson	£30
8148—Epson (2k buffer XON/XOFF protocol)	£65
JUKI	£55
Plus cables from	£12

BUSINESS SYSTEMS

A.C.T. Apricot Processors and Business Systems assembled to your specification. Price dependent on equipment supplied. Call us to discuss your requirement.

DISK INTERFACES

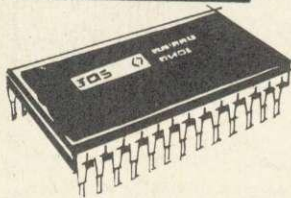

Kenda Mighty Oak	inc VAT
Kenda Professional (double density)	£90
Opus Double Density	£130
Acorn DFS Kit	£130
	£97

MODEMS

Selection of Acoustic Couplers and Mini Modems in stock.
 Minor Miracle WS2000 £145
 inc VAT

TOOLKITS ON TRIAL

Bruce Smith finds firm favourites among five utility ROMs

THE ability of the BBC micro to accept a variety of extra ROM-based software that can be used concurrently with Basic or even replace Basic has always been an important aspect of its design, and it goes some way to compensating for the small amount of user memory available, especially in the high-resolution graphics modes. (With extra hardware, of course, the Electron has similar potential.)

Independent suppliers have been quick to jump onto the bandwagon of ROM-based software (normally termed firmware), producing a variety of programming goodies. As many of you are aware, the choice is confusing. What exactly does the firmware do? Is it as good as the others? If not, which one is the best? And so on.

In an effort to help you through this firmware jungle a comparative review of groups of firmware will be appearing in future issues of *Acorn User*. This month I start the ball rolling with a look at ROMs containing Basic programming aids or utilities. Future issues will focus on machine-code monitors, databases and wordprocessors.

The Jargon

Rom-based software for the Beeb is often called a 'utility'. This word really means an aid to programming, a program that will allow you to perform a certain task with minimum fuss. Consider what would happen if you had a longish program in which you wanted to replace all occurrences of one variable name with another. No problem if the variable has been used only a few times. You simply edit it in using the cursor control and Copy keys. But what if there were ten, 20 or even 30 occurrences of the variable? To edit each one by hand would be laborious. The best answer is a utility program that would do the whole job for you. Enter the name to be replaced, the new name and the utility does the rest! Because of the usefulness of these types of commands a collection of them is generally termed a 'toolbox' or 'toolkit', as they are thought of as supplying a collection of tools for the programmer.

A usable utility

The most obvious way to write a utility program is in Basic, and listing 1 provides an example that lists the values

assigned to all the resident integer variables in decimal and hexadecimal. Trouble is, writing a utility in this way has many drawbacks. First, where do you put it? The most obvious way is to incorporate it in the main program as a procedure, as demonstrated in the program. A library of utility procedures could be stored on tape or disc as ASCII files and simply spooled in as required. However, this eats up memory and means that the final program will need editing to remove the utility when it is complete – shades of Catch 22!

An alternative method would be to place the utility in a different part of

Executing machine code doesn't involve the complicated rigmarole of changing PAGE etc. – a simple CALL to the start address will suffice. Machine code also operates much faster than an interpretative language such as Basic.

Listing 2 provides a simple program compactor. Type it in, run it, and save the machine code to tape or disc using:

```
*SAVE "SPACE" C00 + FF C00
```

Using the program simply involves *RUNning it or, if already present, CALL &C00. The effect of the program is to remove all spaces, except those within quotes, from the program at PAGE so that it requires less memory space. This utility needs to be used with care. For example, the line:

```
500 DEFPROCdemo BYTE% = 0
```

is legitimate, but after deleting the space the line will be:

```
500 DEFPROCdemoBYTE% = 0
```

which will cause an error at run time. The way around this is to place a colon between the procedural name and the variable, thus:

```
500 DEFPROCdemo : BYTE% = 0
```

Similar care should be exercised when using the assembler to differentiate, between a label name and the opcode to prevent them from turning into one long label name!

Using machine code in this way has its disadvantages – it still uses up memory. This may not be a problem if only one utility is required, but finding space for two or more useful utilities well out of the way is not easy. Also, once a machine code program has been assembled into a particular area of memory it can normally only be loaded back and used correctly in that same area, unless some fancy coding techniques have been employed to make it relocatable. Thus a program assembled to run in the soft character buffer is not much good if your program makes use of the definable character facility! A way round this would be to assemble code into several areas and load the required one in, but this is

SUPPLIERS

ADDCOMM

Vine Micros, Marshborough,
Sandwich, Kent.
Tel: (0304) 812276

CARETAKER

Computer Concepts, Gadderden
Place, Hemel Hempstead, Herts
HP3 6EX.
Tel: (0442) 63933

TOOLKIT

Beebugsoft, PO Box 109, High
Wycombe, Bucks HP10 8HQ.

TOOLSTAR

Pace Software Supplies, 92 New
Cross Street, Bradford BD5 8BS.
Tel: (0274) 729306

U-TOOLS

Intersoft, 26 Netherfield Road,
Sandiacre, Nottingham NG10 5LN.
Tel: (0602) 399974

memory by adjusting the value of PAGE. The program still uses up memory, assuming there's enough to put it there in the first place. To run the program you have to alter PAGE and change it back to its original setting to get back to the main program.

Another approach is to write the utility in machine code. The main disadvantage here is that you need a knowledge of assembler to do this yourself, unless the software is being bought. Machine code is more versatile than Basic and usually much less demanding of memory and so can be placed out of the way in a backwater of memory. The user-defined character space from &C00 to &CFF is a favourite location.

Bruce Smith's example utilities in Basic and machine code (listings 1 and 2) are on yellow page 112

Bad mode? no room?

Solve your problems in 5 minutes with the...

RAVEN-20

Features include...

- PROVIDES 20K OF USABLE RAM
- ALLOWS THE RUNNING OF PROGRAMS UP TO 28K LONG IN ANY SCREEN MODE
- RAVEN 20 IS COMPATABLE WITH ALL CORRECTLY WRITTEN SOFTWARE
- SIMPLE PLUG IN AND GO DESIGN
- SPECIAL COMMANDS FOR SOFTWARE WRITERS
- COMPLETELY TRANSPARENT TO BBC OPERATING SYSTEM
- NO SOLDERING OR CUTTING OF TRACKS
- USES ONLY DOCUMENTED MOS CALLS
- LOW POWER DYNAMIC RAM DESIGN + MANUAL
- SELF TEST FACILITY
- COMPLETE WITH ROM BASED SOFTWARE
- CAN BE FITTED TO BBC MODEL B FITTED WITH OS1.2

**THE ULTIMATE IN
DESIGN & PRICE**

**ONLY
£69.95
INC VAT**

RAVEN MICRO PRODUCTS

1 SAVILLE ROAD · WESTWOOD · PETERBOROUGH PE3 7PR · TEL 0733 260930

fiddly and time-consuming, especially for tape users.

Inside track

Home-brewed utilities therefore have their disadvantages – they have to be written, they use up precious memory and they are not always easy to use. The best compromise is to use machine code stored within EPROMs using the sideways ROM facility of the Beeb. The advantages are many. The utilities are always on hand because they form part of the micro itself, and that also makes them 'portable'; you are not dependent on disc drives or cassette recorders to get at them. Virtually all the commands are implemented as commands because the ROM itself contains an interpreter that recognises them. Thus our compacting program, if found in a toolbox, might be executed just by typing *PACK or *CRUNCH. Because ROMs occupy the same area as Basic they are transparent to the user, thanks to some clever electronics, and do not normally require any user memory.

There are disadvantages, of course. For a start, outlay – most items of firmware normally cost at least £22 and they need to be fitted into the machine. A dealer will often do this if you buy from him, but the mail order buyer is on his own.

What's around

Toolbox The only serious item of tape-based utility software I have encountered is BBCSoft's *Toolbox*. This is a neatly packaged book with accompanying cassette of programs. It obviously suffers from all the aforementioned problems and at £21 is not cheap. However, for anyone wishing to learn about the techniques involved in utility programming it is a useful introduction. Twenty-five utilities are provided, 13 of which are written in Basic and 12 in assembler. A good range of programs are provided and these include sorting routines, a variable dump, a REM stripper and program formatter. Each program is discussed in the accompanying text.

It has to be said, however, that EPROM-based software is really a must for the serious utility user.

Addcomm The *Addcomm* from Vine Micros is probably the best value for money out of the toolkits. Although it does not come out on top in table 2, the overall command content is undoubtedly the best. In addition to the 31 Basic programming utilities the EPROM provides some useful enhanced graphics facilities, including circle and ellipse drawing commands, colour fills and commands to scale and rotate your creations.

A simple implementation of Logo graphics is also included providing turtle graphics commands such as PEN, LMOVE, ROTATE, ANGLE and so on.

The commands are implemented not as operating system commands (ie, commands prefixed by asterisk) but instead they are entered directly as they are. This is because the *Addcomm* interpreter traps the errors that Basic would normally throw up and then tries to interpret the command that caused the error as an *Addcomm* command. This is good in theory but it can lead to confusion as it sometimes interprets Basic errors as *Addcomm* errors and displays the wrong error message.

Finally, *Addcomm* offers 40 commands to the user, though I consider only 37 of these usable. The other three allow the user to jump out of loops – naughty! They should be ignored by the user as they are not good programming practice. My plea to Vine Micros would be to delete these computer nasties from the instruction set and replace them with better error-handling.

Caretaker I'm a little disappointed with *Caretaker*. Over the past couple of years Computer Concepts has produced some of the best firmware for the BBC micro, but *Caretaker* falls some way short of the company's high standards. Of its 18 commands, I consider three to be space-fillers, although they are useful sometimes. CURSOR allows

the cursor to be turned on and off, while TABSTOPS and NOTAB allow the user to determine the new position of the cursor on the screen.

What disappoints is that it is rather run-of-the-mill, and shows none of the originality we've come to expect from CC. Useful enhancements, however, are those of single key command entry, emulating the Electron, as is the ability to save specified sections of program such as important procedures. *Caretaker* also scores on its EXCHANGE facility, which allows a good degree of control in selecting global or selective search and replace.

Toolkit Beebugsoft's *Toolkit* scores well in the five standard ratings section of table 2. The variable dump commands are extensive and include listing of procedure names and arrays in addition to integer and real variables. The enhanced line editor is useful, allowing program scrolling in any direction and listing of any erroneous line, highlighting the error at run time.

A couple of commands seem somewhat dubious, however. The ability to be able to perform OLD within a program would be needed on very few occasions, and I can think of no occasion when it has been necessary to perform NEW from within a program.

Toolstar This is not essentially a Basic toolkit but a general utilities aid, as it includes machine code and disc utili-

ITEM	ADDCOMM	CARETAKER	TOOLKIT	TOOLSTAR	U-TOOLS
PRICE	£28	£33.35	£27.00	£34.00	£26.95
No. Basic commands	31	18	26	8	26
Total No. commands	40	18	26	22	26
Bad program cure	●	●	●	●	●
Compact	●	●			●
Error-handling			●		●
Find	●		●	●	●
FKeys lister	●			●	●
Format listings	●				
Global search/Replace	●	●	●	●	●
Graphics Enhancement	●				
Help page	●			●	●
Insert program lines		●	●		
PACK	●	●	●		●
Program status	●	●	●		●
Renumber		●	●	●	
ROM command identity	●		●	●	
Save/Load function keys		●			
Save part program		●			
Screen dump					●
Single key commands		●			
Shift program		●	●		●
Turn off ROM	●				
Variable dumps	●	●	●		●
Verify			●		

Table 1. Facilities at your command

ties. As table 1 shows, only eight of its 22 commands are Basic-orientated and this should be borne in mind when it comes to your decision. In essence, *Toolstar* is suited to the advanced programmer who dabbles in machine code and Basic and uses discs.

The global search and replace facility is a good implementation and the toolkit's built-in software allows you to add your own RAM-based commands. A very interesting feature.

The *Toolstar* manual is excellent - by far the best I have seen produced for an item of commercial software; indeed it is much better than many computer user guides. Its 156 spiral bound pages are colour-coded, and copious use of examples makes it a joy to read.

U-Tools The *U-Tools* box offers a good, steady variety of utilities. One of the more interesting features is a command that will not only save a program but also lock it so that it can *RUN, though it is a shame that it can be used efficiently only with machine code programs. A variety of program-crunching commands are on offer, plus an error-trapping wedge that lists an erroneous line before printing the error message.

	ADDCOMM	CARETAKER	TOOLKIT	TOOLSTAR	U-TOOLS
Ease of use	8	7	7	7	7
Range of utilities	8	7	6	5	7
Documentation	8	5	5	10	5
Error messages	5	6	9	6	6
Five standard utilities ratings					
Bad program core	7	7	8	8	7
FIND string	8	N/A*(5)	9	7	8
Global search & replace	8	9	8	9	7
Program compactor	9	9	7	N/A	9
Variable dumps	7	8	10	N/A	8
TOTAL	68	63	69	52	64

N/A = Not available.

*FIND not directly available but can be implemented using global search and replace facility and specifying same search and replace strings.

Table 2. How they score on a scale of 1 to 10

U-Tools is the only toolbox to provide an intelligent screen dump of any of the graphics modes to an Epson or Epson-compatible printer such as Star. The dump provided is large - 23 x 16.5cm - and it is produced *down* the paper.

Which one?

Before choosing which Basic toolbox you want to buy it is worth making out a list of items that you feel it should contain - in other words, the commands

that would be most useful to you.

My own preference is the *Addcomm*, followed by *Toolkit*, finances allowing. From table 1 it would seem that the best combination would be *Addcomm* and *Caretaker*, as they cover the entire range of utilities. However, these two ROMs seem to be incompatible as some *Addcomm* commands will not function with *Caretaker* present.

At the end of the day, however, it should be a personal choice.



ADD 40 COMMANDS TO BBC BASIC WITH ONE ROM

GRAPHICS

SCALE is a powerful and totally flexible statement that allows the user to take control of the scaling of the screen. Integers, real numbers and variables can be used. **ROTATE** is used to 'rotate' the axes about a point and by an angle both defined by the **ROTATE** statement on a scaled screen. **CIRCLE** and **ELLIPSE** allow a multitude of shapes to be drawn using a single statement, including- any regular polygon, circles, arcs, solid sectors, triangles, squares, etc. **FILL** is used to 'fill' a previously drawn area, with **CFILL** setting the colour/pattern/shade within pre-drawn bounds. **TRANS** is used to translate the scaled area across the screen by the use of cartesian co-ordinates, subsequent graphics commands making use of the now displaced scaled area.

Plus: SMOVE, SDRAW, SPLOT and UNSCALE.

4
IN
1

LLIST can be programmed, unlike **LIST**, and under the User's control, multiple statement lines can be split up into their component parts allowing for greater ease of reading. **LGOTO** is similar to the **GOTO** statement but more powerful in that it enables the user to jump to 'labelled lines' allowing for neater and more readable programmes. **SORT** allows the user to sort all or part of a string array into alphabetical order using a single statement. Invaluable for data processing. **SETWIN** and **WIN** allow the user to define, using **SETWIN**, and display, using **WIN** up to seven complete windows on the screen. The user being able to select and return to previously deselected windows at will, the cursor maintaining it's last used position within that window.

Plus: OPT, POPFOR, POPGOS, POPREP and ADDCOMM.

GENERAL

Compatible with: Acorn DFS, Amcom(Pace) DFS, Watford DFS, Wordwise, Disc Doctor. Model B, BASIC 1 or 2, OS 1.20

ADDCOMM

Plus: *HELP displays the full syntax of all commands. Price includes a detailed ring-bound User Guide.

LOGO

LMOVE is used to position the LOGO cursor, usually used prior to further LOGO statements. **ANGLE** is used to set the intended direction of the LOGO cursor, the angle being described in degrees. **ADVANCE** is used to move the cursor in the direction as set by **ANGLE** by the distance described in the **ADVANCE** statement. **TURN** gives the cursor a new direction by turning it a certain number of degrees anti-clockwise from its previous direction. **PEN** defines the kind of trail left by the LOGO turtle using the internal plot codes. **LCIRCLE** and **LELLIPSE** are the LOGO equivalents of the similar enhanced graphics commands, the shape centre being the current LOGO cursor position. **LPOS** is used to return the position of the LOGO cursor from a SCALED screen.

These commands are unlike those on any other ROM, since they are used in exactly the same way as the standard BASIC commands - i.e. any numeric/string expression, multi-line statements, access to any variable, and, of course no stars!

£28

includes V.A.T. post and packing.

NOW AVAILABLE FOR

ELECTRON
WITH ROM BOARD

CHAR is a simplified 'character' designing facility using an enlarged grid that enables the user to quickly and easily construct or alter graphic and pseudo-alphanumeric characters. **COMPACT** is used to reduce the size of all or part of an existing program by intelligently appending lines together. **FIND** is used to search all or part of a program to find any desired character or set of characters. **GREPL** and **SREPL** are two related commands that enable the user to replace a character or group of characters with any other character or group of characters, under total control of user. **LVAR** is used to list all, or alphabetically selected, variable names currently within memory. **VERIFY** is a simple command to confirm that a copy to tape or disc is exactly the same as the original program in memory.

Plus: MEM, GOODPROG, KILLREM and FKEYS.

HOOKS

VINE MICROS, MARSHBOROUGH,
SANDWICH, KENT. CT13 OPG.
(Or send stamp for Brochure.)

Tandy® Colour Graphics Printers For Quality and Efficiency!

Ultra-Compact Colour Graphics Printer
£149⁹⁵ Inc. VAT

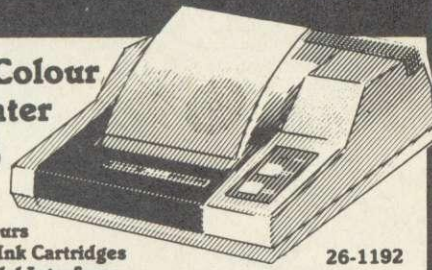

- Prints In Four Vivid Colours
- Uses Easily Replaceable Ink Cartridges
- Includes Serial and Parallel Interfaces

26-1192

Colour Ink-Jet Printer
£499 Inc. VAT

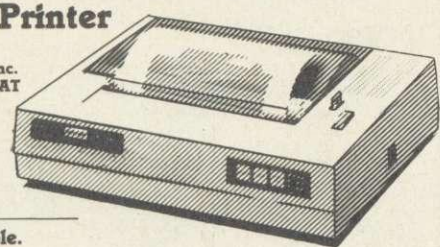

- High-Resolution Ink Jet Printer
- Prints In Seven Vivid Non-Smearing Colours

Model 100 Interface Cable.
 26-1409 £9.95

26-1268

Take A Look At Tandy, Today!

See Our Extensive Range of Microcomputer Accessories At Any One of the 350 Tandy Stores Nationwide!

Prior to this advertisement, all quoted regular prices have been charged during the last six months at the Tandy Store, Tameway Tower, Bridge Street, Walsall, West Midlands WS1 1LA

Known As Radio Shack In The U.S.A. Prices may vary at Dealers Offers Subject to availability

MICROTEK COMPUTER SERVICES

Authorised
acorn  **dealer**

**B.B.C. B & acorn
 electron**

CUMANA disk drives
 DECCACOLOUR & MICROVITEC monitors
 SEIKOSHA, EPSON & DAISYSTEP printers
 ACORNSOFT/MERLE business software
 ACORNSOFT full range

**NEXUS HOUSE
 2 CRAY ROAD
 SIDCUP, KENT
 01 300 3075/6**

ACCESS/BARCLAYCARD WELCOME

"O brother."

A FREE INTERFACE



ABACUS
 BUSINESS MACHINES



**LETTER QUALITY DAISYWHEEL
 PRINTER/TYPEWRITER FROM ONLY
 £299.95 + VAT**

SPECIAL OFFER TO 'BBC B' USERS ONLY

The pedigree of the Brother typewriters & printers needs no help from us but now for the first time we have designed & built an interface that we are offering FREE of charge when you purchase one of the machines listed below.

There are no hidden extras such as cables leads or plugs these are all provided. All you require is a BBC B computer with a spare ROM socket.

FEATURES AS TYPEWRITERS

Brother CE 51, one touch interchangeable daisy wheel
 * Cassette ribbon * All keys repeat * Super & sub script
 * Express return * Auto relocate * Decimal tabulation
 * Impression control * Line indentation * International symbol selector * Auto one line correction * Built in carrying handle
 * Hard cover * Paper width 13.5" * Typing line 11" * Typing pitches 10, 12 & 15 * 46 keys * 96 characters * Line space 1, 1½ 2 * Choice of ribbons & type styles.

Brother CE 60, as per 51, PLUS * Auto carrier return * Auto paper feed * Auto underscore * Ind up & Ind down * Back tabulation * Centering * Right margin flush * Paper support * Glare Proof Acoustic shield.

Brother CE 70, as per 51 & 60, PLUS, * 15 character display * 8K text memory * Previous two line correction * Stop codes * Step keys * Centering between tabs * Auto column layouts * 72 hour battery memory back-up * Proportional spacing * Line space 1, 1½, 2 & 3 * Bidirectional printing in justification from memory.

Typewriters used as printers: All of the above features are available PLUS when using your computer the CE 51 has auto underscore facility.

Special offer starter pack containing 3 fabric ribbons and an Ascii daisy wheel ONLY £25 inc VAT. If you have a Brother CE 51, 60 or 70 and wish to purchase the interface only see below.

ABACUS BUSINESS MACHINES LTD. 961 Christchurch Road, Bournemouth, Dorset. Phone (0202) 423204.

Please send me:

qty	Brother CE 51 typewriters @	£344.94 inc VAT
qty	Brother CE 60 typewriters @	£431.25 inc VAT
qty	Brother CE 70 typewriters @	£672.75 inc VAT
qty	Starter packs @	£25.00 inc VAT
qty	BBC B interfaces (only) @	£75.00 inc VAT
	Post & packing: per typewriter @	£5.00 inc VAT
	Post & packing: S/pack or interface @	£1.50 inc VAT
	No postal charge for interface or S/pack when combined with a typewriter purchase.	

Debit my ACCESS BARCLAY Acc No.

I enclose my cheque No TOTAL

Name

Address

.....

P. code Tel:

Please allow twenty eight days for delivery.

TRADE ENQUIRIES WELCOME

MAKE THE MOST OF YOUR COMPUTER.

INTERFACE PUBLICATIONS

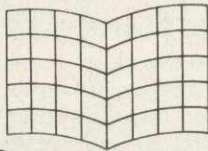

Acclaimed books from the experts . . .

- Dynamic Games for your Electron
Neal Cavalier-Smith. £4.95
- 36 Challenging Games for the BBC Micro
Chris Callender and Tim Rogers. £5.95
- Let Your BBC Micro Teach You to Program
Tim Hartnell. £6.45
- Putting Your BBC Micro to Work (includes a full
word-processing program, plus 14 others)
Chris Callender. £4.95
- Creating Adventure Programs on your Computer
Andrew Nelson. £4.95
- The Easy Way to Program Your New Computer
Tim Hartnell. £3.95
- Practical Applications for the Microcomputer
in the Home.
David Hole. £4.95
- The Art of Structured Programming
Peter Juliff. £5.95

These books are available from most book and computer stores. In case of difficulty, order directly from us.

Interface Publications, Dept. QAU,
9-11 Kensington High Street, London W8 5NP.

Please send me the indicated books. I enclose £ _____

Name _____

Address _____

INTERFACE PUBLICATIONS

We're the Experts.

(TRADE ONLY: Interface Publications are distributed exclusively in the UK and
Ire by W H S Distributors. Export trade handled by Interface Publications.)

EXPANDABLE CONSOLE FOR BBC MICRO

As supplied to Universities, Colleges, Schools,
business & home users

A professional console to house disc drives/2nd processor/Torch dual drives/teletext, etc. All untidy wiring out of sight in the strong aluminium console in a matching textured colour. AVAILABLE NOW a bolt on extra module for extra expansions.

Also available a matching printer stand, yes stack your paper under the printer.

ALSO VDU STANDS AVAILABLE

Torch version available

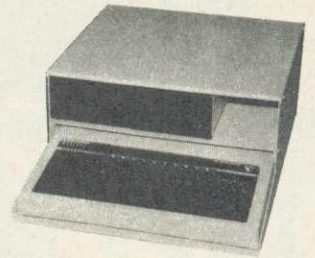

ELECTRON CONSOLES

The console houses the electron and will safely support the expansion interfaces which plug into the rear of the micro, supports the VDU and tidies up all wiring, allows expansion to disc at a later date.

PRICES

Special Torch Version £46.99 + £4 p/p
BBC Console £44.99 + £4 p/p
Bolt on expansion £14.99 + £2 p/p
VDU/Printer Stand £14.99 + £2 p/p
Electron Console £34.99 + £4 p/p

Please add VAT @ 15% to all prices



For further information enclose sae or send cheque to,

Mail Order
Only

Silent 01-801 3014

27 Wycombe Rd
London N17

Viewing by
arrangement

COMPUTERS

24 hour
ansaphone

Please allow 28 days for delivery

The Original "NEWARK" TV/RGB Monitor

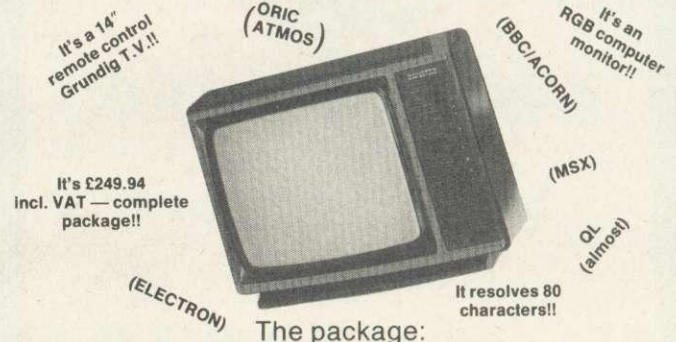

The package:
£249.94 for a remote control 14" TV with a computer lead — delivered to your door — including VAT (we even fit a mains plug!) and carriage.

We have a **Large** range of **Grundig** models from **14" to 26"** with or without Teletext.

Contact Elaine for an up to date leaflet package.

NEWARK VIDEO CENTRE LTD.

108 London Road, Balderton, Newark, Notts.

0636 71475 to order by Access or Visa

Mon-Sat/9 am-6pm

SPECIAL OFFER!
Deduct £1 per cassette when ordering 2 or more.

TOP QUALITY SOFTWARE FOR THE ACORN ELECTRON



PERCY PENGUIN £7.95
The best version available for the Electron micro. Percy is trapped in an ice maze which is populated by the deadly Snobees. His only hope of survival is to squash them by hurling ice cubes at them. Unfortunately, whenever it seems that he has won, a deadlier breed appears. Hi-score, rankings, excellent graphics and sound.
NEW RELEASE

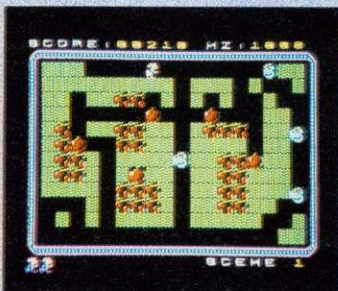

MR. WIZ £7.95
From the author of Percy Penguin, Mr. Wiz is a fast-action multi-scene game. Guide Mr. Wiz around the garden to eat the cherries whilst avoiding the evil gremlins. The gremlins can be killed by dropping apples on them or by throwing the crystal ball. Extra points can be gained by eating the magic mushroom, but beware...this is the home of the gremlins and makes them permanently furious! Sound effects and tunes, hi-score, rankings. Superb arcade-style action.
NEW RELEASE

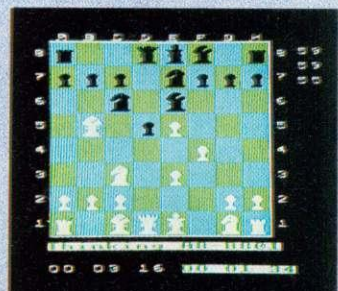

CHES £7.95
A highly versatile implementation of Chess. Play black or white, against the computer or a human opponent. The skill level of the computer's play can be varied widely, and moves are entered either by co-ordinates, cursor control, or joystick control. Moves can be taken back if an error has been made, and the board can be modified at any time. Games can be "saved" or "loaded", and the last game can be replayed. The computer will, if requested, suggest your moves.
NEW RELEASE



CENTIBUG £7.95
The centibug descends from the top of the screen weaving intimidatingly between the mushrooms. Your objective is to shoot all the segments of the centibug before it reaches the bottom of the screen. Features include: spiders, snails, flies, 6 skill levels, hi-score, rankings, and increasing difficulty.



ALIEN DROPOUT £7.95
A novel and unusual program. Arcade-action with this exciting multi-stage shooting game. The objective of the game is to shoot the aliens out of their "boxes" before the "boxes" fill up. Once full, the aliens fly down relentlessly, exploding as they hit the ground. The game features include: 6 skill levels, rankings, hi-score, increasing difficulty.



STRANDED £7.95
An adventure game using hi-resolution full-colour graphics. You are stranded on a strange planet, and your mission is to return to civilisation and home. Many of the locations are shown graphically, including the spaceship, the cliffs, the mountains, and (if you succeed) your home. You must carefully explore your environment searching for hidden clues to help you in your quest.
NEW RELEASE

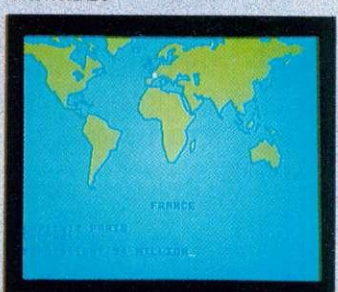

WORLD GEOGRAPHY £7.95
This program covers 166 countries which are divided into 8 categories of difficulty. Each country is pinpointed on an accurate hi-resolution screen map of the world, and the user is asked the capital and/or population. At the end of the test, the percentage of correct answers is given, so that the student can monitor his geographical knowledge.

ALSO AVAILABLE:

INVADERS	£7.95	DISASSEMBLER	£7.95
FRUIT MACHINE	£7.95	DRAUGHTS	£6.95
CONSTELLATION	£7.95	REVERSI	£6.95

DEALERS - Our software is now available at all good dealers including: selected branches of W. H. Smith and Boots; all major computer dealers - Microstyle, Electronequip, 3D Computers, Computerama, GTM Computers, etc.; and our software is also available through all the major distributors, and directly from us.

WE PAY UP TO 20% ROYALTIES FOR HIGH QUALITY BBC MICRO AND ELECTRON PROGRAMS.



SUPERIOR SOFTWARE LTD.
Dept. AU10, Regent House,
Skinner Lane, Leeds 7
Tel: 0532 459453

OUR GUARANTEE

- (1) All our software is available before we advertise.
- (2) All our software is despatched within 48 hours by first-class post.
- (3) In the unlikely event that any of our software fails to load, return your cassette to us and we will immediately send a replacement.

STOP!

IF YOU'RE AN ACORN USER, YOU NEED TO BUY THE BEST!

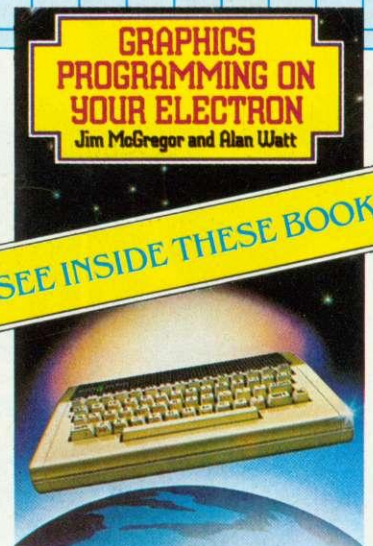
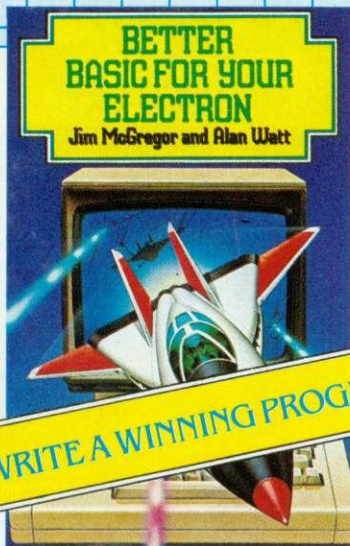

WRITE A WINNING PROGRAM AND WIN VALUABLE PRIZES! SEE INSIDE THESE BOOKS

Energise your Electron

- * A thorough grounding in BASIC.
- * Structured programming techniques.
- * Packed with lots of examples.

Develop your graphic skills to the full

All you need to know to produce:

- * Graphs * diagrams * pictures * 'three-dimensional' displays * plus many other designs.
- * Crammed with practical and challenging exercises.
- * Backed by thought-provoking examples.

MAKE THE MOST OF YOUR MICRO – PUT YOURSELF IN THE PICTURE! WITH THREE NEW BOOKS BY JIM MCGREGOR AND ALAN WATT, AUTHORS WHO STAND "HEAD AND SHOULDERS ABOVE THE REST." (MICRO USER)



CORGI/ADDISON-WESLEY
TOGETHER,
THE NEW FORCE IN COMPUTER BOOK PUBLISHING



All these books are available at your bookshop, though should you find any difficulty in obtaining them, they can be ordered direct from the publisher. Simply fill in the form below.

Please send me

- ___ 99103 1 Better Basic for Your Electron at £4.95 (192 pages)
- ___ 99102 3 Graphics Programming for Your Electron at £4.95 (176 pages)
- ___ 99104 X Graphics Programming for Your BBC Micro at £4.95 (192 pages)

Please allow cost of book(s) plus 30p for one book plus 15p for each additional book for postage and packing.

I enclose my cheque/postal order for £ _____ payable to: TRANSWORLD PUBLISHERS LTD.

(IN BLOCK CAPITALS PLEASE)

Signed _____ Date _____

Name _____

Address _____

Now send to CORGI/ADDISON-WESLEY BOOKS,
61-63 Uxbridge Road, London W5 5SA



(A)

STAR STATUS

Tony Quinn goes boldly to Cambridge on an Elite mission

'Elite', Acornsoft, BBC B, £14.95 (disc £17.95), Electron, £14.95

SPACE is the final frontier as far as Acornsoft is concerned, and the company reckons to have cracked it with the new release, *Elite*.

This game has been the subject of the biggest security operation the company has ever mounted, to ensure no details leaked out before the launch this month. It is still so secret that even I don't have a copy!

Acornsoft spirited half a dozen journalists up to Cambridge and locked them in a room to review the game. So, this is not a full review, but my impressions after bashing away for a couple of hours. However, having written my escape clause, I must say *Elite* looks superb.

Imagine a subtle blending of *Aviator* and *Starship Command*, a sprinkling of the *Star Wars* films, shaken with a trading adventure, served up with some secret ingredients and you have *Elite*.

It sounds ambitious but it's all there, wrapped in a short science fiction novel that sets the scene, a substantial training manual, a poster identifying the foes and friends you are likely to encounter and a postcard giving entry to the competitions that Acornsoft plans to base around the game. Not bad for £15. Plus, the disc is filled out with some special bits and pieces. You'll have to play to find out what they are - I've no idea!

The idea of the game is to start off with a simple space ship and build it and your reputation up to 'Elite' status.

Budding Han Solo's start the game with a sparsely equipped space ship and a small supply of money. The ship is docked in a station orbiting a planet. Pressing various function keys gives information on the planet and enables the raw pilot to buy various goods from food and drink to drugs. Having stocked up, the ship is launched into space and the course set for another planet.

Once a destination has been fixed, the ship goes into hyperspace and after a few seconds emerges near the

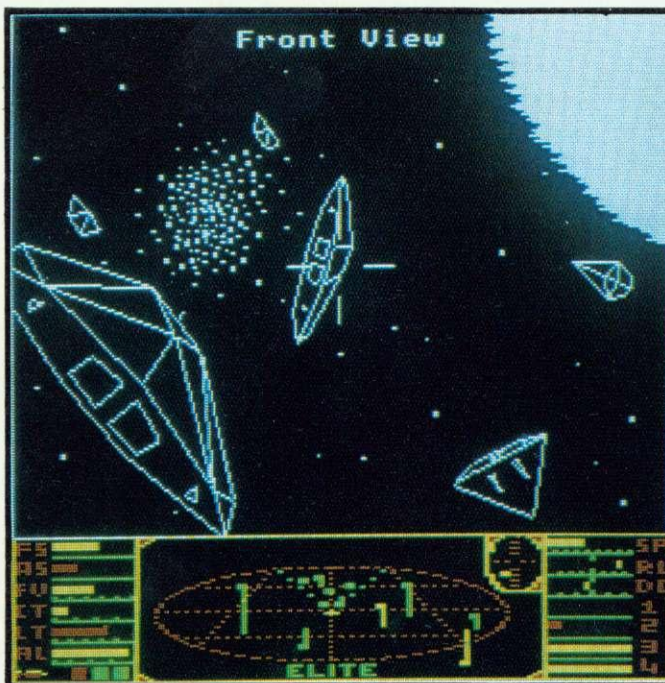

chosen planet. Then it's a dash to reach the orbiting space station before the pirates pounce. The ship has then to be docked by plotting a flightpath along a line leading from the centre of the planet into the station. The entrance is a slit, and the station is rotating, so the ship has to match rotation, otherwise it just won't fit.

Your wares can then be traded, preferably for a profit. Any credits earned can be used to fund the next flight and buy better equipment for the ship.

As you trade and equip the ship until it's bristling with weaponry and everything money can buy, it becomes tempting to play naughty. Illicit cargoes such as slaves and drugs can be bought. You could be in trouble with the law but it's a good way of making a fast buck. Then you can attack space stations for the fun of it, and even try trading with one of the deadlier planets. The risks are high, but so are the profits.

That's the theory, now for the action. The colour screen shot shows a typical view of space, except there are a lot of nasties around. (This shot was specially set up and you are unlikely to meet so many different types of enemy at once.) Views to the front, rear and both side of the ship can be called up.

Instruments at the bottom of the screen give compass, a three-

dimensional map of space and other ships within range, and the status of energy banks and weaponry.

Controlling the ship takes some getting used to, as it's difficult to know where you are and which way to go, especially when someone's shooting at you. The keys are a bit awkward: there are a lot of them, and some are in strange places.

Elite apparently uses up just about every spare byte there is in the Beeb's memory (and some it shouldn't). The graphics impressed even the Cambridge gurus when *Elite*'s two student authors showed them off. Circles and ellipses are drawn in full in real time with hidden line removal. The 3D effects are astounding, and the suns have to be

seen to be believed. Screen graphics modes 4 and 5 are used at the same time to give accurate plotting and colour for the display. Screen width is reduced to speed up plotting and save memory. The reason for the strange keys? Simply because they are next to each other in the operating system's look-up table.

How much work the BBC is doing when plotting the suns and planets is shown as you fly towards them. If you look straight ahead, the game is slowed down! To get there quicker look to the side or behind.

So how do we sum this one up? Well, it's the best game of its type and all *Meteors/Starship Command/Defender/Aviator* freaks will love it. Players who like adventuring might well be hooked by the trading aspects. And then on the disc version there are these things called 'missions' where a task is set. Finally, there's the unknown: no-one has yet reached the ultimate Elite status, and there's even a ship out there that no-one has yet come across. Apparently it eats spaceships, so watch out.

'The 3D effects are astounding'

Simple, reliable, and still the most popular
word processor for the BBC Micro.

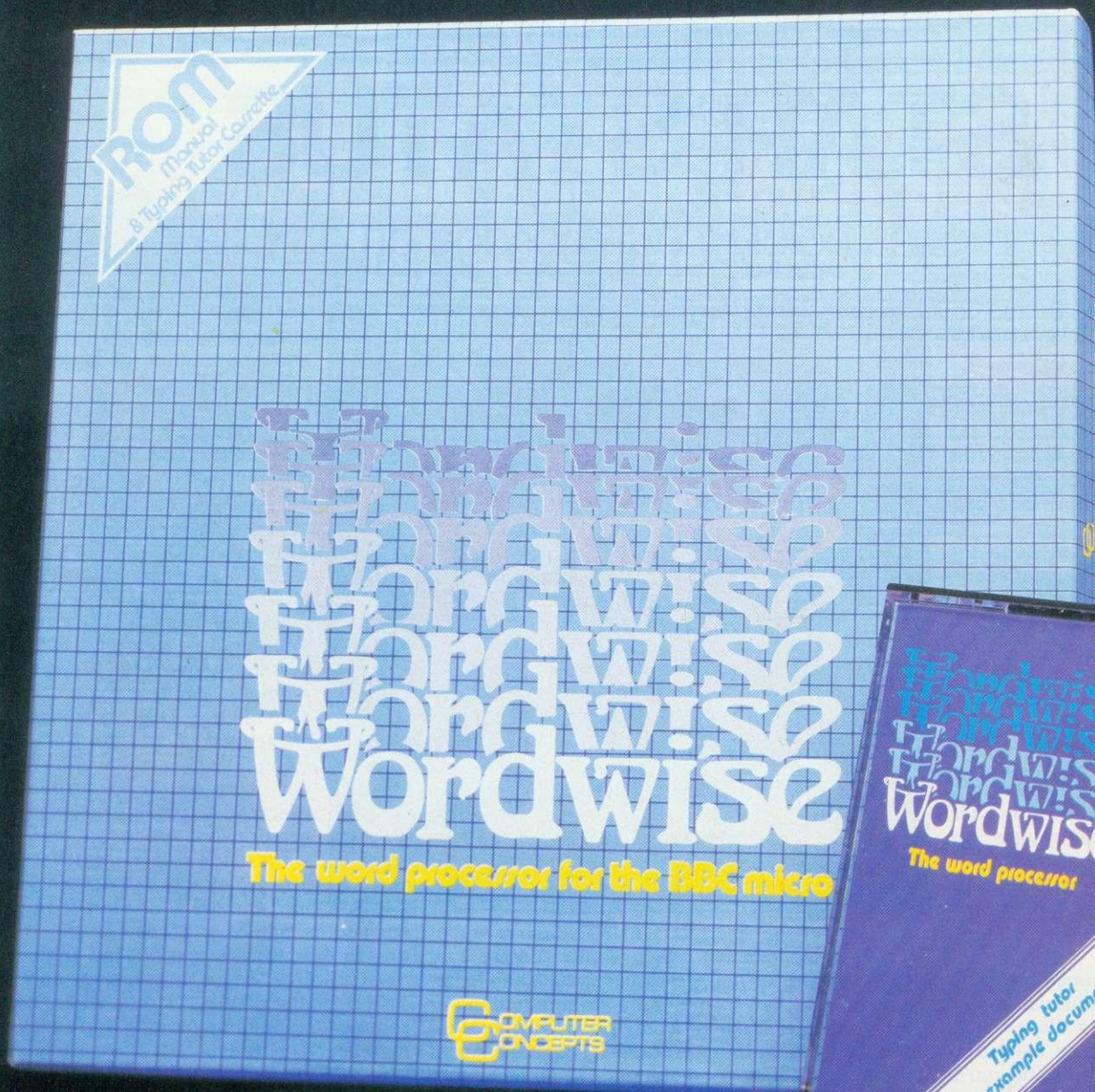

Price **£46**
inc.

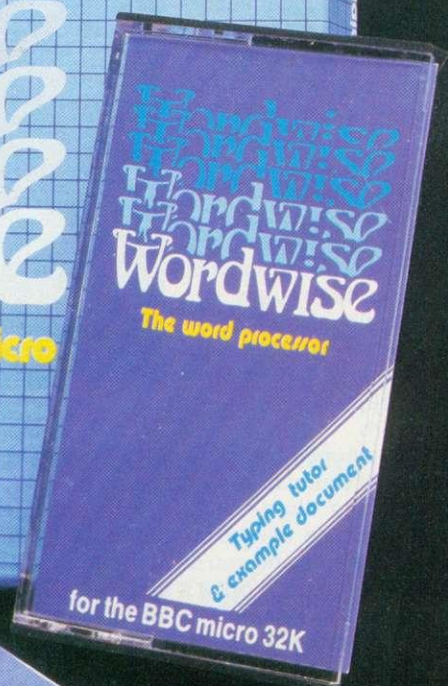

**COMPUTER
CONCEPTS**

Available from all good BBC Computer Dealers.
Available by Mail Order from Computer Concepts, Gaddesden Place, Hemel Hempstead,
Herts HP2 6EX.

Or by 'phoning with your credit card number on (0442) 63933.



SPREAD THE MESSAGE

Bulletin boards offer
real person-to-person
contact, says Jeff
Ashurst. Why not join?

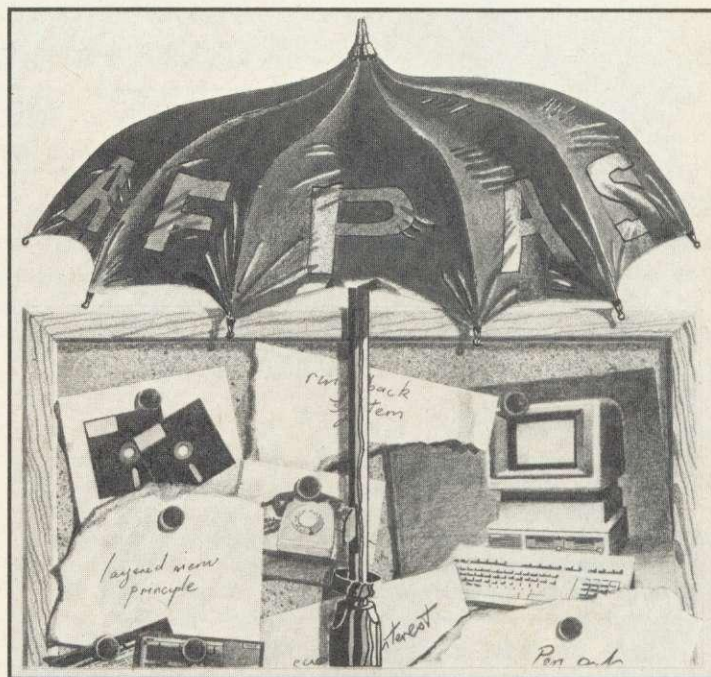

167

BULLETIN boards have been set up by enthusiasts motivated by an interest in microcomputer communications, rather than by commercial gain. True, some BBs are associated with, or sponsored by, small micro businesses, but this aspect is secondary to their main function of providing a way to exchange information. With this aim, the Association of Free Public Access Systems (AFPAS) was founded, and each system operator (SYSOP), with one exception at the time of writing, is a member, under the chairmanship of Fred Brown, SYSOP of Forum 80 in Hull. Incidentally, this was the first microcomputer bulletin board set up in Britain – just look what he started!

Under the umbrella of AFPAS, BB operators have adopted as their standard the V21 transmission protocol of the CCITT (Consultative Committee for International Telegraph and Telephone), which specifies receive and send rates of 300 bits/second, or 300 baud.

Let's assume you're sitting comfortably with your micro, telephone, a V21 modem and some suitable software. You are free to make whatever use you choose of the bulletin boards, from electronic pen pals to serious information exchange. But where are these boards? And which are the best?

Well, the table on page 169 should answer most of your questions. It lists bulletin board systems with their telephone numbers and operating hours and brief comments regarding special interest groups (SIGs) catered for and other points of note. You will notice a few boards with the comment 'ring-back system'. To access these, call the

number, allow the telephone to ring once (ie one double ring), replace the receiver and call again. On the recall, the modem will respond with its high-pitched tone. Then, as with the others, switch your modem to 'on line' or 'data' and replace the handset fairly quickly.

As to what makes a 'good' bulletin board, the answer must be subjective to a degree, but I suggest the following criteria:

- BBC-related information and software.
- Other special interest material.
- On line 24 hours daily.
- Within local call range of your phone.

The last condition cannot always be fulfilled, but should become more and more possible as BBs proliferate. The systems listed are sprinkled from Cumbria to Southampton. I've never heard of any in Scotland, Ireland or Wales, but it's difficult to believe there are none. I've also included a Swedish board specialising in BBC matters.

Systems are coming on line all the time. If anyone knows of, or operates, a board that does not appear in the table, please let me know, either via *Acorn User* or by leaving a message on Liverpool Mailbox.

Roughly half the boards are on line 24 hours per day. The others operate in specific time bands on particular days, which can be restrictive. It is, however, understandable that system operators (and their families) need their telephone line for other uses. Clearly the best solution for BBs is to install a second, dedicated phone line. Even with 24-hour access, however, the better boards are more often than not

engaged, with some SYSOPs reporting around 50 calls on a typical day. You must expect a sore dialling finger!

After logging on with your name and home town, you will find that bulletin boards operate invariably on a 'layered menu' principle. The main menu will allow you to read or enter messages of general interest, but it will also offer access to SIGs, software for downloading and often features such as news, prices of peripherals, electronic mail and information about the system. Electronic mail consists of messages addressed to individuals by name, and is readable only by the recipient (although you can't prevent the SYSOP from having a look).

Software

Communication – questions and answers, information, mutual help – can be achieved using so-called 'dumb terminal' software, that is to say a program which simply outputs characters from your keyboard and displays incoming characters on the screen. Such a routine, by Paul Beverley, was published in *Acorn User* of November 1982. I have also used 'VDUPROG' from Mike James' book *The BBC Micro – An Expert Guide*.

To download the free software available, however, you will require a 'smart' program. The best of these are available as communications ROMs, and are advertised regularly. A good example is Pace's *Commstar*. Using sophisticated firmware of this type it is possible to select the receive and send rates, the word length and parity (see July's issue), and to both upload and download files reliably. A suitable modem enables access to bulletin

**SUPERB
REVIEW!**

AID at last!

Assembler Interactive Debug for the
BBC Micro with DUALSCREEN

**STOP PRESS . . . AID receives
superb review . . . see below**

AID has now established itself as the finest machine code monitor ROM for the BEEB. With its unique DUALSCREEN operation so far in advance of the competition, AID puts unprecedented debugging power into your hands. No other monitor can begin to tackle machine code graphics – something AID takes effortlessly in its stride! Beginner or expert, you cannot afford to be without DUALSCREEN AID.

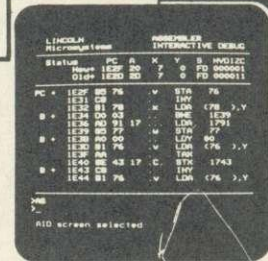

Read what "The Micro User" thinks . . .

“My immediate impression of AID was that it was a very professional product . . . AID offers additional features far in advance of other monitors . . . I found it easy to use, particularly as the user guide is very thorough and accurate . . . I wish I had something like this when I first started dabbling in machine code . . . The last facet I explored was the DUALSCREEN facility, which is perhaps the pearl of the system . . . In conclusion, AID seems a must for the serious machine code programmer and a very useful learning aid for the novice. It is a highly professional product in every way and could prove to be the standard by which others are compared.” *“The Micro User” January 1984*

The most advanced machine code AID for the BBC Micro

**LINCOLN
Microsystems**

P.O. Box 74
Bradford,
W.Yorks. BD6 3RN

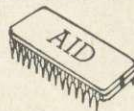

ROM
plus manual
(OS 1.2 required)

£28

p&p add
UK £1.50
Europe £3.00
Outside Europe
£4.50

Increase your fire power!

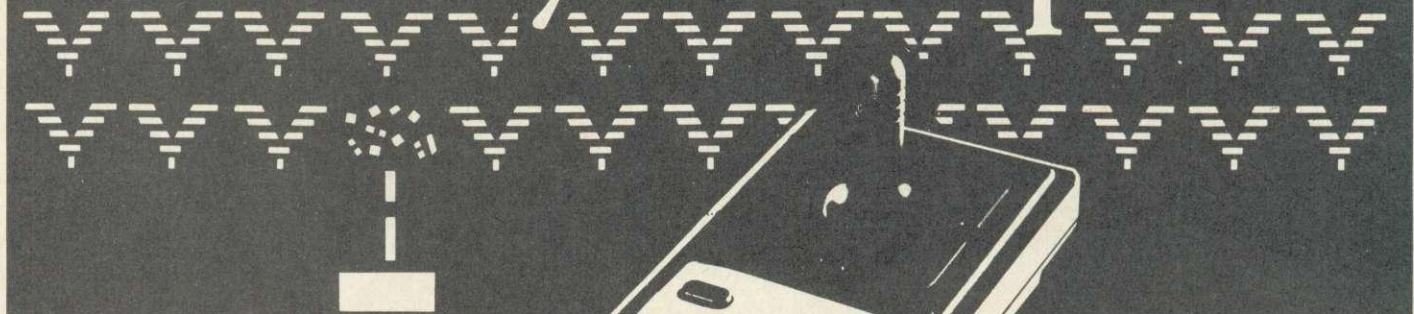

**More than just a joystick
- a system**

- ▲ Nylon encased—Steel shafted joystick with ball and socket joint.
- ▲ Fast sprung return to centre.
- ▲ Graphite wiper linear potentiometers.
- ▲ 12 Months Guarantee.
- ▲ 7 day Money back Guarantee (on Hardware).

DELTA 14b HANDSET £14.95
DELTA 14b/1 A/D/USER PORT INTERFACE £14.85
DELTA DRIVER CASSETTE £5.95 or DISC £9.95
Prices include VAT and P&P. SAE for more detailed information.

VOLTMACE LTD
PARK DRIVE
BALDOCK
HERTS
SG7 6EZ
Tel: (0462) 894410

Numerous stockists
nationwide or direct
from us.



Callers welcome at the
factory—Monday to Friday.

**Complete control
at your fingertips**

A superb joystick and a keypad for the price of either one. Plus the software to integrate it into the computer's system.

One handset will work on it's own in the A/D port as a joystick and two fire buttons. Joystick is immediately compatible with ACORN SOFTWARE and similar software.

The interface joins together the analogue and the user ports to use the full keypads giving a total of 24 user definable keys. The interface can also be used as a splitter for the A/D port to take two items at the same time, e.g. joystick and lightpen.

DELTA DRIVER on cassette or disc: Two programs on each cassette or disc. One converts machine code programs from the keyboard to the joystick or keypad, with adjustable sensitivity on the joystick and will run on any O.S. The second program (needs O.S. 1.0 or later and an interface) duplicates any keyboard keys on the keypads, in the operating system, so that it can become a numeric keypad or will take on the function keys.

Voltmacedelta 14b

INTERESTING BULLETIN BOARDS FOR BBC USERS

NAME	NUMBER	HOURS	COMMENTS
BASUG	(0742) 667983	24 hours daily	Apple user group BB. Ring-back system
BUG	010 468 463 528		Swedish-based English language board for BBC users. (Watch the bills on this one!)
CABB	01-631 3076	24 hours daily	Acorn, Commodore and Sinclair SIGs
CBBS Cumbria	(06992) 314	Daily 1800-2200	Ring-back system. Multi-standard: V21, V23 and Bell 103. Downloading and CP/M SIG
CBBS London	01-399 2136	Sun 1700-2200	
CBBS Surrey	(04862) 25174	24 hours daily	Temporarily off line after lightning strike
CBBS SW	(0626) 890014	24 hours daily	User friendly CBBS board. Popular – usually engaged
Centbull	01-606 4194	24 hours daily	Wednesday 1200/75 protocol. Sirius and Tandy SIGs
Distel	01-679 1888	24 hours daily	Display Electronics board. Very user friendly. News and Product information, including BBC interest section
Estelle	(0279) 443511	Office hours only	STC Electronic Services BB. Also other protocols: ring (0279) 441188 for V22 (1200/1200) or (0279) 441222 for V23 (1200/75)
Forum 80 Hull	(0482) 859169	Mon-Fri 1900-2230; Sat/Sun 1300-2230. Daily 0000-0700	US Bell 103 standard. The first British BB
Forum 80 London	01-902 2546	Evenings and weekends	Telephone and ask for Forum 80
HAM-NET	(0482) 497150		New Hull-based BB specialising in information exchange for radio amateurs
Liverpool Mailbox	051-428 8924	24 hours daily	BBC SIG and download section. Other SIGs include Microwave for radio amateurs. Britain's first 24-hour BB
Mailbox 80 W Midlands	(0384) 635336	1730-0830 Also all day Sun	BBC SIG: Download planned on receipt of sufficient software
Manchester BB	061-427 3711	Sun-Thurs 2230-0000; Fri 2330-0200; Sat 2230-0200	BB under development running on BBC
Maptel	(0702) 552941	Out of office hours	Maplin Electronics board: product information
Microweb	061-456 4157	24 hours daily	BB dedicated to Acorn/BBC matters
NBBBS	(0827) 288810	24 hours daily	N Birmingham. Ring-back system
Rewtel	(0277) 232628		Run by <i>Radio and Electronics World</i> magazine
Southern BBS Stoke ITEC	(0243) 511077 (0782) 265078	Daily 2000-0200	Helpful general interest board CP/M BB, ie when logged on, CP/M commands can be entered directly
TBBS Blandford	(0258) 54494	24 hours daily	BB SIG. Hopes to have full menu of BBC related items at future date
TBBS London	01-348 9400	24 hours daily	BBC SIG and download section
TBBS Nottingham	(0602) 289783	See comments	To start in near future, with V21 (300/300) and V23 (1200/75) protocols and Prestel-type graphics
TBBS Southampton	(0703) 437200	24 hours daily	

ESSENTIAL EQUIPMENT FOR THE REGISTERED BULLETIN BOARD USER

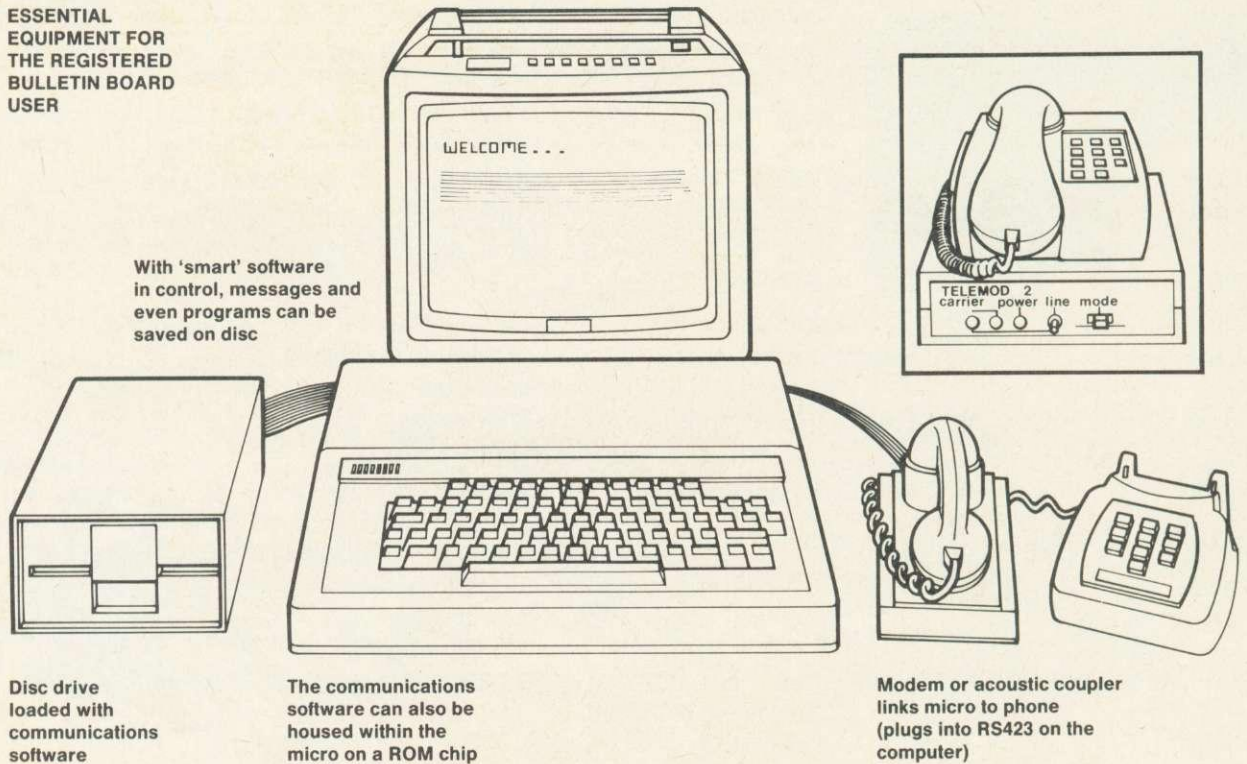

boards, Prestel or even allows your micro to emulate a specific mainframe terminal. Smart software also allows you to compose messages in advance, dial the BB number, upload to the board, download any messages and log off. Messages can then be studied at leisure, or saved to tape or disc, without running up a phone bill.

Once you've logged on, selecting 'SIG' from the main menu will produce a sub-menu of special interest groups, such as BBC, Commodore, Tandy, etc. This is where you will find questions, answers and information on the specific topic selected. BBC owners seem to be quite widely catered for, but remember, the success of a SIG, and of the board in general, depends upon the input. So write. Ask a question. Leave a message. Questions produce answers which, in turn, generate further comments. The more you put in, the more you get out.

Hardware

Looking at modems, several manufacturers are now marketing products built around the AM7910 chip, which offer the facility of switching between not only CCITT V21 (300/300) and V23 (1200/75) standards but also the US Bell 103 standard. The Bell standard specifies 300 bits/second transmission but at different frequencies to V21. These

switchable modems are really superior to single standard devices, and obviate the need to place oneself in one camp or the other, bulletin boards or Prestel, when buying. As yet there is a price premium, but I expect costs to fall.

The future

To date, most of the successful software packages to run bulletin board systems, including TBBS, CBBS and Forum 80, have been written for Tandy machines. Historically, this is because the BB idea was imported from the US, and the Tandy micros have proved to be popular American workhorses.

Now, however, people are developing BB programs to run on the Beeb, and some of these should find their way to the market place, either as software offerings or software/hardware packages. Torch is already moving in this direction with a modem and software combination giving access to Prestel (August issue).

The last hurdles are now falling, and the field should soon be wide open, in terms of choice, to individuals and organisations who want to operate a BBC-based host system. Incidentally, further information on AFPAS can be obtained from Fred Brown at 421 Endike Lane, Hull HU6 8AG – but *please* don't forget a sae.

Under the auspices of the govern-

ment's Micro-electronics Education Programme (MEP), consideration is being given to a BB system for schools – Joe Telford, in July's issue, mentioned CECCTEL, the experimental service for schools in Cleveland. This system is hosted by a BBC micro.

The concept of a board with a specific aim gives, I think, a pointer to the way the bulletin board phenomenon will develop, ie with an increasing amount of specialisation. At present we have two dozen boards in the UK, all broadly aimed at the serious hobbyist. Given many times that number, I expect to see some systems carrying information relating to specific interest groups. Probably the first example of this is the new HAM-NET board in Hull (see table). In the US, with several thousand systems, there is even a bulletin board carrying details and telephone numbers of bulletin boards!

In conclusion, I must say to new and prospective modem owners that I hope you find as much satisfaction in communications as I do. Old hands will know what I'm talking about already. Bulletin boards occupy a special place in this expanding dimension of micro-computing. Yes, we need viewdata for share prices, flight times, weather forecasts and the rest, but to exchange information with real people is a much more rewarding idea.

FOUR AFFORDABLE CHRISTMAS PRESENTS FROM DRG... AND WHERE TO GET THEM.

STAND 949
US 01
COMPEC

If you want a really outstanding deal on a graphics printer, get along to your local DRG dealer or contact us direct today.

Because right now our dealers can show you four Seikosha dot-matrix, centronics parallel printers whose speed, features, ruggedness and affordability are quite exceptional.

They include the amazing GP700A: the first full-colour matrix printer ever offered at under £350.

They're compatible with most makes of micro - including the BBC and the Spectrum.

And with 34 dealers nationwide, you shouldn't have to go too far to find them.

If you're not near a dealer you can order direct from us - just contact Pat Kelly on 0934 416392.

SEIKOSHA GP500A

Takes pin-fed paper up to 10" wide. 50 cps print speed. **£175.00**

SEIKOSHA DEALERS:

ENGLAND

BEDFORDSHIRE Bedford: Bedford Computers. (0234) 215015.

BUCKINGHAMSHIRE High Wycombe: Kingsley Computers. (0494) 449749.

CHESHIRE Frodsham: Northern Computers. (0928) 35110.

CUMBRIA Carlisle: The Computer Shop. (Carlisle) Ltd. (0228) 27710.

DEVON Exeter: Devon Computers Ltd. (0392) 218401.

DORSET Poole: Densham Computers Ltd. (0202) 737493.

DURHAM Darlington: Darlington Computer Shop. (0325) 487478.

ESSEX Harlow: Akhter Instruments. (0279) 443521.

GLOUCESTERSHIRE Cheltenham: The Screen Scene. (0242) 528979.

HAMPSHIRE Portsmouth: Advanced Digital Services. (0705) 823825.

HERTFORDSHIRE Watford: Computer Plus. (0923) 33927.

HUMBERSIDE Hull: The Computer Centre. (Humberside) Ltd. (0482) 26297.

LANCASHIRE Burnley: IMO Computer Centre. (0282) 57411/54299.
Lancaster: Castle Computers. (0524) 61133.

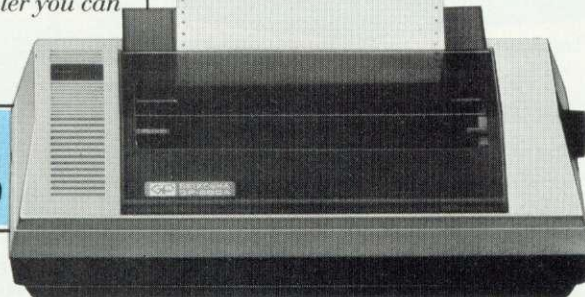

LONDON W.1: Specialist Computer Centre Ltd. 01-935 4150.

Eltham: The Advanced Technology Centre. 01-859 7696.

LINCOLNSHIRE Grantham: Oakleaf Computers. (0476) 76994.

MANCHESTER Sunlock Electronics Services Ltd. 061-834 4233.

MERSEYSIDE Liverpool: Specialist Computer Centre Ltd. 051-236 3499.

NORFOLK Norwich: Sunlock Bondain. (0603) 617083.

NOTTINGHAMSHIRE Nottingham: Computer Market. (0602) 556454.

SALOP Telford: Computer Village. (0952) 506771.

STAFFORDSHIRE Stoke-on-Trent: Computer Cabin. (0782) 636911.

SURREY Croydon: Visionstore Ltd. 01-681 7539.

Kingston-upon-Thames: Visionstore Ltd. 01-546 8974.

SEIKOSHA GP550A

Multi-mode printing (including correspondence-quality) at up to 50 cps. Takes pin-fed or friction fed paper up to 10" wide. **£229.95**

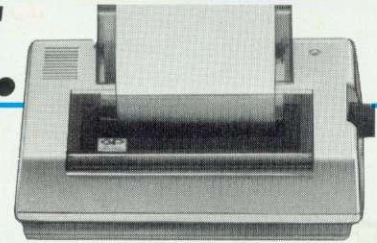

SEIKOSHA GP50A

Takes paper up to 5" wide. 40 cps print speed. A separate version, the GP50S is available for the Spectrum. **£99.95**

SUSSEX Worthing: Worthing Computer Centre. (0903) 210861.

TYNE AND WEAR Gateshead: H.C.C.S. Associates Ltd. (0632) 821924.

WEST MIDLANDS Birmingham: Specialist Computer Centre Ltd. 021-643 4743.
Coventry: Coventry Micros. (0203) 58942.

WEST YORKSHIRE Bradford: Eltec Computers. (0274) 722512.
Leeds: Microcell. (0532) 449722.

WILTSHIRE Trowbridge: Trowbridge Computer Shack. (02214) 57299.

SCOTLAND

GLASGOW Exchange Computers Ltd. 041-424 4242

WALES

CLWYD Abergelge: Abergelge Computer Centre. (0745) 826234.

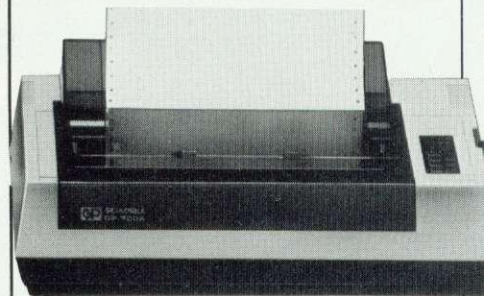

SEIKOSHA GP700A

Gives excellent colour printout in 7 colours and 30 shades in one pass, on pin or friction-fed paper up to 10" wide. Prints text at up to 50 cps. **£349.95**

Please send me more information and an order form for:

GP50A 50S 500A 550A 700A

Name _____

Address _____

Postcode _____



AUS

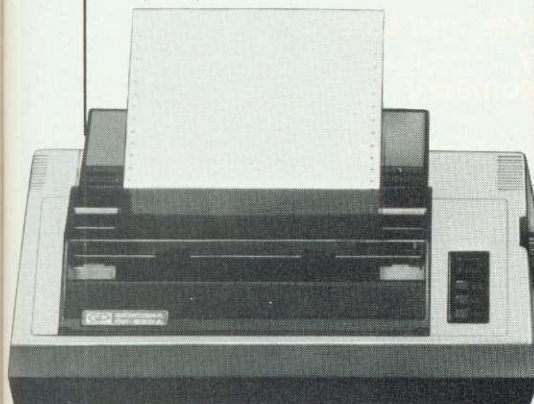

SEIKOSHA DRG

DRG Business Systems, Dealer Division, 13/14 Lynx Crescent, Winterstoke Rd, Weston-Super-Mare BS24 9DN. Tel: 0934 416392. Telex: 444761.

If you're studying... Study our Software

We've been producing educational software for the BBC micro ever since it was launched, and our programs are in use in schools and colleges all over the country. Now, some of these programs have been specially adapted for you to use at home.

With our **Understanding Science** programs you can get to grips with subjects in Biology, Physics or Chemistry that you didn't understand, or supplement your practical work by doing simulated experiments on the computer. These programs are suitable for age 13+ and are ideal if you are studying for those all-important exams. The emphasis is on **understanding** the subject and the programs come with a detailed explanatory booklet. The first programs are ready now —

with many more to follow.

Chemistry — Symbols, Formulae and Valency

Chemistry — Chemical Equations

Chemistry — Inorganic Analysis and Identification of Gases

Physics — The Oscilloscope and Waveform Analysis

The Human Body — Heart and Kidney

Each package costs £12.95 (cassette) or £13.50 (disc).

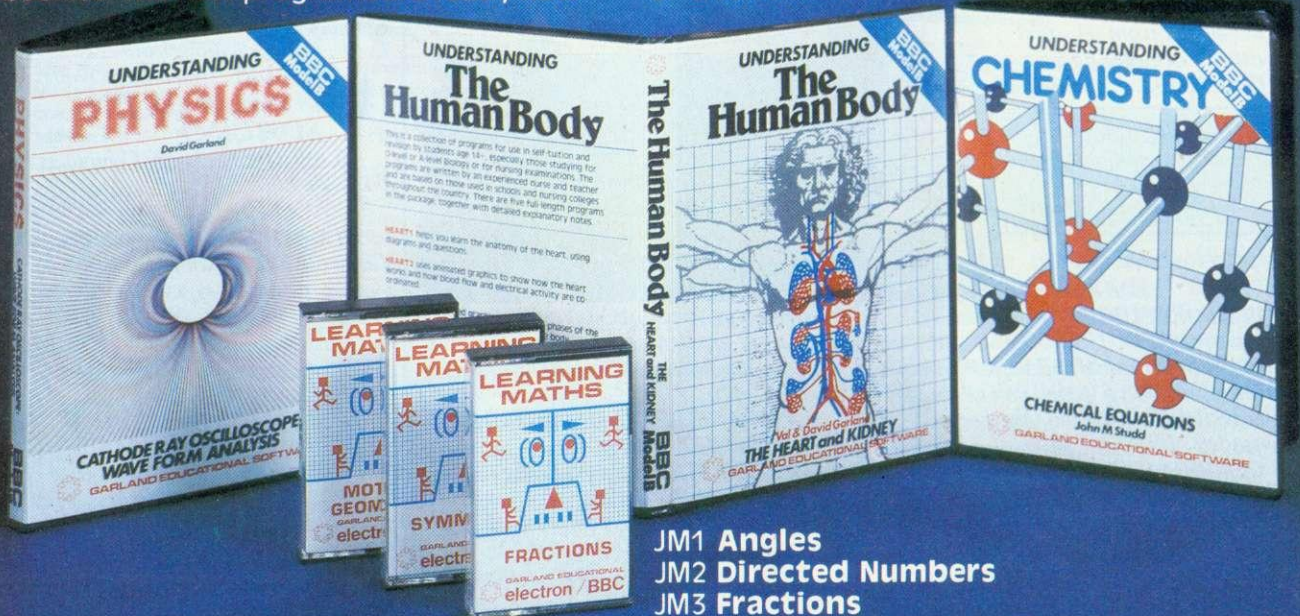

For younger pupils age 9+, our **Learning Maths** programs use simple games and animations to illustrate important principles of elementary Maths. There are nine titles — each containing three or more programs covering a particular concept. The programs are great fun to use — as well as providing real educational value.

Nine cassettes are available*

- JM1 Angles
- JM2 Directed Numbers
- JM3 Fractions
- JM4 Co-ordinates and Lines
- JM5 Symmetry
- JM6 Motion Geometry
- JM7 Sets
- JM8 Elementary Statistics
- JM9 Ratio

Each cassette costs £7.00. Disc collections also available (JM1-6, £30.00; JM7-9 £18.00)

*Electron versions of programs JM1-9 and Dragon versions of JM1-6 also available.

Available by direct mail order, or from selected software dealers.
Prices include VAT and P&P (in UK).

Please send for our full catalogue of over Fifty Educational Programs

Garland Computing 35 Dean Hill, Plymouth PL9 9AF. Tel: (0752) 41287



ROUTE OF

ALL EVIL

'Blogger', Alligata Software, 178 West Street, Sheffield S1 4ET, £7.95

FOR too long the air at computer clubs has been filled with the insane rantings of the owners of certain other (48k) micros about the Beeb's incapacity to play M---c M---r and J-t S-t W---y. Well, now we have at least a first layer of defence in the form of *Blogger*.

The scene is set with a red-haired robber, a 'blogger', working his way through a number of different shops, collecting five keys in each (left in increasingly awkward corners) and taking them to open a safe. At the end of 20 screens - if he ever gets that far - he finally escapes.

The game uses the top half of a mode

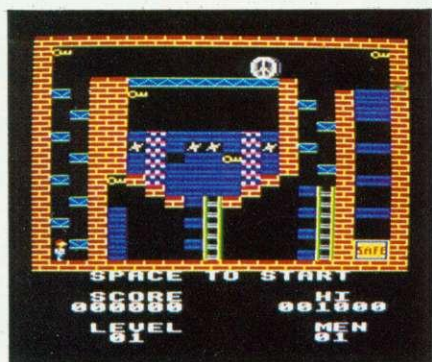

2 screen to show the shop interiors, which contain an assortment of platforms, walls, conveyors, and disappearing ledges. Each screen is a complex arrangement of these features and a good deal of thought is required to work out a successful route. At each level, a number of well-animated sprites parade up and down or to and fro. These are fatal to the touch, as are the bushes which are dotted around the place. The bottom half of the screen shows your score, level, number of men etc.

The sound effects are fairly basic and can't be turned off, but they didn't prove too grating during play.

A rather more annoying oversight is the lack of an option to start the game at any level. I suppose this should mean that the game will last longer before being solved, but it is aggravating to have to complete the easy levels on each attempt before getting to the one you're working on. A practice mode would be very useful.

Nevertheless, *Blogger* is an entertaining game with smoothly animated graphics and plenty of variety. I confess to not having proceeded very far, but

then there's no history of blagging in the family and I've been trying to go straight, honest guv! **Simon Williams**

JOCKEYING

FOR POSITION

'Horse Race', Dynabyte Software, BBC B (32k) and Electron, £6.95

YOU are given £1,000 which you must bet on up to six horses to try to bust the bookies. The computer gives you named horses and their odds, and you may put up to £999 on each one. You then see the six horses raced across the screen.

The graphics in *Horse Race* are superb - the animals are drawn in detail and their movement depicted correctly. You can see their tails move, and all the detail on the jockeys. Two stands are displayed and a commentary board shows which horses have been bet on and which one is in the lead. The game displays people near the ropes waving, flags flapping on the stands, and a very detailed camera car driving alongside the runners.

The sound too is superb. It plays a different tune while loading, before betting, and before and after each race. You can even hear the hooves of the horses and the thud of jockeys falling off.

You select a game for between one and six players, and the number of races to be run. There's no sound on or off option, but surely nobody would want to turn off such good sound effects.

Horse Race is user-friendly and supplied with excellent instructions.

It's repetitive in that it's the same thing every race, only the names and odds change, and it's also boring playing by yourself because there's no skill to it: you place your bet, sit back and the computer does the rest.

When playing with many people, though, it can become quite exciting.

Ian Brettell

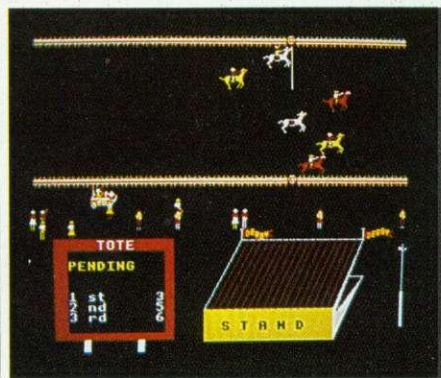

HUSTLER AT

THE KEYBOARD

'Pool', Dynabyte Software, BBC B (32k) and Electron, £7.95

THIS version follows the same rules as real pool, except that there are only three balls of each type. There are versions for the BBC and the Electron and they differ in that the latter doesn't play a tune while loading and the music at the start is played on only one channel instead of the Beeb's three. The Electron version also lacks the extra effects obtained in mode 7.

The sound is good on the Beeb. As well as the 'loading' tune, the computer plays *The Entertainer* at the start of the game and at the completion of each frame.

During play, however, sound is scarce, just short beeps when balls collide and two low beeps for a foul shot. It would have been nice to have an effect for potting, and perhaps a tune playing in the background.

The graphics are reasonable. There are eight large balls on the table: one



cue ball, one black, three red and three outlined red balls, which move very smoothly.

You are offered the options of sound on or off and the number of frames to be played. It would have been an advantage to have a joystick option as well.

The control of *Pool* is easy and responsive. Each player has four direction keys and a shoot key. The length of the cue determines the strength of the shot.

Would it be asking too much to have a topspin and backspin option as well as the ordinary shot included?

Overall, *Pool* is a good game, with acceptable graphics and good sound effects (apart from during play), and it is supplied with excellent instructions. A nice feature is that it displays what you did wrong, eg, 'White ball down'. A drawback is that for people using TVs the red outlined balls and the cue don't show up on the green table. **Ian Brettell**

A World Of Information

Available to you with Nightingale, the new multi-function modem from Pace.

Nightingale is by far the most versatile modem available, at the price, for either home or business use. It offers Prestel/Viewdata baud rates (1200/75 & 75/1200) alongside 300/300 baud full duplex for communication between the BBC and other computers, including bulletin boards.

Nightingale will operate at both European and Bell frequencies for compatibility with CCITT and American systems.

The state-of-the-art modem chip technology employed in Nightingale requires minimal support circuitry resulting in low power consumption, low cost, high quality and extreme reliability.

Nightingale being 'hard wired' is not subject to the noise interference errors common to outdated acoustically coupled devices. In addition Nightingale features a simple self test facility for easy installation.

Nightingale utilises a fully buffered RS 423/232 serial interface and is supplied complete with a lead suitable for connection to the BBC micro, other leads are available on request.

However, in order to use such a versatile modem to its fullest potential, you will require equally sophisticated software. This is where Pace can offer you a total solution — Commstar, unquestionably the most comprehensive communications software available for the BBC.

Supplied on Eprom, Commstar is instantly accessible, simple to use and extremely flexible. Just look at the possibilities:— access Prestel, Micronet, Viewfax, Homelink and Telecom Gold, rummage through bulletin boards and chat to literally thousands of other computer users, but there's more. Commstar can be used to emulate specific terminal types such as VT 100 by means of a configuration disc, thus providing the opportunity to use the BBC as an inexpensive workstation for a main frame or mini-computer.

The complete Nightingale/Commstar package for the BBC micro including the modem, cabling and the Commstar Eprom and manual is just £139 plus V.A.T. Nightingale is available separately for the BBC and other computers at £119 plus V.A.T. and Commstar is £29.57 plus V.A.T. Further details are available, please telephone or write for comprehensive fact sheets.



PACE

PACE SOFTWARE LTD.
92 NEW CROSS STREET,
BRADFORD BD5 8BS.
Tel. (0274) 729306 Telex 51564

This modem incorporates the very latest in communication technology and is therefore not yet B.A.B.T. approved.



LAYING THE FOUNDATIONS

'Chickaroo' by John Cassar, Screenplay,
BBC B, £7.95

THIS is an educational game for up to four players, designed to improve a child's word recognition.

A word is displayed at the top of the screen with one letter missing. A chicken then hops along the screen laying six eggs, which begin to move about. The child must shoot an egg, which reveals a letter. If the child thinks the letter fits into the gap in the incomplete word he presses return. Otherwise he continues shooting.

If the child gets the letter correct, a small bird flies up and takes the letter down.

Chickaroo comes with two files, each



containing 50 words, and a parent or teacher may enter up to 50 of his/her own words, which may be saved.

The graphics are reasonable and do their job (they don't need to be too elaborate) and are smooth, though for some reason the small bird is flickery.

Some kind of sound effect is to be heard all the time except during the instruction session at the beginning: when the eggs are moving, on reaching 200 points, firing, successfully shooting an egg, little bird flying, Chickaroo hopping, and getting an answer right and wrong.

Up to four players can play, and you are allowed to load and save files. The game is controlled from three keys and

I found they were occasionally slow to respond. A joystick option would have helped the younger child, who might well get the keys mixed up.

Chickaroo is a good educational program. It's a bit like space invaders, making the learning process fun. Good graphics and sound add to its quality.

Ian Brettell

FIVE-STAR

TRADING POST

'Star Trader', First Byte Software, BBC
(32k), £7.95

THE object of *Star Trader* is for you, as commander of an expedition starship, to explore the five star systems and their planets, trade with the inhabitants, and mine the area. If any planet is inhabited, you must persuade the population to join the Empire.

You must seek out the Ultimate Computer, as your planet needs its resources.

A corner of the screen displays the five 'single character' star systems. You must move your 'block' or space ship over the system, then press 'V' for visit. The screen flashes, and you then have the system's many planets to orbit, explore, mine, and do trade with. These are just different-sized dots.

The rest of the screen is divided into three sections. One of these shows your status, fuel, time, food, water and air; another is your inventory, showing your trade; and the third displays details of the planet you're currently orbiting, its temperature, atmosphere, population type, attitude, water, food,

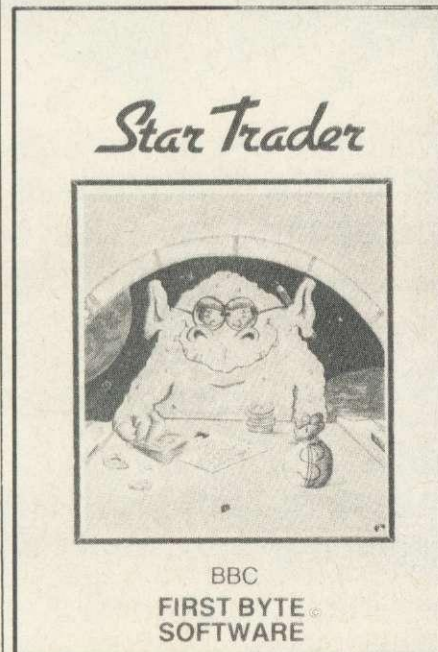

fuel and minerals.

Sound is scarce. Beeps accompany the movement of your ship, and there's an effect for visiting and leaving planets.

Star Trader seems similar to *Star Trek* and *Galaxy*. It's slow and boring with hardly any variation—the process is the same for each planet.

You may load and save games, and you are given very clear instructions, demonstrating each part of the display.

Ian Brettell

FLUSHED

WITH SUCCESS

'Corporate Climber', Dynabyte Software,
BBC and Electron, £7.95

IN THIS game you're an office tea boy whose aim in life is to rise through power and become company president, having a key to the washroom. On your way you have to watch out for taxmen in the lifts, and make sure the strain and stress doesn't raise your blood pressure too high, resulting in a heart attack.

Various objects are scattered about on your way.

You are represented as a little man with a cap, and it looks as though he is carrying a tray. You can see the office building, marked off in stages, with a toilet at the top, marked vacant.

There are lifts going up and down, with taxmen aboard—and they kill you! Bonus objects include telephones, cups of tea, acorns, keys, chairs and suitcases, all shown in good detail, with colour well-used. The lifts move very quickly and can sometimes be a bit flickery.

A pleasant tune plays all through the game, and the only other sound effect is a ping, for when you rise up a level, and for collecting objects. There's an option for sound on or off, three levels of difficulty, but no joystick option.

Corporate Climber is a good, original game, with good sound and visuals, and it comes with adequate instructions.

I reviewed an Electron version on a BBC and found it fast and a little too hard. The speed probably accounts for the flickering graphics. On an Electron the game is much slower and I cleared the first screen first time, whereas I've never managed this on a BBC.

Ian Brettell

More games reviews on
pages 179 and 182

CHASE DATA

PRICES SENSATION

Canon 110: Case/Cables all INCL £99

Canon 220: 400K (40/80 switching)

Case/Cables all INCL £169

N.B. These are state of the Art Disc Drives; Direct Drive
40 track 6mms Access/80 track 3ms Access.

DFS Kits available
ex stock
all inclusive price £109

SLIM CANON DISC DRIVES:

MODEL:	SPECIFICATION OF EACH DRIVE
110	S/SIDED 40 TRACK 100K
210	D/SIDED 40 TRACK 200K
220	D/SIDED 80 TRACK 400K (40/80 TRACK SWITCHING)

■ All **CANON** 40/80 switchable disc drives feature an on-board dual-colour LED on the front panel to show track mode selected. This is coupled with our own unique two-stage illumination, to give a clear operating status, as follows:

40 TRACK MODE: _____ LED GREEN

80 TRACK MODE: _____ LED RED

POWER ON: _____ HALF-ILLUMINATION (GREEN OR RED)

DRIVE SELECTED _____ FULL-ILLUMINATION (GREEN OR RED)

■ Super-slim **CANON** drives, models 211 and 221 and the **SANYO** model 596D, are available with their own **custom-built secondary switching power supply**. This is safe, low in heat generation and excellent value for money.

■ The **SANYO** disc drive is our latest acquisition in quality Japanese products. This is a "half-height" unit of standard dimensions.

ALTD DISC DRIVES

**FOR THE
BBC
MICRO**

SLIM SANYO DISC DRIVES:

MODEL: SPECIFICATION OF EACH DRIVE
596D D/SIDED 40/80 TRACK 400K

SUPER-SLIM CANON DISC DRIVES:

MODEL: SPECIFICATION OF EACH DRIVE
211 D/SIDED 40 TRACK 200K
221 D/SIDED 80 TRACK 400K
(40/80 TRACK SWITCHING)

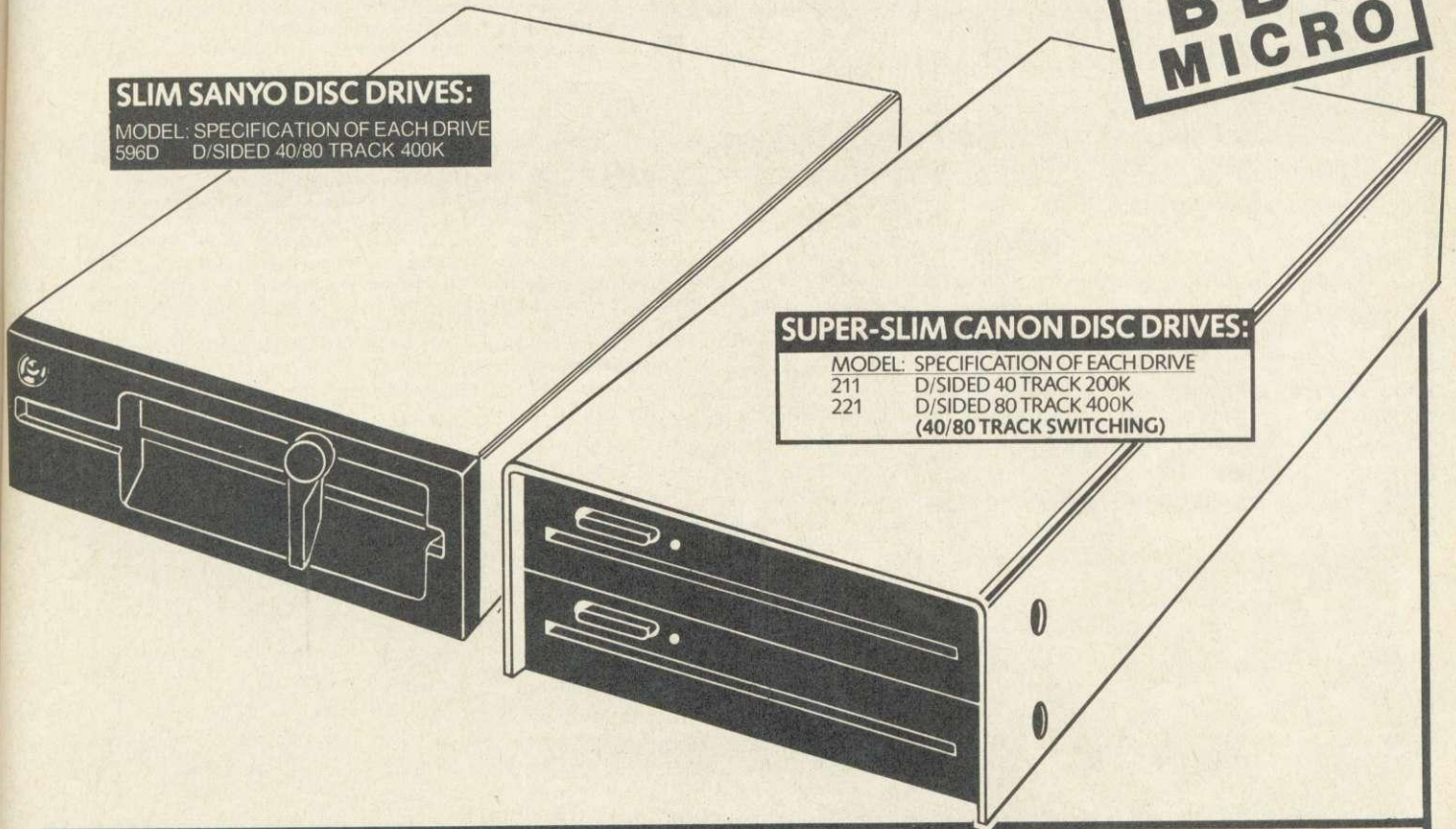

All inclusive price list:

This means: disc drive + case + all power & data cables + U.K. carriage + utilities disc & manual + V.A.T.

	CANON					SANYO
MODEL:	110	210	220	211	221	596D
Formatted Capacity per drive on BBC Micro:	100k	200k	400k	200k	400k	400K
Single Drive & Case:	£99	£139	£169	£179	£236	£182
Single Drive & Case/P. Supply:	£124	£164	£194	£209	£266	£212
Dual Drive & Case:	£204	£274	£314	£329	£437	£368
Dual Drive & Case/P. Supply:	£229	£299	£339	£359	£467	£398

Support:

Warranty: All disc drives sold by Chase Data Ltd. come with a full one-year warranty on parts & labour.

Non-warranty service: As THE experts in our field we can offer service on most makes of floppy disc drive.

Recalibration & Alignment ... £25 per unit inc. VAT. (parts extra). Phone for details: (Tel: 0784 38487)

Payment



By Post: Send your remittance (cheques only please) with your order to:

CHASE DATA LTD

P.O. Box 6, Woking, Surrey, GU21 4PB.

By Phone:  (Tel: 0784 38487).

Home Computers can Cater for Cooks

NEW! "COMP-u-CATER"

—takes the calculating out of cooking

SIX ITEM MENU SELECTIONS plus
QUANTITIES FOR REQUIRED SERVINGS

400 INGREDIENT DATABASE plus
COMPREHENSIVE USER MANUAL

COLLATED SHOPPING LIST plus
AMENDMENT BEFORE PRINTING

RECIPE MODIFICATION plus
EASY ENTRY OF YOUR OWN

PRINTED TABLE MENUS plus
PRINTED SCALED RECIPES

OVER 200 RECIPES plus INGREDIENT QUANTITIES
RANDOM ACCESS FILES

"COMP-u-CATER" full menu planner 40T disc £24.95*

"WHAT'S TO EAT?" simple menu planner cass. £9.95*

"WHAT'S TO EAT?" teaching pack 40T disc £17.45*

also NEW!

"PRINTER DRIVER" JUKI 6100 with view
40T disc £10.00*

*ADD 50p p. & p. (overseas deduct 15% VAT add £1 p. & p.)

SHUMWARI ASSOCIATES

(Dept. B)

12 Marlin Court, Marlow, Bucks. SL7 2AJ

DUCKWORTH HOME COMPUTING

EXPLORING ADVENTURES ON THE BBC MODEL B

by Peter Gerrard £6.95

This is a complete look at the fabulous world of Adventure Games for the BBC Computer. Starting with an introduction to adventures, and their early history, it takes you gently through the basic programming necessary on the BBC before you can start writing your own games.

Inputting information, room mapping, movement, vocabulary - everything required to write an adventure game is explored in detail. There follow a number of adventure scenarios, just to get you started, and finally three complete listings written specially for the BBC, which will send you off into wonderful worlds where almost anything can happen.

The three games listed in this book are available on one cassette.

EXPLORING ADVENTURES ON THE ELECTRON

As above but for the Electron. £6.95

BBC PROGRAMS I

Edited by Nick Hampshire

This book provides you with a range of useful and exciting programs for the BBC Micro. Games, utilities, graphics and functional programs are covered. The games include an exciting version of Star Trek, a full length adventure game, Space Invaders, Battleships, Space Blaster, Brick Basher, and many others. Among the functional programs is a personal information retrieval package which enables you to create and manipulate up to 365 records. This is a basic book for every user of the BBC Micro.

Written by Carl Graham and edited by Nick Hampshire, publisher of *Commodore Computing International*. £6.95

Write in for a catalogue.



DUCKWORTH

The Old Piano Factory, 43 Gloucester Crescent, London NW1 7DY
Tel: 01-485 3484

Programmers make learning entertaining

We at Acornsoft have developed a wide range of educational programs for the BBC Microcomputer and the software-compatible Acorn Electron.

This opportunity, in our home education team, demands excellent, proven experience using BBC BASIC and machine code over a wide range of applications. A background in education or a talent with graphics would be especially relevant as initial projects to be tackled include adventure games, animated graphics/text work.

If you would like to join one of the leaders in microcomputer technology, where flexibility and novel techniques ensure total involvement and real job satisfaction, write today giving brief personal and career details to:

Peter Charlton
Personnel Officer
Acorn Computers Limited
Fulbourn Road
Cherry Hinton
Cambridge CB1 4JN

ACORN^{SOFT}

SEVENTH

HEAVEN

'SUPER-7' compendium, DACC, BBC, £8.95

SEVEN games on one tape? They can't be any good!

That was my initial reaction. But they can be good. None of them is of the standard of the real bestsellers, but they are good value if you want a change, and two of them seem pretty original.

I had never seen anything quite like *Fire Chief*, in which you rescue people from tall buildings, and put out fires. The aim is to deal with as many fires as you can without running out of fuel or water. A really good game requiring

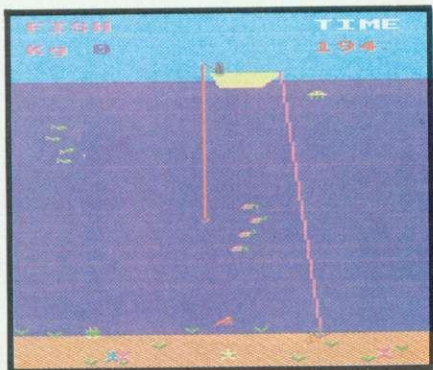

speed of thought and reaction, and forward planning.

Creatures of the Deep has you sitting in a boat fishing. Simple controls allow you only to raise and lower your line. The aim is to catch fish by reeling them into the boat. You must avoid the various monsters, or if you catch them by mistake you must remove them from your line by the appropriate method. You fish against the clock, and your catch is given in kilograms.

The other games are less original but still attractive, all with good graphics. They are:

Space Rescue—a two-screen game, with an easy first screen, and then a second screen in which you have to pick up men from the planet surface and return them to the spacecraft.

Bouncer—a bat 'n' ball game with a twist which rendered me totally incapable of hitting the ball!

Chopper Chase—a nice little anti-tank warfare game.

Space Pilot Test—a *Defender*-type game but without a corridor. All the action takes place on a single screen.

Guns of Navarone—a gunnery simulation game, needing judgment of elevation and power to hit the attacking

helicopters and destroyers.

The picture is of *Creatures of the Deep* in action. The tape transferred to disc with little trouble, as none of the games has voracious memory requirements. I ran them all successfully at PAGE = &1200, needing no shifting.

George Hill

INSECT

INFESTATION

'Bugblaster', Alligata Software, BBC and Electron, £7.95

A CENTIPEDE comes down from the top of the screen, and you play the title role in *Bugblaster*—you must shoot it. There are mushrooms scattered around, which get in the way of both of you and the centipede. There are bonuses for shooting Brian, the mushroom-poisoning scorpion, and spiders. You are a small base at the bottom of the screen that moves left, right and about five lines up and down.

Bugblaster uses four direction keys and a shoot key, and includes a hall of fame.

The objects and characters are well drawn, showing good detail, and colour is well used. All mobile objects move smoothly and without flicker.

There are sound effects for the centipede's movement, firing, spiders and snails appearing, and for a bonus man every 10,000 points, but a tune before

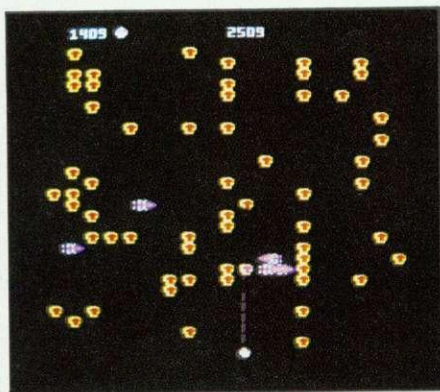

and during play might have brightened things up.

Sadly, there are no options in *Bugblaster*. It is the sort of game that would be nice to play with a joystick, and Alligata could have added a difficulty level and a sound on or off option.

Good sound and graphics make *Bugblaster* a fair game, though it seems to be a pushed-up version of *Space Invaders* set in different surroundings. It becomes boring, as the action is the same on each screen—

only the colours change and the speed increases. More variation in screens and attention to detail in game options would have made it very good.

Ian Brettell

BOUNCING

TO SAFETY

'Lemming Syndrome', Dynabyte Software, BBC (32k) and Electron, £7.95

MAD Marco is on the rampage and has blown up the bridge to the mainland. The people are panicking, jumping into the shark-infested waters rather than facing him. You are lifeboat Lennie, and using your raft, must bounce the people to the other side, avoiding sharks and Mad Marco with his dynamite.

The scenery in *Lemming Syndrome*

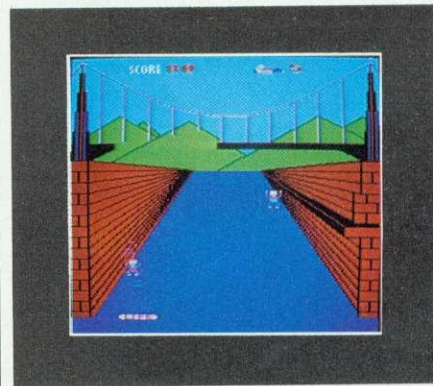

is well drawn, though motionless, and includes a blown-up bridge over a river, and hills. The movable objects—your lifeboat, people, sharks, and dynamite—travel smoothly.

You can alter the speed of the game and thus degree of difficulty, have sound on or off, and you can choose to control your raft in proportional or absolute mode. In proportional mode the raft moves left or right a pixel at a time; in absolute there are three set positions to which the raft may move—left, middle and right. Using the absolute method is much easier. The only option *Lemming Syndrome* lacks is a joystick.

Lemming Syndrome has excellent graphics, good sound, is very flexible with its many options, and is supplied with good instructions. Underneath the fancy graphics, and a well thought out background around Mad Marco blowing up the bridge, *Lemming Syndrome* is just a variation on the *Breakout* theme. It's the same all the way through and, though quite a testing game, it becomes boring.

Ian Brettell

Introducing BEEBUGSOFT

Until recently a very special range of applications and utility packages for the BBC micro has been unavailable to the general public.

This software has been produced by the BBC user group BEEBUG for its members. BEEBUG members tend to be a demanding and discerning group of individuals; and the range of software produced has been kept to a consistently high standard through their constant vigilance.

As a result, BEEBUG software is highly acclaimed amongst BEEBUG's 25,000 members. Independent reviews from the major computing magazines seem to take a similar view of the software, as you can see from their comments.

SPELLCHECK

The disc based spelling checker for text created on Wordwise or View.

"... invaluable ... fast and reliable ... a worthwhile investment"
PCN February 1984
Disc £19.00

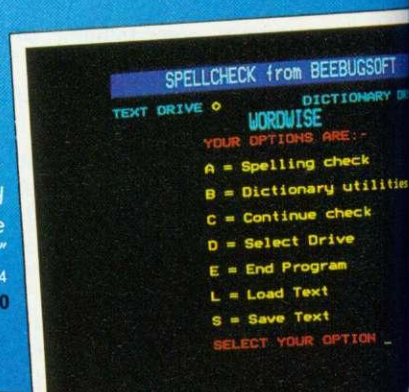

TOOLKIT

27 new commands in eprom to speed up Basic program development and debugging.

"... an indispensable aid"
EDUCATIONAL COMPUTING
March 1984

"... worth every penny ... highly recommended"
COMPUTING TODAY June 1984

"... its range of utilities is excellent"
MICRONET May 1984
Eprom £27.00

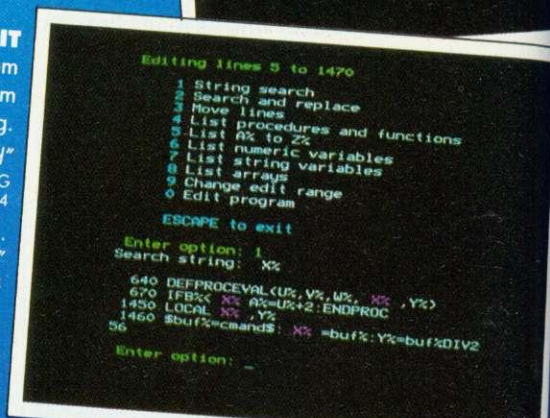

SPRITE UTILITIES

A game writers utility pack enabling high speed arcade games to be quickly written in Basic.

"... definitely recommended ... excellent"
ELECTRONICS AND COMPUTING
May 1984

"... Sprite Utilities wins through"
ACORN USER May 1984

Cassette £10.00
Disc £12.00

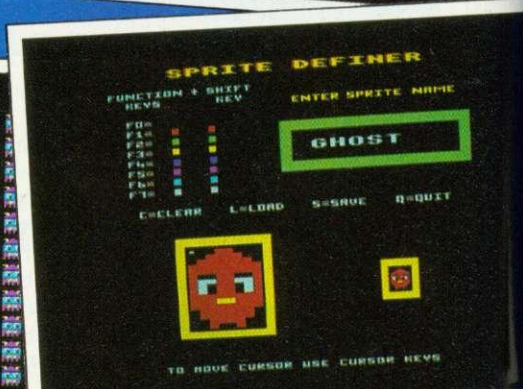
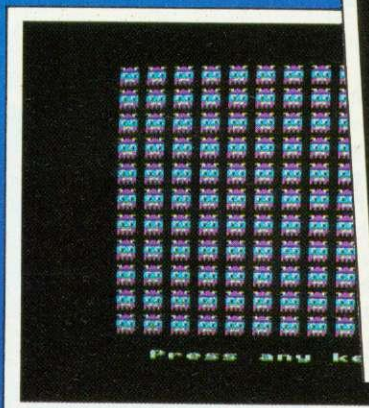

PAINTBOX

Probably the ultimate joystick drawing package on the BBC Micro, great fun and highly educational.

"... amazingly versatile ... easy to use ... (one of the most feature laden picture creating programs around) ... tremendous potential"
EDUCATIONAL COMPUTING Jan 1984

"... a very sophisticated and versatile utility"
ELECTRONICS AND COMPUTING
May 1984

Cassette £10.00
Disc £12.00

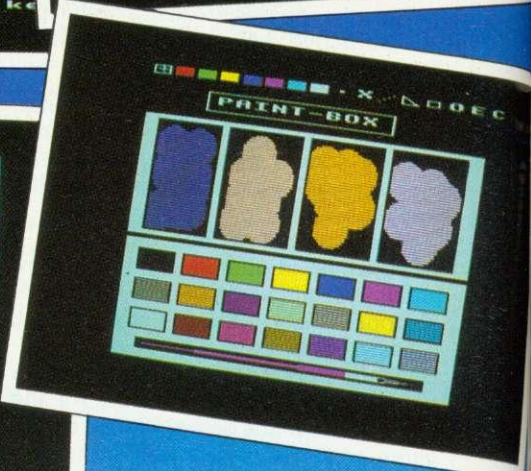
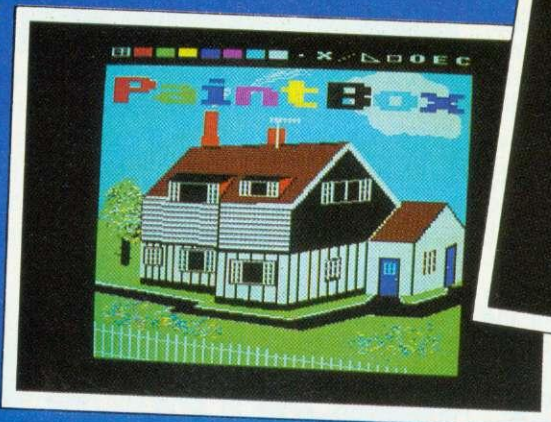

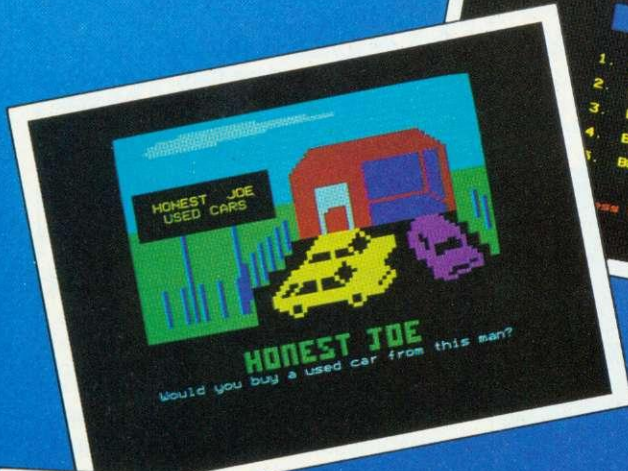

TELETEXT PACK
 A powerful screen editor for quickly creating Teletext Mode 7 screens.
 "... provides teletext editing facilities in a well thought out manner"
 ELECTRONICS AND COMPUTING April 1984
 "... a very neat utility"
 MICRONET April 1984
 Cassette £10.00
 Disc £12.00

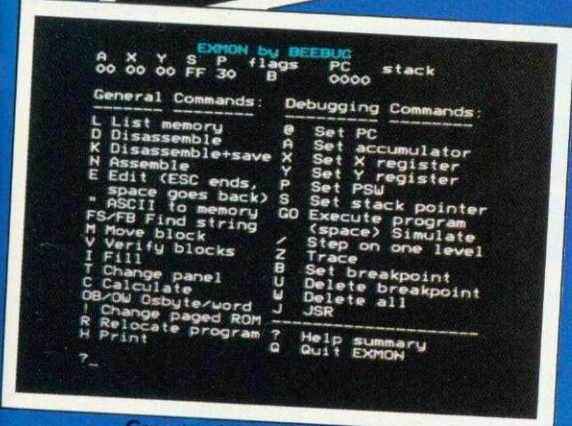

EXMON
 An extremely powerful machine code monitor on cassette or eprom, offering 35 new commands for debugging machine-code.
 "... exceptionally comprehensive... would be hard to improve upon"
 YOUR COMPUTER August 1983
 "... using EXMON is a delight"
 MICRONET May 1984

Cassette £10.00 Eprom £27.00

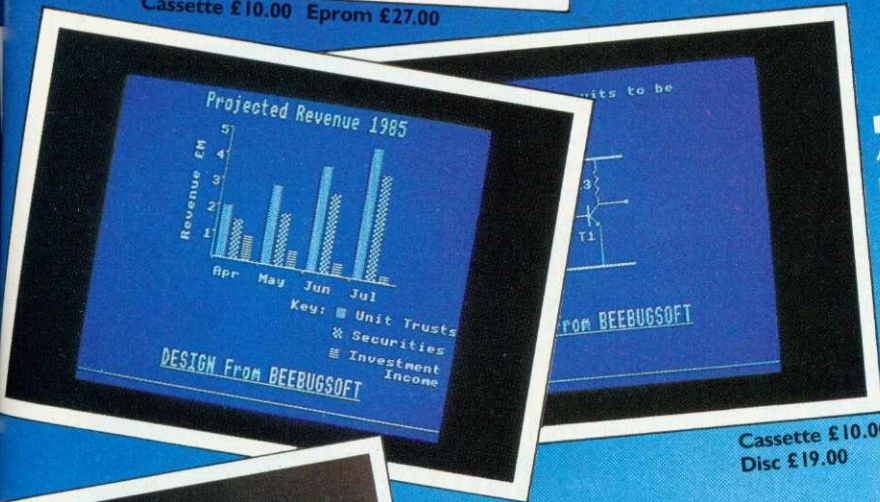

DESIGN
 A Computer Aided Design package to allow screens to be quickly created for display, demonstration, handouts etc.
 "... a first rate screen processor... immense value to schools and colleges"
 EDUCATIONAL COMPUTING April 1984

Cassette £10.00
 Disc £19.00



MASTERFILE
 A flexible general purpose database on cassette or disc; the disc version using random access files.
 "... works well and offers an efficient database"
 PCN November 1983
 Cassette £10.00
 Disc £19.00

If you would like to know more about BEEBUGSOFT products, see the advertisers' index of this magazine, or telephone us for a full software brochure.

BEEBUGSOFT products may now be obtained from major dealers including selected branches of W.H. Smith.

Alternatively all products are available from us on mail order from our despatch department in High Wycombe.

BEEBUGSOFT dept 13 PO BOX 109
 HIGH WYCOMBE BUCKS HP10 8HQ

**TEL: ST. ALBANS
 (0727) 60263**



Prices include VAT

TRENCH

WARFARE

'Trench', Virgin Games, BBC B, £7.95

YOU have been chosen to destroy the invincible Termination Planet, which threatens the universe. Only one weak spot has been found, an exhaust vent, and you are given only one chance. You must steer your X-winged fighter along the trench, avoiding the alien ships and lasers. When you get close to the vent, your attack computer is engaged, and you must position the sights over the small hole, fire, and retreat.

The graphics are nothing special in *Trench* (written by Phil Wilkes), though they do the job sufficiently. You can see the eponymous trench—which scrolls quite nicely—your X-winged fighter, alien ships and firing lasers. At the bottom of the screen is a message centre which tells you how many miles to go and, after the game, what happened, eg. 'Hit by laser'.

You can hear an engine noise all the time, the pitch of which varies with your altitude. There are other sound effects for when alien ships close in, lasers fire, for being killed, and for the run-up to the end of the trench before missile-release.

There's a joystick option, Clares or BBC but once you've selected keyboard or joystick you can't change, so if you enter Clares joystick when you have BBC you have to reload the game. There are nine levels of play. Increasing the difficulty level, makes the trench longer. There's no sound on or off option, or game pause.

The first few times I played *Trench* I found it much too hard, being hit by lasers all the time. I stuck with it, though, and now I can place a missile, though I usually get blown up along with the Termination Planet. Success

seems to be random, depending on whether a laser hits you or not.

Trench is nothing special, with standard graphics, though quite good sound, and I feel it is too difficult.

Ian Brettell



SHAPING UP

FOR THE COUNT

'One to Nine', Acornsoft, 4a Market Hill, Cambridge CB2 3NJ, £9.95

THE number of computer-assisted learning programs for the pre-school child is not large. ICL, under the guide of Acornsoft, has tried to do something about this one with *One to Nine*, a program designed to foster appreciation of simple numbers.

A different shape is used for each of the nine numbers, so the child will see ducks, teddy bears, trains, houses and a number of other familiar shapes, depending on the figure being illustrated. A stencil is supplied with the pack so that the shapes depicted on the screen can be drawn on paper to strengthen the connection between the two media. Instructions to this effect are displayed on the screen. The numeral associated with the number of

objects is also shown, and a stencil shape is again supplied.

The child is asked to press the red function keys the same number of times as the number given. Different red keys give different shapes, in an attempt to remove any association that may be built up between the number and a specific shape. If the right number of keys is pressed before RETURN, a reward is provided in the shape of a yellow train, chuffing across the screen with the appropriate number of trucks. Options are offered to change the level of sound effects and to start with any of the numbers.

While the idea is sound and the images chosen are easily recognised and of a good size, the program is heavily over-priced. If it was included in a combined package or offered at about half the cost it would give reasonable value. As it is, a good beginner's book on basic numbers might be of more use.

I don't like the instructions on screen, which are neither clear nor of value to the child. This kind of instruction should have been included in the packaging. Also, the numerals are rather small, only about twice the height of a normal mode 5 character. The whole package suggests that its inspiration came from a programmer and not a teacher.

Simon Williams



SCROLLING INTO OTHER-WORLDFLY DANGER

'A Maze in Space', Opus Software, BBC (32k), £9.95

HERE's yet another version of *Scramble*, though with a few changes and extra facilities. You must first fly up to the planet, avoiding its moons, meteors and defences. You then go down to the planet and seek and destroy your target, the alien command space station, shooting daleks, fuel dumps, rockets, and planet defence. *A Maze in Space* goes a step further with vertical scrolling, so you can go up and down into caverns.

You are told which state your target

is in, but that can be quite a large area. You have only one life, as the game uses shields, which decrease if you bump into an object, and once they are at zero you're finished. Sometimes you get caught in a space warp, which returns you to your starting point.

Before loading the game itself, the game objects and full instructions are presented.

The graphics are fair, the objects being quite detailed and good use made of colour, though the planet's moons are only in block graphics and the maze drawing is flickery, especially going upwards. At the top of the display

is your score, present stage, and state of shields, and during play the computer warns of failures to your guns, low shields, and lack of fuel.

A nice tune plays while the instructions are displayed and other effects during the game are similar to those of *Rocket Raid*. You can select sound on or off, joysticks, fast or slow game, fixed or random start position, and there's a freeze-game option.

A Maze in Space is a good attempt to improve on *Scramble* and if the flicker from the scrolling could be reduced it would much improve the quality of the program.

Ian Brettell

A little bit of magic from MERLIN COMPUTER PRODUCTS

AN UNBEATABLE COMBINATION! A WORD PROCESSOR
AND DATABASE WHICH CAN BE INTEGRATED.

MERLIN SCRIBE

The first professional
word processor
for the BBC
disc system.

Scribe is a screen-oriented, integrated word processing system specifically designed for non-technical personnel. Text and command functions are fully prompted.

The program comes in a chip with five minute fitting instructions, a 5¼" floppy disc containing the printer driver and a comprehensive instruction manual.

Among the many features available are:

- Create up to 255 pages in a single document.
- Screen user selectable 40 or 80 column with choice of background and text colours.
- Insert text at any page on the document whether currently in memory or not.
- Powerful editing commands:
Move, copy and delete with affected text displayed in reverse video. Will move or copy within a page or to any other page in the document.
- Word search and replace — item by item or globally throughout the document.
- "Go to page" — next and previous using up and down cursor keys or go directly to page numbers
- On screen underlining.
- Format line controls document width and allows setting of right and left margins.
- Tabs set on format line as required.
- Automatic centre and decimal tab.
- Text reformatting.
- Split page and dynamic page break display.
- Word count and display of cursor position by column & line number.
- Will use disc surfaces 0 to 3 as allowed by the BBC system.
- All disc filling operations menu driven, eg. re-name, copy, delete document, compact and catalogue disc, etc. No knowledge of the disc system required.
- Exec document — allows conversion of BASIC programs for editing by word processor and then re-conversion back to either text or program files.
- File merge — one or more documents or other text files may be merged in sequence from any disc drive between 0 and 3.
- Automatic page numbering with page number insertion at any point on the page.
- Headers and footers.
- Total facility print module including selection of serial or parallel output, global printer control codes, page numbering offset, print from page to page, repeat print, etc.
- Selection of up to nine user definable keys for insertion of printer control codes into text, with up to five codes allocated to each key.
- Control number of page display lines for scroll speed increase.

The program comes attractively packaged in a simulated leather grain wallet which contains the manual, disc, chip & function key legend strip.

MERLIN DATABASE

COMING SOON

Merlin Database is a database system designed exclusively for the BBC disc based computer. It provides for the structural input of text and numerical data which is stored permanently as a record on the computer. A group of records constitutes a database. Any number of databases may be created using Merlin Database.

Once created there are sophisticated facilities available for searching, selecting and drawing off information from the database by means of defining the search characteristics. This information can then be formatted for producing printed reports, lists etc.

Performance

- Maximum records per database 4000
- Maximum record size 1800 characters
- Maximum no. of fields 32
- Maximum no. of characters for any single field 900
- Find any record in 2 seconds via key field access
- Search every character in a 100 kb database in 29 secs

Field Types

- Numeric — up to 9 digits
- Date
- Sub fields for economic disc usage i.e. specify average & maximum field size

Data Search

- Search results directory held with database on disc
- Data can be passed to mail merge and report writer
- 16 level conditional search
- Search conditions include 'not', '>', '<', '='.
- Wild card
- Database automatically sorted by key field
- Database can be set to re-sort to any alternative set of key fields:

Report Writing

- Database will integrate with Merlin Scribe word processor
- Format printer output with simple forms editor
- High powered forms layout & editing using Scribe (alls. rt. justify)
- Arithmetic calculations & accumulators
- Conditional report writing
- Semi programming facility for forms & report generation

Other Facilities

- Mail merge using Scribe
- Conditional mail merge
- Automatic reformatting of lines
- Capable of conditional transfer of information between databases.

Database comes in chip with manual, simple fitting instructions & systems disc. Also planned is the production of Database integrated with the Merlin Scribe word processor in a single chip although the database is designed to integrate easily with Scribe in a separate chip.

MERLIN DATABASE £49.00
MERLIN SCRIBE £59.95
MERLIN SCRIBE/DATABASE £95.00

Prices include VAT. Price and specification subject to change without prior notice.

Credit card orders accepted. Special discounts for educational establishments and dealers.

MERLIN COMPUTER PRODUCTS (BUCON LTD)
35/36 SINGLETON STREET, SWANSEA SA1 3QN
Tel: (0792) 467980 (3 lines)



Adventure into



by Miles ELLIS
Computing Services
University of Sheffield
and
David ELLIS

A book with a difference! This is far more than a conventional teach yourself programming book. By using a sophisticated and exciting adventure game Miles Ellis, with the aid of his twelve-year old son, has designed a program which will be enjoyable from the outset as well as teaching the beginner the basic principles of good programming style, the use of sound effects, colour, graphics, program editing, and the storage and reloading of tapes.

With its innovative approach this book is outstanding because it has dared to turn the basic concept of teach yourself books on its head. In this way it captures and retains the interest and overcomes the frustration of so many would-be programmers.

An accompanying cassette tape and disc of the Adventure Game are also available for the BBC Microcomputer Model B.

CONTENTS

- What's it all about? ● Some basic principles ● Sounding off ● Using the right procedures ● Seeing is believing ● Variety is the spice of life ● Communication is the name of the game ● Adding it all up ● Some characters to play with ● A bit more flexibility ● Improve your graphics ● Get animated ● Another way of expressing yourself ● Dealing with sets of data ● Saving your results ● More advanced sound ● Some other useful features of BBC Basic ● Appendices ● Index

0471 90171 7	Book 336 pages	(paper) £6.95
0471 90531 3	Book and Cassette	£12.95
0471 90530 5	Book and Disc	£14.95

ORDER FORM to:

Annabella Duckit, John Wiley & Sons Ltd., FREEPOST,
Baffins Lane, CHICHESTER, West Sussex PO19 1YP
Tel: Chichester (0243) 784531 Telex: 86290 (Reg. No. 641132 England)

Please send me: *Adventure into BBC BASIC*

....0471 90171 7	Book	£6.95
....0471 90531 3	Book and Cassette	£12.95
....0471 90530 5	Book and Disc	£14.95

- I enclose cheque for made payable to John Wiley & Sons Ltd.
 Please charge my AMERICAN EXPRESS/DINERS CLUB/
BARCLAYCARD/VISA/ACCESS

Card No.

Date of Expiry

Telephone your credit card order —
dial 100 and ask for FREEFONE 3477 (UK only)

Name

Address

Signature

BBC Micro Utilities Bruce Smith £7.95 (inc VAT)

There are also 17 helpful machine code subroutines selected from 'BBC Micro Assembly' by the same author.

If you want to start or improve your machine code programming, you will find the BBC Micro Utilities package of booklet and tape, an invaluable aid. The tape includes BEEMON, a menu-driven program containing numerous machine code aids, among them the Disassembler, Monitor, Step and Memmove, to help you to write and debug your own machine code programs.



£7.95 inc VAT

Other Titles

Easy Programming for the BBC Micro £5.95
Eric Deeson 'Probably the best elementary BBC Basic text' — The Micro User.
Further Programming for the BBC Micro Alan Thomas £5.95
'If you are sinking with Basic on your BBC Micro, this could be your life raft' — Educational Computing.

BBC Micro in Education Eric Deeson £6.50
'Invaluable to a teacher who already knows BBC Basic and wants to write his or her own educational software' — Acorn User.

BBC Micro Assembly Language Bruce Smith £7.95
'The most readable of the several covering the topic — Educational Equipment.'



Shiva titles are available from large branches of Boots, Menzies, W. H. Smith and bookshops, computer shops and department stores. In case of difficulty, please write to: SHIVA PUBLISHING LTD, FREEPOST, 64 Welsh Row, Nantwich, Cheshire CW5 5BR. Telephone orders welcome: 0270 628272 [24 hrs/7 days] Telex: 367258 (GASEQP)

Qty	Title	Price	ORDER FORM
—	BBC Micro Utilities	£7.95	I enclose a cheque for £..... made payable to Shiva Publishing Ltd.
—	Easy Programming for the BBC Micro	£5.95	For payment by Access/Barclaycard/American Express:
—	Further Programming for the BBC Micro	£5.95	Card No.
—	BBC Micro Assembly Language	£7.95	Signature
—	BBC Micro in Education	£6.50	

Name
Address

Please send full catalogue of computer books and software



ROMS ON THE SIDE

Chris Drage compares ROM socket systems from NMC and Viglen that provide plug-in Beeb expansion on a budget

ONE OF the most important peripherals to follow in the wake of the BBC micro is the sideways ROM socket board. A number of multi-socket boards have been available for a while now: ATPL, Sir Computers and Watford Electronics have all produced 12-socket boards. A problem associated with some of them is power drain on the host micro, for the Beeb wasn't designed to house such equipment. Another problem is that the physical limit to the number of ROMs available is 16. 'Sideways RAM' has been one answer to the problem, but this means an outlay of up to £45.

For those on a budget there's now another alternative. Both National Micro Centres and Viglen Computer Supplies have stepped in to provide a single exterior sideways socket into which ROMs/EPROMs are simply and quickly inserted. The former has opted for a zero insertion (ZIF) socket, while the latter has taken a more novel approach.

The Viglen socket is really a cartridge ROM edge-connector that is connected via a ribbon cable to an internal ROM socket. Each ROM/EPROM is housed within its own cartridge and simply slotted in when required.

I wanted to see how each system stood up in general use, so I put each in a primary school computer for a fortnight and allowed the children to use *Edword*, *Disc Doctor* and *Printmaster* for various tasks.

The ROM extension socket from National Micro Centres comprises an extension cable with sockets, a ZIF socket, two pieces of double-sided sticky tape and an 'ashtray' aperture cover (figure 1). The system is designed for ROMs/EPROMs to be effortlessly inserted without damage to their legs or to the socket connections. The system is a little more tricky to install but, following the simple yet adequate instruction sheet, it took only 10 minutes.

At the Beeb end a 28-pin socket fits into 1C 52, where Basic usually resides. The socket uses round pins, which are both strong and safe for the main board socket. I was very pleased to note that NMC had not opted for the large, square-pinned plugs that do so

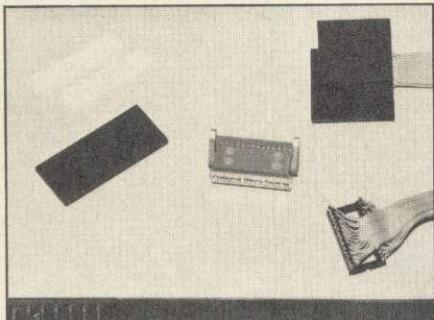

Figure 1. National Micro Centres' ROM extension socket system, consisting of extension cable with socket, ZIF socket, 'ashtray' aperture cover and sticky tape

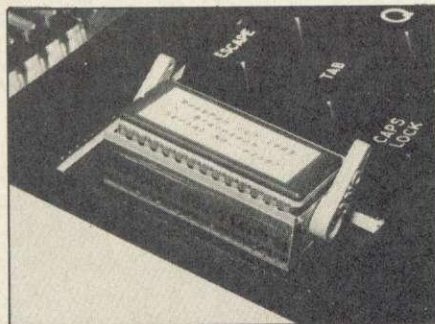

Figure 2. The NMC sideways socket installed. The board is attached to the underside of the keyboard cover with the sticky tape

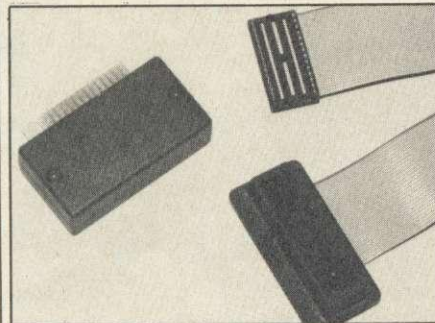

Figure 3. The Viglen cartridge ROM system, showing extension cable with socket and cartridge

much damage (remember the old OS 1.00 EPROM board!) To this a double ribbon cable is soldered and passes over the recessed area beside the power supply to the 'ashtray'. At this end a small board contains another 28-pin socket into which the ZIF socket will plug. Here the whole operation became rather amateurish.

The board is attached to the underside of the keyboard cover by double-

sided sticky tape. It worked, but I found that after a while it became weak either due to rough treatment or the warm working environment. With the keyboard cover replaced the ZIF socket is plugged in and all is ready (figure 2).

Unlike the Viglen cartridge, the ZIF socket is not clearly marked as to which way the ROMs are to be inserted. The rule is implicit: keep the ROM's notch away from you. However, one teacher got it wrong and one 2764 EPROM was ruined. A clearly labelled socket would have avoided this.

In use the system did not always function with all firmware. It appeared to work with some EPROMs and not others. Unfortunately, the *Edword* ROM would not function at all, even after calling it with *FX 142,12, which should initialise any firmware in this socket. This problem is probably due to the fact that no additional circuitry is included to provide for data loss over the length of cable. Unfortunately, the computer must be switched off before a chip can be inserted/removed. Apart from the inconvenience it is yet another easily forgotten operation that could lead to the loss of an EPROM/ROM.

My overall impression of this system is not one of confidence. I was disappointed with quality of the ZIF socket and the presentation of the system.

The Viglen sideways ROM cartridge system comes solidly packed in a plastic case and comprises a ROM extension cable and socket, an empty cartridge, a cartridge storage tray and various covers for the socket, edge connector and the Beeb's 'ashtray' (figure 3). Following the simple instruction sheet Viglen provides, installation was easy and non-traumatic. The computer end of the ribbon cable is provided with a specially tooled 28-pin plug that is simplicity itself to insert, thanks to the excellent cable connection and its strong rounded pins. The ribbon cable proved long enough to run just under the keyboard edge and emerge by the loudspeaker and it didn't foul any components. The edge connector is provided with two flanges, each of which engages within the 'ashtray' slot to the left of the keyboard (figure 4). This results in a surprisingly strong and neat socket. Five minutes

THE DATABASE SOFTWARE FOR THE BBC
THAT GROWS WITH YOUR NEEDS

Filebase II £19.95
inc.

- Operates on any format DISC or CASSETTE
- Unique TURBOFILE and MAXIFILE options
- HIGH CAPACITY files (up to a full disc with the MAXIFILE option)
- Files created to USER DEFINED format
 - up to 20 items per record
 - each record up to 255 characters
- VIEW file by easy use of cursor keys
- PRINT files (optional report layouts)
- Print LABELS
- Powerful SEARCH features
- SELECT records to view, print, count, total, change or write a file
- SORT file on any item
- Convert TURBOFILE to MAXIFILE (on disc)

Requires BBC 32K (OS 1.0 or later). Optional disc/printer. Supplied on cassette - loads to any format disc.
Can be supplied on 40 track disc (please add £3)
Overseas orders please add £2.50 to cover postage.

Cheques or P.O. to Diamondsoft Ltd., FREEPOST,
Cheadle Hulme, Cheshire SK8 5YB. Tel: 061-485 8705 (24 hrs).

BBC/ELECTRON PROFESSIONAL SOFTWARE

Our educational software is used in thousands of schools and homes throughout Great Britain.

EDUCATIONAL 1 BBC/ELECTRON Tape £8.00 Disc £10.00
Hours of fun and learning for children aged five to nine years. Animated graphics will encourage children to enjoy counting, maths, spelling and telling the time. The tape includes six programs: MATH 1, MATH 2, CUBECOUNT, SHAPES, SPELL and CLOCK.
... 'An excellent mixture of games'... Personal Software - Autumn 1983.

EDUCATIONAL 2 BBC/ELECTRON Tape £8.00 Disc £10.00
Although similar to Educational 1 this tape is more advanced and aimed at seven to twelve year olds. The tape includes MATH 1, MATH 2, AREA, MEMORY, CUBECOUNT and SPELL.

FUN WITH NUMBERS BBC/ELECTRON Tape £8.00 Disc £10.00
These programs will teach and test basic counting, addition and subtraction skills for four to seven year olds. The tape includes COUNTING, ADDING, SUBTRACTION and an arcade type game called ROCKET MATHS which will exercise addition and subtraction. With sound and visual effects.

FUN WITH WORDS BBC/ELECTRON Tape £8.00 Disc £10.00
Start your fun with alphabet puzzle, continue your play with VOWELS, learn the difference between THERE and THEIR, have games with SUFFIXES and reward yourself with a game of HANGMAN.
... 'Very good indeed'... A&B Computing - Jan/Feb 1984

JIGSAW AND SLIDING PUZZLES by P. Warner BBC/ELECTRON Tape £7.95 Disc £9.95
There are two jigsaw and four sliding puzzles on a 3 x 3 and 4 x 4 grid. Each program starts off at an easy level to ensure initial success but gradually becomes harder. It helps children to develop spatial imagination and in solving problems. The tape includes: OBLONG, JIGSAW, HOUSE, NUMBERS, CLOWN and LETTERS.

KON-TIKI by J. Amos BBC Tape £12.95 Disc £14.95
Simulation program based on Thor Heyerdahl's KON-TIKI expedition. Enjoy a journey on the KON-TIKI recording on a map the raft's position and entering notes in the logbook on creatures found, unusual events etc. Inclusive of booklet, background information, maps and fully supportive illustrated data sheets.

★★SPECIAL OFFER★★
Buy three titles and deduct £4.00
Add 50p p&p per order. Please state BBC or ELECTRON or
40 or 80 track for discs.

Golem Ltd, Dept A, 77 Qualitas, Bracknell, Berks RG12 4QG. Tel: 0344 50720

THE BBC MICRO SOUND SYSTEM
MICROVOC
As supplied to Schools & Colleges

SYSTEM INCLUDES:

Speakers, Volume control, jack sockets and all connections (assembled).
Buzzgo to eliminate the infernal B.B.C.
Buzz additional £3.00 inclusive

Special offer
Easily fitting with no drilling, soldering or
cabinet modifications £15.00 inc VAT and
p & p

MICROVOC WITHOUT SPEAKERS
£10 inclusive

Microvoc's external socket also allows you to connect directly to your hi-fi system - now you can rattle the windows with Planetoid etc. . .

MICROVOC IS IDEAL FOR SPEECH
SYNTHESIS OR COMPUTER PRODUCED
MUSIC

MICRO-ADVENT

Ashlyn House, 113 Writtle Road, Chelmsford, Essex.
Tel: 0245 59708



ATOMIC MACHINE CODE

A book containing 23 fully explained machine code programmes for the Atom.

**DATA SORTS ● MODE 4 CHARACTERS ●
GAMES ● POOLS PREDICTION ● TOOL KIT ●**

Over 50K of programmes in 1 book for £5.75 inc.
Book and Cassette (source code) £15.50.
Book and Cassette (ready to run) £15.50.
Cassette only £11.50.



TOOL KIT

20 useful programmes for the BBC on one cassette.

**BAD PROGRAMME LIST ● BAD
PROGRAMME FIX ● FIND PROCS ●
FIND DEFPROCS
BIG LETTERS ● FIND BYTE ● FIND
VARIABLE ● AND MANY OTHERS ●**

£3.95 inc.

ECCE Productions, 3/73 Station Road,
Sidcup, Kent. DA15 7DR.
Tel: 01-302 1667. (Mail order only)

and the job was complete.

Each ROM is now ready to be installed in its 60 × 20 × 30mm cartridge (figure 5). This is achieved by removing two screws from the cartridge top and pushing the ROM into a 28-pin socket mounted on a small printed circuit board. Correct orientation is aided by the suitable markings on the base-plate. Each cartridge includes additional components to allow for any losses across the data cable. This adds to the production costs but Viglen has made a wise decision to include this feature. As a result, the three cartridges used by my class of ten-year-olds performed faultlessly over the two-week period, passing the standard 10-year-old 'dropping', 'standing-on' and 'handling' tests.

Two features of the system I particularly like are the fact that it takes no additional power from the BBC micro in its operation and that cartridges may be inserted or removed with the micro switched on and working.

In case the owner wants to remove the socket from the computer, Viglen provides a blank plate to cover the aperture. This clips into the 'ashtray' and is unobtrusive. As the user's cartridges grow in number, each may be stacked in the storage tray.

Overall, this is a very successful system that met with the complete approval of children and staff.

Both the NMC and Viglen extension sockets provide a cost-effective alternative to multi-socket boards, if you don't mind swapping firmware in and out of the computer as required.

A problem of using a sideways socket system in a school environment is that cartridges/ROMs can get misplaced, and the possibility of theft must also be taken into account when using these systems in a 'public' environment. These problems however, must be weighed against the advantage of having expensive firmware quickly and easily available to swap among any number of suitably fitted computers.

Having used both systems over the month, I can recommend only the Viglen ROM cartridge system for

REVIEW SUMMARY CHART

FEATURE	VIGLEN CARTRIDGE ROM SYSTEM	NATIONAL MICRO CENTRE ZIF SOCKET
Design & construction	4	3
Installation	4	3
Performance & reliability	5	2-3
Insertion & removal of ROMs	5	3
Documentation	4	4
Application	- education - home user - laboratory - small business	- home user - laboratory
Other peripherals	- cartridge storage system - none - switchable 4 × cartridge (board planned)	
Value for money	4	3

KEY: 5... Excellent 4... Good 3... Satisfactory 2... Poor 1... Very bad

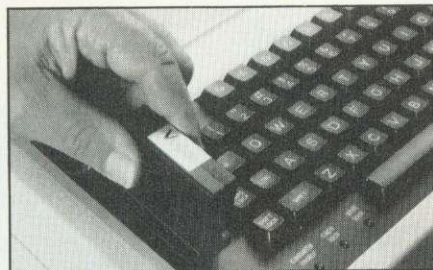

Figure 4. Inserting a cartridge into the Viglen socket

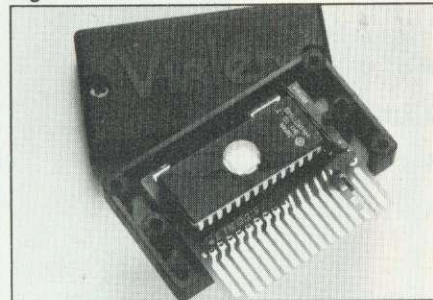

Figure 5. Inserting a ROM into the cartridge

school use. Each element is well designed, strongly built, and functions faultlessly. The risk of handling ROMs/EPROMs is too great to be a viable proposition: the extra expense of each cartridge must be measured against this. Also, as the ZIF socket cannot be relied on to work with all ROMs/EPROMs, its application must be limited.

For the home user, each of these ROM sockets appears to be a useful answer to the problems posed by the plethora of ROM-based software now available. Obviously, the NMC ZIF socket means that ROMs/EPROMs may be quickly and conveniently inserted and removed. However, the onus is on the user to provide safe handling and storage for his/her firmware. The problem is not so acute with the Viglen system as each ROM is well and truly protected. Whether the cartridge system is worth the extra cost is up to the user to decide.

DATASHEET

Product	Sideways ROM cartridge socket
Manufacturer	Viglen Computer Supplies
Socket type	Edge connector
EPROMs supported	2764 and 27128 EPROMs
Cable length	470mm
Special requirements	ROM cartridges
Price	Socket: £19.95 inc. VAT Cartridges: £6.95 inc. VAT £4.95 each for 10 cartridges
Review copy from	Viglen Computer Supplies, Unit 4, Trummers Way, Hanwell W7 2QA.

Product	Sideways ROM socket
Manufacturer	National Micro Centres
Socket type	Zero insertion force (ZIF) socket
EPROMs supported	2764 and 27128 EPROMs
Cable length	420mm
Special requirements	None
Price	Socket: £19.95 inc. VAT
Review copy from	National Micro Centres, 36 St Peters Gate, Stockport SK1 1HL

Rebalance this sheet

The BBC Micro can now give an astonishing new account of itself.

Because with Acornsoft's new 16K ViewSheet ROM, it develops a head for figures which can save you a vast amount of arduous brainwork.

Imagine, for instance, that you had to make several adjustments to a balance sheet.

If you made those adjustments on ViewSheet, it would revise the balance automatically in a split second.

Or imagine that you had to add 15% VAT to every figure on a price list containing 500 items.

ViewSheet can add the tax to each and every one of those items simultaneously. And once again, in virtually a second.

As simple as pencil and paper.

ViewSheet is a computer-based spreadsheet, the figure processing version of a word processor.

With 255 columns in width and 255 rows in depth, it's also one of the largest spreadsheets on the market.

Originating the sheet is as easy as originating an ordinary worksheet with pencil and paper.

Because ViewSheet comes with an easy-to-follow reference card.

It enables even the most inexperienced users to feed all the data they need to use, and store on disc or cassette, into the BBC Micro.

You can nominate headings and sub-headings. And you can create barcharts to display figures graphically.

Ten windows for perfect vision.

The sheer size of ViewSheet makes it impossible for the whole sheet to be visible on the monitor at once.

That's why ViewSheet has ten windows, enabling you to see up to ten different sections of the sheet at any one time.

You can summon the windows onto

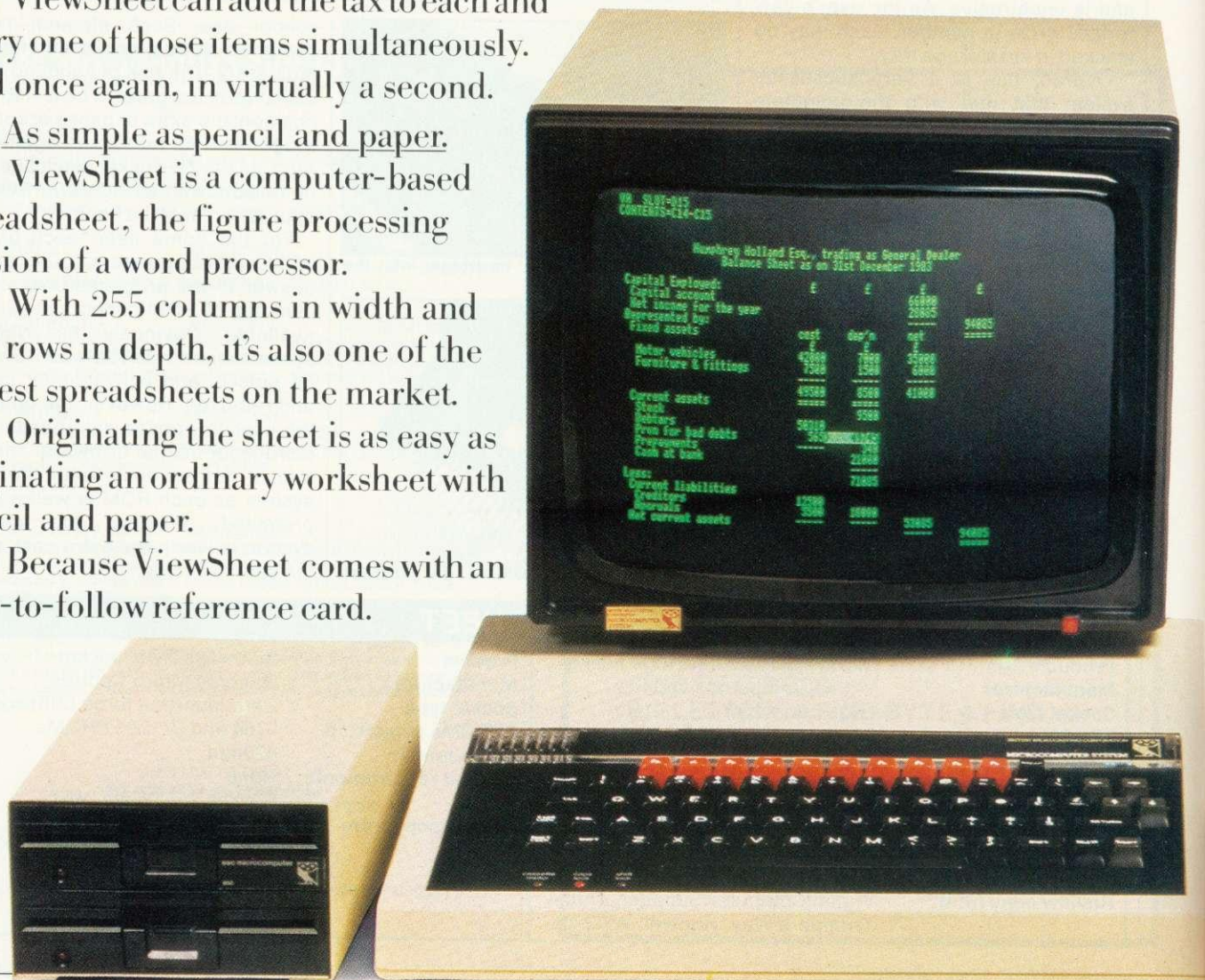

meet in one second.

the screen at the press of a key.

You can cross-reference sections, or even reposition them on the sheet, whenever you need to.

And you can print them out individually, as well as all together.

The possibilities are virtually endless.

By creating special disc files from ViewSheet, you can link two or more spreadsheets together. This means you can build models much bigger than the BBC Micro's considerable memory.

ViewSheet is also compatible with Acornsoft's View word-processing package. This enables you to produce reports and documents which combine text and figures.

In addition, you can use ViewSheet in any screen mode,

making the most of the BBC Micro's potential. And if you use it with the 6502 second processor, you'll have no less than 30K of workspace in any mode.

For only £59.80,

you too can have figures like this.

The ViewSheet ROM can be fitted by your BBC Micro dealer in less than three minutes. And with its straightforward user guide, function

key card and reference card, it'll soon have you juggling figures at lightning speed.

Indeed, at only £59.80, it's an invaluable asset for anyone involved in professional or personal finance, forecasts, formulae and analysis.

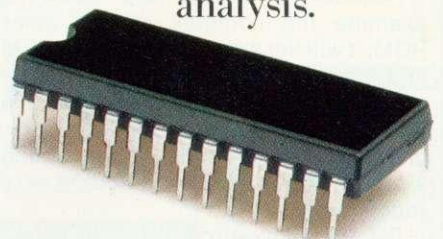
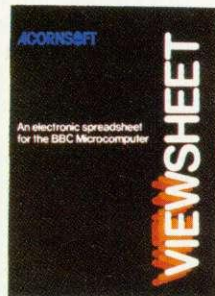

ViewSheet's operations and functions in brief.

The operations supported by ViewSheet are: addition, subtraction, multiplication, division, exponentiation and bracketed operations.

And the functions supported are: ABS, ACS, ASN, SIN, SGN, RAD, ATN, COS, DEG, EXP, INT, LN, LOG, PI, SQR, TAN, MIN, AVERAGE, MAX, CHOOSE, LOOKUP, COL, IE, READ, ROW and WRITE.

ACORNSOFT

c/o Vector Marketing, Denington Estate, Wellingborough,
Northants NN8 2PL. Tel: 0933 79300.



WRITER'S WP

FOR THE ATOM

'Editor' ROM Bearsoft (Bear Hardware, 68 Harmondsworth Lane, Harmondsworth, Middlesex UB7 0AA, tel: 01-897 3059), £35 plus VAT

NEW FOR the Atom is the *Editor* ROM from Bearsoft. A 4k EPROM, addressing at #A000, it is a refinement of, and replacement for, Acornsoft's *Wordpack* ROM. It comes with a full instruction manual, very well written, and a new keytop to replace the backslash key.

The *Editor* is a wordprocessing utility and stores text in a file from #3000 onwards, displaying it in upper and lower case on a mode 4 screen. By dispensing with several duplicate commands in the old *Wordpack* and omitting the TEXT function, a number of new facilities have been enabled. The most obvious thing is the new keytop. This is in white plastic and engraved with the symbols C/P. As in *Wordpack*, control codes can be put at the start of any line to serve various functions. These are now preceded by an inverse C, plus an

inverse P if they are to be sent to the printer. This makes them very easy to see in the text display.

Many of the old functions have been retained. New commands are:

(K)ILL – deletes text from cursor to end of file
 (Q)UIT – run a basic file at the specified address
 (L)EN – address of first free byte
 (W)ORD – displays word count, followed by L
 (I)NFO – does a dummy print run then displays format information (page number, number of lines left; word count; first free byte)

Pressing COPY (to store text) displays the address of the first free byte.

The new commands might not seem much, but the difference they make is remarkable. They turn the *Editor* into a real writer's wordprocessor. Doing a dummy print run can save an awful lot of draft copies and the ability to use Basic to add extra functions is a real treat. In my work, the ability to write very large files in sections then call and print them sequentially from disc using the Basic program given in the manual is a real time-saver. I set it going and leave it to run itself.

The Bearsoft *Editor* is well thought out and lifts the old *Wordpack* to new heights.

Barry Pickles

BUFFER MAKES ROM VALUE FOR MONEY

Buffer and Backup ROM, Watford Electronics, £18 plus VAT.

THIS ROM is one of the latest to be offered from Watford, and comes with an eight-page manual explaining its functions. The ROM can be !BOOTed using SHIFT LOCK-SHIFT and BREAK. A menu is displayed on the screen that offers three alternatives: 'ROMLOOK', 'D-TAPE' and 'TCOPY'.

ROMLOOK allows the user to examine the contents of any other ROM. It will list the contents of any ROM in a similar format to the disc *DUMP command, but unfortunately where the ASCII code is a single digit, the program does not compensate by inserting a space or a 0, so the printout is very ragged.

D-TAPE allows programs to be selectively transferred from a disc (or a series of discs) onto a tape. It will, if required, put a menu at the start of the tape for easier program selection. This menu program was very basic and would have benefited from attention to layout. The user is able to select the files to be listed on the menu. This means that data files need not appear on the menu.

TCOPY is a program to transfer tape files to tape, disc or Hobbit. I could not get this to work at all. It simply came up with the 'Header?' message and would not load tape files that I know will easily

load from tape. I suspect the problem is connected with the sideways ROM board slowing down the timing.

The ROM contains two more utilities, *VAR and *BUFFER. *VAR will list all the variables and their values. Array variables are listed, but only the number of elements and dimensions are shown.

*BUFFER for me is what makes this ROM value for money. It makes use of any RAM on the sideways ROM board as a printer buffer, if required. When the computer is switched on a message appears at the top of the screen displaying the free memory in RAM, if RAM is present on the ROM board. The printer buffer is activated using *FX5,3 when all data destined for the parallel printer port (it does not work with the serial port) is first routed through this memory space. Once all the data has been accommodated on the RAM, control of the computer returns to the user, while the data is sent out bit by bit from the RAM to the printer.

To make use of this facility one needs not only the ROM chip, but either one or two 8k RAM chips (at £40 each) as well as a ROM board. This is still cheaper than buying an 8k or 16k printer buffer, and one then also has use of the extra RAM for other purposes. Some ROM boards will accept RAM only as two 8k chips, whereas others will accept 1 8k RAM.

Martin Phillips

AMPERSAND ADDS

COLOUR BOARD

Amper sand Colour Module, Atom, £13.75 (kit). Ampersand Computers, 86 Neal Road, West Kingsdown, Kent TN45 6DQ.

OBSERVANT readers may have noticed in the small ads section two gentlemen, Messrs White and Worrall, offering construction details for a cheap colour module for the Atom. It can now be revealed that these gentlemen are known collectively as Ampersand Computers (another *Acorn User* scoop!) and their board has now been put through its paces.

It is offered in four packages, to suit every level of competence. The one tested was a ready-built board, but we also built one ourselves, using the notes provided. Construction is reasonably straightforward for anyone with any experience and the parts used are all standard components, readily available from any decent supplier – ours cost £8 to build, excluding the Veroboard. (The ready-assembled unit costs £21.50). A PCB foil pattern and overlay is provided and the notes are well written.

The board takes the signals from the 6847 VDG and converts these, using a series of TTL components to the correct signals necessary for PAL receivers (the 6847 was designed for the American NTSC standard). All the necessary signals are present on PL4 (now you know what it's for) and the board plugs into this, allowing it to be mounted inside or outside the case. Anyone who has ever tried to remove the Acorn colour card will know what a blessing this is! One capacitor is removed from the Atom PCB and a single wire inserted – this is the input to the Astec modulator. After that, it's a matter of setting up and adjusting a trimmer, until the colour is satisfactory – this is a five-minute job.

The construction notes come with demonstration listings. There is a superb pattern generator, a lovely (and extremely fast) flag drawing program and an absolutely awful 'fruit machine' game.

What about the colour? Well, it was found to vary, according to the make of TV used. However, the colour register was as good as the Acorn board, if set properly, but with none of the problems associated with that board.

All in all, a nice design and one to be recommended. Even if you buy the ready-built version, it is still excellent value.

Barry Pickles

BBC MICRO

- USER SUPPORT -

LOOK WHAT YOU
MISSED IN BEEBUG
VOLUME TWO

- 10 ISSUES OF BEEBUG MAGAZINE
MAILED FREE TO MEMBERS
- 30 EXCITING GAMES AND VISUAL PROGRAMS
- 43 SOFTWARE REVIEWS
- 33 HARDWARE REVIEWS
- 16 BOOK REVIEWS
- 150 HINTS AND TIPS
- 25 APPLICATION PROGRAMS
- SERIES OF ARTICLES FOR BEGINNERS
- MANY ADVANCED TECHNICAL ARTICLES
- NEWS AND PRODUCT INFORMATION
- PLUS SPECIAL OFFERS
- BIG DISCOUNTS ON A WIDE RANGE OF PRODUCTS
- EVENTS
- BRAIN TEASERS
- LOCAL CLUBS
- FULL MAGAZINE INDEX

A YEARS SUBSCRIPTION WOULD HAVE BOUGHT YOU ALL THIS

Figures based on the 10 issues of BEEBUG Volume 2.

BUT IT'S NOT TOO LATE TO JOIN FOR VOLUME THREE

BEEBUG PUBLICATIONS LTD. PO BOX 109, HIGH WYCOMBE, BUCKS

PLEASE ENROL ME FOR VOLUME 3
OF BEEBUG AT £11.90 (10 ISSUES)

NAME

ADDRESS

AMOUNT ENCLOSED

PLEASE MAKE CHEQUES PAYABLE TO
BEEBUG PUBLICATIONS LTD.
AND SEND TO:- DEPT 13, PO BOX 109
HIGH WYCOMBE, BUCKS.
(DISTRIBUTION AGENTS FOR BEEBUG)

**BEEBUG HAS BEEN
ESTABLISHED FOR TWO
YEARS AND NOW HAS
OVER 25,000 MEMBERS. IT
OFFERS TOTAL USER
SUPPORT TO ALL BBC
MICRO USERS.**

Disk Drives for the Acorn user —

Statacom Distribution Ltd, are main distributors for Datafax Disk Drives in the U.K.

Whatever your needs . . . talk to us.

An amazing range of top quality drives, supplied with leads, cables and utility disks from a single 100K (200K flipable disk)

with or without power supply unit, right through to a dual 400K, double sided unit (800K double density) with power supply unit.

We also distribute a complete range of 5 1/4" disk drives.

All finished in an attractive metal case to match your BBC

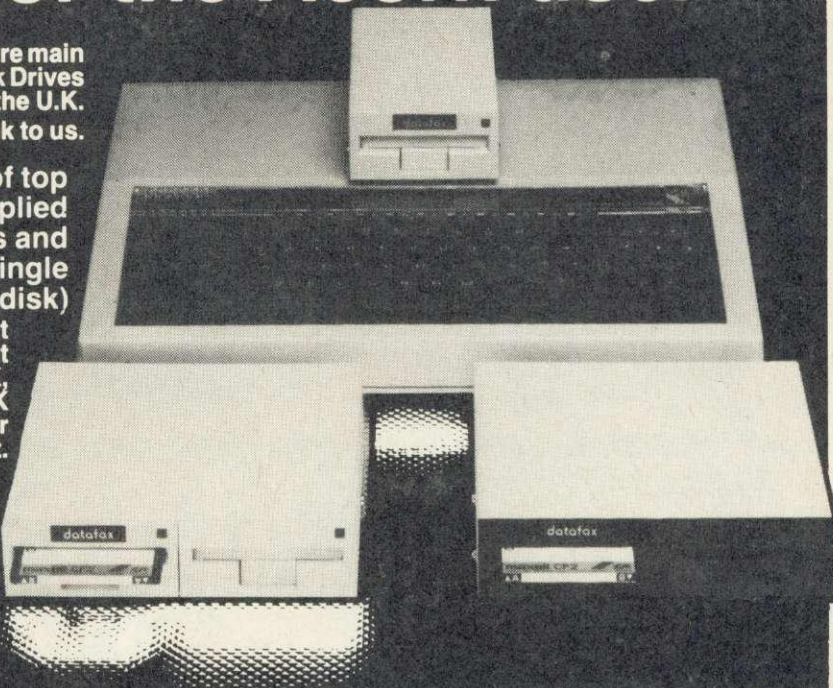

**STATACOM DISTRIBUTION LTD,
18 GROVE ROAD, SUTTON, SURREY
Telephone 01 661-2266**

datafax

Prices from £167 plus VAT

See us at the
P.C.W. Show
Olympia 2
19th-23rd
September
Stand 1045

Please send me

- Full Brochure
3" Tech Details
Dealer Info.
(Dealers attach letterhead)

Name

Address

Tel. No.

A/U



See what the experts have to say...

We proudly present our
NEW GRAPHIC ADVENTURE
The Wheel of Fortune
... widely regarded as the best
available for the BBC Micro

This game is a classic puzzle adventure with all the features you'd expect from EPIC

- HALF SCREEN FULL-COLOUR GRAPHICS FOR EACH OF THE 250 LOCATIONS
- INTELLIGENT MOVING CHARACTERS ACTING IN REAL TIME
- MULTI STATEMENT LANGUAGE AND SPEECH INTERPRETERS

"At last we have an adventure worthy of the BBC Micro... This game must now become a yardstick by which future adventures should be measured." *MICRO ADVENTURER*

"This has to be the adventure of 1984. It really is superb." *MICRONET 800*

"Technically, this game surpasses any I have seen for the BBC Micro." *H.C.W.*

"The definitive adventure. Highly recommended." *ELECTRON USER*

TO: EPIC SOFTWARE, DEPT. A, 10 GLADSTONE ST., KIBWORTH BEAUCHAMP, LEICESTER LE8 0HL *Please Rush Me -*

	CASSETTE	DISC	STATE:
.....qty THE WHEEL OF FORTUNE	£9.95	£11.95	BBC/
.....qty CASTLE FRANKENSTEIN	£7.95	£9.95	ELECTRON
.....qty THE QUEST FOR THE HOLY GRAIL	£7.95	£9.95	(Delete)
.....qty THE KINGDOM OF KLEIN	£7.95	£9.95	

POSTAGE & PACKING FREE FOR 2 OR MORE. ADD 50p FOR ONE.

I ENCLOSE CHEQUE/P.O. TO THE VALUE OF

NAME

ADDRESS

POST CODE

All programs available for immediate despatch. Dealer enquiries welcome. Help Service.

B-BASE: £25—8 Great Features

WHAT IS A DATABASE?

It is a FILE which contains RECORDS. Records consist of a number of FIELDS containing the information—an analogy can be drawn with a card index in which a box of cards is the file. Each card is a record and each line on the card is a field.

SPECIFICATION

- 1) Random Access—disc based, single or dual drives
- 2) File Size—99K (40 track), 199K (80 track)—65,000+ records
- 3) Record Size—up to 2048 characters and 200 fields
- 4) Field Size—up to 254 characters with complete line scanning
- 5) Access any record using Primary Key in 2 seconds
- 6) Holds—1200 NAMES AND ADDRESS records on 100K disk
- 7) Search—500 records on 5 fields in 60 seconds
- 8) Sort—500 records on 3 fields in 60 seconds

SYSTEM FEATURES

SEARCH PARAMETERS =, <, >, >=, <=, <>, INSTR
 CALCULATE—Global or local totals and functions using any valid BBC expression
 POWERFUL PRINTOUT OPTION—Eliminates need for separate mailing program, Parallel/Serial Printout allows setting of printer control codes, line spacing, tabulation, Headings etc, plus label printing with horizontal and vertical tab control.
 REDEFINE—Titles, field widths, number of fields etc.
 TRANSFER—Records from one file to another
 SEARCH LISTS—Allow creation of sub-Databases within main Database but without having to save data again.
 DATE FORMATS—6 formats for printout

All timings and sizes are relative to ACORN DFS. Compatible with ACORN DFS, WATFORD 1.3 and latest AMCOM DFS.

All Disc Software now available on 3" disc—add £3 to printed prices

Send S.A.E. for detailed data sheet

REPLICA II: £12.00.

The original REPLICA set a very high standard so the specification we set our chief programmer included some impossible features. In fact ACORN state that some of the things that we have done are impossible, it just took us longer that's all. REPLICA II transfers most cassette based programs to disk, even more than REPLICA. When you buy disk drives you do not have to throw away expensive cassette based programs.

REPLICA II transfers 'LOCKED' programs, programs loading as files, programs that load below &EOO, those with up to 6 sections and those up to &6E in length eg adventure programs. No waiting for 6 minutes whilst adventure programs load.

REPLICA II is very easy to use. The user enters a name, how many sections and whether CHAIN*, RUN or* LOAD to load the first section. Press play and let the program do the rest, even a menu. Think how much it will cost you to buy just 1 disk version of your favourite program—REPLICA II which will hold up to 16 programs, limited only by the disc capacity.

CLARES NO1 IN UTILITY SOFTWARE!

BEEBSYNTH: disk £11.00 cassette £8.00

A very powerful, easy to use sound generating program for expert and novice. Up to 16 envelopes can be defined and saved. The envelope definer is easy to use, control is through the cursor keys and the effects of changes can be heard immediately. When you have defined your envelopes press 'K' for Keyboard and the keyboard is transformed into a musical instrument, but you control which instrument. Plays chords, not just single notes, change pitch and duration etc. A superb program that you can use immediately. Unlimited sounds at your disposal. Recommended by MICRO USER, PCN, HCW etc.

GRAFKEY/GRAFDISK: disk £12.95 cassette £9.00

The 'GRAF' series of programs are, to our knowledge, the cheapest entry to the CAD (Computer Aided Design) field on the BBC micro. Input is either joystick or keyboard. All graphics modes can be used and altered whilst running, the functions provided are: Line, rectangle, triangle, circle, text (upper and lower case), paint and colour pallet (8 colours and flashing). Drawing aids include:

Alignment grid, circle copy, delete, free memory, purge memory, variable cursor speed, clear screen and redraw. Save drawings to tape in about 20 seconds or to disk in about 2 seconds.

Rubber Band is a very flexible line drawing facility. Pictures can be saved and included in your own programs, very easily. GRAFDISK also provides a screen save facility. Recommended by BBC MICRO USER, PCN, ELECTRONICS & COMPUTING, LASERBUG etc, used by universities, colleges and business, as well as the enthusiast.

SINGLE KEY: (requires 1.2 0.S) £5.00

SINGLE KEY ENTRY provides the user with single key entry of all 66 keywords on the BBC micro. Speeds up your program input, it's just like having 66 function keys and it only occupies 256 bytes. Compatible with BASIC 1 & Basic 2.

VIEWpoint: £12.00

VIEW PRINTER DRIVER FOR EPSON FX80 Multi-page drive with print menu allowing the setting of global (document wide) printer functions at printer initialisation.

1) Multiple choice of highlight options including underline, italics, bold, enlarged,

proportional, condensed, superscript, subscript.

- 2) Choice of any one of the nine language character sets held in the printer ROM.
- 3) Choice of PICA or ELITE type face.
- 4) Print intensity: normal or dark.
- 5) Single sheet or continuous printing.
- 6) Slow (accurate line feed) or fast print speed.
- 7) Choice of "PAD character. Selection of " " as the PAD character switches off the backslash trap to allow full implementation of the foreign language character sets.

User Defined Character Definition

The print menu program also contains a sophisticated character generator which allows the construction of 95 user defined characters which are then accessible from VIEW via a highlight option. The characters are displayed in an 8x 11 grid and can be printed (singly or as a set), stored, examined or changed at will.

Supplied on disc with comprehensive user manual.



All prices inclusive of VAT & Carriage—NO EXTRAS!

We're not short of Utility Software.

Clares
MICRO SUPPLIES

Dept AU10
98 Middlewich Rd.,
Northwich, Cheshire CW9 7DA
Tel: 0606 48511
Open 9—5 pm Monday—Friday

A large, weathered stone monolith stands in a grassy field under a dark, stormy sky. The monolith has a rough, layered texture. At the top, several thin, metallic rods protrude. Near the base, there is a pixelated logo consisting of a central square with four radiating lines, each ending in a small circle. Below the logo, the word "Clares" is written in a large, stylized, serif font. Underneath "Clares", the words "UTILITY SOFTWARE" are written in a smaller, all-caps, sans-serif font.

Clares
UTILITY SOFTWARE

HIGH QUALITY DRIVES AT EVEN LOWER PRICES.

Opus disc drives are the best buys on the market.

We have reduced our prices, but the quality still remains as high as ever.

All our 5¼" drives have been tested to their limits, running for 8,000 hours – that's a year of constant use.

And when you look at our prices, you'll find that VAT, all necessary leads and carriage are included along with a two year guarantee – a year more than any other company can offer.

You can order by posting the coupon below or calling at our showroom.

3" MICRODRIVE.

- Twice the capacity on line of other available drives.
- 200K Single Density – 400K Double Density.
- Easy to connect to the BBC Micro. • 3ms. Access time.
- Low power consumption – direct drive.
- Manual and free disc cartridge provided.



Double sided 40 Track Drive Single drive _____ **£199.95**
Dual drive _____ **£399.95**

5¼" SINGLE DISC DRIVES.

- All ½ height.
- Low power consumption.
- Comprehensive manual. • Free utilities disc.
- Direct drive mechanism. • Fast access time.

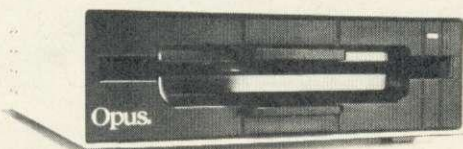

5401 100K Single sided 40 Track _____ **£149.95**
5402 200K Double sided 40 Track _____ **£169.95**
5802 400K Double sided hardware switchable
80/40 Track _____ **£199.95**

5¼" DUAL DISC DRIVES.

- Metal cased and all necessary leads.
- Separate power supply.
- Utilities disc and manual.

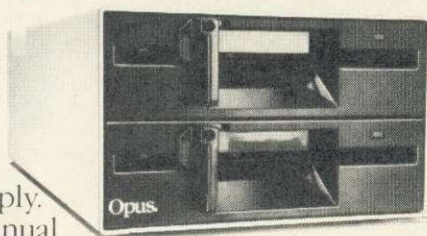

5401D 200K/400K on line S/sided 40 Track _____ **£349.95**
5402D 400K/800K on line D/sided 40 Track _____ **£399.95**
5802D 800K/1.6 Megabyte on line D/sided
hardware switchable 80/40 Track _____ **£499.95**

FLOPPY DISCS.

3" cartridge **£5.75** each or **£25.95** for 5.

5¼" Discs – with full 5 year warranty and free library case.

S/SS/D **£17.95** for 10.
S/SD/D **£19.95** for 10.
D/SD/D **£21.95** for 10.
S/S 80 Track **£25.95** for 10.
D/S 80 Track **£27.95** for 10.

DOUBLE DENSITY DISC INTERFACE.

The ultimate double density disc interface for your BBC Micro, compatible with 6502 2nd Processor.

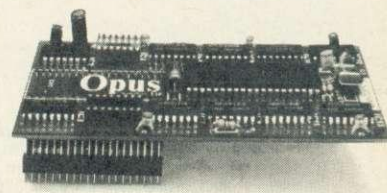

- Utilities on ROM including: Format and verify, tape to disc transfer, automatic 40/80 Track selection, automatic density selection, unique mass copy routine, powerful machine code operating system giving up to 248 files, 80% faster than single density. Easy to install. Free user manual supplied. _____ **£129.95**

GENEROUS EDUCATION AND DEALER DISCOUNTS GIVEN. ALL ITEMS ARE GUARANTEED FOR TWO YEARS AND ARE SUITABLE FOR USE WITH THE BBC MICRO.

OPUS SUPPLIES LTD.

158 Camberwell Road, London SE5 0EE.

Opening hours: 9.00-5.30 Monday-

Friday, 9.00-1.00pm Saturday.



01-701 8668

01-703 6155

OPUS PRODUCTS ARE AVAILABLE FROM BOOTS, W.H. SMITHS, SPECTRUM, JOHN MENZIES, ALLDERS AND OTHER GOOD COMPUTER STORES NATIONWIDE.

To: Opus Supplies Ltd., 158 Camberwell Road, London SE5 0EE. Please rush me the following: **(ALL PRICES INCLUDE VAT & CARRIAGE.)**

Quantity	Description	Price

I enclose a cheque for £_____ TOTAL

Or please debit my credit card account with the amount of £_____

My Access/Barclaycard (please tick) No. is _____

Name _____ **AC30**

Address _____

Telephone _____

Opus.
Opus Supplies Ltd.

✓ This indicates clubs that have responded to our circular asking for confirmation of details and continued existence. Would those clubs who have not responded please do so, otherwise they will be deleted from our list.

✓ **The Secretary Wakefield BBC Micro User Group**
116 Pinderfields Road
Wakefield
West Yorkshire WF1 3PL

■ Colin Price
Keighley Computer Club
Red Holt
Hainsworth Wood
Keighley
W. Yorks
Tel: Keighley 603133

■ Jennifer Woeller
Sutton Library Computer Club
Sutton Central Library
St Nicholas Way
Sutton, Surrey
Tel: 01-661 5031

■ Mr C. Rutter
Medway Atom Users Club
St John Fisher School
Ordnance Street
Chatham
Kent

■ Mr J. Ashurst
Acorn Computer Users Group
Abraham Moss Centre
Crescent Road
Manchester 8

✓ **BBC Adventure Club**
18 Weardale House
Woodberry Down
London N4 1QN

✓ **John Wood Atom Users' Group of Canada**
812 Cabot Trail
Milton
Ontario L9T 3M8
Canada

✓ **Austin Vaughan Irish Amateur Computer Club**
35 Monastery Drive
Clondalkin
Dublin 22
Eire
Tel: (01) 593112 (evenings)

✓ **Miss J. Lines South East Essex BBC User Group (SEEBUG)**
97 Oakhurst Drive
Wickford
Essex SS12 0NW
Tel: 03744 63396

✓ **D. Donaldson, Secretary Bracknell Primary Schools Computer Users' Group**
Wildridings County Junior School
Netherton
Bracknell
Berks RG12 4DX

■ Stuart Mallinson
Huddersfield BBC Micro User Group
34 Ryefields
Scholes
Huddersfield
West Yorks HD7 1XF

■ J. Smith, Secretary
Brighton, Hove & District Computer Club
30 Leicester Villas
Hove
E. Sussex BN3 5SQ

✓ **Mr Ric Keyworth North London BBC Micro Users Group**
'The Penthouse'
4b Kilburn High Road
London NW6 5UL
Tel: 01-734 9235
(7am-3pm Mon-Fri)

■ **West Midlands Computer Group**
12 Apsley Road
Oldbury
West Midlands B68 0QZ

■ Mr J. Price
Bedford House
27-28 St George's Road
Brighton
Sussex

■ Mr P. Beverley
Norwich Area Acorn User Group
Room 12a
Norwich City College
Ipswich Road
Norwich NR2 2LJ

■ Keith Mitchell
Edinburgh ZX Computer Club
19 Meadowplace Road
Edinburgh
Tel: 031-334 8483

■ Robin Bradbeer
Association of London Computer Clubs
Polytechnic of North London
Holloway
London N7 8DB

✓ **Andy Purkiss North & Mid-Essex User Group (NAMEBUG)**
12 Palm Close
Witham, Essex
Tel: 0376 515609
Prestel: 376515609

✓ **M. A. Cowley, President Beebnet**
PO Box 262
Kingswood
South Australia 5062

■ Mr D. L. Evans
23 Hitchin Road
Henlow Camp
Bedfordshire

✓ **R. Welch Harpenden Microcomputer Group**
7 Tylers
Harpenden
Herts AL5 5RT

■ Mr P. Frost
Atom Users Group
3 Leyland Road
Bulkington
Warks CV12 9LW

■ Ray Mitcham
Southport BBC Micro Group
5 Easedale Avenue
Ainsdale
Southport
Tel: 79936

✓ **The Secretary Radio Amateur Micro User Group (G4KCS)**
c/o R. A. Webb
39 Aldworth Road
Stratford
London E15 4DN

■ Malbeeb
BBC Users Club 'Micar'
St Monica Street
Guardamangia
Pieta
Malta

✓ **John Hannon Tasbeeb (BBC Users' Group)**
Box 25 PO
North Hobart
7002 Tasmania
Australia
Tel: (002) 342704

■ A. F. Powell
The Daventry and District Computer Club
c/o The Daventry
Ex-Servicemens Club
Market Square
Daventry
Northants

✓ **BBC INFO**
Horten Ingeniorhogskole
Skippergt. 6
3190 Horten
Norway

✓ **E. R. Piper Bognor Computer Group (BUG)**
2 Ely Gardens
Aldwick Park
Bognor Regis
Sussex PO21 3RY

■ Andrew Pike
Peterborough Personal Computer Club
920 Bourges Boulevard
Peterborough PE1 2AN
Tel: 0733 44342 (after 5pm)

✓ **John Farris Mid-Cheshire Computer Club**
75 Swanlow Lane
Winsford
Cheshire CW7 1JD
Winsford 53339

■ **Liverpool BBC Microgroup**
c/o Fred Shaw
14 Albany Avenue
Eccleston Park
Prescot
Merseyside L34 2QW

■ John Harris
Bottisham Acorn User Group
1 Rowan Close
Bottisham
Cambridge CB5 9BN
Tel: (0223) 811487

✓ **Brian Pain BEEBACC**
40a High Street
Stony Stratford
Milton Keynes
Tel: (0908) 564271

✓ **Duncan Coulter Preston BBC User Group**
8 Briar Grove
Ingol
Preston PR2 3UR

■ **Acorn Users Group of Sweden**
c/o Janne Soderberg
Frihetsvagen 32
S-175 33 Jarfalla
Sweden

✓ **Anders Wickman BBC User Group (BUG)**
Folkungagatan 58
116 22 Stockholm
Sweden

■ Peter Wilson
Universal Micro Club
26 North Cape Walk
Corby
Northants NN18 9DQ
Tel: Great Oakley 742622

✓ **John Haigh Iver Computer Society (IC's)**
11 Colliston Walk
Fords Farm
Calcot, Reading
Berks RG3 5ZJ
Tel: 0734-417534

■ John Eary
Kinder Peak Computer Club
36 Parkway
New Mills
Tel: New Mills 43870

■ C. Verrier
Wandsworth Computer Club
Earlsfield Library
Magdalen Road
London SW18

■ Mr J. Craig
National BBC User Group
40 Mount Pleasant Avenue
Wells
Somerset BA5 2JQ

■ Mr R. Luff
Kingbee
54 Arlington Close
Kingswinford
West Midlands

✓ **Computer Club**
Caterham Leisure Centre
Godstone Road
Caterham
Surrey CR3 6RE
Tel: Caterham 48304/43316

■ Ted Ryan
Eastwood Town Microcomputer Club
15 Queens Square
Eastwood
Nottingham NG16 3BJ

✓ **Mr T. A. Kayani SOBAT Computer Club (East London)**
12 Calderon Road
London E11 4EU
Tel: 01-556 5423

■ Mr M. G. Forster
Potbug BBC Users Group
8 St George's Avenue
High Lane
Tunstall
Stoke-on-Trent
Tel: 818499

✓ **Steve MacLeod BBC Users Group - Canberra**
5 Hatfield Street
Evatt A. C. T. 2617
Australia
Tel: (062) 587719

■ A. H. Fowler
Tonbridge School Computer Society
44 Birling Road
Tonbridge Wells
Kent TN2 5LY

■ J. Assies, Secretary
Big Ben Club
PO Box 177
4670 AD Zevenbergen
The Netherlands

■ H. W. H. Fisher
Sunningdale BBC User Group
82 Cedar Dive
Sunningdale
Berks SL5 0UB
Tel: Ascot 25030

✓ **Peter Hughes Format 40/80 Club**
BBC Disc User Group
5 Marsh Street
Bristol BS1 4AA

■ Dave Davies
229 Manley Road
Chorlton-cum-Hardy
Manchester M21 1RB
Tel: 061-881 0382

✓ **Tony Latham Computer Users Club**
69 Hadlow Road
Welling, Kent DA16 1AX

✓ **Tony Pickard Newcastle & Washington BBC User Group (NEWBUG)**
c/o Washington Town Centre
Library
The Galleries
Washington, Tyne & Wear
Tel: Houghton (927) 849342
after 6pm

✓ **John Fryer, Treasurer ABUG**
17 Edgedale Road
Sheffield S7 2BQ

✓ **Chris Parry, Secretary Stratford Computer Club**
15 Kipling Road
Stratford-on-Avon
Tel: 0789 68080

✓ **Robert Watt Inverclyde BBC Micro Users' Club**
9 St John's Road
Gourock
Renfrewshire PA19 1PL
Tel: Gourock 39967

✓ **Antony Hurden West Suffolk BBC Micro Users' Club**
14 Plovers Way
Bury St Edmunds
Suffolk IP33 2NJ

■ **Forum 80**
421 Endike Lane
Hull HU6 8AG

✓ **Simon Ward Porchester & Fareham Computer Club**
9a East Cams Close
Downend
Fareham
Hants PO16 8RP

✓ **D. Davidson Central Scotland BBC User Group**
1 Roxburgh Place
Larbert
Stirlingshire FK5 4UE

✓ **Linda Yeomans, Secretary Beeb Users Group (Bug Club)**
13 Regent Street
Church Gresley
Burton-on-Trent
Staffs DE11 9PL

✓ **Arjen Raateland Hopeatie 10A21**
00440 Helsinki 44
Finland
Tel: 90-5625027

✓ **Sqn Ldr J. A. Upham RAF Personal Computer Association**
Man S (ADP)
HQ RAFSC
RAF Brampton
Huntingdon PE18 8QL

✓ **Bazyle Butcher Harrow Computer Group**
16 St. Peter's Close
Bushey Heath
Watford WD2 3LG
Tel: 01-950 7068

✓ **MUSE (for teachers)**
PO Box 43
231/2 Friary Chambers
Whitefriargate
Hull HU1 2HD
Tel: 0482 20268

✓ **Nik Kelly Mersey BBC User Group**
56 Queen's Drive
Liverpool L4 6SH

✓ **R. V. Souter, Secretary TRS-80/Beeb Users Group**
4 Risby Garth
Skidby
Cottingham, Hull
HU16 5UE
Tel: 0482 845326

✓ **BBC Micro Club Tenerife**
PO Box 1297
Santa Cruz de Tenerife
Canary Islands (Spain)
Tel: (922) 216546

✓ **Rupert Steele Association of Computer Clubs**
17 Lawrie Park Crescent
London SE26 6HH

✓ **Andy Leeder Amateur Computer Club**
Church Farm
Stratton St. Michael
Norwich NR15 2QB

✓ **Bob Hindle South Yorks Personal Computer Group (SYPCG)**
139 Penrhyn Road
Sheffield S11 8UP

✓ **J. G. Dowling Acorn Atom Users Group**
27 Oriibi Avenue
Van Riebeeck Park
Kempton Park 1620
South Africa



Computer Concepts

General:

All common printer facilities are made available with easy-to-use commands including:

- * UNDERLINE
- * ITALICS
- * STYLE
- * LINESPACE
- * PAGELEN

.... and others

Other Facilities:

- Character definition utility.
- Send files to printer at the same time as running BASIC programs etc.
- Interactive window setup, for choosing area of screen to be dumped.
- Save/load character font.
- Large character printing.
- Commands can be included in wordwise text (version 1.2 onward)

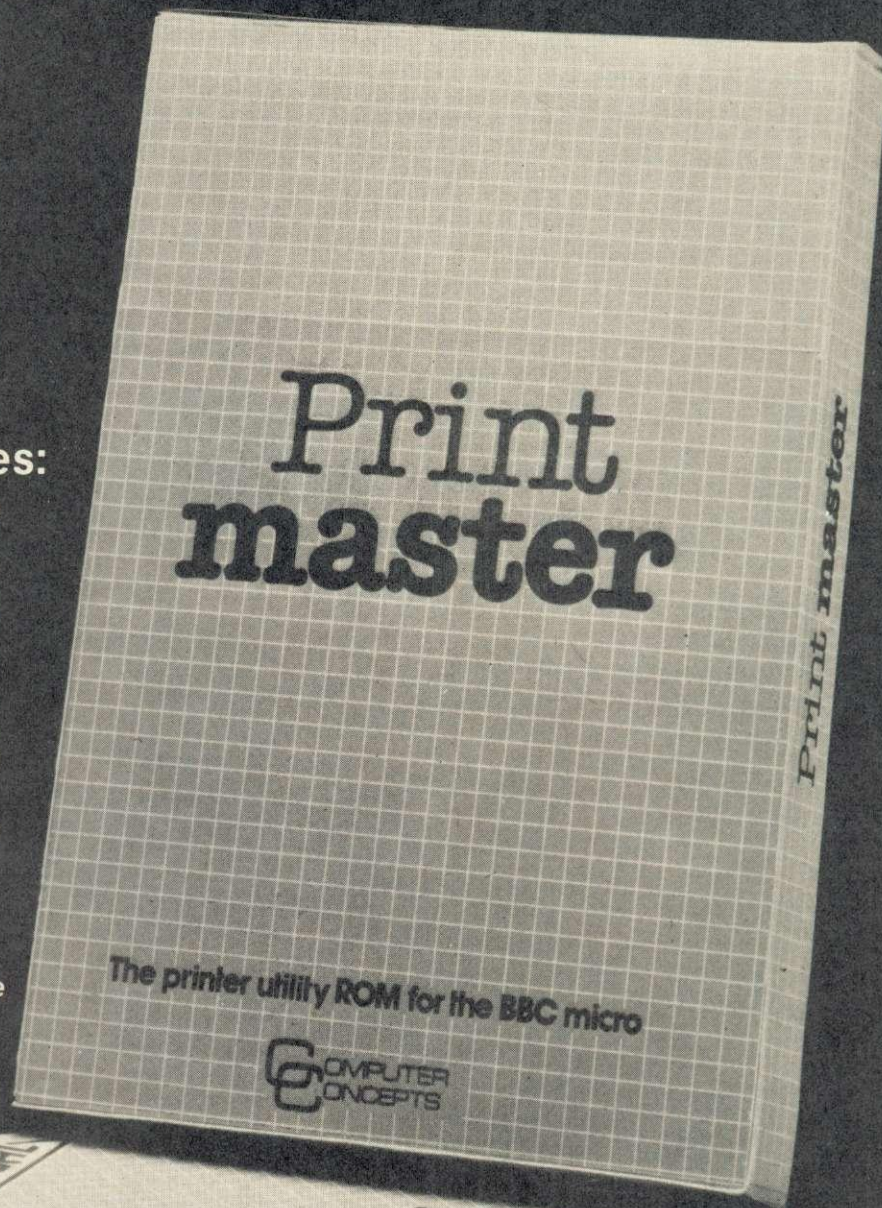

Computer
Concepts

Gaddesden Place
Hemel Hempstead
Herts HP2 6EX
(0442) 63933

Now available:
PRINTMASTER
(EPSON)
PRINTMASTER
(STAR)
price £33.35 incl.



Speech Synthesizer

FOR BBC MODEL B

Close Approximation of Text to Speech
Immediate Verbal Acknowledgement on
"power up"

Unlimited Vocabulary

Word Representation to Sound

User Programmes Easily Modified
by using a Simple *S Command

FITS INTO ONE OF THE BBC ROM SOCKETS

Price £41.00 inc. P & P complete
including Simple Fitting Instructions
and User Guide

Please make all Cheques and Postal Orders to:

D. E. SYSTEMS

44 Cross Street, Widnes, Cheshire WA8 6LT

THE MIDDLESEX CENTRE FOR BBC

Everything for the Acorn/BBC Owner under one roof.

ACORN ELECTRON — £199 BBC + ACORN DFS £469

BBC MODEL 'B' — £399

Disk Drives by: TEAC, BBC,
MITSUBISHI, AMS, CUMANA,
KORMANDI, TORCH and others
from £149.00

Monitors by: NOVEX, PHILIPS,
MICROVITEC, FIDELITY from
£79.95

Printers from EPSON, STAR,
BIT, SHINWAY, BROTHER,
JUKI, UCHIDA, CANAN, TAXAN
etc, etc

Accessories: Lightpens, Dust
Covers, Joysticks, Monitor Stands,
Cases, Leads, Floppy Discs and
much much more

SOFTWARE: GAMES, BUSINESS
& EDUCATIONAL plus
PROGRAMMING AIDS on
Cassette, Disk or Rom.

SECOND PROCESSORS, Z80's
PACKS, UPGRADES, ROM
FITTING, REPAIRS, TESTING
etc, etc

PLUS!

Special Word Processing, Business
and Programming starter Kits
offered to meet your requirements
at good savings.

WE WILL BETTER ANY GENUINE OFFER IF THE PRICE IS LOWER THAN OURS

SCREENS MICROCOMPUTERS

(A Division of Mayfair Computer Services Limited)
6 MAIN AVENUE, MOOR PARK, NORTHWOOD, MIDDLESEX, ENGLAND.
Tel: NORTHWOOD (09274) 20664
Telex 923574 ALACOL G.

- ★ Open 6 days per week. Easy Parking.
 - ★ Worldwide fast, reliable mail order.
 - ★ Official Orders/Enquiries welcome.
- Visa . Access . Amex . Diners Club . Instant Credit



NEW

SOCIAL SCIENCE SOFTWARE

A NEW RANGE OF COMPUTER PROGRAMMES DEVELOPED AND TESTED IN AN EDUCATIONAL ENVIRONMENT
AND DESIGNED AS TEACHING AIDS FOR SOCIAL SCIENCES TAPE OR DISC
SUITABLE FOR ANY B.B.C. MICRO B, 40/80 TRACK

- **THE ELECTION PROGRAMME** — SOPHISTICATED AND VERSATILE ANALYSIS OF ELECTION RESULTS NOW WITH SCREEN MAPS OF LONDON/ENGLAND & WALES/SCOTLAND & N. IRELAND, LINKED TO DATA FOR A VARIETY OF LOCAL/REGIONAL ANALYSIS. Already used by Politicians, Universities, Polytechnics, Schools and Colleges. (DISC ONLY: DATA DISC & PROGRAMME DISCS £24 DATA/PROGRAMME/MAP DISCS £39.50)
- **THE ENERGY CRISIS** — A SIMULATION OF INVESTMENT AND PRODUCTION OF ENERGY. "A well-designed simulation".... "it has a particular relevance to 'A' Level Economics and 6th Form General Studies"..... "will — stretch the brightest students". John Simkin, 'The Teacher' (TAPE — £15; DISC — £17.50)
- **DISCOUNTED CASH FLOW** — DEMONSTRATES THE USE OF D.C.F. IN COST-BENEFIT ANALYSIS AND INVESTMENT APPRAISAL (TAPE — £7; DISC — £9.50)
- **B/TEC RECORD KEEPER** — FOR STORING, UP-DATING AND PRINTING STUDENT REPORTS AND RESULTS (TAPE — £15; DISC £17.50)
- **MULTIPLE CHOICE TEST DESIGNER** — ALLOWS YOU TO DESIGN/EDIT/RUN MULTIPLE CHOICE TESTS USING A VARIETY OF FACILITIES (TAPE — £8.50; DISC — £11)

ALL PROGRAMMES INCLUDE A COMPREHENSIVE MANUAL DISCOUNTS: ORDERS OVER £50, 10% REDUCTION

ALL ORDERS POST FREE FURTHER INFORMATION SUPPLIED ON REQUEST: ORDERS (WITH REMITTANCE OR YOUR OFFICIAL ORDER FORM, SPECIFYING TAPE OR 40/80 TRACK DISC) AVAILABLE FROM: RICHARD S. BALL, FREEPOST, DEPT. (B), BIRKENHEAD, MERSEYSIDE L42 2AB. DEALER ENQUIRIES WELCOME

ALSO

FROM OLD KENT ROAD TO MAYFAIR "THE FAMOUS BOARD GAME FOR THE B.B.C. MICRO"

- FEATURES INCLUDE:
- UP TO 5 PLAYERS PLUS THE COMPUTER
- THE COMPUTER CONSIDERS DEALS AND OFFERS EXCHANGES
- SHORT AND STANDARD VERSIONS
- GAME — SAVE FACILITY

THE COMPUTER IS AN ACTIVE AND INTELLIGENT PLAYER IN THIS COMPUTERISED VERSION OF THE WORLD FAMOUS BOARD GAME. AND IS HARD TO BEAT. AN IDEAL CHRISTMAS GIFT. TAPE £8.00 DISC (SPECIFY 40 or 80 TRACK) £10.50 POST FREE AVAILABLE FROM THE ABOVE FREEPOST ADDRESS

PUBLISHED BY SOCIAL SCIENCE SOFTWARE



DEALER ENQUIRIES WELCOME

3D COMPUTERS

THE HOME COMPUTER
SPECIALISTS

WITH MORE BRANCHES THAN
ANY OTHER ACORN DEALER
WE OFFER

ONE-STOP SHOPPING FOR YOUR BBC MICRO AND ELECTRON

SPECIAL ELECTRON PACKAGE INCLUDES
ELECTRON WITH PLUS 1
FOR **£229**

**SEE US AT THE SHOW
ON STAND 61**

SOFTWARE

PROGRAM POWER
BUG-BYTE
SUPERIOR SOFTWARE
A & F
SIMON HESSEL
MOLIMERX
ALLIGATA
ACORNSOFT

PERIPHERALS

DISCS SINGLE/DUAL
TORCH Z80 DISCS
MIDWICH DISCS
PRINTERS
JOYSTICKS
MONITORS
B & W/COLOUR
LIGHT PENS
BBC BUGGY

*large range of books,
diskettes, cassettes &
printer paper always
in stock*

*Easy parking at all
branches*

TOLWORTH

230 Tolworth Rise South,
Tolworth, Surbiton,
Surrey KT5 9NB.
Tel: 01-337 4317

SUTTON

30 Station Road,
Belmont, Sutton,
Surrey SM2 6BS.
Tel: 01-642 2534

EALING

114 Gunnersbury Avenue,
Ealing, London W5 4HB.
Tel: 01-992 5855

NEWBURY

26, Stanley Road,
Newbury
Berks RG14 7PB.
Tel: (0635) 30047

RICKMANSWORTH

Grey Stone Works,
The Green, Croxley Green,
Rickmansworth,
Herts WO3 3AJ.
Tel: 0923 779250

LUTON

1 Manor Road,
Caddington, Luton,
Beds LU1 4EE
Tel: (0582) 458575



UNBELIEVABLE SAVINGS

** COMPUTERS **

		EX VAT
APRICOT	F1 - from	£675.00
APRICOT	Point 7 from	£2950.00
APRICOT	PORTABLE from	£1445.00
APRICOT	256K 315Kx2 MONITOR	£1395.00
APRICOT	256K 720Kx2 MONITOR	£1545.00
APRICOT	XI 256K 10MB MONITOR	£2195.00
CIFER	9000 Multi User 21MB	£5095.00
COMMODORE	8250 DISK DRIVE	£785.00
COMMODORE	8296	£695.00
COMMODORE	SX-64 PORTABLE	£675.00
COMMODORE	64	£156.51
COMMODORE	DISK 1541	£165.21
COMMODORE	IBEK PARALLEL INTERFACE	£59.50
COMMODORE	1530 C2N CASSETTE	£32.00
COMPAQ		£1795.00
KAYPRO	II	£945.00
KAYPRO	10MB	£1995.00
OLIVETTI	M20 160KB 2x320KB Drives	£1295.00
OLIVETTI	M24 128KB 2x360KB Drives	£1658.00
OLIVETTI	M24 128KB 10MB Hard Disk	£3315.00
SAGE	II & IV	POA
SANYO	MBC 555 128K 2x160K Drives	£795.00
SIRIUS	256K 10MB	£2850.00
SIRIUS	256K 2.4MB	£2095.00
SIRIUS	128K 1.2MB	£1545.00
SIRIUS	Memory Expansions from	£222.00
SIRIUS	Express Accelerator Boards	POA
PLUS 5	External Hard Disk Drives	POA

** SOFTWARE **

ALL MAJOR SOFTWARE PROGRAMS SUPPLIED AT
LOW COST

WORDSTAR	£195.00
OPEN ACCESS	£360.00
LOTUS 123	£295.00
SYMPHONY	£490.00
MULTIMATE	£240.00
D BASE II	£280.00
DMS DELTA	£395.00
FRIDAY	£135.00
FRAMEWORK	£345.00

Not only do we offer top quality products at low prices. We also support and develop Software with the assistance of our long established software dept.

** MATRIX PRINTERS **

		EX VAT
ANADEX	DP-6500 500cps	£2019.00
ANADEX	WP-6000	£1808.00
BROTHER	EP44	£199.00
BROTHER	HR5	£129.00
CANON	PW1080A 160cps (NLQ)	£279.00
CANON	PW1156A 160cps (NLQ)	£339.00
EPSON	RX 80T 100cps	£195.00
EPSON	RX 80FIT 100cps	£220.00
EPSON	FX 80 160cps	£324.00
EPSON	FX 100F/T 160cps	£430.00
EPSON	LQ 1500 200cps (NLQ)	£895.00
HONEYWELL	From	£375.00
MANNESMANN	MT80 80cps	£199.00
MANNESMANN	MT180 160cps (NLQ)	£590.00
NEC	PINWRITER P2(P)	£535.00
NEWBURY	DRE 8850 300ipm	£2095.00
NEWBURY	DRE 8925 240cps	£1385.00
OKI	82A 120cps	£255.00
OKI	84A 200cps	£630.00
OKI	OKI 192P 160cps	£379.00
OKI	OKI 2410P 350cps	£1535.00
SEIKOSHA	GP100A	£165.00
SHINWA	CP80 Model II FT	£175.00
STAR	DELTA 10 160cps	£319.00
STAR	DELTA 15 160cps	£435.00
STAR	GEMINI 10X 120cps	£189.00
STAR	GEMINI 15X 120cps	£285.00
STAR	RADIX 10 200cps (NLQ)	£449.00
STAR	RADIX 15 200cps (NLQ)	£549.00
TEC	1550 120cps	£465.00
TOSHIBA	TH2100H 192cps	£1275.00
TREND	930 200cps NLQ 80cps	£1350.00

MAYFAIR MICROS

BLENHEIM HOUSE, PODMORE ROAD,
LONDON SW18 1AJ

TEL: 01-870 3255

We accept official orders from UK Government and Educational Establishments. Mail Order and Export Enquiries welcome. Callers by appointment.

** DAISYWHEEL **

** PRINTERS **

		EX VAT
BROTHER	HR1	£445.00
BROTHER	HR15	£329.00
BROTHER	HR15 Keyboard	£135.00
BROTHER	HR15 Sheetfeeder	£185.00
BROTHER	HR15 Tractor Feed	£62.00
BROTHER	HR25	£549.00
DAISYSYSTEM	2000 20cps	£240.00
DIABLO	630 API	£1315.00
DIABLO	Sheet Feeder	£490.00
JUKI	6100 18cps	£325.00
NEC	2010 Serial 20cps	£545.00
NEC	2030 Parallel 20cps	£545.00
NEC	3510 Serial 35cps	£1049.00
NEC	3530 Parallel 35cps	£1049.00
NEC	7710 Serial 55cps	£1440.00
NEC	7730 Parallel 55cps	£1440.00
QUME	11/40 RO	£1185.00
QUME	11/55 RO	£1370.00
QUME	9/45 RO	£1550.00
QUME	9/55 RO	£1900.00
RICOH	RP1300S	£895.00
RICOH	RP1600S	£1190.00
RICOH	RP1600S FLOWWRITER 8k	£1249.00
RICOH	RP1600S FLOWWRITER 8k IBM PC	£1299.00
RICOH	RP1600S Sheet Feeder	£459.00
RICOH	RP1600S Tractor	£138.00
SMITH		
CORONA	TP1 12cps	£195.00
TEC	STARWRITER F1040 40cps	£895.00
TEC	STARWRITER F1055 55cps	£1235.00
TEC	Sheetfeeder	£459.00
TEC	Tractor	£138.00

** VDU's & TERMINALS **

CIFER	T4	£760.00
HAZELTINE	ESPRIT Fixed Keyboard	£395.00
QUME	QVT 103 (VT100 VT131)	£695.00
TELEVIDEO	910	£489.00

** PLOTTERS **

MANNESMANN	PIXY PLOTTER	£495.00
GOULD	PLOTTER	POA

QUIXLEARN

The System That's An Education In Itself

COMPUTER BASED AUTHORING

If you are involved in teaching, whether in school or industry whatever your subject then QUIXLEARN will interest you. No need to search for ready-made educational software. QUIXLEARN now enables you the teacher to design and write teaching material. You need have no programming experience. QUIXLEARN is easy to master but with powerful facilities. Construct lessons containing text and pictures in colour using TELETEXT characters or your own set of 128 graphics characters. Include questions for the student to answer — you decide how the lesson proceeds. Link a lesson to cassette tape for simultaneous audio instruction. Set up your own libraries of text and pictures for use in different lessons. Ideal for preparing lectures, training courses, advertising material and demonstrations.

Designed to be used with the BBC Model 'B' (OSI.O) and disks. (5¼")

QUIXLEARN is supplied on disk, with audio cassette, and instructional material included. The disk and cassette contain a lesson which will teach you how to use the system. Price £75 (incl. VAT + P&P)

State 40 or 80-track DISK DRIVE

Payment with order to:

**QUIXTOR LIMITED, 7 HASLEMERE AVENUE,
HALE BARN, WA15 0AU.**

QUIXLEARN was developed as part of an Open Tech project.

Disc Drive Multiplexer

- * No switches
- * No software
- * No extra cables or connectors

This is a very simple low cost alternative to buying a disc drive for every BBC machine. This unit allows up to 4 BBC computers to access the same single or dual disc drive using the standard DFS commands.

The unit operates by electronically switching the disc interface signals. The multiplexer copes with simultaneous access and will run with one or more BBCs disconnected or turned off. The unit is ideal for use in schools and offices and saves having to purchase several drives for up to £500 each.

The unit is complete with 5ft. cables as standard but cables up to 10ft. can be supplied. The multiplexer has it's own power supply.

Prices: £75.00 for a dual unit with 2 x 5ft. cables
£135.00 for a quad unit with 4 x 5ft. cables
Plus 15% V.A.T.
Postage & packaging £1.50
Extra cable at 60 pence per foot.

VIA Board

This extension board gives the user 3 extra VIAs (equivalent to 6 user ports). The connection is made to the 1MHz Bus and the VIAs can be decoded to appear in pages & FC & FD. Up to 4 boards can be daisy chained to give 12 VIAs.

The board can be powered from +5v, +12v DC or 9v AC.

Price £60.00 each plus 15% V.A.T.

All products will be supplied on a Sale or Return basis to Schools, Colleges and Government Departments.

For further details contact:

BENWICK ELECTRONICS

5 Church Street, Wimblington, Nr, March, Cambs.

PE15 0QS

Tel: March (0354) 740508

Micro Resources Limited

Southfield House, 11 Liverpool Gardens, Worthing, Sussex BN11 1RY
Telephone: Worthing (0903) 213174

BBC Model B	£399.00
BBC Model B Disc Interface	£469.00
BBC Model B Econet	£446.00
BBC Model B Econet & Disc	£516.00
Acorn Electron	£199.00

Acorn 6502 2nd Processor £199.00

This allows the BBC Model B to run faster with greatly increased memory especially in high resolution graphics modes, the package includes Tube software, the latest version of the DFS & NFS called DNFS, a Rom containing Hi-Basic and a comprehensive User Guide.

Acorn Z80 2nd Processor £299.00

If you have wondered how to make the best use of your BBC for Business, then the Z80 2nd Processor and CP/M must be the answer. This package comes with a suite of business programs, including Memoplan, Fileplan, Graphplan, Accountant, BBC Basic (Z80 Version), Cobal, Neculeus (Programming Aid), Professional Basic. This software alone is worth hundreds of pounds and with CP/M you can buy any of the programs written for this operating system.

Dual 800K Disc Drive £359.00

Superb British made disc drive unit ideal for use with the 280 2nd processor.

Acorn Teletext Adaptor £225.00

Allows the downloading, storing and running of programs via Ceefax, transmitted free of charge, pages can also be saved and printed from all 4 channels.

Acorn Bitsik £375.00

This superb menu driven graphics package allows high quality CAD at a modest price. Needs 6502 2nd Processor and dual 80 track discs drives, a must for all design teams.

Acorn IEEE 488 Interface £325.00

Provides computer control of compatible scientific and technical equipment. Useful in experimental work in industry and education.

Acorn Word Processor View £59.00

This Rom based word processor has many advanced features including macros, still one of the best available on the market.

Acorn Spreadsheet Viewsheet £59.00

A new spreadsheet from Acornsoft comes in a 16K Rom with a comprehensive manual, it is compatible with view and the 6502 2nd processor.

Mass Marco Assembler £35.00

A superb machine code assembler in Rom, includes comprehensive manual where the user is introduced to Mass and given step-by-step guide to writing source code and assembling it using Mass. Also includes a utility disc with many useful routines.

All prices include VAT and delivery

PROGRAMMER'S REVENGE

The Programmer used to play the adventure games found on mainframe computers. He thought he could do better. He tried. His friends urged him to publish.

Not for thugs whose idea of intellectual recreation is to go around beating up hapless trolls, Revenge is a puzzle adventure game set in a strange but beautiful landscape closer to home than you think. Some problems require hard lateral thinking, some are merely whimsical: all are deeply satisfying to solve.

Text compression is used to fit a novelette-length game into your micro. The program understands commands of up to four words, with a large vocabulary. Over 300 locations, save and restore facility. Characters you will meet on your travels include the Programmer himself.

A superior quality adult adventure game. Spend your winter evenings exploring!

Order form:

COLISOFT, PO Box 195, 53 Carlton Road, Oxford OX2 7SQ

Enclose cheque/PO for £8 incl., made payable to COLISOFT, plus your name and address.

FOR THE BBC 32K ONLY - CASSETTE

(Further enquiries to C. Jack, 53 Carlton Road, Oxford OX2 7SB)

BBC VOLUME CONTROL

At last turn your sound UP/DOWN or OFF with this variable volume control. Fitted discreetly to the back of your Beeb. Easy to fit. Some soldering necessary.

Kit of parts and step by step instructions.

Only £2.80 inc.

**RACEY DESIGNS
47 TWY CROSS RD, BURBAGE
LEICS LE10 2SF**

BBC POOLS PREDICTOR

WITH 11,000 MATCH DATABASE

Now in its 3rd successful season, Mayday Software's Pools Predictor has been made even more powerful with a new and unique 11,000 match database. Seven separate forecasting techniques have been combined to give you the best forecasts yet. And, just as easy to use, is our new Racing Analyser. This uses the racecard from your daily paper to analyse any horse race—and it's yours for no extra charge!

..... Also available for the Spectrum.....

MAYDAY SOFTWARE

**181, PORTLAND CRESCENT
STANMORE, MIDDX HA7 1LR**

FREE RACING ANALYSER

BOTH PROGRAMS FOR ONLY

£8.99

BBC model B 1-20S, 9 months old, plus cassette and software. All as new £300 ono. Tel: St. Albans 63981 evenings.

BBC model B 1-20S, Basic II plus joysticks, cassette recorder, leads. Lots of software, magazines and books. Hardly used. All for £340. Write to D Francis, 12 Exeter House, Hallfield Estate, London W2.

BBC model B, 1-20S, DFS, Word-wise, Disc Doctor ROMs, software including Spellcheck, Acorn Graphs and Charts, Gemini Database. 100k Cumana CS50A disc drive. VGC £500 ono. Owner emigrating to Canada. Berkhamsted 5518.

BBC model B, Acorn DFS and speech chips, brand new. Software, books and joystick included. Only £475 ono. Phone Taunton 490901 evenings.

BBC model B OS1-2, Basic II, recorder, joysticks, books, mags and software. Cost £530 new. Bartaun at £370. Telephone Mansfield (0623) 810982.

BBC model B with 1-2 operating system. Absolutely unused and in perfect condition. £330. Write to Mr D Leach, 104 St. George's Square, Pimlico, London SW1 for immediate response.

BBC micro books, all in mint condition, for sale or exchange for BBC graphics and assembly books. Telephone Mathew on Lisburn 79066—evenings.

BYTE back issues wanted: Jan to Dec 1980; Jan, May to Dec 1982; Jan to Dec 1983. Plenty of American magazines available to exchange. Smith, 84 Edenfield Gardens, Worcester Park, Surrey KT4 7DY.

£400 cash paid for BBC B with disc I/F + drive + OS 1-2 + Basic II. £325 for above without d/drive. £250 paid for Beeb only. Prices open to negotiation. Tel: (0522) 694961 after 6 pm.

CASIO FX602 wanted by degree student. Phone 01-330-1554.

CANON 2 x 100k disc drives with Tandy interface, parallel printer interface, integral psu, special BBC cable LDOS 5-1-4, £325. TRS-80 model 1/L2 48K, no reasonable offer refused. New Kaga monitor £75. Tel: 0438 811082, Hertfordshire.

CANON PJ1080A ink-jet colour printer for sale. Absolutely as new. £450. No offers. Deliver around south Essex for price of petrol. Phone Chris 01-836 8651, working hours only.

COMMODORE 64, C2N cassette recorder, joystick, Introduction to Basic parts 1 and 2, Maths 1, 7 games. New value £330, will sell for £210. Will sell software at £50 separately. Phone Meifod 224.

CONTACTS. Jonathon Reynolds, c/o Australian Embassy Rome, 215 Via Alessandria, 00198 Rome, Italy would like BBC users to swap info, pass on tips, etc. Please write.

CUMANA disc drive for sale. 400k double sided, double density, 80 track, own power supply and lead. Including manual and formatting disc. £250 ono. Also for sale: Word-wise, £22. Tel: (0222) 758897.

CUMANA 40trk drive for quick sale, with cable for BBC B, perfect working condition. £100. Ring 831 7411 Ex 282, day.

CUMANA 100k disc drive, used four times only. Could deliver around Bristol. Tel: 0272 565149.

DAISYBAND printer. Plugs into serial interface socket. Upper and lower case. Works perfectly with BBC computer. £85 ono. Ruislip 30344.

400K disc drive for sale. Microware ZL242 dual double sided 40 track disc system, with leads utilities, mains powered. £299 ono. Tel: 0202 885166 evenings.

100K disc drive, Cumana, with PSU, 6 months old, boxed, with cables and 10 disks—£90. Tel: Winchester (0962) 883965.

DISC drive £50. Acorn/Olivetti 40 track SS uncased. In working order but needs mechanical adjustment. Workshop manual available. North Herts. Area. Aries, tel: 058-283-3937.

DISC drives. Dual 800k Mitsubishi's. Own PSU and metal case: £400. Grafpad with full CAD software, as new: £100. Morphy Encore Chess computer including Ni-cad battery pack: £80. Tel: 01-743-1579 (evenings).

DISC drives and interface: dual d/s 40 track drives with Kenda double density interface. As new, cased with cables, utilities. Capacity 800k. £390 or offers. Phone Tunbridge Wells (Kent) 0892-33434 anytime.

8271 disc interface chip wanted for cash. Telephone Broadstone (0202) 602660 after 7 pm.

DRAGON 32, joysticks, cassette, software worth £320+. Swap for printer, monitor, or teletext adaptor for BBC B. D Barker, 38 St. Aidans Ave, Grangetown, Sunderland SR2 9SF, Tyne and Wear.

DISC interface, complete with AMCOM DFS, utilities disc and manual; allows Page to be set to &1500 and 63 files per disc. £60 ono. Tel: 090 567488, evenings.

DRAGON 32, joysticks, cassette and software worth £320+. Offers? 38 St Aidans Ave, Grangetown, Sunderland SR2 9SF, Tyne and Wear. D. Barker.

DRAGON micro plus Delta DOS, joysticks, cover and all cables. VGC. Also disc and cassette software (business and games). £200. May consider split. Tel: (0254) 396033.

DUAL single sided 40 track disc drive with Acorn disc upgrade, £300 ono. Also Torch Z80 card £150. 0252 710566, Farnham, Surrey.

EARLY copies of computer magazines for sale in perfect condition. Some bound. Sae for list. Burton, 37 Green Road, Southsea, Hants. Tel: (0705) 811760.

ELECTRON joystick interface made by Signpoint. Brand new and with instructions. £15 ono. Tel: 856 8790.

EPSON RX80 F/T, few months old, hardly used. No longer needed. In original packaging, as new. Quick sale, hence £250. Phone Luton (0582) 20691.



Ariadne Software Ltd
have vacancies for
**ASSEMBLER CODE
PROGRAMMERS**

to work on BBC BITSTIK,
Microtext, Compunet

Pleasant informal work environment,
considerable responsibility, and the
opportunity to work on advanced systems
software. Salary negotiable depending on
experience.

For further information write to Personnel,

Ariadne Software Ltd,
275 Kensal Road, London W10,
or phone 01-969 6488

NEW * AIRBRUSH *

A Graphics tool for the
BBC micro B

Check these features:-

- * Amazing Airbrush effect on Screen.
- * Operates in Modes 0 and 1.
- * Screen LOAD and SAVE options.
- * Variable 'spray' area.
- * Example Mode 0 picture on disc.

(The Orion Nebula)
40-Track Disc Only.

Send cheque or p.o. for
£7.95 to:-

P. Sharpe,
Llwydfan, Minffordd Road,
Penrhyndeudraeth, Gwynedd
LL48 6AU.

Harrier™

BBC/ELECTRON*
Compatible Joystick

£10⁹⁵ Include VAT and P&P

Special Features:

1. Firm grip handle
2. Self centring
3. Dual fire buttons
4. Plug direct into A/D socket
- no software/interface required
5. Suitable for most
joystick games
6. Rugged construction
for durability



* Electron
requires
joystick
interface
to use
joystick

Available from all
good BBC Computer
Dealers and Chain
Stores.
Or Mail Order only
from:

TRADELINK U.K.

Dept. AU, 21 Broughton St., Edinburgh EH1 3JU
Tel. 031-557 4138

Distributor/Dealer enquiries welcome

HIGHLIGHT SOFTWARE

B.B.C.+ELECTRON

READ-RIGHT-AWAY

".....I suspect these are the sort of programs
children will enjoy taking home in days to come for
learning with these really is fun, and mums and dads
will play with them after children are tucked up in bed
just for the pleasure of the graphics....."

A & B COMPUTING.

Reading Pack 1. Age 5-8

SPLASHDOWN

Building 3 letter words

FIREFIGHT

sl-,sm-,sn-,sp-,bl- etc.

Reading Pack 2. Age 6-9

PYRAMIDS

th-,ch-,sh-,wh-.

SPLOOSH

oo-,ee-,ea-,oi-,ou-,oa-,ai-.

Reading Pack 3. Age 7-10

MAGIC E

"Magic e" spelling rule.

BREAK-IN

Soft "c"/soft "g" sounds.

Reading Pack 4. Age 8-11

SORTOUT

Alphabetical sorting.

LETTERBUGS

Unscrambling hidden words.

Available now from MICROPOWER DEALERS, selected branches of
JOHN MENZIES and by mail order (please state whether you
require B.B.C. or ELECTRON version).
Telephone or write for our new catalogue with details of our
full range of programs.

PRICE PER READING PACK:

CASSETTE: £ 7.95 40 TRACK DISC: £11.95

All prices include V.A.T.



Highlight Software,
36, Sherbourne Close, Barry, S. Glam. CF6 5AQ
Telephone: (0446) 745482

THE MICRO PULSE 5.25" DISC DRIVES

ANNOUNCEMENT

* Northern Computers announce 6 new models of Micropulse 5.25" disc drive, manufactured and assembled in the North West, for the BBC computer. These drives are exactly compatible with the two Acorn/BBC disc formats. They are based on the highest quality Teac mechanisms with built-in power supply, as previously supplied by Cumana Ltd.

* Prices from **£119.95** + V.A.T.

* Also: High Quality 3" Compact Disc Drives

* Prices from **£129.95** + V.A.T.

* Each Micropulse disc drive is supplied with a BBC cable, formatter utility disc and comprehensive 55page disc filing system manual for the BBC computer.

* For further details send large S.A.E. to :



Northern Computers,
Churchfield Road,
FRODSHAM
Cheshire WA6 6RD
Tel: 0928 35110

THE MICRO PULSE EXTERNAL ROM BOARDS

For the BBC Computer and the Acorn Electron

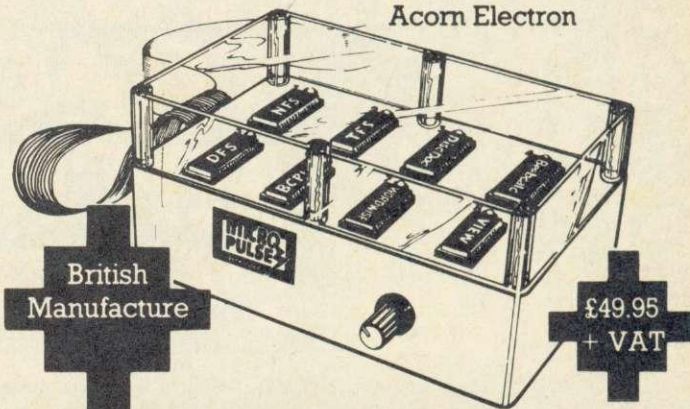

- ◆ BRITISH MANUFACTURE
- ◆ ALLOWS 8 ROMS ON LINE
- ◆ HARDWARE-BASED ROM SELECTION AVOIDS SOFTWARE INTERACTION BETWEEN UTILITY ROMS
- ◆ SWITCH TO REQUIRED ROM USING MANUAL SWITCH OUTSIDE THE UNIT
- ◆ RED LIGHTS INDICATE THE SELECTED ROM
- ◆ HIT "BREAK" TO ACCESS ROM, NO NEED TO USE SOFTWARE COMMAND
- ◆ INCLUDES ZIF SOCKET, FOR INSTANT CHANGING OF A SELECTED ROM
- ◆ INCLUDES BBC CABLE AND ROM SOCKET CONNECTOR
- ◆ INCLUDES SIMPLE FITTING INSTRUCTIONS, JUST PLUG IN AND GO!

please contact: Gareth Littler
Mark Howard or
Judith Allen at
Micro Pulse
Division



Churchfield Road,
FRODSHAM
Cheshire WA6 6RD
Tel: 0928 35110

ACORN USER ADVERTISEMENT PAGES - OCTOBER ISSUE

AB Designs	142	Diamondsoft	186	Microtek	161
Abacus Business Machines	161	DRG Business Systems	171	Microvitec	8
Abacus Soft	82	Duckworth	178	Microware	75
Acorn	90	ECCE	186	Musicsoft	34
Acornsoft	188/189	Elbug	128	Newark Video	162
Acornsoft	16/17	Electronequip	92/93	Newnes Technical Books	191
Acornsoft	178	English Soft	82	Northern Computers	206
Addictive Games	154	Epic Software	193	Opus	34/115/127/142/196
AJ Vision	152	Garland Computers	172	Pace	174
Akhter	48/49	GCC (Camb) Ltd	140	Paw Systems	66
Akhter	14	Gemini	25/26	Peter Sharpe	204
Ariadne Soft	204	Golem	186	Phimag	4/5
BBC Publications	6	Griffin	191	Proxima	50
Beebug	192	GSL	136	Quxstor	202
Beebugsoft	88/89	HCR Electronics	50	Racey Designs	203
Beebugsoft	180/181	Highlight	204	Raven Micro-Products	158
Benwick Electronics	202	Icon Soft	28	SCI (UK)	76/77
Brother Industries	87	Infrascope	126	Screens	199
C-Tech	63	Intec	1	Shards	132
Cambridge Microcomputer Centre	80	Intelligent Interface	134	Shiva Publishing	184
Care Electronics	118	Interface	162	Shumwari	178
ChaseData	176/177	John Wiley & Son's Ltd	184	Silent Computers	162
Cheetah	72	Kansas	64	SIR Computers	150/154
CJE Micros	122	Keyzone	129	Skywave Soft	150
Clares	194/195	Lincoln Micros	168	Social Science Software	199
Clwyd Tecnics	80	Loco Systems	148	Software Supermarket	91
Colisoft	203	LVL	1FC	Solidisk	36/37
Communitel	60	Mayday	203	Statacom Distribution	193
Computer Concepts	116/166/198	Mayfair Micros	200	Superior Software	1BC/74/163
Computerama	52	Merlin	183	Synergy	84
Computerlink	191	Micahels Business Systems	66	System	131
Computerwise	121	Micro Management	55/56/57	Systems International	58
Control Telemetry	54	Micro Repair-Club	34	Tandy	163
Corgi/Addison Wesley	164	Micro Test	78	Technomatic	74
Cumana	11	Micro-Advent	186	Three D Computers	200
CYB Design	66	Micro-Investor	54	Trade Link (UK)	34
Data-Technology	12/13	Micro-Resources	202	Viglen	143/145/147/149/151/153
Database	73	Microbyte Soft	68	Vine Micros	127
Dataefficiency	31	Microfast	156	Virgin Games	71
Datapen	138	Microfix	152	Voltmace	205
Datastar	129	Microman	138	Watford	OBC
Datastore	191	Micropower	OBC/32/71/205	Wessex Micro-Computers	116
DE Systems	199	Microstyle	124/125	West Coast Personal	140

BEAM DESIGN

- For architects, engineers, surveyors, builders, etc.
- Analysis of simply supported beam with any combination of multiple point loads, u.d. loads and triangular loads.
- Steel beam design to BS.449 with selection of suitable single and double sections from standard range of RSJs, Channels, UBs and UCs.
- Timber design to CP.112 permits choice of species/grade and single, double or triple built-up members.

- Allows user to instantly switch between steel and timber modes and browse through the entire range of suitable sections.
- Output to printer for L.A. checking includes all loading data, reactions, max. bending moment, deflection and full details of chosen section(s).
- Separate graphics version displays BM and SF diagrams (but not steel or timber sections).
- Available for BBC model B. Cassette £40, disc £45.

Send large SAE for specification showing printout.

BEAMSCAN, 20 Vaughan Avenue, Hendon, London NW4 4HU

■ **Advanced User Guide binders.** Stiff plastic backed, titled, open flat, ring binders, £3.50 inc. p&p. Hepworth & Co., Waulkmill Farm, Ingersley Vale, Bollington, Cheshire SK10 5BP.

■ **Backup** valuable discs including dual format 40/80 types. Disk Duplicator II, personal use only, requires Acorn DFS, 40/80 track disc, £8.95. H. Spurr, 13 The Avenue, Trimley St Mary, Ipswich IP10 0TT.

■ **Beeb** cheat sheet for only £1. You can cheat on 10 of your favourite games. Cheque/PO and SAE to L Dawson, 3 The Meadows, Rainhill, Merseyside.

■ **BBC Morse code trainer.** 5-20 wpm. Exercise tapes available. Heliography. Learn to read flashing light at 5 wpm. £4.50 each. Mr Caswell, 96 Oakdale Close, Ovenden, Halifax, W. Yorks.

■ **BBC/Electron.** Image-ultimate tape back-up copier. Copies with locks, any length, files, 300 + 1200 baud, ?'s in filename, false addresses. Locks/unlocks programs. 100% M/C. £3.80. P. Donn, 33 Little Gaynes Lane, Upminster, Essex RM14 2JR.

■ **Compact BBC disk drives.** Group purchasing dual D/D 5 $\frac{1}{4}$ " 40/80, guarantee VAT, carriage included. Unboxed: s/s £262.50, d/s £320.00. Boxed: s/s £286.65, d/s £351.05 including utility disk, manual (+ power £30). Baldock 895405.

■ **Copier.** Back-up copier for BBC B OS1-2/Electron. 100% m/c. Copies almost anything. £3.50. Cannibal Software, 145 Woodville Road, Cathays, Cardiff.

■ **Copycat** copies most protected discs. Supplied with manual. Please specify 40 or 80 track disc. £8.95 from Integral Software, 11 Grove Park, Bangor, Co. Down, N. Ireland BT20 5QG.

■ **Dictionary** for View: check your spellings with this fast menu-driven program. Single/dual disc system, fully expandable from the 6000 words supplied. £10. Polarsoft, 9 Grayshot Drive, Blackwater, Surrey GU17 0EW.

■ **Discounts** on computers and peripherals, most makes, large and small, hardware only. Some used equipment bought and sold. Tel: Ascot 26875 or Crawley 883853.

■ **Disc drive.** Cumana CD800S dual double sided 40/80 track, switchable, with manual and formatting disc. As new. Cost £465, selling for only £300. Tel: Maidenhead 73769.

■ **EPROMs** utilities. ROM writer writes initialisation code, *help, *command routines for you. R.F.S. program formatter. ROM copier. £6.50. D. Lister, 37 Powicke Drive, Romiley SK6 3EG.

■ **EPROM** programming service. Send your programs on tape/disk and create your sideways ROMs. 8k - £15, 16k - £28. Ms C. Gouyon, 51 Codenham Straight, Kingswood, Basildon, Essex SS16 5DJ.

■ **Epson RX80F/T** and Teac SS 80trk disc drive. Together £350 ono, will sell separately. Ring 555-9586 after 6 pm.

■ **Floppy disks** (5 $\frac{1}{4}$ " with five year warranty). SSSD 40 track £1.19, SSDD 40 track £1.49, SSDD 80 track £2.19, DSDD 80 track £2.49. 500 pack mailing labels 4" x 1 $\frac{1}{16}$ " £4.95. 500 sheet 11" x 9 $\frac{1}{2}$ " listing paper £4.95, BBC printer cable (1 metre) £8.95. All prices inclusive. Send SAE for list to Mistry Micro Services, 75 St. Margaret's Road, Bradford BD7 2BY.

■ **Games.** Frogger arcade game (cross the river + road). One-armed bandit with hold, nudge + gamble. Both in mode 2, full sound + colour graphics. Both for £3.99. Cheque/PO to S. Houghton, Greenbank, Broseley Lane, Kenyon, Nr Warrington, Lancashire. Tel: 092-576 3522.

■ **Geography** UK. Draws full map, three magnifications, blow up any section, full on-screen editing, save, load, screen dump, £5. SAE for examples and manual. BHL Software, 310 Darley Avenue, Chorlton, Manchester M21 2HS.

■ **Hijacker II** Ultimate disc back-up utility. £5 inc. Also 'Cypher', gives password protection to discs. £4 inc. SAE for details, other programs. Aggressive Software, 14 Elmore Road, Sheffield S10.

■ **Home Accounts** BBC B. Extensive and user friendly. Up to 300 transactions. Automatic standing orders. £3.95 inc. R. Brookes, 6 Thirlmere Avenue, Elland, Halifax, West Yorkshire.

■ **"How-To"** move software from tape to disc. Utilities + extensive text, hints, tools. Recommended to frustrated disk-owners. £5. R-Soft, 22 Marriotts Close, Felmersham MK43 7HD, Beds. 0234-781730.

■ **Journal** index system for BBC 'B' plus disc-drive. Create then Search your journal article database. Holds journal name, month/year, author(s), title and comment for up to 700 articles. Search by author, journal and/or user-defined keyword dictionary of 250 words. A truly professional program already used in Universities and other educational institutions. 40 track disk - state single/double sided. Single/double drive, £20 including manual, from K. A. Spencer, 74 Dovers Park, Bathford, nr Bath, Avon.

■ **Joysticks** - top quality at amazing low price. Only £10.95 a pair. Easier to handle and faster than others costing twice as much. Cheque/PO to Peritron, 21 Woodhouse Road, London N12 9EN.

■ **Metal** BBC micro car badges (owl design), 2 colour. Also Spectrum car badges, 6 colour. £4.25 each including p&p from: Hawthorn, 90 Victoria Street, Hyde, Cheshire.

■ **Money, Money, Money.** Proven programs for all horse racing or football pools forecasting. Send £12 to The Butronics Co., Penjerrick House, Budock, Falmouth, Cornwall.

■ **Music** teachers/students. Three big programs, full graphics, CSE & O level dictation, exam format, many levels. TDK46 cassette £7.90, disc (40/80) (state) £8.90. Tried & Tested. R & I Music, 14 Chaloners Hill, Steeple Claydon, Buckingham MK18 2PE.

■ **'Nutcrackers':** Tape 2 Tape + Tape 2 Disc + Disc 2 Disc + Disc 2 Tape: £5. Rompull + Tapedump: £5. Super disc menu: £5. ROM-filing system generator: £5. R-Soft, 22 Marriotts Close, Felmersham MK43 7HD, Beds. 0234-781730.

■ **Pools** BBC 32k. Enter the Pools with the most successful program available. £7.50 complete with manual and up-to-date database. E. Crosby, 10 Lodge Avenue, Manchester M31 1LL.

■ **Printwise** adds power to Wordwise/Epson. Simple commands replace messy control codes. Also Greek (FX only), macros, autonumbering! £12.50 (disc) or SAE details. Astrosoft, 39 Latimer Way, North Pickenham PE37 8JY.

■ **Programs** wanted for new software company. Good rates paid for your own original material. Cottage Software, 3 Conrad Drive, Worcester Park, Surrey 01-330 1554.

■ **ROMboards???** Fit a ROM Extension Socket to your BBC keyboard instead. Use any number of ROMs. Rapid change over. Easily fitted. £17.95 inclusive. Steelappeal, 3 Hambleton Close, Blandford, Dorset. (0258) 53742.

■ **Search** complete *Acorn User* index for that valuable hint/program/article/etc in only 5 seconds. Create/edit your own index of mags/photos/records etc. 40 trk disc with Tracer program and A.U. index, £10. Woodsoft, 12 Copsewood Ave, Nuneaton CV11 4TQ.

■ **Single-sheet** printing on a tractor-only printer (eg Epson RX80T)? Use Letter-Trac, the unique carrier-wallet. Up to A4 size, £2.30 or £3.95 for two (incl.). Cheques: Letter-Trac, PO Box 272, Compton Martin, Bristol BS18 6PY. Tel. (0761) 62445.

■ **Small** company? Good product? Need professional marketing? Hardware, software, non-technical, anything for microcomputer market considered. David Winrow Marketing, PO Box 9, Northwich, Cheshire CW9 7TP.

■ **Sprites** in mode 2 for BBC. Large 16 x 24 sprites fully compatible with discs. Generator program and manual supplied for only £5.99 + 70p p&p. I. Cornes, 3 Knowsley Park Lane, Prescot, Merseyside L34 3NA. Tel: 426 1202.

■ **Stripper II.** New version, ultimate tape back-up utility. Many new features. For BBC, Electron. Only £4 inc. Sae for details, other programs. Aggressive Software, 14 Elmore Road, Sheffield S10.

■ **Timetabling:** 40/80 disk-based formatting and analysis. Friendly, sophisticated, avoids errors. £25. Yorke House Software, 33 West Street, Oundle, Peterborough PE8 4EJ. Tel: 0832/72362.

■ **Torch Z80** disc pack plus software, BBC B plus disc interface, BBC green monitor. Total value £1400. 5 months young. Selling price £990. H. Heuschmidt, London 730 1931 after 7 pm.

■ **Torch Z80** card plus BBC Basic spreadsheet, Wordpro Filer. Unwanted gift, £275 - unused: original ROM software also unwanted gifts. Offers? Telephone West Drayton 441582, evenings only.

■ **Unwanted** prize - must spend £1800 on personal computer. Will buy to your required specification and sell to you unused for £1600. 0734 474985 evenings.

■ **Wordprocessing** (View, Wordwise), printing, listings: dot-matrix/daisy wheel (various styles). Cheap, accurate and fast. Collect/deliver in London area. Phone Mr Davies on 01-833 4040.

£10 SMALL AD SERVICE

Please include your cheque for £10 made payable to Redwood Publishing. This is the standard fee. Don't forget your name, address or phone number. Send cheque plus form to Acorn User Small Ads, 68 Long Acre, London WC2E 9JH.

ACORN
ABUSER'S

Diary

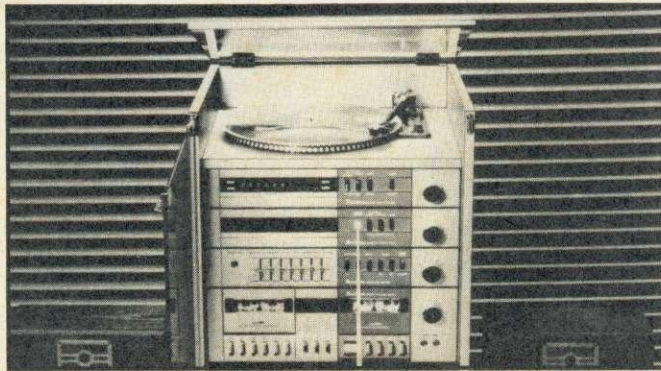

H1f1: icons, radiowave interface? three-speed disc drive

Astounding
action
by Amstrad

IT IS unusual for Acorn Abuser to benchtest machines from other manufacturers, but this month we make an exception for the Amstrad H1f1. This machine is so different from conventional micros that Hermann Hauser was heard to comment 'Was ist es?'

Imagine a machine with no monitor or qwerty keyboard, but physical icons, in-built radiowave interface and three-speed disc drive and you'll realise why Kai Gooney will describe it as 'the shape of things to come' next year.

The principle behind the machine is distributed computing. Whereas current home micros have a central microprocessor driving the memory chips and peripherals, the H1f1 has peripherals which drive themselves. The central board merely focuses the current input device to the current output device. Amstrad calls this central board the 'amplifier', a term soon to become a household word.

The input devices are a three-speed disc drive, cassette recorder and switches and dials on the amplifier. Of these the disc is the most notable. It is an internal Amstrad design and the company has made a surprising choice.

According to a spokesman the 'turntable' (Amstrad name for disc drive) will take either 7in or 11in discs at any of three speeds—33, 45 and 78rpm. With most makers going for 3in or 3.5in drives, this may seem surprising. However, Amstrad

is hedging its bets, as the spokesman mentioned the possibility of a 'compact' disc, presumably 3.5in.

Even more amazing is that the discs are read-only serial access, surely the biggest quantum leap backwards since Sinclair microdrives. The large surface area does however give a massive storage capacity and, at 78rpm, performance should be better than the aforementioned microdrives.

Rather than going for boring colour monitors as output devices, the H1f1 has a pair of 50-watt loudspeakers with optional earphones. This results in astounding sound effects for a new range of arcade games, although experts believe colour graphics could be difficult. Amstrad do sell colour monitors, but these only receive BBC programmes, so there is obviously an Acorn link-up here.

Software authors will have to learn new skills, as the H1f1 has a non-standard Basic. We'll describe it later on when we have worked out how to use it.

Amstrad makes it clear that most conventional programming languages are no good because they have no structure comparable to the basic of the H1f1. Whilst it is incredibly simple to program the H1f1 to produce sounds identical to the human voice or musical instruments, it will take time to

generate any numbers.

The system software design is brilliant. Amstrad has reassuringly continued the policy of releasing products when they are finished. Consequently the operating system is not 0.1; it doesn't hang off the back of the machine, in fact it doesn't exist at all. A look inside the amplifier proved there are no standard microprocessors, ROMs, or RAMs, but cheaper, less sophisticated circuits.

After detailed analysis Acorn Abuser found that the work of a processor and the obligatory 64k of RAM was all being done by a single transistor. Damn clever.

Amstrad has recognised the need for machines that will communicate with each other and has provided an ingenious solution. Rather than opting for network interfaces which are slow and localised, H1f1 has a radio interface called a 'tuner' (something of a misnomer because it can do nothing with tunes). Software is input via the tuner and processed directly without the need for storage on cassette. However, software can be saved onto cassette and Amstrad claims this could cut costs by 90%, so software houses should rush to support the H1f1. Hmmmm. The tuner shares the same irritating limitation as the disc drive in being read-only, but we are sure an enterprising company will produce a cheap writable tuner.

Envelope of the month

Ms. Cherry Hinton
Acorn Computers, Ltd.
Fulbourn Road
Cambridge, CB1 4JN ENGLAND

Envelope as addressed to Acorn from Microscope-84, Texas

■ ALL these business machine rumours! According to the rags it's an Advanced Business Machine, it's an Acorn Business Machine, it's a Personal Workstation Range, it's based on the 6502, it hasn't got a Z80, it has got a Z80, the big one's a 68020, it's a 16032, it's an 80286. Of course, prediction is a little difficult when Acorn are so secretive. But if you read *Acorn User*, it's as easy as ABC.

■ DOES *Oric Muser* know something we don't? We're just hearing reports from the Palace that as well as Prince Andrew being an *Aviator* addict, Prince Charles is dating a girl called Diana...

■ MARKETING man Tom Hairbrush has received an apology from *Computer Weekly* over an article they published naming him 'Tom Hamburg'. Uncle Tom, as he's known to his friends, described the article as 'the pits of journalism'.

■ SPEAKING of pits, it's a trifle embarrassing for Auntie Acorn when the Acorn-sponsored car crashes on Acorn race days. R&D are said to be releasing the 1.0 engine 'within a month'. (That's just longer than 28 days).

■ MESSAGE to an Acorn director. Our Editor wants his £5 loan back – or he'll spill the beans about his guitar playing.

■ ANOTHER Acorn director in trouble is Peter Winalot for blowing the engine on a Ford Caterham racing car on a practice circuit at Silverstone.

■ HAD anyone heard of MSX before Chris Curry started being paranoid about it?

■ IT WAS so nice to receive a postcard from Barry Woodentop on his holidays. He goes to Silicon Valley each year 'to get away from it all'. Oh Barry, if you're reading, there are two 'r's in 'squirrel'.

■ WHY does Acornsoft's new marketing manager Jeremy Piston-Engine wear such outlandish bow-ties? Is he one of the *elite*?

■ ASTOUNDING fact 1001: Computer Concepts boss Chas Moir is a carrot fanatic.

■ TRIED typing the command 'daytona' in on View?

**TWO SENSATIONAL NEW RELEASES
FROM SUPERIOR SOFTWARE**

SPECIAL OFFER!
Order both
directly from
us and deduct
£1 from each.



STAR STRIKER (32K) £7.95
A multi-stage arcade-style game in which you take control of a 3-stage rocket equipped with 4 side lasers and a central laser cannon. Not only must you defend the rocket against the 6 types of circling alien, and avoid the asteroids and fireballs, but you must also attempt to dock the separate stages of the rocket together. Stunning graphics, sound effects, introductory tunes, hi-score and rankings. Another excellent program from Superior Software. (KEYBOARD or JOYSTICKS)

OUR PROGRAMS ARE NOW AVAILABLE FROM OVER 1000 OUTLETS THROUGHOUT THE UK AND OVERSEAS. SEE YOUR LOCAL DEALER!

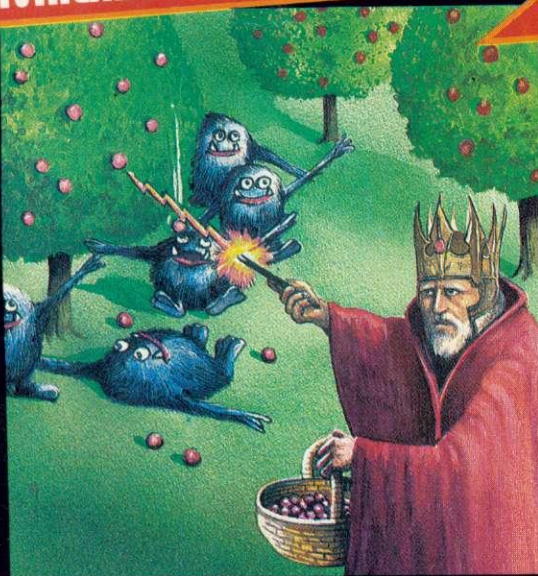

MR. WIZ (32K) £7.95
From the author of Percy Penguin, Mr. Wiz is a fast-action multi-scene game. Guide Mr. Wiz around the garden to eat the cherries whilst avoiding the evil gremlins. The gremlins can be killed by dropping apples on them or by throwing the crystal ball. Extra points can be gained by eating the magic mushroom, but beware... this is the home of the gremlins and makes them permanently furious! Sound effects and tunes, hi-score, rankings. Superb arcade-style action. (KEYBOARDS or JOYSTICKS).

WE PAY UP TO 20% ROYALTIES FOR HIGH QUALITY BBC MICRO AND ELECTRON PROGRAMS



SUPERIOR SOFTWARE LTD.

Dept. AU10, Regent House,
Skinner Lane, Leeds 7
Tel: 0532 459453

OUR GUARANTEE

- (1) All our software is available before we advertise.
- (2) All our software is despatched within 48 hours by first-class post.
- (3) In the unlikely event that any of our software fails to load, return your cassette to us and we will immediately send a replacement.

M I C R O P O W E R M I C R O P O W E R M

ANOTHER INCREDIBLE CHALLENGE FROM BRITAIN'S LEADING SOFTWARE HOUSE

FELIX

Meets
The

EVIL SWEEVILS



Clamber up the pipes, dodging the cascading ball bearings to despatch the Weevils and Superweevils using your spray can. Features oxygen cylinders, bonus letters, belt lever and panic button.
NEW PRICE! B.B.C. and Electron cassette: £6.95. B.B.C. disk version: £9.95.

(B.B.C. MICRO VERSION)

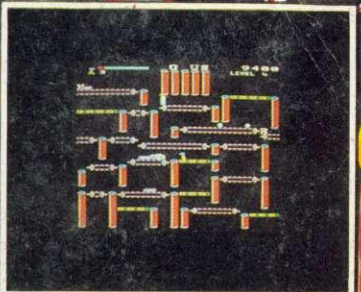

electron
B.B.C. MICRO

**M I C R O
P O W E R**

MICRO POWER LTD.,
NORTHWOOD HOUSE, NORTH STREET,
LEEDS LS7 2AA TEL: (0532) 458800
MICRO POWER SOFTWARE IS AVAILABLE FROM
SELECTED BRANCHES OF WH SMITH, BOOTS, JOHN
MENZIES, CO-OP, WOOLWORTHS AND ALL GOOD
DEALERS.
AUTHORS! WE PAY 20% ROYALTIES!

"WATCH OUT
FOR THE FANTASTIC
NEW PACKAGING!"

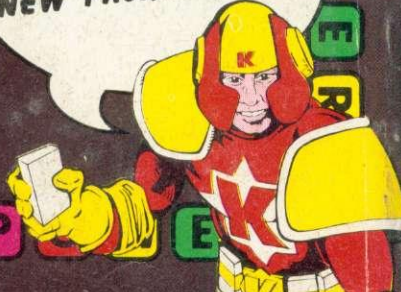

M I C R O P O W E R M I C R O P O W E R M