

## Presence of Peroxylradicals in Cigarette Smoke and the Scavenging Effect of Shikonin, a Naphthoquinone Pigment

Masahiro NISHIZAWA,<sup>a</sup> Masahiro KOHNO,<sup>a</sup> Minemitsu NISHIMURA,<sup>b</sup> Akio KITAGAWA,<sup>b</sup> and Yoshimi NIWANO<sup>\*,a,b</sup>

<sup>a</sup>New Industry Creation Hatchery Center, Tohoku University; Aoba, Aramaki, Aoba-ku, Sendai 980–8579, Japan; and

<sup>b</sup>Business Development Division, Sunny Health Co., Ltd.; Yaesu Center Bldg., 1–6–6 Yaesu, Chuo-ku, Tokyo 103–0028, Japan. Received February 21, 2005; accepted April 18, 2005; published online April 21, 2005

Using a new method having been developed for the purpose of quantitative determination for peroxyradicals, the presence of peroxyradicals was proved in cigarette smoke. In brief, peroxyradicals in cigarette smoke were measured by ESR spectrometry coupled to non-reductive scavenging of 1,1-diphenyl-2-picrylhydrazyl (DPPH). As a result, peroxyradicals were found to be major reactive oxygen species (ROS) since the concentration of peroxyradicals recovered from cigarette smoke was much higher than that of any of other ROS (superoxide and hydroxyl radical) and nitric oxide. Furthermore, several antioxidants (ascorbic acid, reduced glutathione, epigallocatechin gallate, shikonin) were examined for scavenging activity against peroxyradicals in the cigarette smoke. Among them shikonin alone exerted the scavenging activity, suggesting that shikonin is promising antioxidant for cigarette filters because of its effectiveness against broad range of ROS including peroxyradicals, heat resistance, nonvolatility and high affinity to the filter.

**Key words** peroxyradical; cigarette smoke; ESR; scavenging activity; shikonin

In addition to the association of cigarette smoking to cardiovascular diseases, stroke, chronic bronchitis, chronic obstructive pulmonary disease and emphysema, epidemiological data have been establishing that cigarette smoke is one of the major causes of lung cancer.<sup>1–3</sup> While addiction of cigarette smoking is supposed to be attributable to nicotine that is not carcinogenic, carcinogenicity is considered to be caused by byproducts produced by combustion of tobacco.<sup>3</sup> Among the byproducts, enormous amounts of free radicals and reactive oxygen species (ROS) are estimated to be present. That is, carbon- and oxygen-centered organic radicals and a high concentration of NO are proved to be present by electron spin resonance (ESR) study, and carbon-centered radicals rapidly scavenged by molecular oxygen give oxygen-centered alkoxyradicals.<sup>4–6</sup> Although peroxyradicals are presumed to be produced in the gas-phase cigarette smoke,<sup>6</sup> the clear evidence has not been existed. Recently, we have found that a stable radical 1,1-diphenyl-2-picrylhydrazyl (DPPH) is a useful agent for the quantitative measurement of peroxyradicals.<sup>7</sup> In brief, as shown in Fig. 1, non-reductive DPPH-scavenging by peroxyradical is quantitatively determined by ESR analysis. In this study, we report that peroxyradical(s) was proved to be present in the gas-phase cigarette smoke using the method described in our previous study.<sup>7</sup>

Several studies have been conducted to inactivate free radicals from cigarette smoke by using antioxidants.<sup>8–11</sup> As indicated in the previous study,<sup>10</sup> antioxidants used should necessarily be effective against broad range of free radical species, be heat resistant, nonvolatile and display high affinity to the filter. Shikonin, a red naphthoquinone derivative, is

an active principle of the medicinal plant *Lithospermum erythrorhizon*,<sup>12</sup> and is in folk medicine where it is claimed to possess wound healing and anti-inflammatory activity.<sup>13–16</sup> Those activities of shikonin are considered to be associated with its scavenging activity for oxygen radicals.<sup>16,17</sup> Since it has recently been reported that shikonin shows highly efficient antioxidative activities against several types of reactive oxygen species, such as singlet oxygen, superoxide anion radical, hydroxyl radical and *t*-butyl peroxyradical,<sup>18</sup> we examined the scavenging activity of shikonin for peroxyradicals in cigarette smoke in comparison with that of other antioxidants.

### Experimental

**Materials** 5,5-Dimethyl-1-pyrroline-*N*-oxide (DMPO) and *N*-methyl-D-glucaminethiocarbamate (MGD) were purchased from Labotec Co., Ltd. (Tokyo, Japan), DPPH was from Tokyo Kasei Kogyo Co., Ltd. (Tokyo, Japan), and 2,2,6,6-tetramethyl-4-hydroxypiperidine-1-oxyl (TEMPOL) was from Sigma-Aldrich Corp. (St. Louis, MO, U.S.A.). Ascorbic acid, epigallocatechin gallate, reduced glutathione, and shikonin were purchased from Kanto Kagaku Co., Ltd. (Tokyo, Japan), Roche Vitamin Japan (TEAVIGO<sup>TM</sup>, Tokyo, Japan), Sigma-Aldrich Corp. (St. Louis, MO, U.S.A.) and Tokyo Kasei Kogyo Co., Ltd. (Tokyo, Japan), respectively. Bovine hemoglobin was purchased from Nacal tesque Co., Ltd. (Kyoto, Japan). All the other reagents used were of analytical grade. Cigarettes used in this study were commercially available ones (Seven Stars, Japan Tobacco Inc., Tokyo, Japan), and each cigarette with a charcoal filter contained 14 mg of tar and 1.2 mg of nicotine.

**ESR Analyses** Measurement conditions of ESR for superoxide, hydroxyl radical, nitric oxide (NO) and peroxyradicals are summarized in Table 1.

**Suction of Cigarette Smoke** A smoking device for cigarette smoke is illustrated in Fig. 2, in which the rate of sucking gas was adjusted to 0.75 l/min.

**Quantitative Analysis of Superoxide, Hydroxyl Radical and NO** Superoxide and hydroxyl radical in the cigarette smoke were quantitatively analyzed by ESR spectrometry coupled to spin trapping with DMPO. An aliquot (180  $\mu$ l) of the reaction mixture obtained after the exposure of cigarette smoke to 2.0 ml of 1.1 M DMPO aqueous solution at 0.75 l/min for 60 s was immediately transferred to a quartz sample cell for a ESR spectrometer (JES-FA100, JEOL, Tokyo, Japan). The signal intensity of each spin adduct (DMPO–OOH from superoxide and DMPO–OH from hydroxyl radical) was recorded for quantitative analysis. Since the half-life of DMPO–OH is much

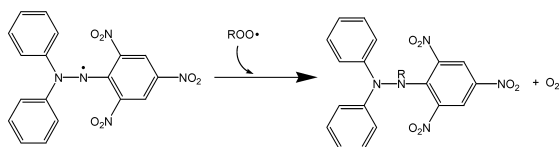

Fig. 1. The Reaction Scheme of Non-reductive DPPH-Scavenging by Peroxyradical

\* To whom correspondence should be addressed. e-mail: y.niwano@sunnyhealth.co.jp

Table 1. ESR Measurement Conditions for Reactive Oxygen Species (ROS) and NO

ROS	MW freq/GHz	Magnetic field/mT	Mod width/mT	Amplitude
Superoxide, Hydroxylradical	9.426	335.7±5.0	0.07	500.0
NO	9.427	329.5±7.5	0.40	800.0
Peroxyradical	9.427	335.7±5.0	0.10	250.0

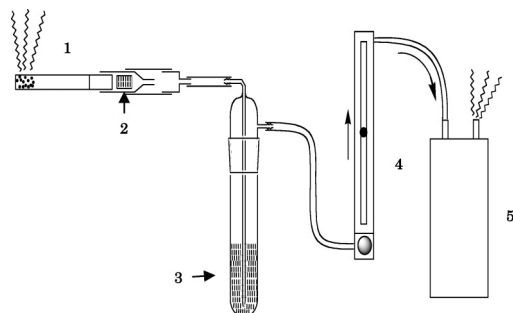

Fig. 2. Schematic Figure of the Smoking Device

1: cigarette with charcoal filter, 2: filter in which shikonin, ascorbic acid, reduced glutathione or epigallocatechin gallate is contained, 3: spin trapping or DPPH solution, 4: flow meter, 5: pump.

longer than that of DMPO–OOH,<sup>19,20</sup> the signal intensity of DMPO–OH was measured after the signal intensity of DMPO–OOH disappeared.

NO was similarly analyzed by ESR spectrometry coupled to spin trapping with Fe–bis(*N*-methyl-D-glucaminethio-carbamate) (Fe–MGD<sub>2</sub>) complex. Ten mM Fe–MGD<sub>2</sub> complex aqueous solution was prepared from the mixture of equal amount of 20 mM FeSO<sub>4</sub> and 200 mM MGD aqueous solutions. An aliquot (180 μl) of the reaction mixture obtained after the exposure of cigarette smoke to 2.0 ml of 10 mM Fe–MGD<sub>2</sub> complex aqueous solution was immediately transferred to a quartz sample cell for the ESR spectrometer. The signal intensity of spin adduct (MGD<sub>2</sub>–Fe–NO) was recorded for quantitative analysis. Since it was reported that in some cases a nitrogen-containing compound such as hydroxyurea can be oxidized to form NO,<sup>22</sup> we checked whether the signal of the adduct was derived from primarily existing NO by adding hemoglobin that is a potent scavenger for NO. Bovine hemoglobin was added to the Fe–MGD<sub>2</sub> complex aqueous solution (to be a final concentration of 5 mM Fe–MGD<sub>2</sub> aqueous solution containing 25 mg/ml of hemoglobin) and the signal intensity of MGD<sub>2</sub>–Fe–NO was similarly recorded up to 20 min. The quantitative determinations for superoxide, hydroxyl radical and NO were performed by being compared with the signal intensity of Mn<sup>2+</sup> as an external standard that was normalized in given concentrations of TEMPOL solution. Each ESR measurement was started 60 s after the exposure of cigarette smoke to each spin trapping agent was stopped.

**Quantitative Analysis of Peroxyradicals from Cigarette Smoke** Peroxyradicals in cigarette smoke were quantitatively analyzed by ESR spectrometry coupled to non-reductive scavenging of DPPH as reported previously.<sup>7</sup> An aliquot (180 μl) of the reaction mixture obtained after the exposure of cigarette smoke to 2.0 ml of 1.0 mM DPPH dissolved in ethanol at 0.75 l/min for 30 or 60 s was immediately transferred a quartz sample cell for a ESR spectrometer. The quantitative analysis for peroxyradicals was performed by monitoring the decrease in the signal intensity of DPPH, since one molecule of DPPH reacts with one molecule of peroxyradical.<sup>7</sup> In this assay system, effect of hydroxyl radical itself on DPPH is completely negligible, since ethanol used as a solvent is a potent scavenger for the radical. There is a possibility that the carbon-centered radical formed by the reaction between ethanol and hydroxyl radical acts as a scavenger for DPPH. However, we conclude that the DPPH-scavenging is a dominant reaction caused by peroxyradicals in the assay system, since this study revealed that the amount of peroxyradicals in the cigarette smoke was about 2000 times higher than that of hydroxyl radical as described in the results of this paper. In the case of NO, it was reported that NO does not react with DPPH.<sup>19</sup> There is a possibility that superoxide acts as a scavenger for DPPH. However, we conclude that the DPPH-scavenging is a dominant reaction caused by peroxyradicals in the assay system, since this study revealed that the amount of peroxyradicals in the cigarette smoke was almost 400 times higher than that of superoxide as described in the results of this paper.

#### Scavenging Activity of Shikonin and Antioxidants for Peroxyradicals

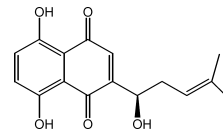

Fig. 3. Chemical Structure of Shikonin

Cellulose acetate filters with 5 mm in diameter and 10 mm in height were immersed in 10 mM of shikonin (Fig. 3), ascorbic acid, reduced glutathione, or epigallocatechin gallate dissolved in ethanol. After drying, each filter was set in the smoking device as illustrated in Fig. 2, and following the exposure of cigarette smoke to 2.0 ml of 1.0 mM DPPH dissolved in ethanol at 0.75 l/min for 60 s, peroxyradicals in cigarette smoke was analyzed by ESR as described above.

## Results and Discussion

**ROS and NO Recovered from Cigarette Smoke** The representative spectra of DMPO–OOH (for superoxide determination), DMPO–OH (for hydroxyl radical determination) and MGD<sub>2</sub>–Fe–NO (for NO determination) are shown in Fig. 4. It has been reported that the addition of superoxide dismutase (a scavenger for superoxide) and ethanol (a scavenger for hydroxyl radical) resulted in the disappearance of the ESR spectra of DMPO–OOH and DMPO–OH, respectively,<sup>23,24</sup> indicating that DMPO–OOH was derived from superoxide and DMPO–OH from hydroxyl radical. Since the signal intensity of MGD<sub>2</sub>–Fe–NO was reduced by 50% or more by the addition of hemoglobin (Fig. 5), at least 50% or more of the intensity was derived from primarily existing NO. The spectra indicate that the concentrations of superoxide, hydroxyl radical and NO trapped in the reaction mixture were 2.1 μM (4.2 nmol), 0.4 μM (0.8 nmol) and 40 μM or more (80 nmol or more), respectively. The results obtained here are in agreement with those reported previously<sup>6,25</sup> in which NO is considered to be substantially present in cigarette smoke. The signal intensity of the adduct derived from peroxyradical and DMPO was very weak and was interfered by the signal of DMPO–OH so that DMPO is considered to be inadequate for the quantitative determination of peroxyradicals. In the case of alkoxyradicals, the signal derived from the adduct of alkoxyradicals and DMPO was not observed, indicating that the amount of alkoxyradicals in the cigarette smoke is considered to be a trace level.

#### Quantitative Determination of Peroxyradicals, and Scavenging Activity of Antioxidants for Peroxyradicals

Representative ESR spectra of DPPH for quantitative determination of peroxyradicals are summarized in Fig. 6. The spectra clearly revealed that DPPH was increasingly scavenged by peroxyradicals with sucking time, and the peroxyradical concentrations trapped in the reaction mixtures were 0.33 mM (0.66 μmol) for 30 s and 0.79 mM (1.6 μmol) for 60 s. Peroxyradicals are supposed to be generated through a kinetic process<sup>5</sup> in which carbohydrates and proteins in the cigarette burn produce alkenes and NO. Then NO is oxidized

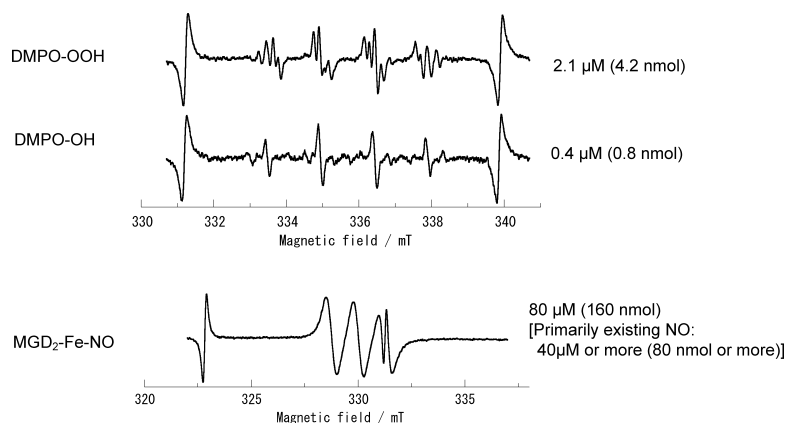

Fig. 4. The Representative ESR Spectra of DMPO-OOH (for Superoxide Determination), DMPO-OH (for Hydroxyl Radical Determination) and MGD<sub>2</sub>-Fe-NO (for NO Determination)

Superoxide, hydroxyl radical and NO were derived from the cigarette smoke.

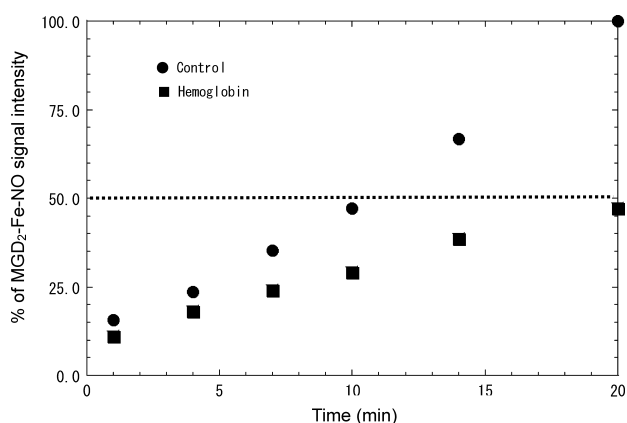

Fig. 5. The Inhibitory Effect of Hemoglobin on the MGD<sub>2</sub>-Fe-NO Complex Formation by the Reaction between Fe-MGD<sub>2</sub> and the Cigarette Smoke

The dotted line indicates 50% of the control intensity at 20 min.

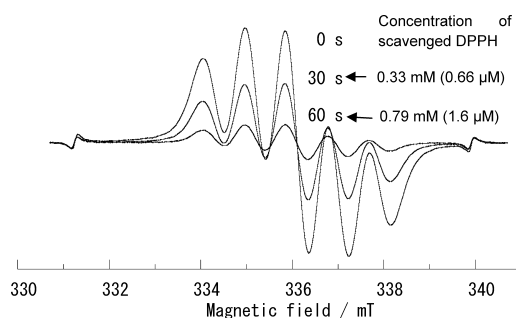

Fig. 6. The Representative ESR Spectra of DPPH for Quantitative Determination of Peroxyradicals

Peroxyradicals were derived from the cigarette smoke obtained by combustion for 30 or 60 s. The concentrations of scavenged DPPH correspond to peroxyradicals trapped by DPPH.

to NO<sub>2</sub> which reacts with alkenes to generate alkoxyradicals and peroxyradicals. However, quantitative analyses of peroxyradicals in cigarette smoke have not been reported so far. The result of the present study revealed that peroxyradicals are major ROS since the concentration of peroxyradicals recovered from the cigarette smoke for 60 s was much higher than that of any of other ROS (superoxide and hydroxyl radical) and NO. Furthermore, inhibitory effects of the filters

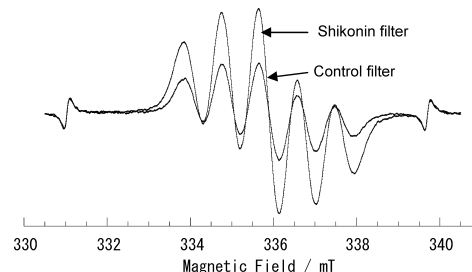

Fig. 7. The Representative ESR Spectra of DPPH Reacted with the Cigarette Smoke that Passed through the Control and Shikonin-Containing Filters

containing shikonin, ascorbic acid, epigallocatechin gallate or reduced glutathione on the degradation of DPPH were examined. Of the five antioxidants, shikonin alone exhibited an inhibitory effect on DPPH-degradation by the cigarette smoke, indicating that DPPH-reactive radicals were effectively trapped by shikonin. Representative ESR spectra of DPPH reacted with cigarette smoke that passed through the control and shikonin-containing filters are shown in Fig. 7. Since peroxyradicals are the most major radicals found in the cigarette smoke, inhibition of DPPH-degradation is considered to be attributable to mainly the scavenging effect of shikonin on peroxyradicals.

These results suggest that shikonin is promising antioxidant for cigarette filters because of its effectiveness against broad range of ROS including peroxyradicals, heat resistance, nonvolatility and high affinity to the filter.

## References

- 1) Shopland D. R., *Environ. Health Perspect.*, **103** (Suppl. 8), 131–142 (1995).
- 2) Hecht S. S., *J. Natl. Cancer Inst.*, **91**, 1194–1210 (1999).
- 3) Tønnesen P., Vermeire P. A., *Eur. Respir. J.*, **16**, 1031–1034 (2000).
- 4) Forbes W. F., Robinson J. C., Wright G., *Can. J. Biochem.*, **5**, 1087–1098 (1967).
- 5) Church D. F., Pryor W., *Environ. Health Perspect.*, **64**, 111–126 (1985).
- 6) Pryor W. A., Stone K., *Ann. N.Y. Acad. Sci.*, **686**, 12–28 (1993).
- 7) Nishizawa M., Kohno M., Nishimura M., Kitagawa A., Niwano Y., *Chem. Pharm. Bull.*, **53**, 714–716 (2005).
- 8) Greg K., *Altern. Med. Rev.*, **7**, 370–388 (2002).
- 9) Greg K., *Altern. Med. Rev.*, **7**, 500–511 (2002).

- 10) Greg K., *Altern. Med. Rev.*, **8**, 43—54 (2002).
- 11) Zhang D., Tao Y., Gao J., Zhang C., Wan S., Chen Y., Huang X., Sun X., Duan S., Schonlau F., Rohdewald P., Zhao B., *Toxicol. Ind. Health.*, **18**, 215—224 (2002).
- 12) Tabata M., *Plant Tissue Culture Lett.*, **13**, 117—125 (1996).
- 13) Hayashi M., *Nippon Yakurigaku Zasshi*, **73**, 193—203 (1977).
- 14) Ozaki Y., Ohno A., Abe K., Saito Y., Satake M., *Biol. Pharm. Bull.*, **16**, 683—685 (1993).
- 15) Ozaki Y., Ohno A., Saito Y., Satake M., *Biol. Pharm. Bull.*, **17**, 1075—1077 (1994).
- 16) Tanaka S., Tajima M., Tsukada M., Tabata M., *J. Nat. Prod.*, **49**, 466—469 (1986).
- 17) Kourounakis A. P., Assimopoulou A. P., Papageorgiou V. P., Gavalas A., Kourounakis P. N., *Arch. Pharm. (Weinheim)*, **335**, 262—266 (2002).
- 18) Gao D., Kakuma M., Oka S., Sugino K., Sakurai H., *Bioorg. Med. Chem.*, **8**, 2561—2569 (2000).
- 19) Tsai P., Pou S., Straus R., Rosen G. M., *J. Chem. Soc., Perkin Trans. 2*, **1999**, 1759—1763 (1999).
- 20) Villamena F. A., Zweier J. L., *J. Chem. Soc., Perkin Trans. 2*, **2002**, 1340—1344 (2002).
- 21) Poirier R. H., Kahler E. J., Benington F., *J. Org. Chem.*, **17**, 1437—1445 (1952).
- 22) Tsuchiya K., Jiang J. J., Yoshizumi M., Tamaki T., Houchi H., Minakuchi K., Fukuzawa K., Mason R. P., *Free Radical Biol. Med.*, **27**, 347—355 (1999).
- 23) Tanigawa T., Yoshikawa T., Takahashi S., Naito Y., Kondo M., *Free Radical Biol. Med.*, **17**, 361—364 (1994).
- 24) Zang L. Y., Stone K., Pryor W., *Free Radical Biol. Med.*, **19**, 161—167 (1995).
- 25) Zao B. L., Yan L. J., Hou J. W., Xin W. J., *Chin. Med. J. (Engl.)*, **104**, 591—594 (1991).