

BNAs: novel nucleic acid analogs with a bridged sugar moiety

Takeshi Imanishi* and Satoshi Obika

Graduate School of Pharmaceutical Sciences, Osaka University, 1-6 Yamadaoka, Suita, Osaka 565-0871, Japan. E-mail: imanishi@phs.osaka-u.ac.jp; Fax: +81 66879 8204; Tel: +81 66879 8200

Received (in Cambridge, UK) 13th February 2002, Accepted 9th April 2002

First published as an Advance Article on the web 24th April 2002

This article deals with our recent studies on the synthesis of BNAs (Bridged Nucleic Acids), novel nucleic acid analogs bearing a preorganized sugar conformation by a bridged structure. Duplex- and triplex-forming abilities of the BNA modified oligonucleotides are also described.

Introduction

The sequencing of the human genome provides various new tools and new opportunities for researches of life-science in the 21st century. In the context of the post-genome-sequencing era, the development of a general technology to regulate the targeted gene expression is highly important. Based on the fundamental features of the strict nucleobase recognition by means of Watson-Crick and Hoogsteen (reverse-Hoogsteen) hydrogen bondings, nucleic acids form duplex and triplex structures (Fig. 1). The oligonucleotides with high and sequence-specific binding affinity to single-stranded (ss) RNA and/or double-stranded (ds) DNA could serve as promising materials in antisense and/or antigene methodology (Fig. 2) not only for potential genomic drugs discovery but also for various diagnostic and biological applications. The oligonucleotides for an antisense and/or antigene application should fulfill some criteria such as (i) high-affinity and sequence selectivity towards ssRNA and/or dsDNA targets, (ii) stability towards enzymatic

Takeshi Imanishi (b. 1944) obtained his doctoral degree in Pharmaceutical Chemistry from Osaka University in 1972, spent some years at the Faculty of Pharmaceutical Sciences, Osaka University, as a Research Associate and then moved to Kanazawa University as an Associate Professor at the Faculty of Pharmaceutical Sciences. He returned to Osaka University in 1983 and was promoted to a Professor of Organic Chemistry at the Faculty of Pharmaceutical Sciences in 1990. He received the Award for Young Scientist from the Pharmaceutical Society of Japan in 1983. Now he is Professor of Bioorganic Chemistry at the Graduate School of Pharmaceutical Sciences. His current research activities are in the areas of organic and bioorganic chemistry, focused on developing useful bio-functional or bio-related compounds, such as artificial analogues of nucleic acids, coenzymes, lipids, peptides and amino acids. He is also engaged in synthetic studies on biologically active natural products.

Satoshi Obika (b. 1967) received his MSc degree in 1992 from the Graduate School of Pharmaceutical Sciences, Osaka University under the supervision of Professor Takeshi Imanishi, and joined the faculty immediately afterwards as a Research Associate. In 1998, he obtained his PhD in Pharmaceutical Chemistry from Osaka University. His current research interests are the synthesis and properties of modified nucleic acids.

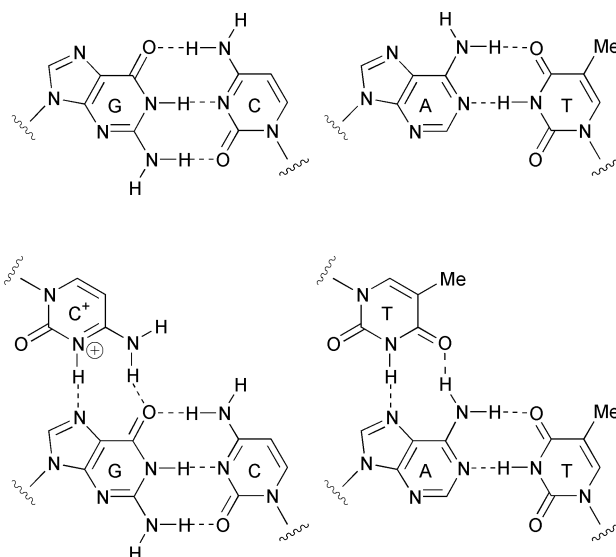

Fig. 1 Watson-Crick-type base pairs, G-C and A-T (upper), and Hoogsteen-type base triads, C⁺-G-C and T-A-T (lower).

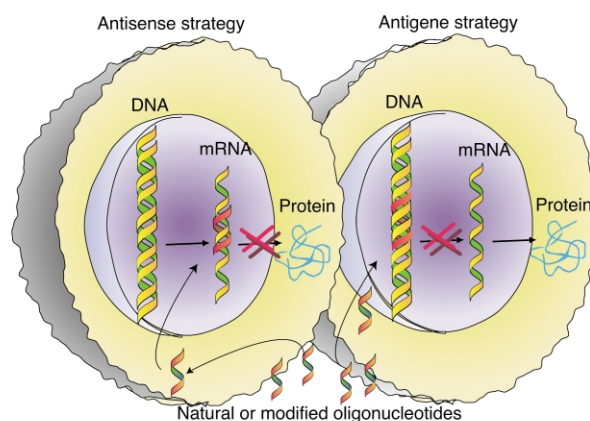

Fig. 2 Representation of antisense and antigene strategies.

hydrolysis, and (iii) efficient preparation on a DNA synthesizer, and so on. Due to the instability under physiological conditions of natural oligonucleotides, numerous artificial nucleoside (oligonucleotide) analogs have been developed and their utilization in antisense or antigene strategy has been tried.^{1–10} Recently, the first antisense drug for CMV retinitis using a phosphorothioate oligonucleotide (S-oligo) was approved by FDA.¹¹ However, the phosphorothioate modification was known to decrease the binding affinity of the oligonucleotides towards the target sequences, and to show a nonspecific interaction with some biomolecules in a cell.⁹ Therefore, further chemical innovations are still desired for development of ideal antisense and/or antigene oligonucleotides.

One attractive strategy for construction of oligonucleotide analogs having high binding affinity with ssRNA and/or dsDNA would be 'restriction of a conformational flexibility into a proper shape', as proposed earlier.^{6,12–15} A single-stranded oligonucleotide has some freely rotating single bonds in its sugar and phosphate backbone, so that it is considered as a relatively flexible molecule. The hybridization step of the flexible oligonucleotide with ssRNA or dsDNA is entropically unfavorable owing to fixation of the internal bond rotations. If the oligonucleotide flexibility decreases and its 3D structure is fixed (preorganized) in a suitable form for hybridization beforehand, the entropy loss will decrease significantly. Based on this concept, some interesting nucleic acid analogs such as bicyclo-^{16,17} or tricyclo-DNA,¹⁸ anhydrohexitol nucleic acid (HNA),^{19,20} and oligonucleotide N3'→P5' phosphoramidate²¹ have been developed. Since bicyclo-DNA was reported by Leumann *et al.*,^{16,17} some other nucleic acid analogs with a bridged sugar moiety have been synthesized.^{13–15,22–27} The structures of selected nucleic acid analogs are illustrated in Fig. 3. We synthesized and developed novel types of conformation-

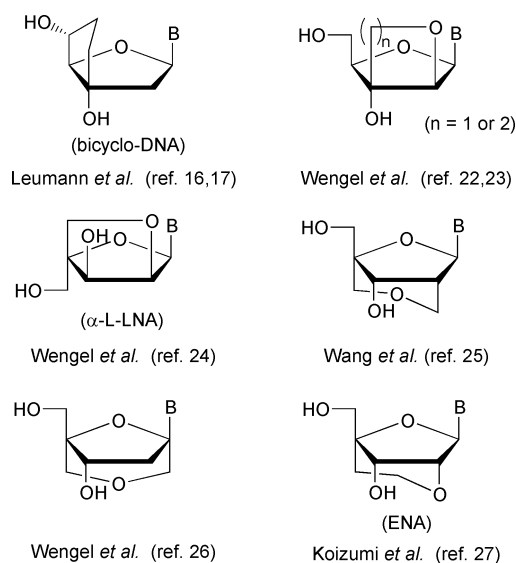

Fig. 3 Structures of selected nucleic acid analogs bearing a bridged sugar moiety.

ally restricted nucleic acid analogs, Bridged Nucleic Acids (BNAs),²⁸ such as 2',4'-BNA/LNA,^{14,15,29,30} 3'-amino-2',4'-BNA and 3',4'-BNA (Fig. 4). The 2',4'-BNA/LNA,^{14,15,29,30}

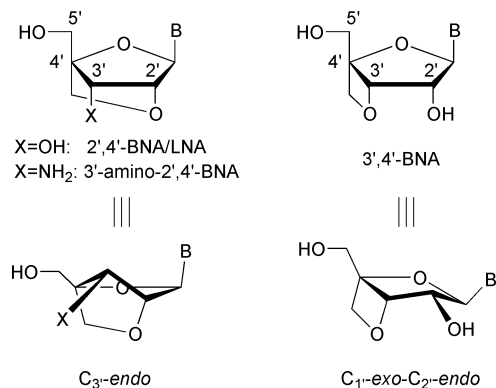

Fig. 4 Structures and conformations of BNA monomers.

which would be the most promising chemical modification of nucleic acids for antisense and/or antigene applications, was independently developed by us and by Wengel's group.³¹ In this article, we would like to review briefly the synthesis and some properties of BNAs.

Synthesis of the BNA monomers

2',4'-BNA/LNA (a linear route)

The five-membered furanose ring in nucleosides is flexible and exists in an equilibrium of two major conformations (N- and S-type conformations). In contrast, the RNA duplex exists predominantly in an A-type double helix with N-type sugar conformation, while the DNA duplex has a B-type helix with S-conformation (Fig. 5).³² On the other hand, it was reported that

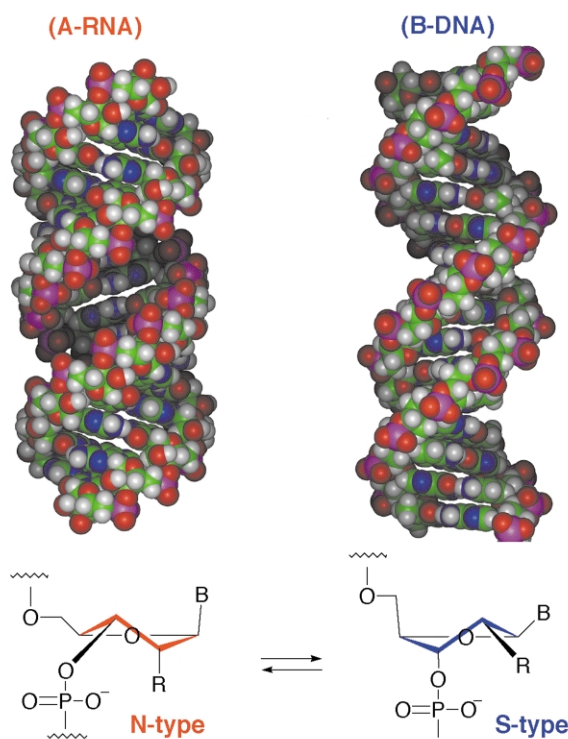
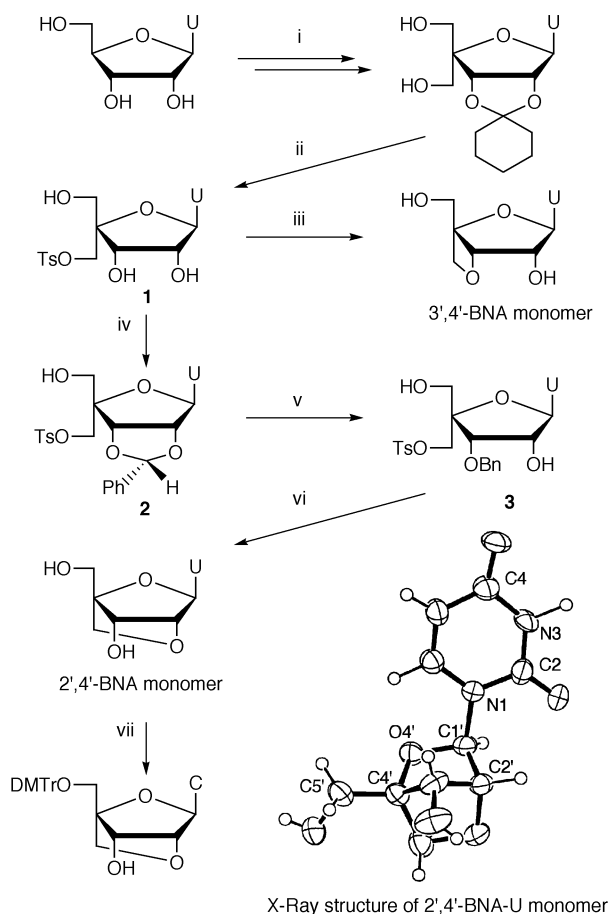

Fig. 5 Helical structures of A-RNA and B-DNA (upper), and N- and S-type sugar puckerings (lower).

the homopyrimidine RNA oligonucleotides form a more stable triplex with dsDNA than the corresponding DNA oligonucleotides.³³ This finding suggests that the sugar ring in the third strand of the triplex prefers N-type conformation to the S-type. Therefore, oligonucleotides containing nucleoside analogs with a rigid N-type sugar conformation are expected readily to enhance the hybridizing ability towards ssRNA and dsDNA.

To fix the flexible sugar-unit conformation of nucleosides into an N-type, we designed a novel nucleoside analog, 2',4'-C-methylenribonucleoside (2',4'-Bridged Nucleic Acid; 2',4'-BNA), and accomplished the first synthesis of the 2',4'-BNA/LNA monomers by a linear approach starting from uridine in 1997.^{34,35} The synthetic outline is shown in Scheme 1. The crucial step in this synthesis was a selective recognition between 2'- and 3'-hydroxy groups in **1**, which was fairly achieved by a regioselective and reductive C–O bond cleavage of the benzylidene intermediate **2** to give **3**. Its ring-closure reaction followed by debenzoylation afforded the desired 2',4'-BNA monomer. On the other hand, a direct cyclization of **1** under various conditions resulted in exclusive formation of 3',4'-BNA monomer. Conversion of uracil nucleobase to cytosine in 2',4'-BNA/LNA was readily carried out by a conventional method.³⁷

The strictly locked N-type conformation of 2',4'-BNA/LNA monomers is quite obvious from their bicyclic structural feature and was further confirmed by ¹H NMR spectral data and an X-ray crystallographic analysis, depicted in Scheme 1. The pseudorotation phase angle³² of the 2',4'-BNA/LNA-U monomer, determined from the X-ray structure, was 17°, character-



Scheme 1 Reagents: i, ref. 36; ii, (a) TsCl, Py; (b) TFA-H₂O (98:2); iii, NaHMDS, THF; iv, PhCHO, ZnCl₂; v, NaBH₃CN, TiCl₄, MeCN; vi, (a) NaHMDS, THF; (b) H₂, Pd/C, MeOH; vii, (a) DMTrCl, DMAP, Py; (b) Ac₂O, Py; (c) 4-chlorophenyl phosphorodichloridate, 1,2,4-triazole, Py; (d) NH₃ aq., dioxane.

istic of the typical C3'-*endo* sugar puckering. In addition, it is noteworthy that all the signals for H1', H2' and H3' appeared as singlets in ¹H NMR spectra.

2',4'-BNA/LNA (convergent routes)

A little later, Wengel *et al.* reported an alternative synthesis of the 2',4'-BNA/LNA monomers by employing the coupling reaction of a nucleobase and 1,2-di-*O*-acetyl-4-tosyloxymethylribofuranose derivative **5** as a key step (Scheme 2).³⁸⁻⁴⁰

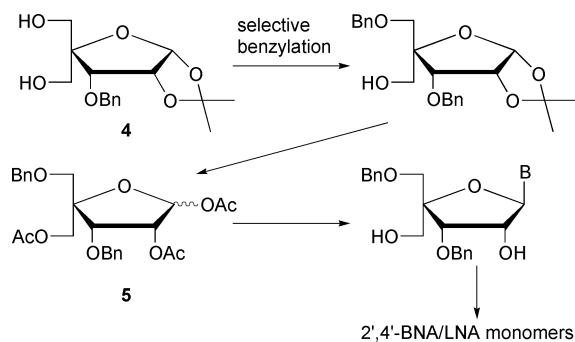

Scheme 2

Independently, we have also achieved the convergent synthesis of the 2',4'-BNA/LNA monomers in a similar manner.⁴¹ A minor drawback to this convergent route was the difficulty incurred in selective protection of two hydroxy groups in **4**. Very recently, a solution to the problem was found by Koshkin

et al. Namely, mesylation of two hydroxy groups in **4** was followed by introduction of nucleobase and subsequent cyclization to provide the convenient route (Scheme 3).⁴²

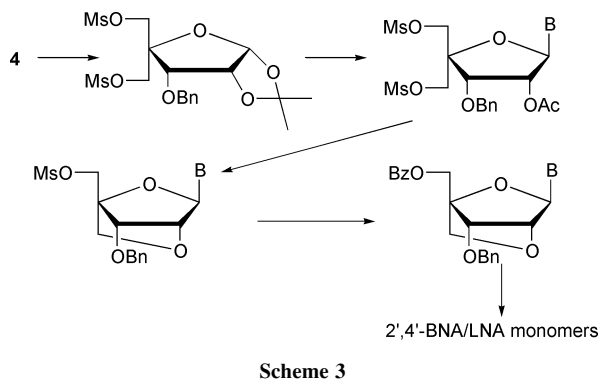

Scheme 3

3'-Amino-2',4'-BNA

The effectiveness of an N3'→P5' phosphoramidate linkage in progressing duplex- and triplex-forming ability of oligonucleotides was reported by Gryaznov *et al.*²¹ Furthermore, the phosphoramidate modification of oligonucleotides significantly enhanced their resistance to enzymatic hydrolysis.⁴³ Therefore, 3'-amino-2',4'-BNA, the combination of an N3'→P5' phosphoramidate linkage and 2',4'-BNA structure is also of great interest (Fig. 6).

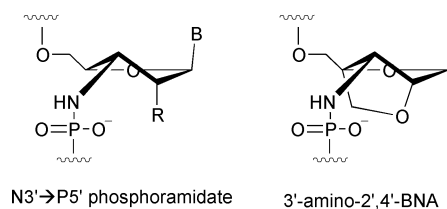

Fig. 6 Structures of oligonucleotide N3'→P5' phosphoramidate and 3'-amino-2',4'-BNA.

A representative 3'-amino-2',4'-BNA monomer was synthesized as shown in Scheme 4.⁴⁴ Successive modification of the two hydroxy groups in **6**, which was easily derived from D-glucose *via* the known dibenzoate, gave **7**. Its acetolysis followed by coupling with an activated thymine afforded the β-anomer of 3'-azido-3'-deoxythymidine derivative **8** effectively. The deacetylation and subsequent ring-closure reaction yielded **9**, which was desilylated to give 3'-azido-2',4'-BNA-T, an analog of AZT. More recently, the same compound was also prepared in a similar manner by Wengel *et al.*, who showed that this AZT analog did not have any anti-HIV activities.⁴⁵ 3'-Azido-2',4'-BNA-T was readily reduced by a catalytic hydrogenation to afford the desired product, 3'-amino-2',4'-BNA-T.

Heterodimer unit **10**, another good synthon for preparation of 3'-amino-2',4'-BNA oligonucleotides, was also synthesized as shown in Scheme 5.⁴⁶ After protection of the 5'-hydroxy group in the 3'-azido-2',4'-BNA monomer, the 3'-azido group was successfully reduced to give the 3'-amino derivative **11**. The Atherton-Todd-type oxidative phosphorylation reaction^{47,48} between **11** and the 5'-H-phosphonate counterpart followed by desilylation afforded the heterodimer **10**.

2',4'-BNA C-nucleoside

C-Nucleosides are nucleoside analogs containing a carbon-carbon linkage between the furanose and the heterocyclic base, instead of the carbon-nitrogen linkage in the natural N-nucleosides. They are very intriguing nucleoside analogs as antitumor, antibacterial or antiviral agents. Concerning the

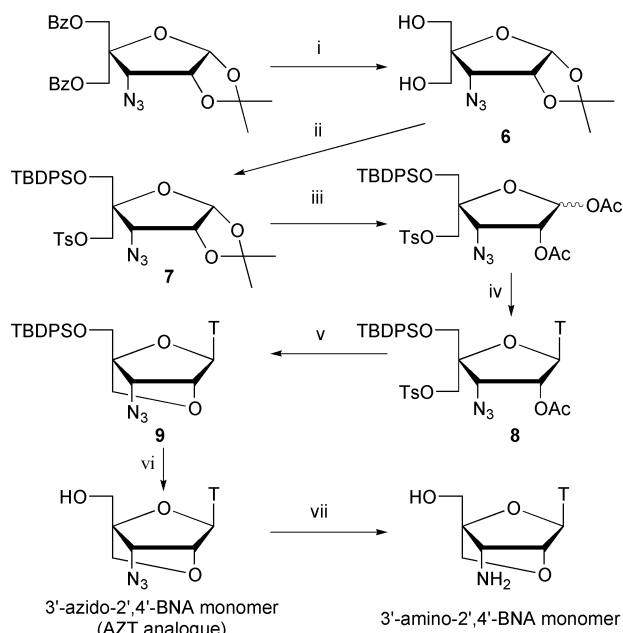

Scheme 4 Reagents: i, K_2CO_3 aq., MeOH; ii, (a) TBDPSCl, Et_3N , CH_2Cl_2 ; (b) TsCl, Et_3N , DMAP, CH_2Cl_2 ; iii, cat. H_2SO_4 , Ac_2O , AcOH; iv, silylated thymine, SnCl_4 , $\text{ClCH}_2\text{CH}_2\text{Cl}$; v, K_2CO_3 , MeOH; vi, TBAF, THF; vii, H_2 , Pd/C, EtOH.

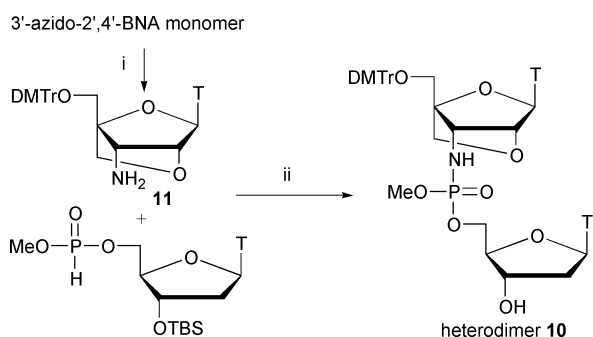

Scheme 5 Reagents: i, (a) DMTrCl, DMAP, Py; (b) Ph_3P , Py, then NH_4OH aq.; ii, (a) CCl_4 , Et_3N , MeCN; (b) TBAF, THF.

sugar puckering, the two stereoelectronic effects, the gauche effect between $\text{O}3'$ and $\text{O}4'$ and the anomeric effect between $\text{C}1'$ and $\text{N}1$, influence the conformational equilibrium of the *N*-nucleosides. The former effect drives the conformational equilibrium towards *S*-type, while the latter drives it towards *N*-type.⁴⁹ The *C*-nucleosides are known to exist in *S*-type conformation predominantly for lack of an anomeric effect (Fig. 7).⁵⁰ Therefore, restriction of the sugar puckering of *C*-nucleosides, especially in *N*-type conformation, is thought to contribute towards discovery of the novel biological activities of *C*-nucleosides. Furthermore, *C*-nucleosides, unlike the natural nucleosides, can possess a great variety of heterocycles; therefore, *C*-nucleoside analogs with fixed *N*-conformation would be useful for antisense and antigene applications, along with their biological activities.

A number of *C*-nucleosides with 2',4'-BNA modification were synthesized as shown in Scheme 6.^{51–53} Coupling reaction between the magnesium derivatives of some aromatic heterocycles and the aldehyde **12**, which was prepared from *D*-ribose or *D*-glucose, gave the corresponding diols **13** with desirable stereoselectivity. Their cyclization under the Mitsunobu conditions successfully proceeded to give the β -anomers of **14**, and finally the 2',4'-BNA *C*-nucleosides were obtained by debenzoylation of **14**. X-ray crystallography of the 2',4'-BNA *C*-nucleoside (Ar = oxazol-5-yl) shows that its sugar conforma-

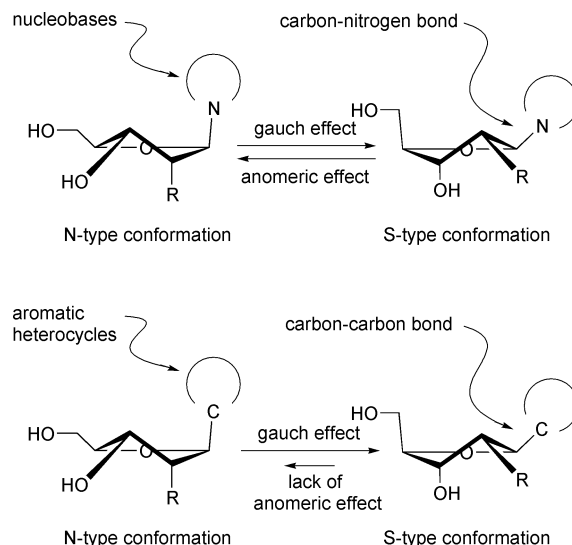
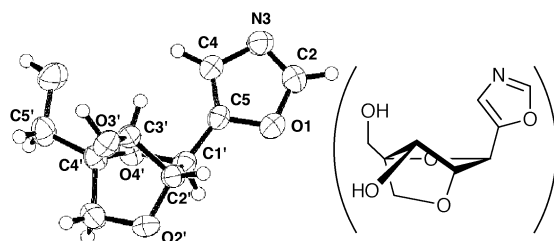
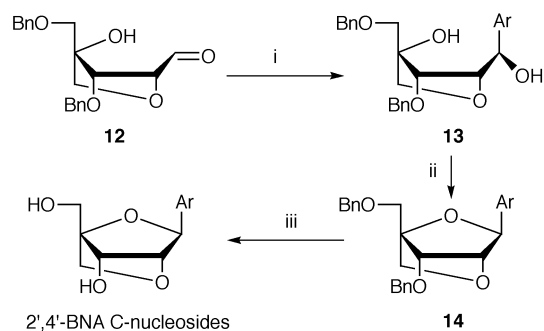

Fig. 7 Sugar puckering of *N*- and *C*-nucleosides.



X-Ray structure of 2',4'-BNA *C*-nucleoside (Ar = oxazol-5-yl)

Scheme 6 Reagents: i, Ar-MgBr, THF or THF-TMEDA; ii, DEAD, Ph_3P , THF or TMAD, Bu_3P , benzene; iii, H_2 , $\text{Pd}(\text{OH})_2/\text{C}$, EtOH or cyclohexene, $\text{Pd}(\text{OH})_2/\text{C}$.

tion was restrained in a typical *C3'*-endo mode (pseudorotation phase angle was 18°) and that both the endocyclic torsion angles and the pseudorotation phase angle of this *C*-nucleoside analog are almost identical to those of the 2',4'-BNA *N*-nucleoside (2',4'-BNA/LNA-U monomer).

3',4'-BNA

In most DNAs and RNAs, nucleoside units are connected *via* a 3',5' internucleoside phosphodiester linkage. On the other hand, there are some biologically active nucleic acids bearing a 2',5' internucleoside phosphodiester linkage (Fig. 8). For example, a 2',5'-linked oligoadenylate (2-5A) is well known to enhance the activity of 2-5A dependent RNase L, which plays an important role in prevention of virus infection.⁵⁴ Furthermore, it was reported that the 2',5'-linked oligonucleotides have a tendency to hybridize with their RNA complements rather than DNA complements, and that they also have resistance towards several types of nucleases.⁵⁵ These characters of the 2',5'-linked

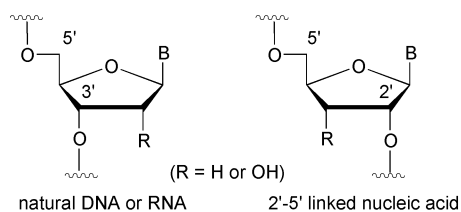
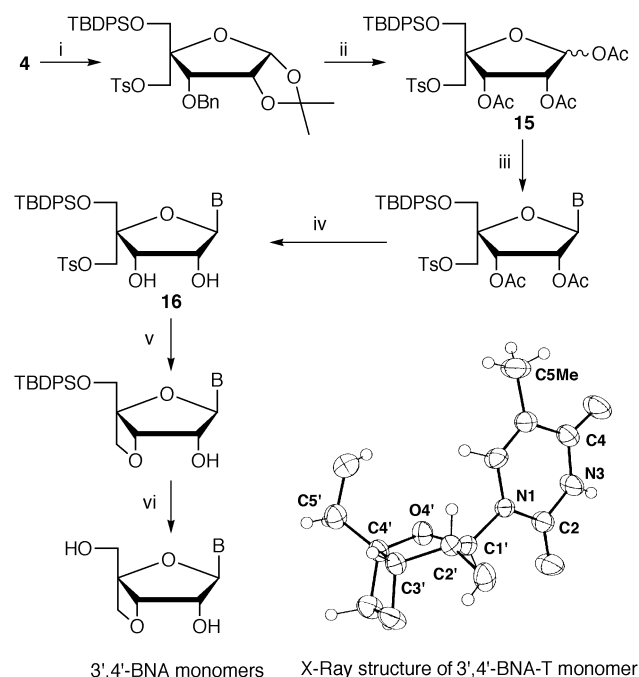

Fig. 8 Structures of natural DNA/RNA and 2',5'-linked nucleic acid.

oligonucleotides seem to be quite favorable for antisense technology.

The conformationally restrained nucleoside analogs for 2',5'-linked oligonucleotide modification, 3'-O,4'-C-methylene-ribonucleosides (3',4'-BNA monomers), were synthesized by a linear approach shown in Scheme 1.^{56,57} In addition, these nucleosides were also obtained by a convergent route outlined in Scheme 7, where the coupling reaction of the triacetate **15**



3',4'-BNA monomers X-Ray structure of 3',4'-BNA-T monomer

Scheme 7 Reagents: i, (a) TBDPSCl, Et₃N, CH₂Cl₂; (b) TsCl, Et₃N, DMAP, CH₂Cl₂; ii, (a) cat. H₂SO₄, Ac₂O, AcOH; (b) H₂, Pd/C, AcOEt-CHCl₃; (c) Ac₂O, Py; iii, silylated base, TMSOTf, ClCH₂CH₂Cl; iv, K₂CO₃, MeOH; v, NaHMDS, THF; vi, TBAF, THF.

with silylated nucleobases, and the oxetane-ring formation by a treatment of diols **16** under alkaline conditions were employed as key steps.^{57,58} The resulting 3',4'-BNA monomers were found to have relatively large coupling constants between H1' and H2' in ¹H NMR spectra ($J_{1'2'} = 7.3\text{--}7.6$ Hz), regardless of the type of nucleobase, meaning that the 3',4'-BNA monomers have predominantly an S-type sugar pucker. The same result was obtained by a molecular modeling (PM3) study and X-ray crystallographic analysis. The pseudorotation phase angle of the 3',4'-BNA-T monomer was calculated to be 136° (C1'-*exo*-C2'-*endo* sugar pucker) from the X-ray structure.

Properties of BNA modified oligonucleotides

General properties

The BNA monomers and the 3'-amino-2',4'-BNA-type heterodimer were easily converted to the corresponding amidites by a conventional method, and the incorporation of these nucleoside analogs into oligonucleotides was successfully undertaken by using a standard phosphoramidite approach on a DNA synthesizer (in some cases, prolonged coupling time was needed).

Purification of the BNA modified oligonucleotides can be performed by a simple reversed-phase HPLC, and identification of these oligonucleotide analogs can be made by MALDI-TOF-Mass measurements. There was no problem in each step (oligomerization, purification and identification) and also in the aqueous solubility of the oligonucleotide analogs.

Duplex formation

Duplex-forming ability of the modified oligonucleotide can be discussed in terms of the melting temperature (T_m value) of the duplex consisting of the oligonucleotide and its DNA or RNA complement. The T_m values of the BNA modified oligonucleotides with their DNA or RNA complements were determined by UV melting experiment under near physiological pH and salt conditions (Table 1). The T_m values of the duplexes involving

Table 1 Duplex-forming ability of the BNA modified oligonucleotides with DNA and RNA complements^a

Entry	Oligonucleotides (5'→3')	T_m (ΔT_m per mod. ^b)/°C	
		with RNA complement	with DNA complement
1	d(GCGTTTTTTGCT)	45	47
2	d(GCGTTT ^{2B} TTTGCT)	52(+7)	53(+6)
3	d(GCGT ^{2B} T ^{2B} T ^{2B} T ^{2B} T ^{2B} T ^{2B} GCT)	80(+5.9)	67(+3.3)
4	d(GCGTTU ^{2B} TTTGCT)	49(+4)	49(+2)
5	d(GCGU ^{2B} U ^{2B} U ^{2B} U ^{2B} U ^{2B} U ^{2B} GCT)	71(+4.3)	58(+1.8)
6	d(GCGTTT ^{aB} TTTGCT)	52(+7)	51(+4)
7	d(GCGTTT ^{3B} TTTGCT)	47(+2)	47(±0)
8	d(GCGT ^{3B} TT ^{3B} TT ^{3B} TGCT)	42(-1)	33(-4.7)
9	d(GCGT ^{3B} T ^{3B} T ^{3B} T ^{3B} T ^{3B} T ^{3B} GCT)	33(-2)	<5(<-7)
10	d(GCGTTU ^{3B} TTTGCT)	47(+2)	47(±0)
11	d(GCGU ^{3B} U ^{3B} U ^{3B} U ^{3B} U ^{3B} U ^{3B} GCT)	30(-2.5)	<5(<-7)

^a C = cytidine monomer, G = guanosine monomer, T = thymidine monomer, U = uridine monomer, T^{2B} and U^{2B} = 2',4'-BNA monomer, T^{aB} = 3'-amino-2',4'-BNA monomer, T^{3B} and U^{3B} = 3',4'-BNA monomer. UV melting experiments were carried out in 10 mM sodium phosphate buffer (pH 7.2) containing 100 mM NaCl at a scan rate of 0.5 °C min⁻¹ at 260 nm. The oligonucleotide concentration used was 4 μM for each strand. The sequence of target DNA or RNA complements is 5'-AGCAAAAAACGC-3'. ^b ΔT_m per mod. = change in T_m per modification compared to the unmodified reference strand (entry 1).

the parent DNA oligonucleotides, 5'-d(GCGTTTTTTGCT)-3', and its RNA and DNA complements were 45 and 47 °C, respectively (entry 1). In contrast, the 2',4'-BNA/LNA modification of oligonucleotides significantly enhances hybridizing ability towards the complementary strand (entries 2–5).⁵⁹ Especially, remarkable thermal stability of the duplexes was observed when RNA was used as a complementary strand (ΔT_m is +4 to +7 °C), which would come from the preorganized N-type sugar conformation of the 2',4'-BNA/LNA.^{59,60} The thermodynamic parameters determined by van't Hoff plots revealed that the hybridization step of the 2',4'-BNA/LNA oligonucleotide and its RNA complement is entropically favourable compared with that of the parent DNA oligonucleotide and RNA complement.⁵⁹ The A-like helical structure of the duplex involving a 2',4'-BNA/LNA oligonucleotide was also confirmed by CD measurement,^{59,61} ¹H NMR experiment⁶¹ and X-ray crystallographic analysis.⁶²

The 3'-amino-2',4'-BNA oligonucleotide, bearing both a 2'-O,4'-C-methylene-bridged sugar moiety and an N3'→P5' phosphoramidate linkage, showed almost the same hybridizing ability as the 2',4'-BNA/LNA oligonucleotide (entries 2 and 6).⁴⁶ This result is quite acceptable considering that the driving force for the high binding affinity of both modifications, the 2',4'-BNA and phosphoramidate linkage, would be a pre-organization of sugar pucker into N-type conformation. The unprecedented hybridizing properties of the 2',4'-BNA/LNA and 3'-amino-2',4'-BNA oligonucleotides towards the RNA

complement are quite favourable for an antisense strategy, and these oligonucleotide analogs should be promising candidates for an antisense strategy in the coming generation.

On the other hand, the 3',4'-BNA oligonucleotides showed little depression or some increase in T_m towards complementary RNA as compared with the parent DNA oligonucleotide, while greater depression in T_m was observed towards DNA complement (entries 7–11).⁶³ In particular, the oligonucleotides bearing six successive 3',4'-BNA modifications did not bind to their DNA complement (entries 9 and 11). Meanwhile, these oligonucleotides nearly maintained hybridizing ability towards the RNA complement. Thus, the 3',4'-BNA modification of oligonucleotides promotes binding selectivity for RNA over ssDNA, which comes from the destabilization of the duplex between the 3',4'-BNA and its DNA complement.

Triplex formation

Compared with antisense technology, antigene methodology has two major drawbacks preventing its practical use. The first problem is that only homopyrimidine oligonucleotides can bind with homopurine-homopyrimidine tracts in dsDNA *via* Hoogsteen-type hydrogen bonding (Fig. 1). In other words, there are few nucleosides to recognize pyrimidine-purine base pairs, such as C-G and T-A base pairs. The second one is that even for the targets involving homopurine-homopyrimidine tracts, the triplex stability under physiological conditions (or at neutral pH) is insufficient because the protonation at N3 in cytosine nucleobases is required for triplex formation.¹⁰ To overcome these problems, we evaluated the triplex-forming properties of the oligonucleotides with 2',4'-BNA/LNA modification.

By means of various experimental techniques such as UV melting, isothermal titration calorimetry (ITC) and gel-shift analysis, it was demonstrated that the homopyrimidine oligonucleotides with 2',4'-BNA/LNA modifications form very stable triplexes with the homopurine-homopyrimidine region of dsDNAs.^{35,64–66} In the UV melting experiments of the triplexes consisting of a 15-mer homopyrimidine oligonucleotide, 5'-d(TTTT^mCTXT^mCT^mCT^mCT)-3', where ^mC means 5-methylcytidine, and 21-bp dsDNA targets, only one 2',4'-BNA/LNA modification at the X-site in the triplex-forming oligonucleotide (TFO) promoted marked triplex stabilization in a highly sequence-selective manner (Table 2).⁶⁴ The triplex-

Table 2 Triplex-forming ability of the BNA modified TFOs, 5'-d(TTTT^mCTXT^mCT^mCT^mCT)-3', with the dsDNA targets, 5'-d(GCTAAAAAGAYAGAGATCG)-3'/3'-d(CGATTTTCTZTCTCTAGC)-5'^a

Entry	X	$T_m/^\circ\text{C}$			
		Y:Z			
		A-T	G-C	T-A	C-G
1	T	44	20	17	25
2	C	18	43	16	25
3	T ^{2B}	57	31	16	35
4	^m C ^{2B}	27	53	15	33
5	T ^{aB}	55	31	16	32

^a T = thymidine monomer, ^mC = 5-methylcytidine monomer, T^{2B} and ^mC^{2B} = 2',4'-BNA monomer, T^{aB} = 3'-amino-2',4'-BNA monomer. UV melting experiments were carried out in 7 mM sodium phosphate buffer (pH 7.0) containing 140 mM KCl and 10 mM MgCl₂ at a scan rate of 0.5 °C min⁻¹ at 260 nm. The oligonucleotide concentration used was 1.5 μM for each strand.

forming ability of the 3'-amino-2',4'-BNA oligonucleotide was found to be comparable to that of the parent 2',4'-BNA/LNA oligonucleotide (Table 2, entry 5).⁴⁶ Kinetic experiments for triplex formation between the 2',4'-BNA modified TFOs, *e.g.* 5'-d(C^{2B}TC^{2B}TT^{2B}TC^{2B}TT^{2B}TC^{2B}TT^{2B}TC)-3', and their target dsDNA by resonant mirror method clearly revealed that the

increase in the binding affinity by the 2',4'-BNA/LNA modification of TFO resulted from the considerable decrease in the dissociation rate constant.^{65,66} The binding affinity of this 2',4'-BNA/LNA modified TFO, 5'-d(T^mC^{2B}T^mC^{2B}T^mC^{2B}T^mC^{2B}T^mC^{2B}TT^{2B}TT)-3', towards the target duplex was elucidated by using gel-retardation assay, where the dissociation constant (K_d) was estimated to be 2.5×10^{-8} M at pH 7.0, which was at least 300-fold lower than that of the parent DNA oligonucleotide. Furthermore, binding of the transcription factor NF-κB (p50 subunit) to the target dsDNA was effectively inhibited by triplex formation of this 2',4'-BNA/LNA modified TFO.³⁵

On the other hand, some 2',4'-BNA nucleosides bearing unnatural nucleobases were prepared for recognition of pyrimidine-purine interruptions in the target dsDNA.^{51–53,67} From the fact that T or C interacts with a C-G base pair (Table 2), we considered that the 2-carbonyl oxygen of T or C plays an important role in recognition of a C-G base pair. To avoid the interaction of T or C with A-T or G-C base pair, we utilized the 2-pyridone, which has no other functional groups besides 2-carbonyl in T or C for selective interaction to a C-G base pair. As depicted in Fig. 9, the TFO, 5'-

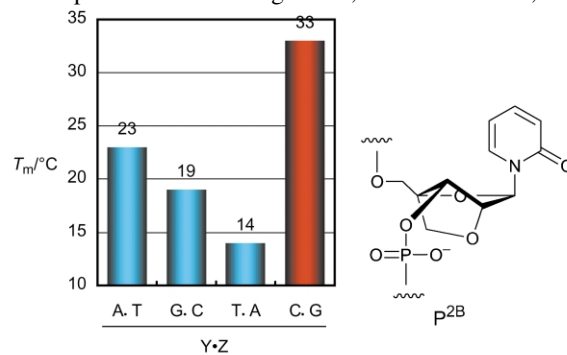

Fig. 9 Triplex-forming ability of the TFO containing the BNA monomer P^{2B} with the dsDNA targets. The sequences of the TFO and the dsDNA targets are 5'-d(TTTT^mCTP^{2B}T^mCT^mCT^mCT)-3' and 5'-d(GCTAAAAAGAYAGAGATCG)-3'/3'-d(CGATTTTCTZTCTCTAGC)-5', respectively. Other conditions are shown in the caption in Table 2.

d(TTTT^mCTP^{2B}T^mCT^mCT^mCT)-3', in which P^{2B} means the 2',4'-BNA monomer bearing a 2-pyridone, formed a stable triplex involving a P^{2B}-C-G triad under near physiological conditions.⁶⁷ Furthermore, the triplex formation by this TFO was found to be highly sequence-selective.

Thus, the 2',4'-BNA modification of TFO promotes triplex-forming ability under physiological conditions, and efficient recognition of C-G interruption in homopurine-homopyrimidine dsDNA was achieved by using the 2',4'-BNA monomer with an unnatural nucleobase.

Closing remarks

Thus, the preorganization of oligonucleotides into a desirable N-type sugar conformation for duplex or triplex formation by a bridged sugar structure is a promising strategy to develop nucleic acid analogs with high binding affinity towards the RNA or dsDNA target. However, there are some other criteria, such as the recruitment of RNase H and the resistance to enzymatic hydrolysis, to be satisfied for an ideal nucleic acid analog. Concerning the activation of RNase H, a partial 2',4'-BNA modification of oligonucleotide (a gap-mer structure) was found to allow RNase H-mediated degradation of the RNA target,^{68,69} while the fully modified counterparts did not have enough activity.⁶⁹ In fact, the partially 2',4'-BNA/LNA modified antisense oligonucleotides greatly inhibited the target gene expression in *in vitro*⁶⁸ and *in vivo*⁶⁹ experiments without notable cytotoxicity. The resistance to enzymatic hydrolysis of the BNA oligonucleotides (2',4'-BNA/LNA, 3'-amino-2',4'-BNA and 3',4'-BNA) was also elucidated, and it was found that

these BNA modifications of oligonucleotides enhanced the stability against enzymatic degradation.^{46,63,68,69} It was quite noteworthy that the resistance of the 3'-amino-2',4'-BNA oligonucleotide, which contains an N3'→P5' phosphoramidate linkage, against hydrolysis by snake venom phosphodiesterase was superior to that of S-oligo.⁴⁶ Although further biological and pharmacological studies are of course needed, the BNAs and related nucleic acid analogs should be promising candidates as efficient antisense or antigene molecules for practical applications not only in novel therapeutic drug discovery but also in various diagnostic and biological uses.

Part of this work was supported by a Grant for Research on Health Sciences focusing on Drug Innovation from The Japan Health Sciences Foundation, Industrial Technology Research Grant Program from New Energy and Industrial Technology Development Organization (NEDO) of Japan, a Grant-in-Aid from Japan Society for the Promotion of Science, and a Grant-in-Aid from the Ministry of Education, Science, and Culture, Japan.

Notes and references

- E. Uhlmann and A. Peyman, *Chem. Rev.*, 1990, **90**, 543.
- S. L. Beaucage and R. P. Iyer, *Tetrahedron*, 1993, **49**, 6123.
- J. F. Milligan, M. D. Matteucci and J. C. Martin, *J. Med. Chem.*, 1993, **36**, 1923.
- N. T. Thoung and C. Hélène, *Angew. Chem., Int. Ed. Engl.*, 1993, **32**, 666.
- A. De Mesmaeker, R. Häner, P. Martin and H. E. Moser, *Acc. Chem. Res.*, 1995, **28**, 366.
- P. Herdewijn, *Liebigs Ann.*, 1996, 1337.
- S. M. Freier and K.-H. Altmann, *Nucleic Acids Res.*, 1997, **25**, 4429.
- Clinical Trials of Genetic Therapy with Antisense DNA and DNA Vectors*, ed. E. Wickstrom, Marcel Dekker, New York, 1998.
- Applied Antisense Oligonucleotide Technology*, ed. C. A. Stein and A. M. Krieg Wiley-Liss, New York, 1998.
- Triple Helix Forming Oligonucleotides*, ed. C. Malvy, A. Harel-Bellan and L. L. Pritchard, Kluwer Academic Publishers, Boston, 1999.
- S. T. Crooke, *Antisense Nucleic Acid Drug Dev.*, 1998, **8**, vii–viii.
- E. T. Kool, *Chem. Rev.*, 1997, **97**, 1473.
- P. Herdewijn, *Biochim. Biophys. Acta*, 1999, **1489**, 167.
- M. Meldgaard and J. Wengel, *J. Chem. Soc., Perkin Trans. 1*, 2000, 3539.
- C. J. Leumann, *Bioorg. Med. Chem.*, 2002, **10**, 841.
- M. Tarköy, M. Bolli, B. Schweizer and C. Leumann, *Helv. Chim. Acta*, 1993, **76**, 481.
- M. Tarköy and C. Leumann, *Angew. Chem., Int. Ed. Engl.*, 1993, **32**, 1432.
- R. Steffens and C. Leumann, *J. Am. Chem. Soc.*, 1999, **121**, 3249.
- C. Hendrix, H. Rosemeyer, I. Verheggen, F. Seela, A. Van Aerschot and P. Herdewijn, *Chem. Eur. J.*, 1997, **3**, 110.
- C. Hendrix, H. Rosemeyer, B. De Bouvere, A. Van Aerschot, F. Seela and P. Herdewijn, *Chem. Eur. J.*, 1997, **3**, 1513.
- S. M. Gryaznov, *Biochim. Biophys. Acta*, 1999, **1489**, 131.
- P. Nielsen, H. M. Pfundheller, C. E. Olsen and J. Wengel, *J. Chem. Soc., Perkin Trans. 1*, 1997, 3423.
- N. K. Christensen, M. Petersen, P. Nielsen, J. P. Jacobsen, C. E. Olsen and J. Wengel, *J. Am. Chem. Soc.*, 1998, **120**, 5458.
- V. K. Rajwanshi, A. E. Håkansson, M. D. Sørensen, S. Pitsch, S. K. Singh, R. Kumar, P. Nielsen and J. Wengel, *Angew. Chem., Int. Ed.*, 2000, **112**, 1722.
- G. Wang, E. Gunic, J.-L. Girardet and V. Stoisavljevic, *Bioorg. Med. Chem. Lett.*, 1999, **9**, 1147.
- L. Kvaerno and J. Wengel, *J. Org. Chem.*, 2001, **66**, 5498.
- K. Morita, C. Hasegawa, M. Kaneko, S. Tsutsumi, J. Sone, T. Ishikawa, T. Imanishi and M. Koizumi, *Bioorg. Med. Chem. Lett.*, 2002, **12**, 73.
- T. Imanishi and S. Obika, *J. Synth. Org. Chem., Jpn.*, 1999, **57**, 969.
- J. Wengel, *Acc. Chem. Res.*, 1999, **32**, 301.
- D. A. Braasch and D. R. Corey, *Chem. Biol.*, 2001, **8**, 1.
- We called 2'-O,4'-C-methyleneribonucleosides 2',4'-BNA monomers. On the other hand, Wengel *et al.* called these nucleoside analogues LNA monomers. The 2',4'-BNA/LNA monomers were first reported by our group in 1997, while the 2',4'-BNA/LNA oligonucleotides were first published by Wengel *et al.* in 1998. See references 34 and 38.
- W. Saenger, *Principles of Nucleic Acid Structure*, Springer-Verlag, New York, 1984.
- R. W. Roberts and D. M. Crothers, *Science*, 1992, **258**, 1463.
- S. Obika, D. Nanbu, Y. Hari, K. Morio, Y. In, T. Ishida and T. Imanishi, *Tetrahedron Lett.*, 1997, **38**, 8735.
- S. Obika, T. Uneda, T. Sugimoto, D. Nanbu, T. Minami, T. Doi and T. Imanishi, *Bioorg. Med. Chem.*, 2001, **9**, 1001.
- S. L. Cook and J. A. Secrist, *J. Am. Chem. Soc.*, 1979, **101**, 1554; G. H. Jones, M. Taniguchi, D. Tegg and J. G. Moffatt, *J. Org. Chem.*, 1979, **44**, 1309.
- T.-S. Lin, J.-H. Yang, M.-C. Liu, Z.-Y. Shen, Y.-C. Cheng, W. H. Prusoff, G. I. Birnbaum, J. Giziewicz, I. Ghazzouli, V. Brankovan, J.-S. Feng and G.-D. Hsiung, *J. Med. Chem.*, 1991, **34**, 693.
- S. K. Singh, P. Nielsen, A. A. Koshkin and J. Wengel, *Chem. Commun.*, 1998, 455.
- A. A. Koshkin, S. K. Singh, P. Nielsen, V. K. Rajwanshi, R. Kumar, M. Meldgaard, C. E. Olsen and J. Wengel, *Tetrahedron*, 1998, **54**, 3607.
- A. A. Koshkin, V. A. Rajwanshi and J. Wengel, *Tetrahedron Lett.*, 1998, **39**, 4381.
- T. Imanishi and S. Obika, Pat. Applications WO 98/39352 [unpublished work].
- A. A. Koshkin, J. Fensholdt, H. M. Pfundheller and C. Lomholt, *J. Org. Chem.*, 2001, **66**, 8504.
- S. M. Gryaznov and H. Winter, *Nucleic Acids Res.*, 1998, **26**, 4160.
- S. Obika, J. Andoh, T. Sugimoto, K. Miyashita and T. Imanishi, *Tetrahedron Lett.*, 1999, **40**, 6465.
- A. G. Olsen, V. K. Rajwanshi, C. Nielsen and J. Wengel, *J. Chem. Soc., Perkin Trans. 1*, 2000, 3610.
- S. Obika, M. Onoda, K. Morita, J. Andoh, M. Koizumi and T. Imanishi, *Chem. Commun.*, 2001, 1992.
- S. M. Gryaznov and R. L. Letsinger, *Nucleic Acids Res.*, 1992, **20**, 3403.
- S. M. Gryaznov and J.-K. Chen, *J. Am. Chem. Soc.*, 1994, **116**, 3143.
- J. Plavec, T. Weimin and J. Chattopadhyaya, *J. Am. Chem. Soc.*, 1993, **115**, 9734; J. Plavec, C. Thibaudeau and J. Chattopadhyaya, *J. Am. Chem. Soc.*, 1994, **116**, 6558.
- N. C. Chaudhuri, R. X.-F. Ren and E. T. Kool, *Synlett*, 1997, 341.
- S. Obika, Y. Hari, K. Morio and T. Imanishi, *Tetrahedron Lett.*, 2000, **41**, 215.
- S. Obika, Y. Hari, K. Morio and T. Imanishi, *Tetrahedron Lett.*, 2000, **41**, 221.
- Y. Hari, S. Obika, M. Sakaki, K. Morio, Y. Yamagata and T. Imanishi, *Tetrahedron*, 2002, **58**, 3051–3063.
- H. C. Schröder, R. J. Suhadolnik, W. Pfeleiderer, R. Charubala and W. E. G. Müller, *Int. J. Biochem.*, 1992, **24**, 55; M. R. Player and P. F. Torrence, *Pharmacol. Ther.*, 1998, **78**, 55.
- H. Hashimoto and C. Switcher, *J. Am. Chem. Soc.*, 1992, **114**, 6255; J. P. Dougherty, C. J. Rizzo and R. Breslow, *J. Am. Chem. Soc.*, 1992, **114**, 6254; R. Kierzek, L. He and D. H. Turner, *Nucleic Acids Res.*, 1992, **20**, 1685; P. A. Giannaris and M. J. Damha, *Nucleic Acids Res.*, 1993, **21**, 4742.
- S. Obika, K. Morio, D. Nanbu and T. Imanishi, *Chem. Commun.*, 1997, 1643.
- S. Obika, K. Morio, D. Nanbu, Y. Hari, H. Itoh and T. Imanishi, *Tetrahedron*, 2002, **58**, 3039–3049.
- S. Obika, K. Morio, Y. Hari and T. Imanishi, *Chem. Commun.*, 1999, 2423.
- S. Obika, D. Nanbu, Y. Hari, J. Andoh, K. Morio, T. Doi and T. Imanishi, *Tetrahedron Lett.*, 1998, **39**, 5401.
- Duplex-forming ability of the 2',4'-BNA/LNA has also been summarized in excellent reviews. See references 15, 29 and 30.
- K. Bondensgaard, M. Petersen, S. K. Singh, V. K. Rajwanshi, R. Kumar, J. Wengel and J. P. Jacobsen, *Chem. Eur. J.*, 2000, **6**, 2687.
- M. Egli, G. Minasov, M. Teplova, R. Kumar and J. Wengel, *Chem. Commun.*, 2001, 651.
- S. Obika, K. Morio, Y. Hari and T. Imanishi, *Bioorg. Med. Chem. Lett.*, 1999, **9**, 515.
- S. Obika, Y. Hari, T. Sugimoto, M. Sekiguchi and T. Imanishi, *Tetrahedron Lett.*, 2000, **41**, 8923.
- H. Torigoe, Y. Hari, M. Sekiguchi, S. Obika and T. Imanishi, *J. Biol. Chem.*, 2001, **276**, 2354.
- H. Torigoe, S. Obika and T. Imanishi, *Nucleosides Nucleotides Nucleic Acids*, 2001, **20**, 1235.
- S. Obika, Y. Hari, M. Sekiguchi and T. Imanishi, *Angew. Chem.*, 2001, **113**, 2149; S. Obika, Y. Hari, M. Sekiguchi and T. Imanishi, *Angew. Chem., Int. Ed.*, 2001, **40**, 2079.
- S. Obika, R. Hemamayi, T. Masuda, T. Sugimoto, S. Nakagawa, T. Mayumi and T. Imanishi, *Nucleic Acids Res., Suppl. 1*, 2001, 145.
- C. Wahlestedt, P. Salmi, L. Good, J. Kela, T. Johnsson, T. Hökfelt, C. Broberger, F. Porreca, J. Lai, K. Ren, M. Ossipov, A. Koshkin, N. Jakobsen, J. Skouv, H. Oerum, H. E. Jacobsen and J. Wengel, *Proc. Natl. Acad. Sci. USA*, 2000, **97**, 5633.