

angular-overlap parameter, the angular-overlap integral $S_{\sigma}^2(R)$ over the $4f$ Yb^{3+} function and np ligand function is given. The e_{σ} values for $[(\text{C}_6\text{H}_5)_4\text{As}]_2\text{Yb}(\text{NO}_3)_5$ correspond reasonably well to the $S_{\sigma}^2(R)$ value as is shown in Table III.

Conclusions

The analysis of ESR spectra of low-symmetrical $[(\text{C}_6\text{H}_5)_4\text{As}]_2\text{Yb}(\text{NO}_3)_5$, have clearly demonstrated that it is not justified to assume idealized high symmetry. The angular-overlap model has been shown to be a valuable tool for the

interpretation of the spectral and magnetic properties of low-symmetry rare-earth complexes. The obtained values for the angular-overlap parameters give some insight into chemical bonding between rare-earth ions and ligand ions.

Acknowledgment. The authors are indebted to Professor B. Elschner for the experimental facilities at the TH Darmstadt and Dr. Kuhl for his assistance in obtaining the electronic spectra.

Registry No. $[(\text{C}_6\text{H}_5)_4\text{As}]_2\text{Yb}(\text{NO}_3)_5$, 85584-68-5.

Contribution from the Institute of Inorganic Chemistry,
University of Basel, CH-4056 Basel, Switzerland

Investigation of Complex Equilibria in Solution by EPR Spectroscopy

HARALD GAMPP

Received September 13, 1983

The pH-dependent equilibria between copper(II) and 3,7-diazanonedioic acid diamide (DANA, L) have been studied in aqueous solution by EPR spectroscopy. Data of high quality were obtained by designing a specific titration system using a flow cell. Representation of the digitized spectra in their eigenvector basis significantly reduces the number of data to be handled in the subsequent numerical treatment and also gives the number of complexes present in solution. Stability constants ($\log K^{\text{Cu}}_{\text{CuL}} = 12.06$, $\log K^{\text{H}}_{\text{CuL}} = 7.05$, $\log K^{\text{H}}_{\text{CuLH}_1} = 8.41$) and solution EPR spectra of the different complexes ($g_{\text{CuL}} = 2.125$, $g_{\text{CuLH}_1} = 2.111$, $g_{\text{CuLH}_2} = 2.100$) were calculated by using a program based on Marquardt's modification of the Newton-Gauss nonlinear least-squares method. No information with respect to the EPR spectra of the species is needed, which makes the mathematical technique especially useful if several complexes are formed simultaneously and if their spectra are unknown and/or strongly overlapping. The results of this study show that EPR titration offers an alternative both to potentiometry and to spectrophotometry for the investigation of solution equilibria.

Introduction

The EPR spectra of paramagnetic ions strongly depend on the ligand environment.¹ EPR spectroscopy therefore should be a valuable tool for investigating complex equilibria in solution. However, solution EPR^{2,3} plays only a minor role among the methods used for determining equilibrium constants and moreover is mostly restricted to the simplest systems, which can be described by a single constant.²⁻⁴ Examples are the association of iodide with organic radical anions,⁵ inner- and outer-sphere complexes of Mn^{2+} and simple anions,^{6,7} and ion-pair formation between organic radical anions and alkali metal ions.^{8,9}

EPR parameters used in the determination of stability constants are (i) coupling constants,⁵ (ii) line widths,^{6,7} (iii) g values,⁹ and (iv) line intensities, i.e. spin concentrations.⁸ Methods i-iii can be used, where the complexation kinetics are fast on the EPR time scale and where only one time-averaged signal is found. In cases where the different species in a mixture give rise to separate signals, only method iv can be applied.

In the EPR spectra obtained from a mixture of organic radicals, the observed lines are readily assigned to the individual species because the spectrum of a pure component consists of a set of rather sharp and narrow lines.¹ The concentrations of the different species are obtained by simply

integrating over the respective lines.¹⁰ Computer programs exist for this purpose.¹¹ The situation is quite different for many transition-metal complexes due to the much broader spectra.¹ E.g. for cupric complexes, where the dependence of the EPR parameters on coordinating atoms, geometry, and charge is well understood,^{12,13} the spectra of the species present in an equilibrium system are strongly overlapping.^{14,15} Therefore, for species that occur only to a minor extent, the spectra cannot be obtained straightforwardly and the problems in determining stability constants from EPR data are the same as in spectrophotometry.^{16,17}

Only recently a paper appeared that dealt with the determination of equilibrium constants for a number of Cu^{2+} -peptide complexes from EPR data.¹⁸ The calculation was done on a mainframe computer using a grid search, which is easy to apply but converges slowly and is thus expensive in computer time.¹⁹ The procedure used¹⁸ has the disadvantage that for n simultaneously occurring complexes $n - 1$ spectra have to be known, which limits its practical use to systems with only two species occurring in a certain mixture.

In the present work the complexation of Cu^{2+} by 3,7-diazanonedioic acid diamide (DANA, L) in aqueous solution was studied by EPR spectroscopy. The main difficulties related to the use of EPR data in the determination of stability

- (1) Goodman, B. A.; Raynor, J. B. *Adv. Inorg. Chem. Radiochem.* **1970**, *13*, 135.
- (2) Sullivan, P. D. *Magn. Reson. Rev.* **1978**, *4*, 197.
- (3) Allendoerfer, R. D. *Magn. Reson. Rev.* **1980**, *5*, 175.
- (4) Hartley, F. R.; Burgess, C.; Alcock, R. M. "Solution Equilibria"; Ellis Horwood Ltd.: Chichester, England, 1980.
- (5) Alegria, A. E.; Conception, R.; Stevenson, G. R. *J. Phys. Chem.* **1975**, *79*, 361.
- (6) McCain, D. C.; Myers, R. J. *J. Phys. Chem.* **1968**, *72*, 4115.
- (7) Burlamacchi, L.; Martini, G.; Tiezzi, E. *J. Phys. Chem.* **1970**, *74*, 3980.
- (8) Stevenson, G. R.; Alegria, A. E. *J. Phys. Chem.* **1973**, *77*, 3100.
- (9) Stevenson, G. R.; Alegria, A. E. *J. Phys. Chem.* **1975**, *79*, 1042.

- (10) Vollmer, R. T.; Caspary, W. J. *J. Magn. Reson.* **1977**, *27*, 181.
- (11) Vancamp, H. L.; Heiss, A. H. *Magn. Reson. Rev.* **1981**, *7*, 1.
- (12) Peisach, J.; Blumberg, W. E. *Arch. Biochem. Biophys.* **1974**, *165*, 691.
- (13) Addison, A. W. "Copper Coordination Chemistry: Biochemical and Inorganic Perspectives"; Karlin, K. D., Zubieta, J., Eds.; Adenine Press: New York, 1983; p 109.
- (14) Gould, D. C.; Mason, H. S. "The Biochemistry of Copper"; Peisach, J., Aisen, P., Blumberg, W. E., Eds.; Academic Press: New York, London, 1966; p 35.
- (15) Gould, D. C.; Mason, H. S. *Biochemistry* **1967**, *6*, 801.
- (16) McBryde, W. A. E. *Talanta* **1974**, *21*, 979.
- (17) Hänisch, G.; Kaden, Th. A.; Zuberbühler, A. D. *Talanta* **1979**, *26*, 563.
- (18) Kittl, W. S.; Rode, B. M. *J. Chem. Soc., Dalton Trans.* **1983**, 409.
- (19) Gans P. *Coord. Chem. Rev.* **1976**, *19*, 99.
- (20) Kaden, Th. A.; Zuberbühler, A. D. *Helv. Chim. Acta* **1974**, *57*, 286.

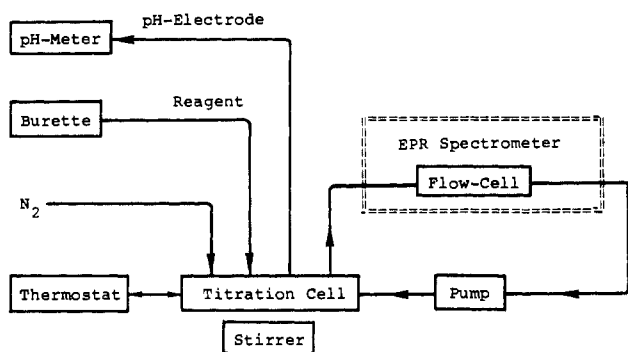

Figure 1. Experimental setup for the EPR titration.

constants have been successfully overcome: (i) Data of high quality were obtained by using a flow cell. (ii) Representation of the digitized EPR spectra in their eigenvector space significantly reduces the amount of data to be handled in the numerical treatment, allows the complete calculation to be done on a desk computer, and gives the number of complexes present in solution. (iii) Stability constants and EPR spectra were calculated by using a procedure that does not need any information with regard to the complex spectra. This makes the method particularly useful if several complexes are formed simultaneously and if their spectra are unknown and strongly overlapping.

Experimental Section

Materials. NaOH (Merck, Titrisol), KCl, and $\text{CuSO}_4 \cdot 5\text{H}_2\text{O}$ (Merck, p.a. grade) were used without further purification. DANA-2HCl was obtained from Prof. A. D. Zuberbühler and had been synthesized according to ref 20. Doubly distilled water was used throughout. Buffers of pH 4.00 and 7.00 (Metrohm) were used for calibrating the potentiometer.

Apparatus. The apparatus (Figure 1) consists of a temperature-controlled titration vessel, a digital pH meter (Metrohm 605), a glass electrode (Metrohm EA 121), a motor-driven buret (Metrohm E 412), a thermostat (Haake FS), and a magnetic stirrer. A glass capillary (1-mm i.d.) fixed in the cavity of an EPR spectrometer (Varian E 3, using 100-kHz field modulation, equipped with a 9.5-GHz microwave bridge) was connected with flexible tubing to the titration vessel. A pump (Serva E 25) operating on the plastic tubing maintained the flow of the titrated solution through the cell.

Measurement. The titration was done at 298 K in aqueous solution of constant ionic strength ($I = 0.5 \text{ M}$ (KCl)) under nitrogen. To 14 mL of a solution, which was 0.01955 M in Cu^{2+} and 0.02029 M in DANA-2HCl, was added 3.08 mL of a 0.408 M NaOH in increments of 0.07 mL. After each addition of base, the solution was pumped for 4 min through the flow system in order to achieve complete mixing. The EPR spectrum was measured between 2750 and 3450 G and recorded on chart paper. Instrument settings were as follows: 4-mW microwave power; 1.6-G modulation amplitude; 1-s time constant; 1 G s^{-1} scan rate. After the spectrum was recorded, the pH was measured.

Data Reduction. The first-derivative EPR spectra were digitized by using an APPLE II desk computer equipped with a Graphix Tablet (program EPRDIG²¹). Each of the 44 recorded spectra was resolved into 141 digital points at equidistant intervals of 5 G between 2750 and 3450 G. The data were multiplied by the appropriate factors to make them all correspond to the same receiver gain (2×10^{-5}), are expressed in arbitrary units (au), and range from 0 to 1.1 au. The EPR data ($44 \times 141 = 6204$ points) and the total concentrations of protons, metal, and ligand (44×3 points) were stored on diskette.

The calculations were done on a Hewlett-Packard HP 9835 desk computer with 128K memory, equipped with a plotter, HP 72225A, and a Heathkit H14 printer. The data were transferred from the APPLE II to the HP 9835 through a serial interface HP 98036A (program TRANSFER²¹). Due to the limited memory of the HP 9835, each spectrum was further reduced to not more than 50 points at equidistant intervals of 10 or 15 G (see text). This data set was

evaluated with the program EPRFIT²¹ (written in Basic), which consists of three parts: (i) The first one is a modified version of EIGEN²² and represents the measured first-derivative EPR spectra in their eigenvector basis. This leads to a significant reduction of the amount of data to be handled in the iterative refinement of the equilibrium constants without any loss of significant information. The eigenvector representation also gives us the number of complexes occurring during the titration. (ii) The second part is a modified version of ELORMA²³ with automatic generation of the Newton-Raphson subroutine (used to calculate the concentration of the different complexes for a given set of equilibrium constants) and using analytical derivatives as introduced into TITFIT.²⁴ The program uses the Newton-Gauss-Marquardt algorithm²⁵ and calculates the best equilibrium constants (i.e., the one leading to the minimal square sum) for the whole data set simultaneously. It only needs estimates for the equilibrium constants, while the molar EPR absorptivities (i.e., the dI/dH for every H) are eliminated from the iterative refinement. The EPR spectra of the complexes are obtained noniteratively from the final set of equilibrium constants by linear regression at the end of the calculation. (iii) The third part consists of several subroutines and allows the species distribution as a function of pH, the titration curves at different magnetic fields, and the EPR spectra of the individual complexes to be plotted. In addition, the double integration of the calculated species spectra can be done.

Mathematical Methods. The mathematical methods used for the numerical evaluation of the titration data have been described elsewhere.^{22,23} Therefore, it will only be outlined here how the problem of determining stability constants and EPR spectra of the complexes formed in solution is formulated in order to do the mathematical treatment.

Given a set of S first-derivative EPR spectra measured at H discrete magnetic field strengths, the whole data set can be written as a matrix Y (number of rows = H ; number of columns = S) (eq 1). Obviously,

$$Y = \begin{bmatrix} (dI/dH_1)_1 & (dI/dH_1)_2 & \dots & (dI/dH_1)_S \\ (dI/dH_2)_1 & & & \\ \vdots & & & \\ (dI/dH_H)_1 & \dots & \dots & (dI/dH_H)_S \end{bmatrix} \quad (1)$$

each column of Y is one of the measured spectra, and an element $Y_{h,s}$ contains the data point obtained at the magnetic field strength h for the spectrum s .

If in a pH-dependent equilibrium system P different complexes are formed, their concentrations depend only on the known total concentrations of metal and ligand, on the measured pH, and on the set of $P - 1$ equilibrium constants to be determined. Thus, for the solution from which spectrum s has been taken, the concentrations of each species p , $c_{p,s}$, can be calculated if the stability constants are known.

Provided that each measured spectrum is a linear combination of the spectra of the complexes present in solution, each element $Y_{h,s}$ can be represented by a calculated expression $Y_{h,s}^c$ (eq 2). (2) is an

$$Y_{h,s}^c = \sum_{p=1}^P ((dI^*/dH_h)_p \cdot c_{p,s}) \quad (2)$$

expression analogous to Beer's law, which is also valid for the derivatives because the concentrations do not depend on the magnetic field strength. The elements $Y_{h,s}^c$ can be written as a matrix Y^c of the same dimensions as Y (eq 3a,b). Matrix C contains the complex

$$Y^c = \begin{bmatrix} (dI^*/dH_1)_1 & \dots & (dI^*/dH_1)_P \\ \vdots & & \vdots \\ (dI^*/dH_H)_1 & \dots & (dI^*/dH_H)_P \end{bmatrix} \begin{bmatrix} c_{1,1} & c_{1,2} & \dots & c_{1,S} \\ \vdots & \vdots & & \vdots \\ c_{P,1} & \dots & \dots & c_{P,S} \end{bmatrix} \quad (3a)$$

$$Y^c = E \cdot C \quad (3b)$$

(21) Listings of the programs are available upon request.

(22) Maeder, M.; Gampp, H. *Anal. Chim. Acta* **1980**, *122*, 303.

(23) Gampp, H.; Maeder, M.; Zuberbühler, A. D. *Talanta* **1980**, *27*, 1037.

(24) Zuberbühler, A. D.; Kaden, Th. A. *Talanta* **1982**, *29*, 203.

(25) Marquardt, D. W. *J. Soc. Ind. App. Math.* **1963**, *11*, 431.

Table I. Data Sets and Results of Their Eigenvector Representation

data set	no. of points/spectrum ^a	limits of magn field strength, G		interval, 10 ³ σ, b G	10 ³ σ, b au
		lower	upper		
A ^c	141	2750	3450	5	4.4
B	47	2750	3450	15	4.5
C	29	2750	3450	25	4.3
D	50	2875	3365	10	5.3
E	50	2880	3370	10	5.1
F	50	3125	3370	5	5.2

^a 44 spectra were used throughout. ^b Standard error between Y (eq 1) and Y^e (eq 5) obtained with four eigenvectors.

^c Complete data set, only used for the eigenvector representation.³⁰

concentrations, and the columns of **E** contain the unknown first-derivative EPR spectra of the pure complexes. The Newton-Gauss procedure now can be applied to find the set of equilibrium constants and particle spectra, which leads to the minimal square sum Sq (eq 4). In the Cu-DANA system $P = 4$ different species are present:^{20,28}

$$\text{Sq} = \sum_{h=1}^H \sum_{s=1}^S (Y_{h,s} - Y_{h,s}^e)^2 \quad (4)$$

Cu²⁺, CuL²⁺, CuLH₁⁺, and CuLH₂. We therefore have to determine 3 ($=P - 1$) equilibrium constants and 564 ($=P \times H = 4 \times 141$) elements of **E** (spectra of the complexes) from our data set of 6204 ($=S \times H = 44 \times 141$) points. This problem can be reduced to the iterative refinement of the three stability constants only.^{22,23,27,28} The elements of **E** can be obtained by linear regression at the end of the least-squares procedure.

Representing the elements of **Y** in their eigenvector basis reduces the amount of data to be handled significantly.²² For a system with P absorbing species, **Y** can be represented by Y^e (eq 5). **V** is a matrix

$$\mathbf{Y}^e = \mathbf{V} \cdot \mathbf{L} \quad (5)$$

of dimension $H \times P$ and contains the eigenvectors; **L** is of dimension $P \times S$ and contains the respective linear coefficients. The decomposition according to (5) is done by using the method of vector iteration.²⁹ The iterative refinement of the equilibrium constants can be done by using **L** instead of **Y**.^{23,27} In our system with $P = 4$, instead of handling 6204 data we have only to deal with 176 ($=4 \times 44$) data.

Thus, the two features (eigenvector representation and elimination of the complex spectra from the iterative procedure) finally allow all parameters to be calculated in a straightforward manner.

Results and Discussion

Eigenvector Analysis. Due to the limited memory of our computer, each spectrum had to be reduced to not more than 50 points.³⁰ In order to make sure that the selection did not produce artifacts, several data sets were chosen (Table I; Figure 2). For each of them the measured data written according to eq 1 were represented in their eigenvector basis. Matrix rank analysis showed that each data set could be represented by four eigenvectors. This is to be expected since by potentiometry²⁰ and by spectrophotometry²⁶ four different species were found in the Cu²⁺-DANA system.

The overall standard deviation between the experimental data and their eigenvector representations according to eq 5 is about 5×10^{-3} au (Table I) and thus equals the error introduced by digitizing the spectra. This can also be taken as a quantitative measure for the quality of the experimental

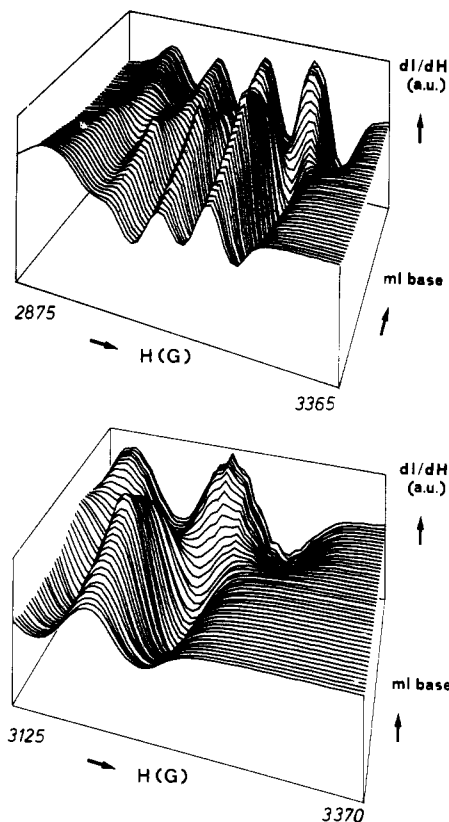

Figure 2. Three-dimensional plots of the EPR data from the titration of copper(II) and 3,7-diazanonanedioic acid diamide (DANA) ($I = 0.5$ M (KCl); 25 °C; $[\text{Cu}^{2+}]_{\text{tot}} = [\text{DANA}]_{\text{tot}} = 0.02$ M): upper part, data set D; lower part, data set F (cf. Table I).

Table II. Stability Constants (with Standard Errors) of the Cu²⁺-DANA Complexes Obtained from EPR Titration Using Different Data Sets^{a, b}

data set ^c	10 ³ σ, d			
	au	log K ^{Cu} _{CuL}	log K ^H _{CuL}	log K ^H _{CuLH₁}
B	6.9	12.07 (0.02)	7.05 (0.02)	8.40 (0.02)
C	7.0	12.06 (0.02)	7.06 (0.02)	8.44 (0.03)
D	7.2	12.06 (0.01)	7.05 (0.02)	8.41 (0.03)
E	7.2	12.05 (0.01)	7.05 (0.02)	8.41 (0.02)
F	8.3	12.24 (0.02)	7.02 (0.02)	8.41 (0.02)

^a From potentiometric titration: log K^H_{LH₂} = 6.55, log K^H_{LH} = 8.40, log K^{Cu}_{CuL} = 7.14, log K^H_{CuLH₁} = 8.38.²⁰

^b From spectrophotometric titration: log K^{Cu}_{CuL} = 12.08,³² log K^H_{CuL} = 7.14, log K^H_{CuLH₁} = 8.38.²⁶ ^c See Table I.

^d Standard error between Y (eq 1) and Y^e (eq 3).

data. Using the flow cell has the advantage over the method of taking discrete samples¹⁸ that the probe is in the same position inside the cavity during the whole titration and that errors due to different EPR tubes are avoided. Errors of $\pm 1\%$ (corresponding to 10^{-2} au in our case) were introduced only by repositioning the sample and by using different EPR tubes.¹⁸

Stabilities of the Copper(II)-DANA Complexes. The complex stability constants (Table II) were calculated for each data set by using the potentiometrically determined ligand deprotonation constants and agree well with the values from potentiometry and spectrophotometry (cf. Table II, footnotes, a and b). The distribution curves (Figure 3) show that CuL is already formed to more than 50% below pH 2.5 (therefore, K^{Cu}_{CuL} cannot be determined by pH titration²⁰) and that CuLH₁ is formed to not more than 70%.

The stability constants obtained from the different data sets show no statistically significant difference. The only exception is the value for log K^{Cu}_{CuL} from data set F. The reason for

(26) Zuberbühler, A. D.; Kaden, Th. A. *Talanta* 1979, 26, 1111.

(27) Sylvestre, E. A.; Lawton, W. H.; Maggio, M. S. *Technometrics* 1974, 16, 353.

(28) Golub, G. H.; Pereyra, V. *SIAM J. Appl. Math.* 1973, 10, 413.

(29) Schwarz, H. R.; Rutishauser, H.; Stiefel, E. "Numerik Symmetrischer Matrizen"; Teubner: Stuttgart, FRG, 1972.

(30) The eigenvector representation of the complete data set has been done on a UNIVAC 1108 using a program COMBEV³¹ written in Fortran.

(31) Gamp, H.; Maeder, M.; Meyer, C.; Zuberbühler, A. D., to be submitted for publication.

(32) Blum, R. Ph.D. Thesis, University of Basel, 1977.

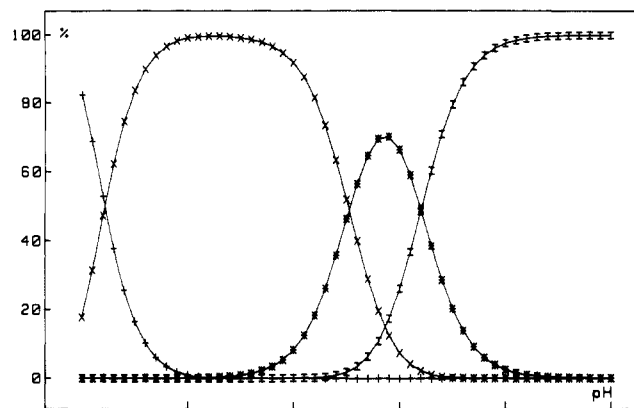
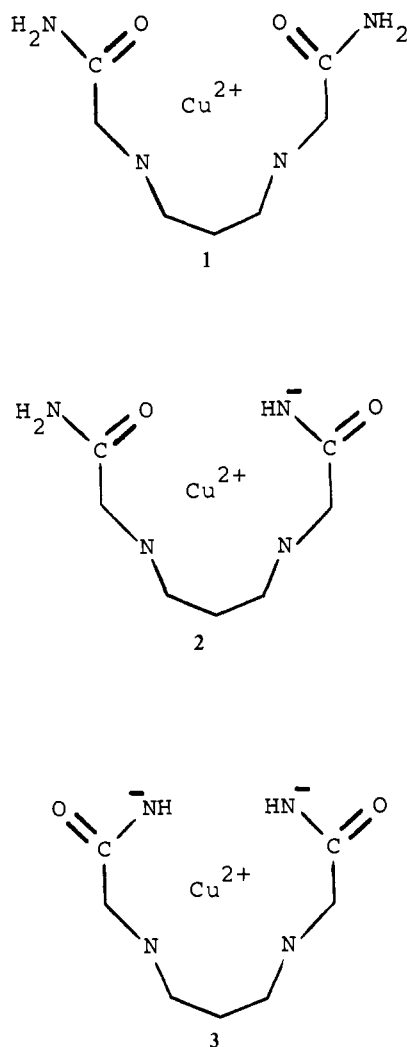

Figure 3. Species distribution of the copper(II)-DANA complexes as a function of pH. The results are given as the percentage of the total copper present: +, Cu^{2+} ; x, CuL^{2+} ; *, CuLH_1^+ ; I, CuLH_2 . (Conditions are as in Figure 2.)

Chart I



this discrepancy is that only data at high magnetic field were taken, i.e. from a region where CuL and CuLH_1 have almost identical spectra (vide infra). By visual inspection of the data (Figure 2, lower part) it would be impossible to conclude that two species are present during the first half of the titration (i.e., below pH 7).

The EPR titration curves (Figure 4) show that the calculated curves nicely fit the experimental points. The standard error of fit is 7×10^{-3} au (cf. Table II), which is less than 1%

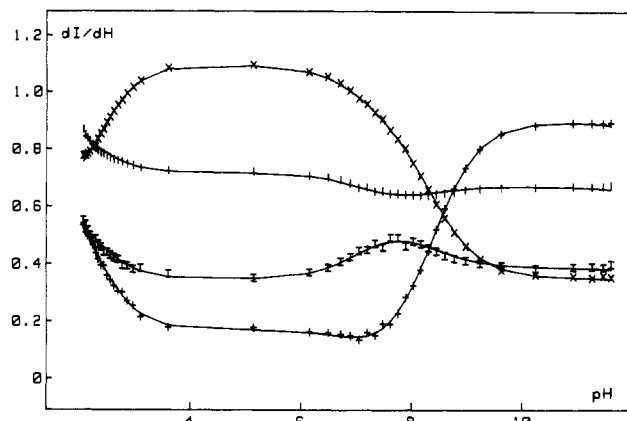

Figure 4. EPR titration curves for the copper(II)-DANA system. Experimental points: | (2925 G); x (3185 G); I (3205 G); + (3235 G). Calculated curves: —. (Conditions are as in Figure 2.)

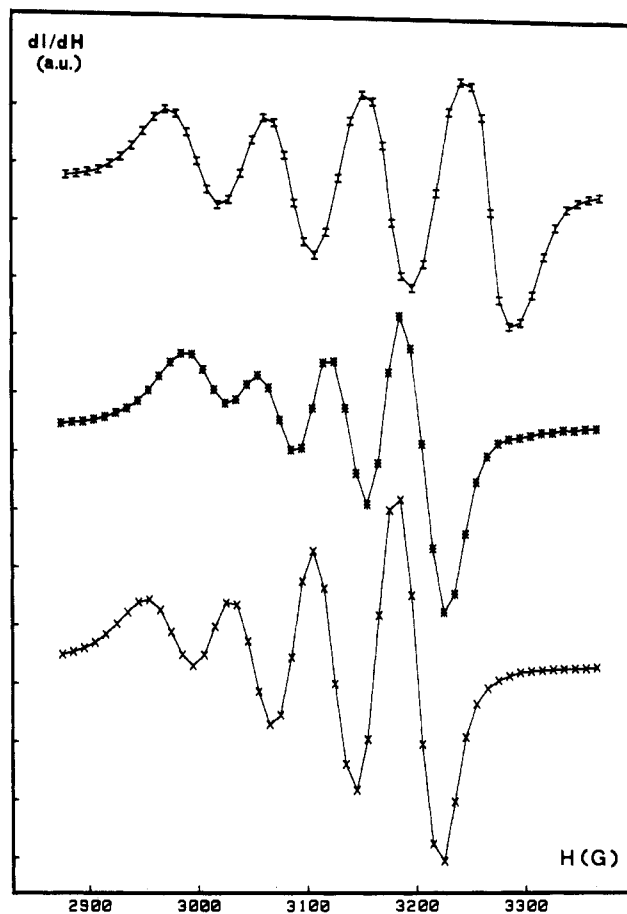

Figure 5. Calculated EPR spectra of the copper(II)-DANA complexes: x, CuL^{2+} ; *, CuLH_1^+ ; I, CuLH_2 .

and corresponds to the instrumental noise and the error of digitizing.

The results obtained from the different data sets show that no special care has to be taken with respect to the data selection, the only requirement being to include data from all magnetic field regions where spectral changes occur.

EPR Spectra of the Copper(II)-DANA Complexes. The spectra of complexes 1-3 (Figure 5; Chart I) show four lines, consistent with the interaction of an unpaired electron with a copper nucleus of nuclear spin $I = 3/2$. Each spectrum has an asymmetrical shape; the heights of the peaks increase with the magnetic field, whereas the line widths do not change significantly. This means that at room temperature the complexes do not rotate fast enough that the anisotropic terms in the Hamiltonian are averaged to zero, which would result in

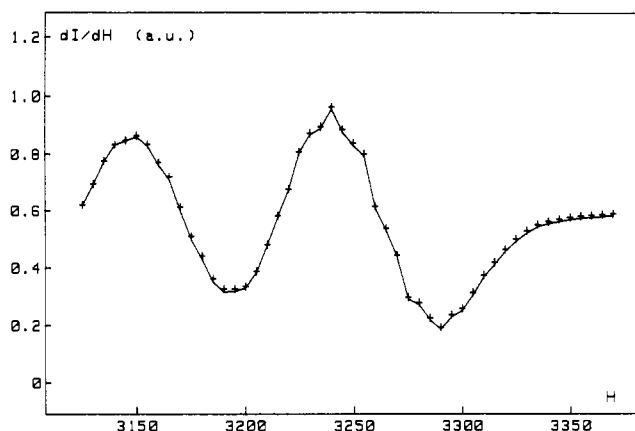

Figure 6. Experimental (+) and calculated (—) EPR spectra of the copper(II)-DANA system at pH 11.5. (Conditions are as in Figure 2.)

a completely isotropic and therefore symmetric spectrum. The asymmetry of the calculated spectra decreases from CuL^{2+} over CuLH_1^+ to CuLH_2 and thus parallels the decrease of charge on the complexes. A possible explanation is that, in this medium of high ionic strength, the more positive the charge of the complex is, the higher is its solvation and the more restricted is its rotation. A similar presence of anisotropic terms has been reported for the room-temperature EPR spectra of copper(II)-dipeptide complexes in solution.^{15,18}

Only the complex formed at high pH, CuLH_2 (2), shows an additional hyperfine structure on the $m = -3/2$ line (Figure 5; Figure 2, lower part), due to the interaction of the unpaired electron with the ^{14}N nuclei ($I = 1$). Owing to the large overlap of these lines and their asymmetry, their exact number and relative intensities cannot be assigned.¹⁵ The splitting is about 13 G, which is in agreement with the values found for copper(II)-dipeptide complexes.¹⁸ It should be emphasized, however, that although the exact hyperfine pattern is not well resolved, both the measured and the calculated spectra at high pH show the same hyperfine features (Figure 6). Thus, without making any assumption with respect to the shape of the EPR spectra of the complexes, the mathematical method used in the least-squares refinement allows calculation of the correct spectra and even reproduces their finer details.

Another test for the reliability of the results of the calculation consists of determining the spin concentration for each complex. This is done by doubly integrating the calculated first-derivative spectra with respect to the magnetic field strength. As there is one unpaired electron in each complex, the double integration should give the same number in each case. In fact, the calculated integrals (Table III) differ by less than 5%. Again, it should be noted that this result, which is demanded by the theory, has not been introduced into the algorithm used. Therefore, the close agreement of the integrals calculated for the three complexes is an independent test for the reliability of our results.

The values for g_{av} decrease in the order $\text{CuL} > \text{CuLH}_1 > \text{CuLH}_2$ (Table III). In the same order the positive charge on the complexes decreases and the axial ligand field changes from N_2O_2 over N_3O to N_4 .²⁰ These effects result in an increase of the cubic ligand field and thus in a shift of the d-d band to shorter wavelengths^{33,34} and should lead to smaller

Table III. Spectral Parameters of the Cu^{2+} -DANA Complexes Obtained from EPR Titration^a

species	g_{av}^b	A_{av}^c $\text{cm}^{-1} \times 10^{-3}$	$I,^c$ au	$\lambda_{\text{max}},^d$ nm
CuL	2.125	7.34	126	628
CuLH_1	2.111	6.31	132	584
CuLH_2	2.100	8.72	132	526

^a The values for g_{av} and A_{av} were determined graphically from the calculated spectra. ^b The magnetic field was calibrated by using the signal of pentaphenylallyl as standard. ^c Double integral calculated between 2750 and 3450 G by numerical integration. ^d From spectrophotometric titration.^{20,26}

values for g_{av} and to greater values for A_{av} , as has been shown for a large and representative number of cupric complexes.¹² The values for A_{av} do not completely follow the expected order (Table III). This is due to the fact, that the EPR spectra of the three complexes are not completely isotropic and moreover differ in their degree of anisotropy (vide supra).

Although the solution EPR spectra do not give the full structural information (due to the fact that only averaged values for g and A are observed), solution studies will be helpful in relating information obtained from EPR in solid matrices to the complexes, which are actually present in solution.³⁴

Conclusions

The present study shows that stability constants and spectra of the complexes can be obtained from solution EPR data.

The use of appropriate mathematical methods allows numerical evaluation to be done in a straightforward manner even on a desk computer. Only initial estimates for the stability constants are necessary, while no information with regard to the spectra of the complexes is needed. No care has to be taken to select the data such that only distinct complexes give rise to a signal, since by doing the calculation on the complete data set simultaneously all the information from the measurement is used.

Thus, EPR titration offers an alternative both to potentiometric and to spectrophotometric titrations. It is superior to pH measurements in strongly acidic or basic solutions, where the buffering capacity of H_3O^+ and OH^- obscures any complexation equilibria, and also gives structural information. While this is also true for spectrophotometry, EPR spectroscopy has the advantage that due to specific hyperfine interactions a more detailed picture of the structure of the complexes is obtained. In addition, the spin concentration for each complex can be calculated, which allows confirmation of the results of the mathematical analysis. Thus, while in no way suggesting abolishment of potentiometric or spectrophotometric titrations, we are advocating EPR titration, to be included whenever this is feasible. It is to be expected that the latter method will be essential for establishing the correct solution structure of complexes in many cases.

Acknowledgment. Prof. A. D. Zuberbühler provided the ligand, and Prof. F. Gerson and Dr. W. Huber (all from the University of Basel) allowed us to use their EPR spectrometer. This work was supported by the Swiss National Science Foundation (Grant No. 2.213-081).

(33) Billo, E. J. *Inorg. Nucl. Chem. Lett.* **1974**, *10*, 613.

(34) Sigel, H.; Martin, R. B. *Chem. Rev.* **1982**, *82*, 385.