

Contribution from the Department of Chemistry, Northeastern University, Boston, Massachusetts 02115, and the Faculty of Science, Alexandria University, Alexandria, Egypt

Distinguishable Sites in Tetranuclear Oxocopper(II) Complexes $(\text{py})_3\text{Cu}_4\text{Cl}_4\text{O}_2$ and $(\text{DENC})_3\text{Cu}_3\text{M}(\text{H}_2\text{O})\text{Cl}_4\text{O}_2$ ($\text{M} = \text{Co}, \text{Ni}, \text{Cu}, \text{Zn}$)

Geoffrey Davies,*^{1a} Mohamed A. El-Sayed,*^{1b} Ahmed El-Toukhy,^{1b} Maher Henary,^{1a} and Colleen A. Martin^{1a,c}

Received May 9, 1986

Tetranuclear oxocopper(II) complexes $(\mu_4\text{-O})(\text{py})_3\text{Cu}_4\text{Cl}_4\text{O}$ (Ia; py = pyridine) and $(\mu\text{-O})(\mu_4\text{-O})(\text{DENC})_3\text{Cu}_4\text{Cl}_4(\text{H}_2\text{O})$ (III; DENC = *N,N*-diethylnicotinamide), which disproportionate on attempted crystallization, have been investigated by electronic and EPR spectroscopy, titration with *N,N,N',N'*-tetraethylethylenediamine (TEED), and transmetalation with $\text{Ni}(\text{NS})_2$ (NS = *S*-methyl isopropylidenehydrazinecarbothioate) in aprotic solvents. Each complex has similar electronic spectra in methylene chloride and nitrobenzene, but both have higher molar absorptivities in nitrobenzene. This phenomenon is not observed for symmetrical complexes $(\mu\text{-O})_2[(\text{DENC})\text{CuCl}]_4$ (II) and $(\mu_4\text{-O})(\text{py})_4\text{Cu}_4\text{Cl}_6$ (V) and indicates that Ia and III are asymmetrical, polar molecules. Although Ia is EPR-silent, reaction with 1 mol of py in methylene chloride at 25 °C gives $(\mu_4\text{-O})(\text{py})_4\text{Cu}_4\text{Cl}_4\text{O}$ (Ib), which has an axial spectrum ($g_{\perp} = 2.09$, $g_{\parallel} = 2.00$) assigned to its Cu-(terminal O) site, labeled V; a tetragonally compressed octahedral geometry is suggested for site V in complex Ib. The stoichiometry $\Delta(\text{TEED})/\Delta(\text{Ia,b}) = 1.5$ is interpreted to indicate that py is relatively weakly coordinated at site V and that the three other $(\mu_4\text{-O})\text{-Cu}(\text{py})$ sites (site X) in complexes Ia and Ib are not substituted. A bis($\mu\text{-oxo}$) structure for Ib is also discounted by this stoichiometry. Complexes Ia and Ib fragment on transmetalation with $\text{Ni}(\text{NS})_2$, as found for $(\mu\text{-O})(\mu_4\text{-O})(\text{DENC})_3\text{Cu}_3\text{M}(\text{H}_2\text{O})\text{Cl}_4$ complexes (IV; M = Co, Ni, Zn). Complexes III and IV have solvent-dependent electronic and rhombic EPR spectra at 25 °C in aprotic solvents; the EPR spectra suggest tetragonally elongated geometry at copper. Similar EPR signals are observed for III and IV (M = Zn), indicating that the 6-coordinate copper(II) at site Z in $\text{NCu}_2(\mu\text{-O})\text{-M}_2(\text{OH}_2)_2$ of IV is responsible for EPR activity. Complexes III and IV all react with 2.0 mol of TEED, apparently at their sites $(\mu_4\text{-O})\text{-Cu}(\text{DENC})$, labeled X. Complex III is completely transmetalated by 4 mol of $\text{Ni}(\text{NS})_2$ in separate stoichiometric steps without fragmentation. Sites in the tetranuclear products of stepwise transmetalation of III have been assigned from their electronic and EPR spectra. Those containing two and three nickel centers isomerize to products that are spectroscopically identified. EPR spectroscopy shows that nickel remains at site Z during isomerization. The kinetics of isomerization are compared with those of isomerization of $(\mu\text{-O})_2[\text{NCuNi}(\text{H}_2\text{O})\text{Cl}_2]_2$ (VII) in methylene chloride and nitrobenzene. It is concluded that copper at site Y is effectively 4-coordinate in complexes that also have nickel at site Z.

Introduction

Previous work in our laboratories has identified five possible core structures, I-V (Chart I), for neutral, tetranuclear (halo)oxocopper(II) complexes. Complex I is the apparent result of aprotic oxidation of $(\text{py})_m\text{Cu}_4\text{Cl}_4$ complexes (py = pyridine, $m = 3$ (Ia) or 4 (Ib)) with dioxygen.²⁻⁵ Changing py to N = monodentate *N,N*-diethylnicotinamide (DENC) or ethylnicotinate with $m = 4$ or 8 gives product II.^{2,3,6,7} Complex III is a specific example of the products IV from aprotic oxidation of $\text{N}_3\text{Cu}_3\text{M}(\text{NS})_n\text{Cl}_4$ complexes (M = Co, Ni, Cu, Zn; NS is monoanionic *S*-methyl isopropylidenehydrazinecarbothioate; $n = 1$ or 2) with dioxygen.^{8,9}

Attempted crystallization of products I-IV often results in disproportionation to give the well-known crystalline structure V, where the N ligand shown is py or DENC. Indirect methods of structural distinction are therefore necessary. Among those we have applied are the following.

1. Initiator Activity. An ability to initiate the oxidative coupling of phenols by dioxygen is specifically ascribed to complexes Ia and Ib.^{2,3,8,9}

2. Solvent-Dependent Electronic Spectra. Only the electronic spectra of complexes I are reported to have different maximum molar absorptivities, ϵ , in methylene chloride and nitrobenzene.³ Here, we report solvent dependence of the spectra of complexes III and IV (M = Ni).

Chart I

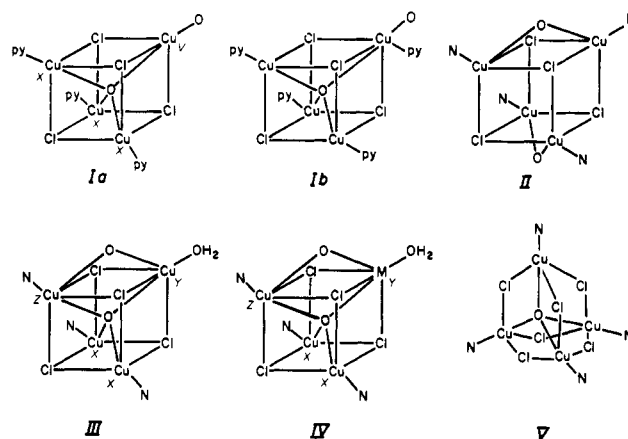

3. Room-Temperature EPR Activity. Complexes II³ and V¹¹ are EPR-silent at room temperature. Here, we report the room-temperature EPR spectra of Ib, III, IV, and particular transmetalated^{2,6,6-9} derivatives of III.

4. Reaction with Carbon Dioxide. Only complexes of type II³ form carbonato derivatives.

5. Reactions with *N,N,N',N'*-Tetraethylethylenediamine (TEED). Complexes II and V react stoichiometrically with 2 and 4 mol of TEED, respectively.⁶ Here, we report the stoichiometries of the reactions of I, III, and IV with TEED.

6. Transmetalation Stoichiometries and Products. The copper(II) centers of I⁶ and V^{6,7} can be completely replaced with nickel(II) from $\text{Ni}(\text{NS})_2$ reagents, but the transmetalated products differ greatly in their stability: those obtained from I have time-dependent properties.⁶ Transmetalation of IV (M = Co, Ni, Zn) by $\text{Ni}(\text{NS})_2$ is accompanied by the characteristic disproportionation of a CuO unit.^{8,9} By contrast, complex II is only transmetalated to the Cu_2Ni_2 stage by excess $\text{Ni}(\text{NS})_2$ reagents and no CuO disproportionation is observed.^{6,7} We show here that CuO disproportionation also does not occur on stepwise transmetalation of III and discuss the likely transmetalation product structures. Certain of the transmetalated species isomerize in aprotic solvents. The products have been identified and the kinetics

- (1) (a) Northeastern University. (b) Alexandria University. (c) Undergraduate research student, 1985-1986.
- (2) Davies, G.; El-Sayed, M. A. In *Inorganic and Biochemical Perspectives in Copper Coordination Chemistry*; Karlin, K. D., Zubieta, J. A., Eds.; Adenine: Guilderland, NY, 1983; p 281.
- (3) Davies, G.; El-Sayed, M. A. *Inorg. Chem.* **1983**, *22*, 1257.
- (4) Bodek, I.; Davies, G. *Inorg. Chem.* **1978**, *17*, 1214.
- (5) Davies, G.; El-Sayed, M. A.; Fasano, R. E. *Inorg. Chim. Acta* **1983**, *71*, 95.
- (6) El-Toukhy, A.; Cai, G.-Z.; Davies, G.; Gilbert, T. R.; Onan, K. D.; Veidis, M. J. *Amer. Chem. Soc.* **1984**, *106*, 4596.
- (7) Cai, G.-Z.; Davies, G.; El-Toukhy, A.; Gilbert, T. R.; Henary, M. *Inorg. Chem.* **1985**, *24*, 1701.
- (8) Davies, G.; El-Sayed, M. A.; El-Toukhy, A.; Gilbert, T. R.; Nabih, K. *Inorg. Chem.* **1986**, *25*, 1929.
- (9) Davies, G.; El-Sayed, M. A.; El-Toukhy, A.; Henary, M.; Gilbert, T. R. *Inorg. Chem.* **1986**, *25*, 2373.
- (10) tom Dieck, H. *Inorg. Chim. Acta* **1973**, *7*, 397.

Table I. Diagnostic Properties of Tetranuclear Halooxo(amino)copper(II) Complexes

property	core structure				
	I	II	III	IV ^a	V
initiation activity ^b	yes	no	no	no	no
EPR (298 K) ^c	<i>a^d</i>	<i>s^e</i>	<i>r^d</i>	<i>r^d</i>	<i>s^e</i>
spectral solvent dependence ^f	yes	no	<i>yes</i>	<i>yes</i>	no
reaction with CO ₂	no	yes	no	no	no
TEED stoichiometry ^g	<i>1.5</i>	2.0	2.0	<i>2.0</i>	4.0
Ni(NS) ₂ transmetalation product ^h	Ni ₄	Cu ₂ Ni ₂	Ni ₄	Ni ₃	Ni ₄

^aM not Cu. ^bFor initiation of oxidative coupling of 2,6-dimethylphenol by dioxygen.² ^cIn methylene chloride or nitrobenzene. ^d*a* = axial for Ib only (see text); *r* = rhombic. ^e*s* = EPR silent. ^fComparison between methylene chloride and nitrobenzene solutions. ^g Δ TEED/ Δ (I-V) for complete reaction at [I-V] = (1-3) × 10⁻³ M. ^hWith excess Ni(NS)₂.

are compared with those for other tetranuclear isomerizations.^{6,7}

Results of past and present diagnostic investigations are summarized in Table I. New results are italicized.

Experimental Section

Materials. The syntheses of (py)_{*m*}Cu₄Cl₄O₂ (Ia,b; *m* = 3 or 4),³⁻⁶ N₃Cu₃Cu(H₂O)Cl₄O₂ (III), and N₃Cu₃M(H₂O)Cl₄O₂ (IV; N = *N,N*-diethylnicotinamide; M = Co, Ni, Zn)^{8,9} followed literature procedures. Methods for purification of all reactants, solvents and products have been described.^{3,4,6-9}

Physical Measurements. Physical measurements were conducted at 25 °C. EPR spectra of reactants and products (1.0 mM) in aprotic solvents were obtained with a Varian E-9 instrument. Electronic spectra were measured in methylene chloride or nitrobenzene solution with a Beckman DK-1A spectrophotometer and matched quartz cells. Spectrophotometric titrations of I, III, and IV (2.0 mM) with TEED were performed in methylene chloride by using standard techniques. Titration mixtures were left at room temperature for at least 6 h to ensure complete reaction. The kinetics of isomerization of transmetalated products were measured by conventional spectrophotometry at 850 nm as described previously.^{6,7}

Results and Discussion

Structures for complexes I-V in Chart I have been assigned on the basis of a variety of evidence (Introduction and Table I), which is further discussed and supported in the following sections.

Two structural subgroups are evident in these neutral tetranuclear complexes. The first, exemplified by complexes II and V, contains four N ligands. Complex II contains a 3-coordinate halide together with two μ -oxo groups, while complex V has a 2-coordinate halide and a central μ_4 -oxo group.⁶ Table I shows that, aside from their different Cu:O:X ratios, II and V can be distinguished by their reactivity toward CO₂ and from the stoichiometries of reactions with TEED and transmetalation with excess Ni(NS)₂.

Complexes in the second subgroup, I, III, and IV, have the same metal:halide ratios and are all supposed to contain 3-coordinate halide. Complexes I have different copper(II) sites labeled V and X in Chart I. Sites X are also evident in complexes III and IV. They differ from those labeled Y and Z in compounds III and IV, which are linked by a μ -oxo group and are also separately connected to a μ_4 -oxo group. The members of this second subgroup are asymmetrical, polar molecules.

Our goal is to demonstrate the effects of asymmetry and different metal sites on the properties of tetrameric oxocopper(II) complexes by use of the tools on Table I. In this paper we pay particular attention to complexes I and III.

Properties of I. Electronic Spectra. We know that phenolic oxidative coupling initiator I exists in two forms, Ia and Ib, where Ib carries a fourth py ligand. Both are tetranuclear complexes in nitrobenzene, where they exhibit closely similar spectra with broad maxima at 725 nm ($\epsilon = 810 \text{ M}^{-1} \text{ cm}^{-1}$) and 810 nm ($\epsilon = 830 \text{ M}^{-1} \text{ cm}^{-1}$).^{2,3} Maxima at these same wavelengths also are observed in methylene chloride but the molar absorptivities for Ia and Ib are significantly lower (725 and 715 $\text{M}^{-1} \text{ cm}^{-1}$, respectively) in this solvent.³ Since the electronic spectra of II and V are unaffected by changing the solvent from nitrobenzene to

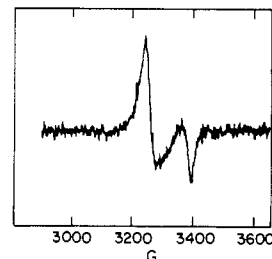
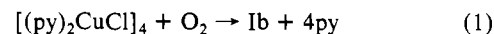

Figure 1. EPR spectrum of Ib (1.0 mM) in nitrobenzene at 25 °C. Sensitivity = 2 × 10³.

methylene chloride,^{3,6} we conclude that spectral solvent dependence is distinctive of asymmetrical, polar tetranuclear oxocopper(II) complexes.

We also know that the absorptivity of complex Ib in nitrobenzene decreases in the presence of excess pyridine, produced in eq 1 (see Figure 2 of ref 3) or deliberately added to nitrobenzene



solutions of Ib (Figure 2 of ref 5). These decreases have been ascribed to reaction 2 with $n = 4.23 \pm 0.07$ and $K = (2.1 \pm 0.8)$

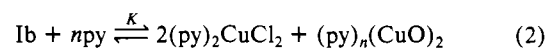

× 10⁸ M⁻² at 25 °C and contrast sharply with the low affinity of molecule V (N = py) for added pyridine.⁵ Reaction 2 can be envisioned as disproportionation of two of the site X centers of Ib as a result of py coordination at site X. This leaves the "spine" of I, py_{*n*}(Cu_X-O-Cu_V-O), a highly reactive, polymerizing species.⁴ The question is whether we can demonstrate that Ib has py coordinated at site V. EPR spectroscopy provides the answer.

EPR Spectroscopy. We found previously that symmetrical oxocopper(II) complexes II³ and V¹¹ are EPR-silent in methylene chloride at room temperature. This also is the case for (μ -O)₂L₄Cu₄ (L = 6-methyl-2-hydroxypyridinate), which contains bridging, monoanionic ligands L and identical (presumably 3-coordinate), copper(II) centers.¹³ Thus, on this evidence alone, room-temperature EPR silence can be attributed to identical copper(II) centers in tetranuclear oxocopper(II) structures of high symmetry.

From the unit N:Cu stoichiometry of symmetrical complexes II and V (N = py)⁶ and the existence of Ib as a discrete tetranuclear molecule subject to disproportionation by excess py, eq 2, we can suggest that 1 mol of py is coordinated by the V site of Ia.^{2,3} We now report that while Ia is EPR-inactive in nitrobenzene at room temperature, Ib is active (Figure 1). Addition of 1 mol of py to Ia changes the coordination number at the V site from 5 to 6. Thus, room-temperature EPR silence in tetranuclear Ia, II, and V seems to be associated with 5-coordinate copper(II) centers, irrespective of their local geometry or coordinated O, N, or Cl atoms.

If Ia contained a μ -oxo group and three-coordinate halide, then one of its copper(II) centers would be 6-coordinate and EPR-active at room temperature, contrary to observation.

The room-temperature EPR spectrum of Ib is axial ($g_{\perp} = 2.09$ and $g_{\parallel} = 2.00$), which suggests tetragonally compressed octahedral geometry at site V.¹⁴ The O-Cu-O vector is the likely principal

(11) Davies, G.; El-Sayed, M. A.; El-Toukhy, A. *Inorg. Chem.* **1986**, *25*, 2269.

(12) Davies, G.; El-Toukhy, A.; Onan, K. D.; Veidis, M. *Inorg. Chim. Acta* **1985**, *98*, 85.

(13) Cai, G.-Z.; Davies, G.; El-Sayed, M. A.; El-Toukhy, A.; Gilbert, T. R.; Onan, K. D. *Inorg. Chem.* **1986**, *25*, 1935.

(14) Hathaway, B. J.; Billing, D. E. *Coord. Chem. Rev.* **1970**, *5*, 143. We are aware of the limitations of the use of room-temperature EPR solution spectra to assign specific copper(II) geometries, and our geometrical suggestions are tentative pending further work. Our experience indicates that single-crystal samples of complexes I-IV (Chart I) are difficult, if not impossible, to obtain.

Chart II

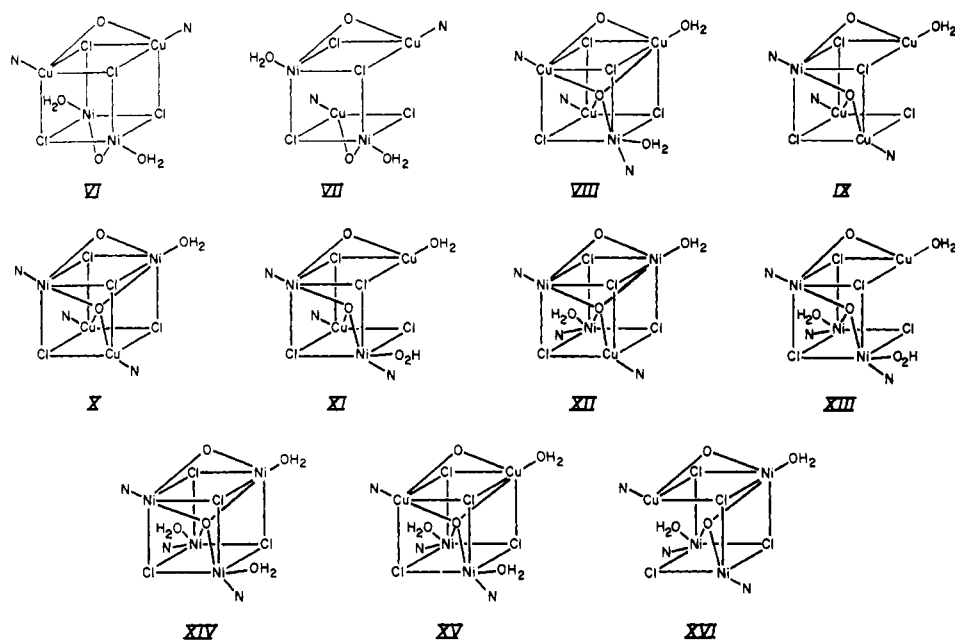

axis.¹⁵ Examination of space-filling models suggests that Cu₄ is displaced out of the Cl, Cl, Cl, N plane toward the O (terminal) atom.¹⁴

Reactions with TEED. General Observations. Previous work has shown that the hard, bidentate ligand TEED stoichiometrically reacts with tetranuclear oxocopper(II) complexes to extents that depend on their core structures. Thus, complex II reacts with 2 mol of TEED,³ while the transmetalated product $(\mu\text{-O})_2[\text{NCu-Ni}(\text{H}_2\text{O})\text{Cl}_2]_2$ (VI), Chart II, reacts with only 1 mol of TEED.⁶ The difference arises because VI contains only one $\text{NCu}(\mu\text{-O})\text{CuN}$ unit and its $(\text{H}_2\text{O})\text{Ni}(\mu\text{-O})\text{Ni}(\text{H}_2\text{O})$ unit is not substituted by TEED. In each case one N of $\text{NCu}(\mu\text{-O})\text{CuN}$ is replaced by TEED.⁶ There is evidence that electronic coupling between the copper(II) centers of $\text{NCu}(\mu\text{-O})\text{CuN}$ units of II limits the extent of its substitution by TEED to one.⁶ We feel that the $\text{Cu}(\mu\text{-O})\text{-Cu}$ angles in II are sufficiently large and/or flexible to allow effective electronic coupling responsible for these limits and for the ability of complexes II and VI to form dicarbonates.^{3,6,7}

By contrast, V reacts completely with 4 mol of TEED, a property associated with the presence of 2-coordinated halide and a central $\mu_4\text{-oxo}$ group.⁶

Titration of I with TEED. Figure 2 shows that Ia and Ib (2.0 mM) both completely react with only 1.5 mol of TEED in methylene chloride. The stoichiometry $\Delta(\text{TEED})/\Delta(\text{I})$ was independent of analytical wavelength in the range 575–800 nm. The titration of Ib gave a product with $\lambda_{\text{max}} = 700$ nm and isosbestic at 520 and 665 nm.

The same stoichiometry of reaction of Ia and Ib with TEED indicates that py coordinated to the V site in Ib is easily replaced by TEED; the stoichiometry also shows that the three copper sites X are not substituted. Substitution of TEED for py at site V in Ia would increase its coordination number to 7; therefore, bonds to 3-coordinate halide and/or the $\mu_4\text{-oxo}$ group must be broken or at least weakened on addition of TEED; it is this requirement that presumably increases the stoichiometry above $\Delta(\text{TEED})/\Delta(\text{I}) = 1.0$. However, the fact that $\Delta(\text{TEED})/\Delta(\text{I})$ is less than 2 confirms that Ib does not contain two $(\text{py})\text{Cu}(\mu\text{-O})\text{Cu}(\text{py})$ units (see previous section and data for II in Table I).

Transmetalation of I with $\text{Ni}(\text{NS})_2$. Although it has been shown that Ia,b react stoichiometrically with 4 mol of $\text{Ni}(\text{NS})_2$ reagents

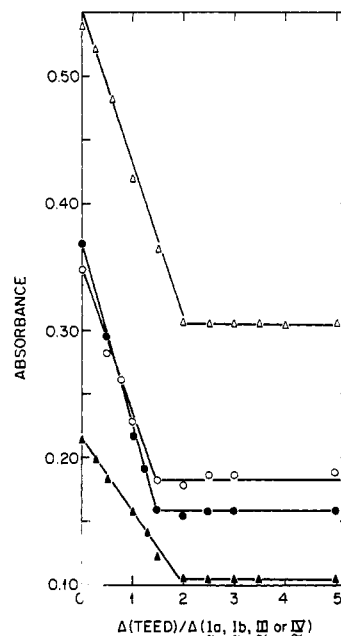

Figure 2. Spectrophotometric titrations of Ia (○), Ib (●), III (▲), and IV (M = Ni) (△) (all 2.0 mM), with TEED in methylene chloride at 750, 800, 850, and 800 nm, respectively, at 25 °C.

to give 4 mol of $\text{Cu}(\text{NS})_2$ (Table I), the transmetalated products have time-dependent properties that defy complete characterization.⁶ Disproportionation commences on addition of only 1 mol of $\text{Ni}(\text{NS})_2$, testifying to the fragility of Ia as a result of addition of py at sites X (eq 2) or on transmetalation of just one of its copper centers. By contrast, we shall see that the closely similar complex III does not disproportionate on transmetalation with $\text{Ni}(\text{NS})_2$, which gives identifiable, tetranuclear products and important information on sites X, Y, and Z.

Summary. Structure Ia has two distinct sites, V and X, which are both 5-coordinate. Coordination of py at site V gives a 6-coordinate site in Ib that is epr-active. Bidentate TEED displaces py from site V but does not displace py from sites X. However, sites V and X coordinate excess py, which causes disproportionation of I via eq 2. Complex I disproportionates on transmetalation with $\text{Ni}(\text{NS})_2$ reagents. Total transmetalation destroys its ability to act as an initiator and catalyst for phenol oxidation by dioxygen.⁶

(15) Davies, G.; El-Shazly, M. F.; Rupich, M. W.; Churchill, M. R.; Rotella, F. J. *J. Chem. Soc., Chem. Commun.* **1978**, 1045. Davies, G.; El-Shazly, M. F.; Kozlowski, D. R.; Kramer, C. E.; Rupich, M. W.; Slaven, R. W.; *Adv. Chem. Ser.* **1979**, No. 173, 178.

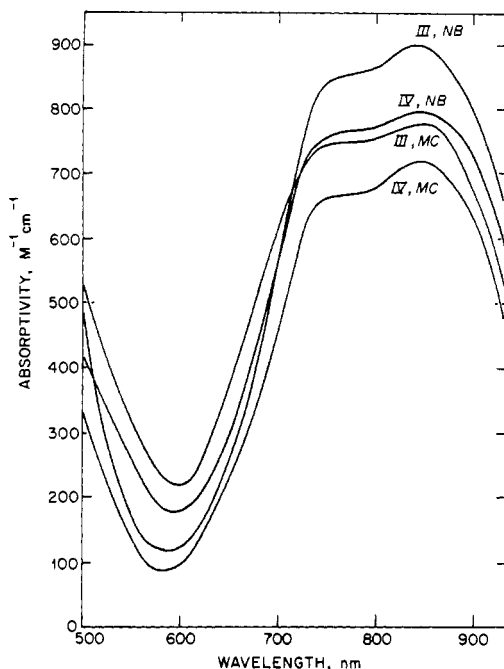
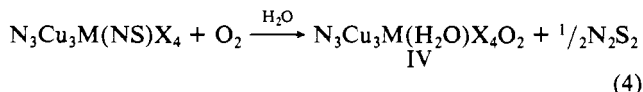
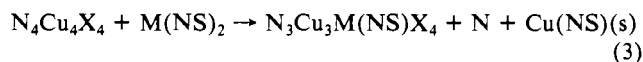

Figure 3. Electronic spectra of III and IV ($M = \text{Ni}$) in methylene chloride (MC) and nitrobenzene (NB) at 25 °C.

Properties of III and IV. General Observations. Complex III is a specific example of general structure IV proposed for the products of reactions 3 and 4, where M is Co, Ni, Cu, or Zn.^{8,9}



The previously proposed structure for III contains two 6-coordinate copper(II) sites (labeled Y and Z in Chart I) and two 5-coordinate copper(II) sites labeled X by analogy with complexes Ia and Ib. The Y site in IV is occupied by Co, Ni, or Zn.^{8,9} Complexes IV are asymmetric and polar. This property and the presence of six-coordinate copper should give rise to solvent-dependent electronic spectra and EPR activity, as demonstrated in the next section.

Electronic Spectra. Figure 3 shows that the electronic spectra of complexes III and IV ($M = \text{Ni}$)¹⁶ are solvent-dependent, with higher absorbivity in nitrobenzene, as found for Ib.³ However, in contrast to the effects of py in eq 1, addition of 4 mol of DENC does not alter the spectra of III or IV in either solvent. We already know that very large excesses of DENC are necessary to affect the spectra of II and V,¹² so this result is not surprising. However, it does show that the Y site of III has a low affinity for DENC, which is in sharp contrast to the higher affinity of the V site of Ia for py (see above).

EPR Activity. The spectra in Figure 4 demonstrate that complexes III and IV ($M = \text{Co}, \text{Ni}, \text{Zn}$) are EPR-active at room temperature in methylene chloride. The spectra in Figure 4 were all measured with 1.0 mM solutions. All the spectra are rhombic, and not axial as observed for Ib (Figure 1).

The signal strength is affected by M at sites Y^{8,9} in complexes III and IV. The spectra for III and IV ($M = \text{Zn}$) have similar strengths, which indicates that rhombic EPR activity is due to copper site at Z. The room-temperature EPR signal of IV is stronger with $M = \text{Co}^{\text{II}}$ or Ni^{II} , which have fewer electrons than Cu^{II} .

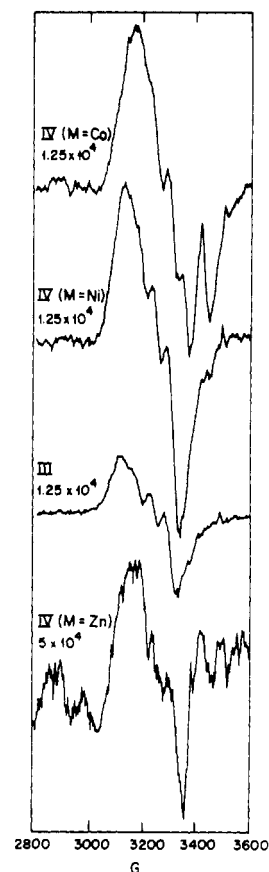

Figure 4. EPR spectra of III and IV ($M = \text{Co}, \text{Ni}, \text{Zn}$) in methylene chloride at 25 °C. Instrumental sensitivity is given for each spectrum. The signals are weaker than those for typical monomeric copper(II) complexes.¹¹

The room-temperature EPR spectrum of III (Figure 4) is rhombic ($g_{\perp} = 2.18, g_{\parallel} = 2.09, g_3 = 2.04$), suggesting a tetragonally elongated rhombic octahedral geometry at site Z,¹⁴ whatever the detailed geometries, the different EPR spectra clearly distinguish between Ib and III and reveal the EPR activity of sites Z in III and IV.

Summary. Room-temperature EPR silence in tetranuclear (halo)oxocopper(II) complexes is associated with strongly coupled 5-coordinate metal centers even in asymmetrical structure Ia. The presence of 6-coordinate copper(II) weakens electronic coupling and leads to room-temperature EPR activity, specifically at site V in Ib and site Z in III and IV. EPR measurements at room temperature are useful for detecting different coordination numbers of copper(II) centers in tetranuclear oxocopper(II) complexes.

Titration of III and IV with TEED. Figure 2 shows that III and IV ($M = \text{Ni}$) completely react with TEED with stoichiometry $\Delta(\text{TEED})/\Delta(\text{III})$ or $(\text{IV}) = 2.0$ in methylene chloride at room temperature. This stoichiometry was independent of analytical wavelength in the range 575–850 nm. The products with IV ($M = \text{Co}$ or Ni) had maxima at 650 nm and isobestics at 540 and 675 nm. The product of complete reaction of III with TEED had a slight shoulder at 700 nm and an isobestic at 650 nm.

The most obvious explanation is that only the X sites of III and IV are substituted by TEED, as observed for the 5-coordinate $\text{NCu}-(\mu_4\text{-O})-\text{CuN}$ units in V⁶ and irrespective of M in IV. We pointed out above that $\text{NCu}-(\mu\text{-O})-\text{CuN}$ units in II each substitute one TEED,³ but the $\text{NCu}_Z-(\mu\text{-O})-\text{M}_Y(\text{H}_2\text{O})$ unit in IV is not substituted. Site Z is already 6-coordinate; site Y also has a low affinity for TEED and may not be coordinated to the μ_4 -oxo group (see below).

Transmetalation of III and IV by Bis(*S*-methyl isopropylidenehydrazinecarbodithioato)nickel(II) ($\text{Ni}(\text{NS})_2$). **General Observations.** Proposed structures for III and IV contain μ - and μ_4 -oxo groups. As such, their transmetalation by bis(*S*-methyl isopropylidenehydrazinecarbothioato)nickel(II) ($\text{Ni}(\text{NS})_2$)⁶ shows

(16) IV ($M = \text{Ni}$) was chosen to demonstrate the electronic spectral solvent effect because nickel centers have very low absorbivity in the 500–900-nm region (see text).

Table II. Analytical and Cryoscopic Data for Reactions and Transmetalated Products^a

symbol ^b	complex	anal., %							M_r^c
		C	H	N	Cl	Cu	Ni		
III	$N_3Cu_4Cl_4O_2 \cdot 2H_2O$	35.8 (36.7)	4.1 (4.5)	8.6 (8.6)	14.0 (14.46)	25.3 (25.9)			950 ± 20 (980.5)
IV	$N_3Cu_3NiCl_4O_2 \cdot 2H_2O^d$	36.6 (36.7)	4.6 (4.5)	8.4 (8.6)	15.2 (14.53)	20.2 (19.5)	6.6 (6.05)		1000 ± 20 (976)
	$N_3Cu(Ni(H_2O))_2Cl_4O^e$	38.1 (38.9)	4.0 (5.0)	8.7 (9.07)	16.7 (15.31)	5.8 (6.8)	11.6 (12.7)		840 ± 20 (926)
IX	$N_3Cu_3NiCl_4O_2 \cdot 2H_2O$	36.3 (36.9)	4.3 (4.5)	8.3 (8.6)	14.1 (14.53)	18.8 (19.5)	6.4 (6.05)		940 ± 20 (976)
X	$N_3Cu_2Ni_2Cl_4O_2 \cdot 2H_2O$	36.7 (37.0)	4.3 (4.5)	8.4 (8.6)	14.1 (14.6)	12.4 (13.1)	11.3 (12.15)		1030 ± 20 (972)
XI	$N_3Cu_3Ni_2Cl_4O_2 \cdot 2H_2O$	36.5 (36.4)	4.4 (4.6)	8.4 (8.6)	13.8 (14.33)	13.5 (12.8)	12.6 (11.9)		1040 ± 20 (989.5)
XII	$N_3CuNi_3Cl_4O_2 \cdot 2H_2O$	36.2 (36.5)	4.4 (4.7)	8.4 (8.5)	14.7 (14.4)	6.0 (6.4)	16.4 (17.9)		990 ± 20 (985)
XIII	$N_3CuNi_3Cl_4O_2 \cdot 3H_2O$	35.2 (35.9)	4.6 (4.8)	8.5 (8.4)	14.7 (14.1)	6.3 (6.3)	16.6 (17.6)		990 ± 20 (1003)
XIV	$N_3Ni_4Cl_4O_2 \cdot 3H_2O$	36.4 (36.0)	4.6 (4.8)	8.3 (8.4)	14.3 (14.2)		22.6 (23.0)		1060 ± 20 (999)

^a N = DENC; calculated values in parentheses. ^b Symbols in Charts I and II. ^c Determined cryoscopically in nitrobenzene in the range (1–5) × 10⁻² m.³ ^d Data from ref 8. ^e Trinuclear product of eq 6 (M = Ni; see text).

be related to those of oxocopper(II) complexes I, II, and V, each of which contains only one of these respective oxo units.

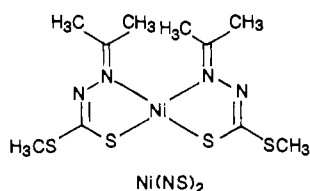

The presence of a μ_4 -oxo group in I and V allows complete exchange of nickel for copper on reaction with 4 mol of Ni(NS)₂.^{6,7} Transmetalation of V is rapid¹¹ and proceeds in separate stoichiometric steps to give discrete products (μ_4 -O)_xN₄Cu_{4-x}(Ni(H₂O))_xX₆ (x = 1–4). Products IV of eq 4 (M = Co, Ni, Zn) also appear to contain a μ_4 -oxo group, but disproportionation with CuO loss accompanies their transmetalation; for example, see eq 5.^{8,9}

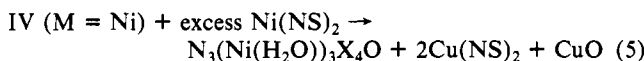

The absence of a μ_4 -oxo group in II leads to transmetalation by excess Ni(NS)₂ which is limited to the Ni₂Cu₂ stage in product VII, Chart II. Limited transmetalation indicates a trans-directing influence across the μ -oxo groups of II.^{6,7,13} Formation of a particularly stable NCu-(μ -O)-CuN unit in VI leads to spontaneous, irreversible isomerization of VII to VI in aprotic solvents, and the kinetics have been measured.^{6,7}

Reaction of IV (M = Ni) with 1 mol of Ni(NS)₂. We have reported that IV (M = Co) reacts with 1 mol of Ni(NS)₂ in eq 6. The first product of eq 6 is impure because of slow reaction IV (M = Co) + Ni(NS)₂ → N₃CuNiCoCl₄O + Cu(NS)₂ + CuO (6)

7 during transmetalation.⁹ We found that reaction 6 also occurs



with IV (M = Ni, Table II), which indicates that IV (M = Co or Ni) characteristically lose 1 mol of CuO on transmetalation with just 1 mol of Ni(NS)₂.

The following questions are addressed in the next sections: (1) Does CuO loss occur on transmetalation of III with Ni(NS)₂ (cf. eq 5 and 6)? (2) If not, can III be completely transmetalated by Ni(NS)₂ in discrete, stoichiometric steps and can each product be identified from its spectra? (3) Do any transmetalation products isomerize?^{6,7} If so, which isomers are formed?

Stoichiometries of Transmetalation of III by Ni(NS)₂. We are pleased to report that III is transmetalated to give tetranuclear products in discrete, stoichiometric steps by 1–4 mols of Ni(NS)₂ in methylene chloride or nitrobenzene at room temperature, eqs 8–11, respectively. The respective products were easily separated

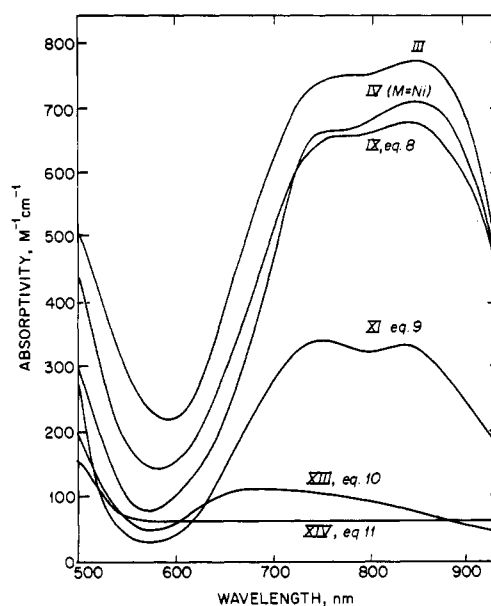
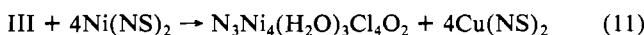
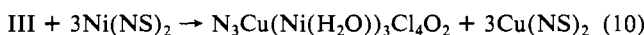
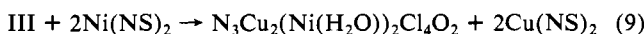
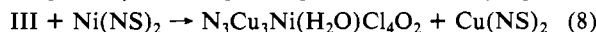

Figure 5. Electronic spectra of III, IV (M = Ni), and the products of eq 8–11 in methylene chloride at 25 °C.

by gel permeation chromatography (methylene chloride eluant), which results in the coordination of aquo ligands.^{6,7}

Analytical data for each tetranuclear product are given in Table II and their electronic spectra in methylene chloride and nitrobenzene at 25 °C are compared with those of III and IV (M = Ni) in Figure 5 and 6, respectively.

Spectral Identification of Transmetalation Products. Comparisons between electronic spectra of tetranuclear oxocopper(II) complexes and their transmetalated derivatives are useful in assigning particular structures and metal centers.^{6,7} Structure VI is assigned because its electronic spectral maxima occur at the same wavelengths as those in II but with half its molar absorptivities.^{6,7} Also, the maxima of V and its derivatives (μ_4 -O)_xN₄Cu_x(Ni(H₂O))_{4-x}Cl₆, (x = 1–4) are found at the same wavelengths, with absorptivities accurately proportional to the atomic copper content.¹¹

The spectra in Figure 5 are those of the tetranuclear products of eq 8–11 (identified by detailed spectral and kinetic analysis (see below) and listed in Chart II), III, and IV (M = Ni) in methylene chloride. The product XIV of eq 11 has very low absorptivity (average 16 L (mol of Ni)⁻¹ cm⁻¹ in the range 540–1000 nm), indicating that maxima in the other spectra are due to copper(II) centers. The single spectral maximum of the product XIII of eq 10 is similar to that of VII (λ_{max} 700 nm; ϵ = 140 M⁻¹ cm⁻¹), but with about half the maximum absorptivity.¹⁷ Product XI of eq 9 (Figure 5) has a spectrum with split maxima similar to that of III but its absorptivities are about half of those of III. Finally, Figure 5, the spectra of product IX of eq 8 and

(17) This spectral similarity is of particular relevance to our discussion of isomerization (see text).

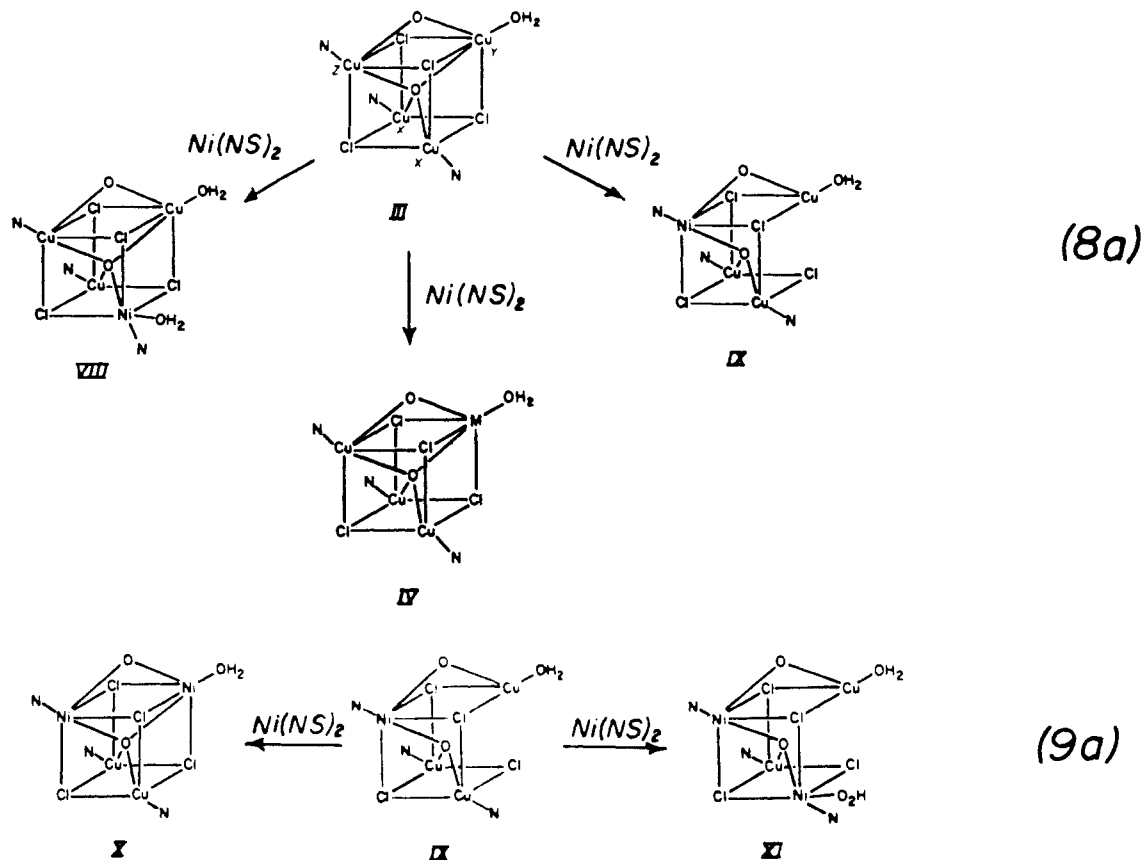

IV (M = Ni) are not quite the same, although they both resemble that of III.

Spectral Identification of Products from Eq 8–11. Taken together, the features of Figures 5 and 6 suggest that three of the four copper centers in III are largely responsible for its spectrum. The fourth, weakly absorbing copper center has the single spectral maximum exhibited by product XIII of eq 10.

The fact that III, IV, and the tetranuclear products of eq 8 and 9 all have spectral features near 760 and 850 nm (Figures 5 and 6) encouraged us to approximate the atomic absorptivities x , y and z of sites X, Y, and Z in III and IV as additive so we could then identify products from their spectra. Thus, the molar absorptivity of III at 850 nm is $\epsilon = 2x + y + z$. Occupancy of site Y by nickel in IV causes a change of atomic absorptivity from y to y' and so on; thus, the molar absorptivity of the tetranuclear product of reaction 11 is $\epsilon = 2x' + y' + z'$.

The assignment of x – z' is described in the Appendix, the parameters used in spectral analysis are given in Table III and a complete summary of observed and calculated molar absorptivities is given in Table IV.¹⁸

Assignment and addition of atomic absorptivities from Table III are useful approximations if they predict observed molar absorptivities ϵ to ca. $\pm 13\%$: we should not expect to be able to distinguish spectrally between the product of eq 8 and IV (M = Ni), Figure 5, although distinction can be made by EPR spectroscopy and from differences of transmetalation behavior. For present purposes our main prediction is that occupancy of sites X by copper in the products of eq 8–10 and their isomerized forms leads to large molar absorptivities ϵ at 850 nm, since x is considerably larger than y , z , x' , y' , or z' (Table III). Comparison through $R_x = x(\text{nitrobenzene})/x(\text{methylene chloride})$ etc. (Table III) also indicates that R_x and $R_{x'} \approx 1$, R_y and $R_{y'} < 1$, and R_z and $R_{z'} > 1$. The first result is consistent with solvent-independent spectra for V;⁶ opposite variations of R_y and $R_{y'}$ and R_z and $R_{z'}$ predict different solvent dependences of electronic spectra (see below).

Table III. Assigned Atomic Absorptivities^a for Copper and Nickel Sites^b

solvent	x	y	z	x'^c	y'	z'
methylene chloride	325	22	100	25	2	10
nitrobenzene	336	8	240	41	1	30
R^d	1.0	0.4	2.4	1.6	0.5	3.0

^aUnits are L (mol of metal)⁻¹ cm⁻¹. ^bSee text and Appendix for assignment procedure. ^cPrimed values are for nickel. ^d $R_x = x(\text{nitrobenzene})/x(\text{methylene chloride})$, etc.

Product of Eq 8. Selective monotransmetalation of III at its X, Y, or Z sites gives alternative products VIII, IV (M = Ni, Chart I), or IX, respectively (eq 8a). Product IV (M = Ni) is discounted because it would disproportionate to give CuO in the analogue of eq 6,^{8,9,19} but no CuO is produced in eq 8–11. From Table III, complex VIII has a calculated molar absorptivity $\epsilon = x + x' + y + z = 462 \text{ M}^{-1} \text{ cm}^{-1}$ in methylene chloride, which is much smaller than that observed (Figure 5).²⁰ Selective transmetalation at site Z gives product IX with calculated $\epsilon = 2x + y + z' = 672$ and $683 \text{ M}^{-1} \text{ cm}^{-1}$ in methylene chloride and nitrobenzene, which is in good agreement with those observed (Figures 5 and 6) and is solvent-independent, as predicted. The tetranuclear product of eq 8 is thus identified as IX (Chart II).

Product of Eq 9. Product IX could be selectively transmetalated at its Y or X sites to give products X or XI, respectively (eq 9a). We calculate $\epsilon = 2x + y' + z' = 661 \text{ M}^{-1} \text{ cm}^{-1}$ for complex X in methylene chloride, which is far greater than the measured molar absorptivity ($335 \text{ M}^{-1} \text{ cm}^{-1}$, Figure 5). Product XI is indicated by calculated $\epsilon = x + x' + y + z = 372 \text{ M}^{-1} \text{ cm}^{-1}$, in much better agreement with experiment, and further confirmed by a calculated value, $415 \text{ M}^{-1} \text{ cm}^{-1}$, which agrees well with the measured value in nitrobenzene (Figure 6). The spectrum of product XI also is not very solvent-dependent.

(19) Davies, G.; El-Sayed, M. A.; El-Toukhy, A.; Henary, M.; Kasem, T. S.; Martin, C. A. *Inorg. Chem.* **1986**, *25*, 3904.

(20) Note from Table IV¹⁸ that VIII and IX are spectrally distinguishable in methylene chloride but not in nitrobenzene.

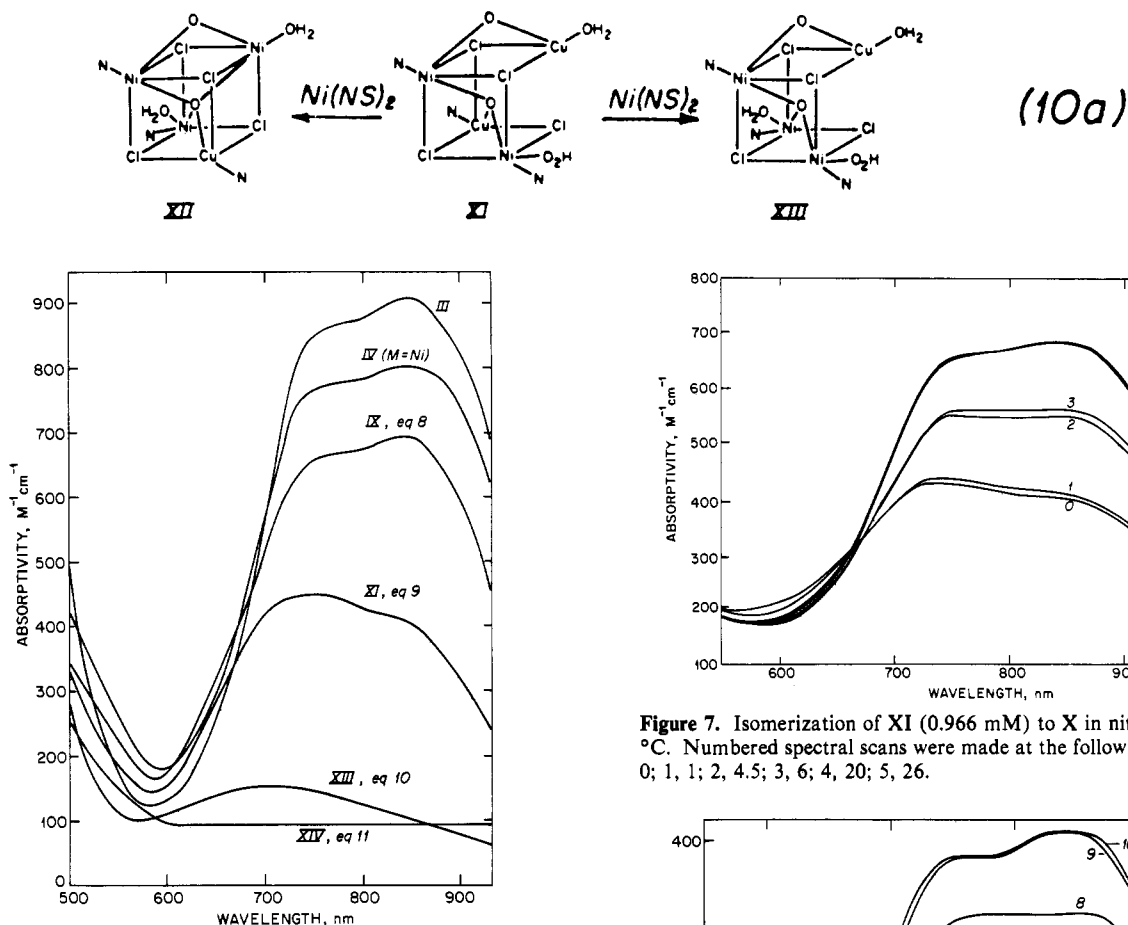

Figure 6. Electronic spectra for III, IV ($M = \text{Ni}$), and the products of eq 8–11 in nitrobenzene at 25 °C.

Selective transmetalation at one of the X sites of IX indicates reluctance of the $\text{NNi}_2(\mu\text{-O})\text{-Cu}_Y(\text{OH}_2)$ unit of IX to be transmetalated by $\text{Ni}(\text{NS})_2$, exactly as found for the $(\text{H}_2\text{O})\text{-Ni}(\mu\text{-O})\text{-CuN}$ unit of VII.^{6,7} If complex X were the product of eq 9 we would expect it to lose CuO in reaction 10,^{8,9} which is not observed.

Product of Eq 10. Selective transmetalation of XI by $\text{Ni}(\text{NS})_2$ at its Y or X sites gives alternative products XII and XIII, respectively (eq 10a). Transmetalation at Y to give XII is discounted from calculated $\epsilon = x + x' + y' + z' = 361$ and $408 \text{ M}^{-1} \text{ cm}^{-1}$ in methylene chloride and nitrobenzene, respectively, which are far greater than those observed (Figures 5 and 6). In addition, transmetalation at Y to give XII would cause loss of CuO (eq 6), which is not observed, and would obviate the trans effect, which prevents Y transmetalation at earlier stages. The product of reaction 10 is thus XIII: $\epsilon = 2x' + y + z' = 72$ and $120 \text{ M}^{-1} \text{ cm}^{-1}$ calculated from Table III are in good agreement with the measured spectra (Figures 5 and 6, respectively).

Product of Eq 11. The Y site of III is the last to be transmetalated by $\text{Ni}(\text{NS})_2$ and gives XIV: $\epsilon = 2x' + y' + z' = 61$ and $114 \text{ M}^{-1} \text{ cm}^{-1}$ in methylene chloride and nitrobenzene agree quite well with those values for the green, tetranuclear product XIV. This last stage of transmetalation is very much slower (30 h for completion)²¹ than the first three (6 h maximum) and probably proceeds via XII, which is rapidly transmetalated by $\text{Ni}(\text{NS})_2$ (see below).

Isomerization of Transmetalated Products. Complexes VIII, IX, X, XI, and XII, XIII are pseudoisomeric pairs²² that are spectrally distinguishable. We next observed the electronic and EPR spectra

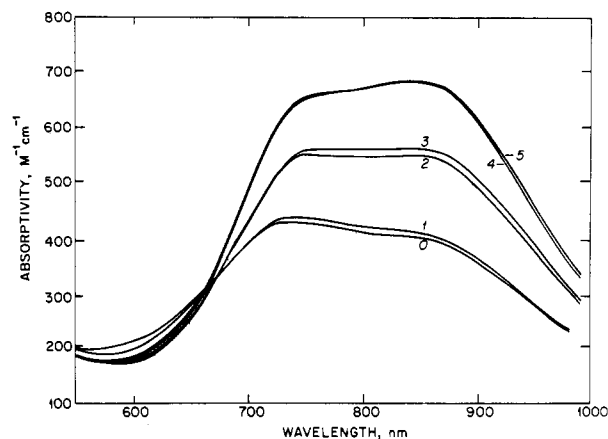

Figure 7. Isomerization of XI (0.966 mM) to X in nitrobenzene at 61 °C. Numbered spectral scans were made at the following times (h): 0, 0; 1, 1; 2, 4.5; 3, 6; 4, 20; 5, 26.

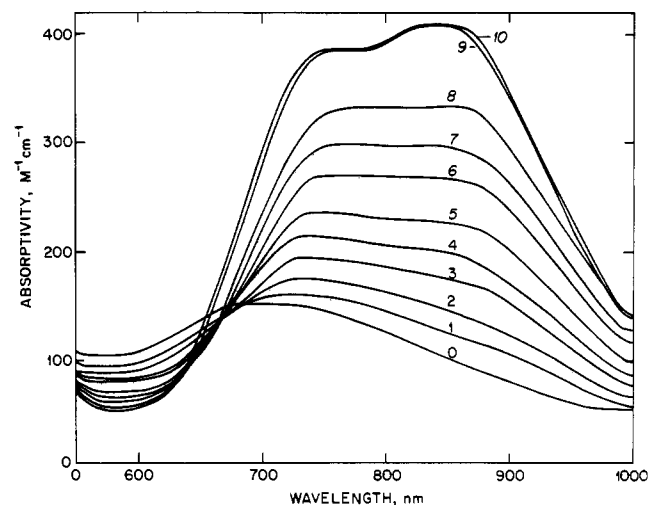

Figure 8. Isomerization of XIII (1.75 mM) to XII in nitrobenzene at 50.0 °C. Numbered spectral scans were made at the following times (min): 0, 0; 1, 24; 2, 35; 3, 55; 4, 75; 5, 105; 6, 275; 7, 350; 8, 500; 9, 1140; 10, 1540.

of IV ($M = \text{Ni}$), IX, XI, and XIII in nitrobenzene at room temperature over long time periods to see, for example, if IX isomerizes to VIII.

No Isomerization of IV ($M = \text{Ni}$) or IX. The spectra of IV ($M = \text{Ni}$) and IX were invariant in nitrobenzene at room temperature for at least 5 days. Copper evidently prefers X sites in complexes IV and IX, consistent with selective monotransmetalation of III at site Z. Substantial barriers evidently separate complexes IV, VIII, and IX.

Isomerization of XI to X. The electronic spectrum of brown XI slowly changes to that of dark brown X (Chart II: $\epsilon = 2x + y' + z' = 703 \text{ M}^{-1} \text{ cm}^{-1}$ for complex X from Table III) in nitrobenzene (Figure 7). Now fixed isobestics are always observed in isomerization of VII to VI (see, e.g., ref 6, Figure 5) because no changes of ligand type occur for Ni or Cu.^{6,7} Isomerization of XI to X that requires substitution of N for H_2O on copper is presumably responsible for nonisobestic behavior (690–630 nm) in Figure 7. The driving force for isomerization

(21) The slow transmetalation of XIII is indicated by high Cu and low Ni content in products isolated for reaction times shorter than 30 h.

(22) Pairs VIII, IX, etc., are not true isomers because they contain different numbers of aquo ligands (Table II).

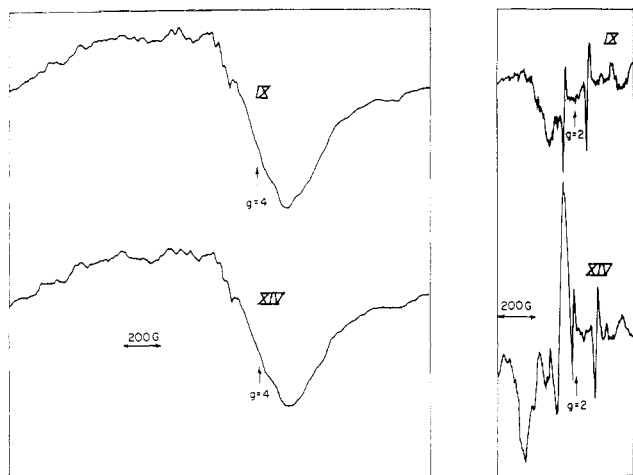

Figure 9. EPR spectra that are typical of products IX–XIV (1.0 mM) in methylene chloride at 25 °C. The spectra in the $g = 4$ region were obtained with instrument sensitivity = 4×10^3 and scan time = 4 min; those in the $g = 2$ region were obtained with instrument sensitivity 2×10^4 and scan time = 16 min.

is the preference for Cu at site X (see above). Isomerization of VII to VI also is spontaneous and irreversible, but the driving force there is formation of the especially stable $\text{NCu}(\mu\text{O})\text{CuN}$ unit of VI.^{6,7}

Note that isomerization of XI to XV (Chart II) is predicted from Table III to give $\epsilon = 162 \text{ M}^{-1} \text{ cm}^{-1}$ in methylene chloride and hence a substantial decrease in absorbance at 850 nm, which is not observed. It would also put Ni at site X and is not expected (see above).

Isomerization of XIII to XII. The electronic spectrum of green XIII slowly changes to that of brown XII ($\epsilon = x + x' + y' + z' = 408 \text{ M}^{-1} \text{ cm}^{-1}$ from Table III) in nitrobenzene (Figure 8). The spectrum of XII is not very solvent-dependent (Table IV).¹⁸ Nonisobestic behavior is ascribed to changes of ligands on copper (see above). The driving force is again the preference for copper at site X. We observed that transmetalation of XII with 1 mol of $\text{Ni}(\text{NS})_2$ is considerably faster than that of XIII, which agrees with Y as the most slowly transmetalated site.²¹

Note that isomerization of XIII to XVI (Chart II) would give much smaller absorption increases than are observed, would give solvent-dependent spectra (Table IV),¹⁸ and would not agree with the observed preference for Cu at X in III, IV, IX, and X. Structure XVI seems primed for CuO loss via the analogue of eq 6 (see below).

EPR Spectra of Products IX–XIV. The room-temperature EPR spectra of the title products are exemplified by Figure 9.

Comparison of Figures 4 and 9 reveals the dramatic effect of replacing copper with nickel at site Z. The spectra in Figure 9 are broad, isotropic signals centered at $g = 4$ and show little, if any, activity at $g = 2$, which indicates that they are not due to copper. There is little variation of signal strength with occupancy of the other sites by nickel or copper, which confirms that copper or nickel at site Z is responsible for room-temperature EPR activity of III, IV, and IX–XIV. EPR spectroscopy cannot be used to monitor isomerization because nickel remains at site Z.

Kinetics of Isomerization. We have measured the kinetics of the observed isomerization reactions for comparison with those for VII \rightarrow VI (Table V).^{6,7}

Plots of $\ln(A_\infty - A_t)$ versus time, where A_t is the absorbance at 850 nm at time t , were linear for at least 4 half-lives (Figure 10), showing that isomerization is first order in each system. The first-order rate constants, k_{obsd} , at fixed temperature were independent of the initial reactant concentration, consistent with the fact that each reactant is an unassociated tetramer in nitrobenzene (Table II).²³ Plots of $\ln k_{\text{obsd}}$ vs. $1/T$ were linear in the tem-

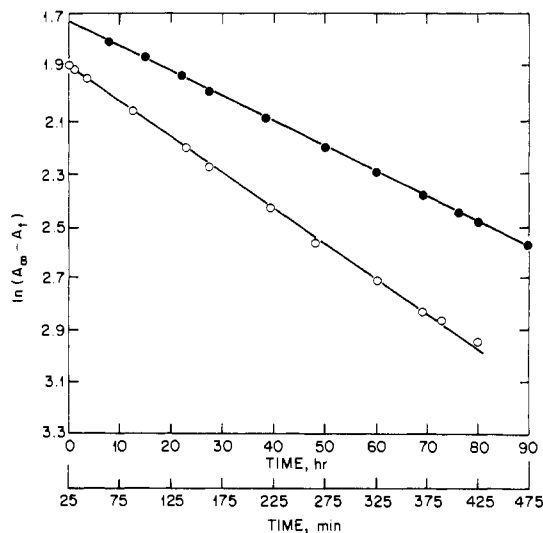

Figure 10. First-order plots of $\ln(A_\infty - A_t)$ vs. time at 850 nm for isomerization of IX in methylene chloride at 15.0 °C (O) and XIII in nitrobenzene at 26.0 °C (lower time scale) (●).

Table V. Kinetic Parameters for Isomerization of VII, XI, and XIII in Aprotic Solvents

complex	solvent	$10^6 k_{\text{obsd}}^a$	ΔH^\ddagger^b	$-\Delta S^\ddagger^c$
VII	CH_2Cl_2	8.1 ^d	5.1	63
XI		6.1	8.1	57
XIII		20.2	6.4	58
VII	PhNO_2	11.0 ^d	3.9	59
XI		10.1	4.8	66
XIII		24	4.8	63
			av 4.6 ± 0.5^e	av 61 ± 3^f

^aUnits are s^{-1} at 30 °C. ^bUnits are kcal mol^{-1} ; typical precision = $\pm 0.5 \text{ kcal mol}^{-1}$. ^cUnits are $\text{cal deg}^{-1} \text{ mol}^{-1}$ at 25 °C; typical precision = $\pm 3 \text{ cal deg}^{-1} \text{ mol}^{-1}$. ^dData from ref 7. ^eAverage excludes 2nd and 3rd column entries (see text); average error quoted. ^fAverage includes all column entries; average error quoted.

perature range 9.0–59.0 °C and gave the respective activation parameters in Table V.

Comparison of Kinetic Data. Striking features of the kinetic data for isomerizations of VII, XI, and XIII in methylene chloride and nitrobenzene (Table V) are (1) essentially solvent-independent rate constants at 30 °C in each system; (2) nearly constant and very negative entropies of activation, ΔS^\ddagger , and (3) activation enthalpies, ΔH^\ddagger , which are essentially constant except for isomerizations of XI and XIII in methylene chloride. These features suggest common requirements for isomerization.

Interpretation of the Kinetic Data. We base our interpretation of the kinetic data for isomerization on likely structures for the reactants.

It was concluded previously that polynuclear species that exhibit prominent, split maxima in the spectral region 730–870 nm contain copper sites with a minimum of three coordinated halo ligands per copper.^{7,12} The proposed structures for I–V (Chart I) satisfy this requirement for each copper site. Preferred representations of nickel-containing transmetalation products in Chart II and eq 8a–10a are based on the following considerations.

(1) Atomic absorptivity x (Table III) is solvent-independent and similar to the average atomic absorptivity of complex V ($\text{N} = \text{DENC}$), which is $400 \text{ L (mol of Cu)}^{-1} \text{ cm}^{-1}$ at 850 nm. Structure V is known to contain three μ -chloro ligands per copper(II) center.^{6,11}

(2) We associate high atomic absorptivities for copper with coordination of DENC, three halides, and μ_4 -oxo, the latter because the average atomic absorptivity $180 \text{ L (mol of Cu)}^{-1} \text{ cm}^{-1}$ in II and VI, which contain no μ_4 -oxo groups, is only ca. 55% of x (Table III) at 850 nm.⁶

(3) The electronic spectra of VII and XIII have single maxima at 700 nm with very low absorptivities and no spectral features

(23) VI and VII characteristically associate in aprotic solvents, which causes k_{obsd} for isomerization of VII to increase with $[\text{VII}]_0$.^{6,7}

at longer wavelength. This strongly suggests that the copper centers in these molecules are bonded to less than three chloro ligands.

(4) Thus, very low y in complexes IX, XI, and XIII is attributed to copper(II) coordinated by two chloro ligands, μ -oxo, and H_2O . The absence of DENC at site Y is supported by $z > y$ and $R_x < R_y$ (Table III).

Spectral evidence for weak copper-chlorine bonds at site Y is only apparent in complexes VII, IX, XI, and XIII, all of which contain a $Ni(\mu-O, Cl, Cl)Cu$ "dimer" unit in the top face. Loosening of this top unit from the core of each molecule would give ground-state entropies $S_{VII} > S_{IX}$ and S_{XI} , $S_{XIII} > S_{III}$. A requirement for formation of copper-chlorine bonds in the activation process for isomerization to give structures more like II and III would lead to a decrease in entropy: as anticipated, ΔS^\ddagger (Table V) is strikingly negative and similar in all systems. We much prefer this description of activation to the "polar-activated complex" hypothesis presented earlier.⁷

Isomerizations VII \rightarrow VI, XI \rightarrow X, and XIII \rightarrow XII all require breaking of a $Cu(\mu-O)$ bond. Four of the six ΔH^\ddagger values are essentially the same (Table V). The higher ΔH^\ddagger for isomerizations XI \rightarrow X and XIII \rightarrow XII in methylene chloride suggest a more significant, solvent-induced $Cu\gamma-(\mu_4-O)$ interaction in complexes XI and XIII, in line with higher absorptivity y in this solvent (Table III).

Conclusions. Molecular structures I-III (Chart I) are different and distinguishable. Introduction of nickel into complexes II (to give VII) and III (to give IX) apparently increases the entropy of $Cu(\mu-O, Cl, Cl)$ sites. This does not appear to be the case for $Cu(\mu_4-O, Cl, Cl, Cl)$ sites, which are thermodynamically preferred by copper. It is this preference that is probably responsible for disproportionation to complex V on attempted crystallization of complexes I-IV and any of their transmetalated derivatives containing copper.

Acknowledgment. This work was supported by Biomedical Research Support Grant RR07143 from the Department of Health and Human Services and Grant INT-8512210 from the

National Science Foundation, which are gratefully acknowledged. We wish to thank Professor William Orme-Johnson and co-workers for assistance with EPR measurements.

Appendix

From inspection of the spectra in Figures 5 and 6 we assume that the site of transmetalation of III by $Ni(NS)_2$ is Z, X, X, and Y in eq 8-11, respectively. If ϵ_{III} and ϵ_8 are the measured molar absorptivities at 850 nm of III and the tetranuclear product of eq 8 etc., then from the data in Figure 5 for methylene chloride we can write eq A1-A5. Thus, $z - z' = 90$, $x - x' = 260$ or 345

$$\epsilon_{III} = 2x + y + z = 770 \text{ M}^{-1} \text{ cm}^{-1} \quad (\text{A1})$$

$$\epsilon_8 = 2x + y + z' = 680 \text{ M}^{-1} \text{ cm}^{-1} \quad (\text{A2})$$

$$\epsilon_9 = x + x' + y + z' = 335 \text{ M}^{-1} \text{ cm}^{-1} \quad (\text{A3})$$

$$\epsilon_{10} = 2x' + y + z' = 75 \text{ M}^{-1} \text{ cm}^{-1} \quad (\text{A4})$$

$$\epsilon_{11} = 2x' + y' + z' = 64 \text{ M}^{-1} \text{ cm}^{-1} \quad (\text{A5})$$

(av 300 ± 40) and $y - y' = 11 \text{ L (mol of metal)}^{-1} \text{ cm}^{-1}$. We could then assume that $x' = y' = z' = \epsilon_{11}/4 = 16 \text{ L (mol of Ni)}^{-1} \text{ cm}^{-1}$. This gives $x = 316 \pm 40$, $y = 27$, and $z = 106 \text{ L (mol of metal)}^{-1} \text{ cm}^{-1}$. A better approximation is $x \gg x'$, $y \gg y'$ and $z \gg z'$, which gives $x = 325$, $y = 12$, $z = 100$, $x' = 25$, $y' = 1$ and $z' = 10 \text{ L (mol of metal)}^{-1} \text{ cm}^{-1}$, each with an average error of ca. $\pm 13\%$ arising from the alternative choices, 260 or 345 L (mol of metal)⁻¹ cm⁻¹, for $x - x'$. These average x' , y' , and z' values are different, as expected, and each is 8-10% of the corresponding value for copper, which supports the approximation. The same analysis for the data in Figure 6 gives $x - z'$ in nitrobenzene (Table III). A complete summary of observed and calculated molar absorptivities is given in Table IV.¹⁸

Supplementary Material Available: Table IV, observed and calculated molar absorptivities (ϵ , $M^{-1} \text{ cm}^{-1}$) of reactants and products at 850 nm in methylene chloride and nitrobenzene solution at 25 °C (1 page). Ordering information is given on any current masthead page.

Contribution from the Department of Chemistry, University of Saskatchewan, Saskatoon, Canada S7N 0W0, and Hahn-Meitner-Institut für Kernforschung Berlin GmbH, Bereich Strahlenchemie, D-1000 Berlin 39, Federal Republic of Germany

Pulsed-Laser Photochemical Study of Tris(1,10-phenanthroline)chromium(III) Ion in Acidic and Alkaline Aqueous Media

Jochen Lilie,^{1a} William L. Waltz,^{*1b} Sang H. Lee,^{1b} and Linda L. Gregor^{1b}

Received May 21, 1986

The photochemistry and photophysics of tris(1,10-phenanthroline)chromium(III) ion, $Cr(phen)_3^{3+}$, following pulsed-laser excitation at 347 nm, have been studied in deaerated acidic and alkaline aqueous media (pH 3.0-11.1) at room temperature by using conductivity and visible optical detection methods. The lifetimes of the lowest doublet excited state(s) from which is derived the major portion of the photochemistry are little affected by changes in pH as monitored by emission and excited-state absorption nor are the initial intensity levels of these phenomena noticeably altered by pH changes. Alterations in pH do have significant effects on the conductivity signals, which correlate to photoaquation. Conductivity studies for natural pH (ca. pH 7.1) provide evidence for a ground-state intermediate with a pK_a value around 7. In basic media, an apparent single stage of conductivity occurs, and the values of the observed rate constant and the resulting overall change in conductance are dependent upon the concentration of hydroxide ion. The quantum yield for aquation at the highest pH of 11.1 is determined as 0.08 ($\pm 20\%$). By contrast, photochemical reaction in acidic media is found to be very much reduced relative to that occurring in alkaline solutions. A mechanism, incorporating a six-coordinate, monodentate phenanthroline intermediate, is proposed, and it is used to discuss the occurrence of photoracemization and to compare the behavior of $Cr(phen)_3^{3+}$ to that previously reported for the congeneric system $Cr(bpy)_3^{3+}$, where bpy designates the 2,2'-bipyridine ligand.

Introduction

A number of studies have been presented recently pertaining to the photochemistry and photophysics of tris(2,2'-bipyridine)-chromium(III) ion, $Cr(bpy)_3^{3+}$, and tris(1,10-phenanthroline)-chromium(III), $Cr(phen)_3^{3+}$, as well as related complexes.²⁻²⁶ Such efforts have been engendered in part by the opportunities

afforded to investigate fundamental chemical and spectroscopic aspects for these materials, representing a broad class of sub-

- (1) (a) Hahn-Meitner-Institut. (b) University of Saskatchewan.
- (2) Jamieson, M. A.; Serpone, N.; Hoffman, M. Z. *Coord. Chem. Rev.* **1981**, *39*, 121.
- (3) Kirk, A. D. *Coord. Chem. Rev.* **1981**, *39*, 225.
- (4) Kemp, T. J. *Prog. React. Kinet.* **1980**, *10*, 301.
- (5) Bolletta, F.; Maestri, M.; Moggi, F.; Jamieson, M. A.; Serpone, N.; Henry, M. S.; Hoffman, M. Z. *Inorg. Chem.* **1983**, *22*, 2502.

* To whom correspondence should be addressed.