

Electrospray Ionization Mass Spectrometry of a Novel Family of Complexes in which Various Nitroso Compounds are Stabilized via Coordination to $[\text{IrCl}_5]^{2-}$

Natalia Escola,[†] Florencia Di Salvo,[†] Renato Haddad,[‡] Laura Perissinotti,[†] Marcos Nogueira Eberlin,^{*,‡} and Fabio Doctorovich^{*,†}

Departamento de Química Inorgánica, Analítica y Química Física/INQUIMAE-CONICET, Facultad de Ciencias Exactas y Naturales, Universidad de Buenos Aires, Ciudad Universitaria, Pabellón II, piso 3, C1428EHA Buenos Aires, Argentina, and ThoMSON Mass Spectrometry Laboratory, Institute of Chemistry, State University of Campinas, UNICAMP, CEP 13083-970, C.P. 6154, Campinas SP, Brazil

Received July 25, 2006

Electrospray ionization mass spectrometry (ESI-MS) and tandem mass spectrometry (ESI-MS/MS) data of a unique family of complexes of nitroso compounds coordinated to pentachloroiridate(III), $[\text{Cl}_5\text{IrN}(\text{O})\text{XR}]^{2-}$ ($\text{X} = \text{NH}, \text{S}, \text{CH}$ and $\text{R} = \text{alkyl, aryl}$) are presented. These novel complexes are obtained by nucleophilic attack of primary amines, thiols, and alkenes to the coordinated nitrosyl. Despite their lability and low volatility, MS analysis of complexes of the type $\text{MN}(\text{O})\text{X}$ was done for the first time, complementing other spectroscopic techniques. The intrinsic dissociation chemistry of the gaseous diagnostic ions was studied via ESI-MS/MS and found to be very useful to confirm the proposed connectivities of the parent complexes. In particular, ESI-MS of their solutions allows the detection of series of diagnostic ions, mainly, $[\text{M} - \text{Cl}]^-$, $[\text{M} + \text{K}]^-$, $[\text{M} - \text{NO}]^-$, and $[\text{M} - \text{Cl} + \text{AcN}]^-$ ($\text{AcN} = \text{acetonitrile}$), which confirmed the identity of the analyzed complexes to be $\text{M} = [\text{Cl}_5\text{IrN}(\text{O})\text{XR}]^{2-}$. Major fragments were formed by losses of NO or $\text{N}(\text{O})\text{XR}$. ESI-MS and ESI-MS/MS measurements are therefore shown to be the proper techniques to complement the spectroscopic characterization of this important class of nitroso complexes. An interesting rearrangement that does not take place in solution was observed in the gaseous phase, and a plausible mechanism is discussed.

Introduction

The nitrosyl group, when coordinated to potassium pentachloronitrosyliridate(III), $\text{K}[\text{IrCl}_5(\text{NO})]$, is probably the most electrophilic one known to date. This exceptional electrophilicity is reflected by the extremely high IR frequency of the NO ligand¹ and the corresponding electrochemical behavior of the complex.² The reactivity also reflects this high electrophilicity; when the nitrosyl group is attacked by nucleophiles such as amines, thiols, or alkenes, the family of (otherwise very reactive) nitroso compounds

stabilized via coordination to pentachloroiridate(III), $[\text{IrCl}_5]^{2-}$, are obtained as complexes with the general formula $[\text{Cl}_5\text{IrN}(\text{O})\text{XR}]^{2-}$ ($\text{X} = \text{NH}, \text{S}, \text{CH}$ and $\text{R} = \text{alkyl, aryl}$) (eq 1).

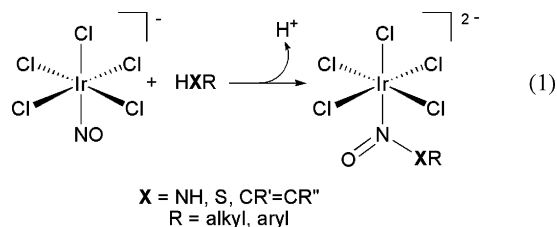

The high reactivity of $\text{K}[\text{IrCl}_5(\text{NO})]$ is useful for the preparation of a rich series of derivatives. For instance, when amines act as the nucleophiles ($\text{X} = \text{NH}$), the compound stabilized via coordination to the $[\text{IrCl}_5]^{2-}$ moiety is a primary N -nitrosamine. If thiols are used, the resulting ligand is a

* To whom correspondence should be addressed. E-mail: doctorovich@qi.fcen.uba.ar (F.D.); eberlin@iqm.unicamp.br (M.N.E.).

[†] Universidad de Buenos Aires.

[‡] State University of Campinas.

(1) KBr pellet: 2006 cm^{-1} , CH_3CN solution: 1953 cm^{-1} .

(2) $E_{1/2} = +0.96 \text{ V}$ vs Ag/AgCl in 1 M HClO_4 . Compare with $E_{1/2} = -0.33 \text{ V}$ vs ferrocene in butyronitrile. Sieger, M.; Sarkar, B.; Zališ, S.; Fiedler, J.; Escola, N.; Doctorovich, F.; Olabe, J.; Kaim, W. *J. Chem. Soc., Dalton Trans.* **2004**, 1797–1800.

S-nitrosothiol. When an alkene reacts with the nitrosyl complex, a *C*-nitroso ligand is obtained.

Primary *N*-nitrosamines (RN(H)N=O) and their tautomeric isomers, diazoic acids (RN=NOH), are important and elusive intermediates in the deamination of DNA bases,³ as well as in the formation of diazonium salts.⁴ In acidic or neutral medium, these compounds rapidly produce unstable diazonium salts by the loss of a hydroxide anion.⁵ Primary *N*-nitrosamines are unstable either as free species or coordinated to a metal; therefore, their complexes are rare.⁶ Taking advantage of the great nucleophilicity of NO in K[IrCl₅(NO)], our group has opened a unique route of preparation of aromatic and aliphatic coordinated nitrosamines,⁷ as the first examples of such compounds bonded to a metallic center through the NO moiety.

Because of their low stability, free *S*-nitrosothiols (RSNOs) attracted little attention in the past. But this changed drastically after the discovery of their key physiological role related to NO transport.⁸ Subsequently, biochemical aspects related to RSNOs have been widely studied. The coordination chemistry of RSNOs is of great importance because it may allow the stability and reactivity of biologically relevant RSNOs to be accessed. The coordinated RSNOs of general formula [M(X)₅N(O)SR]ⁿ⁻ (M= Ru, Fe, Os) are unstable and decompose spontaneously to produce metal complexes and disulfides, the lifetimes of these elusive species depending strongly on the thiol structure.⁹ Free thiols react however with [IrCl₅(NO)]⁻ to form the surprisingly stable coordinated *S*-nitrosothiol complexes K[Cl₅IrN(O)SR]. These are the first nitrosothiol complexes that have been isolated and fully characterized, including via structural analysis by X-ray crystallography.¹⁰

For *C*-nitroso compounds, a wide variety of synthetic routes have been regularly employed for more than a century,¹¹ in particular the reactions of olefins with different electrophiles. For instance, when nitrosyl chloride (NOCl) adds to dicyclopentadiene, the dimeric nitroso chloride is

formed,¹² when it adds to norbornene or norbornadiene, the only reaction product is the syn *exo* unrearranged isomer.¹³ In contrast, only a few reactions between coordinated nitrosyl and carbanions have been described to yield *C*-nitroso compounds.¹⁴ Therefore, the formation of *C*-nitroso compounds via the reaction of alkenes with [IrCl₅(NO)]⁻ is one of the few fully characterized examples of this kind of chemistry.¹⁵

In the past, mass spectrometry was not commonly included in the set of major techniques used for structural analysis in coordination and organometallic coordination chemistry.¹⁶ This limitation was mainly related to the thermal instability or low volatility of such compounds, which hampered their investigation by conventional MS techniques. But with the advent of electrospray ionization (ESI),¹⁷ this limitation has been overcome, and ESI-MS now provides one of the most convenient techniques¹⁸ to determine the composition, investigate the structures, and even measure the physicochemical properties of coordination complexes.¹⁹ More specifically, ESI-MS have been previously reported as a tool for the characterization of metal nitrosyls²⁰ and many other metal complexes, but there are few examples where iridium is the metal center.²¹

In this work, we report the ESI-MS and ESI-MS/MS investigation of a novel family of iridium complexes formed by nitroso ligands coordinated to [IrCl₅]²⁻. ESI-MS and ESI-MS/MS spectra have been used to firmly characterize these interesting complexes because they were found to be gently transferred from the solution to the gas phase. The MS measurements for a series of gaseous anions which are diagnostic of the parent complexes have provided accurate mass measurements and precise isotopologue distributions. The intrinsic dissociation chemistry of the gaseous ions were also accessed via ESI-MS/MS and found to be structurally

- (3) Caulfield, J.; Wishnok, J.; Tannenbaum, S. *J. Biol. Chem.* **1998**, *273*, 12689–12695.
- (4) (a) Mohrig, J. R.; Keegstra, K. *J. Am. Chem. Soc.* **1967**, *89*, 5492–5493. (b) Berner, D.; McGarrity, J. F. *J. Am. Chem. Soc.* **1979**, *101*, 3135–3136.
- (5) (a) Ho, J.; Fishbein, J. C. *J. Am. Chem. Soc.* **1994**, *116*, 6611–6621. (b) Finneman, J. I.; Fishbein, J. C. *J. Am. Chem. Soc.* **1996**, *118*, 7134–7138. (c) Finneman, J. I.; Ho, J.; Fishbein, J. C. *J. Am. Chem. Soc.* **1993**, *115*, 3016–3017.
- (6) (a) Schramm, K. D.; Ibers, J. A. *J. Am. Chem. Soc.* **1978**, *100*, 2932–2933. (b) Keefer, L. K.; Wang, S.; Anjo, T.; Fanning, J. C.; Day, C. S. *J. Am. Chem. Soc.* **1988**, *110*, 2800–2806. (c) Vaughan, G. A.; Chadwick, D. S.; Hillhouse, G. L. *J. Am. Chem. Soc.* **1989**, *111*, 5491–5493. (d) Lalor, F. J.; Desmond, T. J.; Ferguson, G.; Siew, P. Y. *J. Chem. Soc., Dalton Trans.* **1982**, *10*, 1981–1985.
- (7) Doctorovich, F.; Di Salvo, F.; Escola, N.; Trápani, C.; Shimon, L. *Organometallics* **2005**, *24*, 4707–4709.
- (8) (a) Stamler, J. S.; Jaraki, O.; Osborne, J.; Simon, D. I.; Keaney, J.; Vita, J.; Singel, D.; Valerie, C. R.; Loscalzo, J. *Proc. Natl. Acad. Sci.* **1992**, *89*, 7674–7677. (b) Jourdeuil, D.; Hallén, K.; Feilish, M.; Grisham, M. B. *Free Radical Biol. Med.* **2000**, *28*, 409–417.
- (9) (a) Szacilowski, K.; Wanat, A.; Barbieri, A.; Wasielewska, E.; Witko, M.; Stochel, G.; Stasicka, Z. *New J. Chem.* **2002**, *26*, 1495–1502. (b) Roncaroli, F.; Olabe, J. A. *Inorg. Chem.* **2005**, *44*, 4719–4727.
- (10) Perissinotti, L. L.; Estrin, D.; Leitus, G.; Doctorovich, F. *J. Am. Chem. Soc.* **2006**, *128*, 2512–2513.
- (11) Gowenlock, B. G.; Richter-Addo, G. B. *Chem. Rev.* **2004**, *104*, 3315–3340.

- (12) (a) Kraemer, G.; Spilker, A. *Berichte* **1896**, *29*, 552. (b) Wilder, P., Jr.; Culberson, C. F.; Youngblood, G. T. *J. Am. Chem. Soc.* **1959**, *81*, 655–658.
- (13) Youngblood, G. T.; Trivette, C. D., Jr.; Wilder, P., Jr. *J. Org. Chem.* **1958**, *23*, 684–686.
- (14) Lee, J.; Chen, L.; West, A. H.; Richter-Addo, G. B. *Chem. Rev.* **2002**, *102*, 1019–1065.
- (15) Escola, N.; Llebaria, A.; Doctorovich, F.; Leitus, G. *Organometallics* **2006**, *25*, 3799–3801.
- (16) Crabtree, R. H. *The Organometallic Chemistry of the Transition Metal*, 3rd ed.; Wiley-Interscience: New York, 2001; Chapter 10, p 259.
- (17) Fenn, J. B.; Mann, M.; Meng, C. K.; Wong, S. F.; Whitehouse, C. M. *Science* **1989**, *246*, 64–71.
- (18) (a) Colton, R.; D'Agostino, A.; Traeger, J. C. *Mass Spectrom. Rev.* **1995**, *14*, 79–106. (b) Traeger, J. C. *Int. J. Mass Spectrom.* **2000**, *200*, 387–401.
- (19) (a) Eberlin, M. N.; Tomazela, D. M.; Araki, K.; Alexiou, D. D. P.; Formiga, A. L. B.; Toma, H. E.; Nikolaou, S. *Organometallics* **2006**, *25*, 3245–3250. (b) Mayer, I.; Eberlin, M. N.; Tomazela, D. M.; Toma, H. E.; Araki, K. *J. Braz. Chem. Soc.* **2005**, *16*, 418–425. (c) Henderson, W.; Evans, C. *Inorg. Chim. Acta.* **1999**, *294*, 183–192. (d) Toma, H. E.; Alexiou, A. D. P.; Formiga, A. L. B.; Nakamura, M.; Dovidauskas, S.; Eberlin, M. N.; Tomazela, D. M. *Inorg. Chim. Acta.* **2005**, *358*, 2891–2899.
- (20) Shepherd, R. E.; Slocik, J. M.; Stringfield, T. W.; Somayajula, K. V.; Amoscato, A. A. *Inorg. Chim. Acta.* **2004**, *357*, 965–979 and references therein
- (21) (a) Matthew Polson, M.; Ravaglia, M.; Fracasso, S.; Garavelli, M.; Scandola, F. *Inorg. Chem.* **2005**, *44*, 1282–1289. (b) Carano, M.; Cicogna, F.; Houben, J. L.; Ingrosso, G.; Marchetti, F.; Mottier, L.; Paolucci, F.; Pinzino, C.; Roffia, S. *Inorg. Chem.* **2002**, *41*, 3396–3409.

Table 1. Major and Diagnostic Ions Detected by ESI-MS and ESI-MS/MS in the Negative Ion Mode for the Complexes Bearing Primary *N*-Nitrosamines Bonded to $[\text{IrCl}_5]^{2-}$ ^a

<i>N</i> -nitrosamines		
R	exptl (calcd, error in ppm) values for MS diagnostic ions <i>m/z</i>	MS/MS relevant fragments <i>m/z</i>
$-\text{CH}_2\text{CF}_3$	$[\text{M} + \text{K}]^-$: 536.789 (536.7877, 3) $[\text{M} - \text{Cl}]^-$: 462.853 (462.98561, 16)	from 536, $[\text{M} - \text{N}(\text{O})\text{NHR} + \text{K}]^- = 410.999$ from 460, $[\text{M} - \text{N}_2]^- = 433.998$; $[\text{IrCl}_4]^- = 332.934$
$-(\text{CH}_2)_3\text{CH}_3$	$[\text{M} + \text{K}]^-$: 510.834 (510.8473, 19) $[\text{M} + \text{RNH}_3]^-$: 545.972 (545.9805, 16)	from 510, $[\text{M} - \text{N}(\text{O})\text{NHR} + \text{K}]^- = 410.999$; $[\text{M} - \text{NO} + \text{K}]^- = 480.160$; $[\text{IrCl}_5 + \text{K}]^- = 408.8930$; $[\text{IrCl}_4]^- = 332.934$
-9-octyladenyl ($-\text{C}_{13}\text{H}_{19}\text{N}_4$)	$[\text{M} - \text{Cl} - \text{H}]^-$: 610.0399 (609.9975, 40) $[\text{M} - \text{Cl} + \text{H}_2\text{O}]^-$: 629.034 (629.0158, 3)	from 610, $[\text{M} - \text{Cl} - \text{H} - \text{N}_2]^- = 582.080$; $[\text{M} - \text{Cl} - \text{R} - \text{OH}]^- = [\text{IrCl}_4\text{N}_2]^- = 362.838$ from 629, $[\text{M} - \text{Cl} + \text{H}_2\text{O} - \text{NO}]^- = 599.063$; $[\text{M} - \text{Cl} + \text{H}_2\text{O} - \text{N}(\text{O})\text{NHR}]^- = 351.838$
$-p\text{-toluidyl}$ ($-\text{C}_7\text{H}_8$)	$[\text{M} + \text{K}]^-$: 544.834 (544.8313, 5) $[\text{M} - \text{OH}]^-$: 488.860 (488.8652, 5)	from 545, $[\text{M} - \text{N}(\text{O})\text{NHR} + \text{K}]^- = 410.999$; $[\text{M} - \text{HCl} + \text{K}]^- = 509.202$; $[\text{IrCl}_4]^- = 332.934$
$-p\text{-pyridyl}$ ($-\text{C}_5\text{H}_4\text{N}$)	$[\text{M} + \text{K}]^-$: 531.810 (531.8112, 10) $[\text{M} - \text{HCl} + \text{RNH}_3]^-$: 549.930 (549.9345, 19)	from 550, $[\text{M} - \text{N}(\text{O})\text{NHR} + \text{K}]^- = 410.999$; $[\text{IrCl}_4]^- = 332.934$; $[\text{M} - \text{HCl} - \text{NO} + \text{RNH}_3]^- = 520.091$

^a In all cases, $\text{M} = [\text{Cl}_5\text{IrN}(\text{O})\text{NHR}]^{2-}$, and the counterions are K^+ and RNH_3^+ ; the corresponding R is indicated in the table.

elucidative and coherent with the proposed connectivities for these complexes. To our knowledge, this is the first time that MS spectra of compounds of the type $\text{M}-\text{N}(\text{O})\text{X}$ (M is any transition metal) are reported.

Results

General Observations. The ESI-MS in the negative ion mode for solutions of the complexes have been acquired under mild conditions to obtain the structural and compositional information on the anions $[\text{Cl}_5\text{IrN}(\text{O})\text{XR}]^{2-}$ ($\text{X} = \text{NH}$, S , CH and $\text{R} =$ alkyl, aryl). ESI-MS/MS of the all relevant diagnostic ions was also performed to confirm the identity of the organic ligands and the proposed structures and to permit comparison along the subfamilies.

For most complexes, $[\text{IrCl}_5(\text{NO})]^-$ (m/z 399.800) and other anions related to it, such as $[\text{IrCl}_4]^-$ (m/z 332.850), $[\text{IrCl}_5 + \text{H}]^-$ (m/z 367.809), and $[\text{IrCl}_5 + \text{K}]^-$ (m/z 410.990), have been observed as major ions (Table S1). Considering the stability of the +3 oxidation state in iridium, we assume that the metal remained unaltered as Ir(III).²

Within the whole family, that is, for $\text{M} = [\text{Cl}_5\text{IrN}(\text{O})\text{XR}]^{2-}$, the major diagnostic anions (those that confirm the identity of these complexes) are $[\text{M} - \text{Cl}]^-$, $[\text{M} - \text{Cl} - \text{NO}]^-$, and $[\text{M} + \text{K}]^-$. The $[\text{M} - \text{Cl} + \text{AcN}]^-$ ion, formed by coordination of the acetonitrile solvent (AcN), was also observed for the *C*-nitroso ligand. It is important to note that the observation of this ion is consistent with the fact that the X-ray structure¹⁵ of this complex shows an AcN coordinated to the position trans to the nitroso moiety. The coordination of AcN is caused by the labilization of the corresponding chloride, which is replaced by AcN when the reaction occurs in this solvent. In many cases, AcN was also found to be one of the most convenient solvents for ESI-MS.

The isotopical distribution analysis of these ions was very important for the correct assignment of the tetrachloro and pentachloro anions. For instance, the pattern shown by IrCl_4^- is remarkably different from the one corresponding to IrCl_5^- (Figure 1).

Nitrosamines. We have prepared a range of nitrosamines $[\text{Cl}_5\text{IrN}(\text{O})\text{NHR}]^{2-}$ that includes aliphatic ($\text{R} = -\text{CH}_2\text{CF}_3$

and $-(\text{CH}_2)_3\text{CH}_3$), aromatic ($\text{R} = p\text{-toluidyl}$ and $p\text{-pyridyl}$), and pseudoaromatic ($\text{R} = 9\text{-octyladenyl}$) members. After the corresponding amine reacts with the nitrosyl complex in dry acetonitrile, the solid product is isolated from the media as K^+ and RNH_3^+ (ammonium) salts. These compounds were previously analyzed by several spectroscopic techniques, and two of them were also crystallized ($\text{R} = p\text{-toluidyl}$ and $-\text{CH}_2\text{CF}_3$).⁷ All of them are very soluble in water, dimethyl formamide (DMF), and dimethyl sulfoxide (DMSO) and are barely soluble in AcN. Normally, water is not a good solvent for such complexes because of the low stability of some nitrosamines in aqueous solutions. The solvent chosen for ESI-MS was therefore a 1:1 mixture of AcN and DMSO. The ESI-MS spectra in the negative ion mode were acquired using mild conditions: mainly, needle voltage of 2800 V and cone voltage of 25 V. The ESI-MS/MS spectra were acquired with collision energy set at 15 eV, and argon was used as the collision gas.

In most cases, the major ion detected was $[\text{IrCl}_4]^-$. The $[\text{M} + \text{K}]^-$, $[\text{M} - \text{Cl}]^-$, and $[\text{M} + \text{RNH}_3]^-$ were the main diagnostic anions detected by ESI-MS. The $[\text{M} - \text{OH}]^-$ ion (corresponding to the coordinated diazonium ion $[\text{Cl}_5\text{Ir}(\text{N} \equiv \text{N}-\text{R})]^-$) has also been detected for a few complexes with reasonable abundance, and for some cases, it could be observed the loss of HCl. All of these ions are diagnostic for the complexes because they conserve the unaltered organic ligand bonded to the $[\text{IrCl}_n]^{3-n}$ moiety. Generally, the counterion present in the detected ions was K^+ , but in the case of the *p*-aminopyridil derivative, protonated amine was observed (detected ion = $[\text{M} - \text{HCl} + \text{RNH}_3]^-$).

The ESI-MS/MS of $[\text{M} + \text{K}]^-$ shows two major losses which are also structurally elucidative, that is, loss of the organic nitrosyl ligand that forms $[\text{M} - \text{N}(\text{O})\text{NHR} + \text{K}]^-$ (m/z 410.999) and $[\text{M} - \text{N}(\text{O})\text{NHR} - \text{Cl}]^-$ (m/z 332.850); the loss of NO that forms $[\text{M} - \text{NO} + \text{K}]^-$ could be observed only in a few cases.

When ESI-MS/MS spectra were acquired for $[\text{M} - \text{Cl}]^-$, the loss of organic ligands was also observed, leading to $[\text{IrCl}_4]^-$ of m/z 332. Note that, in general, the deviations between the values for the calculated and observed m/z values are less than 10 ppm. These accurate mass measurements

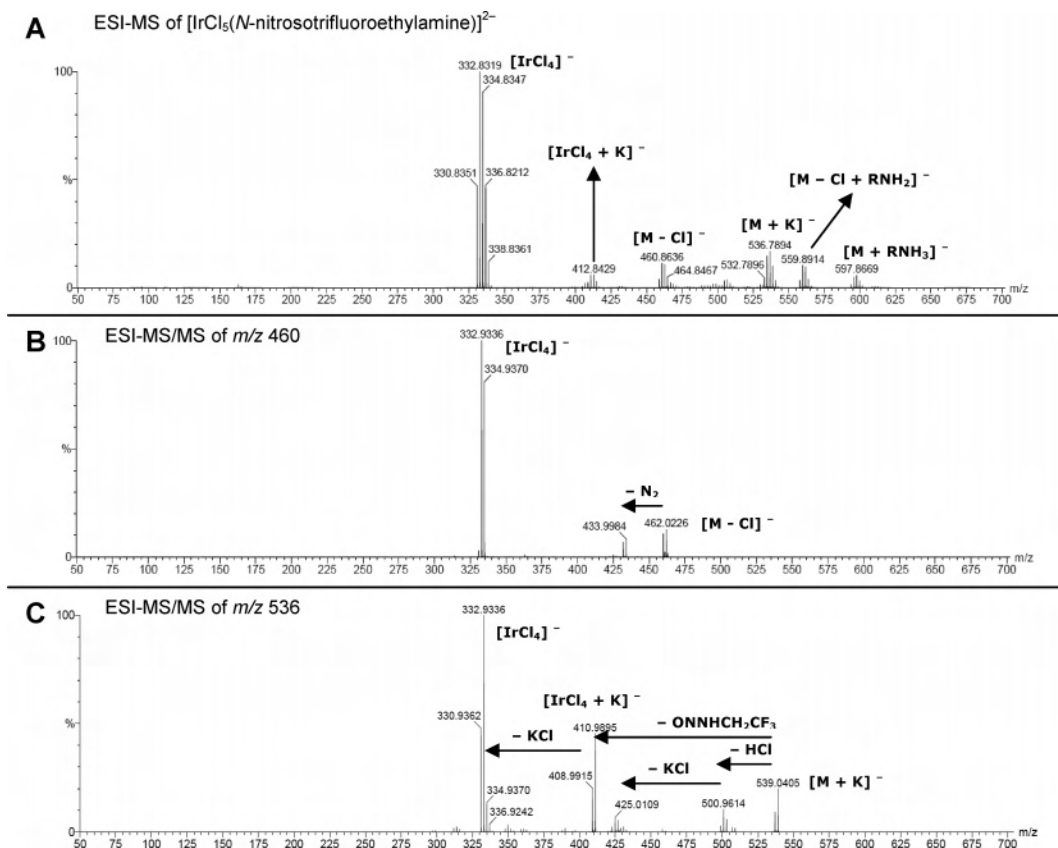

Figure 1. ESI-MS and ESI-MS/MS in the negative ion mode for $\text{K}(\text{CF}_3\text{CH}_2\text{NH}_3)[\text{Cl}_5\text{IrN}(\text{O})\text{NHCH}_2\text{CF}_3]$ in an acetonitrile/DMSO solution.

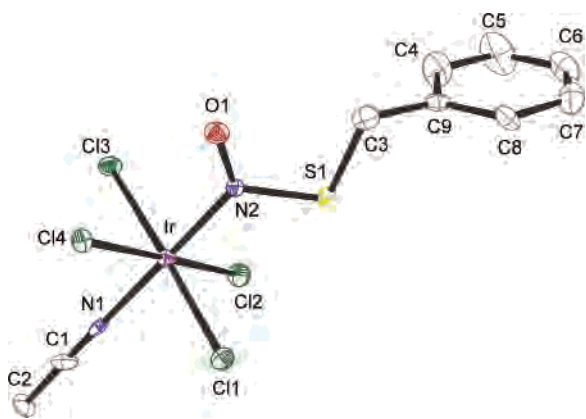

Figure 2. X-ray crystal structure and atom numbering for $[\text{Cl}_4(\text{CH}_3\text{CN})\text{IrN}(\text{O})\text{Sbenzyl}]^{2-}$.¹⁰ Thermal ellipsoids are drawn at the 50% level.

and precise distributions of isotopologue ions firmly confirm the identity of the molecular species (see SI for a comparison between calculated and experimental distributions).

Consequently, we concluded that all the *N*-nitrosamines show similar ESI-MS and ESI-MS/MS behavior with analogous primary diagnostic ions and that they also display a consistent set of analogous fragment ions (Table 1). Finally, as an example, in Figure 1 the ESI-MS and ESI-MS/MS for $\text{K}(\text{CF}_3\text{CH}_2\text{NH}_3)[\text{Cl}_5\text{IrN}(\text{O})\text{NHCH}_2\text{CF}_3]$ are shown.

Nitrosothiols. We have also prepared two complexes with coordinated *S*-nitrosothiols, with general formula $[\text{Cl}_5\text{IrN}(\text{O})\text{SR}]^{2-}$, for which $\text{R} = \text{phenyl, benzyl}$. The compound of formula $[\text{Cl}_4(\text{CH}_3\text{CN})\text{IrN}(\text{O})\text{Sbenzyl}]^{2-}$ (where the *trans* chloride ion was replaced by a molecule of solvent) could be crystallized,

Scheme 1. Formation of *trans*- $[\text{Cl}_4\text{Ir}(\text{CH}_3\text{CN})(\text{syn-1-chloro-2-nitroso-1,2-dihydrodicyclopentadiene})]^-$ by Nucleophilic Attack of Dicyclopentadiene to $[\text{IrCl}_5(\text{NO})]^-$ ^a

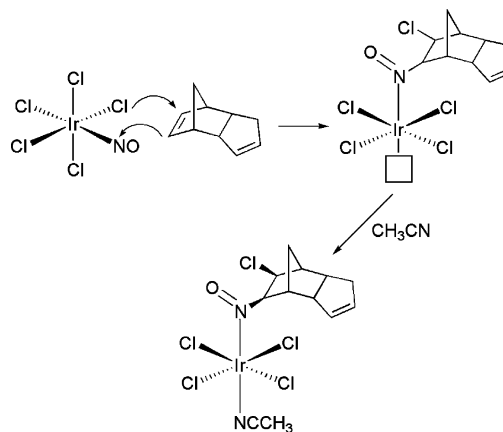

^a For details see ref 15.

and its structure was determined by X-ray crystallography (Figure 2). The two nitrosothiol complexes were prepared in dry AcN, and the isolated salts have K^+ and H^+ as counterions for $\text{R} = \text{phenyl}$ and benzyl .

Like the other compounds described here, coordinated RSNOs are soluble in water, DMSO, and DMF. The solvent mixture chosen as the most appropriate for the ESI-MS experiments was a 1:1 mixture of AcN and DMSO. ESI-MS and ESI-MS/MS spectra were collected using needle voltage of 2500 V and a cone voltage of voltage 25 V, and the collision energy was 15 eV for CID using argon as the collision gas.

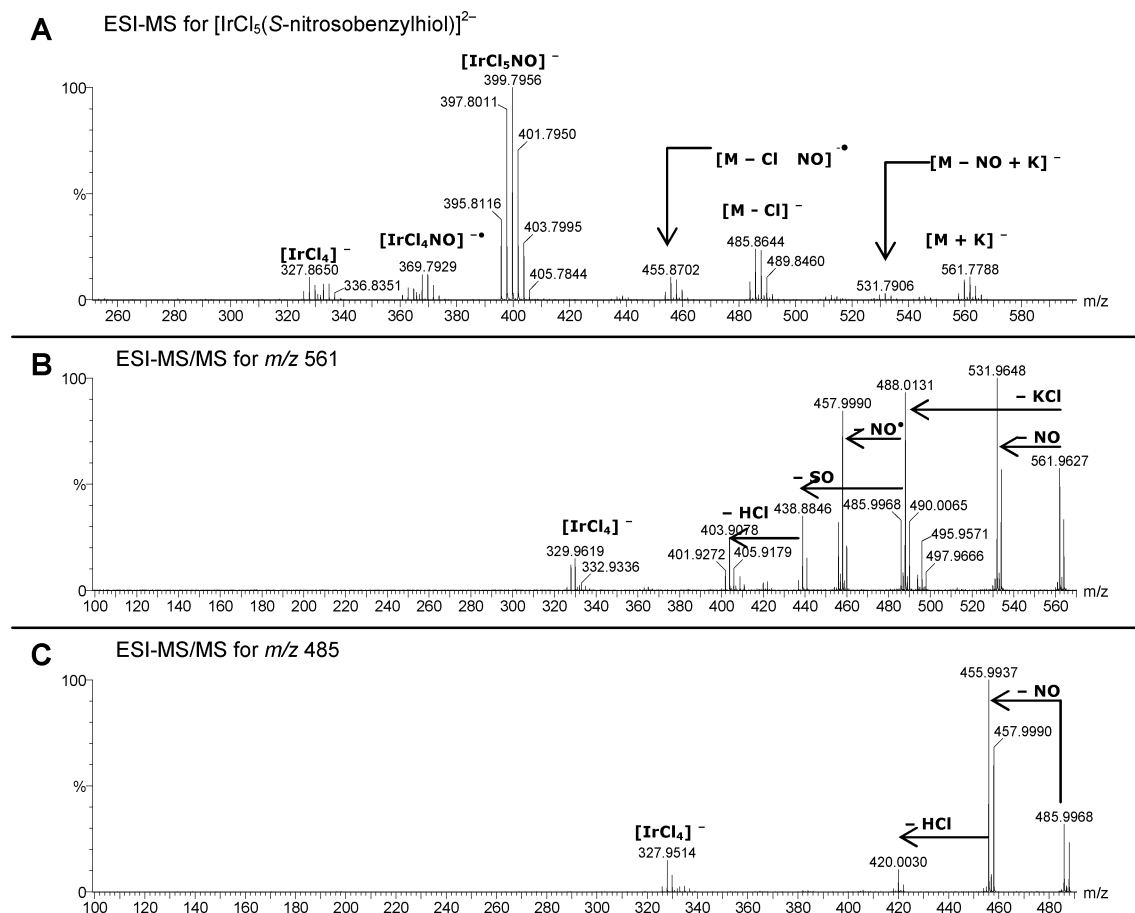

Figure 3. ESI-MS and ESI-MS/MS in the negative ion mode for $\text{KH}[\text{Cl}_5\text{IrN}(\text{O})\text{Sbenzyl}]$ in an acetonitrile/DMSO solution.

Table 2. Major and Diagnostic Ions Detected by ESI-MS and ESI-MS/MS in the Negative Ion Mode for the Complexes in which *S*-Nitrosothiol Ligands are Coordinated to $[\text{IrCl}_5]^{2-}$ ^a

R	S-nitrosothiols	
	exptl (calcd, error in ppm) values for MS diagnostic ions m/z	MS/MS major fragments, m/z
-CH ₂ Ph	$[\text{M} + \text{K}]^-$: 561.779 (561.7789, 1) $[\text{M} - \text{Cl}]^-$: 487.227 (487.2239, 4)	from $[\text{M} - \text{Cl}]^-$, $[\text{M} - \text{NO} - \text{Cl}]^- \bullet$ = 457.994 from $[\text{M} + \text{K}]^-$, $[\text{M} - \text{Cl}]^-$ = 488.013; $[\text{M} - \text{NO} + \text{K}]^- \bullet$ = 531.965; $[\text{M} - \text{KCl} - \text{NO}]^- \bullet$ = 458.000
-Ph	$[\text{M} - \text{NO} - \text{Cl}]^- \bullet$: 457.2210 (457.2178, 7) $[\text{M} + \text{K}]^-$: 547.750 (547.7438, 11) $[\text{M} - \text{Cl} + \text{K}]^- \bullet$: 512.297 (512.2908, 12) $[\text{M} - \text{Cl}]^-$: 473.183 (473.1888, 12) $[\text{M} - 2\text{Cl} + \text{H}]^-$: 438.76 (438.7438, 37)	from $[\text{M} - \text{Cl}]^-$ and $[\text{M} - 2\text{Cl} + \text{H}]^-$, $[\text{M} - 2\text{Cl} - \text{NO}]^- \bullet$ = 408.00 from $[\text{M} - \text{Cl} + \text{K}]^- \bullet$, $[\text{M} - 2\text{Cl} + \text{H}]^-$ = 438.76

^a In all cases, $\text{M} = [\text{Cl}_5\text{IrN}(\text{O})\text{SR}]^{2-}$, and the counterions are K^+ and H^+ ; the corresponding R is indicated in the table.

For the $[\text{Cl}_5\text{IrN}(\text{O})\text{SR}]^{2-}$ complexes, the major detected ion was $[\text{IrCl}_5(\text{NO})]^-$ (m/z 399.800), for which R = phenyl an benzyl. The main diagnostic anions detected by ESI-MS were $[\text{M} + \text{K}]^-$, $[\text{M} - \text{Cl}]^-$, $[\text{M} - \text{NO} - \text{Cl}]^- \bullet$, and $[\text{M} - 2\text{Cl} + \text{H}]^-$ (see Figure 3). The complexes with coordinated RSNOs provide clean ESI-MS nearly free of fragment ions. The ESI-MS/MS of these $[\text{Cl}_5\text{IrN}(\text{O})\text{SR}]^{2-}$ complexes show loss of NO, Cl, and combinations with AcN. Figure 3 shows, as an example, the ESI-MS and ESI-MS/MS for $[\text{Cl}_5\text{IrN}(\text{O})\text{Sbenzyl}]^{2-}$. Table 2 shows the summarized results.

C-Nitrosoalkanes. When dicyclopentadiene was added to an acetonitrile solution of $\text{K}[\text{IrCl}_5(\text{NO})]$ at room temperature, we observed immediate formation of the complex with the C-nitroso ligand which precipitated as a green salt (Scheme

1).¹⁵ This potassium salt was therefore subjected to ESI-MS. Major conditions were a needle voltage of 3000 V a cone voltage of 40 V, and a collision energy of 10 eV for CID with argon as a collision gas.

The high-resolution and high-accuracy ESI-MS shows a major anion corresponding to the $[\text{IrCl}_4]^-$ ion of m/z 332.850, and the main diagnostic molecular anion of m/z 531.89 free of the coordinating acetonitrile, that is, $[\text{M} - \text{CH}_3\text{CN}]^-$ with formula $\text{C}_{10}\text{H}_{12}\text{Cl}_5\text{IrNO}$ (four chlorides are coordinated to iridium, and the fifth chloride is bonded to a carbon atom). Another major ion observed with appreciable abundance was that of m/z 506.940 in which AcN has not been lost and that corresponds to $[\text{M} - \text{HCl} - \text{NO}]^- \bullet$, with formula $\text{C}_{12}\text{H}_{14}\text{Cl}_4\text{IrN}$. The ESI-MS/MS of $[\text{M} - \text{CH}_3\text{CN}]^-$ shows loss of the organic moiety that leads to $[\text{IrCl}_5(\text{NO})]^-$ (m/z 399.93)

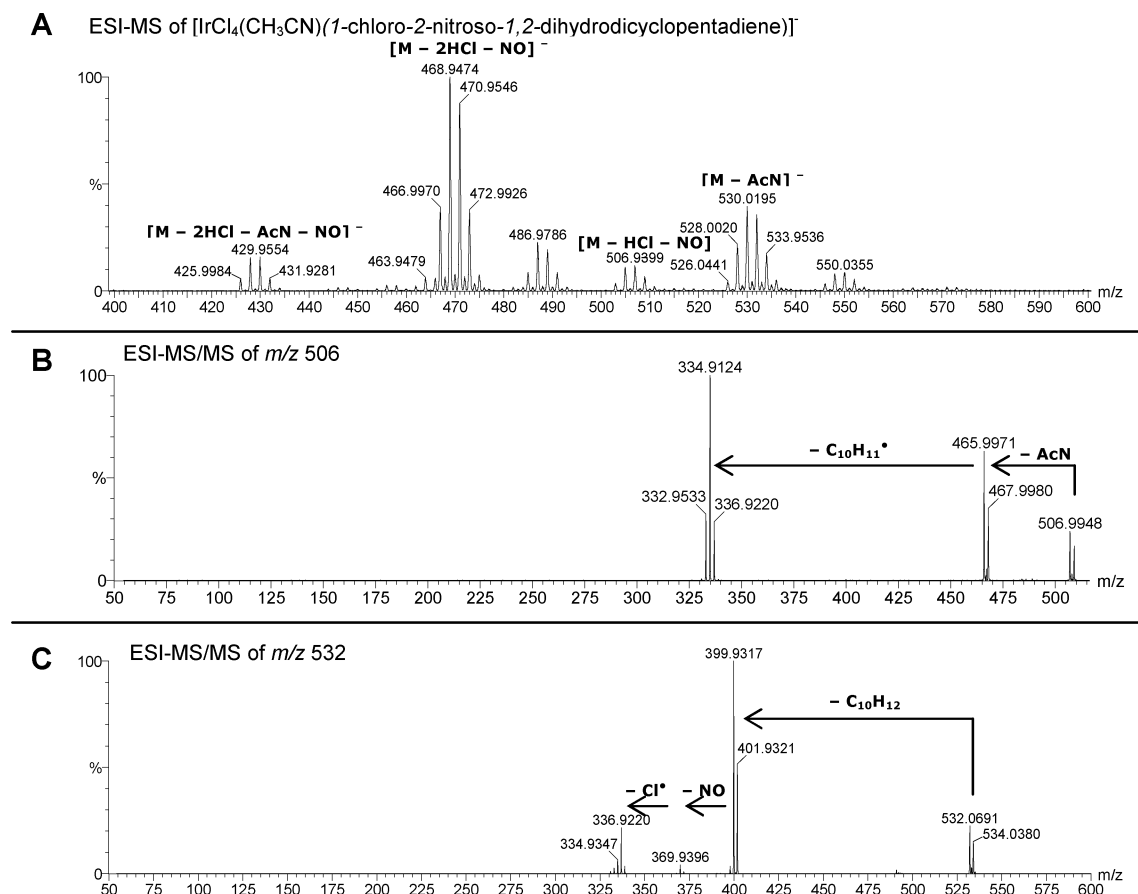

Figure 4. ESI-MS and ESI-MS/MS in the negative ion mode for *trans*- $\text{K}[\text{Cl}_4\text{Ir}(\text{CH}_3\text{CN})(\text{syn-1-chloro-2-nitroso-1,2-dihydrocyclopentadiene})]$ in an acetonitrile solution.

Table 3. Major and Diagnostic Ions Detected by ESI-MS and ESI-MS/MS in the Negative Ion Mode for *trans*- $\text{K}[\text{Cl}_4\text{Ir}(\text{CH}_3\text{CN})(\text{syn-1-chloro-2-nitroso-1,2-dihydrocyclopentadiene})]^-$ ^a

C-nitroso compound		
R	exptl (calcd, error in ppm) values for MS diagnostic ions m/z	MS/MS major fragments, m/z
$-\text{C}_{10}\text{H}_{12}\text{Cl}$	$[\text{M} - \text{AcN}]^-$: 531.896 (531.8961, 1) $[\text{M} - \text{HCl} - \text{NO}]^-$: 506.940 (506.9480, 17) $[\text{M} - 2\text{HCl} - \text{NO}]^-$: 468.947 (468.9470, 40) $[\text{M} - 2\text{HCl} - \text{AcN} - \text{NO}]^-$: 427.962 (427.9477, 33)	from $[\text{M} - \text{AcN}]^-$, $[\text{M} - \text{AcN} - \text{C}_{10}\text{H}_{12}]^- = [\text{IrCl}_5\text{NO}]^- = 399.932$ from $[\text{M} - \text{HCl} - \text{NO}]^-$, $[\text{M} - \text{HCl} - \text{NO} - \text{AcN}]^- = 468.995$; $[\text{M} - \text{HCl} - \text{NO} - \text{AcN} - \text{C}_{10}\text{H}_{11}]^- = 334.912$

^a $\text{M} = [\text{Cl}_4\text{Ir}(\text{AcN})\text{N}(\text{O})\text{R}]^-$ and the counterion is K^+

by cleavage of the C–N bond (Figure 4). In the ESI-MS/MS of the $[\text{M} - \text{HCl} - \text{NO}]^-$, the major fragment of m/z 468.95 corresponds to the loss of AcN, that is, $[\text{M} - 2\text{HCl} - \text{NO} - \text{AcN}]^-$. These results are summarized in Table 3.

Discussion

Using ESI-MS, we have been able to characterize in detail a family of complexes of general formula $[\text{Cl}_5\text{IrN}(\text{O})\text{XR}]^{2-}$ in which novel nitroso compounds are stabilized via coordination to pentachloroiridate(III). In most cases, the molecular ion was detected directly through the $[\text{M} - \text{Cl}]^-$ and $[\text{M} + \text{K}]^-$ ions. Other significant ions that implicated losses of neutral molecules could be explained on the basis of the organic ligand nature or by expected rearrangements that could take place around the metal center. The intrinsic dissociation chemistry of the gaseous complexes were also accessed via ESI-MS/MS and found to be structurally

elucidative and coherent with the proposed connectivities in the parent complexes.

It is important to remark that we have not only been able to characterize this family of compounds but also increased our understanding of different aspects linking this family of complexes when X is S, CH, or NH through the ESI-MS technique. As previously depicted, it could be observed that when X contains a nitrogen atom the major ions detected were $[\text{IrCl}_4]^-$, $[\text{IrCl}_5 + \text{K}]^-/[\text{IrCl}_5 + \text{H}]^-$ (originated by loss of the intact -N(O)XR fragment), or both, while when X is a sulfur atom the major ion detected was $[\text{IrCl}_5(\text{NO})]^-$. In the case where X is a carbon atom, an intermediate situation arises in which, although the major ion detected was $[\text{IrCl}_4]^-$, $[\text{IrCl}_5(\text{NO})]^-$ could also be observed (see complete spectra in SI). This is reflected by the N1–X and Ir–N1 distances depicted in Table 4. In this table, it can be seen that the N1–N bond distances for the coordinated nitrosamines are

Table 4. Relevant X-ray Crystallographic Data for $[\text{Cl}_4(\text{L})\text{Ir}(\text{O})\text{XR}]^{2-}$ Complexes, Where $\text{L} = \text{Cl}^-$ or CH_3CN

distances (Å)	nitrosamines			C-nitroso compound ^d
	toluidine ^a	trifluoroethylamine ^b	nitrosothiol ^c	
$d(\text{N1}-\text{X})$	1.309	1.323	1.738	1.494
$d(\text{N1}-\text{O1})$	1.225	1.139	1.218	1.216
$d(\text{X}-\text{C1})$	1.455	1.466	1.815	1.387, 1.390
$d(\text{N1}-\text{Ir})$	1.992	2.020	1.959	1.948
$d(\text{X}-\text{Ir})$	2.832	2.851	3.180	3.011

^a X-ray crystallographic data for $(\text{PPh}_4)_2[\text{Cl}_5\text{Ir}(\text{N-nitroso-2,2,2-trifluoroethylamine})]$, ref 7. ^b X-ray crystallographic data for $(\text{PPh}_4)_2[\text{Cl}_5\text{Ir}(\text{N-nitroso-}p\text{-toluidyne})]$, ref 7. ^c X-ray crystallographic data for $\text{PPh}_4[\text{Cl}_4(\text{CH}_3\text{CN})\text{Ir}(\text{S-nitrosobenzylthiol})]$, ref 10. ^d X-ray crystallographic data for *trans*- $\text{K}[\text{Cl}_4\text{Ir}(\text{CH}_3\text{CN})(\text{syn-1-chloro-2-nitroso-1,2-dihydrodicyclopentadiene})]$, ref 15.

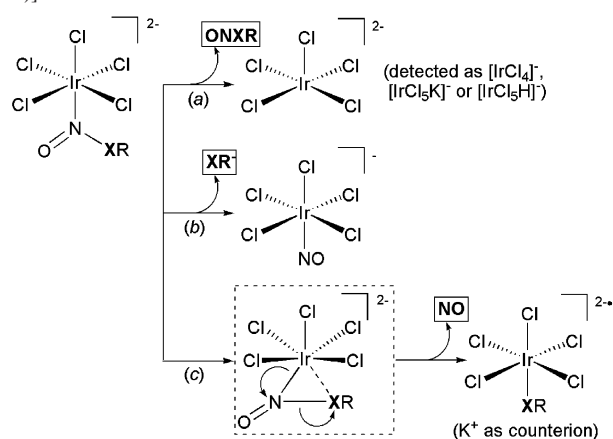
Scheme 2. Relevant Fragments Originated from $[\text{Cl}_5\text{Ir}(\text{O}=\text{N}-\text{XR})]^{2-}$ ^a

^a Pathway a was mostly observed for *N*-nitrosamine and *C*-nitroso compounds, while pathways b and c are more frequent for *S*-nitrosothiols.

0.4 and 0.2 Å shorter than the $\text{N1}-\text{S}$ and $\text{N1}-\text{C}$ bond distances observed for the nitrosothiols and nitroso compounds, respectively. Therefore, the $\text{N1}-\text{N}$ bond in the nitrosamines is expected to be stronger than the $\text{N1}-\text{S}$ and $\text{N1}-\text{C}$ bonds of the nitrosothiols and nitroso compounds. The $\text{N1}-\text{Ir}$ bond is longer (and therefore weaker) in the nitrosamine complexes (see $\text{N1}-\text{Ir}$ distances in Table 4). Taking these two facts together, we expect the rupture of the relatively weak $\text{N1}-\text{X}$ bond to be the preferred pathway for the thiol and carbon complexes, while breakage of the weak $\text{N1}-\text{Ir}$ bond is the expected pathway in the case of the amine complexes, as observed experimentally (see Scheme 2 a and b).

The lower relative stability of the *N*-nitrosamine complexes with respect to the *S*-nitrosothiol ones could also be observed when the ESI-MS/MS spectra for the $[\text{M} - \text{Cl}]^-$ ions shown in Figures 1B and 3C are compared. For the former, the major ion detected is again $[\text{IrCl}_4]^-$, while for the other compounds, this ion is a minor one. Consequently, species that originate from loss of Cl^- (mainly IrCl_4^-) are more stable in the gas phase for the thiols than for the amines.

The loss of NO was also detected by ESI-MS and ESI-MS/MS, mostly for the thiols and the *C*-nitrosoalkane derivative. The $[\text{M} - \text{NO} + \text{K}]^- \cdot$ ion, which results from loss of NO , could be rationalized in terms of a three-centered rearrangement which favors loss of a neutral NO molecule

(Scheme 2c). This proclivity to lose NO during the gentle ESI-MS conditions could again be associated to the relative intrinsic stability of the $\text{N1}-\text{X}$ and $\text{N}-\text{Ir}$ bonds for the gaseous ions for each subfamily, together with the stability of the $\text{X}-\text{Ir}$ bond which is formed. As was said before, this could be related to the significant difference shown in the X-ray data for the $\text{N1}-\text{X}$ distances (Table 4).

An interesting observation results from the inspection of the spectrum in the case of the *C*-nitrosoalkane complex. In the MS/MS spectra for the $[\text{M} - \text{AcN}]^-$ ion, it can be observed that the major ion is $[\text{IrCl}_5(\text{NO})]^-$. This is surprising when the X-ray structure of the complex, which has four chloride ions coordinated to iridium and the fifth chloride covalently bonded to a carbon atom, is taken into account. The formation of $[\text{IrCl}_5(\text{NO})]^-$ implies that in the gas phase the first reaction shown in Scheme 1 is reversed leading to the reactants ($[\text{IrCl}_5\text{NO}]^-$ and dicyclopentadiene), which then originate other ions from loss of NO and Cl^- .

Another point worthy of note is the loss of an HCl molecule; this could be observed mainly for the amine complexes but also for the *C*-nitrosoalkane derivative. In the case of the amine complexes, it could be easily explained by the presence of a hydrogen bond between the very acidic nitrosamine proton²² and one of the chlorides. Then, the negative charge on the organic ligand is strongly stabilized by delocalization to form a diazoate derivative ($\text{R}-\text{N}^--\text{NO} \leftrightarrow \text{R}-\text{N}=\text{N}-\text{O}^-$) (eq 2).

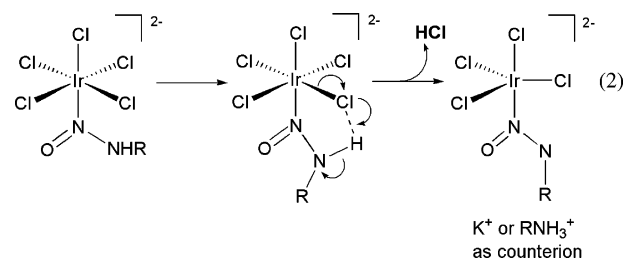

Finally, through this study using the ESI-MS technique, we showed that all these interesting complexes have been gently transferred from the solution to the gas phase, and the MS measurements for the intact gaseous anions, as well as closely related diagnostic ions, have provided accurate mass measurement and precise isotopologue distributions (see SI). In this regard, it is important to emphasize that this powerful technique allowed us to gain further insight into the chemical behavior in the gas phase of the subfamilies of complexes and to perform a detailed characterization and comparison that was done for the first time and may be useful in future studies. Moreover, interesting chemistry, such as the reverse of the electrophilic addition shown in Scheme 1, was observed in the gaseous phase for this type of complexes for the first time.

Experimental Section

Materials. All the *N*-nitrosamines complexes were prepared as described in ref 7, where the synthesis of $[\text{Cl}_5\text{Ir}(\text{N-nitroso-}p\text{-toluidyne})]^{2-}$ and $[\text{Cl}_5\text{Ir}(\text{N-nitroso-2,2,2-trifluoroethylamine})]^{2-}$, with

(22) ¹H NMR: ~15 ppm.

the corresponding ammonium and potassium counterions, is described. Benzylamine and 4-aminopyridine were purchased from Aldrich; *n*-butylamine was purchased from Riedel-de Haën and was used as received. 9-Octyladenine was synthesized from adenine and *n*-octylbromide.²³

S-Nitrosothiol complexes were prepared as described in ref 10, where the synthesis and complete spectroscopic characterization of *trans*-[(CH₃CN)Cl₄Ir(*S*-nitrosobenzylthiol)]K is included. Phenylthiol was purchased from Aldrich and used as received.

trans-[Cl₄Ir(CH₃CN)(*syn*-1-chloro-2-nitroso-1,2-dihydro-dicyclopentadiene)]⁻ was obtained as described in ref 15, where the synthesis and complete spectroscopic characterization is included.

Mass spectrometry measurements were done by dissolution of the pure solids in dry acetonitrile or DMSO at room temperature under inert atmosphere. Under these conditions, all the studied compounds are stable for long periods (hours or days) as observed by ¹H NMR. The solutions were transferred to the instrument using a microsyringe.

Instrumentation. All fragmentations of the *N*-nitrosamine and the nitrosothiol complexes were performed under exactly the same conditions. Mass spectrometric measurements were performed using a high-resolution hybrid quadrupole (Q) and orthogonal time-of-flight (TOF) mass spectrometer (QToF from Micromass, U.K.)

operating in the negative ion electrospray ionization mode set from 2100 to 3500 V. Samples dissolved in appropriate anhydrous solvents at room temperature (RT) under an inert atmosphere were injected through an uncoated fused-silica capillary, using a syringe pump (Harvard Apparatus, Pump 11, 15 μL min⁻¹). The temperature of the nebulizer and desolvation gas was set at 100 °C, and the cone voltage was set between 25 and 35 V. Tandem mass spectra (ESI-MS/MS) were acquired using the product ion scan mode via mass selection of the ion of interest, followed by collision-induced dissociation (CID) with Ar using energies varying from 15 to 35 eV with high-accuracy orthogonal TOF mass analysis of the CID ionic fragments. For comparison with experimental data, isotopic patterns were calculated using the MassLynx software.

Acknowledgment. This work was supported by the Agencia Nacional de Promoción Científica y Tecnológica (ANPCYT), Consejo Nacional de Investigaciones Científicas y Técnicas (CONICET), Universidad de Buenos Aires (UBA), Fundación Antorchas, São Paulo State Research Foundation (FAPESP), and Brazilian National Research Council (CNPq).

Supporting Information Available: MS spectra and some additional tables. This material is available free of charge via the Internet at <http://pubs.acs.org>.

(23) Bunton, C. A.; Wolfe, B. B. *J. Am. Chem. Soc.* **1974**, *96*, 515–522.

IC061388N