

# Mutual Solubility Measurements of Hydrocarbon–Water Systems Containing Benzene, Toluene, and 3-Methylpentane

Brian J. Neely, Jan Wagner, Robert L. Robinson, Jr., and Khaled A. M. Gasem\*

School of Chemical Engineering, Oklahoma State University, 423 Engineering North, Stillwater, Oklahoma 74078

Although abundant literature data are available on liquid–liquid phase equilibrium for select hydrocarbon–water systems at ambient or near ambient temperatures, a deficiency exists for data at elevated temperatures. In this study, we sought to (a) evaluate existing mutual hydrocarbon–water liquid–liquid equilibrium (LLE) data, (b) develop an experimental apparatus capable of measuring accurately the hydrocarbon–water (LLE) mutual solubilities, and (c) perform measurements on the benzene–water, toluene–water, and 3-methylpentane–water systems. A continuous flow apparatus was utilized to measure the LLE mutual solubilities at temperatures ranging from ambient to 500 K, which is near the three-phase critical end point of the benzene–water and toluene–water systems. The well-documented benzene–water system was used to validate the reliability of the sampling and analytical techniques employed. Generally, the present measurements showed adequate agreement with available literature data. An error propagation analysis for the three systems indicates maximum expected uncertainties of 4 % and 8 % in the water-phase and organic-phase solubility measurements, respectively. This study provides valuable LLE mutual solubility data and demonstrates the efficacy of the experimental apparatus in making accurate measurements.

## Introduction

Phase equilibrium data are essential for the proper design, operation, and simulation of many chemical processes, including distillation, absorption, and liquid–liquid extraction. An example application is the removal of environmentally harmful organic substances from wastewater streams in refineries and petrochemical plants. Here, both sour water strippers<sup>1</sup> and liquid–liquid extraction processes (based on the equilibration of hydrocarbon-rich and water-rich liquid streams) are used.<sup>2</sup> Increasing environmental concerns have also led to the use of supercritical water, instead of organics, as the solvent in some reaction processes and extraction methods. Examples are the destruction of hazardous wastes in supercritical water<sup>3</sup> and chemical processing in supercritical and near critical water.<sup>4</sup> Additionally, the development of environmental impact studies, such as the potential contamination of a body of water by a liquid hydrocarbon, is dependent on phase equilibrium data.

When experimental data are not available, thermodynamic models for liquid–liquid equilibrium (LLE) are used to predict the phase equilibrium. The accuracy of these models is dependent on the quality, as well as the quantity, of the experimental data used in the model development. While sufficient literature data exist on LLE for many hydrocarbon–water systems at ambient or near ambient temperatures, a deficiency exists for data at elevated temperatures.

The objectives of this work are to measure and correlate mutual hydrocarbon–water LLE data for the benzene–water, toluene–water, and 3-methylpentane–water systems over a temperature range from ambient conditions to approximately 500 K.

## Experimental Measurements

To address the need for LLE data on selected systems, a continuous flow apparatus,<sup>5</sup> originally described by Chen and Wagner<sup>6–8</sup> and later used by Ratzlaff,<sup>9</sup> was utilized to obtain liquid–liquid mutual solubilities at temperatures from ambient to 500 K and pressures up to 13.8 MPa. Mutual solubility data have been measured at temperatures from ambient to near the three-phase critical end points,<sup>10</sup> (540 and 560) K, for hydrocarbon–water systems including benzene–water and toluene–water, respectively. At temperatures and pressures below the three-phase critical end point, three phases (liquid hydrocarbon, liquid water, and vapor) exist, and at temperatures and pressures greater than this point, two phases consisting of a liquid water phase and a vapor phase exist. The well-documented system, benzene–water, was used to validate the operation of the apparatus, as well as the sampling and analytical techniques employed.

**Materials.** Benzene (99.9+ %) and toluene (99.8 %) were supplied by Aldrich Chemical Co., and the 3-methylpentane (99+ %) was supplied by Acros. Additional chemicals used as solvents in the phase analyses included 2,2,4-trimethylpentane (99+ %) and decane (99+ %) supplied by Aldrich Chemical Co. No further purification of these chemicals was attempted. Ethanol (USP grade, Absolute-200 Proof) supplied by Pharmco Products was dehydrated and stored over 4 Å molecular sieves from Fisher Chemical Company for at least two months prior to use. The Oklahoma State University School of Chemical Engineering supplied the nanopure, deionized water. High-purity helium (99.997 %) and ultrahigh-purity nitrogen (99.999 %) were obtained from Sooner Airgas, Inc.

Alltech screw top bottles (1 oz.) with open-hole caps and Teflon liners were used for sample collection. Hamilton 10 cm<sup>3</sup> syringes from Alltech were used for preparation of the calibration standards and were thoroughly rinsed between uses with acetone (99.7 %) from Pharmco Products. Hamilton 0.01 cm<sup>3</sup>

\* Corresponding author. Tel.: +1 405 744 5280. Fax: +1 405 744 6338. E-mail address: gasem@okstate.edu.

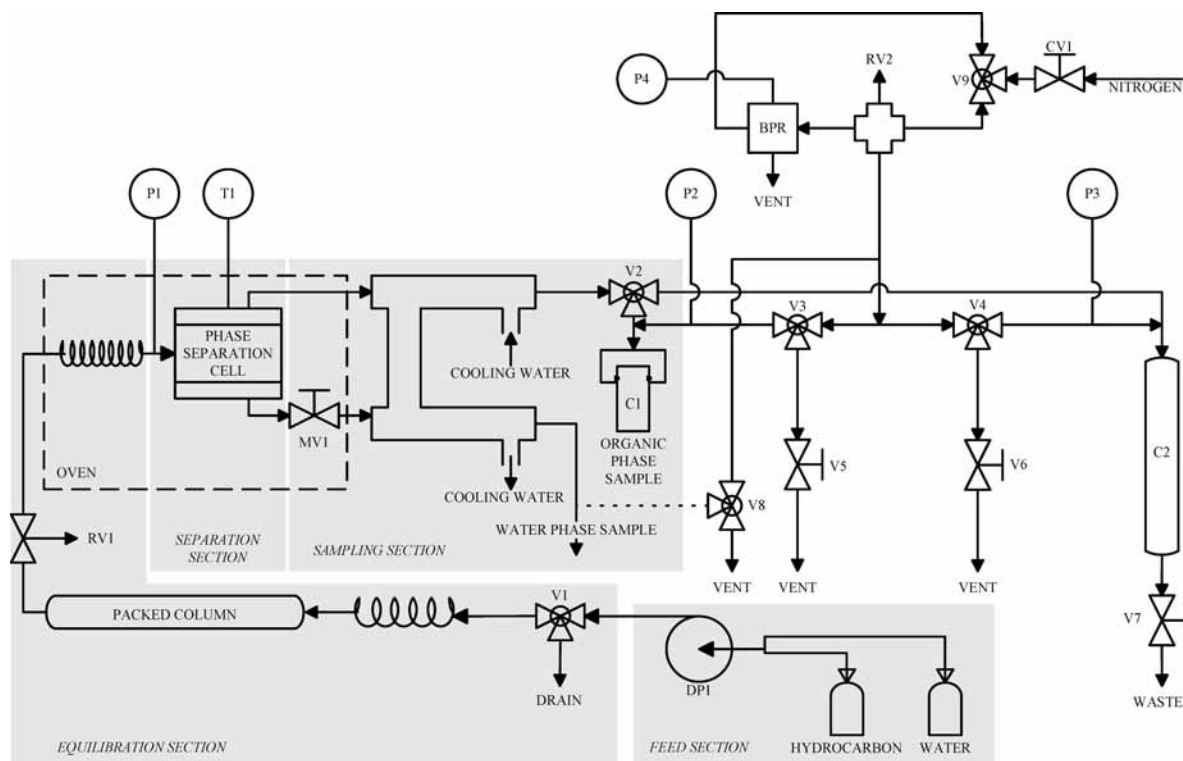

**Figure 1.** Schematic diagram of the continuous flow apparatus.

(10  $\mu\text{L}$ ) syringes from Alltech were used to inject the calibration standards and experimental samples into the gas chromatograph. Pharmco Products provided the ACS grade methanol (99.99 %), which was used in combination with acetone (99.7 %) to clean the apparatus and glassware.

**Apparatus.** A detailed diagram of the experimental apparatus is presented in Figure 1. The apparatus consists of four sections: a feed section, an equilibration section, a separation section, and a sampling section. In the feed section, two pure, partially miscible fluids are injected at constant flow rates to the equilibration section, where they are thoroughly mixed and allowed to equilibrate. After the equilibration section, the aqueous and hydrocarbon phases are separated in the separation section. Next, the separated phases are collected in the sampling section. The total volume of the apparatus is approximately 120  $\text{cm}^3$ . Abbreviations used in the description of the apparatus correspond to those given in Figure 1.

**Feed Section.** The feed section contains two reservoirs for the pure liquid feedstocks, a hydrocarbon and water, and a LCD Analytical type NSI-33R duplex miniPump (DPI), which has the capability for independent flow rate settings for the feedstock streams; however, this pump is represented by a general pump symbol in Figure 1. The duplex miniPump supplies the liquids at a constant total flow rate of  $4.0 \text{ cm}^3 \cdot \text{min}^{-1}$  with equal rates ( $2.0 \text{ cm}^3 \cdot \text{min}^{-1}$ ) of hydrocarbon and water. The flow rate was varied to determine the effect on the measured solubilities, but no significant effect was observed with flow rates ranging from (1.5 to 4.5)  $\text{cm}^3 \cdot \text{min}^{-1}$ . Flow rates in this range are sufficiently low to avoid the formation of emulsions in the apparatus and to allow sufficient time for the two liquids to reach equilibrium in the equilibration section. At the selected flow rate, the residence time of the system is approximately 30 min.

**Equilibration Section.** The equilibration section facilitates the mixing necessary for the fluids to reach equilibrium at the selected experimental temperature. Immediately following the duplex miniPump is a Whitey three-way valve (V1), which acts

as a bypass valve when the duplex miniPump is primed. The two fluids then pass through approximately 6.8 m of 3.18 mm o.d. stainless steel tubing followed by 3.1 m of 6.35 mm o.d. stainless steel tubing packed with 1.0 mm glass beads. Next, the liquid enters a 1.0 m section of 3.18 mm o.d. stainless steel tubing before entering the constant-temperature oven.

A Hotpack Digimatic model 213024 air oven with a maximum temperature rating of 623 K is utilized to provide a suitable thermal environment. The oven temperature is controllable to within  $\pm 0.1 \text{ K}$  of the set point, as determined by the manufacturer. A J-type thermocouple calibrated against a Minco platinum resistance thermometer that is NIST traceable is used to measure the phase separation cell temperature. Once the fluid reaches the oven, a 15.2 m section of 3.18 mm o.d. stainless steel tubing allows thermal equilibration of the thoroughly mixed hydrocarbon–water mixture before it enters the separation section.

**Separation Section.** The separation section consists of a phase separation cell, which is a 316 stainless steel Jerguson model 12T40 liquid level gage with an internal volume of 19  $\text{cm}^3$ , located inside the oven. Phase separation of the hydrocarbon–water mixture occurs inside the cell. The aqueous phase exits from the bottom of the cell, and the less dense hydrocarbon phase exits from the top of the cell. Because a potential exists for phase separation to occur in the aqueous and hydrocarbon phases due to adsorption of the solute on sample line surfaces,<sup>11</sup> the separated phases exit the phase separation cell through 1.59 mm o.d. stainless steel capillary tubing. This tubing minimizes dead volume, thus minimizing the effects of phase separation on sample composition.

**Sampling Section.** After exiting the phase separation cell, the aqueous phase passes through an Autoclave Engineering micrometering valve (MV1). The valve packing material limits the maximum operating temperature of the apparatus to 505 K. This valve, which is located inside the oven, controls the flow of the aqueous phase from the phase separation cell. By

adjusting the aqueous phase effluent rate, the hydrocarbon–water interface level is maintained near the center of the cell, which reduces the possibility of entrainment. Each phase passes through a water-cooled heat exchanger 0.23 m in length prior to being collected. Tap water is used on the shell side (6.35 mm o.d. stainless steel tubing) to cool each phase to room temperature before collection; this aids in the prevention of sample evaporation.

Because the presence of a vapor phase would interfere with the collection of the hydrocarbon phase from the top of the equilibrium cell, pressures above the three-phase pressure in the apparatus are established using pressurized nitrogen gas to create a backpressure on the system. A Grove Mity Mite S-91XW backpressure regulator (BPR) is used to control the pressure in the high-pressure sampling cell (C1). To protect against overpressure, a spring-loaded Nupro relief valve is placed at each possible source of pressure. One relief valve (RV1) is located on the liquid mixture feed line, upstream of the oven, and a second relief valve (RV2) is located on the nitrogen stream line.

The hydrocarbon phase sample is collected in a glass bottle placed in a 300 cm<sup>3</sup>, sightless, high-pressure sampling cell (C1), which is pressurized by nitrogen gas. Cell pressure is measured at the feed port of the phase separation cell with a Sensotec STJE pressure transducer and 450D readout. The maximum pressure of the system is limited by the pressure transducer, which has a pressure limit of 13.8 MPa (2000 psia). The relief valves are set at 12.4 MPa (1800 psia).

A Whitey three-way valve (V2) is located between the phase separation cell and C1. This valve diverts the flow of the hydrocarbon phase sample to a 400 cm<sup>3</sup>, sightless, high-pressure, collection cell (C2), which allows continuous flow through the system at elevated pressures while changing the sample bottles in C1. The blanket of nitrogen gas also pressurizes C2. The nitrogen gas may be vented when C1 and C2 are isolated from the system by sequencing of the Whitey three-way valves. The valve V3 is used to isolate C1, and the valve V4 is used to isolate C2. When isolated, C1 or C2 may be depressurized to atmospheric pressure while maintaining a constant elevated pressure inside the apparatus.

**Analytical Methods and Procedures.** The analyses of equilibrium phase samples proceeded as follows. First, a known amount of solvent, by weight, was added to the sample bottles. For the organic phase analysis, the sample was mixed with ethanol in approximate weight ratios of 0.7, 0.3, and 0.8 for the benzene–water, toluene–water, and 3-methylpentane–water systems, respectively. The ethanol functioned as a homogenizing cosolvent to provide a single-phase sample for analysis. (The ethanol contained a small amount of water, which was accounted for in the sample analysis.)

The water-phase sample was mixed with a known weight of decane for the benzene–water and 3-methylpentane–water systems; 2,2,4-trimethylpentane was used for the toluene–water system. To avoid interference with the gas chromatograph analysis of the hydrocarbons of interest, the retention time of the solvents was used as the basis for their selection. The solvent-to-sample weight ratio was 0.4 for the benzene–water system and 0.2 for the toluene–water and 3-methylpentane–water systems. The solvent was used in the water phase to extract the hydrocarbon from the water, thus providing a water-free (hydrocarbon + solvent) sample. More reproducible analyses were achieved by excluding water because aqueous solutions are difficult to analyze accurately by gas chromatography.

The samples were collected after addition of the solvent to the sample bottles to avoid reopening the sample bottles and thus minimizing sample contact with the atmosphere. At each temperature, samples of each phase, organic and water, were collected simultaneously at a pressure slightly above the three-phase equilibrium pressure. Three samples of each phase were collected for analysis at each experimental equilibrium condition.

Sample volumes of 0.003 cm<sup>3</sup> (3 μL) were analyzed using a Hewlett-Packard 5890A gas chromatograph (GC) equipped with a thermal conductivity detector (TCD) and a Hewlett-Packard 3396A integrator. The GC column used was a 3.6 m × 3.18 mm stainless steel packed GasChrom 254 supplied by Alltech, and high-purity helium was used as the carrier gas.

The GC was calibrated by one of two techniques. A serial dilution technique was utilized for the aqueous phase, and for the hydrocarbon phase, individually prepared external standards were employed. Calibration data were used to generate calibration curves, which represented the solute-to-solvent weight ratio as a function of the solute-to-solvent area ratio. The calibration data were regressed using a Marquardt nonlinear weighted least-squares method.<sup>12</sup> The weighting of each datum was based on propagation-of-error calculations. Each calibration curve was expressed empirically

$$WR_i = \alpha AR_i^\beta \quad (1)$$

where WR is the weight ratio; AR is the area ratio; and  $\alpha$  and  $\beta$  are regressed parameters. This expression was utilized in the sample analysis to determine the solute-to-solvent weight ratio. The following mass balance relation, expressed in terms of the solute-to-solvent weight ratio, WR, solvent-to-sample weight ratio, SSR, and the molecular weights of the solute, MW<sub>1</sub>, and solvent, MW<sub>2</sub>, was used to calculate the mole fraction of the solute in the sample:

$$x_1 = \frac{[(WR)(SSR)]/MW_1}{\{[(WR)(SSR)]/MW_1\} + \{1/MW_2\}} \quad (2)$$

A complete description of the apparatus and the operating procedures and techniques is given by Neely<sup>13</sup> (Chapters 3 and 4).

## Data Correlation and Evaluation

Correlations to describe the solubility of liquid hydrocarbons in water and the solubility of water in liquid hydrocarbons were developed from published solubility data and calorimetric data for enthalpy and specific heat of solution.

**Solubility of Hydrocarbons in Water.** Benson and Krause<sup>14</sup> and Wilhem et al.<sup>15</sup> have discussed the merits of different empirical equations for correlating the temperature dependence of solubility data. The following form, expressing the mole fraction of hydrocarbon as a function of temperature, was selected for hydrocarbon solubility in water

$$\ln x_{hc} = A + BT_{r,hc}^{-1} + CT_{r,hc}^{-2} \quad (3)$$

where  $x_{hc}$  is the hydrocarbon mole fraction and  $T_{r,hc}$  is the temperature (absolute) of the system divided by the critical temperature of the hydrocarbon, hc. The constants, A, B, and C in eq 3 were obtained by nonlinear regression, minimizing the weighted sum of squares (WSS) in the calculated solubilities. All our measured solubility data for the three systems of interest were included in the preliminary regressions; however, any data point with a weighted deviation greater than 2.5 times the standard deviation was removed and not included in the final regressions. Data not included in the regressions are marked

Table 1. Mutual Solubilities for Hydrocarbon–Water Systems

Benzene–Water System										
aqueous phase					organic phase					
T/K	P/MPa	$x_{\text{benzene}} \cdot 10^4$	estimated errors		T/K	P/MPa	$x_{\text{water}} \cdot 10^2$	estimated errors		
			absolute $\cdot 10^4$	%				absolute $\cdot 10^2$	%	
299.1	0.194	4.13	0.057	1.3	299.0	0.204	0.32	0.012	3.8	
324.3	0.139	4.68	0.034	0.73	324.3	0.139	0.64	0.020	3.2	
350.2	0.271	6.61	0.055	0.83	350.2	0.271	1.26	0.046	3.7	
376.2	0.443	10.0	0.010	1.0	376.2	0.443	2.17	0.067	3.1	
400.3	0.638	15.2	0.099	0.65	400.3	0.638	3.83	0.10	2.6	
431.4	1.944	27.2	1.1	4.0	431.4	1.944	8.33	0.34	4.1	
461.8	3.426	48.5	1.7	3.5	461.8	3.426	14.4	0.48	3.3	
490.8	6.873	66.0*	0.73	1.1	490.8	6.873	25.5	0.051	2.0	

Toluene–Water System										
aqueous phase					organic phase					
T/K	P/MPa	$x_{\text{toluene}} \cdot 10^4$	estimated errors		T/K	P/MPa	$x_{\text{water}} \cdot 10^2$	estimated errors		
			absolute $\cdot 10^4$	%				absolute $\cdot 10^2$	%	
297.8	0.115	1.07	0.035	3.3	298.5	0.112	0.30	0.0081	2.8	
324	0.199	1.31	0.0092	0.70	324.3	0.201	0.55	0.023	4.1	
350.6	0.197	1.78	0.014	0.77	350.9	0.358	1.15	0.052	4.5	
376.1	0.167	2.77	0.018	0.66	376.6	0.478	2.22	0.11	4.8	
401.6	0.792	4.49	0.084	1.9	401.5	0.716	4.11	0.18	4.3	
431.9	1.261	7.46	0.22	2.9	431.7	1.450	7.79	0.23	2.9	
461.0	2.040	14.5	0.60	2.4	461.8	3.076	15.4	0.35	2.3	
490.4	3.800	25.3	0.57	2.4	491.4	4.733	25.2	0.47	1.8	

3-Methylpentane–Water System										
aqueous phase					organic phase					
T/K	P/MPa	$x_{3\text{-MP}} \cdot 10^4$	estimated errors		T/K	P/MPa	$x_{\text{water}} \cdot 10^2$	estimated errors		
			absolute $\cdot 10^4$	%				absolute $\cdot 10^2$	%	
298.3	0.188	0.026	0.00097	3.7	295.5	0.168	0.031	0.0017	5.6	
324.5	0.275	0.031	0.0010	3.2	299.1	0.194	0.038	0.0027	7.0	
351.2	0.402	0.047	0.0010	2.2	324.3	0.139	0.11	0.0079	7.4	
377.2	0.478	0.077	0.00091	1.2	350.9	0.486	0.29 <sup>a</sup>	0.0077	2.7	
401.2	0.709	0.14	0.0044	3.2	376.4	0.575	0.52	0.044	8.4	
432.2	1.924	0.26	0.0081	3.1	400.3	0.638	1.17	0.020	1.7	
462.1	3.352	0.60	0.018	3.0	432.4	2.144	2.51 <sup>a</sup>	0.0935	3.7	
491.9	7.248	2.18 <sup>a</sup>	0.061	2.8	491.5	5.860	13.0	0.43	3.3	

<sup>a</sup> Value was not used in the regression of the solubility parameters since the weighted deviation was greater than 2.5 times the standard deviation.

with an asterisk in Table 1 and discussed in the results section. Because error estimates for the data points vary with temperature, regressions were weighted by the expected experimental error for each data point, as determined through the analysis of propagated error. The objective function, WSS, is

$$\text{WSS} = \sum_{i=1}^n \left( \frac{y_i - \hat{y}_i}{\sigma_i} \right)^2 \quad (4)$$

where  $n$  is the number of data points;  $y_i$  is the predicted value;  $\hat{y}_i$  is the measured value; and  $\sigma_i$  is the estimated error in the measured value.

Knowledge of solvation processes and available calorimetric data can be used to assess the quality of the correlation. For very dilute hydrocarbon–water systems, the temperature dependence of the solubility can be expressed by the Gibbs–Duhem equation in the following general form<sup>16</sup>

$$\left( \frac{\partial \ln x_i}{\partial T} \right)_P \cong \frac{\Delta \bar{H}_i}{RT^2} \quad (5)$$

where the heat of solution,  $\Delta \bar{H}_i$ , is the excess enthalpy of component  $i$  expressed as the difference between the partial molar enthalpy of component  $i$  in solution and the pure molar

enthalpy of component  $i$ . The heat capacity of solution,  $\Delta \bar{C}_P$ , is defined with general notation as

$$\left( \frac{\partial \Delta \bar{H}_i}{\partial T} \right)_P = \Delta \bar{C}_P \quad (6)$$

This excess heat capacity is the difference between the partial molar heat capacity of component  $i$  in solution and the pure molar heat capacity of component  $i$ . The derivative properties, using a notation reflective of the hydrocarbon solubility, can be calculated from eq 3 to yield

$$\Delta H_{\text{soln,hc}} = -RT \left[ \frac{B}{T_{r,\text{hc}}} + \frac{2C}{T_{r,\text{hc}}^2} \right] \quad (7)$$

and

$$\Delta C_{p,\text{soln,hc}} = \frac{2RC}{T_{r,\text{hc}}^2} \quad (8)$$

For many hydrocarbon–water systems, a minimum hydrocarbon solubility exists where  $\Delta H_{\text{soln,hc}} = 0$ . The corresponding temperature,  $T_{\text{min,hc}}$ , can be estimated from eq 7 as



$$T_{\min, \text{hc}} = \frac{-2CT_{r, \text{hc}}}{B} \quad (9)$$

where  $T_{c, \text{hc}}$  is the critical temperature of the hydrocarbon.

**Solubility of Water in Hydrocarbons.** On the basis of derivative properties and the current understanding of the solvation process of water in hydrocarbons,<sup>17</sup> the data for the water solubility in hydrocarbons were correlated by an equation expressing the mole fraction of water in hydrocarbon,  $x_w$ , as a function of temperature as follows

$$\ln x_w = A + B \ln T_{r, w} \quad (10)$$

where  $T_{r, w}$  is the temperature (absolute) of the system divided by the critical temperature of water,  $T_c = 647.1$  K. The constants,  $A$  and  $B$ , in eq 10 were obtained by nonlinear regression in a fashion similar to the hydrocarbon solubility.

Using eq 10 and notation reflective of the water solubility, the enthalpy of solution and heat capacity of solution of water can be calculated as

$$\Delta H_{\text{soln}, w} = RBT \quad (11)$$

and

$$\Delta C_{p, \text{soln}, w} = RB \quad (12)$$

The solvation process of water dissolving into a nonpolar hydrocarbon liquid phase is described primarily as a process of breaking hydrogen bonds.<sup>18</sup> Typical hydrogen bond energies are in the range of (21 to 29)  $\text{kJ} \cdot \text{mol}^{-1}$  at 298 K, which should correspond to the value of  $\Delta H_{\text{soln}, w}$ .

## Results and Discussion

The mutual solubility data, which are expressed in terms of mole fraction, and error estimates of the benzene–water, toluene–water, and 3-methylpentane–water systems are reported in Table 1, and the weighted-root-mean-square (wrms) errors of the solubility data are given in Table 2. The correlation parameters and derivative property values are given in Table 3 and Table 4 for the hydrocarbon and water solubilities, respectively. Ideally, both phases were collected at the same time, but occasionally additional experimental data were collected for only one phase, which accounts for differences in operating temperatures and pressures in Table 1. Figures 2 to 13 present the mutual solubility data graphically, which includes plots of the solubility and percent deviation for each hydrocarbon or water solubility. The lines in the solubility plots represent the results of the correlating equations based on this work. Deviations from these lines show only differences among the investigators without a determination of accuracy.

**Table 2.** wrms for Hydrocarbon–Water Systems

system	wrms	
	aqueous phase	organic phase
benzene–water	0.72	0.61
toluene–water	0.68	0.36
3-methylpentane–water	0.52	0.10

**Table 3.** Derivative Properties for Hydrocarbon Solubilities

solute	parameters in eq 3			$\Delta H$	$\Delta C_p$	$T_{\min}$
	$A$	$B$	$C$	$\text{kJ} \cdot \text{mol}^{-1}$ at 298.15 K	$\text{J} \cdot \text{mol}^{-1} \cdot \text{K}^{-1}$ at 298.15 K	K
benzene	11.09	-19.79	5.176	1.25	306	294
toluene	10.71	-19.81	4.951	0.75	324	296
3-methylpentane	11.74	-29.14	8.641	-0.41	411	299

**Table 4.** Derivative Properties for Water Solubilities

solute	parameters in eq 10		$\Delta H$	$\Delta C_p$
	$A$	$B$	$\text{kJ} \cdot \text{mol}^{-1}$ at 298.15 K	$\text{J} \cdot \text{mol}^{-1} \cdot \text{K}^{-1}$ at 298.15 K
benzene	1.029	8.824	21.9	73.4
toluene	1.122	9.035	22.4	75.1
3-methylpentane	1.215	11.81	29.3	98.2

Error bars representing the uncertainty in the solubility measurements have been omitted from the solubility graphs since they do not extend beyond the symbols. From error propagation analysis of the three systems studied, the maximum uncertainty is 4 % at a mole fraction of 0.0027 (0.00011 absolute error) and 8 % at a mole fraction of 0.0052 (0.00044 absolute error) in the water-phase and organic-phase measurements, respectively. The higher uncertainty associated with the organic phase measurements is indicative of the difficulty in accurately analyzing aqueous samples by GC. The contributing factors to the uncertainty in the mole fractions include the solvent and sample weights, the GC analysis, and the temperature uncertainty. For both hydrocarbon and water solubility, the solvent and sample weights account for less than 1 % of the total uncertainty. The GC analysis and temperature account for approximately 84 % and 16 %, respectively, of the total hydrocarbon solubility uncertainty and 97 % and 3 %, respectively, of the total water solubility uncertainty. Because the aqueous phase has a smaller absolute uncertainty than the organic phase and the organic phase has a smaller wrms value than the aqueous phase, then there seems to be an anomaly present; however, the wrms is calculated by dividing (weighting) the deviation by the absolute uncertainty, and the magnitudes of the values involved may lead to contradictions in the expected relative magnitude of error values.

**Benzene Solubility in Water.** Benzene solubility measurements are presented in Figure 2. At temperatures near ambient, an abundance of data exist, which allows for detailed comparisons; however, the system has not been investigated as thoroughly at temperatures greater than 375 K. The evaluations of Hefter<sup>19</sup> and Wagner<sup>17</sup> were utilized extensively in evaluating the quality of the data.

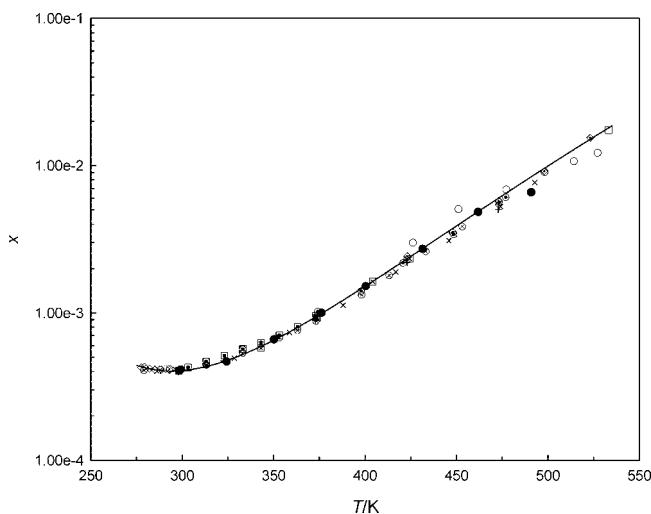

**Figure 2.** Mole fraction  $x$  of benzene, soluble in water, as a function of temperature  $T$ . —, correlation of this work; ●, this work; ○, ref 33; □, ref 34; ◇, ref 35; ◊, ref 36; ■, ref 31; ◆, ref 37; ⊙, ref 38; ◻, ref 39; tilted square with a dot in the middle, ref 1; circle with the middle filled, ref 2; square with the middle filled, ref 6; tilted square with the middle filled, ref 21; ⊗, ref 20; box with an X inside, ref 11; +, ref 22; ×, ref 9.

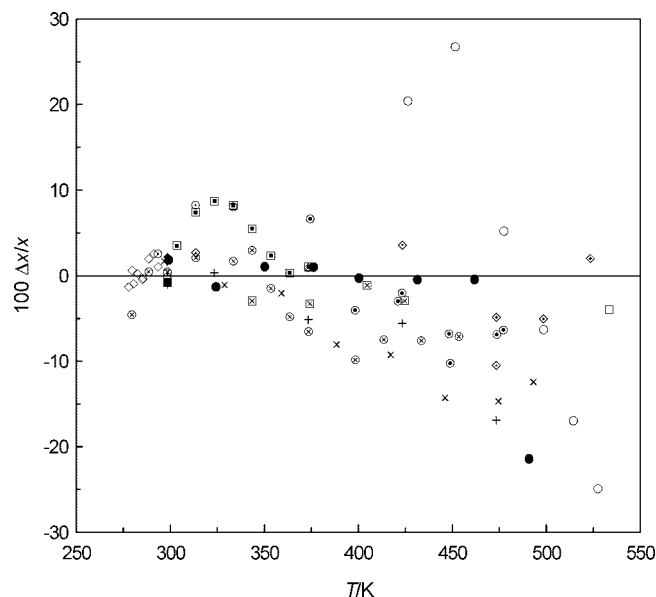

**Figure 3.** Fractional deviation,  $\Delta x/x = \{x(\text{exptl}) - x(\text{calcd})\}/x(\text{calcd})$ , of the solubility  $x(\text{exptl})$  of benzene in water as a function of temperature  $T$ . ●, this work; ○, ref 33; □, ref 34; ◇, ref 35; ◇, ref 36; ■, ref 31; ◆, ref 37; ⊙, ref 38; ⊞, ref 39; tilted square with a dot in the middle, ref 1; circle with the middle filled, ref 2; square with the middle filled, ref 6; tilted square with the middle filled, ref 21; ⊗, ref 20; ■, ref 11; +, ref 22; ×, ref 9.

Equation 3 was employed to correlate the benzene solubility measurements. Upon analysis, the measurement taken at 490.8 K was not included in the determination of the equation parameters due to a weighted deviation greater than 2.5 times the standard deviation. As estimated by error propagation, the solubility measurements have a maximum uncertainty of 4.0 % at a mole fraction of 0.0027 (0.00011 absolute error) and an average uncertainty of 1.6 %, which is shown in Figure 3. The wrms error of the solubility data is 0.72.

At temperatures less than 400 K, the solubility measurements agree within 10 % of the broad range of literature data. Generally, in the higher-temperature range, the measurements agree within 10 % of the more recent results reported by Jou and Mather,<sup>20</sup> Chandler et al.,<sup>21</sup> Chen and Wagner,<sup>7</sup> Anderson and Prausnitz,<sup>2</sup> and Marche et al.<sup>11</sup> Deviations greater than 10 %, however, were observed at higher temperatures in comparison with the recent studies of Ratzlaff<sup>9</sup> and Miller and Hawthorne.<sup>22</sup>

From eq 7, the heat of mixing at 298.15 K is  $1.25 \text{ kJ}\cdot\text{mol}^{-1}$ . This value agrees more favorably with the calorimetric heat of solution reported by Reid et al.<sup>23</sup> of  $0.80 \text{ kJ}\cdot\text{mol}^{-1}$  than the values reported by Gill et al.<sup>24</sup> of  $2.08 \text{ kJ}\cdot\text{mol}^{-1}$  and De Lisi et al.<sup>25</sup> of  $2.34 \text{ kJ}\cdot\text{mol}^{-1}$ . The specific heat of solution, calculated using eq 8 is  $306 \text{ J}\cdot\text{mol}^{-1}\cdot\text{K}^{-1}$ . While this value is in good agreement with the value of  $301 \text{ J}\cdot\text{mol}^{-1}\cdot\text{K}^{-1}$  reported by Clarke and Glew,<sup>26</sup> there is disagreement with the values of (373, 351, and 225)  $\text{J}\cdot\text{mol}^{-1}\cdot\text{K}^{-1}$  found by Makhatadze and Privalov,<sup>27</sup> Wauchope and Haque,<sup>28</sup> and Gill et al.,<sup>24</sup> respectively. Using eq 9, the temperature at which the minimum solubility of benzene in water occurs is 294 K, which is reasonably consistent with the value of 289.0 K reported by Gill et al.<sup>24</sup>

**Water Solubility in Benzene.** The solubility of water in benzene is shown in Figure 4. An abundance of solubility data for water in benzene exist in the literature at atmospheric pressures; however, Hefter<sup>19</sup> notes the more recent studies tend toward slightly higher solubilities than previous studies and with considerably smaller measurement uncertainty.

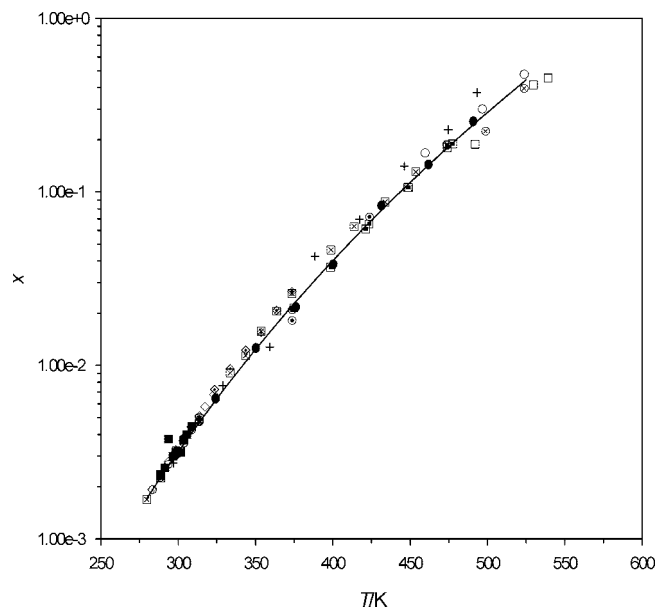

**Figure 4.** Mole fraction  $x$  of water soluble in benzene as a function of temperature. —, correlation of this work; ●, this work; ○, ref 40; □, ref 41; ◇, ref 42; ◇, ref 43; ■, ref 44; ◆, ref 32; ⊙, ref 45; ⊞, ref 46; tilted square with a dot in the middle, ref 47; circle with the middle filled, ref 1; square with the middle filled, ref 2; tilted square with the middle filled, ref 6; ⊗, ref 21; box with an X inside, ref 20; +, ref 9.

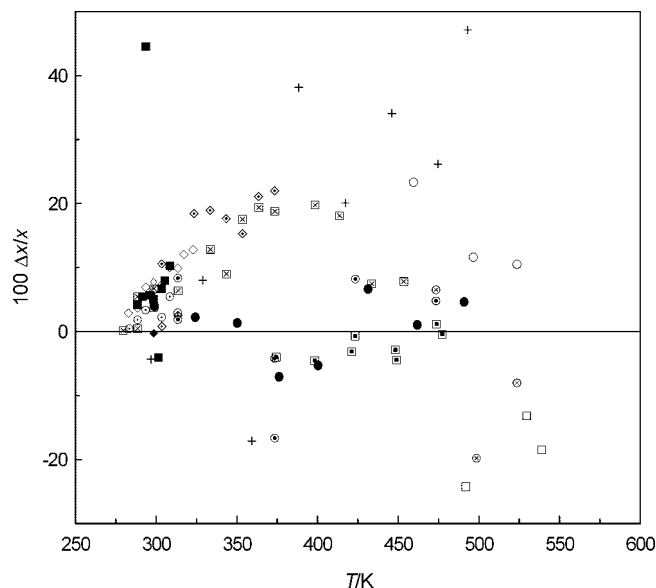

**Figure 5.** Fractional deviation,  $\Delta x/x = \{x(\text{exptl}) - x(\text{calcd})\}/x(\text{calcd})$ , of the solubility  $x(\text{exptl})$  of water in benzene as a function of temperature  $T$ . ●, this work; ○, ref 40; □, ref 41; ◇, ref 42; ◇, ref 43; ■, ref 44; ◆, ref 32; ⊙, ref 45; ⊞, ref 46; tilted square with a dot in the middle, ref 47; circle with the middle filled, ref 1; square with the middle filled, ref 2; tilted square with the middle filled, ref 6; ⊗, ref 21; box with an X inside, ref 20; +, ref 9.

Correlation of the water solubility measurements employed eq 10. As estimated by error propagation, the solubility measurements have a maximum uncertainty of 4.1 % at a mole fraction of 0.083 (0.0034 absolute error) and an average uncertainty of 3.2 %. The wrms error of the solubility data is 0.61. The percent deviations are shown graphically in Figure 5.

The solubility measurements from this study agree within 10 % of most literature data. Particularly good agreement is noted between this study and the work conducted by Anderson and

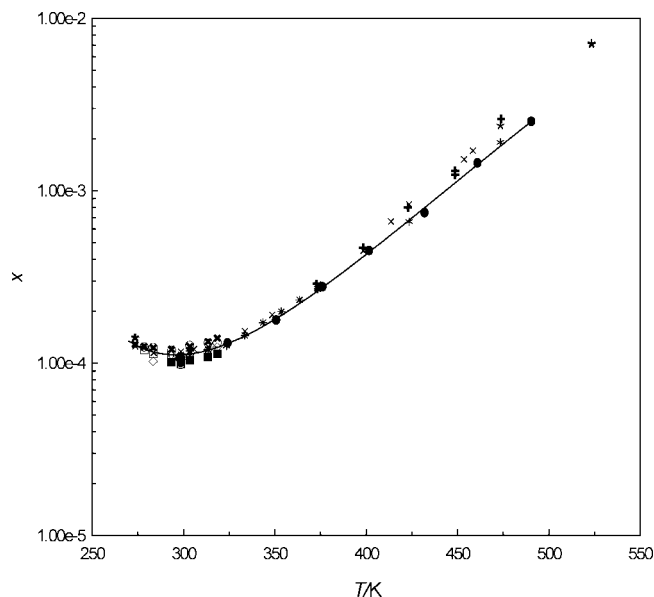

**Figure 6.** Mole fraction  $x$  of toluene, soluble in water, as a function of temperature  $T$ . —, correlation of this work; ●, this work; ○, ref 48; □, ref 35; ◇, ref 49; ◇, ref 50; ■, ref 51; ◆, ref 52; ⊙, ref 53; ⊠, ref 54; tilted square with a dot in the middle, ref 55; circle with the middle filled, ref 30; square with the middle filled, ref 36; tilted square with the middle filled, ref 56; ⊗, ref 31; box with an X inside, ref 57; +, ref 58; ×, ref 20; star, ref 21; \*, ref 22; eight-pronged asterisk, ref 7; bold +, ref 2; bold ×, ref 59; bold star, ref 32.

Prausnitz.<sup>2</sup> Over a midtemperature range, deviations approaching 20 % are observed with the recent data of Jou and Mather,<sup>20</sup> Chandler et al.,<sup>21</sup> and Chen and Wagner,<sup>7</sup> but better agreement is seen as the temperature increases. At higher temperatures, large differences are seen with the work of Ratzlaff.<sup>9</sup>

From eq 11, the heat of solution is determined to be 21.9 kJ·mol<sup>-1</sup>, at 298.15 K, which is in good agreement with the values of (20.7 and 23.3) kJ·mol<sup>-1</sup> reported by De Lisi et al.<sup>25</sup> and Chen and Wagner.<sup>7</sup> This value supports the theory stated by Franks<sup>18</sup> that liquid water dissolving into a nonpolar hydrocarbon liquid phase is essentially a process of breaking hydrogen bonds, which possess energy in the (21 to 29) kJ·mol<sup>-1</sup> range. Using eq 12, the heat capacity of solution at 298.15 K is estimated to be 73.4 J·mol<sup>-1</sup>·K<sup>-1</sup>, which is consistent with the value of 78.3 J·mol<sup>-1</sup>·K<sup>-1</sup> at 298.15 K reported by Chen and Wagner.<sup>7</sup>

**Toluene Solubility in Water.** An abundance of data exist at near ambient temperatures, but at temperatures greater than 325 K, the system has not been investigated as thoroughly. The solubility measurements are presented in Figure 6.

The maximum uncertainty of the solubility measurements, as estimated by error propagation, was 3.3 % at a mole fraction of 0.00011 ( $3.5 \cdot 10^{-6}$  absolute error) with an average uncertainty of 1.8 %. The wrms error of the solubility data is 0.68. Figure 7 provides a graphical representation of the percent deviations.

At temperatures less than 400 K, the solubility measurements agree within 10 % of the broad range of literature data. In the higher temperature range, the measurements are in reasonable agreement with the results of Miller and Hawthorne<sup>22</sup> and Anderson and Prausnitz,<sup>2</sup> but the works of Jou and Mather<sup>20</sup> and Chandler et al.<sup>21</sup> have large deviations.

The heat of solution at 298.15 K was determined using eq 7. The 0.751 kJ·mol<sup>-1</sup> value obtained is in poor agreement with the values reported by Gill et al.<sup>24</sup> of 1.73 kJ·mol<sup>-1</sup> and by De Lisi et al.<sup>25</sup> of 1.80 kJ·mol<sup>-1</sup>. The specific heat of solution, calculated with eq 8 is 324 J·mol<sup>-1</sup>·K<sup>-1</sup>. This value

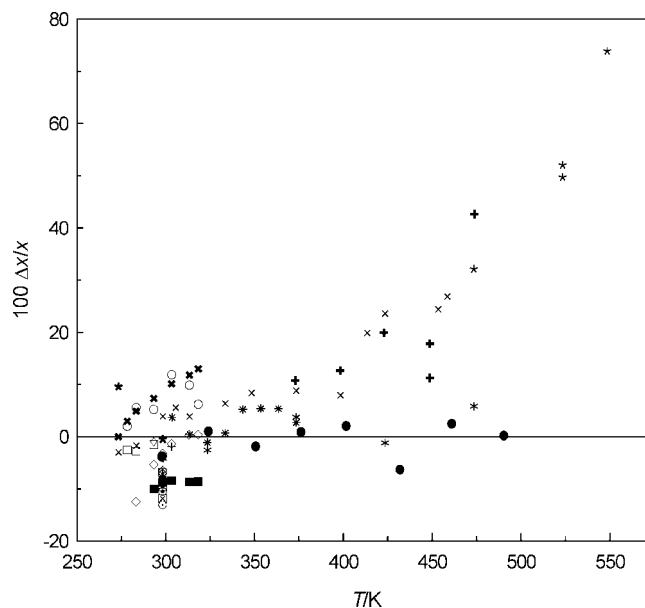

**Figure 7.** Fractional deviation,  $\Delta x/x = \{x(\text{exptl}) - x(\text{calcd})\}/x(\text{calcd})$ , of the solubility  $x(\text{exptl})$  of toluene in water as a function of temperature  $T$ . ●, this work; ○, ref 48; □, ref 35; ◇, ref 49; ◇, ref 50; ■, ref 51; ◆, ref 52; ⊙, ref 53; ⊠, ref 54; tilted square with a dot in the middle, ref 55; circle with the middle filled, ref 30; square with the middle filled, ref 36; tilted square with the middle filled, ref 56; ⊗, ref 31; box with an X inside, ref 57; +, ref 58; ×, ref 20; star, ref 21; \*, ref 22; eight-pronged asterisk, ref 7; bold +, ref 2; bold ×, ref 59; bold star, ref 32.

is in fair agreement with the values of (351 and 363) J·mol<sup>-1</sup>·K<sup>-1</sup> reported by Gill et al.<sup>24</sup> and Chen and Wagner,<sup>8</sup> respectively, but the value of 461 J·mol<sup>-1</sup>·K<sup>-1</sup> given by Makhatadze and Privalov<sup>27</sup> is much higher. Using eq 9, the temperature at which the minimum solubility of toluene in water occurs is 296 K, which is consistent with the values of (291.6 and 297.3) K reported by Gill et al.<sup>24</sup> and Chen and Wagner.<sup>8</sup>

**Water Solubility in Toluene.** The solubility of water in toluene is shown in Figure 8. An abundance of literature solubility data for water in toluene exist at near ambient temperatures. The measurements have a maximum uncertainty of 4.8 % at a mole fraction of 0.022 (0.0011 absolute error) and an average uncertainty of 3.4 %. The wrms error of the solubility data is 0.36. The percent deviations are shown graphically in Figure 9.

The solubility measurements from this study agree within 10 % of almost all literature data over the entire temperature range with a few exceptions. These exceptions include the recent data of Anderson and Prausnitz,<sup>2</sup> which approach deviations of approximately 15 % at higher temperatures, and Chandler et al.,<sup>21</sup> which deviate by 30 % at high temperatures.

From eq 11, the heat of solution is determined to be 22.4 kJ·mol<sup>-1</sup> at 298.15 K, which is consistent with the values of (30.9 and 23.9) kJ·mol<sup>-1</sup> reported by De Lisi et al.<sup>25</sup> and Chen and Wagner,<sup>8</sup> respectively. Again, this value supports the theory<sup>18</sup> that liquid water dissolving into a nonpolar hydrocarbon liquid phase is essentially a process of breaking hydrogen bonds. Using eq 12, the heat capacity of solution at 298.15 K is estimated to be 75.1 J·mol<sup>-1</sup>·K<sup>-1</sup>, with no available literature for comparison.

**3-Methylpentane Solubility in Water.** 3-Methylpentane solubility measurements are presented in Figure 10. Limited data exist at near ambient temperatures, and the system has not been investigated at temperatures greater than 300 K.

Correlation of the 3-methylpentane solubility measurements employed eq 3, but the measurement taken at 491.9 K was not

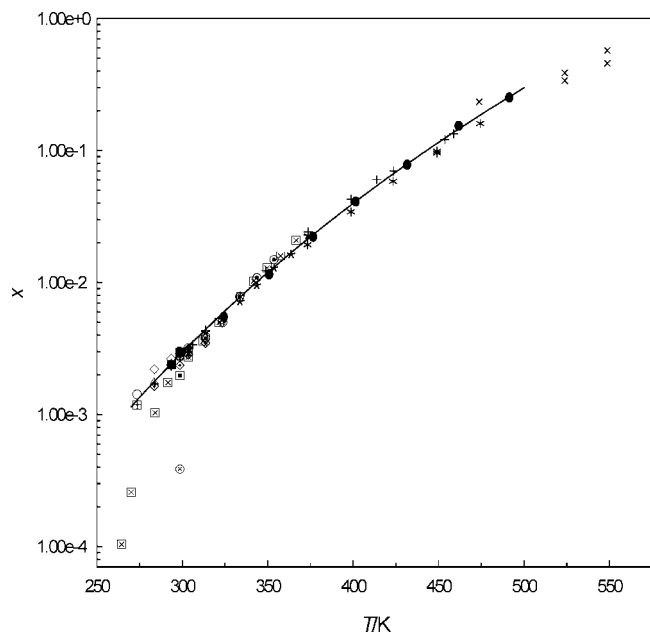

**Figure 8.** Mole fraction  $x$  of water, soluble in toluene, as a function of temperature. —, correlation of this work; ●, this work; ○, ref 60; □, ref 32; ◇, ref 61; ◇, ref 62; ■, ref 63; ◆, ref 64; ⊙, ref 65; ⊠, ref 66; tilted square with a dot in the middle, ref 53; circle with the middle filled, ref 67; square with the middle filled, ref 68; tilted square with the middle filled, ref 69; ⊗, ref 43; box with an X inside, ref 70; +, ref 20; ×, ref 21; star, ref 7; \*, ref 2.

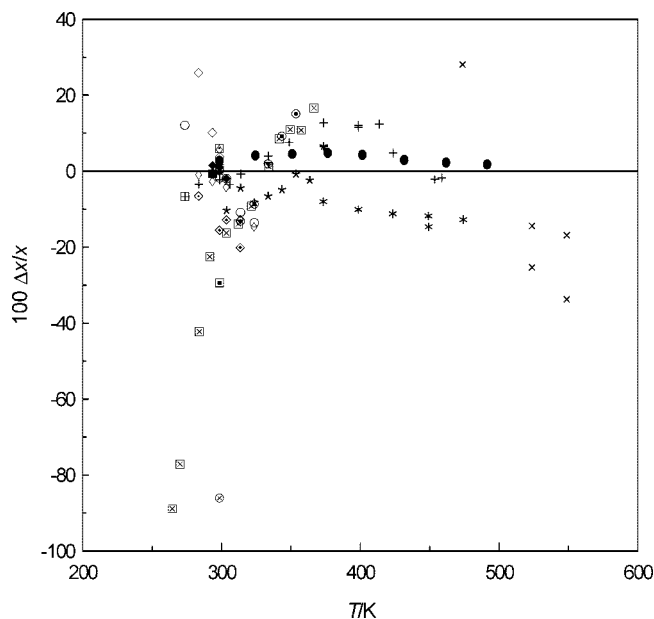

**Figure 9.** Fractional deviation,  $\Delta x/x = \{x(\text{exptl}) - x(\text{calcd})\}/x(\text{calcd})$  of the solubility  $x(\text{exptl})$  of water in toluene as a function of temperature  $T$ . ●, this work; ○, ref 60; □, ref 32; ◇, ref 61; ◇, ref 62; ■, ref 63; ◆, ref 64; ⊙, ref 65; ⊠, ref 66; tilted square with a dot in the middle, ref 53; circle with the middle filled, ref 67; square with the middle filled, ref 68; tilted square with the middle filled, ref 69; ⊗, ref 43; box with an X inside, ref 70; +, ref 20; ×, ref 21; star, ref 7; \*, ref 2.

included due to a weighted deviation greater than 2.5 times the standard deviation. The solubility measurements have a maximum uncertainty of 3.7 % at a mole fraction of 0.0000026 ( $9.7 \cdot 10^{-6}$  absolute error) and an average uncertainty of 2.8 %, which is shown in Figure 11. The wrms error of the solubility data is 0.52.

At a temperature of 300 K, the solubility measurement agrees within 3 % of the measurements reported by Rudakov and

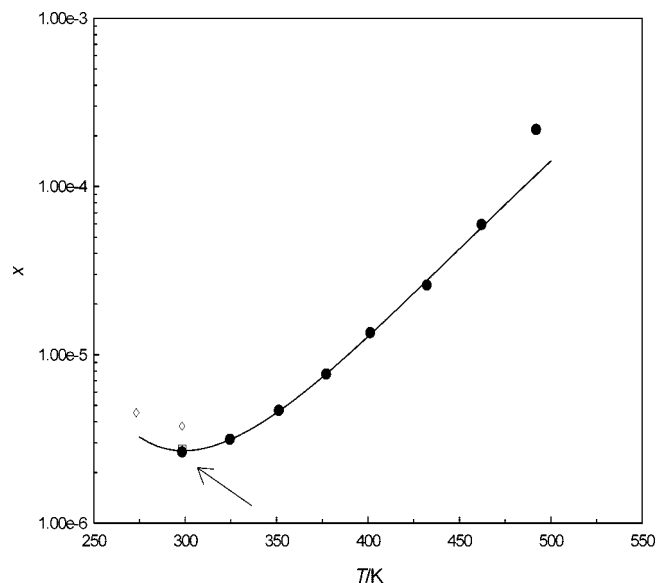

**Figure 10.** Mole fraction  $x$  of 3-methylpentane, soluble in water, as a function of temperature. As indicated by the arrow at  $T = 300$  K, there is superimposition of four points, ●, ○, ■, and ◇. —, correlation of this work; ●, this work; ○, ref 30; □, ref 31; ◇, ref 29; ◇, ref 32.

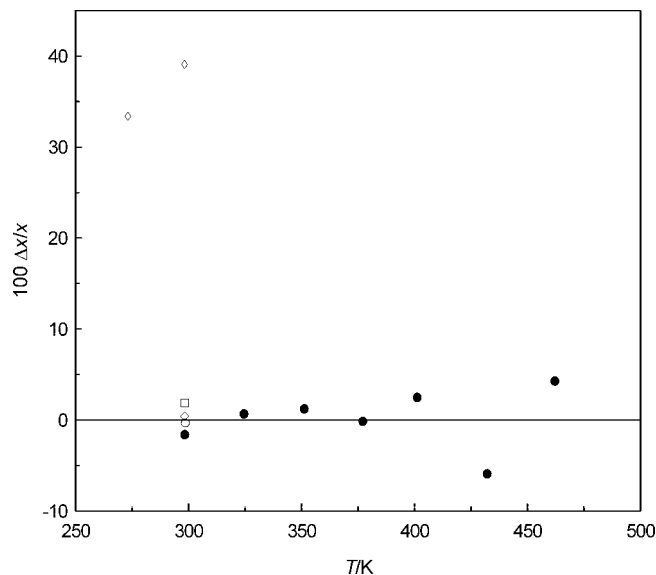

**Figure 11.** Fractional deviation,  $\Delta x/x = \{x(\text{exptl}) - x(\text{calcd})\}/x(\text{calcd})$ , of the solubility  $x(\text{exptl})$  of 3-methylpentane in water as a function of temperature  $T$ . ●, this work; ○, ref 30; □, ref 31; ◇, ref 29; ◇, ref 32.

Lutsyk,<sup>29</sup> McAuliffe,<sup>30</sup> and Price,<sup>31</sup> but the work of Polak and Lu<sup>32</sup> shows deviations approaching 40 %. However, according to the critical data review by Hefter,<sup>19</sup> other hydrocarbon solubility measurements made by Polak and Lu tend to be approximately 30 % higher than other reported values.

From eq 7, the heat of solution at 298.15 K is  $-0.407 \text{ kJ} \cdot \text{mol}^{-1}$ , and the specific heat of solution, calculated with eq 8, is  $411 \text{ J} \cdot \text{mol}^{-1} \cdot \text{K}^{-1}$ . Using eq 9, the temperature at which the minimum solubility of 3-methylpentane in water occurs is 299 K. Literature data are unavailable for comparison.

**Water Solubility in 3-Methylpentane.** Limited data exist at near-ambient temperatures, and the system has not been investigated at temperatures greater than 300 K. The solubility of water in toluene is shown in Figure 12.

In correlating the data, the measurements at (350.9 and 432.4) K were not included in the determination of the equation parameters due to a weighted deviation greater than 2.5 times



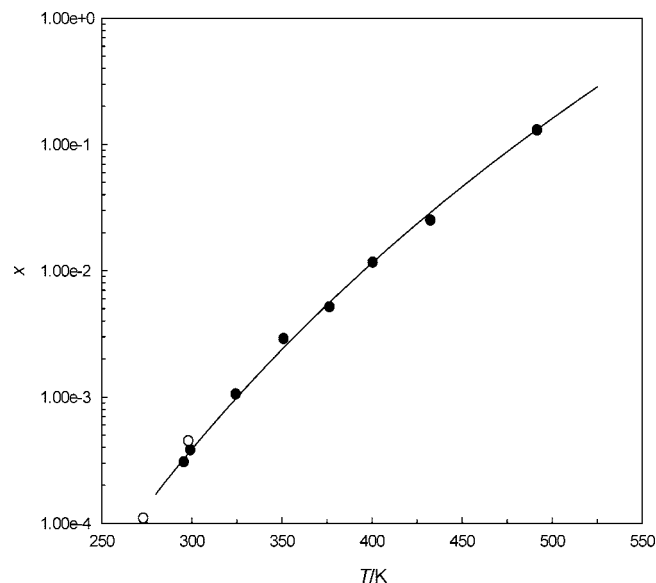

**Figure 12.** Mole fraction  $x$  of water, soluble in 3-methylpentane, as a function of temperature. —, correlation of this work; ●, this work; ○, ref 32.

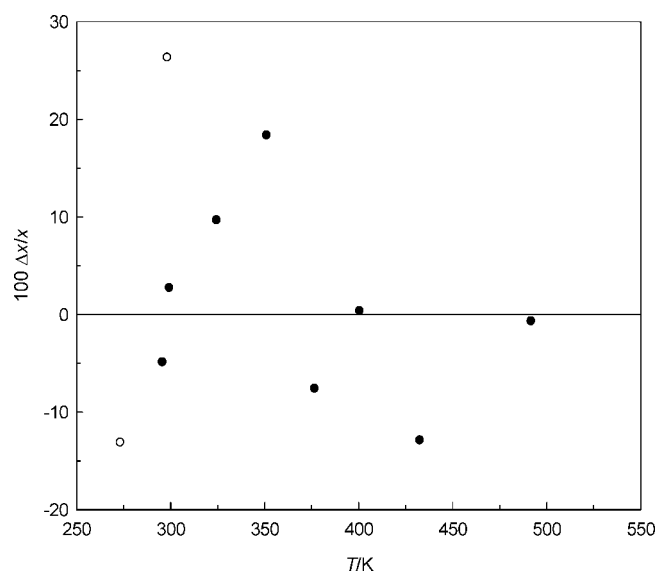

**Figure 13.** Fractional deviation,  $\Delta x/x = \{x(\text{exptl}) - x(\text{calcd})\}/x(\text{calcd})$ , of the solubility  $x(\text{exptl})$  of water in 3-methylpentane as a function of temperature  $T$ . ●, this work; ○, ref 32.

the standard deviation. The solubility measurements have a maximum uncertainty of 8.4 % at a mole fraction of 0.0052 (0.00044 absolute error) and an average uncertainty of 5.0 %, which is presented in Figure 13. The wrms error of the solubility data is 0.10.

The solubility measurements from this study show reasonable agreement with the data reported by Polak and Lu.<sup>32</sup> As shown by Hefter,<sup>19</sup> a decided lack of accuracy exists in Polak and Lu's hydrocarbon solubility values, but their water solubility data are more consistent with those of other researchers.

From eq 11, the heat of solution is determined to be 29.3 kJ·mol<sup>-1</sup>, at 298.15 K, which falls within the range of hydrogen bond energy. Using eq 12, the heat capacity of solution at 298.15 K is estimated to be 98.2 J·mol<sup>-1</sup>·K<sup>-1</sup>, with no available literature for comparison.

## Conclusions

A continuous flow apparatus was utilized to measure mutual solubilities at temperatures ranging from ambient to 500 K.

Generally, adequate agreement was observed for the benzene–water, toluene–water, and 3-methylpentane–water systems with literature data. A propagated error analysis of the three systems studied calculated the maximum uncertainty as 4 % at a mole fraction of 0.0027 (0.00011 absolute error) and 8 % at a mole fraction of 0.0052 (0.00044 absolute error) in the water-phase and organic-phase measurements, respectively.

Enthalpies of solution for the hydrocarbon solubility in water estimated from experimental measurements are in reasonable agreement with available calorimetric measurements from the literature. The enthalpies of solution for the water solubility in the hydrocarbons were within the range of the hydrogen bonding energies and were consistent with available literature data.

## Literature Cited

- (1) Tsonopoulos, C.; Wilson, G. M. High-temperature mutual solubilities of hydrocarbons and water. Part I: Benzene, cyclohexane and n-hexane. *AIChE J.* **1983**, *29*, 990–999.
- (2) Anderson, F. E.; Prausnitz, J. M. Mutual solubilities and vapor pressures for binary and ternary aqueous systems containing benzene, toluene, m-xylene, thiophene and pyridine in the region 100–200°C. *Fluid Phase Equilib.* **1986**, *32*, 63–76.
- (3) Shaw, R. W.; Brill, T. B.; Clifford, A. A.; Eckert, C. A.; Franck, E. U. Supercritical water—a medium for chemistry. *Chem. Eng. News* **1991**, *69*, 26–39.
- (4) Katritzky, A. R.; Allin, S. M.; Siskin, M. Aquathermolysis: Reactions of organic compounds with superheated water. *Acc. Chem. Res.* **1996**, *29*, 399–406.
- (5) Neely, B. J.; Ratzlaff, D. W.; Wagner, J.; Robinson, J. R. L.; Gasem, K. A. M. In *Mutual solubilities of hydrocarbon-water systems*; Integrated Petroleum Environmental Consortium, Albuquerque, NM, 2000; Albuquerque, NM, 2000.
- (6) Chen, H. P.; Wagner, J. An apparatus and procedure for measuring mutual solubilities of hydrocarbons + water: Benzene + water from 303 to 373 K. *J. Chem. Eng. Data* **1994**, *39*, 470–474.
- (7) Chen, H. P.; Wagner, J. An efficient and reliable gas chromatographic method for measuring liquid-liquid mutual solubilities in alkylbenzene + water mixtures: Toluene + water from 303 to 373 K. *J. Chem. Eng. Data* **1994**, *39*, 475–479.
- (8) Chen, H. P.; Wagner, J. Mutual solubilities of alkylbenzene + water systems at temperatures from 303 to 373 K: Ethylbenzene, p-xylene, 1,3,5-trimethylbenzene, and butylbenzene. *J. Chem. Eng. Data* **1994**, *39*, 679–684.
- (9) Ratzlaff, D. W. Hydrocarbon-water solubilities at elevated temperatures near the three-phase equilibrium pressure. M.S. Thesis, OK State University, Stillwater, OK, 1999.
- (10) Roof, J. G. Three-phase critical point in hydrocarbon-water systems. *J. Chem. Eng. Data* **1970**, *15*, 301–303.
- (11) Marche, C.; Delepine, H.; Ferronato, C.; Jose, J. Apparatus for the on-line GC determination of hydrocarbon solubility in water: Benzene and cyclohexane from 70 to 150 °C. *J. Chem. Eng. Data* **2003**, *48* (2), 398–401.
- (12) Chandler, J. P.; Jackson, L. W. *Computer program*, Department of Computing and Information Sciences, OK State University: Stillwater, OK, 1981.
- (13) Neely, B. J. Improved quantitative structure–property relationship models for infinite-dilution activity coefficients of aqueous systems. Ph.D. Dissertation, OK State University, Stillwater, 2007.
- (14) Benson, B. B.; Krause, D., Jr. Empirical laws for dilute aqueous solutions of nonpolar gases. *J. Chem. Phys.* **1976**, *64*, 689–709.
- (15) Wilhem, E.; Battino, R.; Wilcock, R. Low-pressure solubility of gases in liquid water. *Chem. Rev.* **1977**, *77*, 219–262.
- (16) Smith, J. M.; Van Ness, H. C.; Abbott, M. M. *Introduction to chemical engineering thermodynamics*, 5th ed.; McGraw-Hill: NY, NY, 1996.
- (17) Wagner, J. *GPSA engineering data book, revitalization and maintenance, water-hydrocarbon mutual solubility data*; Research Report RR-169; Gas Processors Association: Tulsa, OK, 1999.
- (18) Franks, F. Solute-water interactions and the solubility behavior of long-chain paraffin hydrocarbons. *Nature* **1966**, *210*, 87–88.
- (19) Hefter, G. T., *IUPAC solubility data series*, Pergamon Press: Oxford, UK, 1989; Vol. 37, pp 63–85.
- (20) Jou, F.-Y.; Mather, A. E. Liquid–liquid equilibria for binary mixtures of water + benzene, water + toluene, and water + p-xylene from 273 to 458 K. *J. Chem. Eng. Data* **2003**, *48* (3), 750–752.
- (21) Chandler, K.; Eason, B.; Liotta, C. L.; Eckert, C. A. Phase equilibria for binary aqueous systems from a near-critical water reaction apparatus. *Ind. Eng. Chem. Res.* **1998**, *37*, 3515–3518.

- (22) Miller, D. J.; Hawthorne, S. B. Solubility of liquid organics of environmental interest in subcritical (hot/liquid) water from 298 to 473 K. *J. Chem. Eng. Data* **2000**, *45* (1), 78–81.
- (23) Reid, D. S.; Quickenden, M. A. J.; Franks, F. Direct calorimetric measurement of the heats of solution of some liquid hydrocarbons in water. *Nature* **1969**, *224*, 1293–1294.
- (24) Gill, S. J.; Nichols, N. F.; Wadso, I. Calorimetric determination of enthalpies of solution of slightly soluble liquids. II. Enthalpy of solution of some hydrocarbons in water and their use in establishing the temperature dependence of their solubilities. *J. Chem. Thermodyn.* **1976**, *8*, 445–452.
- (25) De Lisi, R.; Goffredi, M.; Turco Liveri, V. Calorimetric determination of solution enthalpies of liquids with a small mutual solubility at 298.15 K. *J. Chem. Soc., Faraday Trans. 1* **1980**, *76* (8), 1660–1662.
- (26) Clarke, E. C. W.; Glew, D. N. Evaluation of thermodynamic functions from equilibrium constants. *Trans. Faraday Soc.* **1966**, *62*, 539–547.
- (27) Makhatazde, G. I.; Privalov, P. L. Partial specific heat capacity of benzene and of toluene in aqueous solution determined calorimetrically for a broad temperature range. *J. Chem. Thermodyn.* **1988**, *20* (4), 405–412.
- (28) Wauchope, R. D.; Haque, R. Aqueous solutions of nonpolar compounds. Heat-capacity effects. *Can. J. Chem.* **1972**, *50* (2), 133–138.
- (29) Rudakov, E. S.; Lutsyk, A. I. Solubility of saturated hydrocarbons in aqueous sulfuric acid. *Zh. Fiz. Khim.* **1979**, *53*, 1298–1300.
- (30) McAuliffe, C. Solubility in water of paraffin, cycloparaffin, olefin, acetylene, cycloolefin, and aromatic hydrocarbons. *J. Phys. Chem.* **1966**, *70*, 1267–1275.
- (31) Price, L. C. Aqueous solubility of petroleum as applied to its origin and primary migration. *Am. Assoc. Petrol. Geol. Bull.* **1976**, *60*, 213–244.
- (32) Polak, J.; Lu, B. C. Y. Mutual solubilities of hydrocarbons and water at 0 and 25 °C. *Can. J. Chem.* **1973**, *51*, 4018–4023.
- (33) Guseva, A. N.; Parnov, E. I. *Vestn. Mosk. Khim.* **1963**, *18*, 76–79.
- (34) Connolly, J. F. Solubility of hydrocarbons in water near the critical solution temperatures. *J. Chem. Eng. Data* **1966**, *11* (1), 13–16.
- (35) Brown, R. L.; Wasik, S. P. A method of measuring the solubilities of hydrocarbons in aqueous solutions. *J. Res. Natl. Bur. Stand.* **1974**, *453*–460.
- (36) Mackay, D.; Shiu, W. Y.; Wolkoff, A. W. *Water quality parameters*, ASTM STP 573; 1975; pp 251–258.
- (37) May, W. E.; Wasik, S. P.; Freeman, D. H. Determination of the aqueous solubility of polynuclear aromatic hydrocarbons by a coupled column liquid chromatographic technique. *Anal. Chem.* **1978**, *50* (1), 175–179.
- (38) Bittrich, H. J.; Gedan, H.; Feix, G. Zur loslichkeitsbeeinflussung von kohlenwasserstoffen in wasser. *Z. Phys. Chem. Leipzig* **1979**, *260*, 1009–1013.
- (39) Banerjee, S.; Yalkowsky, S. H.; Valvani, C. Water solubility and octanol/water partition coefficients of organics. Limitations of the solubility-partition coefficient correlation. *Environ. Sci. Technol.* **1980**, *14*, 1227–1229.
- (40) Umamo, S.; Hayano, I. Solubility of water and sodium chloride solution in benzene. *Kogyo Kagaku Zasshi* **1957**, *60*, 1436–1437.
- (41) Guerrant, R. P. Hydrocarbon-water solubilities at high temperatures under vapor-liquid-liquid equilibrium conditions, PA State University, 1964.
- (42) Moule, D. C.; Thurston, W. M. A method for the determination of water in nonpolar liquids; the solubility of water in benzene. *Can. J. Chem.* **1966**, *44* (12), 1361–1367.
- (43) Roddy, J. W.; Coleman, C. F. Solubility of water in hydrocarbons as a function of water activity. *Talanta* **1968**, *15*, 1281–1286.
- (44) Karlsson, R. Solubility of water in benzene. *J. Chem. Eng. Data* **1973**, *18* (3), 290–292.
- (45) Goldman, S. The determination and statistical mechanical interpretation of the solubility of water in benzene, carbon tetrachloride, and cyclohexane. *Can. J. Chem.* **1974**, *52* (9), 1668–1680.
- (46) Kirchnerová, J.; Cave, G. C. B. The solubility of water in low-dielectric solvents. *Can. J. Chem.* **1976**, *54* (24), 3909–3916.
- (47) Singh, R. P.; Sah, R. Aqueous solubility in a modified solvent system: Part I. Aqueous solubility in n-butyl, n-amyl, n-hexyl and benzyl alcohols containing benzene as a modifier of solvent environment. *Indian J. Chem.* **1978**, *16A*, 692–694.
- (48) Pierotti, R. A.; Liabastre, A. A. No. 21163; U. S. Nat. Tech. Inform. Serv., **1972**.
- (49) Sanemasa, I.; Araki, M.; Deguchi, T.; Nagai, H. Solubility measurements of benzene and the alkylbenzenes in water by making use of solute vapor. *Bull. Chem. Soc. Jpn.* **1982**, *55* (4), 1054–1062.
- (50) Korenman, I. M.; Aref'eva, R. P. Determination of the solubility of hydrocarbons in water. *J. Appl. Chem. USSR* **1978**, *51*, 923–924.
- (51) Sanemasa, I.; Arakawa, S.; Piao, C. Y.; Deguchi, T. Equilibrium solubilities of benzene, toluene, ethylbenzene, and propylbenzene in silver nitrate solutions. *Bull. Chem. Soc. Jpn.* **1985**, *58* (10), 3033–3034.
- (52) Andrews, L. J.; Keefer, R. M. Cation complexes of compounds containing carbon-carbon double bonds. IV. The argentation of aromatic hydrocarbons. *J. Am. Chem. Soc.* **1949**, *71*, 3644–7.
- (53) Klevens, H. B. Effect of electrolytes on the solubilization of hydrocarbons and polar compounds. *J. Am. Chem. Soc.* **1950**, *72*, 3780–5.
- (54) Morrison, T. J.; Billett, F. Salting-out of nonelectrolytes. II. The effect of variation in nonelectrolyte. *J. Chem. Soc., Abstracts* **1952**, 3819–3822.
- (55) McAuliffe, C. Solubility in water of C1-C9 hydrocarbons. *Nature* **1963**, *200* (4911), 1092–1093.
- (56) Sutton, C.; Calder, J. A. Solubility of alkylbenzenes in distilled water and sea water at 25.0 °C. *J. Chem. Eng. Data* **1975**, *20* (3), 320–322.
- (57) Rossi, S. S.; Thomas, W. H. Solubility behavior of three aromatic hydrocarbons in distilled water and natural seawater. *Environ. Sci. Technol.* **1981**, *15* (6), 715–716.
- (58) Gross, P. M.; Saylor, J. H. The solubilities of certain slightly soluble organic compounds in water. *J. Am. Chem. Soc.* **1931**, *53*, 1744–51.
- (59) Bohon, R. L.; Claussen, W. F. The solubility of aromatic hydrocarbons in water. *J. Am. Chem. Soc.* **1951**, *73*, 1571–1578.
- (60) Englin, B. A.; Plate, A. F.; Tugolukov, V. M.; Pryanishnikova, M. A. Solubility of water in individual hydrocarbons. *Khim. Tekhnol. Topl. Masel* **1965**, *10* (9), 42–46.
- (61) Uspenskii, S. P. Mutual solubility of some liquid fuels and water. *Neftyanoe Khozyaistvo* **1929**, *17*, 713–717.
- (62) Rosenbaum, C. K.; Walton, J. H. The use of calcium hydride for the determination of the solubility of water in benzene, carbon tetrachloride and toluene. *J. Am. Chem. Soc.* **1930**, *52*, 3568–3573.
- (63) Caddock, B. D.; Davies, P. L. The use of tritium to study the solubility of water in hydrocarbon liquids. *J. Inst. Pet.* **1960**, *46*, 391–396.
- (64) Glasco, P. K.; Schultz, S. D. Solubility of water and deuterium oxide in carbon tetrachloride, toluene, and cyclohexane at various temperatures. *J. Chem. Eng. Data* **1972**, *17* (1), 66–68.
- (65) Hogfeldt, E.; Bolander, B. The extraction of water and nitric acid by mixtures of triaurylamine (TLA) and octanol in aliphatic hydrocarbons. *Acta Chem. Scand.* **1964**, *18* (2), 548–552.
- (66) Johnson, J. R.; Christian, S. D.; Affsprung, H. E. The molecular complexity of water in organic solvents. II. *J. Chem. Soc., Inorg., Phys., Theoret.* **1966**, (1), 77–78.
- (67) Tarassenkow, D. N.; Poloshinzewa, E. N. *Zh. Obshch. Khim.* **1931**, *1*, 71–79.
- (68) Wing, J.; Johnston, W. H. Solubility of water in aromatic halides. *J. Am. Chem. Soc.* **1957**, *79*, 864–865.
- (69) Jones, J. R.; Monk, C. B. Determination of the solubility of water in some organic liquids by means of tritium. *J. Chem. Soc., Abstracts* **1963**, 2633–2635.
- (70) Tarassenkow, D. N.; Poloshinzewa, E. N. *Chem. Ber.* **1932**, *65*, 184–186.

Received for review August 06, 2007. Accepted October 02, 2007.

JE700449Z