

# Synthesis and Biological Properties of Water-Soluble *p*-Boronophenylalanine Derivatives. Relationship between Water Solubility, Cytotoxicity, and Cellular Uptake

Hisao Nemoto, Jianping Cai, and Naoki Asao

Department of Applied Molecular Science, Okazaki Institute for Molecular Science, Myodaiji 38, Okazaki 444, Japan

Satoshi Iwamoto and Yoshinori Yamamoto\*

Department of Chemistry, Faculty of Science, Tohoku University, Sendai 980-77, Japan

Received October 17, 1994\*

Water-soluble *p*-boronophenylalanine (BPA) derivatives having cascade polyols, the monohydroxy derivative BPA(OH) (4), the dihydroxy analogue BPA(OH)<sub>2</sub> (5), and the tetrahydroxy analogue BPA(OH)<sub>4</sub> (6), were synthesized in order to elucidate a relationship between the molecular structures and the cellular uptake. Biological properties of these compounds in addition to BPA (1) itself were investigated. Water solubility increased in the order of BPA < BPA(OH) ≤ BPA(OH)<sub>2</sub> < BPA(OH)<sub>4</sub>. Cytotoxicity to B-16 melanoma and TIG hydroblast cells decreased in the order of BPA ≫ BPA(OH) ≥ BPA(OH)<sub>2</sub> > BPA(OH)<sub>4</sub>. The cellular uptake by both B-16 and TIG cells decreased in the order of BPA > BPA(OH) ≥ BPA(OH)<sub>2</sub> > BPA(OH)<sub>4</sub>, whereas the uptake ratio of B-16/TIG increased in the order of BPA < BPA(OH) ≤ BPA(OH)<sub>2</sub> < BPA(OH)<sub>4</sub>. The latter ratio indicates the selectivity on the uptake by a cancer to normal cell.

## Introduction

*p*-Boronophenylalanine (1; BPA) is a <sup>10</sup>B carrier clinically used for boron neutron capture therapy (BNCT) for melanoma cancer.<sup>1</sup> It is considered that BPA is an analogue of phenylalanine or tyrosine, and incorporation of BPA to melanoma cells is very brisk. In fact, some successful results have been obtained clinically using BPA as a <sup>10</sup>B carrier.<sup>2</sup> A serious drawback associated with the use of BPA is its low water solubility.<sup>3</sup> Thus, administration of BPA is now carried out using an aqueous solution containing excess of fructose<sup>4</sup> which converts BPA to a mixture of water-soluble borate complexes, 2.<sup>3</sup> However, it is considered that *in vivo* 2 is immediately converted to BPA by the hydrolysis in the presence of a huge amount of water (Scheme 1).<sup>3</sup> Poor solubility in aqueous or biological media has been an obstacle to the effective delivery of potentially useful boron compounds, such as BPA, to the tumor site. We have developed polyols of a cascade type, 3, as a water-solubilizing element for BNCT.<sup>5</sup> Cascade polyols have no asymmetric centers, so that no diastereoisomers are formed when they are bonded to boron-containing biologically active molecules. Furthermore, the number of hydroxy groups can be managed at will; for example, polyols having one, two, four, or eight hydroxy groups are able to be prepared readily.<sup>5</sup> Accordingly, a systematic change of water solubility is attained using the cascade polyols. It occurred to us that we may control the water solubility of BPA by attaching the cascade polyols, thereby elucidating relationship between the molecular structures, water solubilities, cytotoxicities, and cellular uptakes of BPA derivatives. A relationship between the molecular structure and biological property of a biologically active compound has been mentioned frequently, but it seems that a clear-cut relationship has been obtained in very few cases. We wish to report that

Scheme 1. BPA and Its Fructose Complex

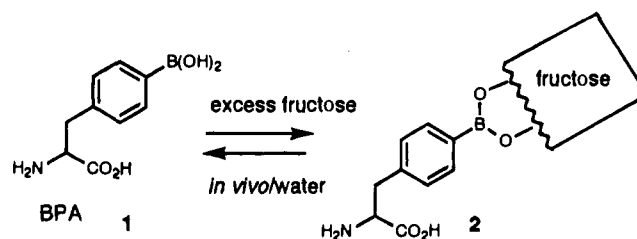

there is a marked relationship between the molecular structures of cascade polyol-attached BPA derivatives and their biological properties: (i) as the water solubility increases the cytotoxicity decreases, (ii) the cellular uptake decreases as the water solubility increases, (iii) the selectivity on the uptake by a cancer to normal cell increases as the water solubility increases.

## Results and Discussion

**Synthesis of BPA Derivatives Bearing Cascade Polyols.** We designed BPA derivatives 4-6 in order to obtain a potentially useful <sup>10</sup>B carrier for melanoma and to clarify a relationship between three biological properties (water solubility, cytotoxicity, and cellular uptake). 1,3-Bis(benzyloxy)-2-propanol (7a)<sup>5</sup> was converted to the corresponding tosylate 7b upon treatment with tosyl chloride/4-(dimethylamino)pyridine (DMAP) in pyridine. Treatment of 7b with sodium azide in DMF gave the azide derivative 7c. Reduction of 7c with LiAlH<sub>4</sub> in ether afforded 2-amino-1,3-bis(benzyloxy)propane (7d); the overall yield of 7d from 7a was 95%. Quite similarly, 1,3-bis(1,3-dibenzyl-2-glyceroxy)-2-propanol (8a) was converted to the amine derivative 8d in 73% overall yield (Scheme 2). BPA was converted to the Cbz-protected form 9, upon treatment with CbzCl in aqueous NaOH solution, in 98% yield. Treatment of 9 with 2 equiv of *N*-methyldiethanolamine in DMF gave

\* Abstract published in *Advance ACS Abstracts*, April 15, 1995.

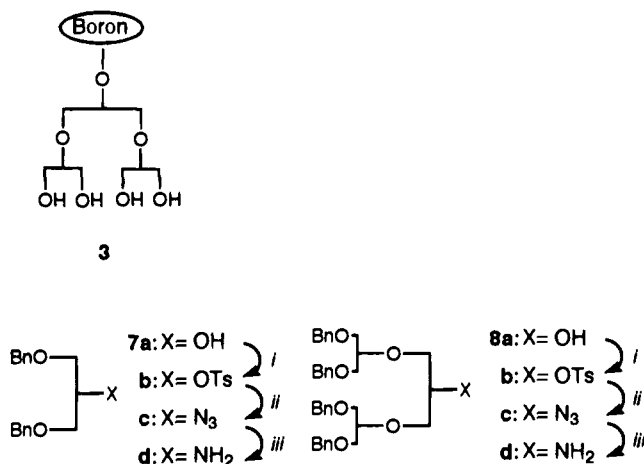
**Scheme 2.** Synthesis of Cascade Polyol Derivatives<sup>a</sup>

<sup>a</sup> (i) TsCl, DMAP in Py; (ii) NaN<sub>3</sub> in DMF; (iii) LiAlH<sub>4</sub> in ether. 7a → 7d, 95%; 8a → 8d, 73%.

the boronate **10** in which the B(OH)<sub>2</sub> group was protected by the *N*-methylethanolamine moiety. Reaction of **10**, without isolation and purification, with ethanolamine in the presence of HOBt (*N*-hydroxybenzotriazole) and EDC (ethyl-*N,N*-(dimethyl-3-aminopropyl)-carbodiimide)<sup>6</sup> afforded **11**, which was transformed to the monohydroxy borophenylalanine derivative **4**, BPA(OH), upon hydrogenation with Pd(OH)<sub>2</sub>-C catalyst (Scheme 3). The overall yield of **4** from **9** was 28%. Treatment of **10** with **7d** under the same conditions as above (HOBt-EDC) produced **12** in 95% yield.<sup>7</sup> It should be noted that the use of *N*-methyldiethanolamine protection for the B(OH)<sub>2</sub> group is essential to obtain a high chemical yield in the condensation step with **7d**. The direct reaction of **9** with **7d** in the presence of HOBt-EDC gave **12** in lower yield (48% yield). Perhaps, the coordination of a nitrogen lone pair to boron stabilizes the boronate group, avoiding the nucleophilic attack of the amine to the boron atom, and thereby the condensation proceeds effectively.<sup>8</sup> Removal of the Cbz and Bn groups from **12** using H<sub>2</sub>/Pd(OH)<sub>2</sub>-C afforded **5**, BPA(OH)<sub>2</sub>, in 56% yield. The similar procedure was used for the condensation of **10** with **8d**. Without purification, **13** was converted to **6** upon hydrogenation. The tetrahydroxy BPA derivative **6**, BPA(OH)<sub>4</sub>, was obtained in 37% overall yield from **9**.

**Biological Properties.** (1) **Water Solubility.** The water solubilities of BPA itself, BPA(OH), BPA(OH)<sub>2</sub>, and BPA(OH)<sub>4</sub> are shown in Table 1. It is apparent that BPA(OH)<sub>4</sub> is about 150 times more water-soluble than BPA itself (entry 4 vs 1).

(2) **Cytotoxicity (Survival ratio of cells).** The cytotoxicities of BPA(OH)<sub>*n*</sub> toward B-16 melanoma cells and TIG-1-20 hydroblast cells (human fetal lung normal cells) are shown in Table 2, although the data are not IC<sub>50</sub> values but survival ratio of cells. B-16 cells were chosen as a model of tumor cells and TIG as a model of normal cells.<sup>9</sup> The IC<sub>50</sub> values of BPA were 8.6 × 10<sup>-3</sup> and 2.2 × 10<sup>-3</sup> M for B-16 and TIG, respectively. Obviously, BPA is far less toxic than 1-carbonyl-3-(2-methylaziridino)-2-propanol (MACB)<sup>9a</sup> and 5-carboranyluridine (5-B<sub>10</sub>U),<sup>9b</sup> whose IC<sub>50</sub> values to B-16 cells were of the order of 10<sup>-6</sup> and 10<sup>-5</sup> M, respectively. The newly synthesized compounds BPA(OH)<sub>*n*</sub> (*n* = 1, 2, and 4) were much less toxic than BPA, and large amounts of the compounds were needed to measure those IC<sub>50</sub>

values; for example, the growth inhibition of B-16 cells with BPA(OH)<sub>2</sub> did not reach 50% even under 1.8 × 10<sup>-2</sup> M concentration. Accordingly, for convenience sake, the survival ratios of the cells were obtained by counting numbers of living cells after incubating the cells under the same concentration (1.5 × 10<sup>-3</sup> M) of the boron compounds (see the Experimental Section) (Table 2). Needless to say, the ratio is 100% if the cells are incubated in the absence of boron compounds (entry 1). It is clear that the toxicity of the boron compounds toward both B-16 and TIG decreases in the order of BPA ≫ BPA(OH) ≥ BPA(OH)<sub>2</sub> > BPA(OH)<sub>4</sub>. Very interestingly, selective toxicity to B-16 cells was observed in the case of BPA(OH)<sub>*n*</sub> (*n* = 1, 2, and 4), although the extent of the selectivity was not large.

(3) **Cellular Uptake.** Incorporation of each <sup>10</sup>B carrier in the cells was measured by using the ICP-AES method.<sup>9a</sup> The cells [(4.5–5.0) × 10<sup>6</sup>] were incubated for 1–24 h with Eagle-MEM medium containing 2 mM BPA(OH)<sub>*n*</sub> (*n* = 0, 1, 2, and 4). The solubility of BPA(OH)<sub>4</sub> in this medium was greater than 2 mM (*cf.* Table 1), but the concentration was adjusted to 2 mM for the purpose of comparison with other carriers. Since BPA itself was less soluble, BPA·HCl was used, and the concentration was adjusted to 2 mM. At 3, 12, and 24 h, the cells were washed three times with PBS(-) (Ca- and Mg-free phosphate-buffered saline, 5 mL) and processed for boron measurement by ICP. The results are summarized in Figure 1. Boron incorporation increased, as time went on, regardless of the cells and the boron carriers. The cellular uptake of BPA(OH)<sub>*n*</sub> by B-16 melanoma cells was greater, at any times, than that by TIG normal cells. This observation seems to be a reflection of the fact that B-16 is a cancer cell and TIG is a sort of normal cell; the growth of B-16 is more rapid than that of TIG. The cellular uptake at 24 h is shown in Figure 2. It is clear that, as the water solubility of BPA(OH)<sub>*n*</sub> increases, the boron incorporation decreases irrespective of B-16 melanoma and TIG hydroblast cells. A very interesting phenomenon on the selectivity of the cellular uptake is observed in Figure 2. Apparently, the boron uptake ratio of B-16 to TIG cells in the case of BPA(OH)<sub>4</sub> is greater than the ratio in the case of BPA. Figure 3 shows a relationship between the water solubility of BPA(OH)<sub>*n*</sub> and the boron uptake ratio of B-16 to TIG cells. The selectivity increases as the water solubility increases. This seems to be a promising result because the selective uptake by a cancer cell may be enhanced with the increase of water solubility.

Direct correlations between the cellular uptake at 24 h (the intracellular molar concentration of BPA(OH)<sub>*n*</sub> with cell survival ratio are shown in Figure 4 (for B-16) and Figure 5 (for TIG). Since it was demonstrated that the cellular uptake of the compound decreased based on its increased hydrophilicity, there appeared to be a relationship between increased hydrophilicity of the compound and decreased cytotoxicity. This may be directly related to the intracellular concentration of the compound alone. We assumed that the boron concentration determined by the ICP method would be roughly similar to the intracellular concentration. Figure 5 shows that the survival ratio of TIG increases with the decreases of boron concentration. Although the relationship shown in Figure 4 is not straightforward in

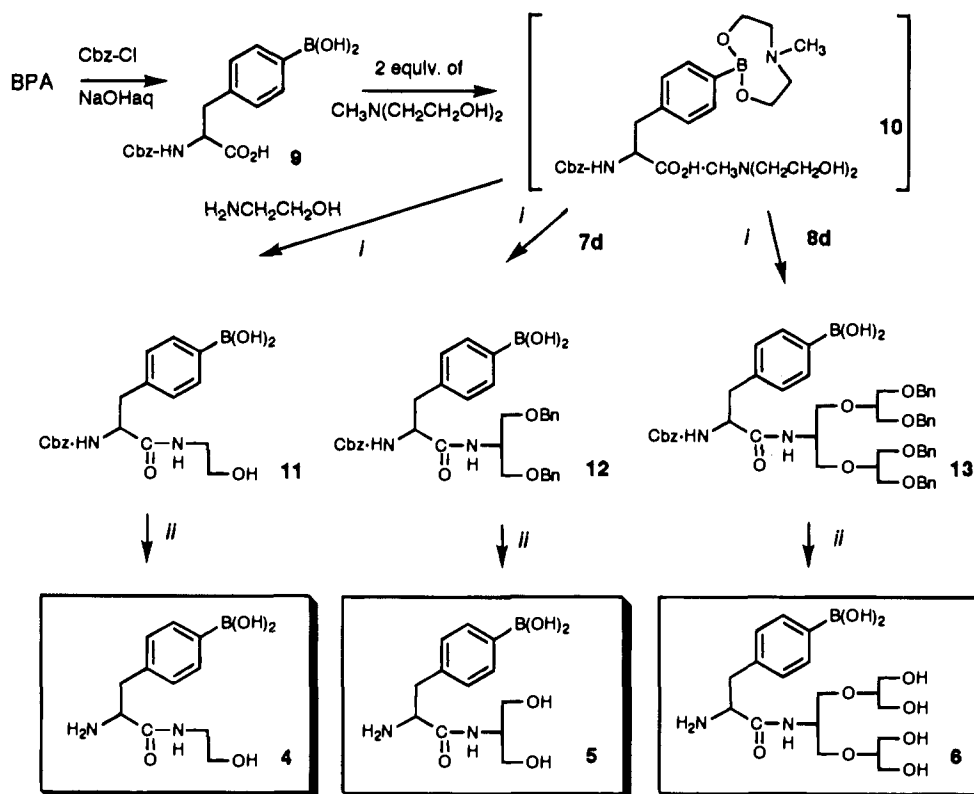
Scheme 3. Synthesis of BPA Derivatives Bearing Cascade Polyols<sup>a</sup>

<sup>a</sup> (i) *N*-Hydroxybenzotriazole,  $(\text{CH}_3)_2\text{N}^+\text{HCH}_2\text{CH}_2\text{N}=\text{C}=\text{NC}_2\text{H}_5$  in dimethylformamide; (ii)  $\text{Pd}(\text{OH})_2$  on charcoal,  $\text{HCl}_{\text{aq}}$ ,  $\text{H}_2$  in  $\text{CH}_3\text{OH}$ .

Table 1. Water Solubility of  $\text{BPA}(\text{OH})_n$ <sup>a</sup>

| entry | $\text{BPA}(\text{OH})_n$     | solubility at room temp (M)  |
|-------|-------------------------------|------------------------------|
| 1     | BPA (1)                       | $7.7 \pm 0.1 \times 10^{-3}$ |
| 2     | $\text{BPA}(\text{OH})$ (4)   | $6.0 \pm 0.1 \times 10^{-1}$ |
| 3     | $\text{BPA}(\text{OH})_2$ (5) | $6.6 \pm 0.1 \times 10^{-1}$ |
| 4     | $\text{BPA}(\text{OH})_4$ (6) | $1.20 \pm 0.05$              |

<sup>a</sup> The ICP-AES method was used for the measurement.

Table 2. Survival Ratio of the Cells

| entry | compound                      | survival ratio (%) |             |
|-------|-------------------------------|--------------------|-------------|
|       |                               | B-16               | TIG         |
| 1     | —                             | $100 \pm 3$        | $100 \pm 3$ |
| 2     | BPA (1)                       | $20 \pm 1$         | $20 \pm 1$  |
| 3     | $\text{BPA}(\text{OH})$ (4)   | $60 \pm 2$         | $66 \pm 2$  |
| 4     | $\text{BPA}(\text{OH})_2$ (5) | $60 \pm 2$         | $71 \pm 2$  |
| 5     | $\text{BPA}(\text{OH})_4$ (6) | $62 \pm 2$         | $73 \pm 2$  |

comparison with that in Figure 5, the survival ratio of B-16 increases, more or less, with the decrease of boron concentration. Accordingly, the results obtained here suggest how important the compound's hydrophilic properties are in determining its cytotoxicity.

### Conclusion

We have clarified, for the first time, a relationship between the water solubility, cytotoxicity, and cellular uptake of  $\text{BPA}(\text{OH})_n$  ( $n = 0, 1, 2,$  and  $4$ ). As the water solubility increases, the cytotoxicity to and the cellular uptake by both B-16 and TIG cells decrease. However, the selectivity of the uptake by B-16 increases as the water solubility increases. Accordingly, it is expected that a water-soluble BPA derivative may provide a better result in vivo in an actual neutron irradiation experiment. In fact, a distinctly improved therapeutic effect of  $^{10}\text{B}$ -enriched  $\text{BPA}(\text{OH})_2$ , as compared to the

$^{10}\text{B}$ BPA-fructose complex, in neutron capture therapy of malignant melanoma in hamsters (NCI-245) was observed.<sup>10</sup> After 18 days, the tumor volume was decreased to approximately 18% by using  $^{10}\text{B}$ BPA-(OH)<sub>2</sub>, whereas it was decreased to approximately 50% by using the  $^{10}\text{B}$ BPA-fructose complex. We have been able to determine the cellular uptake by using ICP and boron element<sup>11</sup> and thus clarify a relationship between the molecular structure and biological properties. Perhaps, the relationship obtained here provides a suggestion to ones who want to know the ability of the cellular uptake of some biologically important molecules.

### Experimental Section

**Materials.** <sup>1</sup>H- and <sup>13</sup>C-NMR spectra were recorded on a JEOL EX-270 spectrometer. The chemical shifts were expressed in parts per million downfield from tetramethylsilane as internal or outer standard. IR spectra were taken with a Hitachi 215 spectrometer or a Perkin Elmer 1600 FT-IR spectrometer. Elemental analyses were carried out with a Yanaco CHN recorder MT-3 spectrometer. Column chromatography was performed on Merck Kiesel gel (230–400 mesh). Pyridine (Py) was distilled over KOH. Dimethylformamide (DMF) was treated by Dowex 50 ( $\text{H}^+$  form) and then dried over barium oxide and distilled.<sup>12</sup> Ether was distilled over benzophenone sodium prior to use. Perfect removal of water from cascade polyols and their boron derivatives was not easy. Accordingly, some elemental analysis data are based on the molecular formula containing  $(\text{H}_2\text{O})_x$ .

**Source of Cells.** B-16 melanoma cells (B-16) and TIG-1-20 hydroblast cells (TIG) were obtained from Cancer Cell Repository, Research Institute for Tuberculosis and Cancer, Tohoku University.

**Synthesis of 2-Amino-1,3-bis(benzyloxy)propane (7d).** A mixture of 1,3-dibenzylglycerol (7a) (20.07 g, 73.69 mmol) and *p*-TsCl (21.25 g, 111.5 mmol) in pyridine (25 mL) in the presence of DMAP (1.82 g, 14.90 mmol) was stirred for 21 h at room temperature. To the mixture was added an aqueous

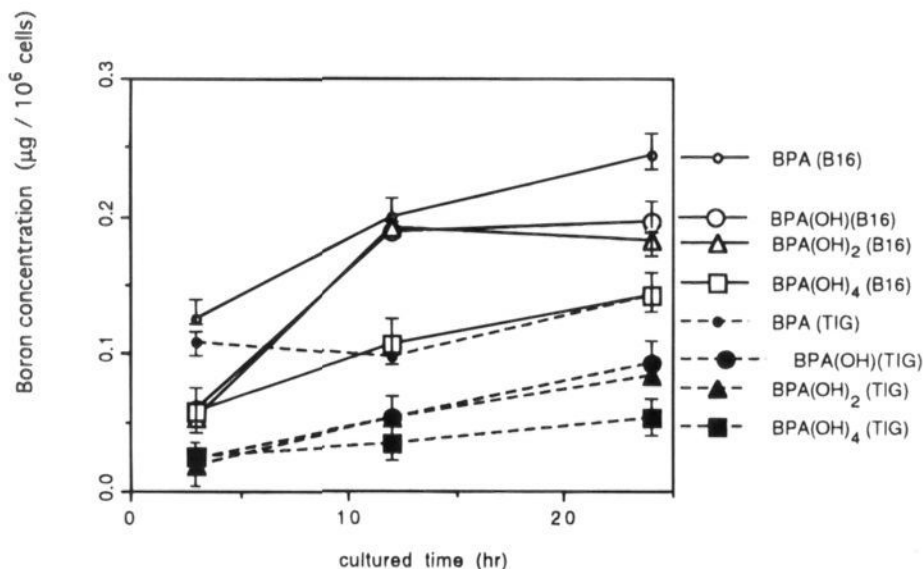

Figure 1. Boron incorporation into B-16 and TIG cells with BPA(OH)<sub>n</sub>.

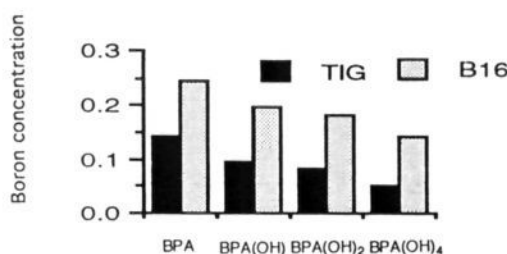

Figure 2. Cellular uptake at 24 h.

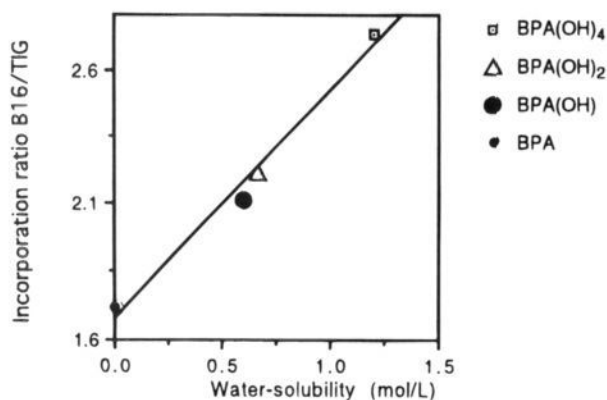

Figure 3. Relationship between water solubility and boron uptake.

3 N HCl solution (150 mL) at 0 °C, and the product was extracted with three portions of ether. The combined organic layers were washed with saturated aqueous NaHCO<sub>3</sub> solution and brine, dried over MgSO<sub>4</sub>, and concentrated *in vacuo*. The tosylate **7b**, thus obtained, was used for further manipulation without purification.

A mixture of **7b** and sodium azide (9.63 g, 148.1 mmol) in DMF (50 mL) was stirred for 5 h at 100 °C. The resulting mixture was cooled to room temperature, the reaction quenched with water, and the mixture extracted with three portions of ether. The combined organic layers were washed with brine, dried over MgSO<sub>4</sub>, and concentrated *in vacuo* to give the azide **7c**, which was used for the next step without purification.

To a solution of **7c** in ether (400 mL) was added dropwise a solution of lithium aluminum hydride (5.63 g, 148.3 mmol) in ether (180 mL) and the mixture was stirred for 3 h at 0 °C. The reaction was quenched with ethyl acetate/water, and the resulting suspension was filtered. The filtrate was dried over

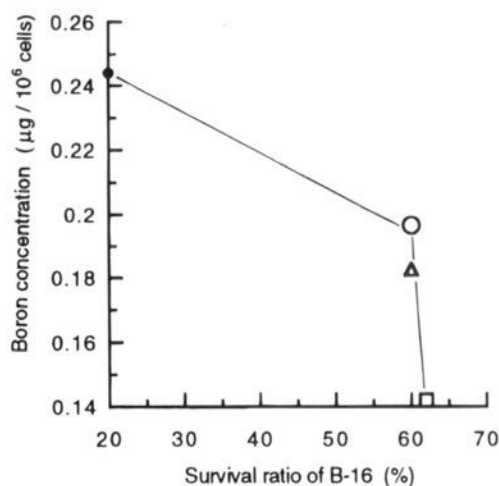
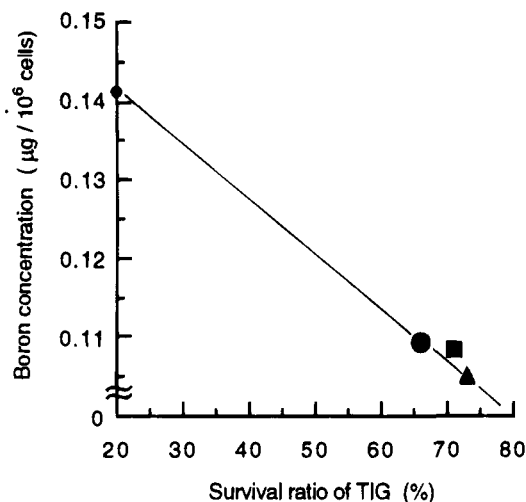

Figure 4. Relationship between cellular uptake at 24 h and cell survival ratio of B-16: (○) BPA, (○) BPA(OH), (△) BPA(OH)<sub>2</sub>, and (□) BPA(OH)<sub>4</sub>.

MgSO<sub>4</sub> and concentrated *in vacuo*. The residue was purified by column chromatography on silica gel using ethyl acetate/ethanol (100:1) as an eluent, giving the amine **7d** as a colorless oil (19.08 g, 70.32 mmol, 95% overall yield from **7a**): IR (neat) 3370, 3030, 2860, 2350, 1585, 1495, 1450, 1360, 1320, 1260, 1200, 1090, 1050, 920, 860, 735, 695, 610 cm<sup>-1</sup>; <sup>1</sup>H-NMR (CDCl<sub>3</sub>) δ 7.24–7.39 (m, 10H, aromatics), 4.51 (s, 4H, C<sub>6</sub>H<sub>4</sub>CH<sub>2</sub>O-), 3.52 (dd, *J* = 9.1, 4.8 Hz, 2H, C<sub>6</sub>H<sub>4</sub>CH<sub>2</sub>O-CH<sub>2</sub>-), 3.41 (dd, *J* = 9.1, 6.6 Hz, 2H, C<sub>6</sub>H<sub>4</sub>CH<sub>2</sub>O-CH<sub>2</sub>-), 3.23 (tt, *J* = 6.6, 4.8 Hz, 1H, H<sub>2</sub>N-CH-), 1.79 (brs, 2H, H<sub>2</sub>N-); <sup>13</sup>C-NMR (CDCl<sub>3</sub>) δ 138.2 (aromatics), 128.3 (aromatics), 128.1 (aromatics), 127.6 (aromatics), 73.3 (benzylics), 72.6 (methylenes), 51.0 (methylene at amino group). Anal. Calcd for C<sub>17</sub>H<sub>21</sub>O<sub>2</sub>N<sub>1</sub>·(H<sub>2</sub>O)<sub>0.428</sub>: C, 73.17; H, 7.83; N, 5.02. Found: C, 73.17; H, 7.60; N, 5.06.

**Synthesis of 2-Amino-1,3-bis(1,3-dibenzyl-2-glyceroxy)propane (8d).** A mixture of **8a** (10.267 g, 17.09 mmol) and *p*-TsCl (4.896 g, 25.68 mmol) in pyridine (6.5 mL) in the presence of DMAP (0.428 g, 3.50 mmol) was stirred for 17 h at room temperature. The usual workup gave **8b**. A mixture of **8b** and sodium azide (3.379 g, 51.98 mmol) in DMF (20 mL) as stirred for 5 h at 120 °C, giving **8c**. To a solution of **8c** in ether (50 mL) was added dropwise a solution of lithium aluminum hydride (1.00 g, 26.35 mmol) in ether (20 mL), and the mixture was stirred for 3 h at 0 °C. The usual workup afforded **8d** as a colorless oil (7.457 g, 12.43 mmol, 73% overall



**Figure 5.** Relationship between cellular uptake at 24 h and cell survival ratio of TIG: (●) BPA, (●) BPA(OH), (▲) BPA(OH)<sub>2</sub>, and (■) BPA(OH)<sub>4</sub>.

yield from **8a**): IR (neat) 3380, 3030, 2860, 2360, 1910, 1870, 1810, 1585, 1495, 1455, 1410, 1365, 1310, 1250, 1205, 1100, 735, 700, 610 cm<sup>-1</sup>; <sup>1</sup>H-NMR (CDCl<sub>3</sub>) δ 7.21–7.35 (m, 20H, aromatics), 4.50 (s, 8H, C<sub>6</sub>H<sub>4</sub>CH<sub>2</sub>O-), 3.43–3.74 (m, 14H, C<sub>6</sub>H<sub>4</sub>-CH<sub>2</sub>O-CH<sub>2</sub>- and C<sub>6</sub>H<sub>4</sub>CH<sub>2</sub>OCH<sub>2</sub>CH-O-), 3.14 (tt, *J* = 6.7, 4.9 Hz, 1H, H<sub>2</sub>N-CH-), 1.90 (brs, 2H, H<sub>2</sub>N-); <sup>13</sup>C-NMR (CDCl<sub>3</sub>) δ 138.1 (aromatics), 128.3 (aromatics), 127.7 (aromatics), 127.5 (aromatics), 78.4 (-HC-O-), 73.2 (benzylics), 72.6 (methylenes), 51.3 (H<sub>2</sub>N-C-). Anal. Calcd for C<sub>37</sub>H<sub>45</sub>O<sub>6</sub>N<sub>1</sub>: C, 74.10; H, 7.56; N, 2.34. Found: C, 74.18; H, 7.38; N, 2.34.

**Preparation of Cbz-BPA (9).** To an aqueous NaOH solution (15%, 10 mL) of (±)-BPA (4.33 g, 20.72 mmol) were added CbzCl (4.5 mL, 31.5 mmol) and aqueous NaOH (15%, 6 mL) at 0 °C, and the mixture was stirred for 5 h at room temperature. The resulting solution was extracted with ether to remove excess CbzCl. To the aqueous layer was added aqueous HCl (12 N, 12 mL) at 0 °C, and the product was extracted with three portions of ethyl acetate. The organic layers were washed with brine, dried over MgSO<sub>4</sub>, and concentrated *in vacuo* to give **9** as a white solid (6.99 g, 20.37 mmol, 98% yield): IR (KBr) 3300, 1725, 1685, 1610, 1565, 1365, 1275, 1240, 1160, 1125, 1055, 755, 700, 645 cm<sup>-1</sup>; <sup>1</sup>H-NMR (CD<sub>3</sub>OH) δ 7.59 (br, 2H, aromatics of -B-C(CH<sub>2</sub>)<sub>2</sub>C-), 7.15–7.35 (m, 7H, B-C(CH<sub>2</sub>)<sub>2</sub>C- and C<sub>6</sub>H<sub>5</sub>-), 5.05 (d, *J* = 12.8 Hz, 1H, C<sub>6</sub>H<sub>5</sub>-CH<sub>2</sub>-), 4.99 (d, *J* = 12.8 Hz, 1H, C<sub>6</sub>H<sub>5</sub>-CH<sub>2</sub>-), 4.33 (dd, *J* = 9.5, 5.0 Hz, 1H, HN-CH-CO<sub>2</sub>H), 3.20 (dd, *J* = 13.8, 5.0 Hz, -B-C<sub>6</sub>H<sub>4</sub>-CH<sub>2</sub>-), 2.93 (dd, *J* = 13.8, 9.5 Hz, 1H, -B-C<sub>6</sub>H<sub>4</sub>-CH<sub>2</sub>-); <sup>13</sup>C-NMR (CD<sub>3</sub>OD) δ 175.9 (C=O), 159.1, 141.3, 138.9, 135.7, 130.3, 130.2, 129.7, 129.4, 68.2 (HN-CH-CO<sub>2</sub>H), 57.4 (-B-C<sub>6</sub>H<sub>4</sub>-CH<sub>2</sub>-), 39.4 (C<sub>6</sub>H<sub>5</sub>-CH<sub>2</sub>-). Anal. Calcd for C<sub>17</sub>H<sub>18</sub>N<sub>1</sub>BO<sub>6</sub>: C, 59.50; H, 5.29; N, 4.08. Found: C, 59.48; H, 5.30; N, 4.18.

**Concentration of Cbz-BPA (9) with 7d.** A mixture of *N*-methyl-diethanolamine (1.6 mL, 13.9 mmol) and **9** (2.150 g, 6.27 mmol) was stirred for 10 min at room temperature in DMF (10 mL). To the mixture were added **7d** (2.036 g, 7.50 mmol), *N*-hydroxybenzotriazole (1.464 g, 9.56 mmol), and ethyl-*N,N*-(dimethyl-3-aminopropyl)carbodiimide (EDC) (1.529 g, 7.98 mmol), and the mixture was stirred for 13 h at room temperature. The resulting mixture was poured into an aqueous 3N HCl solution (75 mL), and the product was extracted with three portions of ethyl acetate. The combined organic layers were washed with brine, dried over MgSO<sub>4</sub>, and concentrated *in vacuo*. The residue was purified by silica gel column chromatography using chloroform/methanol (50/1) as an eluent, giving **12** as a white solid (3.540 g, 5.93 mmol, 95% yield): IR (KBr) 3300, 3040, 2880, 2360, 1700, 1655, 1610, 1520, 1420, 1385, 1260, 1100, 735, 700 cm<sup>-1</sup>; <sup>1</sup>H-NMR (CD<sub>3</sub>OD) δ 7.48 (d, *J* = 7.5 Hz, 2H, -B-C(CH<sub>2</sub>)<sub>2</sub>C-), 7.15–7.37 (m, 17H, -B-C(CH<sub>2</sub>)<sub>2</sub>C- and 3 × C<sub>6</sub>H<sub>5</sub>-), 5.03 (d, *J* = 12.4 Hz, 1H, C<sub>6</sub>H<sub>5</sub>-CH<sub>2</sub>-), 4.97 (d, *J* = 12.4 Hz, 1H, C<sub>6</sub>H<sub>5</sub>-CH<sub>2</sub>-), 4.35–4.51 (m, 5H, C<sub>6</sub>H<sub>5</sub>-CH<sub>2</sub>-, C<sub>6</sub>H<sub>5</sub>-CH<sub>2</sub>-, and -CH<sub>2</sub>-O-), 4.17 (m, 1H, C<sub>6</sub>H<sub>5</sub>-CH<sub>2</sub>-), 3.53 (d, *J* = 5.0 Hz, 2H, -CH<sub>2</sub>-O-), 3.43 (dd, *J* =

9.2, 5.0 Hz, 1H, -NDCH-), 3.34 (m, 1H, DN-CH-COND-), 3.04 (dd, *J* = 13.6, 6.8 Hz, 1H, -B-C<sub>6</sub>H<sub>4</sub>-CH<sub>2</sub>-), 2.86 (dd, *J* = 13.6, 8.1 Hz, 1H, -B-C<sub>6</sub>H<sub>4</sub>-CH<sub>2</sub>-). Anal. Calcd for C<sub>34</sub>H<sub>37</sub>N<sub>2</sub><sup>10</sup>BO<sub>7</sub>: C, 68.46; H, 6.25; N, 4.70. Found: C, 68.69; H, 6.04; N, 4.63.

**Synthesis of 5.** A mixture of **12** (4.10 g, 6.87 mmol), ethanol (40 mL), and an aqueous HCl solution (12 N, 2 mL) was stirred in the presence of suspended Pd(OH)<sub>2</sub>-C (2.50 g) for 37 h at room temperature under a hydrogen atmosphere. The resulting suspension was filtered to remove the palladium catalyst. The filtrate was concentrated *in vacuo*, giving a hydrogen chloride salt of **5**, which was passed through the Dowex 50W-X2 (50–100 mesh) cation exchange gel using water as an eluent to remove chloride anion, and then, an aqueous 1 N ammonium hydroxide solution was used as an eluent. The product was purified by HPLC (Shim-pack; PREP-ODS, 20.0 mm i.d. × 25 cm; flow rate = 5 mL/min, *t*<sub>R</sub> = 90 min, eluted with methanol/water = 1/9) to give **5** as a white solid (1.088 g, 3.86 mmol, 56% yield): IR (KBr) 3355, 3060, 2945, 1655, 1610, 1560, 1430, 1350, 1090, 930, 815, 665 cm<sup>-1</sup>; <sup>1</sup>H-NMR (D<sub>2</sub>O) δ 7.57 (d, *J* = 7.4 Hz, 2H, -B-C(CH<sub>2</sub>)<sub>2</sub>C-), 7.14 (d, *J* = 7.4 Hz, 2H, -B-C(CH<sub>2</sub>)<sub>2</sub>C-), 3.73 (m, 1H, ND-CH-), 3.62 (dd, *J* = 7.5, 6.3 Hz, 1H, D<sub>2</sub>N-CH-COND-), 3.49 (dd, *J* = 11.1, 5.0 Hz, -CH<sub>2</sub>-PO-), 3.39 (dd, *J* = 11.1, 6.1 Hz, -CH<sub>2</sub>-O-), 3.21 (d, *J* = 5.5 Hz, 2H, -CH<sub>2</sub>-O-), 2.90 (d, *J* = 13.1, 6.3 Hz, 1H, -BC<sub>6</sub>H<sub>4</sub>-CH<sub>2</sub>-), 2.82 (d, *J* = 13.1, 7.5 Hz, 1H, -BC<sub>6</sub>H<sub>4</sub>-CH<sub>2</sub>-); <sup>13</sup>C-NMR (CDCl<sub>3</sub>) δ 175.6, 138.8, 134.6, 129.9, 61.6, 57.0, 53.9, 40.8. Anal. Calcd for C<sub>12</sub>H<sub>19</sub>O<sub>5</sub>N<sup>10</sup>B·(H<sub>2</sub>O)<sub>-1.00</sub>: C, 54.75; H, 6.51; N, 10.64. Found: C, 54.83; H, 6.63; N, 10.65.

**Synthesis of 4.** A mixture of *N*-methyl-diethanolamine (1.9 mL, 16.55 mmol) and **9** (2.561 g, 7.46 mmol) was stirred for 10 min at room temperature in DMF (10 mL). To the mixture was added ethanolamine (0.50 g, 8.28 mmol), *N*-hydroxybenzotriazole (1.701 g, 11.11 mmol), and EDC (1.782 g, 9.30 mmol), and the mixture was stirred for 20 h at room temperature. The resulting mixture was poured into aqueous 3 N HCl (75 mL) solution, and the product was extracted with three portions of ethyl acetate. The combined organic layers were washed with brine, dried over MgSO<sub>4</sub>, and concentrated *in vacuo*. The residue was purified by a short silica gel column chromatography using chloroform/methanol (50/1) as an eluent. The product **11** was obtained as a white solid.

A solution of **11** dissolved in ethanol (100 mL) and aqueous HCl solution (12 N, 0.34 mL, 4.08 mmol) was stirred in the presence of suspended Pd(OH)<sub>2</sub>-C (2.50 g) for 1 h at room temperature under a hydrogen atmosphere. The usual workup gave crude product, which was purified by HPLC (Shim-pack; PREP-ODS, 20.0 mm i.d. × 25 cm; flow rate = 5 mL/min, eluted with methanol/water = 1/9) to give **4** as a white solid (1.088 g, 2.09 mmol, 28% yield): IR (KBr) 3355, 2400, 1650, 1560, 1430, 1385, 1350, 1055, 670 cm<sup>-1</sup>; <sup>1</sup>H-NMR (D<sub>2</sub>O) δ 7.62 (d, *J* = 7.4 Hz, 2H, -B-C(CH<sub>2</sub>)<sub>2</sub>C-), 7.18 (d, *J* = 7.4 Hz, 2H, -B-C(CH<sub>2</sub>)<sub>2</sub>C-), 3.65 (dd, *J* = 7.2, 6.9 Hz, 1H, D<sub>2</sub>N-CH-COND-), 3.45 (dt, *J* = 11.5, 5.9 Hz, 1H, -COND-CH<sub>2</sub>-), 3.37 (dt, *J* = 11.5, 5.9 Hz, 1H, -COND-CH<sub>2</sub>-), 3.15 (t, *J* = 5.9 Hz, 2H, -CH<sub>2</sub>-OD), 2.93 (dd, *J* = 13.8, 6.9 Hz, 1H, -BC<sub>6</sub>H<sub>4</sub>-CH<sub>2</sub>-), 2.87 (dd, *J* = 13.8, 7.2 Hz, 1H, -BC<sub>6</sub>H<sub>4</sub>-CH<sub>2</sub>-); <sup>13</sup>C-NMR (D<sub>2</sub>O) δ 175.4, 138.5, 133.5, 128.7, 59.7, 55.9, 41.0, 40.0. Anal. Calcd for C<sub>11</sub>H<sub>17</sub>O<sub>4</sub>N<sub>2</sub><sup>10</sup>B·(H<sub>2</sub>O)<sub>-0.29</sub>: C, 54.84; H, 6.47; N, 10.66. Found: C, 54.83; H, 6.63; N, 10.65.

**Synthesis of 6.** A mixture of *N*-methyl-diethanolamine (2.1 mL, 18.29 mmol) and **9** (2.852 g, 8.31 mmol) was stirred for 10 min at room temperature in DMF (10 mL). To the mixture were added **8d** (5.460 g, 9.10 mmol), *N*-hydroxybenzotriazole (1.913 g, 12.49 mmol), and EDC (1.995 g, 10.40 mmol), and the mixture was stirred for 20 h at room temperature. The resulting mixture was poured into an aqueous 3 N HCl solution (100 mL), and the product was extracted with three portions of ethyl acetate. The combined organic layers were washed with brine, dried over MgSO<sub>4</sub>, and concentrated *in vacuo*. The residue was purified by a short silica gel column chromatography using chloroform/methanol (30/1) as an eluent, giving **13**.

A mixture of **13**, ethanol (40 mL), and an aqueous HCl solution (12 N, 2 mL) was stirred in the presence of suspended Pd(OH)<sub>2</sub>-C (2.50 g) for 37 h at room temperature under a hydrogen atmosphere. The usual workup gave crude **6**. The

crude product was purified by HPLC (Shim-pack; PREP-ODS, 20.0 mm i.d.  $\times$  25 cm; flow rate = 5 mL/min, eluted with methanol/water = 1/9) to give **6** as a white solid (1.321 g, 3.068 mmol), 37% yield: IR (KBr) 3360, 2875, 2360, 1655, 1560, 1480, 1435, 1350, 1110, 1075, 820, 665  $\text{cm}^{-1}$ ,  $^1\text{H-NMR}$  ( $\text{D}_2\text{O}$ )  $\delta$  7.65 (d,  $J = 7.4$  Hz, 2H,  $-\text{B-C}(\text{CHCH})_2\text{C-}$ ), 7.20 (d,  $J = 7.4$  Hz, 2H,  $-\text{B-C}(\text{CHCH})_2\text{C-}$ ), 3.95 (m, 1H, ND- $\text{CH-}$ ), 3.73–3.69 (m, 15H,  $\text{D}_2\text{N-CH-COND-}$ ,  $-\text{CH}_2\text{-O-}$   $\times$  1,  $-\text{CH}_2\text{-O-}$   $\times$  5, and  $-\text{CH-O-}$   $\times$  3), 3.11 (dd,  $J = 10.1, 5.9$  Hz, 1H,  $-\text{CH}_2\text{-O-}$ ), 2.90 (d,  $J = 13.2, 5.6$  Hz, 1H,  $-\text{BC}_6\text{H}_4\text{-CH}_2\text{-}$ ), 2.82 (d,  $J = 13.2, 9.0$  Hz, 1H,  $-\text{BC}_6\text{H}_4\text{-CH}_2\text{-}$ );  $^{13}\text{C NMR}$  ( $\text{CDCl}_3$ )  $\delta$  175.6, 138.8, 133.7, 128.8, 127.0, 80.9, 68.6, 67.8, 60.5, 60.4, 60.2, 56.0, 49.0, 40.1. Anal. Calcd for  $\text{C}_{12}\text{H}_{19}\text{O}_5\text{N}^{10}\text{B}\cdot(\text{H}_2\text{O})_{-1.00}$ : C, 52.55; H, 7.10; N, 6.81. Found: C, 52.85; H, 6.93; N, 6.82.

**Water Solubility.** Enough amounts of the boron compounds were added to pure water. The mixture was stirred for 12 h at 20  $^\circ\text{C}$ , and a saturated solution of each boron compound was obtained. Undissolved boron compounds were filtered through a membrane filter. The concentration of boron atom of each saturated solution was obtained by using ICP-AES. Three replications of each experiment were carried out. Values are represented as mean  $\pm$  SE.

**Determination of Survival Ratio.** The boron compounds (70  $\mu\text{mol}$ ) were dissolved in 7 mL of Eagle-MEM medium. The mixture was filtered via a membrane filter and sterilized. The filtrate (3 mL) and the suspension of the cells in Eagle-MEM medium (10% FCS,  $1 \times 10^5$  cells/mL, 1 mL) were placed in a Falcon 3002 culture dish (60 mm diameter) and diluted with same medium to set the concentration of the boron compound at  $1.5 \times 10^{-2}$  M. The suspension was cultured for 3 days at 37  $^\circ\text{C}$  under a 5% carbon dioxide atmosphere. Skim of the resulting suspension was removed. The remaining cells were treated by trypsin, and the number of living cells was counted. The observed value was divided by the number of the standard system, in which no boron compound was added. Three replications of each experiment were carried out. Values are represented as mean  $\pm$  SE.

**Boron Incorporation into B-16 and TIG.** B-16 cells were cultured in Falcon 3025 dishes (150 mm diameter). When the cells were grown to fill the dish, the cell number was counted ( $5.0 \times 10^6$  cells/dish). One dish was for a control experiment. The boron compounds (2 mM) were added to the dishes. The cells were incubated for 3, 12, and 24 h at 37  $^\circ\text{C}$  under a 5% carbon dioxide atmosphere. After skim of the suspension was removed, the remaining cells were washed with three portions of Ca- and Mg-free phosphate-buffered saline (PBS(-); 4mL), collected by rubber policeman, digested with 7 mL of 60%  $\text{HClO}_4$ -30%  $\text{H}_2\text{O}_2$  solution, and decomposed for 1 h at 70  $^\circ\text{C}$ . After the filtration with a membrane filter (Millipore; 0.22  $\mu\text{m}$ ), the boron concentration was determined by using ICP-AES (Shimazu, ICP-1000-III). The boron concentration of the control experiment was subtracted from the boron concentrations of the cells of each dish. In the case of TIG-1-20 cells, a similar procedure was used. Three replications of each experiment were carried out. Values are represented as mean  $\pm$  SE.

## References

- Mishima, Y.; Ichihashi, M.; Hatta, S.; Honda, C.; Yamamura, K.; Nakagawa, T.; Obara, H.; Shirakawa, J.; Hiratsuka, J.; Taniyama, K.; Tanaka, C.; Kanda, K.; Kobayashi, T.; Sato, T.; Ishida, M. R.; Ujeno, Y.; Takahashi, M.; Abe, M.; Nozaki, T.; Aizawa, O.; Matsumoto, T.; Sato, T.; Karashima, H.; Yoshino, K.; Fukuda, H. First Human Clinical Trial of Melanoma Neutron Capture. Diagnosis and Therapy. *Strahlenther. Onkol.* **1989**, *165* (Nr. 2/3), 251–254. (b) Mishima, Y.; Honda, C.; Ichihashi, M.; Obara, H.; Hiratsuka, J.; Fukuda, H.; Karashima, H.; Kobayashi, T.; Kanda, K.; Yoshino, K. Treatment of Malignant Melanoma by Single Neutron Capture Treatment with Melanoma-seeking  $^{10}\text{B}$  Compound. *Lancet* **1989**, *11*, 388–389. (c) As an excellent review, see: Hawthorn, M. F. The Role of Chemistry in the Development of Boron Neutron Capture Therapy of Cancer. *Angew. Chem., Int. Ed. Engl.* **1993**, *32*, 950–984.
- In the past 15 years, Prof. Mishima and his co-workers have applied BNCT technology using **1** as a  $^{10}\text{B}$  carrier to more than 10 patients. It should be noted that BPA has been demonstrated not to be a substrate for tyrosine hydroxylase nor is BPA incorporated into melanin and that BPA is taken up also briskly into other cancers in which melanin is absent, most notably human glioblastoma.
- Mori, Y.; Suzuki, A.; Yoshino, K.; Kakihana, H. Complex Formation of p-Boronophenylalanine with Some Monosaccharides. *Pigm. Cell Res.* **1989**, *2*, 273–277.
- Although the acidic or basic salts of **1** were used previously, nowadays those salts have not been used clinically since injection of the salts causes serious pain in patients. Prof. Yutaka Mishima, Kobe University, private communication.
- Nemoto, H.; Wilson, G. J.; Nakamura, H.; Yamamoto, Y. Polyols of a Cascade Type as a Water-Solubilizing Element of Carborane Derivatives for Boron Neutron Capture Therapy. *J. Org. Chem.* **1992**, *57*, 435–436.
- König, W.; Geiger, R. Eine neue Methode zur Synthese von Peptiden: Aktivierung der Carboxylgruppe mit Dicyclohexylcarbodiimid unter Zusatz von 1-Hydroxy-benzotriazolonen. (New method for the synthesis of peptides: Activation of the carboxyl group with dicyclohexylcarbodiimide by using 1-hydroxybenzotriazolones as additives.) *Chem. Ber.* **1970**, *103*, 788–798. Racemisierung bei Peptidsynthesen *Ibid.* **1970**, *103*, 2024–2033.
- Nemoto, H.; Iwamoto, S.; Nakamura, H.; Yamamoto, Y. A New Water-soluble p-Boronophenylalanine for Boron Neutron Capture Therapy. *Chem. Lett.* **1993**, 465–468.
- Yamamoto, Y.; Seko, T.; Nemoto, H. A New Method for the Synthesis of Boron-10 Containing Nucleoside Derivatives for Neutron Capture Therapy via Palladium Catalyzed Reaction. *J. Org. Chem.* **1989**, *54*, 4734–4735. Yamamoto, Y.; Seko, T.; Rong, F.-G.; Nemoto, H. Boron-10 Carriers for NCT. A New Synthetic Method via Condensation with Aldehydes Having Boronic Moiety. *Tetrahedron Lett.* **1989**, *30*, 7191–7194.
- In general, it is difficult for normal cells to bear up against in vitro experiments, although tumor cells are strong enough in such experiments. We often use TIG cells, for the purpose of comparison, as a model of normal cells. (a) Yamamoto, Y.; Nakamura, H. 1-Carboranyl-3-methylaziridino-2-propanol. Synthesis, Selective Uptake by B-16 Melanoma, and Selective Cytotoxicity toward Cancer Cells. *J. Med. Chem.* **1993**, *36*, 2232–2234. (b) Yamamoto, Y.; Seko, T.; Nakamura, H.; Nemoto, H.; Hojo, H.; Mukai, N.; Hashimoto, Y. Synthesis of Carboranes Containing Nucleoside Bases. Unexpectedly High Cytostatic and Cytocidal Toxicity toward Cancer Cells. *J. Chem. Soc., Chem. Commun.* **1992**, 157–158.
- Prof. Mishima, Kobe University, private communication.
- Boron is contained in ordinary living organisms. Therefore, the cellular uptake can be clarified by using the ICP method, and the relationship can be elucidated.
- Perrin, D. D.; Armarego, W. L. F.; Perrin, D. R. *Purification of Laboratory Chemicals*, 2nd ed.; Pergamon Press: New York, 1987; p 224.

JM940683R