

PHENYL(TRIMETHYLSILYL)KETENE. SOME KETENE REACTIONS WITH DIAZOMETHANE

WILLIAM T. BRADY* and THERESA C. CHENG

Department of Chemistry, North Texas State University, Denton, Texas 76203 (U.S.A.)

(Received March 21st, 1977)

Summary

Phenyl(trimethylsilyl)ketene was prepared by the zinc dehalogenation of phenyl(trimethylsilyl)bromoacetyl chloride. This ketene parallels trimethylsilylketene in stability and lack of reactivity in cycloaddition reactions. The reaction of phenyl(ethyl)-, phenyl(trimethylsilyl)- and trimethylsilylketenes with diazomethane at -78°C is described. Only the 2/1 cycloadducts, the cyclobutanones, could be isolated.

Introduction

Lipp and Buckremer reported in 1932 that diazomethane added to ketene to yield the unstable cyclopropanone as a transient intermediate [1]. Turro and Hammond have more recently studied the reaction of methylketene and dimethylketene with diazomethane and reported that at -78°C the cyclopropanones were formed in high yield and that the unsymmetrical dimethylcyclopropanone was moderately stable at room temperature [2,3]. The cyclobutanone derivatives were obtained in the presence of excess diazomethane. A more recent communication described the addition of diazomethane to trimethylsilylketene and trimethylgermylketene at -130°C to yield the cyclopropanones and formation of the cyclobutanone at -78°C [4].

This paper relates the synthesis of phenyl(trimethylsilyl)ketene and describes the reaction of some ketenes with diazomethane.

Results and discussion

Phenyl(trimethylsilyl)ketene was prepared by the zinc dehalogenation of phenyl(trimethylsilyl)bromoacetyl chloride in THF. The ketene was isolated by vacuum distillation. It has the characteristic yellow color of ketenes and is very stable at room temperature.

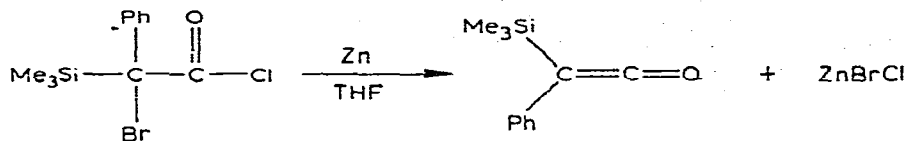

Phenyl(trimethylsilyl)bromoacetyl chloride was prepared by the reaction of phenyl(trimethylsilyl)acetic acid with oxalyl chloride to form the acid chloride and subsequent bromination. Attempts to isolate either of the acid chlorides were unsuccessful due to thermal decomposition. Phenyl(trimethylsilyl)acetyl chloride decomposes upon heating to two ketenes as evidenced by infrared bands at 2040 and 2053 cm^{-1} . The attempted triethylamine dehydrohalogenation of phenyl(trimethylsilyl)acetyl chloride was unsuccessful due to carbon-silicon bond cleavage.

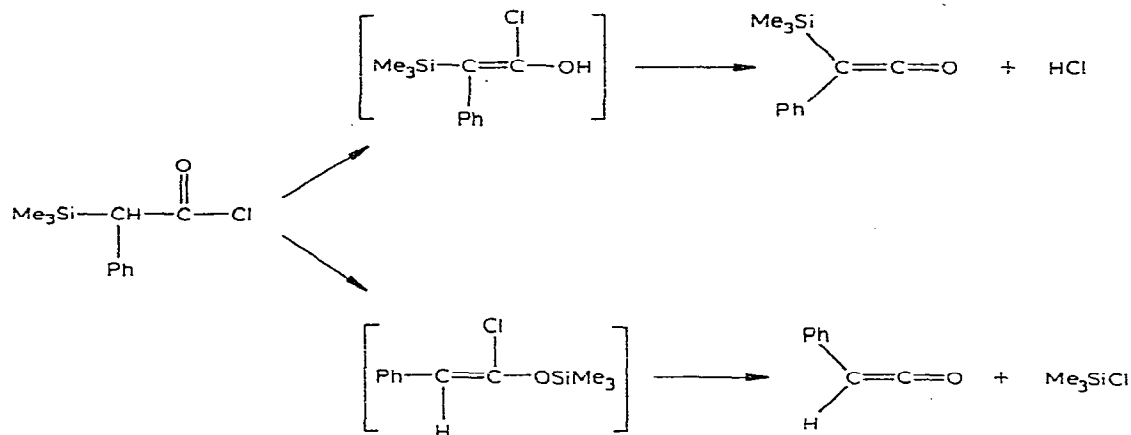

Phenyl(trimethylsilyl)ketene and trimethylchlorosilane could be isolated and the proposed phenylketene is known to readily undergo dimerization and polymerization upon heating. Apparently, the phenyl substituent on the trimethylsilylacetyl chloride favors the enol tautomers from which elimination occurs to yield the two ketenes.

Phenyl(trimethylsilyl)acetic acid was prepared from benzyltrimethylsilane by treatment with *n*-butyllithium, carboxylation and hydrolysis-

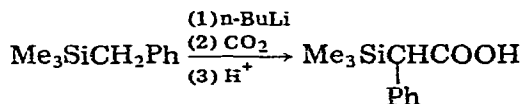

Attempts to synthesize phenyl(trimethylsilyl)acetic acid by several other methods were unsuccessful. The conversion of phenyl(trimethylsilyl)chloromethane into the corresponding Grignard reagent, followed by carboxylation and hydrolysis, yielded mainly polymer. The Grignard reagent was formed with much difficulty and was unusually reactive. Also, the treatment of phenyl(trimethylsilyl)chloromethane with metallic lithium, with subsequent carboxylation and hydrolysis, yielded no acid, only polymer.

Numerous efforts to effect dimerization of the isolated phenyl(trimethylsilyl)ketene and cycloaddition with reactive unsaturated compounds were unsuccessful. However, the attempted in situ cycloaddition of phenyl(trimethyl-

silyl)ketene with *N*-*t*-butylbenzylimine resulted in the formation of the non-silylated cycloadduct, *N*-*t*-butyl-3,4-diphenyl-2-azetidinone. The isolated phenyl(trimethylsilyl)ketene and the imine do not react under the reaction conditions and neither do the acid halide and the imine. Therefore, this cyclo-

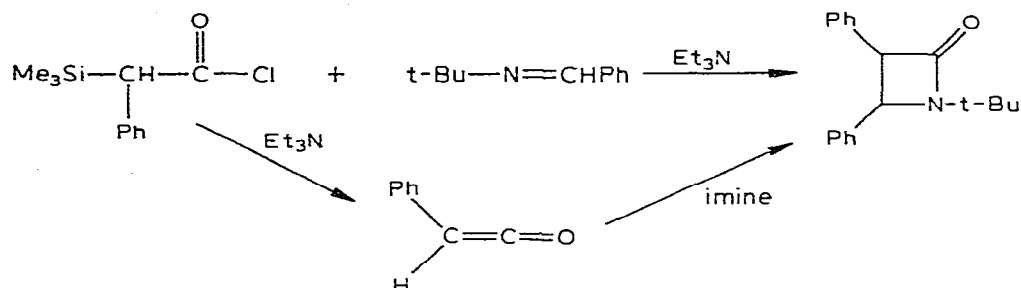

adduct is apparently the result of the action of triethylamine on the acid halide to yield phenylketene and subsequent cycloaddition with the imine to form the azetidinone.

Phenyl(ethyl)ketene was used as a control or standard for the reactions with diazomethane. The reaction of this ketene with diazomethane at -78°C in methylene chloride resulted in the isolation of only the 1/2 cycloadducts, the cyclobutanones, in good yield. When either an excess of the ketene or of diazomethane was employed, the same cyclobutanones were obtained. The two cyclobutanones were produced in approximately equal amounts. This suggests

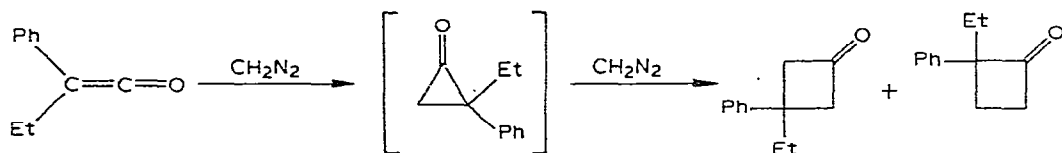

that the intermediate cyclopropanone is much more reactive toward diazomethane than the ketene.

Phenyl(trimethylsilyl)ketene was treated with diazomethane under the same reaction conditions as those used for phenyl(ethyl)ketene. An infrared spectrum of the cold reaction solution indicated that the cyclobutanones had been formed in good yield. 3-Phenyl-3-trimethylsilylcyclobutanone and 2-phenyl-3-trimethylsilylcyclobutanone were produced in approximately equal amounts and isolated

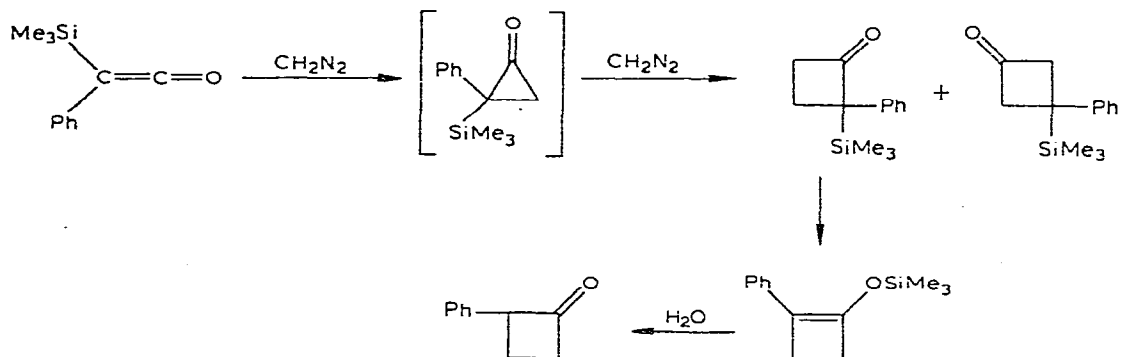

by GLC, but they decomposed on attempted distillation. The loss of the trimethylsilyl substituent from the 2-phenylcyclobutanone is not too surprising since it is well known that a trimethylsilyl substituent adjacent to a carbonyl group is a thermally unstable structure which rearranges to yield the readily hydrolyzable trimethylsilyl vinyl ether. The *O*-silylated isomer in our reaction is probably readily hydrolyzed by atmospheric moisture to 2-phenylcyclobutanone.

In the reaction of trimethylsilylketene and diazomethane, a mixture of products was obtained as evidenced by GLC. 3-Trimethylsilylcyclobutanone was isolated by GLC and cyclobutanone was among the other products in the

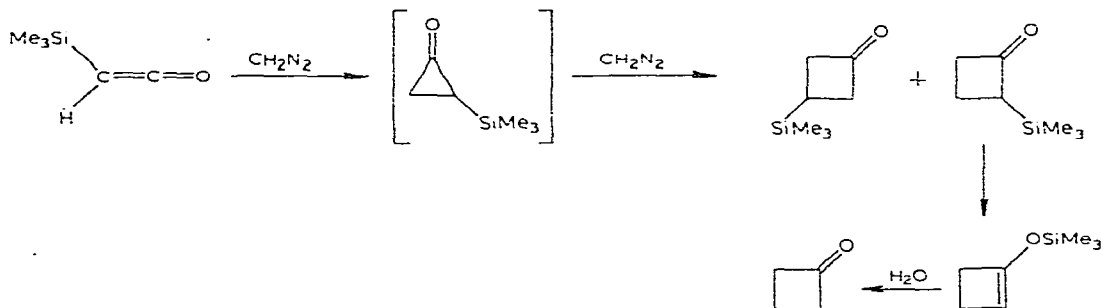

reaction mixture. Apparently, the trimethylsilyl substituent migrates to the oxygen as described above and loss of the trimethylsilyl moiety yields the unsubstituted cyclobutanone.

Experimental

Proton NMR spectra were recorded on a Jeolco PS-100 nuclear magnetic resonance spectrometer employing chloroform as the solvent and either chloroform or the trimethylsilyl substituent as internal standard. GLC was done on an F & M Scientific Model 700 gas chromatograph with a 10 ft. \times $\frac{1}{8}$ in. column packed with 10% SE-30 on an acid-washed Chromosorb W (80/100) support. The infrared spectra were recorded on a Beckman 320 and Perkin-Elmer Model 237 Grating Infrared Spectrometer. Mass spectra were obtained on Hitachi Perkin-Elmer RMU-6E Double Focusing Mass Spectrometer.

Ether was dried and purified by distillation from potassium sodium alloy prior to use. Triethylamine was commercially available and was dried over sodium metal and distilled prior to use. Benzyltrimethylsilane was obtained from the reaction of benzylmagnesium chloride and trimethylchlorosilane [5]. *N*-*t*-Butylbenzylimine was prepared from benzaldehyde and *t*-butylamine [6]. Phenyl(ethyl)ketene was prepared by the dehydrohalogenation of 2-phenylbutanoyl chloride with triethylamine in benzene solution [7]. Trimethylsilylketene was prepared from trimethylsilylethoxyacetylene [8].

Phenyl(trimethylsilyl)acetic acid. To a solution of 0.1 mol of benzyltrimethylsilane in 200 ml of anhydrous ether was added 75 ml of 1.6 *M* (0.12 mol) *n*-butyllithium dropwise over a 1 h period at 0°C under a nitrogen atmosphere. After the addition was complete, the reaction mixture was stirred at room temperature for 20 h. Dry carbon dioxide gas was bubbled into the

solution which had turned orange-brown until the color disappeared. A dilute hydrochloric acid solution was added with stirring to acidify the reaction solution. The ether layer was separated and the aqueous solution extracted with the original ether solution. This solution was dried over anhydrous magnesium sulfate and then the ether removed by evaporation. Upon standing overnight in the refrigerator, the acid crystallized from the residue and was purified by sublimation at 40°C at 0.05 mmHg to yield 12 g (58%); m.p. 117–118°C, IR, 1688, 3000 cm^{-1} ; NMR, δ 0.00 (s, 9H), 3.30 (s, 1H), 7.10 (s, 5H), and 12.30 ppm (s, 1H); mass spectrum parent peak at m/e 208 (theory 208).

Anal. Found: C, 63.18; H, 7.83. $\text{C}_{11}\text{H}_{16}\text{O}_2\text{Si}$ calcd.: C, 63.46; H, 7.69%.

Phenyl(trimethylsilyl)acetyl chloride. To a solution of 3 g (0.015 mol) of phenyl(trimethylsilyl)acetic acid in 30 ml of CCl_4 was added 3.5 g (0.03 mol) of oxalyl chloride with stirring at room temperature. The reaction mixture was stirred for an additional 2 h until gas ceased to be evolved. Attempts to isolate this compound were unsuccessful due to thermal decomposition, but NMR and IR spectra were obtained on the reaction solution; IR, 1785 cm^{-1} ; NMR, δ 0.00 (s, 9H), 3.76 (s, 1H) and 6.96 ppm (s, 5H).

Phenyl(trimethylsilyl)bromoacetyl chloride. To the phenyl(trimethylsilyl)acetyl chloride solution was added 2 g (0.012 mol) of bromine and the reaction solution was stirred at room temperature for 10 h. This compound was not isolated, but IR and NMR data were obtained; IR, 1790 cm^{-1} ; NMR, δ 0.00 (s, 9H), and 7.10 ppm (s, 5H).

Phenyl(trimethylsilyl)ketene. The phenyl(trimethylsilyl)bromoacetyl chloride solution described above was concentrated by rotatory evaporation and added to a stirred mixture of 1 g of activated zinc [9] and 30 ml of dry tetrahydrofuran. After the addition, the reaction mixture was stirred under nitrogen at room temperature for an additional 2 h. The solvent was removed and the residue washed with dry hexane. The zinc salt was removed, and the hexane evaporated. The ketene was distilled at 60°C at 2 mmHg (41% based on 3 g of phenyl(trimethylsilyl)acetic acid); IR, 2085 cm^{-1} ; NMR, δ 0.00 (s, 9H), and 7.10 ppm (s, 5H); mass spectrum parent peak at m/e 190 (theory 190).

Anal. Found: C, 69.66; H, 7.41. $\text{C}_{11}\text{H}_{14}\text{OSi}$ calcd.: C, 69.46; H, 7.36%.

The Reaction of Phenyl(trimethylsilyl)acetyl chloride, triethylamine and N-t-Butylbenzylimine. A solution containing 3.2 g (0.02 mol) of *N-t*-butylbenzylimine, 0.02 mol of phenyl(trimethylsilyl)acetyl chloride and 2 g (0.02 mol) of triethylamine in 60 ml of CCl_4 was refluxed for 2 h. The amine salt was removed by filtration and the solvent was evaporated. The residue was distilled at 100°C at 0.1 mmHg and on standing the distillate crystallized to yield 2.5 g (46%) of the non-silylated cycloadduct which consisted of a mixture of *cis*- and *trans*-*N-t*-butyl-3,4-diphenyl-2-azetidinone. The *trans* isomer could be separated from the *cis* isomer by sublimation at 60°C at 0.05 mmHg; m.p. 104°C (*trans* isomer); IR, 1790 cm^{-1} ; NMR (*trans* isomer), δ 1.30 (s, 9H), 4.55 (d, 1H, J 3 Hz), 4.9 (d, 1H, J 3 Hz), and 6.87 (s, 5H), 6.92 (s, 5H); (*cis* isomer), 1.3 (s, 9H), 3.84 (d, 1H, J 7 Hz), 4.38 (d, 1H, J Hz), 7.14 (s, 5H), and 7.26 (s, 5H); mass spectrum parent peak at m/e 279 (theory 279).

Anal. Found: C, 81.75; H, 7.64.

General procedure for diazomethane reaction with ketenes. To 0.01 mol

of ketene in 30 ml of methylene chloride was added 0.03 mol of diazomethane [10] in methylene chloride at -78°C with stirring. The reaction solution was allowed to warm to room temperature and stirred overnight. The solvent was removed under reduced pressure and the product vacuum distilled.

Reaction of phenylethylketene with diazomethane. Approximately an equal mixture of cyclobutanones, b.p. $65-70^{\circ}\text{C}$ at 0.05 mmHg, was obtained from this reaction in 84% yield. Separation by GLC revealed the presence of 2-ethyl-2-phenylcyclobutanone, IR, 1795 cm^{-1} ; NMR, δ 0.8 (t, 3H), 1.9 (q, 2H), 2.1–2.5 (two sets of t, 2H), 2.9–3.2 (m, 2H), and 7.10 ppm (s, 5H); mass spectrum parent peak at m/e 174 (theory 174).

Anal. Found: C, 82.70; H, 8.15. $\text{C}_{12}\text{H}_{14}\text{O}$ calcd.: C, 83.76; H, 8.05%.

The other cyclobutanone also was purified by collection by GLC and identified as 3-ethyl-3-phenylcyclobutanone; IR, 1795 cm^{-1} ; NMR, δ 0.75 (t, 3H), 1.85 (q, 2H), 2.80 (m, 4H), and 7.15 ppm (s, 5H); mass spectrum parent peak at m/e 174 (theory 174).

Reaction of phenyl(trimethylsilyl)ketene with diazomethane. GLC analysis of the vacuum distillate revealed two major components along with some low boiling components and some polymeric material. 3-Phenyl-3-trimethylsilylcyclobutanone was collected by GLC and estimated to be produced in about 20% yield; IR, 1780 cm^{-1} ; NMR, δ 0.00 (s, 9H), 3.33 (s, 4H), and 7.10 ppm (s, 5H); mass spectrum parent peak at m/e 268 (theory 268).

A non-silylated adduct 2-phenylcyclobutanone, was also purified by collection by GLC and estimated to be produced in about 20% yield; IR, 1790 cm^{-1} ; NMR, δ 1.8–2.7 (m, 2H), 2.7–3.3 (m, 2H), 4.3 (d-d, 1H), and 7.12 ppm (s, 5H); mass spectrum parent peak at m/e 146 (theory 146) [11].

Reaction of trimethylsilylketene with diazomethane. Several products were produced in this reaction as evidenced by GLC analysis of the vacuum distillate. 3-Trimethylsilylcyclobutanone was isolated by GLC; IR, 1790 cm^{-1} ; NMR, δ 0.00 (s, 9H), 1.1–1.8 (m, 1H), and 2.7–3.3 ppm (m, 4H); mass spectrum parent peak at m/e 142 (theory 142).

Acknowledgments

The authors wish to express appreciation to the Robert A. Welch Foundation and the North Texas State University Faculty Research Fund for support of this investigation.

References

- 1 P. Lipp, J. Buckremer and H. Seeles, *Ann. Chem.*, 499 (1932) 1.
- 2 N.J. Turro and W.B. Hammond, *J. Amer. Chem. Soc.*, 88 (1966) 2880 and 3672.
- 3 N.J. Turro and W.B. Hammond, *Tetrahedron*, 24 (1968) 6017.
- 4 G.S. Zaitseva, G.S. Bogdanova, Yu. I. Baukov and I.F. Lutsenko, *J. Organometal. Chem.*, 121 (1976) C21.
- 5 H. Gilman and F.J. Marshall, *J. Amer. Chem. Soc.*, 71 (1949) 2066.
- 6 L.A. Bigelow and H. Eatough, *Org. Syn., Coll. Vol. I*, (1946) 80.
- 7 W.T. Brady and E.D. Dorsey and F.H. Parry, III, *J. Org. Chem.*, 34 (1969) 2846.
- 8 R.A. Ruden, *J. Org. Chem.*, 39 (1974) 3607.
- 9 C.R. Hauser and D.S. Breslow, *Org. Syn., Coll. Vol. III*, (1955) 408.
- 10 F. Arndt, *Org. Syn., Coll. Vol. II*, (1946) 165.