

High-Pressure Effect on One- and Two-Photon-Excited Fluorescence of Organic Molecules in Solid Polymers[†]

Z. A. Dreger, G. Yang, J. O. White, Y. Li, and H. G. Drickamer*

School of Chemical Sciences, Department of Physics and The Frederick Seitz Materials Research Laboratory, University of Illinois, S. Mathews Avenue, Urbana, Illinois 61801-3792

Received: July 3, 1997; In Final Form: September 26, 1997[⊗]

We report the pressure effect on one- and two-photon-excited fluorescence from three organic molecules dissolved in solid polymers. The molecules studied are 4-(*p*-nitrophenyl)-3,4-dihydropyrazo[*c*]benzo[*b*]morpholine (NDPB), 1-phenyl-3-nitrophenylpyrazoline (PNP), and bis[4-(dimethylaminophenyl)]methylid ammonium chloride—Auramine O (AO). All these molecules exhibit strong fluorescence when subjected to visible or infrared laser light. We determine the pressure dependencies of fluorescence intensity, as well as energy and lifetime of the emitting state for one- and two-photon excitation. The pressure dependence of the last two parameters reveals that the fluorescence, for all molecules, originates in the same state regardless of the mode of excitation. In contrast to this, the emission intensity may change with pressure differently for one- and two-photon excitation. We introduce a parameter defined as a ratio of the emission intensity following two-photon excitation to the emission intensity following one-photon excitation ($(I_2(p)/I_1(p))$). This parameter, with increasing pressure, shows almost no change for NDPB but a significant decrease for AO and PNP. Thus we postulate that absorption transitions may proceed for one- and two-photon excitation to the same state in NDPB but to different states in AO and PNP. Moreover, for AO and PNP, the two locally excited states for both modes of excitation may relax through different pathways to the same emitting state. In the case of NDPB and PNP, a large Stokes shift indicates that the emitting state has a distinctly different charge distribution than the initially excited state and that this distribution is strongly pressure dependent.

1. Introduction

Modern technologies such as high density optical data storage, optical communication, and optical sensing increasingly require methods and materials for efficient conversion of coherent near-infrared radiation to visible light. The most common method of frequency up-conversion is a use of second or third harmonic generation. Another possible method for such frequency conversion is multiphoton-excited fluorescence, especially two-photon. This process does not require phase matching and can provide a broad range of frequency tuning. An optical material exhibits two-photon-excited fluorescence when its appropriate nonlinear absorption coefficients are sufficiently large and the emission efficiency is reasonably high. Frequently, two-photon excitation fluorescence is also employed as an alternative approach to determining the two-photon absorption (TPA) cross section (see e.g. refs 1–6).

There has been extensive research in the area of two-photon absorption in aromatic molecules (see e.g. refs 7–12). The main progress has been made in theory and experiment of TPA and has been devoted to finding and describing electronic states which are symmetry forbidden to one-photon spectroscopy. For polar molecules with low or no symmetry the one-photon allowed transitions very often show nonnegligible two-photon intensities due to the excited-state vibronic perturbations and/or due to a significant change in dipole moment with excitation.^{13,14} The very molecules which reveal especially large TPA

cross sections may be attractive for number of unique applications in photonics and biophotonics.^{15,16}

Recently we have reported a strong fluorescence excited by one or two-photon absorption in an organic crystal composed of noncentrosymmetric molecules.^{17,18} By introducing the pressure parameter, we concluded that the two-photon-excited state in crystalline NDPB (4-(*p*-nitrophenyl)-3,4-dihydropyrazo[*c*]benzo[*b*]morpholine) relaxes into the same state as the one-photon-excited state, from which radiative emission is subsequently observed. The emitting state had a different charge distribution than the exciting state and revealed a remarkable pressure tunability by significantly shifting its energy and decreasing efficiency. However, these two parameters showed the same pressure dependence regardless of the mode of excitation, providing further evidence for absorption and emission photophysics being independent of the excitation mechanism in crystalline NDPB.

In this paper we continue our high-pressure studies on one- and two-photon-excited fluorescence of polar organic molecules with evident electron donor–acceptor properties (e.g. refs 19 and 20). These types of molecules very likely exhibit energetically close excited states with different charge transfer distribution. Here we are concerned with the fluorescence properties of molecules dissolved in polymeric media. Our investigation involves three polar molecules: previously studied NDPB, PNP (1-phenyl-3-nitrophenylpyrazoline, AO (bis[4-(dimethylaminophenyl)]methylid ammonium chloride, a cationic dye—Auramine O) (see Figure 1). Because these molecules possess different molecular symmetries one would expect that one- and two-photon-excited fluorescence in each case could exhibit different features. We show that this supposition is true for the molecules studied. On the basis of the pressure effect

[†] This work was supported in part by the Department of Energy, Division of Materials Science grant DEFG02-96R45439 through the University of Illinois at Urbana-Champaign, Frederick Seitz Materials Research Laboratory.

* To whom correspondence should be sent.

[⊗] Abstract published in *Advance ACS Abstracts*, November 15, 1997.

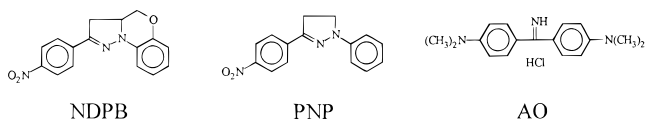

Figure 1. Molecular structure of NDPB, PNP, and AO.

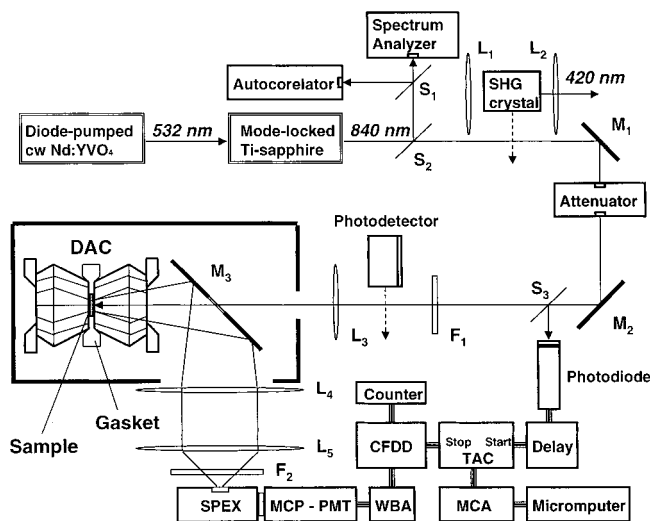

Figure 2. Diagram of the experimental setup. DAC, diamond anvil cell; M_1 , M_2 , M_3 (with a hole), mirrors; L_1 to L_5 , lenses; S_1 to S_3 , beam splitters; F_1 - long-wavelength band-pass filter; F_2 , short-wavelength band-pass filter; SPEX, spectrometer; MCP-PMT, microchannel plate-photomultiplier tube; WBA, wideband amplifier; CFDD, constant fraction differential discriminator; counter, photon counter; TAC, time-to-amplitude converter; MCA, multichannel pulse-height analyzer.

on time-averaged and time-resolved fluorescence characteristics we propose a kinetic model for fluorescent processes to draw conclusions on: (i) pressure-induced changes in the absorbing and emitting state and (ii) differences in the relaxation pathways for the one- and two-photon excited state.

2. Experiment

NDPB and PNP, derivatives of pyrazoline, were synthesized according to the general method described elsewhere.²¹ AO was obtained from the Aldrich Chemical Co. Before using, AO was purified by several recrystallizations from ethanol and vacuum sublimations. NDPB and PNP were dissolved in poly(methyl methacrylate), PMMA, using methylene chloride as a solvent. AO was dissolved in poly(acrylic acid) using methanol. In all cases concentrations of 10^{-4} mol/mol (mole of compound per mole of the monomeric unit of the polymer) were prepared. The solvent was allowed to evaporate slowly at room temperature. The transparent films were then placed in a vacuum oven for a few days at ~ 50 °C. The thickness of the films was estimated to be (50–80) μm .

High pressure is generated in a gasketed Merrill-Bassett type diamond anvil cell (DAC). The diamonds are of the modified brilliant design and have 0.6 culets with 16 facets on the both the table and culet. The samples and a small chip of ruby are placed in the 0.3 mm diameter hole of an Inconel alloy gasket. Light mineral oil serves as a pressure medium. Pressure is determined by monitoring the shift of the R_1 fluorescence line from a ruby chip. A cw He–Cd laser line at 441.6 nm is used to pump the ruby.

The experimental setup is shown schematically in Figure 2. Two-photon excitation is by an 76-MHz mode-locked titanium-sapphire (Ti– Al_2O_3 or Ti-sapphire) laser (Tsunami, Spectra-Physics) pumped by the second harmonic of a diode-pumped Nd:YVO₄ laser (Millennia, Spectra-Physics). The Ti-sapphire

laser pulse width is monitored by an autocorrelator, and the pulse repetition is measured with a fast photodiode. A spectrum analyzer measures the excitation wavelength and line width. The latter is essential because cw radiation can be produced along with the subpicosecond pulses. Typical parameters of the Ti– Al_2O_3 laser used in our experiments are $\lambda = 840$ nm (excitation wavelength), $P_{\text{av}} \sim 100$ mW (average power), and $\tau \sim 100$ fs (pulse width). Intensity of the incident light is controlled and changed by an attenuator and focusing lens (L_3). A long-wavelength pass filter (F_1) is inserted before the sample to eliminate any light except the excitation beam. In the case of one-photon excitation we use either a second harmonic from the Ti-sapphire laser generated with a BBO crystal at 420 nm or a cw He–Cd laser at 441.6 nm. The front-side excited fluorescence is reflected on the mirror (M_3) and collected by a telecentric system of two biconvex UV lenses. A colored glass filter (F_2) is placed in front of the entrance slit of the spectrometer to block the scattered pump light. Fluorescence is dispersed with an 0.25 m spectrometer and detected by a microchannel plate photomultiplier tube (MCP–PMT) coupled to a single-photon time-resolved system. The “start signal” from the MCP–PMT is amplified and then timed using an Ortec Model 583 constant fraction differential discriminator (CFDD). This gives an overall instrumental pulse full width at half-maximum (fwhm) of 60 ps at 840 nm. A Tennelec Model 184 is used to perform the time-to-amplitude conversion (TAC). The synchronized “stop signal” for timing comes from a fast silicon photodiode. A PC based multichannel pulse-height analyzer (MCA) is used to accumulate time-resolved data. These data as well as the spectra are displayed by a computer. The spectrometer grating with grid of 600 lines/mm is moved by a stepper motor. The fluorescence spectra are corrected for the sensitivity of the spectrometer grating, photocathode of PMT, and transmission of the F_2 filter.

One-photon absorption measurements in the range of $(12\text{--}32) \times 10^3$ cm^{-1} are performed with a 150 W tungsten–halogen lamp, a Kratos monochromator and an EMI PMT with an Ortec photon-counting system. Fiber optics are used to direct the light to the DAC and from the DAC to the detector. The data are extracted point by point by a computer on-line.

3. Results

3.1. Absorption and Emission Spectra. Figure 3 presents the one-photon absorption spectra of three chromophores in polymers at atmospheric and high pressure (50 kbar). In the range of $(16\text{--}32) \times 10^3$ cm^{-1} , where diamonds transmit the light well, all samples show strong absorption transitions. At atmospheric pressure, both NDPB and PNP exhibit one absorption band with a maximum located respectively at 23.5×10^3 and 22.0×10^3 cm^{-1} . The difference between absorption peaks for these molecules may indicate better π electron conjugation in PNP than NDPB. With increasing pressure three features in the absorption of these molecules are observed: (i) a shift of the peak to lower energies ($\sim 2.5 \times 10^3$ cm^{-1} for NDPB and 1.5×10^3 cm^{-1} for PNP), (ii) clear appearance of a second absorption peak in the case of PNP, (iii) some decrease in the optical density (note that in Figure 3 spectra at different pressures are normalized to the same maximum value). In contrast to the above molecules, AO in PAA already shows at atmospheric pressure at least two absorption peaks. At 50 kbar, there is only one broad peak with a maximum coinciding with the position of the high energy peak observed at atmospheric pressure. Since, we do not resolve the peaks from the broad absorption band the position of peaks at high pressure cannot be determined. Nevertheless, from the shape of absorption

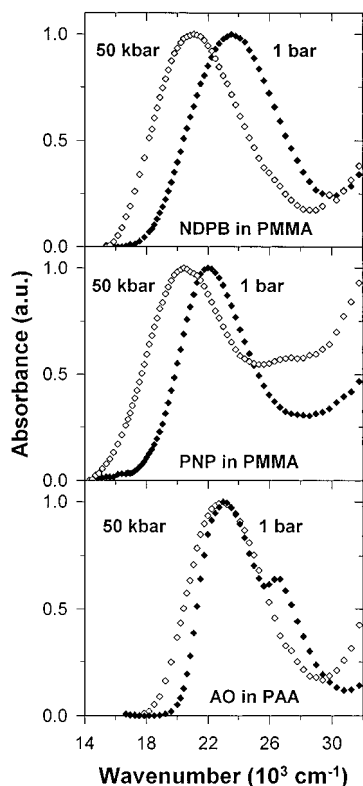

Figure 3. Normalized one-photon absorption spectra of studied molecules at atmospheric pressure and at 50 kbar.

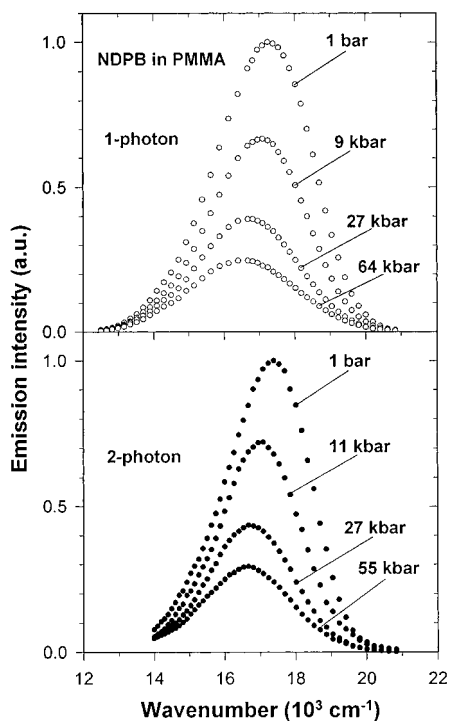

Figure 4. Effect of pressure on spectra of one- and two-photon-excited fluorescence of NDPB in PMMA.

spectrum one concludes extended overlap of at least two bands. It indicates that pressure shifts the high energy peak to lower energies much more strongly than it does the lower energy peak.

One-photon excitation of NDPB and PNP in PMMA and AO in PAA within the main absorption band induces strong fluorescence (see Figures 4–6, upper part). In all cases fluorescence spectra consist of a broad and smooth band with one maximum. In the case of NDPB and PNP, despite the significant difference in the position of absorption peaks, the

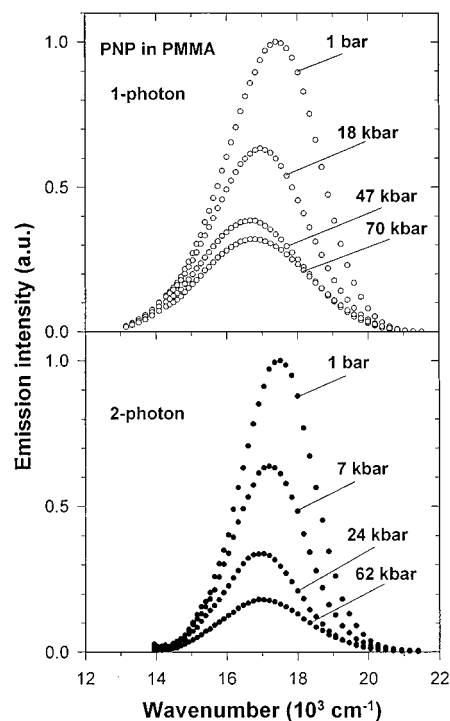

Figure 5. Effect of pressure on spectra of one- and two-photon-excited fluorescence of PNP in PMMA.

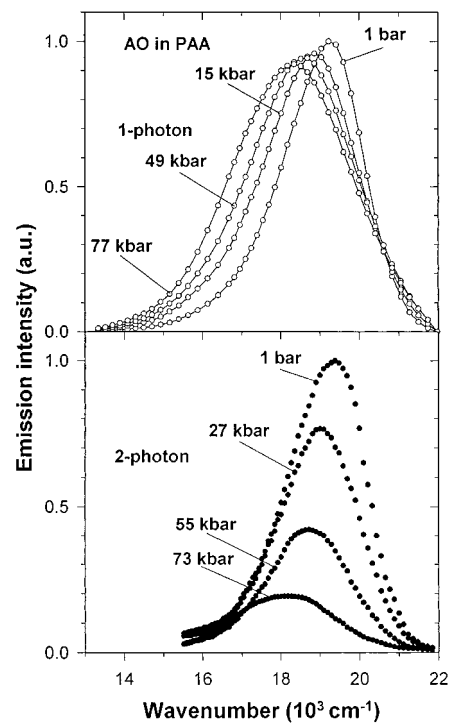

Figure 6. Effect of pressure on spectra of one- and two-photon-excited fluorescence of AO in PAA.

emission maxima of these molecules at 1 atm appear almost at the same energy; $17.3 \times 10^3 \text{ cm}^{-1}$ (NDPB) and $17.4 \times 10^3 \text{ cm}^{-1}$ (PNP). The emission from AO appears, however, at much higher energy ($19.2 \times 10^3 \text{ cm}^{-1}$) than that from the above molecules.

All compounds studied are transparent below $14 \times 10^3 \text{ cm}^{-1}$ ($\sim 715 \text{ nm}$); thus, they do not absorb directly any near-infrared light. However, due to multiphoton absorption these compounds show an efficient emission following the intense laser illumination at 840 nm. The intensity of this emission depends essentially quadratically (see e.g. NDPB in Figure 7) on the

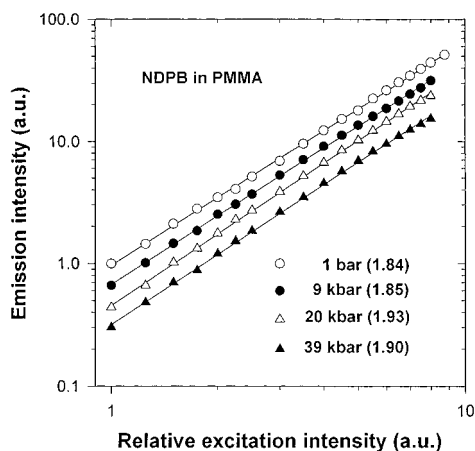

Figure 7. Log-log plot of two-photon-excited fluorescence intensity versus excitation intensity for NDPB in PMMA at several pressures.

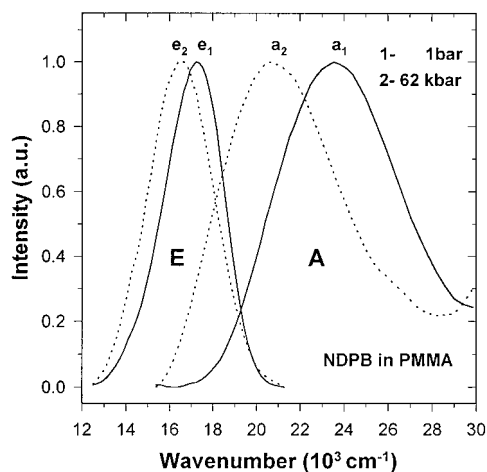

Figure 8. One-photon-excited emission and absorption spectra of NDPB in PMMA at atmospheric pressure (solid line) and 62 kbar (dashed line). A, absorption; E, emission.

peak intensity of the pump laser, indicating two-photon absorption. The exponent is almost pressure independent. The spectra of two-photon excitation of the three molecules are displayed in Figures 4–6 (lower graphs). At atmospheric pressure these spectra are very similar to the spectra excited by one-photon absorption. A comparison of the upper and lower graphs at 1 bar reveals that for both excitations: (i) the fluorescence peak is located at the same energy, (ii) spectral shapes are similar but the fluorescence bandwidth (fwhm) is a few hundreds of cm^{-1} narrower in the case of TPA than OPA, mainly due to a stronger reabsorption effect in the former case. With increasing pressure, in general, all emission spectra show lower intensity and a shift of the peak to lower energies. It should be noticed that in the case of AO in PAA the integrated emission intensity with pressure, in fact, increases due to some broadening of the emission peak. For all three molecules, the emission peaks are much less shifted to lower energy than the corresponding absorption peaks. This results in a pressure-induced decrease of the Stokes shift. This feature is shown for example for NDPB in PMMA in Figure 8 and will be discussed later. Since the absorption spectra for AO are complex the Stokes shift can only be approximated. There is a modest increase followed by a decrease. All of these Stokes shifts are exhibited in Figure 9.

3.2. Absorbing and Emitting States under Pressure. To characterize the emitting state induced by OPA and TPA the energy and lifetime of one-photon-excited fluorescence (OPEF) and two-photon-excited fluorescence (TPEF) under high pressure conditions are measured. The energy is determined from

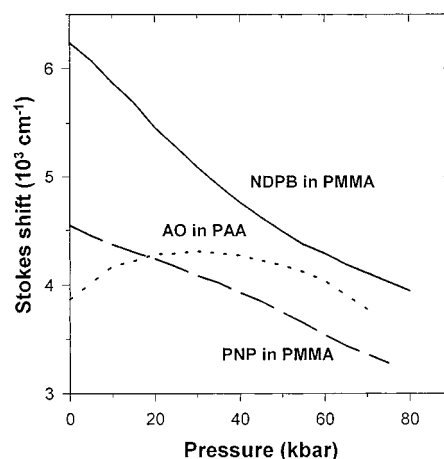

Figure 9. Pressure dependence of the Stokes shift in NDPB and PNP in PMMA and AO in PAA.

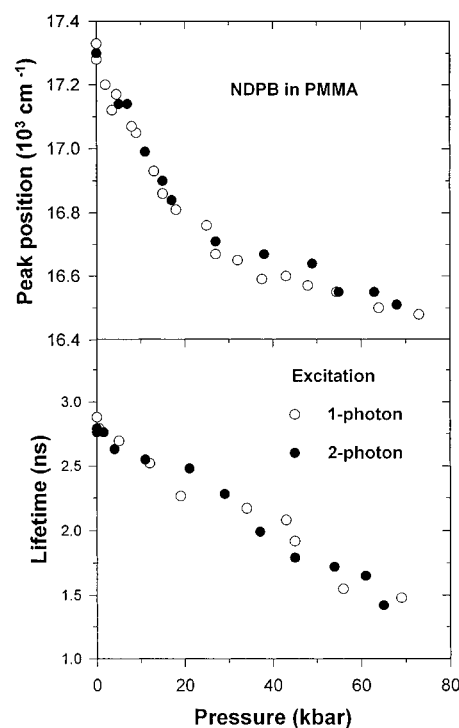

Figure 10. Pressure dependence of the energy and lifetime of the emitting state of NDPB in PMMA following one- and two-photon excitation.

the spectra and lifetime from the time-resolved experiments. For the samples studied, at all pressures the emission intensity exhibits a single exponential decay, indicating that only one excited-state participates in the emission. The above results for two types of excitation, for three molecules are combined in Figures 10–12. With increasing pressure several features can be observed: (i) a moderate decrease of the emitting state energy (800 cm^{-1} for NDPB, 600 cm^{-1} for PNP and 600 cm^{-1} for AO), (ii) a reversal of energy shift (from red to blue) for PNP in PMMA above 40 kbar, (iii) a decrease in lifetime for NDPB (from 2.8 to 1.5 ns within 70 kbar) and for PNP (from 3.6 to 2.5 ns within 80 kbar), (iv) for the lifetime of AO in PAA, an initial gradual increase (about 25%) and then above 40 kbar a decrease of about the same amount as the increase. The most characteristic feature of these results is that the energy as well as the lifetime of the emitting state changes with pressure in the same fashion following either one or two-photon excitation. This is strong evidence that for both excitations, fluorescence takes place from the same excited state.

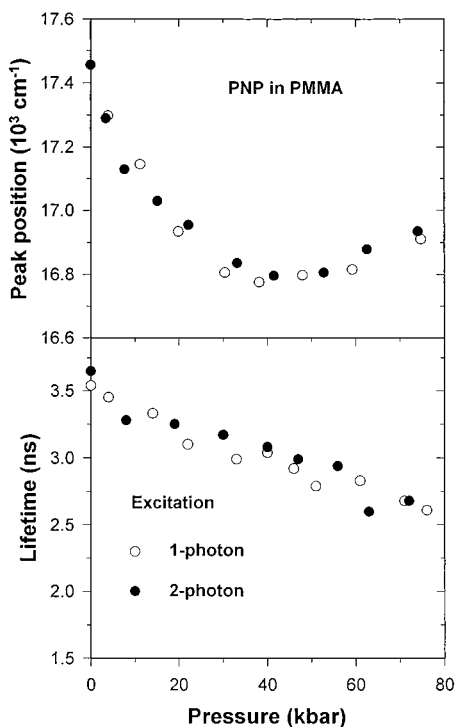

Figure 11. Pressure dependence of the energy and lifetime of the emitting state of PNP in PMMA following one- and two-photon excitation.

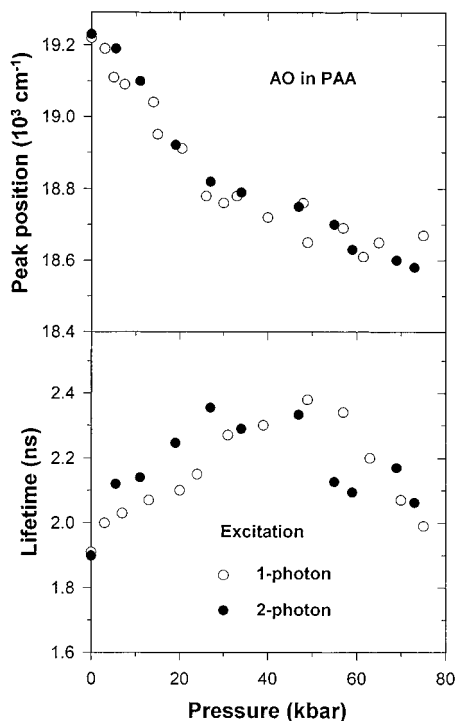

Figure 12. Pressure dependence of the energy and lifetime of the emitting state of AO in PAA following one- and two-photon excitation.

In Figure 13 the changes in emission intensity upon one- and two-photon excitation are presented for all molecules studied. Since the emission intensity is a strong function of the absorption coefficient, changes in emission intensity should also reflect the changes in absorption. The data in Figure 13 are determined from the fluorescence spectra at different pressures and represent the area under the emission curve. The emission intensities for one- and two-photon excitation are then normalized to the value at atmospheric pressure. From the graphs in Figure 13 one can notice that the relationship between the intensity changes for

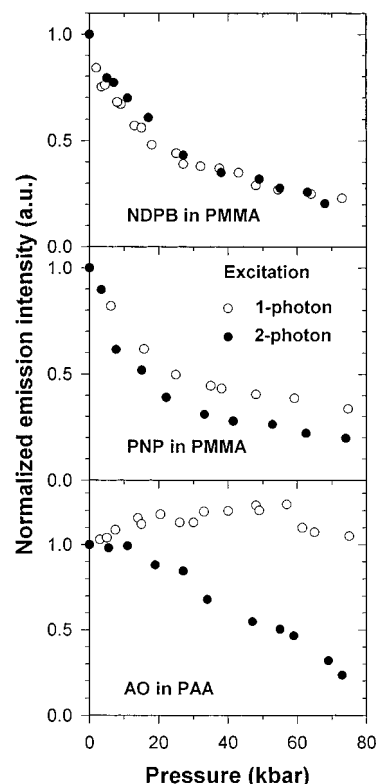

Figure 13. Pressure-induced fluorescence intensity change following one- and two-photon excitation in the molecules studied.

one- and two-photon excitation is different for the different molecules. In the case of NDPB, the pressure dependencies of emission intensity for OPE and TPE are almost identical with respect to the character as well as the magnitude. For both excitations the emission intensity decreases five times over the range of 80 kbar. In contrast to the above, PNP and AO show different changes of emission intensity under pressure when excited by one or two photons. For PNP the intensity of two-photon-excited fluorescence decreases more with pressure than does the one-photon-excited emission. This difference is not so large as it is in the case of AO. For the latter the changes of emission intensity with pressure are entirely different for the two excitations. In OPE the emission intensity increases with pressure about 25% but it decreases by a factor of 5 in TPE.

4. Discussion

The fluorescence signal includes information on both the emission and absorption processes. When photobleaching processes are negligible the time-averaged fluorescence intensity (photon/cm² s), in the case of one [1] and two [2] photon excitation, can be expressed as follows:

$$I_1 = \langle I_1(t) \rangle = K\Phi_1\beta N_0 \langle I_{01}(t) \rangle \int_V f_1(\vec{r}) dV \quad (1a)$$

$$I_2 = \langle I_2(t) \rangle = K\frac{\Phi_2}{2}\delta N_0 \langle I_{02}^2(t) \rangle \int_V f_2^2(\vec{r}) dV \quad (1b)$$

In eqs 1a and 1b, K is the efficiency of the emission collecting system (per unit area of the detector (cm⁻²)) and it does not change with mode of excitation; Φ_1 and Φ_2 are the fluorescence quantum yields, respectively for one- and two-photon excitation (note that Φ_2 is divided by two because two photons are needed for each event of excitation); β (cm²) and δ (cm⁴ s/photon) are the one- and two-photon absorption cross sections; N_0 is the number of molecules per unit volume; V is the observed volume;

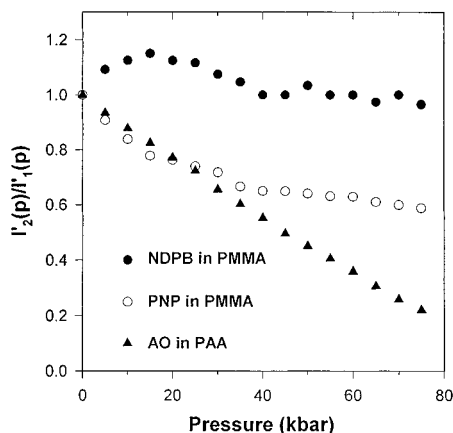

Figure 14. Pressure effect on ratio of the relative fluorescence intensity for two-photon excitation to relative fluorescence intensity for one-photon excitation for NDPB and PNP in PMMA and AO in PAA.

$I_{01}(t)$ and $I_{02}(t)$ (photon/cm² s) are the incident photon flux profile as a function of time, respectively for one- and two-photon; $f_1(\vec{r})$ and $f_2(\vec{r})$ describe, respectively for one- and two-photon, the spatial distribution of the incident laser beam. As can be seen the emission intensity for both modes of excitation is characterized by four parameters: fluorescence quantum yield, absorption cross section, and the spatial and temporal structure of the excitation beam inside the sample. The last two parameters are of special importance in measurements of the absolute value of the absorption cross section.^{1,6,22} In the case of the weak light absorption (the product of the relevant absorption coefficient and thickness of the sample is much smaller than one) eqs 1a and 1b can be approximated by the following:

$$I_1 = K' \Phi_1 \beta N_0 L P_{av1} \quad (2a)$$

$$I_2 = K' \frac{\Phi_2}{2} \delta N_0 \frac{L}{A} P_{av2}^2 \quad (2b)$$

In the above, K' is the constant K including the temporal profile of the laser beam; L is the absorption path length in cm (a thickness of the sample); P_{av1} and P_{av2} are the average laser powers (photon/s), for one- and two-photon excitation; A is the area of the laser beam at the sample (cm²). One should note that although both the concentration (N_0) and thickness (L) change with pressure, the product of N_0L does not, i.e., the number of molecules in the light path is constant (up to 80 kbar there is no noticeable expansion of the gasket).

4.1. Pressure Dependence of Fluorescence Intensity.

Since we compare the effect of pressure on the one- and two-photon-excited fluorescence it is convenient to introduce a parameter defined as a ratio of the emission intensity following two-photon excitation to the emission intensity following one-photon excitation:

$$\frac{I_2(p)}{I_1(p)} = \left(\frac{\beta(0) \Phi_1(0)}{\delta(0) \Phi_2(0)} \right) \frac{\delta(p) \Phi_2(p)}{\beta(p) \Phi_1(p)} \quad (3)$$

In the above eq $I_1(p)$ and $I_2(p)$ are the fluorescence intensities at any pressure, respectively for one- and two-photon excitation, normalized to fluorescence intensities at atmospheric pressure (0). The factor in parentheses is pressure independent. The ratio is shown in Figure 14. The points in this Figure represent a division of the values (every 5 kbar) obtained after smoothing the original data from Figure 13. One notices that in the case

of NDPB the ratio, except for a modest increase below 25 kbar, hardly changes with pressure. For the PNP and AO molecules, the ratio decreases at all pressures but more significantly for AO. It is noticeable that neither NDPB and PNP (derivatives of pyrazoline) show significant change above ~40 kbar. As we see from eq 3 the ratio is governed by the product of two ratios: absorption cross sections and fluorescence quantum yields. At this stage of our investigation it is difficult to separate the pressure effect on these two parameters. However, two limiting cases can be considered; the fluorescence intensity changes with pressure because the absorption cross sections are changing or because the fluorescence quantum yields are changing. The latter would imply different relaxation pathways for the one- and two-photon-excited states.

4.1.1. One-Photon Absorption vs Two-Photon Absorption.

In many cases it is found that the emission spectra of one- and two-photon-excited fluorescence are almost identical.^{5,17,23–25} Thus, in the fluorescence excitation experiments, focused on obtaining the absolute values of cross section for TPA, it is often assumed that fluorescence quantum yields for TPA are the same as for OPA.^{1,4–6} Our results show that for both modes of excitation, for each molecule: (i) the fluorescence spectra are similar, (ii) the energy of the emitting state exhibits the same pressure effect and (iii) the lifetime has the same magnitude and pressure dependence. It implies that, for the molecules studied, emission following one- and two-photon excitation takes place from the same excited state, at all pressures. Moreover, one can also assume that fluorescence quantum efficiencies are the same regardless of the path of excitation. Hence, the ratio of the fluorescence intensities due to one- and two-photon excitation is, simply proportional to the ratio of absorption cross sections for two excitations:

$$I_2(p)/I_1(p) \approx \delta(p)/\beta(p) \quad (4)$$

If this relation is applicable, the data in Figure 14 reflect the pressure-induced change in the ratio of two absorption cross sections. In the case of NDPB in PMMA, since the ratio hardly differs from one, it seems that $\delta(p)$ and $\beta(p)$ change with pressure in the same fashion. It is worthy to note that this result is identical with the result obtained for crystalline NDPB.^{17,18} The molecular structure of NDPB indicates that this molecule has no axis of rotation, no center of inversion, and a mirror plane so it can be formally assigned to the C_1 point group. Consequently, the wave functions have mixed one- and two-photon character, and thus the excited state can be accessed by both one- and two-photon absorption. The very similar pressure dependence of δ and β suggests that the same states are reached in the case of both TPA and OPA.

Both AO and PNP are low symmetry molecules but still higher than NDPB. AO has, in the ground state, C_{2v} symmetry, and PNP can be practically included in the same class. Thus, absorption in these molecules should probably obey different selection rules for one- and two-photon excitation. In fact, this is evidenced by somewhat different changes of ratio δ/β with increasing pressure. At this stage it is difficult to account for the origin of such a difference. However, we can propose the following possibility. It is not unusual that two different electronic states, associated with a one- or two-photon transition, may interact differently with the medium. Hence, the pressure could perturb differently the transition moments for one- and two-photon absorption. In addition to the change in electronic coupling to the medium, the change in the vibronic interaction may also participate. This is due to the strong electron–phonon coupling characterizing conjugated compounds in which the

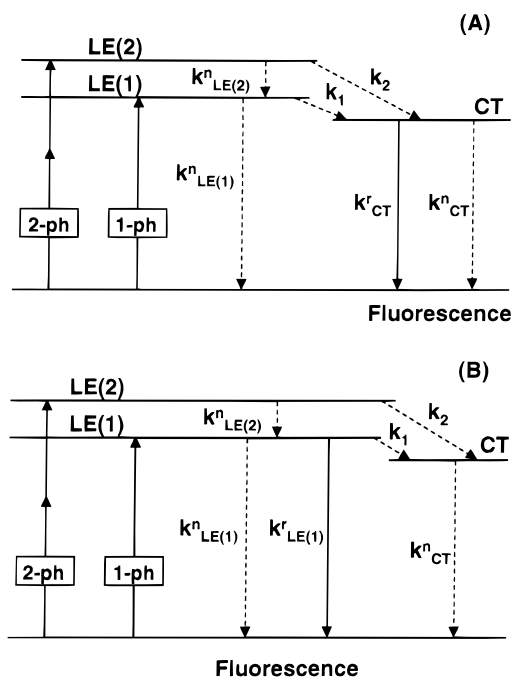

Figure 15. Scheme of the kinetic model for one- and two-photon-excited fluorescence. Case A describes processes in PNP (and NDPB if one assumes only that one- and two-photon transitions are identical); case B describes processes in AO. The meaning of the various rate constants is explained in the text.

excited-state vibrational levels may be involved in the absorption transitions.¹⁴

In addition to the above processes involving a different interaction of two separate states with surroundings, the pressure-induced changes between two states can also be considered. As mentioned above, AO and PNP are low symmetry polar molecules. Thus two-photon transition intensities may partially originate from the one-photon-allowed transitions. Pressure, by changing the intramolecular coupling, may alter the symmetry of the molecule and thus change the distribution among the absorption transitions associated with one-photon (linear) and two-photon (nonlinear) excitations. However, it is not obvious why, for both AO and PNP, the intensity of the two-photon transition decreases with pressure more than the intensity of the one-photon transition.

4.1.2. Pressure Effect on Fluorescence Efficiency. In the previous section, we assumed the equality of fluorescence efficiency for two different excitations. Consequently, we attributed the difference in fluorescence intensity change with pressure to different pressure perturbation of the one- and two-photon absorption transitions.

Below we present an alternative, or rather supplementary, explanation for different pressure dependence of the fluorescence intensity following one- and two-photon excitation. The analysis of the pressure effect on the fluorescence intensity is based on a kinetic model that is schematically shown in Figure 15. The schemes A and B describe the photophysical processes following the one- and two-photon excitations, respectively for PNP and AO. Scheme A can also describe the processes in NDPB if the one- and two-photon transitions reach the same excited state. The bases for the formulation of the above schemes are as follows: (i) regardless of the mode of excitation the emission originates from the same state, at all pressures (identity of the emission spectra and lifetime for two excitations); (ii) both PNP and NDPB emit from a state with a different charge distribution (charge transfer (CT) state) than the locally excited (LE) state (LE and CT are the states with

respectively small and large degree of charge transfer relative to the ground state; this assumption can be supported by a large Stokes shift in these two molecules, see section 4.2); (iii) for AO the emission comes from the LE state (a small Stokes shift) but the energy can also be dissipated through charge redistribution in the excited state. Furthermore, we propose that absorption of one (1-ph) or two photons (2-ph) by the molecule takes place to different locally excited states, respectively LE(1) and LE(2). (We assume that the two-photon allowed transition has higher energy than that allowed for the one-photon transition.^{5,6}) From the LE(1) state, the PNP molecule (scheme A) may relax nonradiatively ($k_{LE(1)}^n$) to the ground state or transform (k_1) to a charge transfer (CT) state. The LE(2) state may undergo transformation to the LE(1) state with the rate $k_{LE(2)}^n$ or to the CT state with the rate k_2 .²⁶ Ultimately, both the LE(1) and LE(2) states decay radiatively from the same CT state. Scheme B, assigned to the AO molecule, involves the same processes as listed above, with only the difference that fluorescence originates in the LE(1) state instead of the CT state.

The time-resolved measurements show (see section 3.2) that the decay of fluorescence intensity following the laser pulse, for the one or two photon excitation, exhibits a single-exponential character. (Note that the resolution of the detection system is estimated to be ~ 100 ps.) As we show below, the kinetic schemes in Figure 15 are, under certain conditions, in agreement with the time-resolved results. For example the instantaneous fluorescence intensity upon one-photon excitation, for scheme A, assumes the following form:

$$I_1(t) = k_{CT}^r \frac{S_{LE(1)}(0)}{1 - \frac{k_{CT}^r + k_{CT}^n}{k_1 + k_{LE(1)}^n}} \{ \exp[-(k_{CT}^r + k_{CT}^n)t] - \exp[-(k_1 + k_{LE(1)}^n)t] \} \quad (5)$$

In this equation, $S_{LE(1)}(0)$ is the initial ($t \rightarrow 0$) population of molecules in the LE(1) state; k_{CT}^r and k_{CT}^n are, respectively, the radiative and nonradiative rate from the CT state; the meaning of the remaining symbols is explained above. Equation 5 has, in general, a double-exponential form. However

if $k_1 + k_{LE(1)}^n \gg k_{CT}^r + k_{CT}^n$, then

$$I_1(t) = k_{CT}^r S_{LE(1)}(0) \exp[-(k_{CT}^r + k_{CT}^n)t] \quad (6)$$

It can be easily shown that the time-dependent intensity for two-photon excitation ($I_2(t)$) also assumes single-exponential form if $k_2 + k_{LE(2)}^n \gg k_{CT}^r + k_{CT}^n$ and $k_1 + k_{LE(1)}^n \gg k_{CT}^r + k_{CT}^n$. For scheme B, in the case of one-photon excitation, there is only a single-exponential decay of the excited state. Two-photon excitation gives a single-exponential form of the time-dependent intensity, if $k_{LE(2)}^n + k_2 \gg k_{LE(1)}^r + k_{LE(1)}^n + k_1$. Thus we conclude that the proposed models are not in contradiction with the time-resolved results as long as the nonradiative rates depopulating the local exciting states (LE(1) and LE(2) for PNP and LE(2) for AO) are much larger than the rates depopulating the emitting states. Note that the latter (see Figures 10-12) are typically $\sim 5 \times 10^8 \text{ s}^{-1}$, so the nonradiative rates from the LE states are expected to be higher than $\sim 10^{10} \text{ s}^{-1}$. Since this value is beyond the resolution of the detection system it is not surprising that experimentally only a single-exponential decay is observed.

From the kinetic models in Figure 15 one can easily obtain expressions for fluorescence quantum efficiencies for one- and two-photon excitation

scheme A

$$\Phi_1^{(A)} = k_{CT}^r \tau_{CT} \frac{1}{1 + r_1} \quad (7)$$

$$\Phi_2^{(A)} = k_{CT}^r \tau_{CT} \frac{1 + r_2}{1 + r_2} \frac{1}{1 + r_1} \quad (8)$$

where $\tau_{CT} + (k_{CT}^r + k_{CT}^n)^{-1}$ (lifetime of the CT state),

$$r_1 = k_{LE(1)}^n/k_1, \quad r_2 = k_{LE(2)}^n/k_2 \quad (9)$$

scheme B

$$\Phi_1^{(B)} = k_{LE(1)}^r \tau_{LE(1)} \quad (10)$$

$$\Phi_2^{(B)} = k_{LE(1)}^r \tau_{LE(1)} \frac{1}{1 + r_2^{-1}} \quad (11)$$

where $\tau_{LE(1)} = (k_{LE(1)}^r + k_{LE(1)}^n + k_1)^{-1}$
is the lifetime of the emitting state

Since the pressure effect on the ratio of fluorescence quantum efficiency for two-photon excitation to fluorescence quantum efficiency for one-photon excitation is of special interest (see eq 3) we present the above equations in the following forms:

$$\text{for PNP} \quad \frac{\Phi_2^{(A)}(p)}{\Phi_1^{(A)}(p)} = 1 + \frac{\frac{k_{LE(1)}^n(p)}{k_1(p)}}{1 + \frac{k_{LE(2)}^n(p)}{k_2(p)}} \quad (12)$$

$$\text{for AO} \quad \frac{\Phi_2^{(B)}(p)}{\Phi_1^{(B)}(p)} = \frac{1}{1 + \frac{k_2(p)}{k_{LE(2)}^n(p)}} = \frac{k_{LE(2)}^n(p)}{k_{LE(2)}^n(p) + k_2(p)} \quad (13)$$

These equations show that the fluorescence quantum efficiency may be different for one- and two-photon excitation and also that the ratio of $\Phi_2(p)/\Phi_1(p)$ may change with pressure. Because the expression 12 or 13 is a part of eq 3, one expects that the pressure change in $\Phi_2(p)/\Phi_1(p)$ will contribute to the pressure dependence of $I_2(p)/I_1(p)$. The magnitude of this contribution depends on the pressure changes in the absorption cross sections. Provided that the latter have a negligible pressure dependence, the ratio of $\Phi_2(p)/\Phi_1(p)$ is expected to decrease in proportion to $I_2(p)/I_1(p)$. These kinds of changes can be easily ensured by eqs 12 and 13. For example in the case of PNP a 40% decrease, over 70 kbar, in can be in general provided when the ratio of $k_{LE(2)}^n(p)/k_2(p)$ increases with pressure more than the ratio $k_{LE(1)}^n(p)/k_1(p)$. It would imply that a pressure increase favors a pathway for energy dissipation from the local excited states at the expense of the pathway for intramolecular charge transfer. Furthermore, the changes should be stronger in the LE(2) state (two-photon-excited) than in LE(1) (one-photon-excited). Since a dissipation of energy from the LE(2) state takes place to the energetically close LE(1) state, a stronger change, with pressure, in $k_{LE(2)}^n(p)$ than in $k_{LE(1)}^n(p)$ can in fact be expected.

In the case of AO the ratio decreases almost 80% within 70 kbar. This decrease may be caused by an increase of the $k_2(p)/k_{LE(2)}^n$ ratio (see eq 13). In other words, the fraction of energy

dissipated from the LE(2) state, through the $LE(2) \rightarrow LE(1)$ path, to the total energy dissipation from LE(2) should decrease with increasing pressure.

Finally we want to emphasize that the above considerations give a reasonable description of fluorescence processes in the molecules studied, provided that the nonradiative rates in eqs 12 and 13 are much larger than the radiative rates. At the same time these nonradiative rates have to be of the same order of magnitude.

Above we showed that for PNP and AO the fluorescence efficiency may change differently with pressure for one and two-photon excitation. To evaluate the importance of this effect on fluorescence intensity, further studies are needed with different matrixes and compounds.

4.2. Absorbing and Emitting State under Pressure—Stokes Shift. NDPB and PNP in PMMA exhibit a large shift of the emission maximum with respect to the absorption maximum, referred to as the Stokes shift. In general the Stokes shift increases with the increasing difference between the equilibrium geometries of the ground and excited states. In an overwhelming number of experiments, with organic molecules, the Stokes shift has a moderate value (2,000–3,000) cm^{-1} and moderate dependence on pressure.^{27,28} However, for NDPB and PNP in PMMA the Stokes shift decreases significantly with increasing pressure (Figure 9). This effect was observed before in intramolecular charge-transfer compounds.²⁹ We comment briefly on this relatively unusual effect.

A large Stokes shift is usually attributed to an intramolecular charge redistribution that takes place between the absorption and emission processes. Thus the fluorescence may originate in a state which is distinct from the LE state. As we shall see, this statement is well confirmed by the pressure effect on the Stokes shift. For our molecules the Stokes shift decreases with pressure, indicating a stronger pressure effect on the absorbing energy than on the emitting one. Moreover, it implies a different interaction between the excited and the emitting species and their surroundings. This difference in the intermolecular interaction can be understood if one considers that during a lifetime of the excited state the molecule assumes a form different from that after instantaneous absorption. It is widely documented that the shift in energy with pressure of absorption or emission peaks is almost always determined by the difference in polarizability of the two states involved, as well as by the polarizability of the medium (see e.g. ref 30). Thus for NDPB and PNP in PMMA we expect that the locally excited state is more polarizable than the emitting state. Since these molecules are polar, both states (absorbing and emitting) may have a charge-transfer character. However, the emitting state should be more polar (usually less polarizable) than the excited state. In this case pressure controls the barrier between two electronically different states.

It is, of course, possible that the Stokes shift could be affected by changes in the relative shape and displacement of ground and excited-state potential wells. There is no evidence for these changes here (the shape of the absorption and emission spectra shows almost no change with pressure).

There is also an apparent blue shift of the emission peak of PNP in PMMA at pressures above 50 kbar. It seems that this effect is caused by an intramolecular redistribution of charge in the ground state of molecule, in addition to changes in the excited state.

5. Summary

We use the pressure parameter to study the fluorescence process in organic molecules following one- and two-photon

excitation. We show that pressure affects the fluorescence properties of the NDPB molecule in the same fashion regardless of the mode of excitation. Thus, for this noncentrosymmetric molecule we propose that two-photon excitation follows the one-photon-allowed transitions. In contrast to the above, the PNP and AO molecules exhibit different pressure dependences for the fluorescence intensity for one- and two-photon excitations. To account for this effect we discuss the different possible changes in the absorption cross sections and fluorescence quantum efficiencies for two different absorption transitions. A different pressure dependence of the absorption cross sections for one- and two-photon excitation may be traced to: (i) the difference in the electronic and vibronic coupling to the medium of two different states, (ii) the change of symmetry of molecules due to the alteration of intramolecular coupling. The differences in fluorescence quantum efficiencies are analyzed on the basis of a kinetic model which takes into account different excitation and relaxation pathways for one- and two-photon absorption. The model can explain different pressure dependences of fluorescence efficiency for two different excitations even if the emission originates, for both excitation, from the same state. The pressure-induced changes in the Stokes shift are attributed to the difference in polarizability of the locally excited and emitting state. Finally, we would like to point out the usefulness of the external pressure parameter in revealing photophysical processes which are masked at atmospheric pressure.

Acknowledgment. The authors would like to acknowledge continuing support from the Department of Energy, Division of Materials Science grant DEFG02-96R45439 through the University of Illinois at Urbana-Champaign, Frederick Seitz Materials Research Laboratory. We thank the referees for helpful comments.

References and Notes

- (1) Hermann, J. P.; Ducuing, J. *Phys. Rev. A* **1972**, *5*, 2557.
- (2) Bradley, D. J.; Hutchinson, M. H. R.; Koetser, H. *Proc. R. Soc. London A* **1972**, *329*, 105.
- (3) Swofford, R. L.; McClain, W. M. *Chem. Phys. Lett.* **1975**, *34*, 455.
- (4) Kennedy, S. M.; Lytle, F. E. *Anal. Chem.* **1986**, *58*, 2643.
- (5) Fischer, A.; Cremer, C.; Stelzer, E. H. K. *Appl. Opt.* **1995**, *34*, 1989.
- (6) Xu, C.; Webb, W. W. *J. Opt. Soc. Am. B* **1996**, *13*, 481.
- (7) Peticolas, W. L. *Annu. Rev. Phys. Chem.* **1967**, *18*, 233.
- (8) McClain, W. M. *Acc. Chem. Res.* **1974**, *7*, 129.
- (9) McClain, W. M.; Harris, R. A. In *Excited States*; Lim, E. C., Ed.; Academic Press: New York, 1977; p 1.
- (10) Freidrich, D. M.; McClain, W. M. *Annu. Rev. Phys. Chem.* **1980**, *31*, 559.
- (11) Birge, R. R. In *Ultrasensitive Laser Spectroscopy*; Klinger, D. S., Ed.; Academic Press: New York, 1983; p 109.
- (12) Goodman, L.; Rava, R. P. *Acc. Chem. Res.* **1984**, *17*, 250.
- (13) Dick, B.; Hohlneicher, G. *J. Chem. Phys.* **1982**, *76*, 5755.
- (14) Beljonne, D.; Brédas, J. L.; Cha, M.; Torruellas, W. E.; Stegeman, G. I.; Hofstraat, J. W.; Horsthuis, W. H. G.; Möhlmann, G. R. *J. Chem. Phys.* **1995**, *103*, 7834.
- (15) Bhawalkar, J. D.; He, G. S.; Prasad, P. N. *Rep. Prog. Phys.* **1996**, *59*, 1041.
- (16) Denk, W.; Piston, D. W.; Webb, W. W. In *Handbook of Biological Confocal Microscopy*; Pawley, J., Ed.; Plenum Publishers: New York, 1995; p 445.
- (17) Dreger, Z. A.; Yang, G.; White, J. O.; Drickamer, H. G. *J. Phys. Chem.* **1997**, *101*, in press.
- (18) Dreger, Z. A.; Yang, G.; White, J. O.; Drickamer, H. G. *Bull. Am. Phys. Soc.* **1997**, *42*, 596.
- (19) Rettig, W. *Angew. Chem., Int. Ed. Eng.* **1990**, *25*, 971.
- (20) Lippert, E.; Rettig, W.; Bonacic-Kutecký, V.; Heisel, F.; Miehé. In *Advances in Chemical Physics*; Prigogine, I., Rice, S. A., Eds.; Wiley: New York, 1987; Vol. 68, p 1.
- (21) Shimizu, T.; Hayashi, Y.; Miki, M.; Teramura, K. *J. Heterocycl. Chem.* **1990**, *27*, 1669.
- (22) Xu, C.; Guild, J.; Webb, W. W.; Denk, W. *Opt. Lett.* **1995**, *20*, 2372.
- (23) He, G. S.; Zieba, J.; Bradshaw, J. T.; Kazmierczak, M. R.; Prasad, P. N. *Opt. Commun.* **1993**, *104*, 102.
- (24) Curley, P. F.; Ferguson, A. I.; White, J. G.; Amos, W. B. *Opt. Quantum Electron.* **1992**, *24*, 851.
- (25) Fisher, W. G.; Wachter, E. A.; Armas, M.; Seaton, C. *Appl. Spectrosc.* **1997**, *51*, 218.
- (26) The rates k_1 and k_2 , respectively for one- and two-photon excitation, are assumed to control a change of the molecule conformation in the excited state from the primary the same conformation as the ground state (LE) to a different structure with a significant charge transfer (CT) character. In the case of NDPB and PNP these rates may correspond to the "twist" around the single bond between nitrophenyl (electron acceptor) and pyrazoline group (electron donor). In the case of AO the rotation of dimethylamino group (electron donor) with respect to the phenyl rings may create nonradiative CT state.
- (27) Offen, H. in *Organic Molecular Photophysics*; Birks, J. B., Ed.; Wiley-Interscience Publishers: New York, 1973; Vol. 1, Chapter 3.
- (28) Dreger, Z. A.; Lang, J. M.; Drickamer, H. G. *Chem. Phys.* **1992**, *166*, 193.
- (29) Rollinson, A. M.; Drickamer, H. G. *J. Chem. Phys.* **1980**, *73*, 5981.
- (30) Drickamer, H. G. In *Photochemistry and Photophysics*; Rabek, J. F., Ed.; CRC Press: Boca Raton, FL, 1989; Vol. 1, p 137.