

# Ultrafast Dynamics of Dye Molecules in Solution as a Function of Temperature

Jian-Yong Liu, Wen-Hui Fan, Ke-Li Han,\* Da-Li Xu, and Nan-Quan Lou

Dalian Institute of Chemical Physics, Chinese Academy of Sciences,  
Dalian 116023, The People's Republic of China

Received: August 22, 2002; In Final Form: October 28, 2002

Femtosecond time-resolved studies using fluorescence depletion spectroscopy were performed on Rhodamine 700 in acetone solution and on Oxazine 750 in acetone and formamide solutions at different temperatures. The experimental curves that include both fast and slow processes have been fitted using a biexponential function. Time constants of the fast process, which corresponds to the intramolecular vibrational redistribution (IVR) of solute molecules, range from 300 to 420 fs and increase linearly as the temperature of the environment decreases. The difference of the average vibrational energy of solute molecules in the ground state at different temperatures is a possible reason that induces this IVR time-constant temperature dependence. However, the time constants of the slow process, which corresponds to the energy transfer from vibrational hot solute molecules to the surroundings occurred on a time scale of 1–50 ps, changed dramatically at lower temperature, nonlinearly increasing with the decrease of temperature. Because of the C–H···O hydrogen-bond between acetone molecules, it is more reasonable that acetone molecules start to be associated, which can influence the energy transfer between dye molecules and acetone molecules efficiently, even at temperatures far over the freezing point.

## Introduction

In recent years enormous experimental and theoretical research studies have been done on the dynamics of complex molecules in solution. The relaxation dynamics of dye molecules play very important roles in those kinds of studies. Following an optical excitation of a solute molecule in a polar solvent, two ultrafast dynamic processes will take place. First, the intramolecular vibrational redistribution (IVR) occurs mostly on a subpicosecond time scale. For several dyes in the  $S_1$  state, energy redistribution among vibrational modes has been observed in 25 to 500 fs.<sup>1–6</sup> Second, the vibrational hot  $S_1$  state is cooled by energy transfer to the solvent molecules. The time scale is 5–50 ps, depending on the specific solvent and the amount of excess energy.<sup>4</sup> Those studies have been reviewed by some authors.<sup>7–12</sup>

Acetone is a typical example of an aprotic dipolar liquid. Generally, the interactions between aprotic dipolar molecules are attributed to weak electrostatic forces. Recent experimental<sup>13,14</sup> and theoretical findings,<sup>15–18</sup> however, point to the possibly important role of hydrogen-bond-like C–H···O interactions in the association of molecules, even between aprotic ones, in all phases, which is very important in crystal formation, and in particular, in the design of solid materials.<sup>17</sup> Following an optical excitation of a dye molecule in acetone, the C–H···O interactions between acetone molecules must influence the cooling of the vibrational hot solute molecules in the  $S_1$  state by the solvent molecules.

A variety of experimental techniques have been developed to study ultrafast dynamics of dye molecules.<sup>1–6,19–30</sup> The fluorescence upconversion and pump–probe are the most popular methods. The femtosecond time-resolved stimulated emission pumping fluorescence depletion (FS TR SEP FD), which was developed by Kong and co-workers,<sup>28</sup> has been used

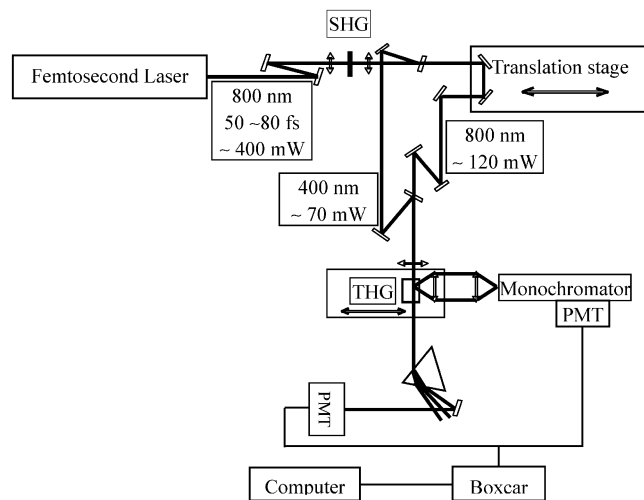
to study vibrational relaxation and solvation dynamics of dye molecules and the fast singlet–triplet intersystem crossing of terthiophene.<sup>28–30</sup> Two femtosecond laser pulses were used in the experiment of FS TR SEP FD. One pulse was used as a pump source to excite the molecule to the electronically excited state, to generate fluorescence. The other, with a specific delay time, was used to perform stimulated emission pumping (SEP) from the electronic excited states to the ground state. The variation of the decrease of the fluorescence induced by the SEP with delay time reflects vibrational relaxation in the excited states. More detail can be found in ref 28.

In this paper we report on investigations of the temperature dependency of relaxation dynamics of Rhodamine 700 in acetone solution and Oxazine 750 in acetone and formamide solutions using the FS TR SEP FD technique, which provided some information about the dye molecule IVR in the excited state, energy transfer between dye molecules and solvent molecules, and the molecular association of acetone molecules.

## Experimental Section

A homemade regenerative amplified self-mode-locking Ti:sapphire femtosecond laser whose oscillator and amplifier were pumped by a multiline argon ion laser (Innova 300, Coherent Corp.) and an Nd:YAG laser (SL903, Spectron Laser Systems, U.K., power = 20 W, repetition rate = 3 kHz), respectively, was used. The output power was about 700 mW at 3 kHz repetition rate at the wavelength of 800 nm with a pulse width of 60 fs (fwhm). A BBO crystal (0.3 mm  $\beta$ -BaB<sub>2</sub>O<sub>4</sub>, Fujian Catech crystals Inc.) was used for frequency doubling to generate UV laser pulses (center wavelength = 400 nm, power = 170 mW, pulse width = 120 fs). The 400 nm pulse was used as an excitation pulse to generate fluorescence and the 800 nm pulse as a probe which was delayed by a translation stage (Unidex-100, Aerotech Inc.) with computer control, providing  $2 \times 1 \mu\text{m}$  path difference increment, equivalent to 6.67 fs. The

\* Corresponding author. E-mail: klhan@dicp.ac.cn.



**Figure 1.** The schematic diagram of the experimental setup.

probe beam was collinear with the pump beam and both of them were focused. The fused quartz sample cell was placed in a spot behind the focus where the beam diameter was 2 mm to avoid the thermal effect of the sample due to the laser heating. The probe polarization was at the magic angle with respect to the pump polarization. Fluorescence perpendicular to the incident beams was focused into a monochromator (Jarrel-Ash, Division of Fisher Scientific Company) and detected by a PMT (R456, HAMAMATSH Corp.). The PMT signal was processed by a Boxcar (SR250, Stanford Corp.) and recorded by a computer. A frequency-tripling BBO crystal (0.5 mm  $\beta$ -BaB<sub>2</sub>O<sub>4</sub>, Fujian Castech crystals Inc.) was used to generate a 266 nm pulse by both the pump and probe pulses. The zero-time point and the time resolution were evaluated by detecting the correlation of 266 nm pulse power and the time delay between the probe pulse and the pump pulse. The sample cell and the frequency-tripling BBO crystal were fixed on a translation stage perpendicular to the incident beams which was used to ensure that the cell and the crystal had the same positioning. A schematic diagram of the experimental setup is shown in Figure 1.

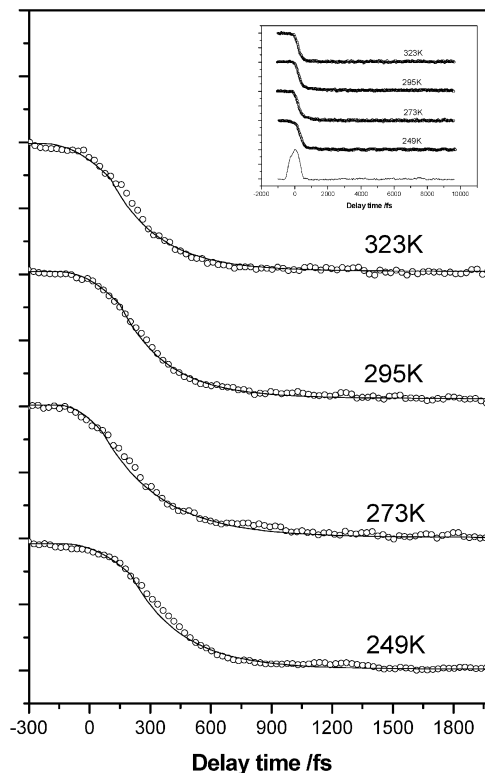
Rhodamine 700 and Oxazine 750 used in the present study were purchased from Exciton. Rhodamine 700 was dissolved at a concentration of  $1.23 \times 10^{-3}$  M in acetone, and Oxazine 750 was dissolved at a concentration of  $7.23 \times 10^{-4}$  M in acetone and formamide.

## Results

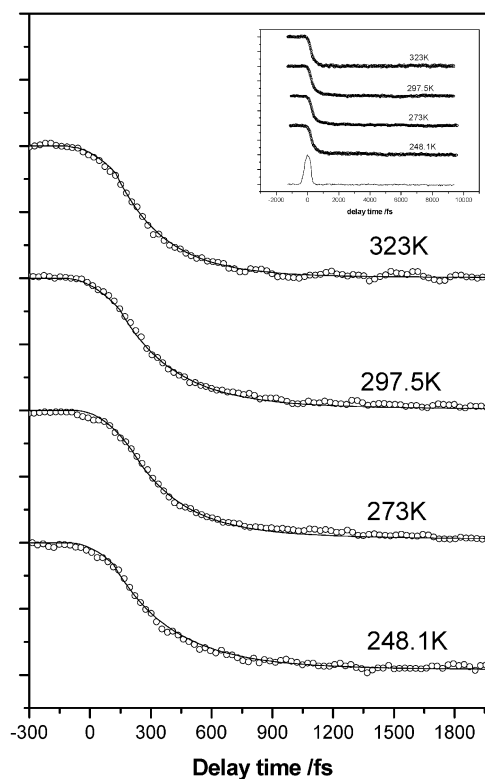
We have measured the fluorescence intensity at 730 nm at different temperatures when the delay time between the probe and pump pulse is changed from  $-1$  to  $10$  ps. The fluorescence depletion signals are shown in Figures 2, 3, and 4. Two decay processes would be found: a rapid decay with a few hundred femtoseconds and a slower decay with a picosecond time scale. The experimental results can be fitted by the deconvolution of eq 1.<sup>28</sup> Here  $R(t - \tau)$  was the correlation function.

$$\Delta I = \int_{-\infty}^{\infty} R(t - \tau) dt - S_{e0} \int_{-\infty}^{\infty} \exp(-t/\tau_e) R(t - \tau) dt - S_{p0} \int_{-\infty}^{\infty} \exp(-t/\tau_p) R(t - \tau) dt \quad (1)$$

The time constants of ultrafast dynamics of electronically excited Rhodamine 700 and Oxazine 750 molecules in solutions are given in Tables 1–3 and Figures 6, 7. It can be seen that, there really are two decay processes: a rapid decay with about

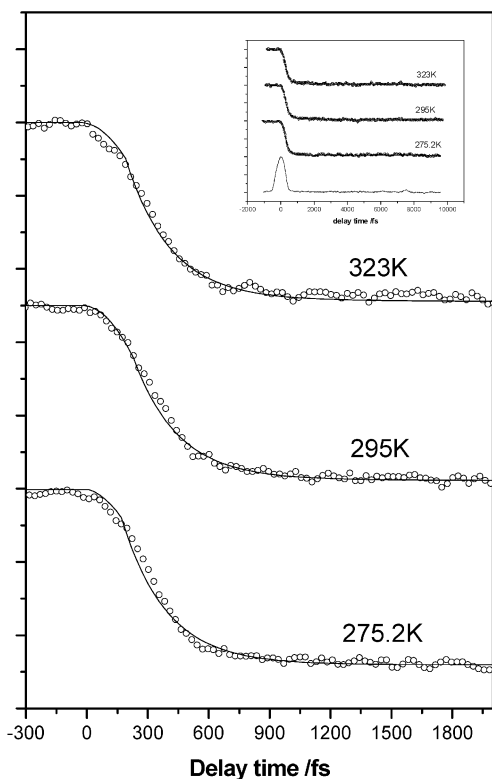


**Figure 2.** Time-resolved stimulated emission pumping fluorescence depletion of Oxazine 750 in acetone at different temperatures. The open circles represent experimental data, and the solid lines represent simulated results.



**Figure 3.** Time-resolved stimulated emission pumping fluorescence depletion of Rhodamine 700 in acetone at different temperatures. The open circles represent experimental data, and the solid lines represent simulated results.

300–420 fs, and a slower decay from 1 to 40 ps depending on the dye and solvent molecules. Where the fast process makes



**Figure 4.** Time-resolved stimulated emission pumping fluorescence depletion of Oxazine 750 in formamide at different temperatures. The open circles represent experimental data, and the solid lines represent simulated results.

**TABLE 1: Time Constants of Ultrafast Vibrational Relaxation for Oxazine 750 in Acetone Solvent under Different Temperatures**

temperature/K	$S_p^0$	$t_p$ /fs	$S_e^0$	$t_e$ /ps
323.0	0.97	300	0.03	6.70
295.0	0.95	350	0.05	7.09
273.0	0.99	370	0.01	8.03
249.0	0.99	409	0.01	22.8

**TABLE 2: Time Constants of Ultrafast Vibrational Relaxation for Oxazine 750 in Formamide Solvent under Different Temperatures**

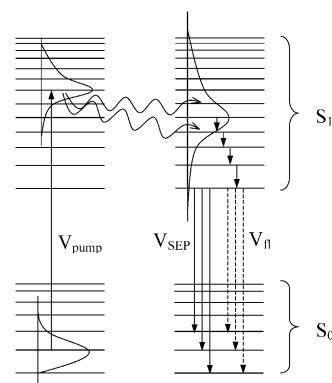
temperature /K	$S_p^0$	$t_p$ /fs	$S_e^0$	$t_e$ /ps
323.0	0.97	306	0.03	8.03
295.0	0.95	359.3	0.05	21.3
275.1	0.96	410	0.04	44.6

**TABLE 3: Time Constants of Ultrafast Vibrational Relaxation for Rhodamine 700 in Acetone Solvent under Different Temperatures**

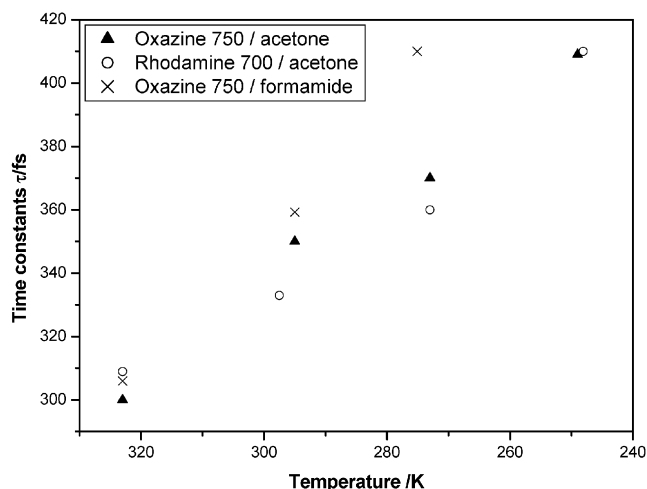
temperature /K	$S_p^0$	$t_p$ /fs	$S_e^0$	$t_e$ /ps
323.0	0.98	309	0.02	1.67
297.5	0.96	333	0.04	1.84
273.0	0.94	360	0.06	2.89
248.1	0.94	410	0.06	5.63

the most contribution, more than 90%, to the fluorescence depletion signals at the current temperature range.

As shown in Figures 6 and 7, as the temperature of environment decreases, the time constants of both the fast and the slow processes increase. Furthermore, the time constants of the fast process linearly increase with the decrease of temperature, and the change of the time constants of the fast process with temperature is almost independent of dye molecules, whereas it was slightly dependent on the solvent



**Figure 5.** The ultrafast relaxation process in photoexcited dye molecules in solutions. Dye molecules in the ground electronic state,  $S_0$ , have a thermal distribution of populated vibrational–rotational levels. Optical absorption,  $V_{\text{pump}}$ , promotes this distribution to a band of vibrational states in the excited electronic state,  $S_1$ , from which the initial excess vibrational energy relaxes to the other levels through an IVR process. Then these vibrational hot molecules are cooled by the solvent to the lowest level of the  $S_1$  state. After several delay times, the second pulse,  $V_{\text{SEP}}$ , performs stimulated emission pumping (SEP) from the electronic excited states to the ground state. The rest of the excited molecules emit the fluorescence,  $V_{\text{fl}}$ , in several nanoseconds.

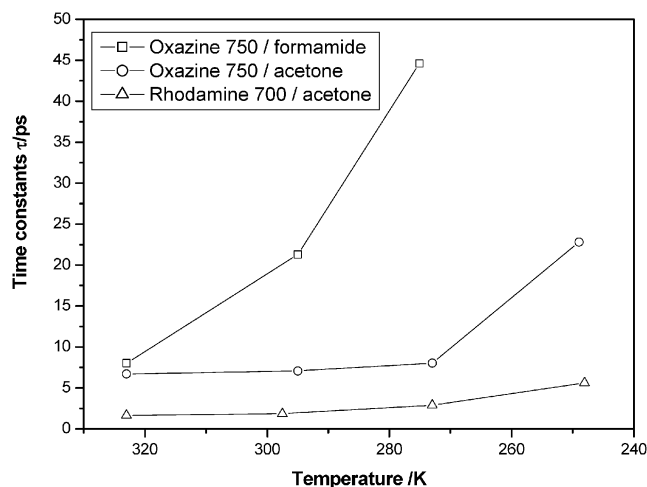


**Figure 6.** Time constants of ultrafast IVR of electronically excited dye molecules under different temperatures.

molecules. The time constants of the slow process as a function of temperature, however, are nonlinear. Particularly, at lower temperature, the time constants of the slow process dramatically increase, whereas they slightly increase, as the temperature decreases, at higher temperature. And they strongly depend on the solute molecules. The time constants of this process for Oxazine 750, for example, were much higher than those of Rhodamine 700 at the current temperature range. As to the Oxazine 750 in different solvents, although they were almost identical at the high temperature, the constant of the slow process in formamide is higher than that in acetone at low-temperature clearly, and as the temperature decreases, the gap is widened.

## Discussion

First of all, the fast process should be an intramolecular process according to the time scale and the temperature dependence of this process. Following the excitation of the dye molecules by a femtosecond pulse at 400 nm, both the Oxazine 750 and Rhodamine 700 molecules reach the excited electronic state with highly excess energy (they are 10589 and 10342  $\text{cm}^{-1}$  in acetone, respectively, and it is 10886  $\text{cm}^{-1}$  for Oxazine 750



**Figure 7.** Time constants of energy transfer from vibrational hot excited dye molecules to the surroundings under different temperatures.

in formamide), where the number density of the vibrational states is significantly large. The quasicontinuum of states gives rise to the possibility of intramolecular redistribution, which leads to a quasi-equilibrium population of the vibrational manifold. So the fast process can respond to the IVR of the dye molecules. The difference of the average vibrational energy of solute molecules in the ground state at different temperatures is a possible reason for the change of the time constants with temperature. The colder the surroundings, the less the average vibrational energy is. The change of the average vibrational energy in the ground state might lead to a change of the vibrational population in the excited state, which causes the variation of the IVR process with the temperature change.

As discussed above, the IVR process leads to a quasi-equilibrium population of the vibrational manifold for the excited dye molecules, characterized by a temperature higher than that of the surrounding solvent. In comparison with the situation in gas, the hot molecules could be cooled by colliding with solvent molecules, which has the same time scale as that of the slow process in this experiment.<sup>4</sup> It is reasonable to define the slow process as the energy transfer from the hot solute to the solvent. The time constants of this process depend on the amount of vibrational excess energy and on the specific solvent. In Figure 6, we can see that the time constants of Oxazine 750 are higher than those of the Rhodamine 700 molecules, which coincides with the difference of excess energy of them. The molecular transitions involved in these investigations are illustrated schematically in Figure 5.

Acetone is a typical example of aprotic dipolar liquids, and, generally, the interactions between aprotic dipolar molecules are attributed to weak electrostatic forces. But more and more experimental<sup>13,14</sup> and theoretical<sup>15–18</sup> researchers have pointed out that there is C–H⋯O hydrogen-bond interaction between acetone molecules, which gives a possible reason for the dramatic temperature dependence. Although the temperature is far over the freezing point, due to the hydrogen bond, the structure of liquid acetone starts to change, such as the molecular association, just as what happened in formamide in its freezing point, which can slow the energy transfer from the hot solute molecules to the acetone molecules effectively.

## Conclusion

We have measured the ultrafast vibrational relaxation of the dye molecules in solution using the FS TR SEP FD technique. Following an intramolecular vibrational redistribution, whose

time constants ranged from 300 to 420 fs, the vibrational energy of the hot solute molecules would transport to the solvent, which occurred on a time scale of 1–50 ps depending on the dye and solvent molecules. The linear change of the speeds of the IVR with the temperature can be related to the variation of the average vibrational energy on the ground state. For the vibrational energy transport to the surroundings, the function of the time constants in acetone with temperature is nonlinear. Particularly, at lower temperature, the time constants dramatically increase as the temperature decreases. The increase was so rapid that it indicated the acetone molecules had associated by the C–H⋯O hydrogen bond even at the temperature far over the freezing point. As far as we know, this is the first time to study the molecular structure change of acetone liquid in such a femtosecond time-resolved dynamic experiment. And this work may suggest to us a new method to study the molecular interaction in liquids.

To understand the detail of the IVR process of electronically excited molecules in solution and the energy transfer between the solute and solvent molecules, more theoretical and experimental work deserve further study.

**Acknowledgment.** This work is supported by the National Natural Science Foundation of China (Grant Nos., 29833080, 29853001), the Knowledge Innovation Program of the Chinese Academy of Sciences (Grant: DICP K200/E3) and NKBRSF.

## References and Notes

- Weiner, A. M.; Ippen, E. P. *Chem. Phys. Lett.* **1985**, *114*, 456.
- Brito Cruz, C. H.; Fork, R. L.; Knox, W. H.; Shank, C. V. *Chem. Phys. Lett.* **1986**, *132*, 341.
- Taylor, A. J.; Erskine, D. J.; Tang, C. L. *Chem. Phys. Lett.* **1984**, *103*, 430.
- Wild, W.; Seilmeier, A.; Gottfried, N. H.; Kaiser, W. *Chem. Phys. Lett.* **1985**, *119*, 259.
- Laermer, F.; Israel, W.; Elsaesser, T. *J. Opt. Soc. Am. B* **1990**, *7*, 1604.
- Laermer, F.; Elsaesser, T.; Kaiser, W. *Chem. Phys. Lett.* **1989**, *156*, 381.
- Stratt, R. M.; Maroncelli, M. *J. Phys. Chem.* **1996**, *100*, 12981.
- Owrutsky, J. C.; Rattery, D.; Hochstrasser, R. M. *Annu. Rev. Phys. Chem.* **1994**, *45*, 519.
- Elsaesser, T.; Kaiser, W. *Annu. Rev. Phys. Chem.* **1991**, *42*, 83.
- Barbara, P. F.; Jarzaba, W. *Adv. Photochem.* **1990**, *15*, 1.
- Miller, D. W.; Adelman, S. A. *Int. Rev. Phys. Chem.* **1994**, *13*, 359.
- Ravichandran, S.; Bagchi, B. *Int. Rev. Phys. Chem.* **1995**, *14*, 271.
- Taylor, R.; Kennard, O. *J. Am. Chem. Soc.* **1982**, *104*, 5063.
- Desiraju, G. R. *Acc. Chem. Res.* **1991**, *24*, 290.
- Han, S. W.; Kim, K. *J. Phys. Chem.* **1996**, *100*, 17124.
- Turi, L.; Dannenberg, J. J. *J. Phys. Chem.* **1993**, *97*, 7899.
- Turi, L.; Dannenberg, J. J. *J. Phys. Chem.* **1996**, *100*, 9638.
- Turi, L. *Chem. Phys. Lett.* **1997**, *275*, 35.
- Schneider, S.; Bierl, R.; Seischab, M. *Chem. Phys. Lett.* **1994**, *230*, 343.
- Weiner, A. M.; De Silvestri, S.; Ippen, E. P. *J. Opt. Soc. Am. B* **1985**, *2*, 654.
- Mokhtari, A.; Chesnoy, J. *Chem. Phys. Lett.* **1989**, *155*, 593.
- Walker, G. C.; Jarzaba, W.; Kang, T. J.; Johnson, A. E.; Barbara, P. F. *J. Opt. Soc. Am. B* **1990**, *7*, 1521.
- Mokhtari, A.; Chebira, A.; Chesnoy, J. *J. Opt. Soc. Am. B* **1990**, *7*, 1551.
- Yoshihara, K.; Yartsev, A.; Nagasawa, Y.; Kandon, H.; Douhal, A.; Kemnitz, K. *Pure Appl. Chem.* **1993**, *65*, 1671.
- Bardeen, C. J.; Shank, C. V. *Chem. Phys. Lett.* **1993**, *203*, 535.
- Lenz, K.; Pfeiffer, M.; Lau, A.; Elsaesser, T. *Chem. Phys. Lett.* **1994**, *203*, 340.
- Laubereau, A.; Seilmeier, A.; Kaiser, W. *Chem. Phys. Lett.* **1975**, *36*, 232.
- Zhong, Q.; Wang, Z.; Sun, Y.; Zhu, Q.; Kong, F. *Chem. Phys. Lett.* **1996**, *248*, 277.
- Zhong, Q.; Wang, Z.; Liu, Y.; Zhu, Q.; Kong, F. *J. Chem. Phys.* **1996**, *105*, 5377.
- He, Y.; Xiong, Y.; Wang, Z.; Zhu, Q.; Kong, F. *J. Phys. Chem. A* **1998**, *102*, 4266.