

Thermodynamics of Double Oxides. I. Some Aspects of the Use of CaF_2 -Type Electrolyte for Thermodynamic Study of Compounds Based on Oxides of Alkaline Earth Metals

V. A. LEVITSKII

Laboratory of Chemical Thermodynamics, Moscow State University, Moscow, B-234, USSR

Received June 21, 1976; in revised form November 1, 1977

The theory of the potentials of the cells with CaF_2 -type electrolyte and electrodes based on oxides of alkaline earth metals

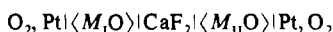

is proposed. The limits of utilization of CaF_2 as a function of partial oxygen pressure over electrodes are considered. The conditions of reversibility of the cells are analyzed for obtaining the thermodynamic parameters of the cell reactions under study. The theoretical analysis and experimental results demonstrate the possibilities of using such cells for thermodynamic study of new classes of refractory compounds based on oxides of alkaline earth and rare-earth or transition metals.

Introduction

The thermodynamic stability of condensed phases in the systems of the type $\text{MO}-\text{MeO}_2$, $\text{MO}-\text{Me}_2\text{O}_3$, and $\text{MO}-\text{Me}_2\text{O}$, etc., where M is Mg, Ca, Sr, or Ba, and Me is Ti, Zr, Hf, Al, Ga, Y, Ln, Ta, or Nb, etc., is of considerable interest for predicting the behavior of these systems at elevated temperatures. However, high-temperature thermodynamic data for most of the listed systems are practically lacking in the literature. The application of the well-known calorimetric methods and the emf method with an $[\text{O}^{2-}]$ -ion electrolyte to these systems frequently involves great experimental difficulties (1). Of great interest therefore is the emf method with a solid $[\text{F}^-]$ -ionic electrolyte, first used by Benz and Wagner to determine the thermodynamic properties of Ca silicates (2).

An electrochemical cell proposed in (2) can

be written in the general form as

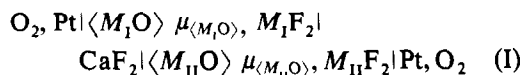

where $\mu_{\langle M_I \text{O} \rangle}$ and $\mu_{\langle M_{II} \text{O} \rangle}$ are the chemical potentials of oxides of alkaline earth metals or Mg in solid solutions or mixtures of double oxide compounds $\langle M_I \text{O} \rangle$ and $\langle M_{II} \text{O} \rangle$ which are at equilibrium with each other according to the phase diagrams. By way of example we consider the cell

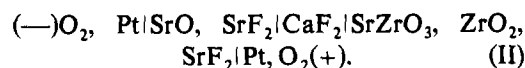

The overall cell reaction is a process of transfer of one mole SrO from the pure state to the heterogeneous mixture $\text{SrZrO}_3 + \text{ZrO}_2$:

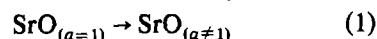

or



With the assumption of unipolar F^- -ionic conductivity of the electrolyte the change of the Gibbs energy of cell reaction (2) will be

$$\Delta G_2^0 = -2 \times F \times E_{II} = \mu_{(SrO)} - \mu_{(SrO)}^0 = RT \ln a_{(SrO)} \quad (3)$$

In recent years such cells have been used to determine the thermodynamic properties of some refractory oxide compounds for which it is almost impossible to use the emf method with an $[O^{2-}]$ -ion electrolyte.¹ It should be noted, however, that the mechanism of formation of the potentials of cells (1) as a function of additions of $M_I F_2$ and $M_{II} F_2$ to the electrodes and of the partial pressure of oxygen in the gas phase has not been studied up to now. The conditions of reproducibility of such cells in the thermodynamic study of phases based on oxides of alkaline earth metals are not quite clear.

In the present paper we give a general thermodynamic approach to the calculation of the potentials E of cells (1) as functions of the chemical potentials of the phase components incorporated in the electrodes under study. The limits of utilization of the CaF_2 electrolyte as a function of the partial oxygen pressure are considered. The thermodynamic conditions of reproducibility of such cells are analyzed. In conclusion we give the thermodynamic properties of $SrZrO_3$ and $BaZrO_3$, which are compared with the available data given elsewhere.

1. The Theory of the emf of the Cells with a Solid CaF_2 -Type Electrolyte

(a) *A model of the electrochemical cell with CaF_2 .* The available data on the interaction of oxygen and oxides of alkaline earth metals with CaF_2 and BaF_2 (3-7) point to a slight solubility of MO in MF_2 and allow one to assume that an analogous picture is encountered at the contacts of the electrodes $\langle M_I O \rangle$ and $\langle M_{II} O \rangle$ with CaF_2 . In this case the electrochemical cell (III) composed of the two

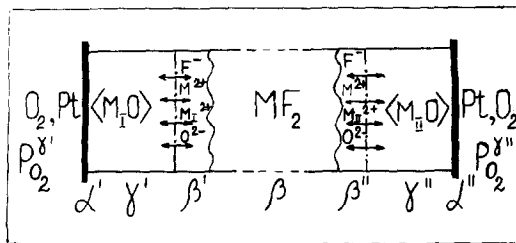

FIG. 1. Schematic representation of the cell III with CaF_2 ; the components of the cell electrodes and electrolyte are mutually soluble only slightly (for details, see the text).

oxide electrodes $\langle M_I O \rangle$ and $\langle M_{II} O \rangle$, the CaF_2 electrolyte and two different metal electrodes α' and α'' can be represented in the general form as a diagram displayed in Fig. 1. In this diagram γ' and γ'' are the electrodes consisting of solid solutions or equilibrium mixtures of oxides denoted by $\langle M_I O \rangle$ and $\langle M_{II} O \rangle$. The chemical potentials of these oxides are equal to $\mu\langle M_I O \rangle$ and $\mu\langle M_{II} O \rangle$, respectively. The electrodes of this cell differ from the electrodes of cell (1) in that they have no free fluorides $M_I F_2$ and $M_{II} F_2$ and the partial pressure of oxygen at the electrodes $P_{O_2}^{\gamma'}$ and $P_{O_2}^{\gamma''}$ is different and not fixed. The phases β' and β'' represent limited solid solutions of the oxides $M_I O$ and $M_{II} O$ in CaF_2 , which are at equilibrium with the corresponding electrodes γ' and γ'' at the "electrode/electrolyte" contacts. The solubility of oxides of alkaline earth metals in CaF_2 is very small.² This permits one to assume that dissolving the oxides $M_I O$ and $M_{II} O$ at the contacts with the electrolyte leaves the activity of CaF_2 in the phases β' and β'' virtually unaffected. And, conversely, dissolving CaF_2 in $\langle M_I O \rangle$ and $\langle M_{II} O \rangle$ does not affect the activity of the oxides $M_I O$ and $M_{II} O$ in the electrodes γ' and γ'' .

The measured potential difference E_{III} of this electrochemical cell will be equal to the

¹ The results of the first investigations along these lines are adequately covered in the review by Tretiakov and Kaul included in (1).

² According to (3, 4), the solubility of CaO and BaO in CaF_2 and BaF_2 at $800^\circ C$ is $\sim 1 \times 10^3$ and 4×10^3 mole fractions, respectively.

sum of potentials at the interfaces α'/γ' ; γ'/β' ; β'/β ; β/β'' ; β''/γ'' ; and γ''/α'' :

$$E_{\text{III}} = (\varphi^{\alpha''} - \varphi^{\gamma''}) + (\varphi^{\gamma'} - \varphi^{\alpha'}) + (\varphi^{\beta''} - \varphi^{\beta'}) + (\varphi^{\beta''} - \varphi^{\beta'}) + (\varphi^{\beta'} - \varphi^{\gamma'}). \quad (4)$$

The first two terms of Eq. (4) represent the difference of potentials at the metal/oxide interfaces. They can be determined from the condition of electrochemical equilibrium when the electrochemical potential of electrons of two phases at the interfaces α'/γ' and α''/γ'' is the same

$$\mu_{\langle e^- \rangle}^{\alpha''} - F\varphi^{\alpha''} = \mu_{\langle e^- \rangle}^{\gamma''} - F\varphi^{\gamma''}, \quad (5)$$

$$\mu_{\langle e^- \rangle}^{\alpha'} - F\varphi^{\alpha'} = \mu_{\langle e^- \rangle}^{\gamma'} - F\varphi^{\gamma'}. \quad (6)$$

Considering that $\mu_{\langle e^- \rangle}^{\alpha''} = \mu_{\langle e^- \rangle}^{\alpha'} = \mu_{\langle e^- \rangle}^{\text{Pt}}$ from relations (5) and (6) we get

$$(\varphi^{\alpha''} - \varphi^{\gamma''}) + (\varphi^{\gamma'} - \varphi^{\alpha'}) = \frac{1}{F} (\mu_{\langle e^- \rangle}^{\gamma'} - \mu_{\langle e^- \rangle}^{\gamma''}). \quad (7)$$

The third term of expression (4) is a diffusion potential at the interfaces $\beta' - \beta''$ which is determined in the general case by the

different rate of diffusion of anions and cations in the electrolyte (8, 9).

(b) *The transport properties of the CaF_2 electrolyte and calculation of the diffusion potential.* In the general case the chemical potentials of the components M_I , M_{II} , and O of the electrodes γ' and γ'' of cell III are different. This should give rise to a concentration gradient of the components and their diffusion through the electrolyte. In the case of CaF_2 the electrode components diffuse through the electrolyte in the form of M_I^{2+} , M_{II}^{2+} , O^{2-} , Ca^{2+} , and F^- ions, the diffusion coefficients of these particles being different (10-13). According to Wagner (8, 9), the diffusion potential

$$\varphi^{\beta''} - \varphi^{\beta'} = \int_{\beta'}^{\beta''} (d\varphi/dx) dx \quad (8)$$

occurring in such a system tends to equalize ionic fluxes:

$$\frac{d\varphi}{dx} = - \sum_i \frac{t_i}{q_i} \text{grad } \mu_i \quad (9)$$

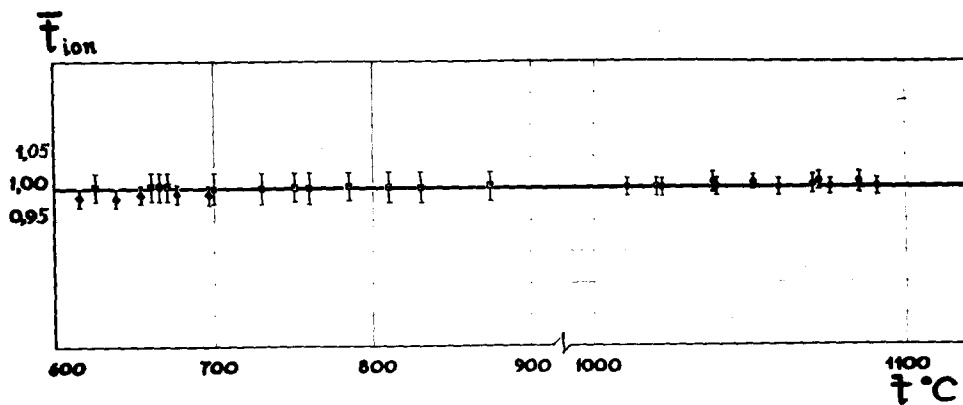
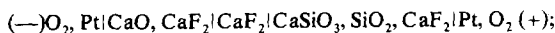
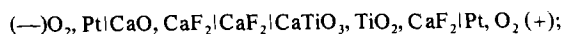

FIG. 2. The temperature dependence of t_{ion} of CaF_2 at $P_{\text{O}_2} \approx 1$ atm. Symbols: \square , values of t_{ion} calculated from the data (2) for the cell:



\diamond , values of t_{ion} calculated from the data (14) for the cell:



\odot , values of t_{ion} calculated from the data (15) for the cell:

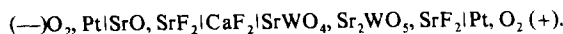

where t_i is the transference number for the i th ion with charge q_i and $\text{grad } \mu_i$ is the gradient of the chemical potential of the i th ion.

In real conditions of a thermodynamic experiment with cells (I–III) the gas phase (O_2 , $\text{N}_2 + \text{O}_2$, vacuum) always contains a certain amount of oxygen. In this context we consider the effect of oxygen of the gas phase on the ionic transference number for CaF_2 . Figure 2 gives the values t_{ion} for CaF_2 , which we have calculated from the experimental values E determined at $P_{\text{O}_2} \approx 1$ atm. in (2, 14, 15) for the cells:

- (—) $\text{O}_2, \text{Pt}|\text{CaO}, \text{CaF}_2|\text{CaF}_2|$
 $\text{CaSiO}_3, \text{SiO}_2, \text{CaF}_2|\text{Pt}, \text{O}_2 (+);$
 (—) $\text{O}_2, \text{Pt}|\text{CaO}, \text{CaF}_2|\text{CaF}_2|$
 $\text{CaTiO}_3, \text{TiO}_2, \text{CaF}_2|\text{Pt}, \text{O}_2 (+);$
 (—) $\text{O}_2, \text{Pt}|\text{SrO}, \text{SrF}_2|\text{CaF}_2|$
 $\text{SrWO}_4, \text{Sr}_2\text{WO}_5, \text{SrF}_2|\text{Pt}, \text{O}_2 (+);$

and from the reliable Gibbs energy values for the reactants of the reactions of these cells, determined in (16–18). The ionic transference numbers obtained from the data for each cell were found to be 1.00 ± 0.02 , 0.98 ± 0.03 , and 1.00 ± 0.01 , respectively. Figure 3 presents the average ionic transference numbers for CaF_2 , which we have calculated from the values of the total conductivity of CaF_2 obtained (6) at lower oxygen pressures.³ As is evident from Figs. 2 and 3, the average ionic transference number for CaF_2 within the given

³ The errors in the values of t_i were taken as the square root values of the sampling dispersion $\sigma_{t_i}^2$. The latter was determined from the formula:

$$\sigma_{t_i}^2 = \sigma_f^2 = (f'_x)\sigma_x^2 + (f'_y)\sigma_y^2,$$

where $f(x, y) = x/y = E_{\text{exp}}/E_{\text{therm}} = \sigma_{\text{ion}}/\sigma_{\text{tot}} = t_i$; σ_x^2 and σ_y^2 are sampling dispersions of the values E_{exp} , σ_{ion} , E_{therm} and σ_{tot} , accordingly.

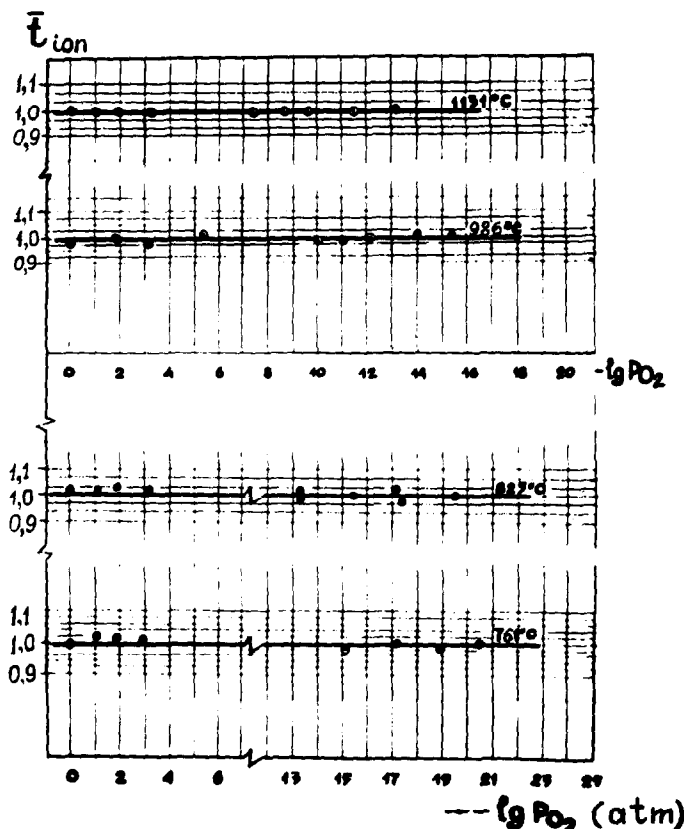

FIG. 3. The dependence of \bar{t}_{ion} of CaF_2 saturated with oxygen at $P_{\text{O}_2} = 1$ atm on the partial pressure of oxygen at $P_{\text{tot}} = 1$ atm.

errors is equal to unity over a broad range of temperatures and oxygen pressures.

Measurements of the diffusion coefficients in fluorides of alkaline earth metals made in recent years (10–13) have given conclusive evidence for a much lower rate of diffusion of calcium and strontium in CaF_2 as compared with that of fluorine in this electrolyte. The values of the cation conductivity σ_{cat} of CaF_2 , calculated with the use of the experimental dependences $t_{\text{cat}} = f(T)$ and $\sigma_{\text{tot}} = f(T)$ as determined in (6, 20), are found to be five or six orders smaller than σ_{tot} for CaF_2 for the same temperatures, which is indicative of a low cation conductivity of this electrolyte. A similar situation is observed in the case of CaF_2 when the oxygen concentration in the crystal is smaller than the intrinsic vacancy concentration of CaF_2 (Fig. 4). Our experiments on electrochemical transfer of oxygen through CaF_2 from oxide electrode to the metal one, made at 800–900°C in the cell $\text{Pt}|\text{Fe}|\text{CaF}_2|\text{FeO}, \text{Fe}_3\text{O}_4|\text{Pt}$ in an atmosphere precluding oxidation of iron through the gas phase bear out this point of view.⁴ Thus, the available data on the electrochemical properties of CaF_2 unambiguously testify to preferential F^- -ionic conductivity of this electrolyte over a wide temperature and oxygen pressure range. All this considered, the expression for the flux of charged particles (J_{F^-}) through the electrolyte layer of the cell (III) (Fig. 1) can be written, according to (8, 9), as

$$J_{\text{F}^-} = - \frac{\sigma_{\text{F}^-}}{q_{\text{F}^-}^2} \left(\frac{d\mu_{\langle \text{F}^- \rangle}}{dx} + q_{\text{F}^-} \frac{d\varphi}{dx} \right) = 0 \quad (10)$$

where σ_{F^-} is the electrical conductivity of CaF_2 and q_{F^-} is the effective charge of F^- ions. From this expression, taking into account Eq. (8), we find

$$\varphi^{\beta''} - \varphi^{\beta'} = \frac{1}{F} (\mu^{\beta''_{\langle \text{F}^- \rangle}} - \mu^{\beta'_{\langle \text{F}^- \rangle}}). \quad (11)$$

⁴ The formation of traces of the oxide phase on the interface of $\text{Fe}|\text{CaF}_2$ was observed only when the duration of experiment had been extended to a few days. The value of t_{of} calculated from the data (3, 6, 20) for intrinsic region of CaF_2 , saturated with oxygen at 1200–1000°C is equal to ≤ 0.01 .

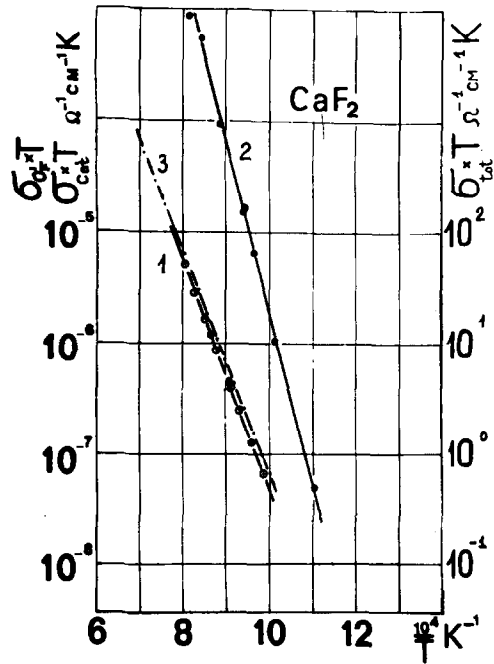

FIG. 4. The temperature dependence of the total, cation, and oxygen conductivity of CaF_2 in the coordinates $\log(\sigma \times T) = f(1/T)$. Graph 1: $\log(\sigma_{\text{tot}} \times T) = f(1/T)$. Graph 2: $\log(\sigma_{\text{cat}} \times T) = f(1/T)$. Graph 3: $\log(\sigma_{\text{O}_F} \times T) = f(1/T)$ [calculated from the data of (3, 6, 20); Graph 3 was obtained for intrinsic region of CaF_2 which is in equilibrium with the gas phase at $P_{\text{O}_2} = 1.10^{-5}$ Torr].

Summing expressions (7) and (11) and substituting them into Eq. (4) yields

$$E_{\text{III}} = \frac{1}{F} [(\mu^{\beta'_{\langle e^- \rangle}} - \mu^{\beta''_{\langle e^- \rangle}}) + (\mu^{\beta''_{\langle \text{F}^- \rangle}} - \mu^{\beta'_{\langle \text{F}^- \rangle}})] + \Delta\varphi \quad (12)$$

where $\Delta\varphi = (\varphi^{\beta''} - \varphi^{\beta'}) + (\varphi^{\beta'} - \varphi^{\beta''})$.

Expression (12) relates the value E_{III} of the cell (Fig. 1) to the chemical potentials of electrons in the oxides $\langle M_{\text{I}}\text{O} \rangle$ and $\langle M_{\text{II}}\text{O} \rangle$, to the chemical potentials of F^- ions at the interfaces β' and β'' and to the potentials at the electrode/electrolyte interfaces. Being general, this expression does not permit one, however, to directly calculate the value E_{III} since the values $\mu_{\langle e^- \rangle}$ and $\mu_{\langle \text{F}^- \rangle}$ in the phases β' , β'' ,

β' , and β'' are unknown and the value $\Delta\phi$ is not fixed. This problem can be solved using the proposed model of a concentration electrochemical cell with CaF_2 , the components of the electrodes and electrolyte of which are mutually soluble to a limited extent.

(c) *Calculation of $\Delta\phi$ and E of the cell (III).* The formation of the phases β' and β'' , which are at equilibrium with the electrodes γ' and γ'' , involves the exchange of F^- , Ca^{2-} , M_I^{2-} , and M_{II}^{2-} ions and of oxygen ions at the interface γ'/β' and γ''/β'' between the oxides and solid electrolyte. Taking into account the proposed cell model, let us consider equilibrium at the interfaces γ'/β' and γ''/β'' with respect to the most mobile fluorine ion and calculate the value $\Delta\phi$ from the condition of electrochemical equilibrium for this case. Let equilibrium be reached at the interfaces γ'/β' and γ''/β'' with respect to fluorine ions according to the reactions:

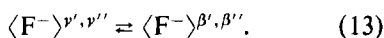

In this case the expression for $\Delta\phi$ will be

$$\Delta\phi = \frac{1}{F} (\mu_{\langle \text{F}^- \rangle}^{\gamma'} - \mu_{\langle \text{F}^- \rangle}^{\beta'} + \mu_{\langle \text{F}^- \rangle}^{\beta''} - \mu_{\langle \text{F}^- \rangle}^{\gamma''}). \quad (14)$$

Substituting Eq. (14) into Eq. (12) yields

$$E_{\text{III}} = \frac{1}{F} [(\mu_{\langle \text{F}^- \rangle}^{\gamma'} - \mu_{\langle e^- \rangle}^{\gamma'}) - (\mu_{\langle \text{F}^- \rangle}^{\beta'} - \mu_{\langle e^- \rangle}^{\beta'})].$$

Whence, using the obvious relation $\mu_{\langle \text{F}^- \rangle} = \mu_{\langle \text{F}^\times \rangle} + \mu_{\langle e^- \rangle}$ we find

$$E_{\text{III}} = \frac{1}{F} (\mu_{\langle \text{F}^\times \rangle}^{\gamma'} - \mu_{\langle \text{F}^\times \rangle}^{\beta'}). \quad (15)$$

If one fixes the values of the chemical potentials of fluorine atoms F^\times at the electrodes, e.g., by means of metals M_I and M_{II} , the value E_{III} in Eq. (15) will correspond to the emf of the cell: $\text{Pt} | M_I, M_I\text{F}_2 | \text{CaF}_2 | M_{II}, M_{II}\text{F}_2 | \text{Pt}$. Such cells have been used to advantage in recent years by a number of investigators to determine the thermodynamic properties of fluorides and alloys of transition

and rare-earth metals (1, 19, 21) and will not be considered here.

We transform Eq. (15) so that under certain conditions the equilibrium values of E of cells (I and II) could be calculated from it. For this purpose the values of the chemical potentials of fluorine and metals M_I and M_{II} will be expressed in terms of the chemical potentials of the corresponding fluorides with the aid of the obvious relation $\mu_{\langle \text{F}^\times \rangle} = \frac{1}{2}(\mu_{\langle \text{MF}_2 \rangle} - \mu_{\langle \text{M}^\times \rangle})$. Substituting this relation into Eq. (15) and taking into account the corresponding indices for the components of the electrodes γ' and γ'' , we get

$$E_{\text{III}} = \frac{1}{2F} [(\mu_{\langle \text{M}_I\text{F}_2 \rangle}^{\gamma'} - \mu_{\langle \text{M}_I\text{F}_2 \rangle}^{\beta'}) + (\mu_{\langle \text{M}_I^\times \rangle}^{\gamma'} - \mu_{\langle \text{M}_I^\times \rangle}^{\beta'})]. \quad (16)$$

One can see from Eq. (16) that the first term on the right side of this equation represents the difference of the chemical potentials of the fluorides $M_I\text{F}_2$ and $M_{II}\text{F}_2$ in γ' and γ'' and the second one is the difference of the chemical potentials of these metals in the same electrodes. In the case of the cell under consideration (Fig. 1), the values $\mu_{\langle \text{M}_I\text{F}_2 \rangle}^{\gamma'}$, $\mu_{\langle \text{M}_{II}\text{F}_2 \rangle}^{\gamma'}$, $\mu_{\langle \text{M}_I^\times \rangle}^{\gamma'}$, and $\mu_{\langle \text{M}_{II}^\times \rangle}^{\gamma'}$ are not fixed, therefore one cannot calculate from Eq. (16) the thermodynamic value E of cell (III), whose reaction would be, for example, reaction (2), without additional conditions. It can easily be shown, however, that the first term of Eq. (16) can be determined if the activities of the fluorides $M_I\text{F}_2$ and $M_{II}\text{F}_2$ in the left and right electrode will be equal to unity. In this case

$$\mu_{\langle \text{M}_I\text{F}_2 \rangle}^{\gamma'} - \mu_{\langle \text{M}_I\text{F}_2 \rangle}^{\beta'} = \mu_{\langle \text{M}_I\text{F}_2 \rangle}^{\circ} - \mu_{\langle \text{M}_I\text{F}_2 \rangle}^{\beta'}. \quad (17)$$

Since the values of the standard chemical potentials of $M_I\text{F}_2$ and $M_{II}\text{F}_2$ are assumed to be known, the first term of Eq. (16) can be calculated using, for example, reference thermodynamic tables.

Now consider the second condition of reversibility of the cell (Fig. 1). To this end we express the values $\mu_{\langle \text{M}_I^\times \rangle}^{\gamma'}$ and $\mu_{\langle \text{M}_{II}^\times \rangle}^{\gamma'}$ in the electrodes γ' and γ'' in terms of the correspon-

ding chemical potentials of oxides and oxygen:

$$\mu_{\langle M_1^x \rangle}^{y'} = \mu_{\langle M_1O \rangle}^{y'} - \mu_{\langle O^x \rangle}^{y'}$$

$$\mu_{\langle M_{II}^x \rangle}^{y''} = \mu_{\langle M_{II}O \rangle}^{y''} - \mu_{\langle O^x \rangle}^{y''}$$

Substituting these relations into Eq. (16) yields

$$E_{III} = \frac{1}{2F} [(\mu_{\langle M_1O \rangle}^{y'} - \mu_{\langle M_{II}O \rangle}^{y''}) + (\mu_{\langle O^x \rangle}^{y'} - \mu_{\langle O^x \rangle}^{y''}) + (\mu_{M_{II}F_2}^{\circ} - \mu_{M_1F_2}^{\circ})]. \quad (18)$$

It follows from Eq. (18) that the potential of the cell III with the different oxide electrodes $\langle M_1O \rangle$ and $\langle M_{II}O \rangle$ is determined not only by the difference $\mu_{M_{II}F_2}^{\circ} - \mu_{M_1F_2}^{\circ}$ but also by two terms: the difference of the chemical potentials of the oxides M_1O and $M_{II}O$ in γ' and γ'' and the difference of the chemical potentials of oxygen in γ' and γ'' . It is easy to express the latter in terms of the oxygen pressures over the electrodes $P_{O_2}^{y'}$ and $P_{O_2}^{y''}$, which can be checked in the course of experiment. Since $\mu_{\langle O^x \rangle}^{y'} = \mu_{\langle O^x \rangle}^{y''} + (RT/2) \ln P_{O_2}^{y'}$, expression (18) can be represented as

$$E_{III} = \frac{1}{2F} \left[(\mu_{\langle M_1O \rangle}^{y'} - \mu_{\langle M_{II}O \rangle}^{y''}) + (\mu_{M_{II}F_2}^{\circ} - \mu_{M_1F_2}^{\circ}) + \frac{RT}{2} \ln \frac{P_{O_2}^{y'}}{P_{O_2}^{y''}} \right]. \quad (19)$$

Because in the general case the values $P_{O_2}^{y'}$ and $P_{O_2}^{y''}$ are not fixed, the potential of cell (III) arbitrarily depends on the difference of the partial pressures of oxygen over the electrodes. Only on condition that

$$P_{O_2}^{y'} = P_{O_2}^{y''} \quad (20)$$

does expression (19) take the form

$$E_{III} = \frac{1}{2F} [(\mu_{\langle M_1O \rangle}^{y'} - \mu_{\langle M_{II}O \rangle}^{y''}) + (\mu_{M_{II}F_2}^{\circ} - \mu_{M_1F_2}^{\circ})] \quad (21)$$

and does it allow one to relate unambiguously the measured potential of the cell (III) to the difference of the chemical potentials of oxides in the left and right electrode.

II. Conditions of the Reversibility of the Cells (I) with the Electrodes on the Base of Oxides of Alkaline Earth Metals

It follows from the foregoing analysis that when conditions (17) and (20) are satisfied, expression (21) makes it possible to calculate the equilibrium potentials of cells (I and II) with complex oxide electrodes based, in particular, on oxides of alkaline earth metals. In fact, using Eq. (21) and assuming, for example, that the activity of the oxide $\langle M_1O \rangle$ in the left electrode is equal to unity and $M_1 = M_{II}$, we have

$$E = \frac{1}{2F} (\mu_{M_1O}^{\circ} - \mu_{\langle M_1O \rangle}^{y'}). \quad (22)$$

The last expression is identical to expression (3) for the equilibrium potential of cell (II) with strontium zirconate.

In a thermodynamic experiment the conditions of reproducibility of galvanic cells (I, II, and III) will be satisfied if:

(i) fluorides of the corresponding metals, whose activity in the initial electrode mixtures is equal to unity, are added to the cell electrodes;

(ii) the activities of these fluorides at the "electrode/electrolyte" interface in the course of experiment remain unchanged due to the interaction of the latter with the oxide phases, with oxygen of the gas phase and with the impurities which lead to hydrolysis of M_1F_2 and $M_{II}F_2$;

(iii) the oxygen pressure over both electrodes is equal.

A very important condition of reversibility of cells (1) is a correct selection of reference electrodes ensuring a reasonable accuracy of the thermodynamic values to be determined and a sufficiently high rate at which electrochemical equilibrium is reached at the interface γ'/β' . As is evident from relation (22), the use of free oxides of alkaline earth metals as reference electrodes is very convenient from the thermodynamic standpoint since the value ΔG_2° of reactions (2), calculated from this equation, are determined from the experimen-

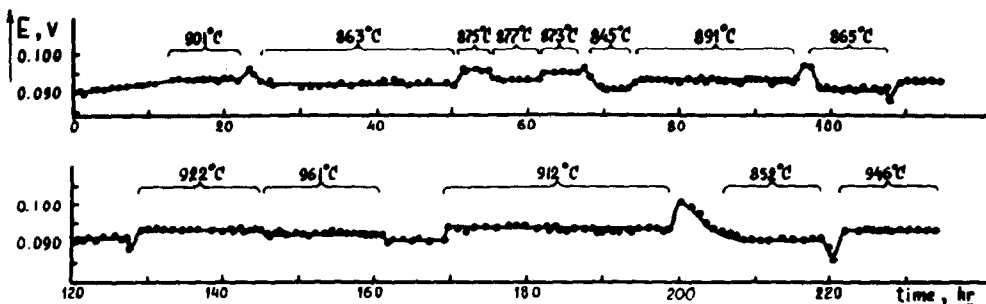

FIG. 5. A section of the kinetic curve of attainment of the equilibrium potential as a function of temperature for the cell:



The dots denote the values E measured at a slow increase or decrease in temperature and at $T = \text{const}$.

tal values E_{II} without recalculation with maximum accuracy. In this case errors in the determination of the required values $\mu^{p''}_{(MeO)}$ are determined only by experimental errors in the values E .

By way of example, Fig. 5 gives one of the typical curves of attainment of the equilibrium potential as a function of time, which we have obtained for cell (II) with a reference electrode $|SrO, SrF_2|$.⁵ An analysis of such curves indicates that the equilibrium values E of such cells are obtained during several hours after the admission of oxygen into the apparatus and the cells themselves remain reproducible within a few days.

It should be noted, however, that the use of free oxides of alkaline earth metals as reference electrodes involves some experimental disadvantages due to difficulties in their preparation and due to high hygroscopicity (especially in the case of BaO). The values of the standard chemical potentials of CaF_2 , CaO , SrF_2 , and BaF_2 and oxides such as MeO_2 , Me_2O_3 , Me_2O_5 ($Me = Ti, Zr, Al, Y, Ln, Ta, \text{etc.}$) available in the literature enable one to use the results of measurement of the Gibbs energy of the exchange reaction of the type

⁵ The thermodynamic parameters of the cell reaction $2SrO + SrAl_2O_4 \rightarrow Sr_3Al_2O_6$ are discussed in (15).



for the direct determination of the thermodynamic parameters of reactions involving the formation of barium- and strontium-oxide compounds from the elements, e.g.,

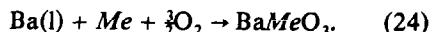

The cells where the least hygroscopic electrode with calcium oxide is used as a reference electrode turn out to be useful for this purpose. For example,

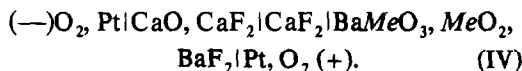

In this case the values of the Gibbs energy of reaction (23) will be related to the values E of cell (IV) and to the chemical potentials of CaF_2 , CaO , and BaF_2 by the relation

$$\begin{aligned} \Delta G_{23}^{\circ} = -2 \times F \times E_{IV} = & (\mu_{(BaO)}^{p''} - \mu_{(CaO)}^{\circ}) \\ & + (\mu_{(CaF_2)}^{\circ} - \mu_{(BaF_2)}^{\circ}). \end{aligned} \quad (25)$$

It is worth noting, however, that the value ΔG_{23}° , calculated from Eq. (25), involves a greater error than ΔG_2° does, because ΔG_{23}° , apart from experimental errors in the values E_{IV} , incorporates errors in the used standard thermodynamic functions of fluorides and oxides of alkaline earth metals.

Experimental Details⁶

For investigation we have chosen SrZrO₃ and BaZrO₃ because the reliable values of ΔH_{298}° , S_{298}° , and $C_p = f(T)$ for these compounds available in (16, 22–24) allow the results of the present work to be compared with independent calorimetric values.

In the literature there are no comprehensive data on the phase diagrams in the systems BaO–ZrO₂ and SrO–ZrO₂. We have examined the obscure parts of the diagrams of these systems in the region with a high ZrO₂ content in order to determine equilibrium phases coexisting with BaZrO₃ and SrZrO₃ in the electrodes being investigated. The X-ray diffraction analysis of heat-treated specimens has shown that in the systems BaO–ZrO₂ and SrO–ZrO₂ in the range from 50 to 100 mole% ZrO₂ the zirconates BaZrO₃ and SrZrO₃ coexist with ZrO₂ without noticeable regions of solid solutions of BaO and SrO in ZrO₂ and of ZrO₂ in BaZrO₃ and SrZrO₃. The electrodes were prepared by mixing $MeZrO_3$, ZrO₂, and MF₂ in an approximate proportion to the stoichiometric coefficients of the cell reactions. In order to obtain homogeneity and mechanical stability of the electrodes the pellets (about 5 mm in diameter and 1 to 3 mm thick) were subjected to annealing for 100 hr in evacuated double-walled silica ampoules. The X-ray study of the electrodes after heat treatment in vacuum and after electrochemical measurements did not reveal any noticeable interaction of the potential-forming equilibrium oxide phases of the electrodes with MF₂. This indicates that the condition $a_{MF_2} = 1$ is fulfilled in the course of experiments in the electrodes γ' and γ'' being investigated. Strontium and calcium oxides were prepared by decomposition of SrCO₃ and CaCO₃ in vacuum (1×10^{-5} – 5×10^{-6} Torr) at 1000–1100°C during 100 to 200 hr. The pellets of the electrodes |MO, MF₂| were heat-treated in

evacuated silica ampoules at 1000–1100°C during 100 to 200 hr to obtain better homogeneity and mechanical stability.

Plates of optical-quality CaF₂ single crystals, approximately 6 × 6 × 3 mm in size, were used as electrolyte. For the fulfillment of the third condition of reversibility of cells (I) ($P_{O_2}^{v'} = P_{O_2}^{v''}$) the measurements of the emf were made in an apparatus with the common gas space (Fig. 6). In this case the oxygen pressure was maintained constant at about 760 or 150⁷ Torr. Oxygen was first purified by passing it over concentrated H₂SO₄, activated CuO heated to 180°C, granulated KOH, P₂O₅, and through a trap cooled by liquid nitrogen.

The emf was measured with a high-resistance potentiometer accurate within ±(0.1–0.01) mV using the compensation method. The potentials E were considered to correspond to equilibrium if they were constant in time at constant temperature, were independent of the direction from which equilibrium temperature was approached, and were reproducible in subsequent runs. The equilibrium values E were obtained approximately 5 to 15 hr after the admission of oxygen into the reactor and remained stable in the temperature range covered during 3 to 8 days. The apparatus was held at a constant emf value for each temperature from 2 to 20 hr. In this time interval, variations in E were within ±0.001 V. The results of measurements were treated using the least squares method and represented in the form of equations:

$$E(\pm t_{0.05} \times S_E) = a(\pm t_{0.05} \times S_a) + b(\pm t_{0.05} \times S_b) \times T, \quad \text{volt}$$

where S_E is the rms error of the calculated value E , S_a , S_b are the errors in the terms a and b , and $t_{0.05}$ is the Student criterion for 95% probability.

⁶ The experimental part of this work has been accomplished together with Dr. Yu. Hekimov and Dr. Yu. Ya. Scolis.

⁷ Such a pressure of oxygen is obtained over liquid O₂ at the boiling temperature of liquid nitrogen.

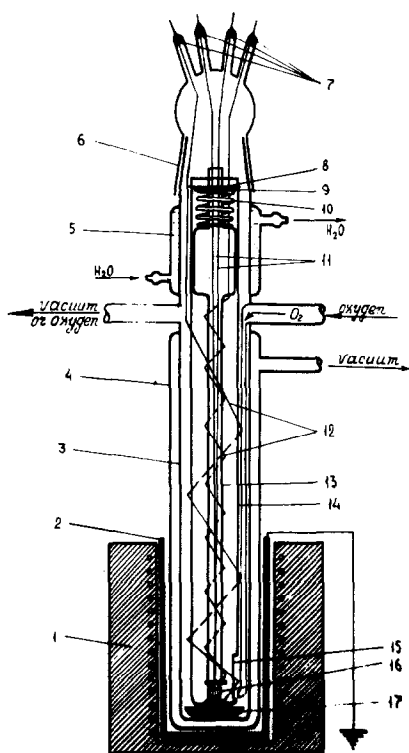

FIG. 6. A device for measuring E of cells (I) in oxygen and in vacuo: (1) resistance furnace; (2) metal screen; (3) silica reactor; (4) silica vacuum jacket; (5) silica water-cooled jacket; (7) electrical leads; (8) clamp; (9) washer; (10) compression spring; (11) Pt-Pt-Rh thermocouple; (12) Pt electrodes; (13) inner silica compression tube; (14) outer silica tube; (15) orifice for mounting electrodes and electrolyte and for oxygen admission; (16) electrolyte and electrodes; (17) ceramic cup with getter to remove reducing gasses in oxygen.

Results and Discussion

1. The Influence of Additions of Fluorides

Benz and Wagner (2), who used this method to study the thermodynamic properties of calcium silicates, pointed out that in view of low conductivity of compounds forming the electrodes it was necessary to introduce calcium fluoride into both electrodes to obtain equilibrium values of E . According to the foregoing analysis of the potentials of cells (I-III), addition of some amount of MF_2 to the electrodes ($a_{MF_2} = 1$) is necessary for fixing the

equilibrium potentials at the interfaces γ'/β' and γ''/β'' . Our experiments with cell (II) without additions of SrF_2 to the electrodes have shown that the potentials measured became constant quickly enough, remaining stable at constant temperature within a fairly long period of time (10 to 20 hr). However, as is evident from Fig. 7 (curve 2), the values E were much smaller than the emf values of cell (II) with additions of SrF_2 and were not reproducible with thermal cycling. An analogous picture was observed in (15). Such behavior of cells (I and II) without additions of MF_2 substantiates their nonequilibrium character and indicates that the added fluoride is directly involved in the processes which cause electrochemical equilibrium to be reached at the electrodes. Since the measured values E of the nonequilibrium cells do not permit one to obtain true values of the thermodynamic parameters of reactions (2, 24), the addition of MF_2 to the electrodes γ' and γ'' of cells (I-III) is especially important in cases where the oxide electrodes and electrolyte have different cations.

2. The Thermodynamic Properties of $SrZrO_3$

The experimental values E of cell (II) are presented in Fig. 7 and in Table I. From the values E of this cell for reaction (2) we find in the interval 1180-1360°K: $\Delta G_2^0(\pm 0.5) = -(19.5 \pm 3.1) - (0.86 \pm 2.5) \times 10^{-3} T$ kcal/mole.

Combining this equation with the corresponding thermodynamic functions for SrO and ZrO_2 (16, 17, 23, 25) yields for the reactions:

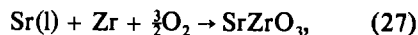
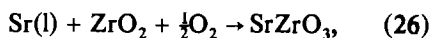

in the same temperature range:

$$\Delta G_{26}^0 = -(165.1 \pm 3.2) - (23.7 \pm 2.6) \times 10^{-3} T \text{ kcal/mole,}$$

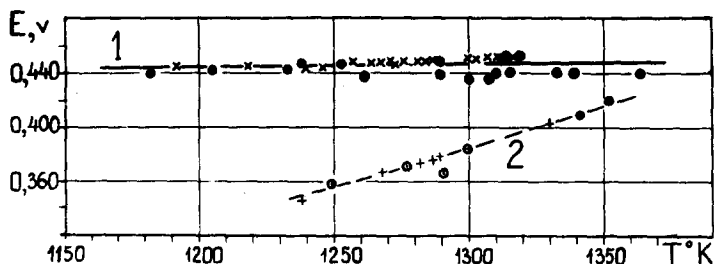

FIG. 7. The temperature dependence of the potentials of the cells:

(1): O₂, Pt|SrO, SrF₂|CaF₂|SrZrO₃, ZrO₂, SrF₂|Pt, O₂;

(2): O₂, Pt|SrO|CaF₂|SrZrO₃, ZrO₂|Pt, O₂.

●, ○, values of E kept constant at T_{const} not less than 2 hr; ×, +, values of E measured with gradial variation in temperature ($\sim 30^\circ\text{K hr}^{-1}$).

$$\Delta G_{27}^\circ = -(427.4 \pm 3.3) - (68.1 \pm 2.7) \\ \times 10^{-3} T \text{ kcal/mole.}$$

In the literature there are no data on the thermodynamic properties of SrZrO₃ at elevated temperatures with the exception of $C_p = f(T)$ determined in (24). In order to compare the data obtained herein for reaction

(2) with the calorimetric value ($\Delta H^\circ (2)_{298} = -17.8 \pm 1.5$),⁸ found in (22), the Third Law

⁸This value was calculated from the calorimetric heat of the reaction SrCO₃ + ZrO₂ → SrZrO₃ + CO₂ (gas), determined in (22) at 298°K, and from the standard enthalpy values for the formation of SrO, CO₂, and SrCO₃ given in (23, 16). Using the values of ΔH_f° for SrO and SrCO₃ recommended in (30), for $\Delta H^\circ (2)_{298}$ one gets -17.9 ± 0.6 kcal/mole.

TABLE I

EXPERIMENTAL RESULTS FOR THE EMF OF THE CELL (II): 1 ATM O₂, Pt|SrO, SrF₂|CaF₂|SrZrO₃, ZrO₂|Pt, O₂ 1 atm AND THE THERMODYNAMIC PARAMETERS OF THE REACTION (2) SrO + ZrO₂ → SrZrO₃^a

T (°K)	T_{const} (hr)	E_{const} (hr)	E (Volts)	$\pm \Delta E$ (Volts)	$-\Delta G_f^\circ$ (kcal/mole)	$-\Delta H_{298}^\circ$ (kcal/mole)
1182	11.5	11.5	0.4398	0.0029	20.28 ± 0.13	17.50
1203	19.5	18.0	0.4434	0.0026	20.45 ± 0.12	17.60
1233	8.0	8.0	0.4433	0.0028	20.45 ± 0.11	17.52
1238	12.5	11.5	0.4485	0.0022	20.69 ± 0.10	17.75
1258	21.0	21.0	0.4475	0.0017	20.64 ± 0.08	17.65
1257			0.4500	0.0031	20.75 ± 0.14	17.75
1262	8.0	7.0	0.4356	0.0011	20.09 ± 0.05	17.09
1289	8.0	7.0	0.4385	0.0016	20.22 ± 0.07	17.09
1289	12.0	12.0	0.4506	0.0044	20.78 ± 0.20	17.65
1300	2.0	2.0	0.4348	0.0007	20.05 ± 0.03	17.00
1307	8.0	8.0	0.4341	0.0034	20.02 ± 0.16	16.90
1310	2.0	2.0	0.4385	0.0012	20.22 ± 0.05	17.09
1312	8.5	8.5	0.4558	0.0022	21.02 ± 0.10	17.88
1315	3.0	3.0	0.4399	0.0020	20.29 ± 0.09	17.14
1317	6.5	6.5	0.4547	0.0012	20.97 ± 0.05	17.81
1333	24.0	23.5	0.4402	0.0032	20.30 ± 0.15	17.10
1339	6.0	6.0	0.4396	0.0028	20.28 ± 0.13	17.08
1364	17.0	16.0	0.4395	0.0011	20.27 ± 0.05	17.00
Mean values:				±0.0022		17.37 ± 0.55

^a Calorimetric value $\Delta H_{298}^\circ = -17.9 \pm 0.6$ kcal/mole.

TABLE II

EXPERIMENTAL RESULTS FOR THE EMF OF THE CELL (IV): $O_2, Pt|CaO, CaF_2|CaF_2|BaZrO_3, ZrO_2, BaF_2|Pt, O_2$
AND THE THERMODYNAMIC PARAMETERS OF THE REACTION (24): $Ba(l) + Zr + \frac{1}{2}O_2 \rightarrow BaZrO_3$

T ($^{\circ}K$)	E (Volts)	$\pm \Delta E$ (Volts)	$t(E)$ (hr) ^a	$-\Delta G_f^{\circ}(23)$ (kcal/mole)	$-\Delta S_f^{\circ}(24)$ (e.u.)	$-\Delta H_{298}^{\circ}(24)$ (kcal/mole)	$-\Delta H_f^{\circ}(24)$ (kcal/mole)
1193	0.3358	0.0005	11.0	15.49 ± 0.02	68.13	427.09	425.83
1209	0.3361	0.0005	2.0	15.05 ± 0.02	68.08	427.08	425.86
1219	0.3358	0.0007	7.0	15.46 ± 0.03	68.04	427.02	425.83
1238	0.3349	0.0005	2.0	15.45 ± 0.02	67.98	426.93	425.80
1242	0.320	0.0010	7.0	15.04 ± 0.05	67.96	426.53	425.41
1254	0.3333	0.0003	11.0	15.37 ± 0.01	67.92	426.78	425.69
1284	0.3302	0.0009	14.0	15.23 ± 0.04	67.82	426.51	425.52
1297	0.3272	0.0003	2.0	15.09 ± 0.01	67.77	426.31	425.35
1320	0.3246	0.0008	10.0	14.97 ± 0.04	67.70	426.80	425.42
Mean values:					67.93 ± 0.29	426.73 ± 0.58	425.63 ± 0.44
Calorimetric value $\Delta H_{f,298}^{\circ} = -425.3 \pm 1.6$ kcal/mole.							

^a $t(E)$ is the time during which E remained constant.

treatment of the values E of cell (II) has been employed. The calculated values $\Delta H^{\circ}(2)_{298}$ are tabulated in Table I. The absence of any trend for variation in $\Delta H^{\circ}(2)_{298}$ with temperature is indicative of the absence of systematic errors in the measured values E_{IV} . The average value $\Delta H^{\circ}(2)_{298}$, calculated from the Third Law (-17.4 ± 0.5 kcal/mole), agrees within the limits of errors with the value $\Delta H^{\circ}(2)_{298} = -17.9 \pm 0.6$ kcal/mole determined calorimetrically. Taking the mean value ($\Delta H^{\circ}(2)_{298} = -17.7 \pm 0.8$ kcal/mole) and using the standard heats of formation of SrO and ZrO_2 , given in (25, 26) and recommended for use by the working group CODATA, as well as S_{298}° for Sr(s), Zr(s), $O_2(g)$, and $SrZrO_3$ (16, 18, 23), for the reaction

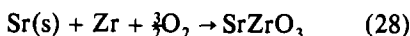

we find at 298°K:

$$\Delta H^{\circ}(28)_{298} = -425.2 \pm 0.9 \text{ kcal/mole;}$$

$$\Delta G^{\circ}(28)_{298} = -405.0 \pm 0.9 \text{ kcal/mole.}$$

These values may be recommended for use instead of those adopted in (23, 27).

3. The Thermodynamic Properties of $BaZrO_3$

The results of measurement of the emf of cell (IV) with $BaZrO_3$ are presented in Table II. From the dependence $E_{IV} = f(T)$ of this cell for reaction (23) in the interval 1180–1320°K we find:

$$\Delta G_{(23)}^{\circ}(\pm 0.2) = -(20.5 \pm 2.3) \\ + (4.15 \pm 1.86) \times 10^{-3} T \text{ kcal/mole.}$$

The Third Law treatment of the obtained values E_{IV} is given in Table II. The thermodynamic functions of CaO, CaF_2 , ZrO_2 , BaF_2 , and $BaZrO_3$ are taken from (16, 17, 23, 24, 28). The absence of a systematic trend for increase or decrease in the values $\Delta H^{\circ}(24)_{298}$ with temperature and a good agreement of the mean value (-426.7 ± 0.6 kcal/mole) with the independent calorimetric value (-425.3 ± 1.6 kcal/mole) recommended in (23) favor the validity of the values E_{IV} obtained.

Thus, the analysis of the data for $BaZrO_3$ suggests that the cells of type (IV) can be used for the direct determination of enthalpies and Gibbs energies of the reactions involving the formation of such oxides from the elements.

In fact, taking from Table II the mean values ΔH_T° (24) and ΔS_T° (24) for reaction (24) with BaZrO_3 in the range 1180–1320°K, one obtains: ΔG° (24) = $-(425.6 \pm 1.5) + (67.9 \pm 0.9) \times 10^{-3} T$ kcal/mole. Using the thermodynamic properties of BaO and ZrO_2 (16, 17, 23, 25, 29), it is easy to find the change in the Gibbs energy for the reaction involving the formation of BaZrO_3 from oxides for the same temperature range:

$$\Delta G^\circ = -(32.1 \pm 1.6) - (0.5 \pm 1.1) \times 10^{-3} T \text{ kcal/mole.}$$

One can see from the dependences $\Delta G^\circ = f(T)$, obtained for the reactions of the formation of SrZrO_3 and BaZrO_3 from the oxides and elements, that changes in the entropy for reactions (2) and (24) with SrZrO_3 are in good agreement with ΔS_T° for similar reactions with isostructural BaZrO_3 .

Conclusion

Thus, the experimental results prove the validity of the theoretical approach to the calculation of the potentials of the cells (I) in which the components of the CaF_2 -type electrolyte and electrodes based on oxides of alkaline earth metals are mutually soluble only slightly and current transport through the electrolyte is effected by fluorine ions. In particular, the fulfilment of the conditions of the reversibility of the cells (I) formulated above gives the possibility to determine with sufficiently high accuracy the thermodynamic parameters of the reactions of the formation of alkaline earth oxide compounds from the oxides and from the elements. The analysis of transport properties of CaF_2 shows that within the uncertainty limits of thermodynamic data obtained and total conductivity measurements, the usefulness of CaF_2 as a solid electrolyte extends down to low oxygen activities. Since the potentials of the cells considered depend on the chemical potentials of nonmetal (F and O) at the electrodes, the expressions of the type

(18) and (19) allow us to determine the unknown chemical potential (f.e. μ''_{O^\times}) from emf data of the cell studied and the chemical potentials of the components of the electrodes if the values of these potentials can be fixed in the process of the experiment.

Thus, the results of the present investigation indicate some promising possibilities of using the cells (I) for thermodynamic study of new classes of refractory compounds based on oxides of alkaline-earth and rare-earth or transition metals which can possess intermediate valency and exist under equilibrium conditions at low oxygen pressures.

Acknowledgment

The author is very grateful to Professor C. Deportes and Dr. V. N. Chebotin for the helpful discussions of the results of the present work.

The author expresses his deep gratitude to Professor Ya. I. Gerassimov for his valuable comments and encouragement throughout this investigation.

References

1. J. HLADIK (Ed.), "Physics of Electrolytes," Academic Press, London/New York (1972).
2. R. BENZ AND C. WAGNER, *J. Phys. Chem.* **65**, 1308 (1961).
3. W. L. PHILLIPS AND J. HANLON, *J. Amer. Ceram. Soc.* **46**, 1269 (1964).
4. E. BARSIS AND A. TAYLOR, *J. Chem. Phys.* **48**, 4357 (1968).
5. K. MUTO AND K. AWAZU, *J. Phys. Chem. Solids* **29**, 1269 (1968).
6. V. A. LEVITSKII, A. AMMOU, M. DUCLLOT, AND C. DEPORTES, *J. Chim. Phys.* **73**, 305 (1976).
7. V. A. LEVITSKII, A. AMMOU AND M. DUCLLOT, *J. Solid State Chem.* **20**, 4, 13 (1977).
8. C. WAGNER, *Z. Phys. Chem. Abt. B* **21**, 25 (1933).
9. C. WAGNER, in "Advances in Electrochemistry and Engineering" (P. Delhay, Ed.), Vol. 4, pp. 1–46, New York Univ., New York, Sydney, 1966.
10. M. BAKER AND A. TAYLOR, *J. Phys. Chem. Solids* **30**, 1003 (1969).
11. HJ. MATZKE, *J. Materials Sci.* **5**, 831 (1970).
12. M. F. BERARD, *J. Amer. Ceram. Soc.* **54**, 144 (1971).
13. R. W. SCHEIDECKER AND M. F. BERARD, *J. Amer. Ceram. Soc.* **59**, 431 (1976).

14. T. N. REZUKHINA, V. A. LEVITSKII, AND M. YA. FRENKEL, *Izv. Acad. Nauk USSR Neorganich. Mat.* **2**, 325 (1966).
15. V. A. LEVITSKII AND YU. YA. SCOLIS, *J. Chem. Thermod.* **6**, 1181 (1974).
16. O. KUBASHEWSKI, E. EVANS, AND C. B. ALCOCK, 'Metallurgical Thermochemistry', Pergamon, London (1967).
17. D. R. STULL AND H. PROPHET, "JANAF Thermochemical Tables," second ed. USA (1972).
18. K. K. KELLEY, S. S. TODD, AND E. G. KING, *U.S. Bur. Mines Rep. Invest.* N 5050 (1954).
19. T. N. REZUKHINA, B. S. POKAREV, T. F. SISOEVA, L. I. HOLOKHONOVA, AND E. G. IPPOLITOV, *J. Chem. Thermod.* **3**, 369 (1971); **6**, 883 (1974).
20. V. A. LEVITSKII, M. DUCLLOT, A. AMMOU, AND C. DEPORTES, *Russ. J. Phys. Chem.* **51**, 3045 (1977).
21. W. H. SKELTON AND J. W. PATTERSON, *J. Less-Common Metals* **31**, 47 (1973).
22. A. S. LVOVA AND N. N. FEDOSIEV, *Russ. J. Phys. Chem.* **34**, 28 (1964).
23. V. B. PARKER, D. D. WAGMAN, AND W. H. EVANS "Selected Values of Chemical Thermodynamic Properties," Technical Note 270-6, Nat. Bur. Stand. USA (1971).
24. V. A. LEVITSKII, D. TSAGARESHVILI, AND G. G. GVELESIANI, *Russ. J. Teplophisika Visokich Temperatur* **14**, 78 (1976).
25. A. N. KORNILOV, I. N. USHAKOVA, AND S. M. SKURATOV, *Russ. J. Phys. Chem.* **41**, 200 (1967).
26. A. D. MAH, *U.S. Bur. Mines Rep. Invest.* N 6171 (1963), N 6415 (1964).
27. M. H. KARAPETIANZ AND M. L. KARAPETIANZ, "Osnov. Therm. Konst. Neorg. Veschestv.," Publish. House "Chemistry," Moscow (1968).
28. L. V. GURVICH *et al.*, "Spravochnik Thermod. Svoistva Individ. Veschestv.," Publish. House Acad. Nauk USSR, Moscow (1962).
29. G. C. FITZGIBBON, E. I. HUBER, JR., AND C. E. HOLLEY, JR., *J. Chem. Thermod.* **5**, 577 (1973).
30. G. B. NAUMOV, B. N. RIJONKO, AND I. L. HODAKOVSKII, "Spravochnik Thermod. Velichin," Moscow, Publish. House Atomizdat (1971).