

Study of the Interaction of β' -Alumina Ceramic with Sodium at Elevated Temperature

P. D. YANKULOV,¹ G. STAIKOV, A. YANAKIEV, R. KVACHKOV,
P. V. ANGELOV, AND E. BUDEVSKI

*Central Laboratory of Electrochemical Power Sources, Bulgarian Academy
of Sciences, 1040-Sofia, Bulgaria*

Received May 20, 1985

The processes proceeding during contact of β' -alumina ceramic with molten sodium and sodium vapor in the presence and absence of electric current are investigated. The kinetics of chemical coloration was studied. It is shown that the rate of this process is the same for the contact with molten sodium and with sodium vapor. It was established that in the presence of an electric current flow the rate of chemical coloration changes considerably. The results obtained are explained on the basis of De Jonghe's mechanism for the interaction between β' -alumina ceramic and sodium, involving the formation of F centers, and Mott and Gurney's model for the influence of an electric field on the drift rate of F centers in alkali halides. © 1986 Academic Press, Inc.

Introduction

One of the most serious problems connected with the development of the sodium-sulfur battery is its lifetime without decrease in capacity and/or discharge voltage. The characteristics of the battery are determined by the properties of the solid electrolyte which should possess high ionic conductivity, high mechanical strength, and resistance to effect of the electrode materials. At present the most widely used solid ionic conductor is β -alumina. It is known that during battery operation the ion-conductive membranes are subjected to two types of degradation (1, 2): (i) rapid (which is a result of the propagation through the membrane wall of preexisting sodium filled cracks under the action of

electric current (3-9)); and (ii) slow (which is connected with the deposition of sodium in the bulk of the solid electrolyte by the so-called internal electrolysis, which leads to microcracking of the membrane (1, 10)). The development of the rapid degradation (mode I according (2)) strongly depends on the density of the current flowing through the membrane wall during charge of the battery. A limit current density exists below which this mode of degradation does not proceed. Its value depends on the quality of the membrane.

Systematic studies of the slow degradation (mode II according (2)) were performed by De Jonghe (1, 10) who, on the basis of his model, determined the factors which most strongly affect its apparition and development: polarization at the β -alumina/sodium polysulfide interface, increased resistivity of the electrolyte due to

¹ To whom correspondence should be addressed.

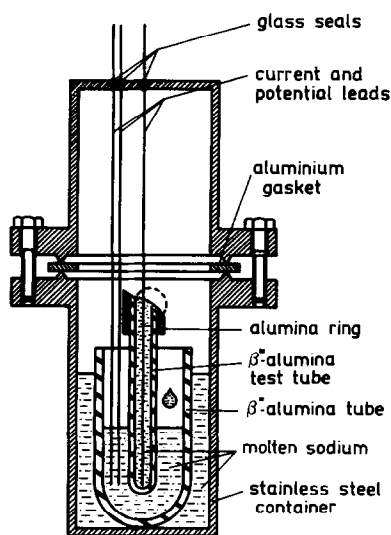

FIG. 1. Diagram of the experimental cell.

the presence of impurities, large thickness of the membrane wall, and increased charge current density. According to (10) the slow degradation is preceded and facilitated by the chemical interaction of the molten sodium with the solid electrolyte reflected by the coloration of the ceramic in contact with sodium even in the absence of electric current. In the literature (10-14) there are some differing opinions concerning the influence of current and/or of the contact with molten sodium or sodium vapor on the processes of degradation and chemical coloration. In the present paper the results of the investigation of the processes proceeding at the contact between β -alumina membranes produced in our laboratory with molten sodium and sodium vapor in the presence and absence of electric current are reported.

Experimental

The studies were performed in a specially constructed experimental cell which is shown schematically in Fig. 1. The cell is

made of stainless steel and makes it possible to study the influence of the electric current flow on the interaction between the solid electrolyte and molten sodium. This is due to the fact that the ion-conducting membrane is immersed only to a certain depth in the outer sodium electrode and no current flows in its upper part. The two faces of the membrane (external and internal) in the upper part are subjected to two different environments (the internal one is in contact with molten sodium and the external one with sodium vapor). As a consequence the study of the interaction between the ceramic and metallic sodium or sodium vapor in the absence of electric current becomes possible.

The experiments were performed using high purity sodium obtained by electrolysis through the large β' -alumina membrane (thus the outer sodium electrode is formed).

All experiments were carried out under galvanostatic conditions at a current density of $1 \text{ A} \cdot \text{cm}^{-2}$. The electrolysis was performed continuously in one direction only (pumping the sodium inside the tested membrane).

During the experiments it was possible to follow the changes in Faradaic efficiency of the electrolysis for the tested membrane, which in turn is a measure of the contribution of the electronic conductivity of the solid electrolyte to its total conductivity and therefore for the development of the degradation processes. The change in the Faradaic efficiency is estimated from the periodic voltage oscillations due to the fall of the sodium drop from the internal compartment of the tested membrane which leads to the periodic change in the height of the meniscus of the molten metal and consequently in the resistance of the current lead.¹

¹ This is why in the experimental cell shown in Fig. 1 no potential probe was used for the internal sodium electrode (cathode).

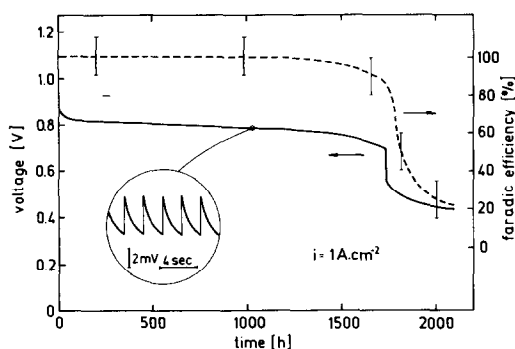

FIG. 2. Typical dependence of the voltage and Faradaic efficiency on time. In the inset the periodic voltage oscillations used for estimating the Faradaic efficiency are shown on an expanded scale.

All experiments were performed at $350 \pm 1^\circ\text{C}$.

The tested membranes were fabricated according to the laboratory technique developed in our laboratory (15). The nominal composition is 8.9 wt% Na_2O , 0.75 wt% Li_2O , and the balance Al_2O_3 . The sintering of the isostatically pressed membranes was carried out in two steps at 1610 and 1590°C for 4 and 15 min, respectively. The phase composition of the sintered ceramic was determined by X-ray diffractometry and showed that it consisted of more than 95% $\beta''\text{-Al}_2\text{O}_3$. The microstructure was examined by optical microscopy. The average grain size was about 5 μm .

After given time intervals the experiments were interrupted and the membranes were removed from the cell. They were washed in absolute alcohol and were subjected to careful examination. Longitudinal and transverse cross-sections were prepared from the membranes for microscopic examination. In some cases thin sections were made for observation in transmitted light.

In order to enhance the coloration of the ceramic, which is a result of its interaction with molten sodium or sodium vapor, the silver staining method described in (16) was employed for some samples.

Results and Discussion

Figure 2 shows a typical result of long term testing of a β'' -alumina membrane. It illustrates the change of the voltage of the experimental cell as a function of time, respectively, of the quantity of electricity. The same figure shows the change of the Faradaic efficiency during the experiment. As can be seen up to about $1770 \text{ Ah} \cdot \text{cm}^{-2}$ the characteristics of the membrane do not change substantially. After that the decrease in the cell voltage is accompanied by a drastic decrease in Faradaic efficiency which is indicative of the appearance of a considerable electronic conductivity due most probably to the penetration of sodium dendrites through the membrane wall (degradation mode I). The analysis of transverse and longitudinal sections of such membranes showed that there are sodium filaments crossing the membrane wall. The results of our experiments indicate that for the given current density ($1 \text{ A} \cdot \text{cm}^{-2}$) the failure of the membranes takes place after more than 1500 hr.

The careful examination of the internal (cathodic) face of the membrane showed the gradual blackening of the ceramic in the region in which electric current flows. Figure 3 represents a photograph of such a face

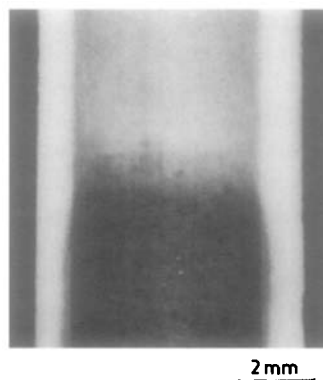

FIG. 3. Photograph of the internal (cathodic) face of a β'' -alumina membrane through which $800 \text{ Ah} \cdot \text{cm}^{-2}$ have flowed.

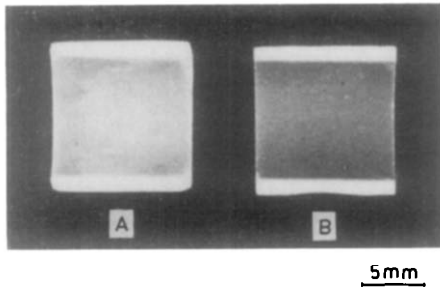

FIG. 4. Photograph of the cathodic faces of two membranes of β'' -alumina through which different quantities of electricity have flowed; (a) $300 \text{ Ah} \cdot \text{cm}^{-2}$; (b) $800 \text{ Ah} \cdot \text{cm}^{-2}$.

of the membrane through which $800 \text{ Ah} \cdot \text{cm}^{-2}$ have flowed at the boundary between the active and inactive part of the membrane (i.e., in the region of the sodium level in the outer electrode compartment; or of the boundary between the regions in which the current has flowed and not flowed). The membrane was not stained in silver nitrate solution. As can be seen there is a substantial blackening of the ceramic in the region in which the electric current has flowed. It should be noted that at the anodic (outer) face of the membrane no such blackening is observed. The analysis of cross sections of these membranes indicates that this blackening propagates as a dark damaged layer in the bulk of the ceramic which is due to the bulk deposition of sodium. The formation of such a layer was mentioned by De Jonghe *et al.* (1) in membranes cycled in sodium-sulfur battery cells and was called slow degradation or degradation mode II. In accord with these observations we found that the thickness of the damaged layer and the degree of blackening at the surface of the membranes increase with the quantity of electricity. Figure 4 represents a micrograph of the cathodic faces of two membranes through which 300 and $800 \text{ Ah} \cdot \text{cm}^{-2}$ have flowed.

Long prior to the beginning of the described degradation mode II, a considera-

bly weaker coloration (darkening) of the ceramic is observed in the electrochemical sodium-sodium cells. Such a darkening was observed by several authors and was called chemical coloration of β'' -alumina. It is a result of the interaction of the ceramic without current both with molten sodium and sodium vapor. As already noted this coloration may be enhanced by immersing the ceramic in a melt or a solution of silver nitrate.

Our microscopic observations of longitudinal and transverse sections of the membranes after staining with silver nitrate indicate that the chemical coloration propagates as a layer in the bulk of the ceramic. An interesting result is shown in Fig. 5 from which it is seen that all other conditions being equal the rate of the coloration process of the ceramic is the same as in the case of the contact with molten sodium and sodium vapor.

According to De Jonghe (10, 11) the cause of the development of this coloration is the chemical interaction of $\beta''\text{-Al}_2\text{O}_3$ ceramic with sodium which leads to the formation of electronically compensated oxygen vacancies in the spinel blocks according to the reaction:

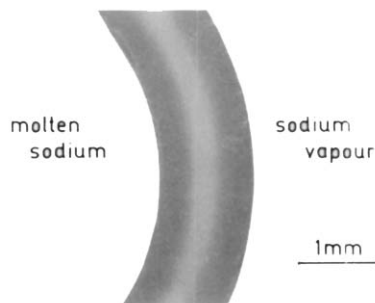
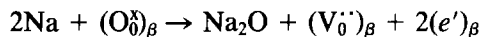

FIG. 5. Micrograph of a thin section of a membrane of β'' -alumina in the region in which no current has flowed. Time of exposure to molten sodium and sodium vapor—1500 hr.

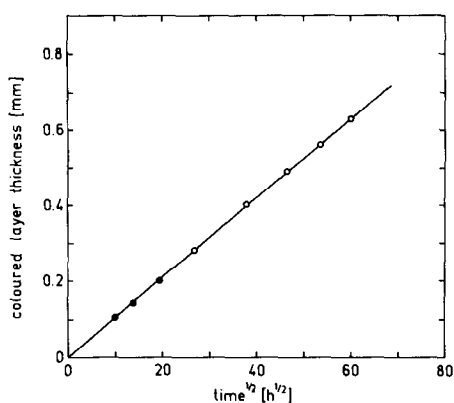

FIG. 6. Dependence of the chemically colored layer thickness, resulting from the interaction between the ceramic and molten sodium, on the square root of time in the absence of electric field. The black dots are taken from Ref. (11).

The results published in (11) demonstrate that for times up to 400 h a parabolic dependence exists between the thickness of the chemically colored layer and time. This suggests a diffusion-controlled process of the coloration. In addition these authors observe an increase of the rate of coloration with the decrease in grain size which is an indication that the diffusion proceeds mainly along the grain boundaries.

Taking into account the lifetime requirements for sodium-sulfur batteries we performed studies of the kinetics of the process of chemical coloration in molten sodium of β'' -alumina samples at 350°C for times ranging to 4000 hr. As seen in Fig. 6 the results obtained once again show a parabolic law for the rate of coloration. Since the chemical and phase composition, the microstructure of the ceramic samples (average grain size 5 μm) and the experimental conditions in our experiments and these of De Jonghe *et al.* (11) were approximately identical we thought it possible to compare the results obtained in the two laboratories. As seen in Fig. 6 in the two cases the rates of chemical coloration are identical.

Let us assume in accord with (11) that the coloration of β'' -alumina is due to the formation of F centers, constituted by oxygen vacancies compensated by two electrons, and that the rate of coloration is determined by the mobility of these centers. Then by analogy with observations on the mobility of F centers in an electric field in the case of alkali halides (17, 18) we can expect an influence of the electric field on the rate of advance of the colored layer in the bulk of the β'' -alumina ceramic. In fact such an effect was observed in our experiments and is demonstrated in Fig. 7 which shows a micrograph of a longitudinal section of the wall of the membrane at the region of the boundary between the active and inactive parts. It is clearly seen that the thickness of the chemically colored layer of the cathodic side of the membrane is considerably larger and of anodic side considerably smaller than the thickness of the colored layer in the absence of electric field. A possible explanation of this result lies in the model proposed by Mott and Gurney (18) according to which the rate of drift of the F centers in the electric field is proportional to the rate of drift of the free electrons and to the degree of ionization of the F centers. From the standpoint of this model the effect

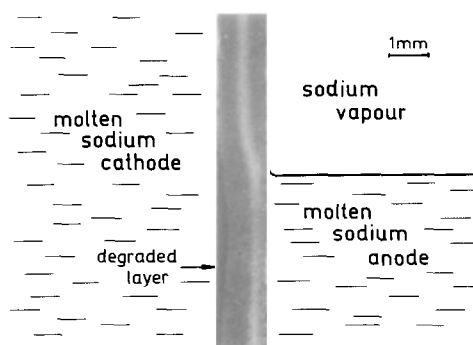

FIG. 7. Micrograph of a longitudinal thin section of a β'' -alumina membrane in the boundary region between the active and inactive parts of the membrane. 1500 Ah \cdot cm⁻² have passed through the membrane ($i = 1$ A \cdot cm⁻²).

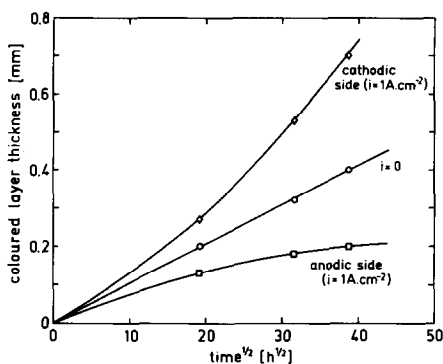

Fig. 8. Dependence of the chemically colored layer thickness on the square root of time in the presence and absence of electric current. The experimental results at $i = 0$ refer both to molten sodium and sodium vapor.

of the electric field should be expressed by an increase of the thickness of the chemically colored layer of the cathodic side, respectively, by a decrease of this thickness of the anodic side of the membrane. This was indeed experimentally observed. On the micrograph in Fig. 7 one can differentiate clearly also the damaged layer of the cathodic side of the membrane obtained as a result of the slow degradation mode II.

The influence of the electric current flow (the presence of electric field) on the dependence of the thickness of the chemically colored layer on time is given in Fig. 8. As is seen in the case of flowing of electric current there is a deviation from the parabolic dependence which is probably due to the fact that in this case the rate of the coloration is determined not only by diffusion but also by the drift of F centers under the action of electric field.

Conclusions

The results of the present work once more unambiguously show that at contact with molten sodium and sodium vapor polycrystalline β'' -alumina is colored (darkened) to a considerable degree and that the

rate of this coloration is one and the same in the two cases. The effect of the electric field on the rate of advance of the chemically colored layer is in accord with the mechanism of the coloration suggested by De Jonghe (11) which includes the formation in the ceramic of oxygen vacancies compensated by weakly bonded electrons. As discussed in Ref. (10) the chemical coloration facilitates the degradation mode II which represents an internal electrolysis of sodium and resulting microcracking. In order to meet the lifetime requirements of the sodium-sulfur battery possibilities of modification of the ion-conducting ceramic should be found in order to decrease its chemical interaction with molten sodium and/or sodium vapor. This will extend the time of development of the degradation mode II.

References

1. L. C. DE JONGHE, L. FELDMAN, AND A. BUECHELE, *J. Mater. Sci.* **16**, 780 (1981).
2. L. C. DE JONGHE, L. FELDMAN, AND A. BUECHELE, *Solid State Ionics* **5**, 267 (1981).
3. R. D. ARMSTRONG, T. DICKINSON, AND J. TURNER, *Electrochim. Acta* **19**, 187 (1974).
4. R. H. RICHMAN AND G. J. TENNENHOUSE, *J. Amer. Ceram. Soc.* **58**, 63 (1975).
5. D. K. SHETTY, A. V. VIRKAR, AND R. S. GORDON, in "Fracture Mechanics of Ceramics" (L. R. Bradt and D. P. Hasselman, Eds.), Vol. 4, p. 651, Plenum, New York (1978).
6. L. C. DE JONGHE, L. FELDMAN, AND P. MILLETT, *Mater. Res. Bull.* **14**, 589 (1979).
7. M. P. J. BRENNAN, *Electrochim. Acta* **25**, 621 (1980).
8. A. V. VIRKAR, L. VISWANATHAN, AND D. R. BISWAS, *J. Mater. Sci.* **15**, 302 (1980).
9. A. C. BUECHELE, L. C. DE JONGHE, AND D. HITCHCOCK, *J. Electrochem. Soc.* **130**, 1042 (1983).
10. L. C. DE JONGHE, *J. Electrochem. Soc.* **129**, 752 (1982).
11. L. C. DE JONGHE, A. BUECHELE, *J. Mater. Sci.* **17**, 885 (1982).
12. P. S. NICHOLSON, *Solid State Ionics* **9&10**, 187 (1983).

13. J. P. BARRET, D. GOURIER, AND D. VIVIEN, *Solid State Ionics* **13**, 267 (1984).
14. D. GOURIER, A. WICKER, AND D. VIVIEN, *Mater. Res. Bull.* **17**, 363 (1982).
15. R. KVACHKOV, A. YANAKIEV, C. N. POULIEFF, P. D. YANKULOV, S. RASHKOV, AND E. BUDEVSKI, *Solid State Ionics* **7**, 151 (1982).
16. L. C. DE JONGHE AND L. FELDMAN, *Mater. Res. Bull.* **15**, 777 (1980).
17. F. A. KRÖGER, "The Chemistry of Imperfect Crystals," North-Holland, Amsterdam (1964).
18. N. F. MOTT AND R. W. GURNEY, "Electronic Processes in Ionic Crystals," Oxford Univ. Press, Oxford (1948).