



A TECHNIQUE FOR THE ASSESSMENT OF STRENGTH OF COUPLING BETWEEN SEA SUBSYSTEMS: EXPERIMENTS WITH TWO COUPLED PLATES AND TWO COUPLED ROOMS

P. P. JAMES[†] AND F. J. FAHY

*Institute of Sound and Vibration Research, University of Southampton,
Southampton SO17 1BJ, England*

(Received 31 July 1996, and in final form 20 November 1996)

In a previous paper a technique for the indication of strength of coupling between SEA subsystems was proposed on the basis of theoretical models. This paper presents the results of an experimental application of the technique to two plates coupled by a variable number of straps and to two rooms coupled by an aperture. Similar values of the coupling strength indicator C_s to those theoretically evaluated are observed. Although not strictly comparable, the indication of dependence of coupling “strength” on coupling configuration and frequency, based upon the ratio of coupling to dissipation loss factors, support the credibility of C_s as a means of signalling unsatisfactory selection of SEA subsystems for experimental purposes.

© 1997 Academic Press Limited

1. INTRODUCTION

The initial step in performing an experimental SEA analysis for the purpose of deriving *in situ* loss factors is to define a model by sub-dividing the whole system into subsystems. On this sub-division depends both the quality of conditioning of the measured data and the reliability of the results derived therefrom. Usually, it is considered that the subdivision is optimal when the chosen subsystems are “weakly coupled”. As explained in reference [1], many different criteria for “weak coupling” have been proposed over the past few years, but unfortunately few of them are of practical use because no measurable quantity can be attached to the majority. If the choice of subsystems is not optimal in that components which are strongly coupled are assigned to different subsystems, the values of the associated coupling loss factors derived by the application of the power injection technique are likely to be seriously in error because these components will possess very similar modal energies. At present, any such deficiency of a model will only be revealed after time consuming and labour intensive tests. The overall objective of the research reported in this paper and its companion [2] is to develop a technique for the rapid assessment of the order of coupling strength between connected components in order to provide guidance for the selection of subsystems prior to test: it does not yield quantitative estimates of coupling strengths. A parameter C_s is defined as the normalized time delay to the peak of the temporal moving average, or envelope, of the frequency-band-limited kinetic energy impulse response of the indirectly excited subsystem; this is proposed as an

[†] Currently at La Société Européenne de Propulsion, Vernon, France.

indicator of strength of coupling in an SEA sense. In this paper the validity of the conclusions reached by means of theoretical models is experimentally examined. The principal aim of experiments has been to check the existence of the theoretically predicted energy peak time delay in physical subsystems. In addition, the robustness of the measure C_s , and the practicability of the experimental procedure for acquiring data have been assessed.

2. REVIEW OF THEORETICAL RESULTS

Langley [3, 4] proposed the following definition of weak coupling in the context of SEA: "The coupling is said to be weak if the Green function $G_{ij}(x, y, \omega)$ for subsystem j is approximately equal to that of the uncoupled system." (Note: this is not the drive-point impedance.) The state of weak coupling so defined seems to ensure both validity of the SEA postulate and good conditioning of the energy matrix generated experimentally for the purpose of deriving the loss factors of a system. However, no obvious quantity can be selected as a basis for the comparison of two Green functions in the frequency domain, especially when there are many resonances and infinitely many pairs of points (x, y) ; they are anyway not available for the uncoupled subsystems. Consequently, an indicator related to Langley's definition has been developed in the time domain. This indicator is based on the time delays to the peaks of the envelope of the band-pass filtered local kinetic energies in the subsystems, when one subsystem is subjected to a force impulse. The potential of this approach has been investigated theoretically for four different one- and two-dimensional systems coupled by linear springs and also with a cross-section discontinuity [2]. It appears that the shape of the temporal moving average (or envelope) of the band-pass filtered kinetic energy of the indirectly excited subsystem can be related to the strength of coupling. In the case of weak coupling, there is an appreciable time delay to the peak of the band-pass filtered kinetic energy of the indirectly excited subsystem, as shown by the case of two spring-coupled rods carrying longitudinal waves (see Figures 1 and 2).

When the strength of coupling is increased, the response of the indirectly excited rod tends towards the response of the directly excited rod. The particular patterns of these

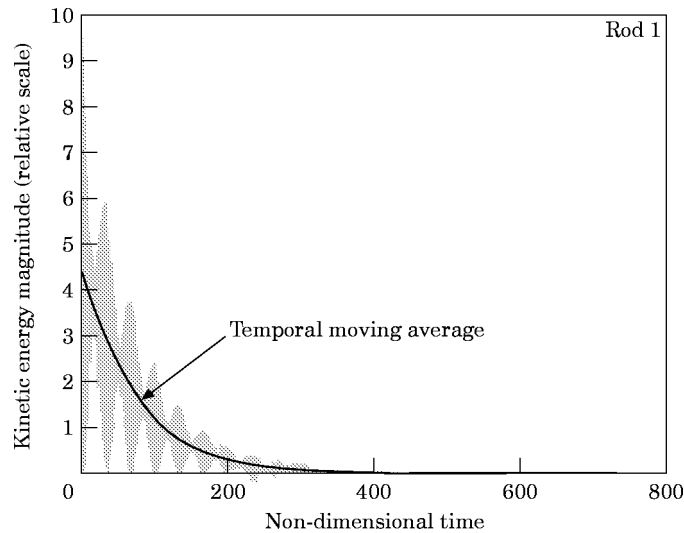

Figure 1. Example of temporal moving average of the space-averaged kinetic energy in a directly excited rod.

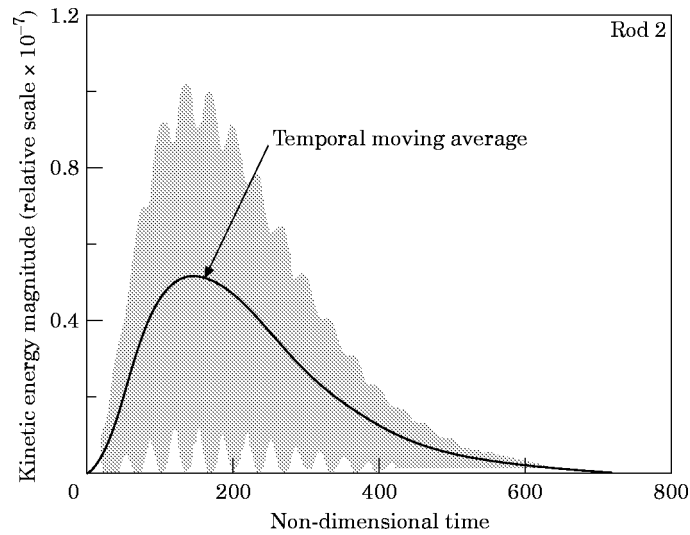

Figure 2. Example of temporal moving average of the space-averaged kinetic energy in an indirectly excited rod.

responses to impulse excitation lead to the proposal of a general, non-dimensional indicator of the coupling strength in an SEA sense based upon the temporal moving average of kinetic energy (Figure 3). This indicator of the strength of coupling is denoted by C_s . For all the systems considered, the range of values obtained for C_s is always the same (Figures 4, 5 and 6). This suggests that C_s is an absolute indicator of the strength of coupling independent of the system considered.

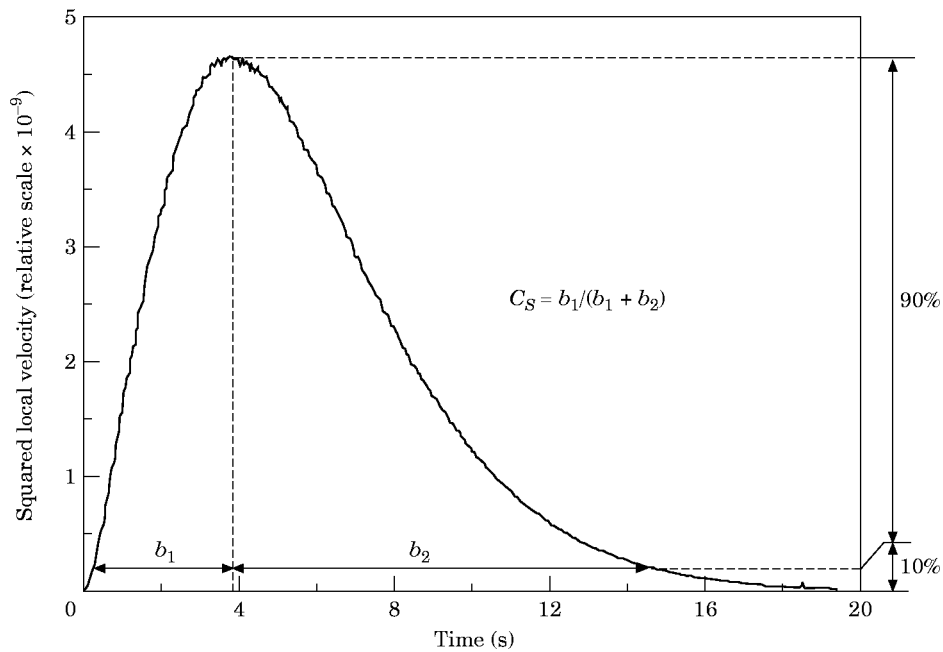

Figure 3. Definition of a non-dimensional measure of the strength of coupling, C_s .

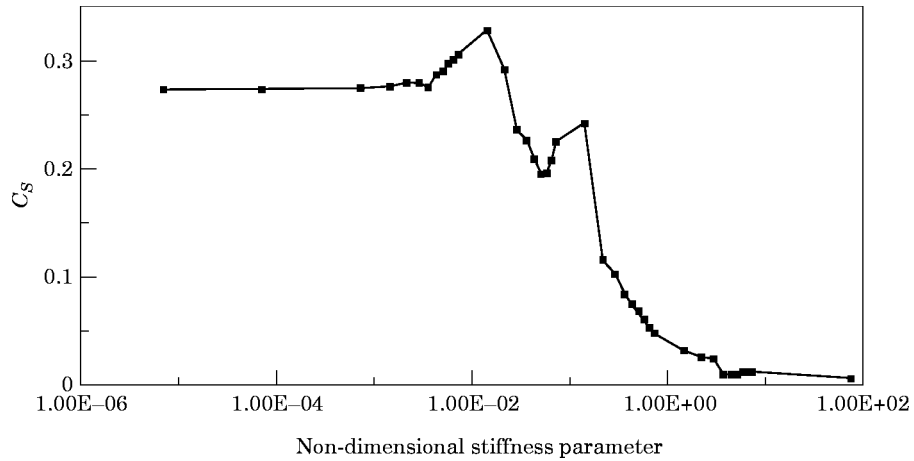

Figure 4. A case of two rods coupled by a linear spring: C_s as a function of the stiffness of the spring.

These results have led to the choice of a threshold of $C_s = 0.07$, above which the coupled subsystems can be considered as weakly coupled in an SEA sense. Furthermore, theoretical studies have shown that C_s is not sensitive to damping over a commonly encountered range of values, but is sensitive to the degree of proximity of natural frequencies of the uncoupled modes of the subsystems [2]. One of the aims of the experiments reported herein has been to assess if C_s can be of practical use, despite this apparently restrictive condition.

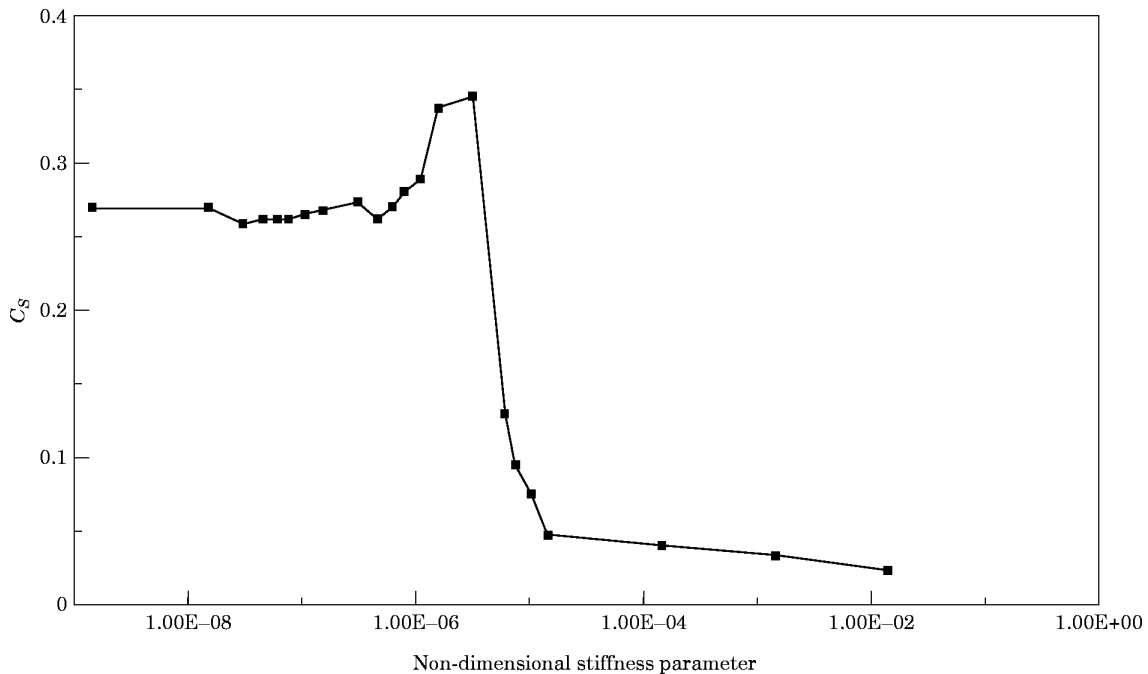

Figure 5. A case of two beams in flexure coupled by a linear spring: C_s as a function of the stiffness of the spring.

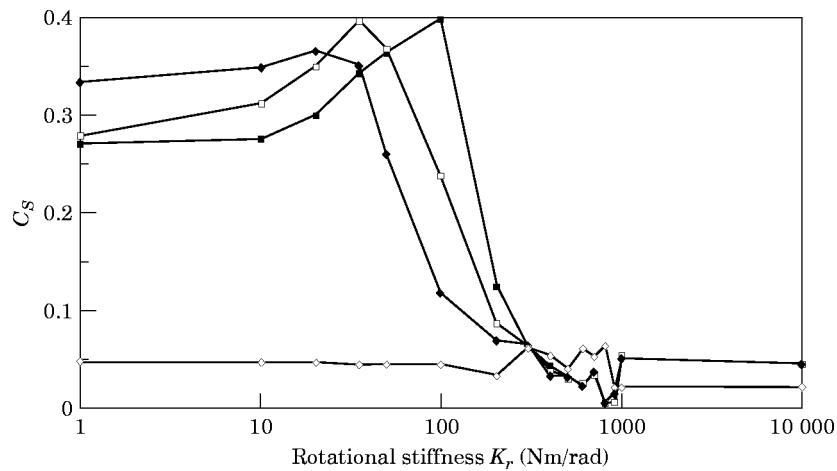

Figure 6. A case of two plates coupled by translational and rotational linear springs of stiffness K_t and K_r , respectively: C_s as a function of both stiffnesses. K_t values (N/m): —■—, 100; —□—, 300; —◆—, 1000; —◇—, 10 000.

3. TWO COUPLED PLATES

3.1. EXPERIMENTAL ARRANGEMENT

Experiments were performed on two coupled 3 mm thick steel plates of irregular shape and identical material properties (Figure 7). The two plates were coupled by means of 3 mm thick steel strips of 40 mm width and 50 mm free length. By varying the number of straps, the strength of coupling was modified. Some damping material was added to

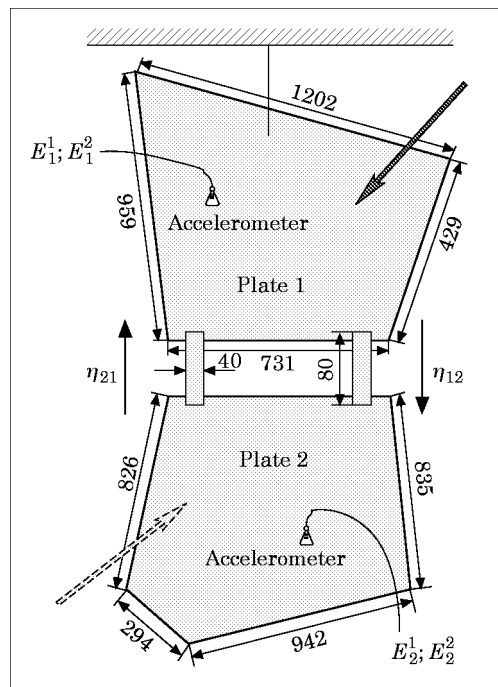

Figure 7. Dimensions of the plates (in mm). Plate thickness 3 mm. Drawing not to scale.

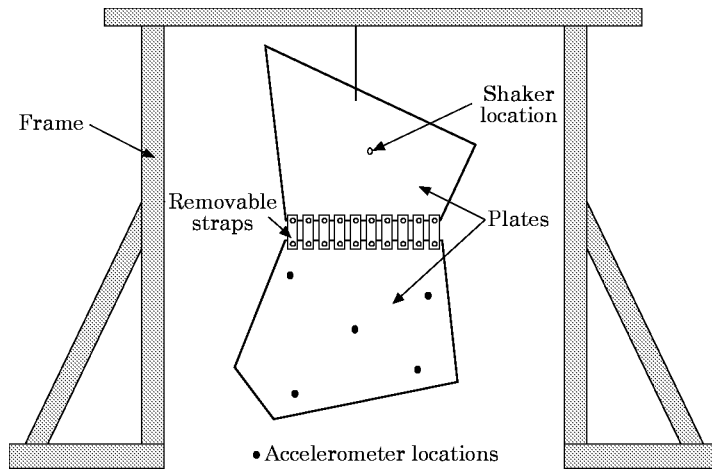

Figure 8. Experimental arrangement

the plates in order to reduce the length of the time window necessary to produce accurate estimates of the impulse responses. The two coupled plates were suspended from a steel frame by a flexible wire (see Figure 8). The upper plate was excited by means of a shaker composed of a magnet and a coil which involved no physical connection.

The shaker was driven by a random signal generated by a two-channel FFT analyzer. An accelerometer was successively attached with bee's wax at the five different positions on the lower plate indicated in Figure 8, in order to derive a space-averaged value of the measure C_s . A force transducer was interposed between the shaker and the plate. The force transducer provided the two-channel FFT analyzer with a measure of the excitation force. Prior to input to the FFT analyzer, the signal provided by the accelerometer was passed

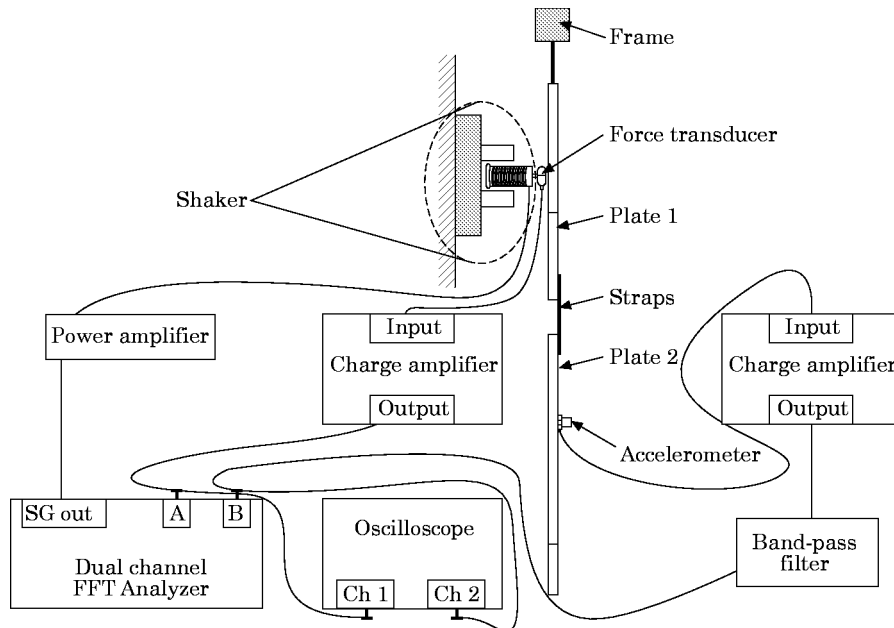

Figure 9. Arrangement of instrumentation.

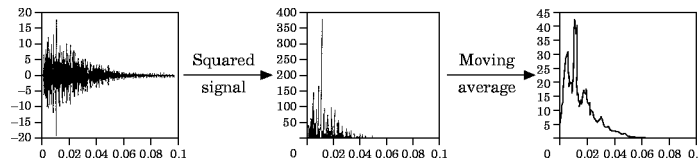

Figure 10. Processing of the signal provided by the 2-channel FFT analyzer.

through a band filter (see Figure 9). The FFT analyzer derived the impulse response between input force (channel A) and the band-pass filtered acceleration response (channel B). (In fact, it derived the inverse Fourier transform (F^{-1}) of the transfer function between signals A and B.) Since the accelerometer signal is filtered through a band-pass filter, the impulse response derived was a band-pass filtered impulse response, or the impulse response convolved with filter response. The band-width of the filter was selected so as to ensure that its impulse response decayed far more rapidly than those of the plates. The experiment was designed to measure a filtered impulse response in order to estimate the strength of coupling not only as a function of the number of straps but also as a function of frequency. The recorded filtered impulse response was transferred from the two-channel FFT analyzer to a personal computer where it was processed. The impulse response was squared, and its temporal moving average was derived using an integration period 20 times greater than the inverse of the lower frequency of the band considered (Figure 10) as recommended in reference [2]. (N.B. Over the initial portion of the impulse, the integration period is progressively increased from zero to 20 periods and then stabilized.)

Values of C_s were evaluated from the temporal moving-average as shown in Figure 3. The reader is reminded that C_s is not a quantitative measure but an indicator of strength of coupling in an SEA sense. If it is less than 0.1 for any pair of subsystems, the experimenter should be wary of the possibility of ill-conditioned data; if it is less than 0.07, the SEA model should be modified.

3.2. STRENGTH OF COUPLING AS A FUNCTION OF THE NUMBER OF STRAPS AND OF THE FREQUENCY BAND

A series of experiments was carried out, in which C_s was evaluated with various numbers of straps in a range of frequency bands. Three coupling configurations were used (see Figure 11). Five frequency bands of equal bandwidth were chosen: 100–300 Hz, centre frequency 200 Hz; 500–700 Hz, centre frequency 600 Hz; 1800–2000 Hz, centre frequency 1900 Hz; 4800–5000 Hz, centre frequency 4900 Hz; 6800–7000 Hz, centre frequency 6900 Hz.

The modal density of each plate is approximately 0.1 mode/Hertz. Thus, there were expected to be approximately twenty natural frequencies in each frequency band considered. The existence of a time delay to the peak of the temporal moving average of the squared impulse response of the indirectly excited plate (plate 2) can, in some cases, even be observed in the raw impulse response data, before processing see (e.g., Figures 12 and 13).

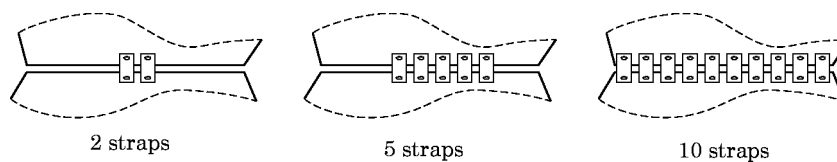

Figure 11. Coupling configurations.

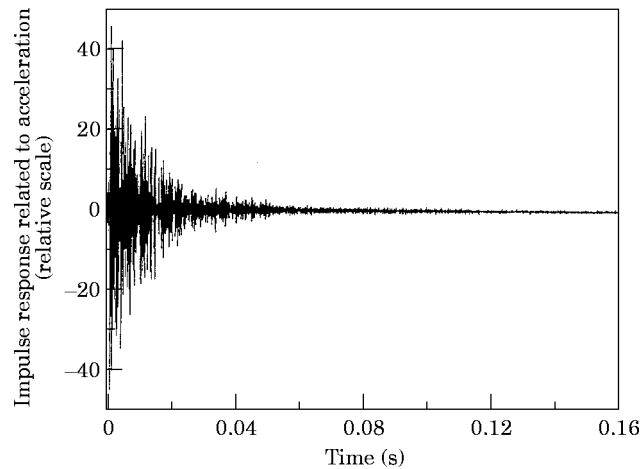

Figure 12. Example of an impulse response measured on plate 1.

C_s was systematically measured for the three configurations in all the selected frequency bands. Table 1 presents the space-averaged value of C_s derived from measurements at five points. All the values of C_s are between 0.06 and 0.3; this range of values is the same as for the results of numerical test presented in reference [2]. The physical coupling increases with the number of straps whatever the frequency band considered; thus C_s would be expected to show a corresponding decrease. In most cases, the values of C_s in Table 1

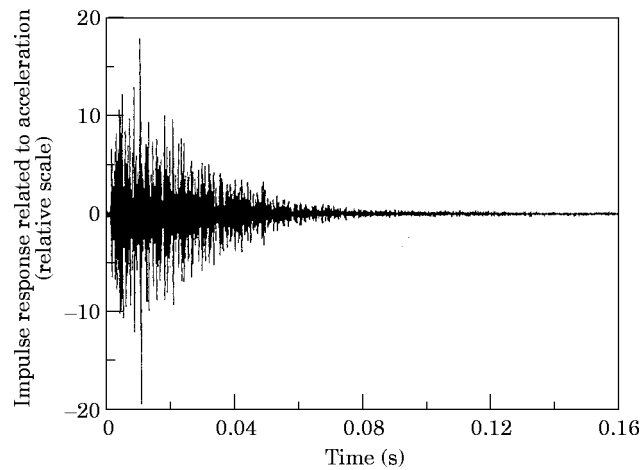

Figure 13. Example of an impulse response measured on plate 2.

TABLE 1

C_s as a function of the number of straps and of the frequency band for plate 2

Number of straps	Frequency (Hz)				
	200	600	1900	4900	6900
2	0.074	0.130	0.194	0.262	0.220
5	0.072	0.074	0.164	0.223	0.176
10	0.059	0.064	0.087	0.185	0.223

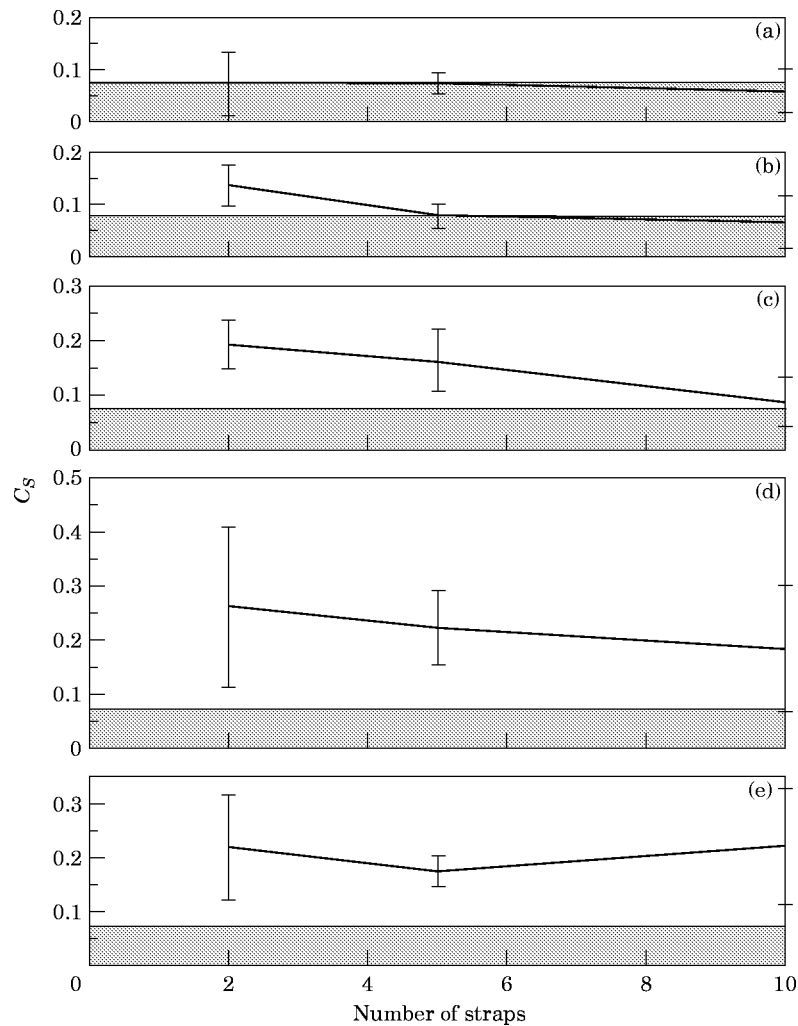

Figure 14. C_s as a function of number of straps and of the frequency band with some confidence intervals: (a) 100–300 Hz; (b) 500–700 Hz; (c) 1800–2000 Hz; (d) 4800–5000 Hz; (e) 6800–7000 Hz.

decrease when the number of straps is increased, which is consistent with expectations. For the frequency band 6800–7000 Hz, no systematic change is observed when the number of straps is varied. The existence of a plateau on the characteristic curve for C_s , in case of very weak coupling [5] may explain this insensitivity; the two plates appear to be weakly coupled even with ten straps.

As the observed range of values for C_s is similar to that derived from theoretical models, it seems reasonable to use the same threshold (0.07) above which the subsystems can be considered as weakly coupled in an SEA sense. However, only five points were used to derive the space-average C_s ; thus in order to assess the accuracy of the measure, it is worth deriving some confidence intervals. Because of the small number of measurements the central limit theorem cannot be exploited. One was thus obliged to assume that measurements C_s at various locations on plate 2 are drawn from a normal population. A confidence coefficient of 90% was chosen arbitrarily. Derived mean values of C_s are presented in Figure 14, together with 90% confidence intervals. For a given confidence

TABLE 2

Values of the "Smith" criterion for the plates coupled by two and ten straps

Centre frequency (Hz)	2 straps η_{12}/η_1	10 straps η_{12}/η_2
600	0.50	4.5
1900	0.35	2.5
4900	0.07	0.11

TABLE 3

Measure of C_s when a small perturbation of the mass of plate 2 is present

Centre frequency (Hz)	Plate 2 without mass: average C_s	Plate 2 with mass: average C_s
200	0.074	0.073
600	0.130	0.167
1900	0.194	0.219
4900	0.261	0.222
6900	0.219	0.215

coefficient, the confidence limits depend on the size of the sample: five in this case. One should remember that "We are 90% confident that the true average of C_s lies within the interval (0.06, 0.15) "does *not* mean that the *probability* that the true average lies in the interval (0.06, 0.15) is 0.90. It means that if one could draw a large number of samples with *all the same number of elements* from the population of C_s and find a confidence interval for the true average of C_s for each sample, then about 90% of the intervals would contain the true average of C_s ".

When comparison is made for each configuration of coupling between the 90% confidence intervals related to C_s for the frequency bands 100–300 Hz and 6800–7000 Hz, it is seen that there is little overlap, except minimally in the case of two straps. Likewise,

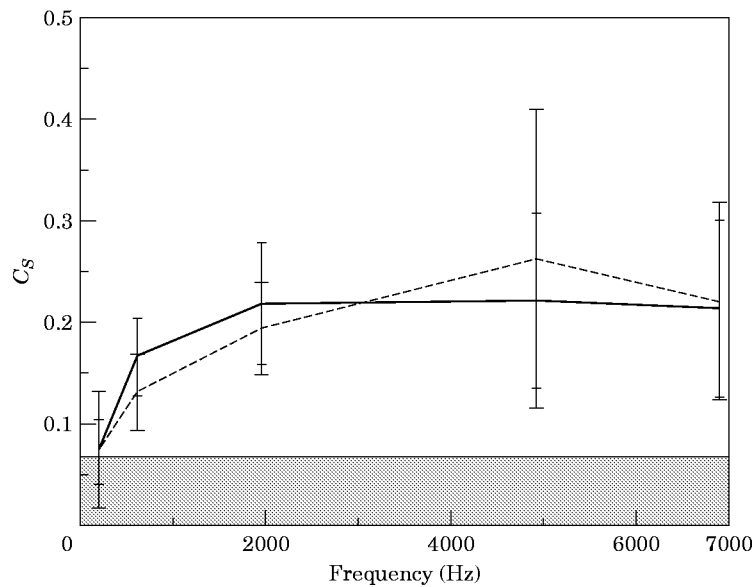
Figure 15. Sensitivity of C_s to a small mass perturbation: —|—, with added mass; -|-|-, without added mass.

when there are two or five straps, the 90% confidence related to C_s for the frequency bands 100–300 Hz and 1800–2000 Hz do not overlap. This suggests that C_s is indeed sensitive to frequency. For the frequency band 1800–2000 Hz, there is no overlap between the 90% confidence interval related to the configuration of plate with two straps and the 90% confidence interval related to that with ten straps. The same comparison can be made for frequency band 500–700 Hz between the results with two and five straps. This observation suggests that C_s is sensitive to the number of straps, as would be expected. For all the other figures, the 90% confidence intervals overlap. Usually, these intervals are fairly large when compared to the range of possible values for C_s . If only the average of the measured values for C_s is taken into account then a sensitivity to the physical strength of coupling is indicated. The wide spread of the 90% confidence interval is partly due to the small number of measures used to derive the average. This could explain why, in some cases, no clear conclusion can be drawn from the results. However, it is undeniable that C_s is sensitive to the physical strength of coupling.

It is important to keep in mind that C_s is not a “measure” of the “strength” of coupling in an SEA sense but an “indicator” of this strength of coupling. As an indicator, C_s needs a threshold. Previous theoretical studies have suggested that for the best use of SEA, this threshold should be 0.07. The grey zones in the figures represent the values of C_s for which the two plates should be considered as strongly coupled in an SEA sense. If a 90% confidence interval is totally outside these zones, then one is 90% confident that the plates are weakly coupled in an SEA sense. If a 90% confidence interval is entirely contained within a grey zone, then one is 90% confident that the two plates are strongly coupled, whereas if it partially overlaps one of these grey zones no reliable conclusion can be drawn. As we can see on the figures, for the frequency bands 4800–5000 Hz and 6800–7000 Hz, whatever the number of straps, one is 90% confident that the two plates are weakly coupled whereas, between 1800 Hz and 2000 Hz, it is only true when the plates are coupled with two or five straps, but not ten. Between 500 Hz and 700 Hz one is 90% confident that the two plates are weakly coupled when there are only two straps. In all the other cases, no reliable conclusion can be drawn about the strength of coupling in an SEA sense.

In an associated study, coupling and dissipation loss factors of the plates, connected by two and ten straps, have been estimated by means of the application of the SEA power injection method [6]. According to Smith [7], strength of coupling may be indicated by the ratio of coupling loss factor to dissipation loss factor. Values of this “Smith criterion” for the plates are available from reference [6] in only the three mid-range frequency bands. They are presented in Table 2. Weak coupling is said to be indicated by a value of less than unity. Comparison of these values with Figures 14(b), (c) and (d) shows good correlation with the indications of C_s .

The earlier theoretical studies [2] had indicated that C_s would be very sensitive to the precise degree of proximity between natural frequencies of pairs of the uncoupled modes of the subsystems. Such sensitivity would, in principle, severely compromise the potential of C_s as an indicator of coupling strength. As described in the following section, a simple *ad hoc* method was devised to check for indications of this potential sensitivity.

3.3. THE INFLUENCE OF MASS PERTURBATION ON C_s

Statistical Energy Analysis is applied when no deterministic approach can give reliable results within reasonable cost constraints because of the uncertainty in the dynamic properties of the systems involved and the sensitivity of high order modal natural frequencies to small variations of geometrical and material properties and of boundary conditions. SEA provides engineers with an approximate estimate of vibrational response which is based upon a probabilistic representation of the characteristics of the subsystems

and represents an ensemble—or frequency—average, estimate. Therefore, by definition, this estimate is not sensitive to small perturbations of the physical parameters of the subsystems. It has been shown above that C_s provides the experimenter with information about the strength of coupling in an SEA sense. But it is important to assess the sensitivity of C_s to small perturbations of the subsystems insofar as these changes should not greatly modify the strength of coupling in an SEA sense. A small perturbation mass (200 g) was applied to plate 2 (≈ 18.5 kg). Thus the uncoupled natural frequencies of this plate were slightly perturbed.

The measures of C_s were repeated on plate 2 with only two straps. Table 3 presents comparisons between the values of $\langle C_s \rangle$ with and without added mass. It is undeniable that there are some differences between the measures, but the conclusions drawn from the values of C_s remain unchanged (see Figure 15). In the case where the two plates are coupled with two straps, the subsystems can be considered as weakly coupled for the frequency bands 500–700 Hz, 1800–2000 Hz, 4800–5000 Hz and 6800–7000 Hz with 90% confidence, whereas no clear decision can be made between 100 and 300 Hz. These limited results suggest that C_s , considered as an indicator of the strength of coupling, is not over-sensitive to small perturbation in uncoupled natural frequencies; however, more comprehensive tests are necessary to establish the validity of this tentative conclusion.

3.4. THE INFLUENCE OF THE FREQUENCY BANDWIDTH ON THE INDICATOR OF STRENGTH OF COUPLING

Clearly, the greater the bandwidth, the greater the number of included uncoupled modal natural frequencies, and therefore the greater the probability of near-coincidence (proximity) theoretically required for C_s to be a valid indicator of coupling strength [2]. In order to check if the value of C_s is sensitive to changes in frequency bandwidth some measurements were carried out for a same centre frequency (600 Hz) but for various frequency bandwidths.

These measurements were carried out with two straps only. Table 4 summarizes the results obtained. It appears from Table 4 that, even if there are differences between measures of C_s when the frequency bandwidth is varied, the indication provided by C_s is the same in all cases. The lower 90% confidence limits are very close to each other for the three sets of measures. The smaller the frequency band, the less likely is close modal proximity to occur: nevertheless, even with only five natural frequencies of each plate in the frequency band, C_s gives the same indication as with twenty modes. Thus, C_s considered as an indicator of strength of coupling in an SEA sense, does not seem to be very sensitive to the number of uncoupled modes in the frequency band.

TABLE 4

C_s as a function of the frequency bandwidth: centre frequency at 600 Hz

Frequency bandwidth (Hz)	Plate 2 estimated average of C_s	Lower confidence limit (90%)	Upper confidence limit (90%)
50	0.137	0.093	0.181
100	0.110	0.082	0.138
200	0.106	0.092	0.169

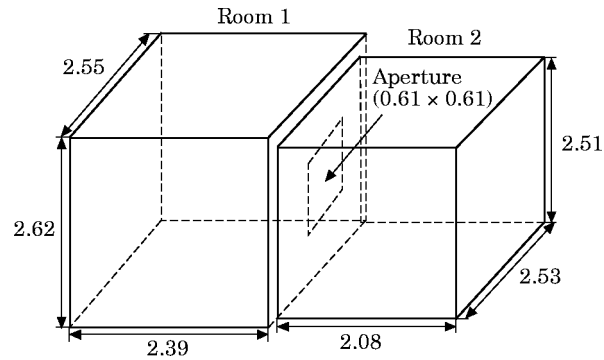

Figure 16. Two coupled rooms; dimensions in m.

4. TWO ROOMS COUPLED BY AN APERTURE

4.1. EXPERIMENTAL ARRANGEMENT

The previous sections have shown that, in the case of two coupled plates, C_s provides the experimenter with a good indication of the strength of coupling in an SEA sense. However, Statistical Energy Analysis does not deal only with structures but also with enclosed fluid volumes. So, experiments have been performed with two rooms coupled by an aperture (see Figure 16) in order to assess the quality of the indication achieved with C_s in case of coupling between acoustic fields. Moreover, for these particular coupled systems, the damping could easily be varied by adding or removing absorbing panels, so it was possible to investigate the influence of damping on the indicator C_s . The earlier theoretical studies [2] had suggested that the normalization procedure applied to the envelope of the energy impulse response would produce a universally relevant range of C_s .

The experimental arrangement is shown in Figure 17. A loudspeaker was positioned in room 1 and the sound pressure with a microphone was measured in room 2. The loudspeaker was driven by random signal generated by a two-channel FFT analyzer. A 1Ω resistor box enabled the loudspeaker current to be monitored. The microphone signal was passed through a band-pass filter before being input to a two-channel FFT analyzer. Thus, the band-pass filtered impulse response related to the loudspeaker (force) and the

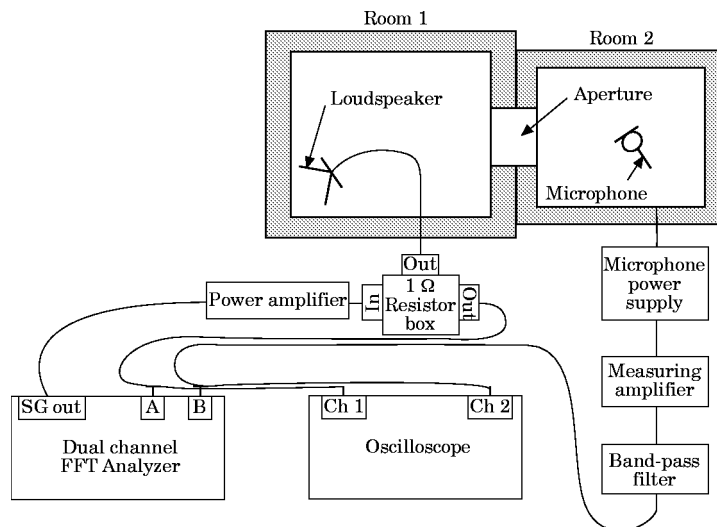

Figure 17. Experimental arrangement.

TABLE 5

90% confidence intervals for C_s when room 2 does not contain any absorbing panels

100–500 Hz	600–1000 Hz	1600–2000 Hz
$0.107 < C_s < 0.128$	$0.187 < C_s < 0.246$	$0.236 < C_s < 0.297$

microphone pressure was derived (Note: above the loudspeaker resonance frequency of about 100 Hz, the acoustic source strength (volumetric acceleration) is proportional to, and in phase with, the force applied to the loudspeaker coil.)

The measured band-pass filtered impulse response was processed as described in section 3. It is worth noting that once the impulse response related to pressure is squared and averaged, one obtains the average behaviour of the potential energy. It is reasonable to assume that the potential and kinetic energy have the same average behaviour.

4.2. THE STRENGTH OF COUPLING AS A FUNCTION OF THE FREQUENCY BAND

First, C_s was measured at thirty different locations in room 2 for three different frequency bands: 100–500 Hz, centre frequency 300 Hz; 600–1000 Hz, centre frequency 800 Hz; 1600–2000 Hz, centre frequency 1800 Hz. Because of the large size of the sample, the Central Limit Theorem can be applied [8]. This implies that the estimate of the mean value of C_s for a sample of thirty has approximately a normal distribution with a variance equal to the true spatial variance of C_s divided by the size of the sample. This approximation improves with the size of the sample. The confidence intervals can therefore be derived without any specific assumption about the spatial probability distribution of the values of C_s ; in this case the 90% confidence intervals have been derived. Because of the large number of measurements carried out, these intervals are fairly small as compared to the range of values for C_s ; thus some significant comparisons can be made between the different sets of measures. Table 5 presents the results obtained when no absorbing panels were present in room 2. The values of C_2 are all in the same range of those predicted by theoretical models. In this particular case, all the 90% confidence intervals are above the threshold of 0.07. The problem of modal proximity raised in reference [2] does not seem too serious, since a significant time delay occurs for all the frequency bands considered. It is highly probable that the rooms are weakly coupled in an SEA sense for the three frequency bands considered.

TABLE 6

90% confidence intervals for C_s for all the tested configurations

Configuration	100–500 Hz	600–1000 Hz	1600–2000 Hz
No absorbing panel	$0.107 < C_s < 0.128$	$0.186 < C_s < 0.246$	$0.236 < C_s < 0.297$
5 absorbing panels	$0.101 < C_s < 0.119$	$0.233 < C_s < 0.299$	$0.167 < C_s < 0.211$
10 absorbing panels	$0.104 < C_s < 0.128$	$0.208 < C_s < 0.262$	$0.133 < C_s < 0.180$

TABLE 7

90% confidence intervals for θ for all the tested configurations

Configuration	100–500 Hz	600–1000 Hz	1600–2000 Hz
No absorbing panel	$0.041 < \theta < 0.048$	$0.072 < \theta < 0.093$	$0.076 < \theta < 0.094$
5 absorbing panels	$0.034 < \theta < 0.038$	$0.051 < \theta < 0.063$	$0.043 < \theta < 0.053$
10 absorbing panels	$0.032 < \theta < 0.037$	$0.042 < \theta < 0.050$	$0.034 < \theta < 0.041$

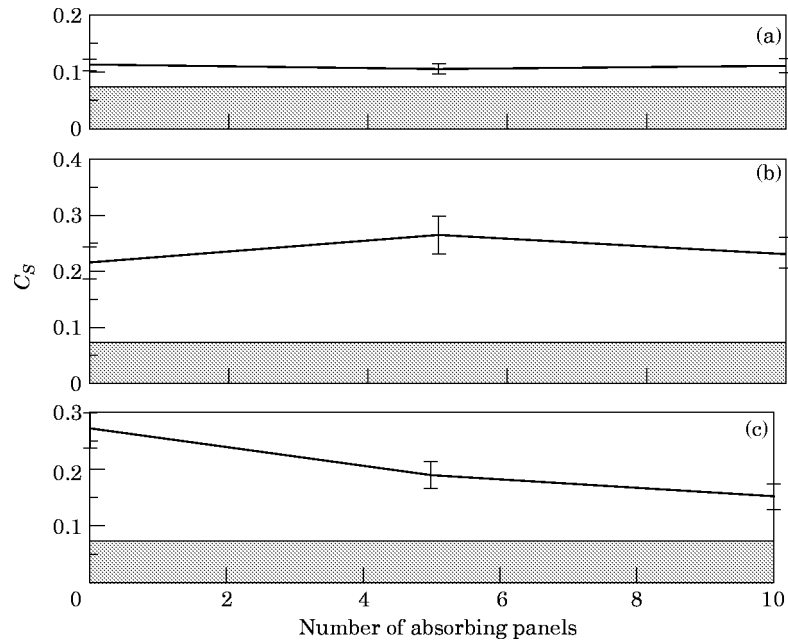

Figure 18. C_s as a function of the number of absorbing panels; (a) 100–500 Hz; (b) 600–1000 Hz; (c) 1600–2000 Hz.

4.3. THE INFLUENCE OF DAMPING ON THE INDICATOR OF THE STRENGTH OF COUPLING

It was easy to add some acoustic damping to the system, so it was possible to check the sensitivity of C_s to the damping. Some experiments were carried out with the following configurations of room 2: room 2 with 10 absorbing panels; room 2 with 5 absorbing panels; room 2 without absorbing panels.

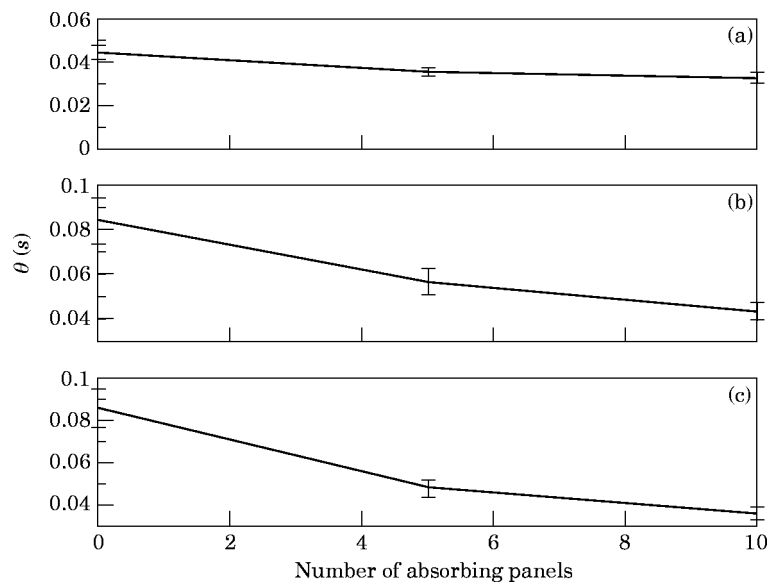

Figure 19. θ as a function of the number of absorbing panels; (a) 100–500 Hz; (b) 600–1000 Hz; (c) 1600–2000 Hz.

TABLE 8

Measured coupling loss factor for each frequency band considered

Frequency band (Hz)	Coupling loss factor (η_{12})
100–500	6×10^{-4}
600–1000	2×10^{-4}
1600–2000	5×10^{-5}

Numerical studies performed in reference [2] suggested that C_s should not be too sensitive to the damping, as opposed to the normalized time delay to the peak of the band-pass filtered kinetic energy, denoted by θ . So, for each configuration, measurements of both C_s and θ were made at thirty different places in room 2, in the three configurations (see Tables 6 and 7). The 90% confidence intervals were derived on the basis of the Central Limit Theorem.

Figures 18 and 19 present C_s and θ for each frequency band as a function of the number of absorbing panels added to room 2. For C_s , a threshold above which subsystems can be considered as weakly coupled has been defined as 0.07, whereas no absolute scale can be defined for θ .

In all cases except one, the 90% confidence limits in any one frequency band, with various numbers of panel, overlap for C_s , but in all except one case they do not overlap for θ , therefore indicating a greater relative insensitivity to damping of C_s .

4.4. SOME COMPARISONS WITH EXPERIMENTALLY DETERMINED COUPLING LOSS FACTORS OF THE COUPLED ROOMS

The two rooms considered are coupled by an aperture whose area is small as compared to their equivalent absorption area. According to reference [9], the two rooms are likely to be weakly coupled from an energetic point of view. In an associated project [6], the SEA power injection method was used to estimate the coupling loss factors between the two rooms. Some comparisons are made between these results and the indications provided by C_s and θ .

TABLE 9

Reverberation times and loss factors of both rooms for the frequency bands considered

Room 1

Frequency band (Hz)	T(s)	η_1
100–500	8.8×10^{-1}	9.1×10^{-3}
600–1000	9.7×10^{-1}	2.8×10^{-3}
1600–2000	1.1	1.1×10^{-3}

Room 2

Frequency band (Hz)	No absorbing panel		5 absorbing panels		10 absorbing panels	
	T(s)	η_2	T(s)	η_2	T(s)	η_2
100–500	1.44	5.1×10^{-3}	7.5×10^{-1}	9.7×10^{-3}	6.4×10^{-1}	1.1×10^{-2}
600–1000	2.08	1.3×10^{-3}	8.9×10^{-1}	3.1×10^{-3}	9×10^{-1}	3.0×10^{-3}
1600–2000	1.89	6.4×10^{-4}	1.0	1.2×10^{-3}	1.0	1.2×10^{-3}

TABLE 10
Smith's criterion for bare rooms

Frequency band (Hz)	No absorbing panel (η_{12}/η_1)
100–500	0.07
600–1000	0.07
1600–2000	0.05

The coupling loss factors of these rooms have been measured in an associated project by means of the SEA power injection method. The frequency-averaged values for the bands indicated are presented in Table 8. The loss factor for each room can be expressed as a function of frequency and reverberation time, T , as $\eta = 2.2/fT$. The reverberation time has been experimentally estimated from a large number of energy decay traces. Table 9 presents the estimated values of T , η for each room. According to Smith [7], in the case of weak coupling; the coupling loss factor should be smaller than the dissipation loss factor of the “source” subsystem. Table 10 presents the frequency-averaged values of η_{12}/η_1 for the two rooms in the absence of absorbing panels.

One sees that Smith's criterion for weak coupling is satisfied; the loss factor ratio varying little with frequency. This behaviour is not fully consistent with the variations of C_s and θ with frequency which indicate that the systems are most strongly coupled in the lowest frequency band. The relationships between these various indications of coupling strength remain to be resolved.

5. CONCLUSIONS

A technique for the assessment of the strength of coupling between SEA subsystems based on theoretical analysis was described in reference [2]. The assessment criterion is based upon the computation of a non-dimensional indicator denoted by C_s . In order to assess its practical utility this technique has been applied to two plates coupled by a number of straps and to two rooms coupled by an aperture. The principal practical advantages of this technique are that it can be applied very rapidly and easily, using simple instrumentation, and that a satisfactory level of confidence in the measurement results may be achieved with only a few samples. Moreover, although reference [2] indicates that, in the absence of modal coincidence, C_s is not a valid indicator of the strength of coupling, this problem does not appear to constitute a limitation in practice: the reason is, at present, unknown. Current research is aimed at the development of a reliable theoretical criterion for assessing “modal proximity”. However, in most practical cases where SEA is likely to be useful, modal coincidence (or resonant coupling) is likely, and the indicator C_s appears to provide reliable guidance to the experimenter in the appropriate selection of subsystems prior to commitment to a time-consuming power injection test.

ACKNOWLEDGMENTS

The authors gratefully acknowledge the Société Européenne de Propulsion and the Centre National d'Etudes Spatiales for financing this work within the R&T programme.

REFERENCES

1. F. J. FAHY and P. P. JAMES 1994 *ISVR Technical Report No. 228, University of Southampton*. Weak coupling in Statistical Energy Analysis.

2. F. J. FAHY and P. P. JAMES 1996 *Journal of Sound and Vibration* **190**, 363–386. A study of the kinetic energy impulse response as an indicator of coupling strength between SEA subsystems.
3. R. S. LANGLEY 1989 *Journal of Sound and Vibration* **135**, 499–508. A general derivation of the statistical energy analysis equations for coupled dynamic systems.
4. R. S. LANGLEY 1990 *Journal of Sound and Vibration* **141**, 207–219. A derivation of the coupling loss factors used in statistical energy analysis.
5. F. J. FAHY and P. P. JAMES 1995 *ISVR Technical Report No. 243*. Evolution of the energy impulse response in the case of two very weakly coupled systems: a mathematical model.
6. F. J. FAHY and H. M. RUIVO 1997 *Journal of Sound and Vibration* (in press) Determination of statistical energy analysis loss factors by means of an input power modulation technique.
7. P. W. SMITH, Jr. 1979 *Journal of the Acoustical Society of America* **65**, 695–698. Statistical models of coupled dynamical systems and transition from weak to strong coupling.
8. H. T. HAYSLETT 1974 *Statistics Made Simple* (third edition). London: W. H. Allen.
9. L. CREMER, H. A. MÜLLER and T. J. SCHULTZ, 1982 *Principles and Applications of Room Acoustics (Volume 1)*. London and New York: Applied Science Publishers. See pp. 261–264.