



A QUICK AND PRACTICAL EXPERIMENTAL METHOD FOR SEPARATING WHEEL AND TRACK CONTRIBUTIONS TO ROLLING NOISE

A. FRID

ABB Corporate Research, S-721 78 Västerås, Sweden

(Received in final form 23 September 1999)

A rapid and inexpensive experimental method for the breakdown of wayside rolling noise into direct and indirect wheel and track components has been developed. “*Direct*” in this context refers to the sound radiation from the outside of wheel and track. “*Indirect*” refers to sound radiation from inside wheel/track parts which is first reflected in the running gear, vehicle subframe and ballast before being radiated to the wayside. The separation method requires simultaneous measurements with a close range highly directive parabolic reflector microphone and a microphone on the track bed. The method gives the sound power for the above-mentioned components in 1/3-octave bands. For validation, synthesized wayside sound pressure time histories in 1/3-octave bands are compared with measured ones at 5 and 25 m distance from the track. The acoustic model for the source separation also allows a rough assessment on the efficiency of noise reduction measures like shielding, wheel damping, bogie absorption, etc., to be made. The method is demonstrated on pass-bys of X2000 trains and the potential benefit of damping, absorption and shielding is discussed.

© 2000 Academic Press

1. INTRODUCTION

Microphone arrays are today the standard tools for identification of acoustic sources in railway pass-by noise. Due to the practical limitations in spatial resolution of the arrays they are in general not capable of distinguishing between wheel and track contributions to the rolling noise. The present paper describes a quick and inexpensive experimental method in which the directly and indirectly radiated sound powers of wheel and track can be determined using a microphone on the track bed in combination with a wayside parabolic reflector microphone. The reflector microphone can be regarded as a simple and inexpensive alternative to the more sophisticated and complex microphone arrays. The source separation procedure described in this report would in principle be applicable also for array-based measurements. The proposed method has been calibrated on pass-bys of X2000 trains. For validation, calculated wayside sound pressure time histories based on sound powers from the separation procedure have been correlated with measured sound pressure levels at 5 and 25 m distance from the track. A propagation and ground reflection model from references [1–3] was used.

2. THE TRACK BED MICROPHONE

The basic assumption is that a reverberant sound field prevails in an air volume enclosed by bogie, wheelset and vehicle subframe as illustrated in Figure 1. A microphone situated on the track bed ballast picks up the enclosure sound pressure when run over by the wheelsets. The main dimensions of the enclosure volume are typically $1\text{ m} \times 2\text{ m} \times 4\text{ m}$. For frequencies above 400 Hz, the acoustical wavelengths are shorter than the enclosure dimension, which justifies the assumption of reverberant sound field. The sound pressure $L'_{p(E)}$ measured by the track bed microphone is related to the sound pressure $L_{p(E)}$ and sound power $L_{w(E)}$ inside the enclosure as

$$L'_{p(E)} = L_{p(E)} + X_{TBM}, \quad L_{w(E)} = L_{p(E)} + 10 \log(A_E \alpha_E / 4). \quad (1a, b)$$

Equation 1(b) is a well-known formula in room acoustics, A_E is here the enclosure surface area and α_E is the mean absorption coefficient of the enclosure surface. The correction X_{TBM} is introduced to compensate for the effect that the microphone is located on a boundary of the enclosure and not inside it. This correction ($0 < X_{TBM} < 6\text{ dB}$) is preferably determined experimentally on the measurement site or in laboratory provided that a reverberant sound field of known strength can be created. Laboratory tests with the microphone plate on top of ballast gave approximately $X_{TBM} = 3\text{ dB}$ in all 1/3-octave bands. It is expected that a slab track would have a correction close to $X_{TBM} = 6\text{ dB}$. Again using a standard room acoustics formula for sound transmission between adjacent rooms, the sound power $L_{w,indir}$ emitted from the enclosure to a fictitious volume outside the enclosure through the lateral "leakage" area S can be expressed in terms of the sound pressure $L_{p(E)}$ inside the enclosure:

$$L_{w,indir} = L_{p(E)} + 10 \log(S) - 6. \quad (2)$$

The assumption is again that a reverberant sound field exists in the "receiving room", i.e., the air volume just outside the enclosure. The (direct) sound power $L_{w,dir}$ from the outer surfaces of wheel and rail can also be related to $L_{p(E)}$.

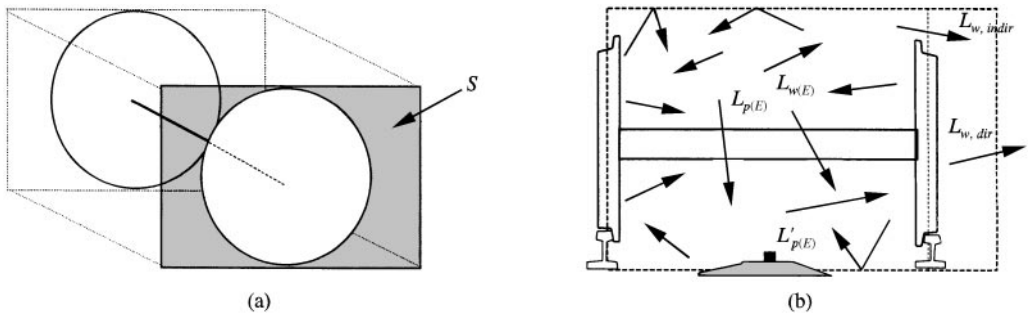

Figure 1. (a) Enclosed air volume between wheels in a wheelset. Lateral "leakage" area is shaded grey. (b) Reverberant sound field inside the enclosure above the track bed microphone. Direct and indirect emission of sound powers $L_{w,dir}$ and $L_{w,indir}$ to the wayside indicated.

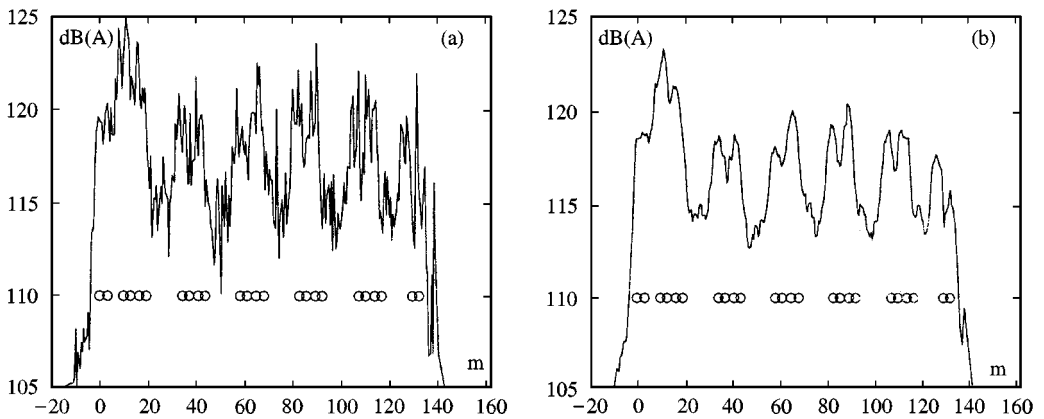

Figure 2. X2000 train pass-by recorded by track bed microphone: (a) non-averaged, (b) averaged over five samples equivalent to a length of 2.5 m.

Provided that the wheel and the rail radiates equal amounts of sound power to the inside and the outside so that $L_{w(E)} = L_{w,dir} + 3$ dB and if the sleeper radiation is neglected,

$$L_{w,dir} = L_{p(E)} + 10 \log(A_E \alpha_E) - 9. \quad (3)$$

The enclosure sound pressures $L_{p(E)}$ should ideally appear as peaks in the time-history signal registered by the microphone. A proper integration constant can be chosen carefully. Figure 2(a) shows a track bed microphone recording of a X2000 pass-by using a very short integration time and Figure 2(b) the same signal averaged over five samples (equivalent to the duration of one enclosure passing over the microphone) where it is much easier to detect the peak values. The wheel positions are indicated by circles.

3. THE PARABOLIC REFLECTOR MICROPHONE

The parabolic reflector microphone used in the measurements has a diameter of 2.2 m. Ideally, the reflector focuses incoming plane sound waves to the focal point where a standard microphone is located. The directivity characteristics of the parabola [1] are shown in Figure 3. It is evident that the reflector microphone has very strong directivity for frequencies above 1000 Hz. A simple relation between sound pressure $L_{p(PRM)}$ and incident sound power $L_{w(PRM)}$ is assumed for the reflector:

$$L_{p(PRM)} = L_{w(PRM)} - X_{PRM}, \quad (4)$$

where X_{PRM} is a calibration factor. The calibration factor X_{PRM} can be determined with an acoustic reference source or during the pass-by using the sum of $L_{w,dir}$ and $L_{w,indir}$ from equations (2) and (3). Figure 4 shows the results from the latter type of calibration for three X2000 passbys. In each 1/3-octave band, X_{PRM} has been taken as the average of all 20–24 wheelset peaks during a passby.

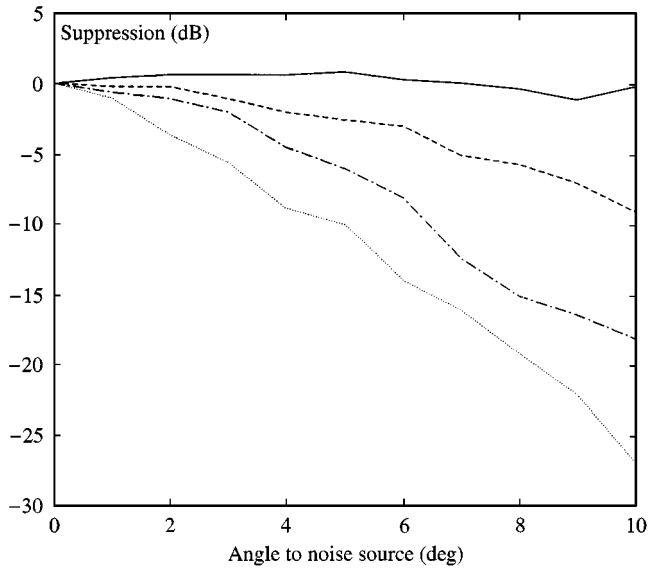

Figure 3. Directivity characteristics of parabolic reflector microphone: —, 500 Hz; ---, 1000 Hz; - · - · -, 2000 Hz; ···, 4000 Hz.

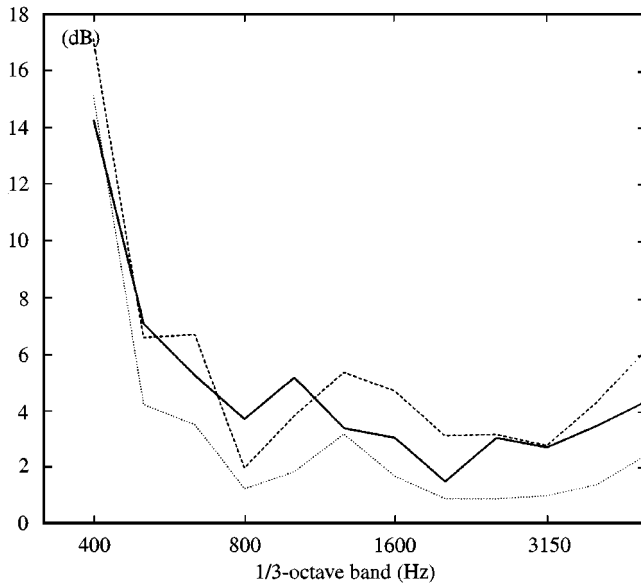

Figure 4. Calculated parabolic reflector microphone calibration factor X_{PRM} for three X2000 pass-bys.

4. TRACK RADIATION AND DECAY

Due to its strong directivity (see Figure 3), the reflector microphone will measure wheel noise contributions only when a wheelset is within a narrow angle in front of it. At all other instances the microphone signal will contain track noise only. It is

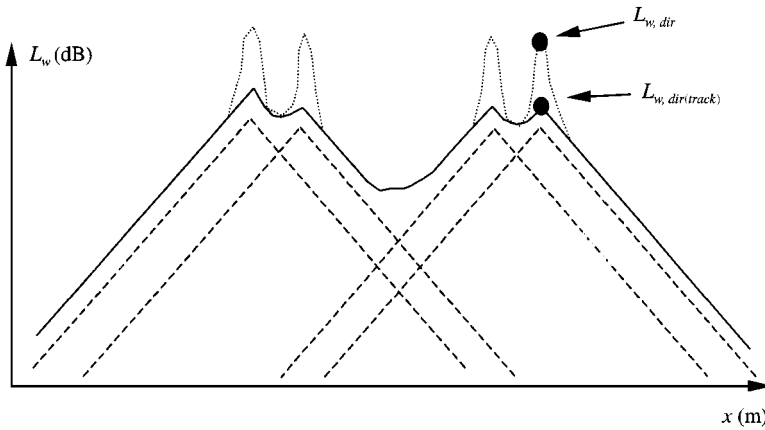

Figure 5. Principle for superposition of wheel/rail contact contributions (dashed lines) to track sound power (solid line). Total direct sound power (dotted line) also shown.

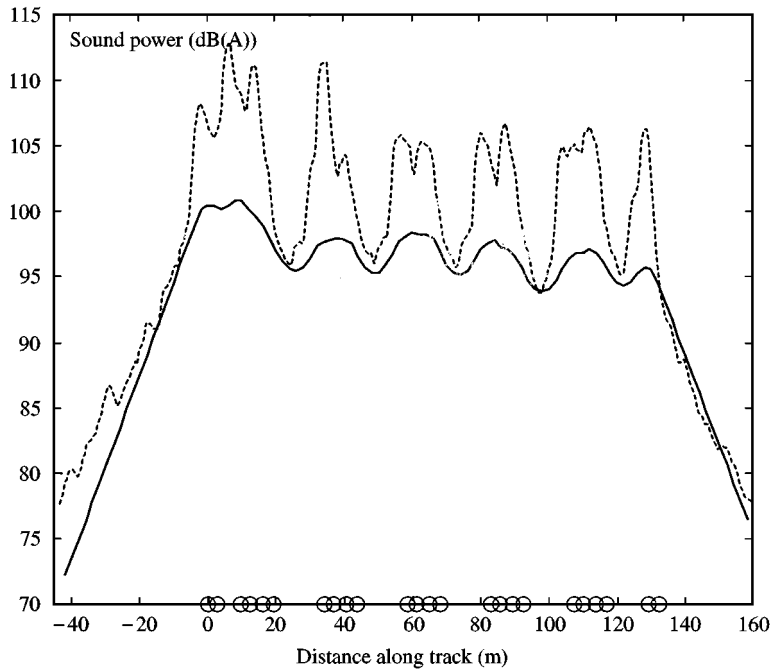

Figure 6. Reconstruction of track contribution (solid line) to parabolic reflector microphone sound power (dashed lines) for X2000 passby in 2000 Hz 1/3-octave band.

then possible to determine the (direct) track sound power based on the parabola microphone signal. A superposition of wheel/rail contact contributions with constant decay rates δ (dB/m) is fitted to the measured curve away from the wheelset peaks as illustrated in Figure 5. A real example of a reconstructed 1/3-octave band track contribution of an X2000 pass-by is shown in Figure 6. Note that the parabola signal will also include a contribution (2.5 dB in the example in Section 3) from the farside track which first must be subtracted in order to separate

$L_{w,dir}$ into $L_{w,dir(track)}$ and $L_{w,dir(wheel)}$ which is the final goal of the source identification. $L_{w,dir(track)}$ refers to the sound power from the track segment at the side of the enclosure (typically 2–2.5 m). The total track sound power is obtained by summing over all segments. The simple linear decay model (in each frequency band) in Figure 5 is strictly valid as long as the vibration wave type with the highest amplitude at the contact point dominates over the other waves. Further away from the excitation point, waves with less decay may be dominant and one will see a *piecewise* linear decay. Since only track lengths of 7–12 m (from wheelset to mid-section of coach) are of interest the simple linear decay model is normally sufficient. The type of vehicle and braking system (tread or disc) should have no influence on the applicability.

5. APPLICATION EXAMPLES

The source identification method has been applied to three pass-bys of X2000 trains running at 200 km/h. The results presented in this section have been limited to one of the pass-bys, although the results are consistent for all three. Two standard omnidirectional microphones at 5 m (1.5 m height) and 25 m (3.5 m height) distance from the track centre were used for validation. Figure 7 shows decay rates in 1/3-octave bands obtained from the curve-fitting procedure described in Section 4. The dip at middle range frequencies is typical for propagating vertical and lateral bending waves which are the most important ones. 1/3-octave spectra of the derived sound powers $L_{w,tot}$, $L_{w,dir(track)}$, $L_{w,dir(wheel)}$ and $L_{w,indir}$ are displayed in two alternative ways. Figure 8 shows the spectral composition of the *average* of all 24 wheel/rail contacts. Figure 9, on the other hand, shows the overall levels of *each* wheelset. To validate the separation into sound power components plotted in Figures 8 and 9, these sound powers were used to calculate sound pressure time histories at 5 and 25 m distance with the SPLM software [2, 3]. Figure 10 shows

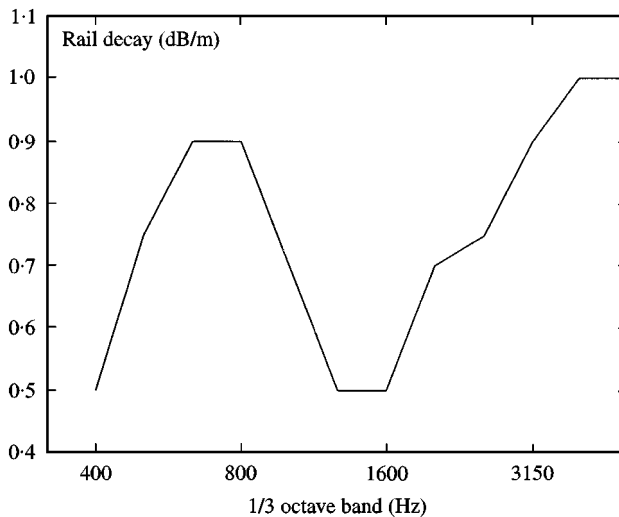

Figure 7. Decay rates for X2000 pass-by derived from parabola microphone measurement.

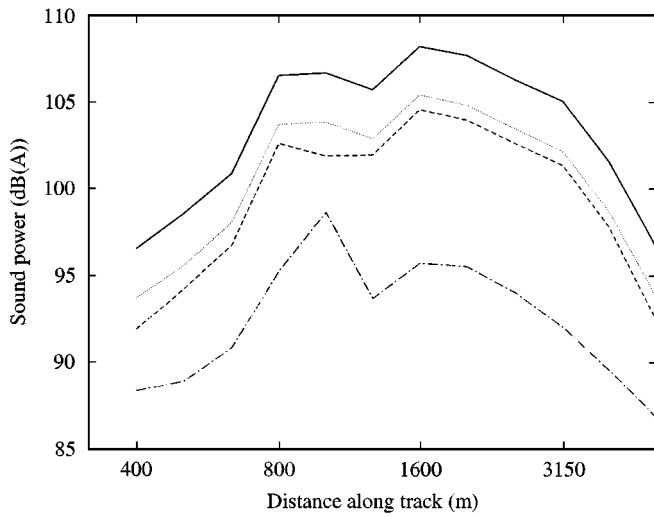

Figure 8. Identified 1/3-octave spectra of wheel, track, indirect and total sound powers for X2000 passby. Track sound power is for 2 m track segment closest to wheel/rail contact. —, total; ----, wheel; - · - · -, track; ····, indirect.

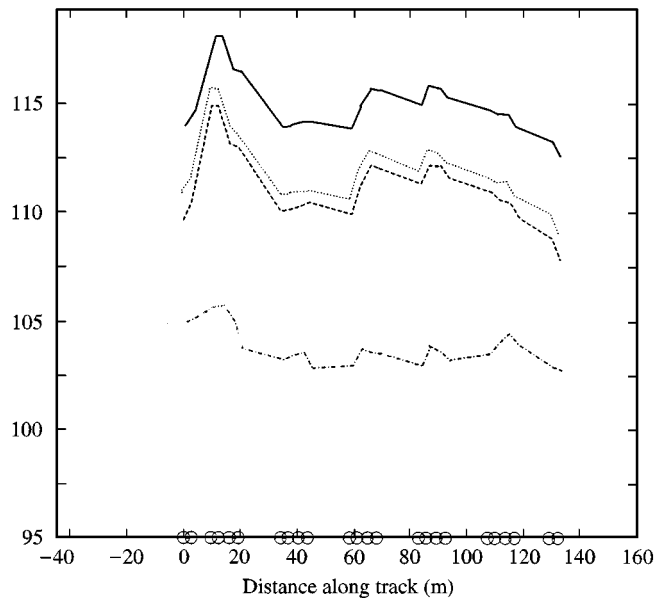

Figure 9. Identified 1/3-octave spectra of wheel, track, indirect and total sound powers for X2000 pass-by. Track sound power is for 2 m track segment closest to wheel/rail contact. —, total; ----, wheel; - · - · -, track; ····, indirect.

the calculated results together with measured time histories. Although not shown, a good agreement is observed in most 1/3-octave bands.

It should be borne in mind that the parabola microphone, due to the high directivity, responds only to incoming sound within a small area in front of it. When it is focused towards the wheel/rail/bogie area, noise sources higher up (pantographs, motor fans, etc.) will not be included. For instance, from the X2000

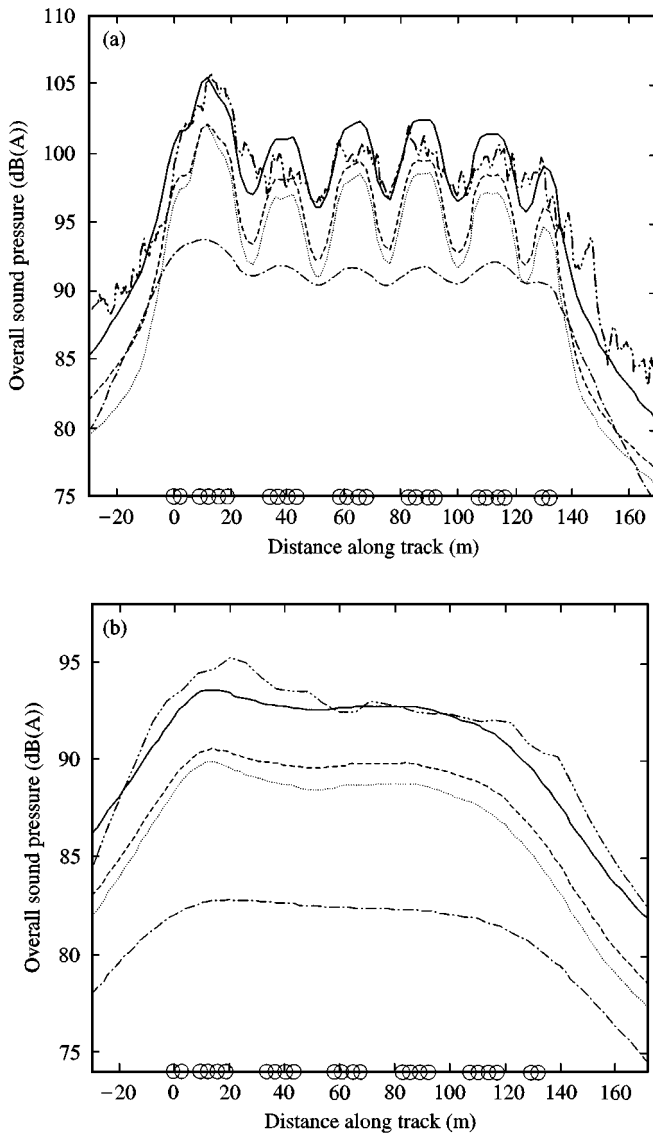

Figure 10. Synthesized and measured overall sound pressure level during X2000 pass-by: (a) 5 m distance (1.5 m height), (b) 25 m distance (3.5 m height): - · - · - ·, measurement; —, total; - - - -, wheel; · · · · ·, track; · · · · ·, indirect.

pass-bys used in this investigation, it was seen in the signal from the 5 m omnidirectional microphone that there were distinct peaks from the power unit in the 1250 and 1600 Hz bands which were less pronounced in the signal from the parabola microphone. These peaks are believed to be fan noise.

6. ASSESSMENT OF NOISE REDUCTION MEASURES

The acoustic model used to separate the rolling noise components can also be used to get a rough estimate on the efficiency of different noise reduction measures

such as wheel damping, bogie absorption and bogie skirts. The X2000 pass-by from the previous section will be used as a reference. No validation measurements have been carried out.

6.1. WHEEL DAMPING

As an approximation, damping added to the wheels will reduce the wheel resonance peaks but will have a negligible effect on the rail radiation. If the wheel damping Δ_d is expressed in dB and index 0 refers to the original condition, the direct wheel sound power will be $L_{w,dir(wheel)} = L_{w,dir(wheel),0} - \Delta_d$ and $L_{w,dir(track)}$ will remain unchanged. The indirect radiation $L_{w,indir}$, which contains a combination of wheel and rail contributions, must be modified according to the following equation:

$$L_{w,indir} = L_{w,indir,0} + 10 \log(10^{\Delta_d/10} + 10^{\Delta_o/10}) - 10 \log(1 + 10^{\Delta_o/10}) - \Delta_d. \quad (5)$$

The original ratio Δ_o (dB) between wheel and rail radiation has been introduced for simplicity. In Figure 11, damping ratios of $\Delta_d = 0, 5$ and 10 dB are compared. With more detailed knowledge of the amount of damping added to individual wheel eigenmodes, different values of Δ_d can be attributed to different 1/3-octave bands.

6.2. BOGIE SKIRTS

Only $L_{w,indir}$ will be affected if absorption is added in the bogie enclosure. Equations (1) and (2) are used to quantify the effect of a change in the absorption

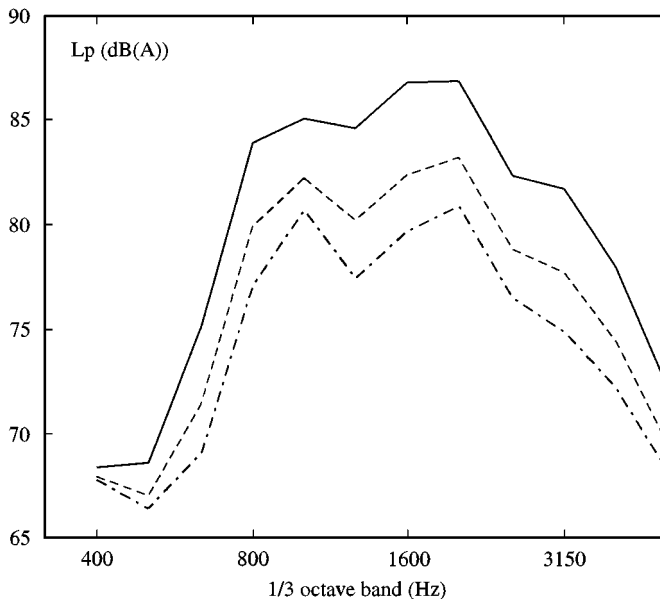

Figure 11. Calculated 1/3-octave spectra of maximum sound pressure (L_{Amax}) at 25 m during passby. L_{Amax} -values for the three wheel damping ratios are 93.6, 89.8 and 87.5 dB(A) respectively: —, original; ----, 5 dB damping; - · - ·, 10 dB damping.

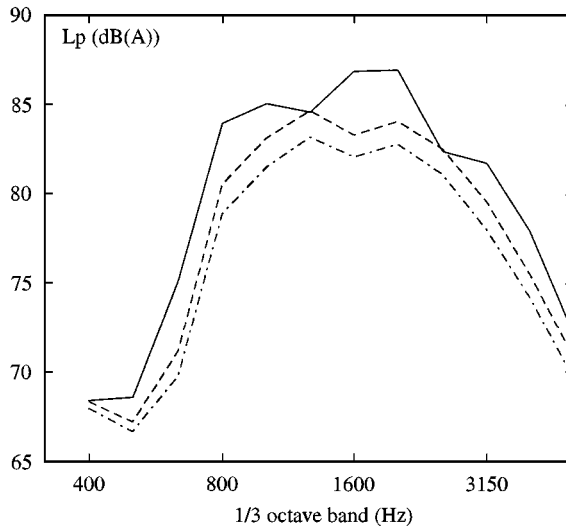

Figure 12. Calculated 1/3-octave spectra of maximum sound pressure (L_{Amax}) at 25 m during passby. L_{Amax} -values for 50% of bogie side area shielding and two levels of absorption are 93.6, 91.5 and 90.1 dB(A) respectively: —, original; ---, 50% shielding; - · - ·, 50% shielding & +3 dB.

α_E . The effect of shielding can also be examined in a simple way. It is assumed that the skirt forces part of $L_{w,dir(wheel)}$ to be reflected inwards so that the enclosure sound power $L_{w(E)}$ will increase. From equations (2) and (3) the modified indirect sound power $L_{w,indir}$ is given as

$$L_{w,indir} = 10 \log \left(\frac{(100 + \Delta)}{100} 10^{L_{w,dir(wheel)}/10} + 10^{L_{w,dir(track)}/10} \right) - 10 \log(S/A_E \alpha_E) + 3, \quad (6)$$

Here Δ (in %) is the amount of wheel sound power redirected inwards. The same amount will be subtracted from the direct wheel radiation $L_{w,dir(wheel)}$. The “leakage” area S (m^2) will also be changed, and possibly also the absorption coefficient α_E .

In the following example, half of the previously unshielded air gap area S has been covered with skirts. The skirts extend from the carbody down to the wheel axle which redirects half of the direct wheel radiation inwards ($\Delta = 50\%$). The maximum sound pressure levels during the pass-by have been calculated and are shown in Figure 12. In the SPLM analysis, the vertical position of the acoustic point sources for wheel and enclosure has been lowered accordingly from 0.44 to 0.30 m above railhead. Two levels of absorption have been compared: $\alpha_E = 0.19$ (original) and $\alpha_E = 0.38$.

7. CONCLUSIONS

A simple and inexpensive experimental method to separate rolling noise sources into direct and indirect wheel and track contributions has been presented. The

method can also be used to make a rough assessment of the effectiveness of noise reduction measures or design changes such as wheel damping, bogie absorption, bogie skirts, etc. The method is restricted to separation of rolling noise, which implies that the aeroacoustical noise must not be too high. This means that the method is less suitable for high-speed trains. It has been demonstrated on pass-bys of the X2000 train. Sound powers were derived and fed into a sound propagation software to obtain wayside sound pressure time histories which were compared with measured ones. The agreement was found to be good even in 1/3-octave bands. Although the first results look promising, further validation work is needed before the method can be considered as robust. From the pass-bys used in the investigation, there were not enough data available on wheels, track and roughness for a comparison with a prediction software like TWINS [4, 5]. This should be ensured in future validation tests. It is also recommended that the calibration of the parabola microphone which is very important for the outcome of the method must be developed. Lastly, different types of train will be studied to get a broader range of validation material.

ACKNOWLEDGMENTS

Many of the underlying ideas for the methods presented originate from Mr Class-Göran Johansson, ABB Corporate Research. His role as initiator and inspiration for the present work cannot be overestimated. The measurements were carried out in collaboration with Mr Thomas Ström, SP (the Swedish National Research and Testing Institute). Discussions with Dr Hans Jonasson and Mr Mikael Ögren on ground reflection and sound propagation models during the writing of the SPLM software are also appreciated. The work was funded by Adtranz.

REFERENCES

1. H. JONASSON 1996 *Report*, **43**, The propagation and screening of wheel/rail noise. Swedish National Testing and Research Institute.
2. A. FRID 1997 *ABB Corporate Research Internal Report CRC/B/TR/97/115E*, August. Sound pressure level module—theory manual.
3. A. FRID 1997 *ABB Corporate Research Internal Report CRC/B/UM/97/116E*, August. Sound pressure level module—user's manual.
4. D. J. THOMPSON 1996 *TNO-Report TPD-HAG-RPT-93-0213*, January. TWINS track-wheel interaction noise software, user's manual version 2.3.
5. D. J. THOMPSON 1996 *TNO-Report TPD-HAG-RPT-93-0214*, January. TWINS track-wheel interaction noise software, theoretical manual version 2.3.