



## CORRELATION FACTORS DESCRIBING PRIMARY AND SPATIAL SENSATIONS OF SOUND FIELDS

Y. ANDO

Graduate School of Science and Technology Kobe University, Rokkodai, Nada, Kobe 657-8501, Japan.  
E-mail: [andoy@kobe-u.ac.jp](mailto:andoy@kobe-u.ac.jp)

(Accepted 30 May 2002)

The theory of subjective preference of the sound field in a concert hall is established based on the model of human auditory–brain system. The model consists of the autocorrelation function (ACF) mechanism and the interaural crosscorrelation function (IACF) mechanism for signals arriving at two ear entrances, and the specialization of human cerebral hemispheres. This theory can be developed to describe primary sensations such as pitch or missing fundamental, loudness, timbre and, in addition, duration sensation which is introduced here as a fourth. These four primary sensations may be formulated by the temporal factors extracted from the ACF associated with the left hemisphere and, spatial sensations such as localization in the horizontal plane, apparent source width and subjective diffuseness are described by the spatial factors extracted from the IACF associated with the right hemisphere. Any important subjective responses of sound fields may be described by both temporal and spatial factors.

© 2002 Elsevier Science Ltd. All rights reserved.

### 1. INTRODUCTION

The human ear sensitivity to a sound source in front of the listener is essentially formed by the physical system from the source point to the oval window of the cochlea [1, 2]. Due to specific characteristics in electro-physiological responses from both the left and right human cerebral hemispheres [3–10], the workable model may be proposed as shown in Figure 1. In this figure, a sound source  $p(t)$  is located at  $r_0$  in a three-dimensional space and a listener is sitting at  $r$  which is defined by the location of the center of the head,  $h_{l,r}(r|r_0, t)$  being the impulse responses between  $r_0$  and the left and right ear-canal entrances. The impulse responses of the external ear canal and the bone chain are  $e_{l,r}(t)$  and  $c_{l,r}(t)$ , respectively. The velocities of the basilar membrane are expressed by  $V_{l,r}(x, \omega)$ ,  $x$  being the position along the membrane.

The action potentials from the hair cells are conducted and transmitted to the cochlear nuclei, the superior olivary complex including the medial superior olive, the lateral superior olive and the trapezoid body, and to the higher level of two cerebral hemispheres. The input power density spectrum of the cochlea  $I(x')$  can be roughly mapped at a certain nerve position  $x'$  [11, 12], as a temporal activity. Amplitudes of waves (I–IV) of the auditory brainstem response (ABR) reflect the sound pressure levels as a function of the horizontal angle of incidence to a listener [3]. Such neural activities, in turn, include sufficient information to attain the autocorrelation function (ACF), probably at the lateral lemniscus as indicated by  $\Phi_{ll}(\sigma)$  and  $\Phi_{rr}(\sigma)$ . In fact, the time domain analysis of firing rate from the auditory nerve of a cat reveals a pattern of ACF rather than the frequency

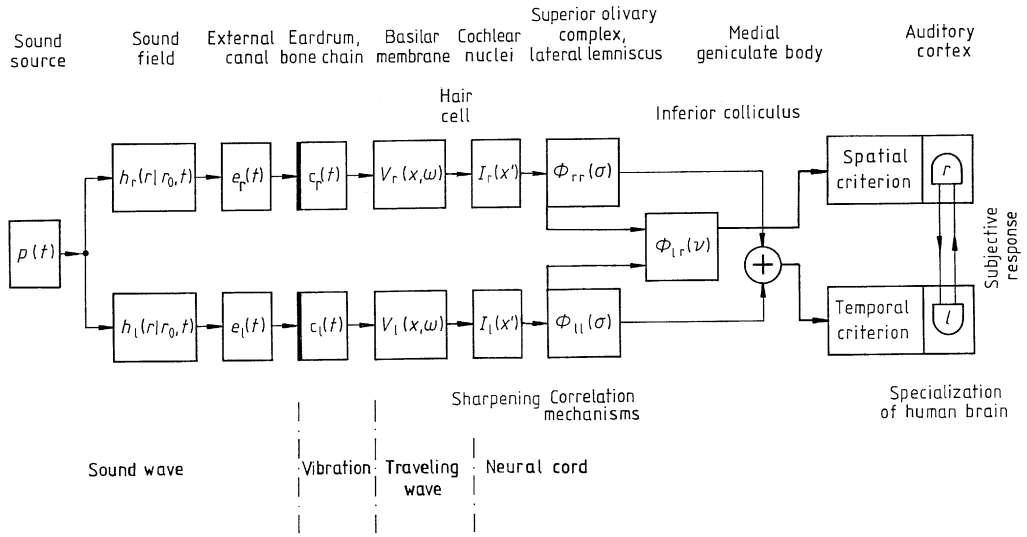

Figure 1. Model of the auditory-brain system with autocorrelation and interaural crosscorrelation mechanisms and specialization of human cerebral hemispheres [2].

domain analysis [13]. Pooled interspike interval distributions resemble the short time or the running ACF for low-frequency component. Also, pooled interval distributions for sound stimuli consisting of the high-frequency component resemble the envelope to the running ACF [14]. From the viewpoint of the missing fundamental or pitch of complex components judged by humans, the running ACF must be processed in the frequency components below about 5 kHz [15]. Due to the absolute refractory or resting period of a single neuron (about 1 ms), the missing fundamental or pitch may be perceived to be less than about 1.2 kHz [16]. A model of running ACF processor is illustrated in Figure 2, which is dominantly connected with the left cerebral hemisphere.

As also discussed [3], the neural activity (wave V together with waves IV<sub>l</sub> and IV<sub>r</sub>) may correspond to the IACC as shown in Figure 3. Thus, the interaural crosscorrelation mechanism may exist at the inferior colliculus. It is concluded that the output signal of the interaural crosscorrelation mechanism including the IACC may be dominantly connected to the right hemisphere. Also, the sound pressure level may be expressed by a geometrical average of the ACFs for the two ears at the origin of time ( $\sigma = 0$ ) and in fact appears in the latency at the inferior colliculus, which may be processed in the right hemisphere.

It was discovered that the listening level (LL) and the IACC are dominantly associated with the right cerebral hemisphere and the temporal factors,  $\Delta t_1$  and  $T_{sub}$ , and the sound field in a room is associated with the left (Table 1). The specialization of the human cerebral hemisphere may relate to the highly independent contribution between the spatial and temporal criteria on any subjective attributes. It is remarkable that, for example, “cocktail party effects” may well be explained by such specialization of the human brain because speech is processed in the left hemisphere, and independently the spatial information is mainly processed in the right hemisphere.

Based on the model, one can describe primary and spatial sensations, and thus any subjective attributes of sound fields in terms of processes in the auditory pathways and the specialization of two cerebral hemispheres.

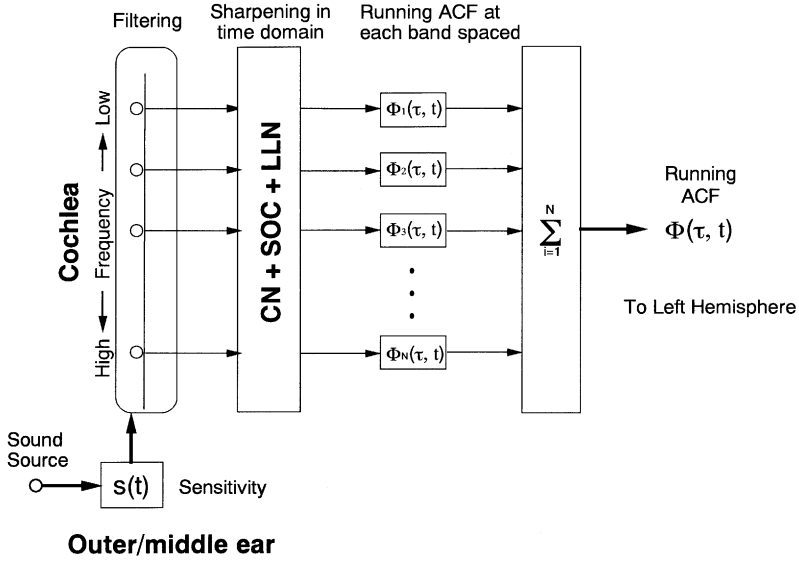

Figure 2. Neural processing model of the running ACF.

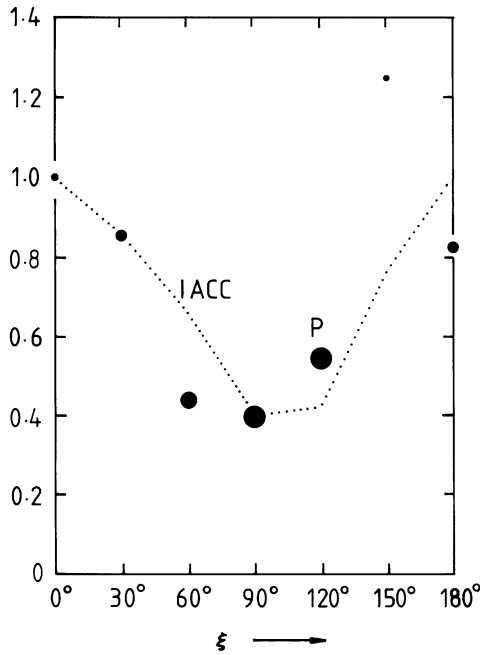

Figure 3. Relationship between values of  $IACC$  and  $P = A_V^2/[A_{IV,l}A_{IV,r}]$ , as a function of horizontal angle ( $\xi$ ) of sound incidence to a listener, where  $A_{IV,l}$  and  $A_{IV,r}$  are amplitudes of ABR waves IV and  $A_V$  is that of wave V averaged. A linear relationship between the  $IACC$  and the value  $P$  is observed ( $p < 0.01$ ). Note that the diameter of full circles corresponds to a number of available data obtained in recording ABR (1-4) from four subjects.

TABLE 1

*Hemispheric specialization obtained by analyses of AEP (SVR), EEG and MEG[ 3–10]*

Factors varied	AEP (SVR) $A(P_1 - N_1)$	EEG, ratio of ACF $\tau_e$ values of $\alpha$ -wave	MEG, ACF $\tau_e$ value of $\alpha$ -wave
Temporal			
$\Delta t_1$	$L > R$ (speech)	$L > R$ (music)	$L > R$ (music)
$T_{sub}$	—	$L > R$ (music)	—
Spatial			
$LL$	$R > L$ (speech)	—	—
$IACC$	$R > L$ (vowel/a/) $R > L$ (band noise)	$R > L$ (music)	—

Sound sources used in the experiments are indicated in the brackets.

## 2. ORTHOGONAL FACTORS

### 2.1. FACTORS EXTRACTED FROM ACF

The ACF is defined by

$$\Phi_p(\tau) = \frac{1}{2T} \int_{-T}^{+T} p'(t)p'(t+\tau) dt, \quad (1)$$

where  $p'(t) = p(t) * s(t)$ ,  $s(t)$  being the ear sensitivity, which is essentially formed by the transfer function of physical system to the oval of the cochlea. For practical convenience,  $s(t)$  may be chosen as the impulse response of an  $A$ -weighted network [1, 2]. The ACF and the power density spectrum mathematically contain the same information. There are three significant items, which can be extracted from the ACF:

- (1) energy represented at the origin of the delay,  $\Phi_p(0)$ . Note that the definition of  $LL$  is given by equation (11);
- (2) fine structure, including peaks and delays (Figure 4(a)). For instance,  $\tau_1$  and  $\phi_1$  are the delay time and the amplitude of the first peak of ACF,  $\tau_n$  and  $\phi_n$  being the delay time and the amplitude of the  $n$ th peak. Usually, there are certain correlations between  $\tau_n$  and  $\tau_{n+1}$ , and between  $\phi_n$  and  $\phi_{n+1}$ ;
- (3) effective duration of the envelope of the normalized ACF,  $\tau_e$ , which is defined by the ten-percentile delay and which represents a repetitive feature or reverberation containing the sound source itself. The normalized ACF is defined by

$$\Phi_p(\tau) = \Phi_p(\tau) / \Phi_p(0). \quad (2)$$

Similar to the manner shown in Figure 4(b), this value is obtained by fitting a straight line for extrapolation of delay time at  $-10$  dB, if the initial envelope of ACF decays exponentially. Therefore, orthogonal and temporal factors that can be extracted from the ACF are  $\Phi_p(0)$ ,  $\tau_1$ ,  $\phi_1$ , and the effective duration,  $\tau_e$ .

### 2.2. AUDITORY-TEMPORAL WINDOW

In the analysis of the running ACF, the so-called “auditory-temporal window”  $2T$  in equation (1) must be carefully determined. The initial part of ACF within the effective duration  $\tau_e$  of the ACF contains important information of the signal. In order to determine the auditory-temporal window, successive loudness judgements in pursuit of the

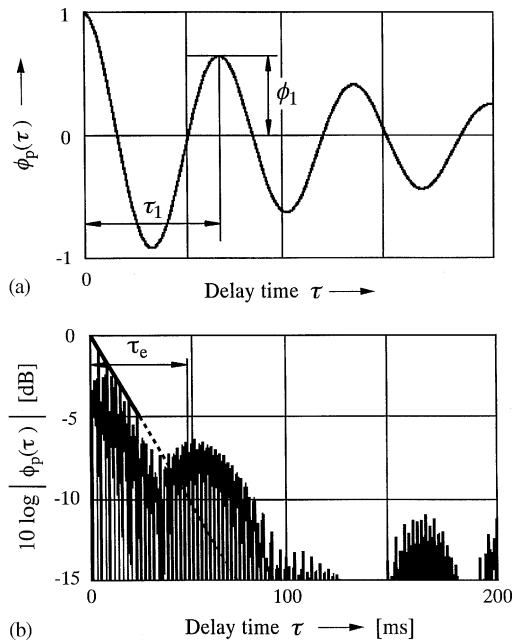

Figure 4. Definition of independent factors other than  $\Phi_p(0)$  extracted from the normalized ACF. (a) Values of  $\tau_1$  and  $\phi_1$  for the first peak; (b) the effective duration of the ACF  $\tau_e$ , which is defined by the 10 percentile delay (at  $-10$  dB) and which is obtained practically by the extrapolation of the envelope of the normalized ACF during the decay, 5 dB initial.

running  $LL$  have been conducted. Results show that the recommended signal duration  $(2T)_r$  to be analyzed is approximately given by

$$(2T)_r = 30(\tau_e)_{min}, \tag{3}$$

where  $(\tau_e)_{min}$  is the minimum value of  $\tau_e$  obtained by analyzing the running ACF [17]. This implies that the time constant represented by “fast” or “slow” of the sound level meter is deeply related to such a temporal window depending on the effective duration of ACF.

The running step ( $R_s$ ) which signifies a degree of overlap of the signal to be analyzed is not critical. It may be selected as  $K_2(2T)_r$ ,  $K_2$  being chosen, say, in the range of  $1/4-1/2$ .

### 2.3. FACTORS EXTRACTED FROM IACF

The IACF is given by

$$\Phi_{lr}(\tau) = \frac{1}{2T} \int_{-T}^{+T} p'l(t)p'r(t + \tau) dt, \tag{4}$$

where  $p'_{l,r}(t) = p(t)_{l,r} * s(t)$ ,  $p(t)_{l,r}$  is the sound pressure at the left- and right-ear entrances. The normalized IACF is given by

$$\phi_{lr}(\tau) = \Phi_{lr}(\tau) / [\Phi_{ll}(0)\Phi_{rr}(0)]^{1/2}, \tag{5}$$

where  $\Phi_{ll}(0)$  and  $\Phi_{rr}(0)$  are autocorrelation functions ( $\tau = 0$ ) or sound energies arriving at the left- and right-ear entrance respectively. Spatial factors extracted from the IACF,  $IACC$ ,  $\tau_{IACC}$  and  $W_{IACC}$  are defined in Figure 5 [2]. Note that the listening level is given by Equation (11).

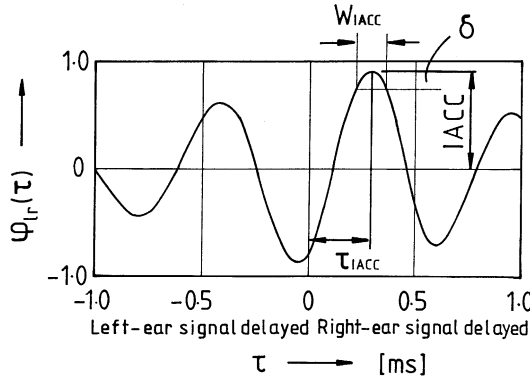

Figure 5. Definition of independent factors  $IACC$ ,  $\tau_{IACC}$  and  $W_{IACC}$  extracted from the normalized IACF,  $\delta = 0.1$ .

In analyzing the running IACF,  $2T$  is also selected by equation (3). For the purpose of spatial design for sound fields, however, longer values of  $(2T)_r$  are recommended.

### 3. PRIMARY SENSATIONS

#### 3.1. PITCH

First of all, consider the pitch or the missing fundamental of the sound signal, which can be given by

$$s_P = f_P(\Phi_p(0), \tau_1, \phi_1, D), \tag{6}$$

where  $D$  is the duration of sound signal as is represented by musical notes.

When a sound signal contains only a number of harmonics without the fundamental frequency, one hears the fundamental as a pitch. This phenomenon is mainly explained by the delay time of the first peak in the ACF fine structure,  $\tau_1$ , in the condition that the missing fundamental is less than about 1.2 kHz [16]. According to experimental results on the pitch perceived when listening to the bandpass noises without any fundamental frequency, the pitch  $s_p$  is expressed by equation (6) as well. The strength of the pitch sensation is described by the magnitude of the first peak of the ACF,  $\phi_1$  [18]. For the signal of a short duration, factor  $D$  might be taken into account.

#### 3.2. LOUDNESS

Next, consider the loudness  $s_L$  which may be given by

$$s_L = f_L(\Phi_p(0), \tau_1, \phi_1, \tau_e, D). \tag{7}$$

Since the sampling frequency of the sound wave is more than twice that of the maximum audio frequency, the value  $10 \log \Phi(0)/\Phi(0)_{ref}$  is far more accurate than the  $L_{eq}$  which is measured by the sound level meter,  $\Phi(0)_{ref}$  being the reference. This fact is the most significant for an impulsive sound.

Scale values of loudness within the critical band were obtained in paired-comparison tests using sharp filters with the slope of 1080–2068 dB/octave under the condition of a constant  $\Phi_p(0)$  [19]. Obviously, when a sound signal has a similar repetitive feature,  $\tau_e$  becomes a large value, like a pure tone, then the greater loudness results are as shown in

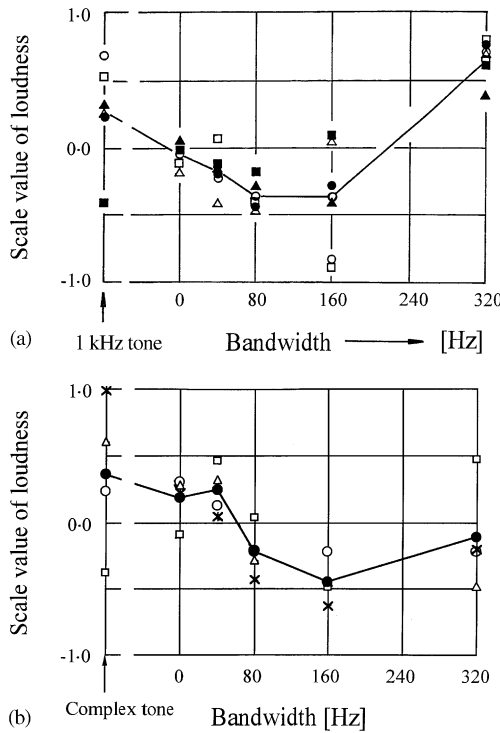

Figure 6. Loudness as a function of the bandpass noise by use of filters with the slope of 1080–2068 dB/octave: (a) Bandpass noise centered on 1 kHz; (b) complex noises with the fundamental centered on 1 kHz.

Figure 6(a). Thus, a plot of loudness versus bandwidth is not flat in the critical band centered at 1 kHz. This contradicts previous results of the frequency range centered on 1 kHz [20].

Figure 6(b) shows results of complex noises with the fundamental centered at 1 kHz. Comparing figures (a) and (b) of Figure 6, scale values of loudness are similar to each other, when the pitch is the same as given by  $\tau_1$ .

### 3.3. TIMBRE

The third primary sensation, timbre, that includes pitch, loudness and duration is assumed to be given by

$$s_T = f_T[\Phi_p(0), \tau_e, \tau_1, \phi_1, D]. \tag{8}$$

Any experimental results on timbre according to equation (8) are not available at present.

### 3.4. DURATION

The fourth-primitive sensation is introduced here because information in musical notes includes loudness, pitch and duration. It is a perception of signal duration, which is given by

$$s_D = f_D[\Phi_p(0), \tau_e, \tau_1, \phi_1, D]. \tag{9}$$

Experimental results have been described in relation to  $\tau_1$ ,  $\phi_1$ , and  $D$  in references [21, 22].

TABLE 2

*Primary sensations, which may be described in relation to factors, extracted from the autocorrelation function and the interaural crosscorrelation function*

Factors		Primitive sensations			
		Loudness	Pitch	Timbre <sup>†</sup>	Duration
ACF	$LL$	X	x	X	X
	$\tau_1$	X	X	X	X
	$\phi_1$	x	X	X	X
	$\tau_e$	X	x	X	x
	$D$	x <sup>‡</sup>	x <sup>‡</sup>	X <sup>‡</sup>	X

X and x: Major and minor factors influencing the corresponding response.

$D$ : Physical duration of sound signal.  $LL = 10 \log[\Phi(0)/\Phi(0)_{ref}]$ , where  $\Phi(0) = [\Phi_{ll}(0)\Phi_{rr}(0)]^{1/2}$ .

<sup>†</sup>In order to describe timbre, additional factors  $\tau_i$  and  $\phi_i$  ( $i = 2, 3, \dots, N$ ) must be taken into account on occasions.

<sup>‡</sup>It is recommended that loudness; pitch and timbre should be examined in relation to the signal duration,  $D$  as well.

Table 2 summarizes the possible relation between the four primary sensations and the factors extracted from the ACF and the physical signal duration  $D$ .

#### 4. SPATIAL SENSATIONS

##### 4.1. DIRECTIONAL SENSATION

The perceived direction of a sound source in the horizontal plane is described as

$$s = f(LL, IACC, \tau_{IACC}, W_{IACC}), \quad (10)$$

where

$$LL = 10 \log[\Phi_{ll}(0)\Phi_{rr}(0)]^{1/2}/\Phi_{ref}(0). \quad (11)$$

$\Phi_{ll}(0)$  and  $\Phi_{rr}(0)$  signify sound energies of the signals arriving at the left and right ear entrances, and  $\Phi_{ref}(0)$  is the reference. In these four spatial and orthogonal factors in Equation (10), the interaural delay time,  $\tau_{IACC}$ , is well known as a significant factor in determining the perceived horizontal direction of the source. A well-defined direction is perceived when the normalized interaural crosscorrelation function has one sharp maximum, a high value of the  $IACC$  and a narrow value of the  $W_{IACC}$ , due to high-frequency components. On the other hand, subjective diffuseness or no spatial directional impression corresponds to a low value of  $IACC$  ( $< 0.15$ ) [23].

Apart from these four spatial factors, of particular interest is the perception of a sound source located in the median plane. The temporal factors extracted from the ACF of sound signal arriving at the ear entrances may act as cue [24] because little changes in spatial factors in the median plane [25]. Figure 7(a) shows that significant differences in the three factors,  $\tau_e$ ,  $\tau_1$ , and  $\phi_1$ , as a parameter of the incident angle are found. Few differences, however, may be found in the head-related transfer functions as shown in Figure 7(b) [10].



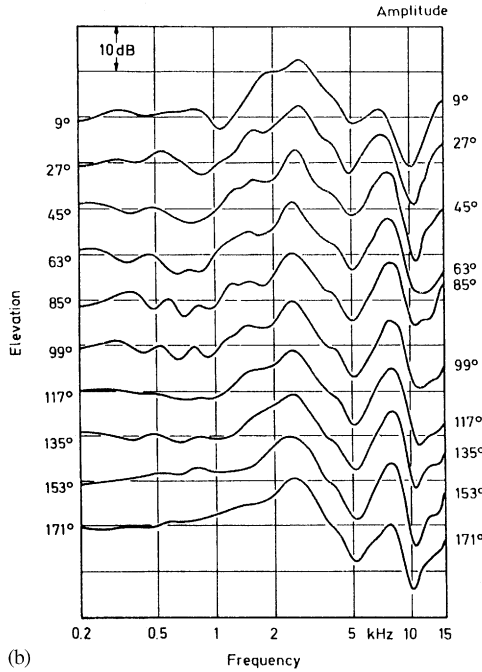
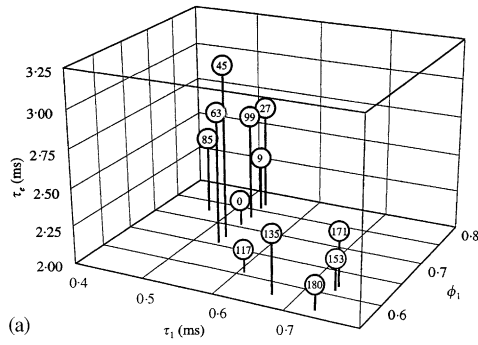

Figure 7. (a) Three-dimensional illustration of  $\tau_1$ ,  $\phi_1$ , and  $\tau_e$  extracted from the normalized ACF at each incident angle in the median plane to a listener for sound localization. The number inside the circles is the vertical angle in the median plane [25], which are used to obtain the normalized ACF. (b) Amplitudes of the head-related transfer function at each incident angle in the median plane [25], which are used to obtain the normalized ACF.

#### 4.2. SUBJECTIVE DIFFUSENESS

The scale value of subjective diffuseness is assumed to be given by Equation (10) also. In order to obtain the scale value of subjective diffuseness, paired-comparison tests with bandpass Gaussian noise, varying the horizontal angle of two symmetric reflections have been conducted. Listeners judged which of two sound fields were perceived as more diffuse, under the constant conditions of  $LL$ ,  $\tau_{IACC}$ , and  $W_{IACC}$  [26]. The strong negative relationship between the scale value and the  $IACC$  can be found in the results with frequency bands between 250 Hz and 4 kHz. The scale value of subjective diffuseness may be well formulated in terms of the  $3/2$  power of the  $IACC$  in a manner similar to the

TABLE 3

*Spatial sensations in relation to factors extracted from the ACF and the IACF*

Factors	Spatial sensations				
	ASW	Subjective diffuseness	Image shift	Horizontal direction	Vertical direction
ACF					
$\tau_1$					X
$\phi_1$					X
$\tau_e$					X
IACF					
$\Phi_{ll}(0)$	—	—	X	(X)	x
$\Phi_{rr}(0)$	—	—	X	(X)	x
$LL$	X	X	—	X	—
$\tau_{IACC}$	x	x	X	X	x
$W_{IACC}$	X	X	X	X	x
$IACC$	X	X	X	X	x

X and x: Major and minor factors influencing the corresponding response.

$LL = 10 \log[\Phi(0)/\Phi(0)_{ref}]$ , where  $\Phi(0) = [\Phi_{ll}(0)\Phi_{rr}(0)]^{1/2}$ ; ASW: Apparent source width.

subjective preference for the sound field, i.e.,

$$S_{diffuseness} = -\alpha(IACC)^\beta, \tag{12}$$

where coefficients  $\alpha = 2.9$  and  $\beta = 3/2$ .

4.3. APPARENT SOURCE WIDTH (ASW)

It is considered that the scale value of apparent source width (ASW) is given by Equation (10) as well. For a sound field with a predominant low-frequency range, the long-term IACF has no sharp peaks in the delay range of  $|\tau| < 1$  ms, and thus a wide value of  $W_{IACC}$  results. Clearly, the ASW may be well described by both factors,  $IACC$  and  $W_{IACC}$  [27], under the conditions of a constant  $LL$  and  $\tau_{IACC} = 0$ . The scale values of ASW were obtained by paired-comparison tests with a number of subjects. The listening level affects ASW [28]; therefore, in this experiment the total sound pressure levels at the ear-canal entrances of sound fields were kept constant at a peak of 75 dBA. Listeners judged which of the two sound sources they perceived to be wider. The results of the analysis of variance for the scale values  $S_{ASW}$  indicate that both of factors  $IACC$  and  $W_{IACC}$  are significant ( $p < 0.01$ ), and contribute to the  $S_{ASW}$  independently, thus

$$S_{ASW} = a(IACC)^{3/2} + b(W_{IACC})^{1/2}, \tag{13}$$

where coefficients  $a \approx -1.64$  and  $b \approx 2.44$ . Calculated scale values  $s_{ASW}$  by equation (13) and measured scale values are in good agreement ( $r = 0.97$ ,  $p < 0.01$ ) [27]. These formulas also hold for complex noise [29].

Table 3 indicates a list of spatial sensations with their significant factors extracted from the IACF.

5. SUBJECTIVE PREFERENCE AND ANY SUBJECTIVE RESPONSES FOR SOUND FIELDS

The most preferred conditions for the sound field in a concert hall are briefly described here by both temporal and spatial factors [2].

## 5.1. TEMPORAL CRITERIA

- (1) The most preferred initial time delay gap between the direct sound and the first reflection is expressed by

$$[\Delta t_1]_p \approx [1 - \log_{10} A](\tau_e)_{min}, \quad (14)$$

where  $(\tau_e)_{min}$  is the minimum value of the effective duration of the running ACF of the source signal, and  $A$  is the total amplitude of reflections given by

$$A = \left\{ \sum_{n=1}^{\infty} A_n^2 \right\}^{1/2}, \quad (15)$$

where  $A_n$  is the pressure amplitude of the  $n$ th reflection,  $n = 1, 2, \dots$ .

- (2) The most preferred-subsequent-reverberation time is approximately expressed by

$$[T_{sub}]_p = 23(\tau_e)_{min}. \quad (16)$$

## 5.2. SPATIAL CRITERIA

- (3) The typical spatial factor is the *IACC*. The consensus preference is obtained at the small value of the *IACC*, so that signals arriving at both ears should be dissimilar. But, the peak value of the *IACF* must be maintained at the origin of the delay time, i.e.,

$$\tau_{IACC} = 0 \quad (17)$$

so that the sound field should be well balanced.

- (4) The listening level *LL* in a room is classified into a spatial factor because of its right hemisphere dominance (Table 1). This is calculated at each seat, such as

$$LL = PWL + 10 \log(1 + A) - 20 \log d_0 - 11(dB), \quad (18)$$

where *PWL* is the power level of sound source, and  $d_0$  is the distance between the source and a listener, which is related to the direct sound. In the design stage of a concert hall and an opera house, the most preferred listening level  $[LL]_p$  is assumed at the center part of seating area because performers can control to some extent *PWL* to the listeners.

Important subjective responses of sound fields in relation to all the above-mentioned all of orthogonal factors are listed in Table 4. These include preferred conditions of performers [30], speech intelligibility [18], and reverberance of sound fields [31].

## 6. CONCLUSIONS

- (i) Primary sensations, pitch, loudness, timbre and duration may well be described by factors extracted from the ACF of the signal (Table 2).
- (ii) Spatial sensations such as localization, subjective diffuseness and apparent source width are described by factors extracted from *IACF* (Table 3).
- (iii) Subjective responses of music and speech sound fields may be described by factors extracted from both ACF and *IACF* (Table 4).

TABLE 4

*Fundamental subjective responses of music and speech sound fields in relation to factors extracted from the ACF and the IACF, and orthogonal factors of the sound field*

Factors	Subjective responses			
	Subjective preference	Subjective preference (performer)	Reverberance	Speech intelligibility <sup>†</sup>
ACF				
	$\tau_1$			X
	$\phi_1$			X
	$\tau_e$	X	X	X
IACF				
	$\tau_{IACC}$	(=0) <sup>‡</sup>	(=0) <sup>‡</sup>	
	$W_{IACC}$			
	$IACC$	X	X	X
Field				
	$LL$	X	X	X
	$\Delta t_1$	X	X	X
	$T_{sub}$	X	X	X

X: factors influencing the corresponding response;

$LL = 10 \log[\Phi(0)/\Phi(0)_{ref.}]$ , where  $\Phi(0) = [\Phi_{ll}(0)\Phi_{rr}(0)]^{1/2}$ .

<sup>†</sup>In order to describe speech intelligibility, additional factors  $\tau_i$  and  $\phi_i$  ( $i = 2, 3, \dots, N$ ) must be taken into account on occasions.

<sup>‡</sup>The preferred condition is obtained under the condition of  $\tau_{IACC} = 0$ .

## REFERENCES

1. Y. ANDO 1985 *Concert Hall Acoustics*. Heidelberg: Springer-Verlag.
2. Y. ANDO 1998 *Architectural Acoustics, Blending Sound Sources, Sound Fields, and Listeners*. New York: AIP Press/Springer-Verlag.
3. Y. ANDO, K. YAMAMOTO, H. NAGAMASTU and S. H. KANG 1991 *Acoustic Letters* **15**, 57–64. Auditory brainstem response (ABR) in relation to the horizontal angle of sound incidence.
4. Y. ANDO, S. H. KANG, and H. NAGAMATSU 1987 *Journal of the Acoustical Society of Japan* (E) **8**, 183–190. On the auditory-evoked potential in relation to the IACC of sound field.
5. Y. ANDO, S. H. KANG, and K. MORITA 1987 *Journal of the Acoustical Society of Japan* (E) **8**, 197–206. On the relationship between auditory-evoked potential and subjective preference for sound field.
6. Y. ANDO, and C. CHEN 1996 *Journal of the Architecture Planning and Environmental Engineering, Architectural Institute of Japan (AIJ)* **488**, 67–73. On the analysis of autocorrelation function of  $\alpha$ -waves on the left and right cerebral hemispheres in relation to the delay time of single sound reflection.
7. C. CHEN and Y. ANDO 1996 *Journal of the Architecture Planning and Environmental Engineering, Architectural Institute of Japan (AIJ)* **489**, 73–80. On the relationship between the autocorrelation function of the  $\alpha$ -waves on the left and right cerebral hemispheres and subjective preference for the reverberation time of music sound field.
8. S. SATO, K. NISHIO and Y. ANDO 1996 *Journal of the Acoustical Society of America* **100** (A), 2787. On the relationship between the autocorrelation function of the continuous brain waves and the subjective preference of sound field in change of the IACC.
9. Y. ANDO 1992 *Acustica* **76**, 292–296. Evoked potentials relating to the subjective preference of sound fields.
10. Y. SOETA, S. NAKAGAWA, M. TONOIKE and Y. ANDO 2001 *Proceedings of 17th International Congress on Acoustics, Rome*, Vol. III. Auditory evoked magnetic fields corresponding to the subjective preference of sound fields.

11. Y. KATSUKI, T. SUMI, H. UCHIYAMA and T. WATANABE 1958 *Journal of Neurophysiology* **21**, 569–588. Electric responses of auditory neurons in cat to sound stimulation.
12. N. Y.-S. KIANG 1965 *Discharge Pattern of Single Fibers in the Cat's Auditory Nerve*. Cambridge, MA: MIT Press.
13. H. E. SECKER-WALKER and C. L. SEARLE 1990 *Journal of the Acoustical Society of America* **88**, 1427–1436. Time domain analysis of auditory-nerve-fiber firing rates.
14. P. A. CARIANI and B. DELGUTTE 1996 *Journal of Neurophysiology* **76**, 1698–1716. Neural correlates of the pitch of complex tones. I. Pitch and pitch salience.
15. M. INOUE, T. TAGUTI and Y. ANDO 2001 *Proceedings of the 17th International Congress on Acoustics, Rome*, Vol. IV. On the pitch identification based upon the autocorrelation function model.
16. M. INOUE, Y. ANDO and T. TAGUTI 2001 *Journal of Sound and Vibration* **241**, 105–116. The frequency range applicable to pitch identification based upon the auto-correlation function model.
17. K. MOURI, K. AKIYAMA and Y. ANDO 2001 *Journal of Sound and Vibration* **241**, 87–95. Preliminary study on recommended time duration of source signals to be analyzed, in relation to its effective duration of autocorrelation function.
18. Y. ANDO, H. SAKAI and S. SATO 2000 *Journal of Sound and Vibration* **232**, 101–127. Formulae describing subjective attributes for sound fields based on a model of the auditory-brain system.
19. S. SATO, T. KITAMURA, H. SAKAI and Y. ANDO 2001 *Journal of Sound and Vibration* **241**, 97–103. The loudness of “complex noise” in relation to the factors extracted from the autocorrelation function.
20. E. ZWICKER, G. FLOTTORP and S. S. STEVENS 1957 *Journal of the Acoustical Society of America* **29**, 548–557. Critical band width in loudness summation.
21. K. SAIFUDDIN, H. SAKAI and Y. ANDO 2001 *Journal of Sound and Vibration* **241**, 117–127. Duration sensation of the simulated environmental noise in relation to its autocorrelation function.
22. K. SAIFUDDIN, T. MATSUSHIMA and Y. ANDO 2002 *Journal of Temporal Design in Architecture and the Environment* **2**, 42–47. Duration sensation when listening to pure tone and complex tone.
23. P. DAMASKE and Y. ANDO 1972 *Acustica* **27**, 232–238. Interaural crosscorrelation for multichannel loudspeaker reproduction.
24. S. SATO, V. MELLERT and Y. ANDO 2001 *Journal of Sound and Vibration* **241**, 53–56. Cues for localization in the median plane extracted from the autocorrelation function.
25. S. MEHRGARDT and V. MELLERT 1977 *Journal of the Acoustical Society of America* **61**, 1567–1576. Transformation characteristics of the external human ear.
26. Y. ANDO and Y. KURIHARA 1986 *Journal of the Acoustical Society of America* **80**, 833–836. Nonlinear response in evaluating the subjective diffuseness of sound field.
27. S. SATO 1999 *Ph.D. Thesis, Graduate School of Science and Technology, Kobe University*. On the Subjective Responses Based on the Auditory-brain Model in Relation to the Factors Extracted From the Interaural Cross-correlation Mechanism and the Auto-correlation Mechanism of Sound Fields.
28. M. V. Keet 1968 *Proceedings of the 6th International Congress on Acoustics Tokyo, Paper E-2-4*. The influence of early lateral reflections on the spatial impression.
29. S. SATO and Y. ANDO 2001 *Proceedings of the 17th International Congress on Acoustics, Rome*, Vol. III. Apparent source width (ASW) of complex noises in relation to the interaural cross-correlation function.
30. S. SATO, Y. ANDO and S. OTA 2000 *Journal of Sound and Vibration* **232**, 27–37. Subjective preference of cellists for the delay time of a single reflection in a performance.
31. S. HASE, A. TAKATSU, S. SATO, H. SAKAI and Y. ANDO 2000 *Journal of Sound and Vibration* **232**, 149–155. Reverberance of an existing hall in relation to both subsequent reverberation time and SPL.