



ACADEMIC
PRESS

Available online at www.sciencedirect.com

SCIENCE @ DIRECT®

Journal of Sound and Vibration 268 (2003) 617–626

JOURNAL OF
SOUND AND
VIBRATION

www.elsevier.com/locate/jsvi

Letter to the Editor

Influence of fastener placement on vibration-induced loosening

N.G. Pai, D.P. Hess*

Department of Mechanical Engineering, University of South Florida, 4202 East Fowler Avenue, ENB 118, Tampa, FL 33620, USA

Received 3 September 2002; accepted 5 March 2003

1. Introduction and background

Threaded fasteners are one of the most common means of joining parts of assemblies. They are often used in assemblies that are subjected to dynamic loads. Failure of joints due to dynamic loads generally occurs due to fatigue or loosening. Even partial loosening can reduce the fastener preload and thereby increase the dynamic loads acting on the fastener, leading to increased likelihood of fatigue failure. It is therefore crucial to understand the causes of loosening to avoid premature joint failure and incorporate the means to avoid loosening in assembly design.

Fastener loosening can result from several types of dynamic loads, such as shock, vibration and varying thermal loads. Previous research has shown that loosening is most severe when the joint is subjected to dynamic shear load [1]. This is a result of slip that occurs at the mating fastener surfaces (bolt and nut) and physically explained by the behavior of sliding friction. The fundamental aspects of loosening were identified by Junker [1] in 1969. Recently, new experimental and three-dimensional finite element analysis results have helped identify the minimum shear force required to cause loosening and also understand details of the underlying mechanism of loosening [2,3]. It was shown that in some cases, loosening in joints occurs due to localized slip when the fastener is subjected to dynamic shear force about half the magnitude required to cause complete slip at the fastener bearing surface.

Threaded fasteners can be subjected to dynamic shear loads due to several reasons. Junker [1] and Haviland [4] discuss some of the major causes of shear loading including bending, differential thermal expansion and impacts. Of these, shear due to bending is most widespread in structures and assemblies and can subject threaded fasteners to large shear forces. This paper explores the influence of placement on vibration-induced loosening in assemblies undergoing bending deflections. The objective is to develop a procedure to identify regions in an assembly where the fastener would be least likely to fail due to loosening.

In the early 1980s a joint ASME/ANSI subcommittee was formed to study the problem of vibration-induced loosening [5]. As part of this committee, Kerley [6] presented a comprehensive

*Corresponding author. Tel.: +1-813-974-5643; fax: +1-813-974-1447.

E-mail address: hess@eng.usf.edu (D.P. Hess).

research plan for the study of loosening of threaded fasteners. One of the proposals of the plan was to identify mathematical relationships that govern loosening based on the study of simple joints, such as beams and apply them to the design of more complex structures such as a bent frame. For instance, if shear were considered to be the primary cause of loosening, the shear load required to cause loosening can be determined for a beam and subsequently the mathematical relation obtained from analysis of the beam can be applied to design more complex structures, such as a bent frame, without the need for further testing. The analysis presented in this paper uses a similar approach.

Dong and Hess [7] utilized the above concept to identify locations for optimum placement of bolts on a compound cantilever beam excited at its natural frequencies. Starting on the premise that a fastener is more likely to loosen in regions with larger shear stress, they proposed that in an assembly excited at its natural frequency, fasteners must be placed away from nodes since they correspond to regions with the highest dynamic shear stress. The results were supported by experiments conducted on a compound cantilever beam. This paper analyzes the same compound beam as used by Dong and Hess, but the excitation frequency is away from the natural frequency of the assembly. The procedure presented in this paper is more general since it is not restricted to assemblies excited at their natural frequencies.

2. Mechanism of fastener loosening

The primary cause for loosening is a result of slip between the mating fastener surfaces. This can be illustrated using a block on incline system shown in Fig. 1. In such a system, when sufficient force is applied in the transverse direction, the block not only moves in the transverse

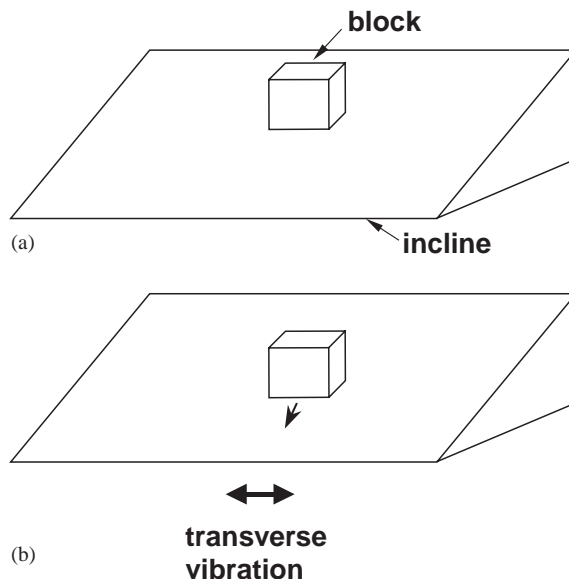

Fig. 1. Block on incline system.

direction, but also downwards. In a threaded fastener, the lead of the thread provides the direction for decreased potential energy, while the external loads provide the additional loads required to cause slip. Several causes of external loads have been identified and summarized in Fig. 2 [3].

The common suggested design guidelines to avoid loosening are tighter tolerances, bolts with large length to diameter ratios and larger preload to avoid slip [8,9]. In addition, locking features, such as thread adhesives and locking washers are also commonly used. Since use of locking features leads to higher costs and increased assembly/disassembly times, it is desirable to avoid loosening by alternate means. Since shear force is the primary cause of slip, this paper explores the option of varying the placement of fasteners such that the fastener is subjected to lower dynamic shear force.

3. Fastener shear due to bending

Previous work [1,4,6] has revealed that bolted joints can be subjected to shear load due to different types of loading. In addition to directly shear-loaded joint (Fig. 3a), joints can be

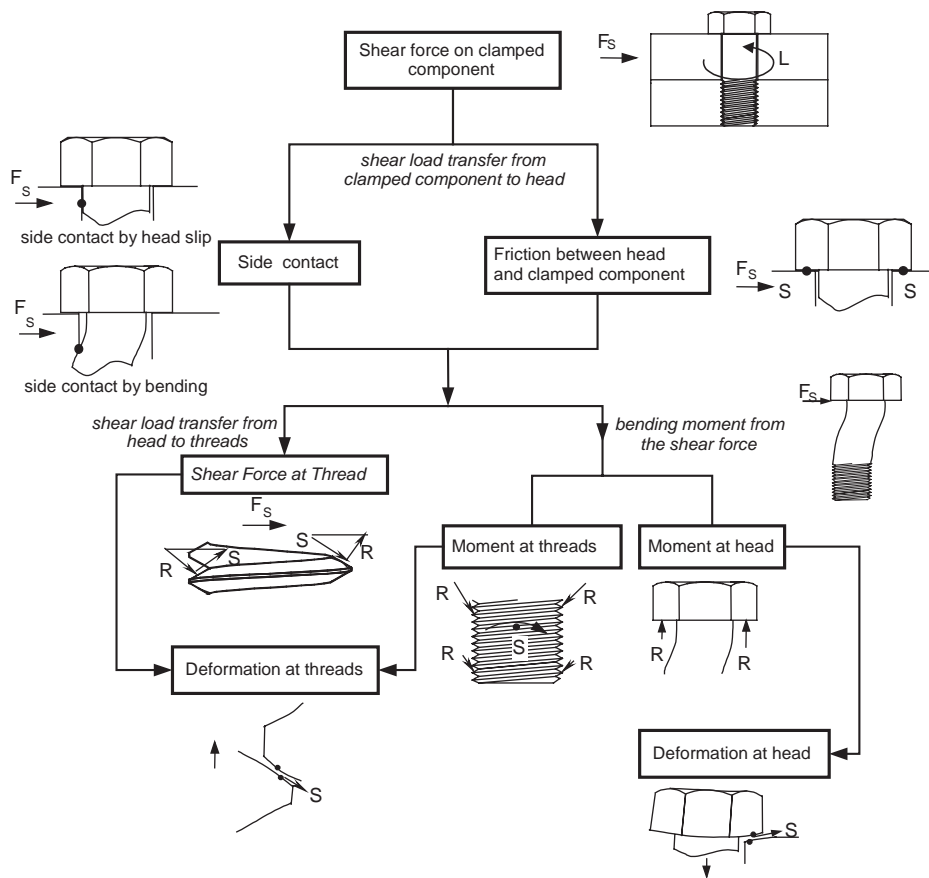

Fig. 2. Relationships between factors that influence loosening (F_s , applied shear force; L , loosening moment; S , tangential slip force; R , normal reaction).

subjected to shear as a result of bending of the components as illustrated in Fig. 3b. Examples in this paper are restricted to assemblies where shear loading on the fastener results from bending, since such loading is widespread (e.g., in beams, panels, etc.) and can be severe as shown below.

To illustrate the behavior of a bolted joint under bending induced shear, consider the compound cantilever assembly shown in Fig. 3b subjected to a vertical load V . Assuming that the assembly behaves as a composite beam (infinite friction at the interface), the expression for shear stress (τ) at the interface between the beams can be obtained for a beam of width b , and combined thickness d to be [10]

$$\tau = \frac{1.5V}{bd}. \quad (1)$$

From the shear force diagram of such a system, it is evident that V is constant along the span L_b of the beam, therefore the shear force, F_S , between the beams can be obtained by integrating the shear stress over the area,

$$F_S = \frac{1.5VL_b}{d}. \quad (2)$$

For the beam used in the experimental part of this study, where $d = 3.175$ mm, $L_b = 304.8$ mm and $V = 1$ N, the shear force between the beams is 144 N. This large shear from the applied vertical load makes the fasteners vulnerable to overloading in joints subjected to bending if such loads are not carefully accounted for in design. It is standard practice in design of joints subjected to shear to assume that the shear force F_S is resisted by the friction between the clamped beams, and only when the friction force has been overcome, is the fastener subjected to significant portion of the load.

A non-linear three-dimensional finite element model that includes friction and contact was developed using the commercially available software, ANSYS, to determine the loads acting on the fastener in a compound cantilever beam (see Fig. 3b) subjected to a concentrated load at the end. The mesh utilized for the finite element model of the beam is shown in Fig. 4. It models a beam assembly of two 6.35 mm thick beams, 304.8 mm long and 25.4 mm wide with a 6.35 mm

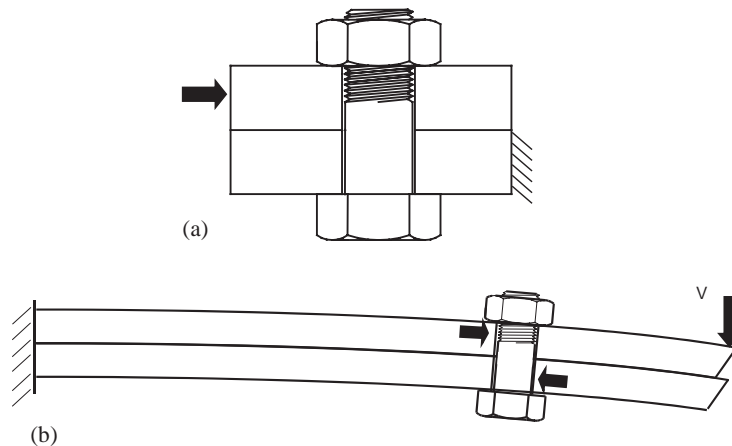

Fig. 3. Common causes of shear-loading on threaded fasteners: (a) direct shear loading and (b) bending induced shear loading [3].

diameter fastener placed 50.8 mm away from the loaded end. A fastener preload of 1.6 kN is developed by modelling an initial interference between the two clamped components. Due to symmetry only half of the geometry was modelled. The beam and the fastener are modelled with 20 node brick elements. The contact regions between the two clamped components, the fastener bearing surface and the clamped components, and between the sides of the fastener and the wall of the hole in the clamped component were modelled with general-purpose contact elements capable of modelling friction. A value of 0.15 was used for the coefficient of friction at all the contact regions. The model consisted of approximately 1900 nodes and 1100 elements.

Contact forces in the horizontal direction, which provide an indication of the shear load resisted by the assembly, are shown in Fig. 5. The contact force at the fastener bearing surface, (solid line) is seen to remain low until the friction between the clamped components (dashed line) is overcome at a load of about 250 N. From this point on, the shear force at the fastener bearing surface increases. This corresponds to the loading region where the fastener is most likely to loosen. As the load continues to increase, the sides of the fastener make contact with the beam, and from this point forward the load on the fastener bearing surface starts to reduce since the load transfer occurs through the stiffer path of the side contact. This illustrates the importance of side contact in increasing the fastener resistance to loosening.

4. General procedure for evaluation of fastener loosening

Based on the above results for the beam subjected to bending, the basic steps in determining locations for fasteners to minimize loosening are: (1) identify alternate design configurations, each

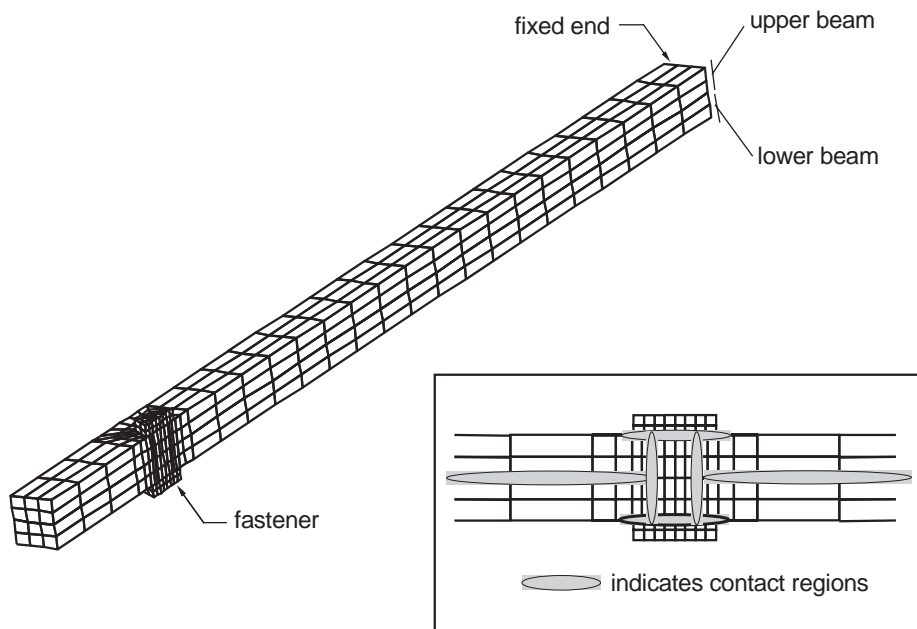

Fig. 4. Finite element mesh of compound cantilever beam model.

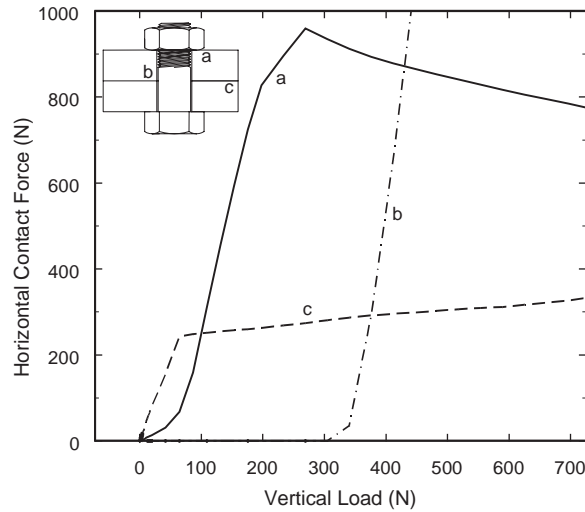

Fig. 5. Horizontal contact forces (friction and normal force) from the finite element model.

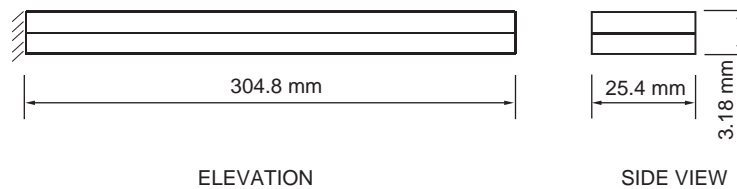

Fig. 6. Compound cantilever beam assembly.

with the fastener placed at a different location; (2) determine the shear force and slip acting on each fastener for each configuration due to service loads; (3) select the best design configuration based either on the lowest shear force or on the combination of low shear and sufficient slip to cause side contact. It must be noted that additional factors, such as ease of fabrication and cost will generally influence the final selection.

Steps 1 and 3 are based on the objective of the specific design being considered. Step 2 (i.e., the process of determining the shear force on a fastener) can be quite complex except for the very simplest of assemblies. In most cases, it requires the use of numerical analysis tools such as the finite element method.

There are different methods used to represent fasteners in finite element models depending on the objective of the analysis. The representation can be as simple as using common nodes between the clamped components, or as complex as actually modelling the entire fastener with brick elements with contact and preload. Other methods such as use of beam elements are also commonly used. Any of these can be used to estimate the shear force acting on the fastener for typical design purposes. This work utilizes the relatively complex method of modelling the entire fastener.

The above general approach for evaluation of assemblies based on fastener loosening is illustrated in the following sections with design of a compound beam assembly (Fig. 6). The finite

element model used for analysis of the compound beam utilizes brick elements to represent the fastener (see Fig. 4).

5. Illustration: design of compound cantilever beam assembly

Fig. 6 shows the basic geometry of a compound cantilever beam to be designed using two beams of equal dimensions. The present task is to analyze alternate designs based on vibration induced loosening when the assembly is subjected to dynamic service loads of 10 g at 40 Hz. The results of this simple analysis can be applied in the design of other composite joints, such as joints between stiffeners and plates.

Step 1: Alternate designs. Four alternate design configurations that utilize different locations for placement of fastener (h in Fig. 7) are listed in Table 1.

Step 2: Determining the shear. The mesh of the finite element model used for determining the shear on the fastener is similar to that shown in Fig. 4 except for modelling of the contact and the thickness of the beam. To minimize the computational cost of the model, the contact between the two beams was modelled by coupling the vertical displacement of the nodes at the interface between the two beams. This results in the two beams having the same vertical displacement (i.e., the two surfaces cannot separate), while allowing them to slip relative to each other. The contacts at the fastener were changed to bonded contacts not capable of sliding. These modifications make the models linear, consequently the computations are reduced by three orders of magnitude in relation to a model with non-linear contact elements.

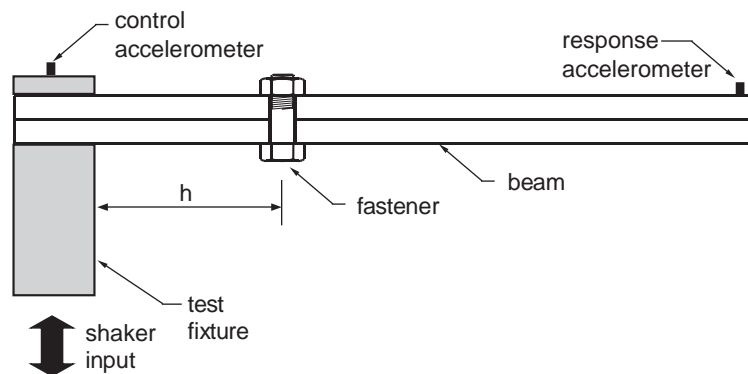

Fig. 7. Compound cantilever test apparatus.

Table 1
FEA results of compound cantilever beam designs subjected to 10 g at 40 Hz

Design	Distance of fastener from fixed end (mm)	Normalized shear force on fastener	Estimated slip (mm)
1	66.8	1.0	0.04
2	107.2	3.4	0.22
3	149.4	14.1	1.28
4	206.5	20.9	2.54

As a result of the simplifications in the above model, the friction force between the beams is ignored, and the entire shear force developed by bending is directly transferred to the fastener through the head contacts (side contacts are not modelled). Since the friction between the beams is not a function of the location, but merely the preload and the coefficient of friction, this does not alter the value of the model to provide useful data for comparison.

Step 3: Selecting the design. Table 1 shows the shear force and fastener bending deformation measured from the model for the above cases. The data has been normalized with respect to the lowest number in the group. Based on the normalized shear force, it is clear that the fastener is less likely to loosen in Design 1 and most likely to loosen in Design 4.

Tests were conducted on an apparatus similar to that used by Dong and Hess [7] to compare the results of the above analysis with experimental data. The test setup shown in Fig. 7 consists of a pair of 330.2 mm long, 25.4 mm wide and 1.59 mm thick 316 stainless-steel beams. The beams are secured to the test fixture with four 10–32 UNF-3A socket screws over a length of 25.4 mm, making the effective length of the cantilever beams to be 304.8 mm. Both beams have four holes, located at distances of the 66.8, 107.2, 149.4 and 206.5 mm away from the fixed end of the beam. These holes correspond to the location of the fastener in the four alternate design configurations considered above (Fig. 7 and Table 1). The beams were assembled at these locations with a single 12.7 mm long Grade 5 0.25–20 UNC hex head bolts with mating nut. Contact surfaces between the two beams, as well as the bolt head and thread were lubricated with anti-seize lubricant to reduce the scatter in the experimental data. The first two natural frequencies of the assembled beams were found to vary from 20 to 24 Hz and 108 to 130 Hz, respectively.

Tests were conducted to determine the loosening response of the beams in configurations corresponding to each of the four designs considered above. The dynamic load required to cause fastener loosening in the assembly was determined as follows. The assembly was subjected to a nominally low sinusoidal load at 40 Hz through a shaker such that no loosening occurs. The magnitude of the dynamic load was then increased in steps of 0.1 g every 10 s until complete loosening was observed. The state of fastener loosening was determined by monitoring the ratio of the response of the accelerometer placed at the end of the cantilever, to that of the control accelerometer (see Fig. 7). This ratio was found to drop abruptly as a result of loosening.

The average vibration amplitude required to induce fastener loosening, as well as the standard deviation from three runs is shown in Table 2. The results show the assembly can withstand maximum dynamic load (15.7 g) when the fastener is placed at location 1. This agrees qualitatively with the results of the finite element analysis, which showed Design 1 to be the most resistant to fastener loosening. The load required to cause fastener loosening was found to be about 10 g at the remaining three locations. This behavior is a result of the relative amount of slip that occurs at

Table 2
Compound cantilever beam test results with sinusoidal loading at 40 Hz

Design	Amplitude of dynamic load required to cause fastener loosening (g 's)	Std. dev. (%)
1	15.7	6.5
2	9.9	9.4
3	10.1	5.4
4	10.2	5.0

these locations. It was shown earlier (Section 3) that a fastener is subjected to significant shear load only after the friction between the beams has been overcome. If at this stage side-contact occurs between the beam and the fastener, the shear loads acting at the bolt and nut bearing areas are limited in spite of the high magnitude of the total shear acting on the fastener (see Fig. 5). Since the amount of slip at these three locations is significant (see Table 1) relative to the hole clearance of 0.18 mm, side contact occurs after the friction between the beams has been overcome.

The data shows that shear load is a good predictor of loosening since it explains the fact that a larger load was required to cause loosening in Design 1. However, it is seen that the occurrence of side contact due to bending can lead to an assembly with significantly greater resistance to loosening than predicted by shear force alone. In such situations, the behavior can be predicted based on the amount of slip (relative to the hole fit) that occurs at fastener locations. Again, the occurrence of side contact is seen to be a crucial factor that determines the performance of a fastener subjected to dynamic shear loads.

6. Discussion

The above illustration shows that it is possible to minimize the likelihood of fastener loosening failure by varying the location of threaded fasteners. While shear force is the main predictor of loosening, it is necessary to consider the effect of slip and side-contact in assemblies with significant slip, i.e., when slip is greater than hole tolerance. The assemblies in the above analysis were modelled with nominal dimensions. However in practice, factors such as slight misalignments can alter the loading on a fastener, and therefore its loosening response. In general, these would reduce the likelihood of loosening if side contact occurs due to misalignment, but increases the likelihood of overloading the fastener in shear.

The above analysis revealed that fasteners placed in certain regions of assemblies are subjected to higher shear force, therefore by avoiding fastener placement in such regions, the likelihood of fastener loosening is reduced. Another effect of varying the location of the fastener is that it can alter the dynamics of the structure by changing the stiffness and inertia characteristics of the assembly as indicated by the change in the natural frequency of the beam assembly with location of fasteners. This effect can be used to avoid loosening by placing fasteners in regions that result in less severe loading conditions, for example by shifting the natural frequency of the system away from the loading frequency. For example, it has been reported that merely shifting the external load frequency by a few Hertz away from the natural frequency of the compound beam leads to cessation of fastener loosening [6].

The loading used in the above illustrations is quite simple. However, using existing finite element analysis tools it is relatively simple to subject the assembly to more complex loadings, such as broadband random excitation and determine the optimum placement of fasteners even in such cases. In general, the response of a structure is largely influenced by the type of joint, loading, and geometry, and although a general method for fastener placement has been presented and illustrated in this paper, general guidelines for placement that apply to a wide variety of structures are not apparent. For instance, the suggestion to place fasteners at anti-nodes in assemblies based on tests on a compound cantilever beam excited at its natural frequency [7] does not provide the optimum solution for a bent frame [11].

While a commonly proposed solution to fastener loosening is to avoid slip between the clamped components, it is sometimes desirable to use threaded fasteners and allow slip to dissipate energy through slip damping [12]. The analysis presented in this paper can be used to guide design of such assemblies.

Acknowledgements

The authors gratefully acknowledge the support from the National Science Foundation under Grant No. CMS-9629217.

References

- [1] G.H. Junker, New criteria for self-loosening of fasteners under vibration, *SAE Transactions* 78 (1969) 314–335.
- [2] N.G. Pai, D.P. Hess, Experimental study of loosening of threaded fastener due to dynamic shear loads, *Journal of Sound and Vibration* 253 (3) (2002) 585–602.
- [3] N.G. Pai, D.P. Hess, Three dimensional finite element analysis of loosening of threaded fastener under dynamic shear loads, *Engineering Failure Analysis* 9 (2002) 383–402.
- [4] G.S. Haviland, Designing with threaded fasteners, *Mechanical Engineering* 105 (1983) 17–31.
- [5] J.H. Bickford, Fastener group seeks answers to bolted-joint problems, *Machine Design* 26 (1984) 77–80.
- [6] J.J. Kerley, An application of retrodution to analyzing and testing the backing off of nuts and bolts during dynamic Loading, NASA Technical Memo. 4001, Goddard Space Flight Center, Greenbelt, MD, 1982.
- [7] Y. Dong, D.P. Hess, Optimum placement of fastener in structures based on dynamic shear, *Journal of Sound and Vibration* 217 (1998) 396–404.
- [8] J.H. Bickford, *An Introduction to the Design and Behavior of Bolted Joints*, 3rd Edition, Marcel Dekker, New York, 1995.
- [9] D.P. Hess, Vibration- and shock-induced loosening, in: J.H. Bickford, S. Nasser (Eds.), *Handbook of Bolts and Bolted Joints*, Marcel Dekker, New York, 1998, pp. 757–824.
- [10] N. Willems, J.T. Easley, S.T. Rolfe, *Strength of Materials*, McGraw-Hill, New York, 1981.
- [11] N.G. Pai, *Vibration Induced Loosening of Threaded Fasteners: Mechanisms, Modeling and Design Guidelines*, Ph.D. Dissertation, University of South Florida, Tampa, FL, 2002.
- [12] Y.S. Shin, J.C. Iverson, K.S. Kim, Experimental studies on damping characteristics of bolted joints for plates and shells, *Journal of Pressure Vessel Technology* 113 (1991) 402–408.