

202. *The Hydrogenation of Furfuraldehyde to Furfuryl Alcohol and Sylan (2-Methylfuran).*

By JOHN G. M. BREMNER and RICHARD K. F. KEEYS.

Both sylan and furfuryl alcohol are formed in the hydrogenation of furfuraldehyde in the vapour phase at atmospheric pressure with a copper catalyst. The alcohol is formed in the lower temperature range ($\leq 200^\circ$) and sylan at intermediate temperatures ($\sim 250^\circ$). At higher temperatures ($\geq 300^\circ$) furfuryl alcohol tends once more to be the main product, but operation under these conditions leads to a rapid decline in catalyst activity. A regular change from the predominance of sylan to that of furfuryl alcohol occurs with an increase in the amount of

alkali added to the catalyst. The presence of chromium oxides, on the other hand, favours the formation of sylvan. A theory of hydrogenation is proposed to account for these effects.

THE hydrogenation of furfuraldehyde in the vapour phase at atmospheric pressure is reported to give sylvan (2-methylfuran) in excellent yield (Burnette, *Iowa State Coll. J. Sci.*, 1944, **19**, 9; Wilson, *J.*, 1945, 61) but other workers find that furfuryl alcohol may be the main product (Ricard and Guinot, F.P. 639,756; U.S.P. 1,739,919; D.R.-P. 528,820; Lazier, U.S.P. 2,077,422). Where this is so, an increased overall conversion of furfuraldehyde into sylvan may be obtained by the further passage of the alcohol over the catalyst or by working at a higher catalyst temperature:

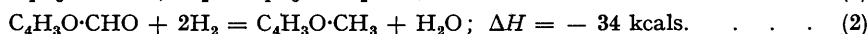
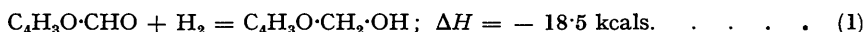

The present work aimed at a more detailed and systematic investigation of the catalytic hydrogenation of furfuraldehyde in the vapour phase. The emphasis was placed on those factors which determine the main product to be furfuryl alcohol or sylvan. The results obtained in this and related work are considered from the standpoint of a theory of catalysis involving the intermediate formation of radicals.

EXPERIMENTAL.

Furfuraldehyde.—The commercial material was distilled at 30–40 mm. The colourless distillate had d_{20}^{20} 1.160, n_D^{20} 1.525, b. p. 161–162°, and contained 0.003% of sulphur.

Hydrogen.—Electrolytic cylinder gas was used containing about 0.001% of carbon monoxide.

Catalysts.—Five different copper catalysts were used.

Copper-aluminium alloy catalysts were prepared from chill castings. The casting was crushed to give $\frac{1}{8}$ – $\frac{1}{2}$ " diameter granules and then activated by treatment with 0.4% aqueous sodium hydroxide at 100°: this removes aluminium from the surface layers but leaves the granule size unchanged (cf. Bag and Egupov, *Uspekhi Khimii*, 1945, **14**, No. 1, 56). In these catalysts both the original alloy composition and the amount of aluminium extracted may be varied. The alloys examined contained 34, 55, and 62% of copper and the aluminium extracted varied from 5 to 35%. After activation, the granules were washed with water to remove alkali. The catalyst may be stored under water until required.

Three copper-alumina catalysts were prepared. (A) Cu–Al₂O₃ was prepared by dehydrating alumina trihydrate to the monohydrate, moulding it into $\frac{1}{8}$ " × $\frac{1}{8}$ " cylinders, and then dehydrating it to γ-Al₂O₃ by heating to 750°. The pellets were impregnated with copper nitrate to give 20% of Cu calculated on Al₂O₃. (B) Cu–Al₂O₃ was prepared by impregnating the commercial activated alumina supplied by the Aluminium Ore Company of America with copper nitrate to give a 20% copper content. (C) Cu–Al₂O₃ was a co-precipitated catalyst formed by addition of sodium carbonate to the mixed metal nitrates. The precipitate, after being washed, was heated to 350°, and then made into cylindrical pellets as above.

A copper chromite catalyst, magnesium promoted, was prepared in similar fashion to that described by Adkins, Connor, and Folkers (*J. Amer. Chem. Soc.*, 1932, **54**, 1138). The Cu : Cr : Mg atom ratio in this catalyst was 1 : 1.05 : 0.04. The catalyst was used in the form of $\frac{3}{8}$ " × $\frac{3}{8}$ " pellets.

The copper-alumina and copper-chromite catalysts were reduced by hydrogen before use. Care was taken in this operation not to exceed 400°, the maximum reduction temperature normally being 350°.

The pelleted catalysts may be modified by impregnation with soluble salts. This is readily accomplished by adding to the pellets a volume of aqueous solution such that complete absorption occurs.

Apparatus.—Experiments were carried out in a continuous manner by passage of furfuraldehyde vapour and hydrogen downwards through the catalyst mass. Two types of apparatus were used, in both of which the catalyst tube was vertical. In one, the catalyst, supported on silica granules, was contained in a "Pyrex" glass tube (42" × 1 $\frac{1}{4}$ ") (Fig. 1). The space above the catalyst was packed with silica granules, and acted as a vaporising and pre-heating zone. The temperature through the contact material was measured by a movable iron-constantan thermocouple held in a glass sheath disposed axially down the tube. The catalyst volume was normally 200 ml. The catalyst tube was surrounded by an iron tube heated by three electrical windings independently controlled. In the absence of a pronounced heat of reaction, this arrangement enables a uniform temperature to be maintained throughout the catalyst mass. This apparatus will subsequently be referred to as the "standard" one.

The other apparatus comprised a "Staybrite" metal catalyst tube (45" × 1") to which was welded a metal jacket (Fig. 2). The catalyst arrangement was as in the glass tube but with the thermocouple sheath of "Staybrite" metal. The jacket was filled with liquid of b. p. suitable to maintain the reaction temperature. The vapour arising from the boiling liquid was condensed and returned. The liquid was heated to the b. p. by electrical windings on the exterior of the jacket. In exothermic reactions the heat evolved is removed by vaporisation of the surrounding liquid. The exterior surface of the catalyst tube is, in this way, held at a constant temperature regardless of the thermal nature of the reaction. This apparatus will subsequently be referred to as the "jacketed" type.

For both catalyst tube arrangements, furfuraldehyde was fed from a calibrated vessel by displacement with hydrogen evolved electrolytically. Hydrogen was admitted to the tube through an integrating rotary gas-meter capable of measuring rates up to about 100 l./hr. The products from the catalyst tube passed through a water-cooled double-surface condenser to a glass receiver. Unreacted hydrogen was passed through two receivers immersed in ice and water and two receivers immersed in solid carbon dioxide-methanol. Material entrained by the gas was recovered in these receivers. The volume of

unreacted hydrogen was measured by an integrating rotary gas-meter. The volume of hydrogen absorbed during the hydrogenation gives an excellent indication of the course of the reaction.

Analysis of Products.—Gaseous products were analysed in an Orsat apparatus. The liquid products were homogeneous if the furfuraldehyde were largely unchanged or if furfuryl alcohol was the main product. With sylvan as the main product, a lower aqueous layer was obtained. Small amounts of aqueous top layer were observed when the product was a mixture of sylvan, furfuryl alcohol, and some

FIG. 1.

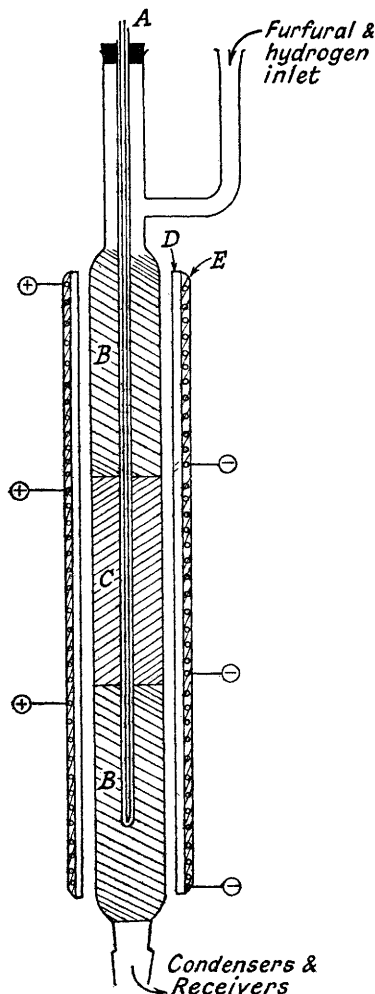

Standard catalyst tube arrangement.

Key to Fig. 1.

- A = Thermocouples.
- B = Silica granules.
- C = Catalyst.
- D = Iron tube.
- E = Electrical windings.

FIG. 2.

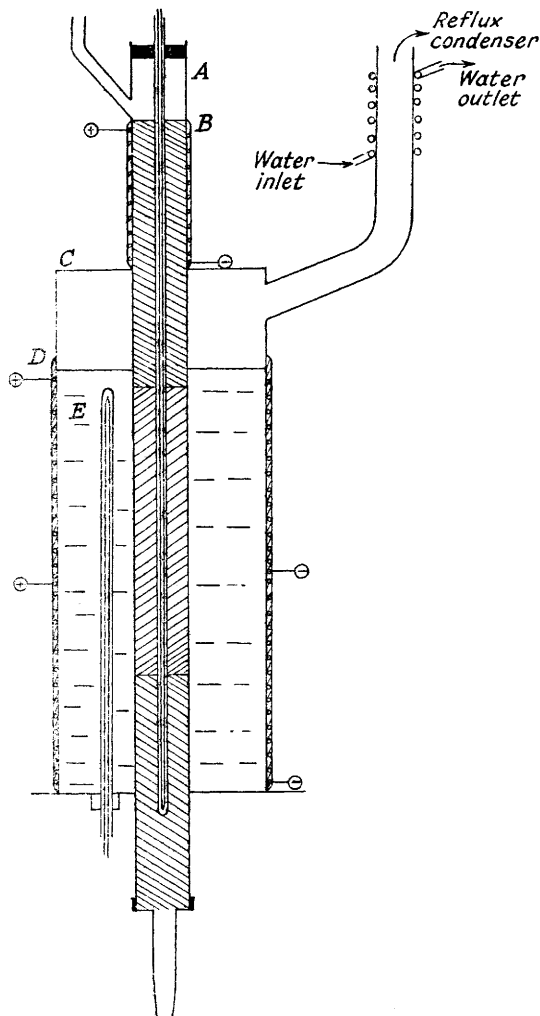

Jacketed catalyst tube arrangement.

Key to Fig. 2.

- A = Metal catalyst tube.
- B = Vapouriser.
- C = Metal jacket.
- D = Jacket heaters.
- E = Temperature control liquid.

unreacted aldehyde. In addition to sylvan and furfuryl alcohol, furan and pentanone-2 (Burnette, *loc. cit.*) were sometimes formed in small amount, and a pentanol in traces. Sylvan appears to be the precursor for pentanone-2.* Furfuraldehyde may suitably be estimated in a homogeneous product by titration of the acid liberated on reaction with hydroxylamine hydrochloride. This determination is carried out at room temperature, for, under reflux conditions, furfuryl alcohol also reacts with hydroxyl-

* Sylvan can be hydrogenated in good yield to pentanone-2 by using a copper catalyst (unpublished work).

amine hydrochloride liberating approximately 1 mol. of hydrochloric acid per mol. of alcohol. This effect is presumably due to a ring opening reaction (Pummerer, *Ber.*, 1923, **56**, 999). Although both furfuraldehyde (Hughes and Acree, *Ind. Eng. Chem. Anal.*, 1934, **6**, 123; *Cereal Chem.*, 1941, **18**, 572) and furfuryl alcohol may react with bromine, the use of pyridine sulphate bromide as reagent (Fitelson, *J. Assoc. Off. Agric. Chem.*, 1943, **26**, 499; Wilson and Nisbet, *Analyst*, 1946, **71**, 183) limits the attack almost completely to furfuryl alcohol. (A fuller description of these analytical methods will shortly be published.)

In addition to the chemical analysis of a homogeneous product, both it and the heterogeneous one were fractionated in a column equivalent to about 20 theoretical plates. When 100° was reached, the distillation was continued at about 20 mm. to separate unreacted furfuraldehyde from furfuryl alcohol (Dunlop and Trimble, *Ind. Eng. Chem.*, 1940, **32**, 1000). Distillative analysis is not straightforward, for furan, sylvan (Pranishnikov and Genin, *J. Appl. Chem. U.S.S.R.*, 1940, **13**, 140), pentanone-2, pentanol-2, and furfuraldehyde all form azeotropes with water. As the water content of these azeotropes exceeds the water miscibility at room temperature the distillates separate into two layers (see Table I).

TABLE I.

Water azeotropes : boiling point and composition.

| Compound. | B. p. | Water azeotrope. | |
|------------------------|-------|------------------|------------------------|
| | | B. p. | Water content (wt. %). |
| Furan | 32° | 30.5° | 1.2 |
| Sylvan | 63 | 58 | 4.9 |
| Pentanone-2 | 102.3 | 82.9 | 13.5 |
| Pentanol-2 | 119.3 | 92.5 | 38.5 |
| Furfuraldehyde | 162 | 98 | 64 |
| Furfuryl alcohol | 171 | — | — |

The low b. p.s of furan and sylvan make their complete recovery during distillation difficult unless cooled condensers and receivers are used. A loss of 5% of sylvan under normal distillation conditions

FIG. 3.

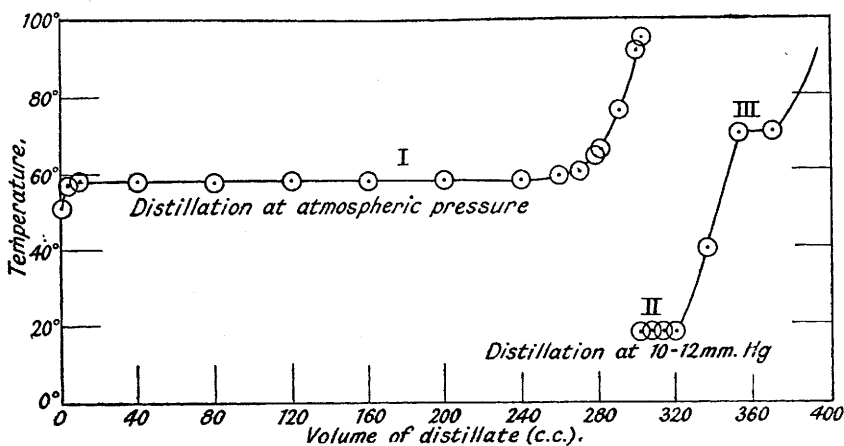

Distillation of the product from the hydrogenation of furfuraldehyde.

I, Sylvan-water azeotrope; II, Furfuraldehyde-water azeotrope; III, Furfuryl alcohol.

readily occurs. When distilled, furfuraldehyde and furfuryl alcohol tend to polymerise, particularly where impregnated catalysts are used which decompose to give acid vapours on heating. This effect was minimised by addition of sodium carbonate to the receiver in which the liquid products were collected. The results of a typical distillation are given in Fig. 3.

It is clear that where a mixture of products is obtained a rigorous analysis is difficult. When either sylvan or furfuryl alcohol alone is formed the interpretation is greatly simplified.

Results.—The terms pass conversion and yield are used to denote, respectively, the percentage of furfuraldehyde used in a single passage over the catalyst and the per cent. of the theoretical yield based on the amount of furfuraldehyde converted. As some 100–150 g. of furfuraldehyde were used in a normal experiment, yields were calculated on the weight and analysis of product obtained so as to counteract the large effect that small weight losses would otherwise have.

The small-scale experiments here described were, in part, the basis for the large-scale preparation of sylvan and furfuryl alcohol. The yields obtained equalled any now given.

Space velocity refers to the volume of furfuraldehyde fed per unit bulk volume of catalyst space per hour.

There is frequently some ambiguity in published work on catalytic reactions as to the interpretation to be placed on the temperature measurements. Normally, only one temperature is given, although it is

evident that the catalyst is not being worked under isothermal conditions. In this work the reaction temperature given is the maximum or peak temperature of the catalyst averaged from recorded half-hourly readings during experiments of a normal duration of 6 hours. In exothermic reactions the catalyst temperature rises rapidly at the beginning of the catalyst mass and then falls off slowly to a steady value which we term the "base" temperature. Typical temperature profiles measured longitudinally down the catalyst mass are given in Fig. 4. Curve VI shows the peak temperature to be only a few degrees above the base temperature for the hydrogenation to furfuryl alcohol ($\Delta H_{298}^0 = -18,500$ cal.). The higher exothermicity accompanying sylvan formation ($\Delta H_{298}^0 = -34,000$ cal.) is evident from curve V,

FIG. 4

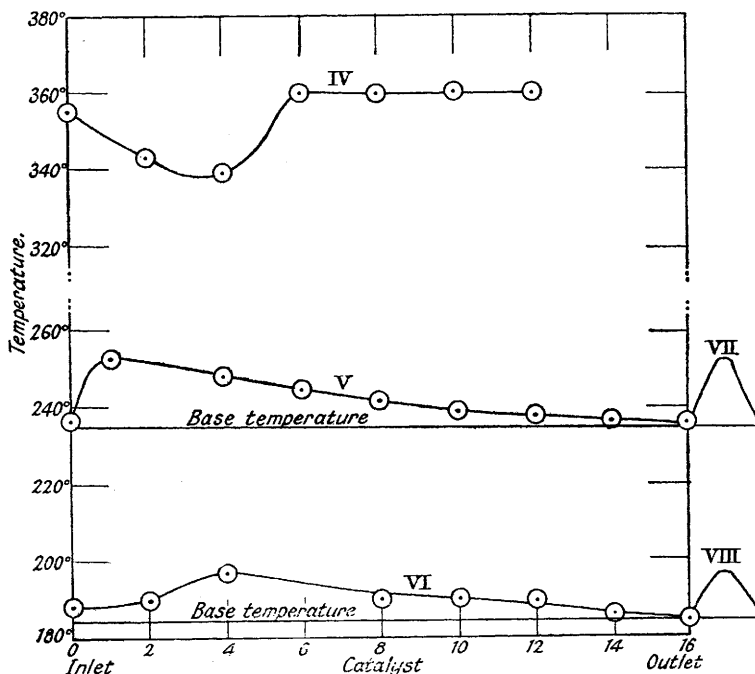

Catalyst temperature profiles for endothermic and exothermic reactions.

Longitudinal profiles: IV, Dehydrogenation and dehydration of isopropanol; V, Hydrogenation of furfuraldehyde to sylvan; VI, Hydrogenation of furfuraldehyde to furfuryl alcohol.

Radial profiles: VII and VIII, Reactions as for V and VI.

Fig. 4, in which the temperature increment is about 20° . The peak temperature is the important one from the standpoint of reaction rate, while the base temperature controls the pass conversion in those reactions which are reversible under the conditions of the experiment. Reaction (1) is reversible in this sense, but not reaction (2). In addition to the longitudinal temperature profile there is a corresponding radial gradient at right angles. The radial gradient is a maximum at the peak temperature and becomes almost zero in the region of the base temperature. The maximum radial gradients are shown alongside curves VI and V in Fig. 4.

In an endothermic reaction the temperature falls at the beginning of the catalyst mass and rises slowly to the base temperature. This is shown in curve IV, Fig. 4.

DISCUSSION.

(1) *Equilibria in the Conversion of Furfuraldehyde into Furfuryl Alcohol and Sylvan.*—Only the scantiest of thermodynamic data are available for furfuraldehyde and furfuryl alcohol, and none has been published for sylvan. Early work by Landrieu, Bayloq, and Johnson (*Bull. Soc. chim.*, 1929, 45, 36) gives the heat of combustion of liquid furfuraldehyde and furfuryl alcohol. Miller (*Iowa State Coll. J. Sci.*, 1936, 10, 91) gives the free energy of formation of the liquids as -32 and -45.2 kcal., respectively, at 298°K . The latent heat of furfuraldehyde alone has been published (Crawford, *Ind. Eng. Chem.*, 1940, 32, 1280).

For the hydrogenation in the vapour phase of furfuraldehyde to furfuryl alcohol, we derive $\Delta H_{298}^0 = -18.5$ kcal. from the combustion data. In making this calculation we have taken the latent heat of the alcohol to be 1 kcal. greater than that of the aldehyde. From bond energies (Pauling, "The Nature of the Chemical Bond," 1939, Chaps. 2 & 4) we obtain $\Delta H_{291}^0 =$

—17.6 kcal. Both these values are higher than those given for similar reactions (Cubberley and Mueller, *J. Amer. Chem. Soc.*, 1946, **68**, 1149). The resonance energy of sylvan being taken as 24.5 kcal. (Pauling, *J. Amer. Chem. Soc.*, 1939, **61**, 1778), the hydrogenation heat of furfuraldehyde vapour to sylvan is found to be $\Delta H_{291}^{\circ} = -34$ kcal.

The Nernst approximate theorem gives 98 and 60% pass conversion for reaction (1) at 0° and 300°, respectively, but the use of five times the theoretical amount of hydrogen raises the conversion to 96% at 250° at 1 atm.

The Nernst theorem applied to reaction (2) shows conversion to be substantially complete up to 300° at atmospheric pressure even with a stoichiometric ratio of hydrogen.

(2) *The Effect of Catalyst Temperature on the Course of Hydrogenation.*—Experiments carried out with copper-aluminium alloy catalysts (Table II) show the activity of the activated alloy to vary little with composition in the range 34—62% of copper (S.118, S.240, and S.244). The activity is, however, dependent on the amount of aluminium removed during the activation procedure. While it is very small for the original alloy (S.198), the removal of only 5% of aluminium (S.155) gives an active catalyst. Somewhat greater activity is apparent at higher extractions (S.118 and S.162), where, however, the copper surface tends to be removable by abrasion. A convenient extraction is 10—20%, and, particularly with the lower value, a catalyst which has become inactive in use may be further extracted to restore the activity. When the activity declines owing to a deposition of carbonaceous material, a high activity results from treatment with air at about 400° followed by reduction with hydrogen (S.126).

The results in Table II show sylvan to be the major product with the alloy catalyst operated in the region of 250° regardless of either the alloy composition or the amount of aluminium extracted. The treatment with air of a catalyst whose activity has declined in use, due to the deposition of carbonaceous material (S.124), leaves unaffected the formation of sylvan in high yield, as does the exposure of the catalyst to air before reaction (S.123). Although these changes in catalyst composition and treatment failed to affect the formation of sylvan, yet experiments conducted at temperatures below about 250° effected a marked change in the products of hydrogenation. At about 200° (S.270) furfuryl alcohol becomes the major product. Whilst this behaviour is not unexpected from previous work, it was surprising to find that at 300° (S.124) the activity of the catalyst declined steadily during operation. Further, this decline in activity was accompanied by an increase in the yield of furfuryl alcohol and a decrease in that of sylvan. The activity of the catalyst could be completely restored by careful treatment with air at a

TABLE II.

*Examination of Cu-Al alloy catalysts.**

| Expt. No. | Initial alloy com- posn. Cu, %. | Al re- moved, %. | Liquid space velocity (hrs. ⁻¹). | Temp. | Molar ratio, H ₂ /alde- hyde. | Dur- ation of expt. (hrs.). | Pass conv. (%). | Yield (%). | | Remarks. |
|-----------|------------------------------------|------------------------|---|-------|---|---|-----------------------|------------|---------------------------|--|
| | | | | | | | | Sylvan. | Fur- furyl alcohol. | |
| S.198 | 55 | Nil | 0.22 | 264° | 7.1 | 1.0 | ~10 | — | — | Al extraction variable. |
| S.155 | 55 | 5 | 0.16 | 253 | 7.3 | 6.0 | 90.5 | 89 | 2 | |
| S.118 | 55 | 20 | 0.19 | 248 | 6.1 | 6.0 | 97.6 | 88 | 5 | Alloy composition variable. |
| S.162 | 55 | 35 | 0.12 | 243 | 6.8 | 6.25 | 99 | 88 | 3 | |
| S.240 | 34 | 20 | 0.17 | 254 | 7.1 | 5.0 | 91 | 89 | 3 | Temp. variable. |
| S.244 | 62 | 20 | 0.15 | 255 | 5.8 | 6.5 | 99.6 | 84 | 6 | |
| S.124 | 55 | 20 | 0.27 | 300 | 5.4 | 6.25 | 27.6 | 42 | 46 | Catalyst exposed to air 30 hrs. before exper- iment. |
| S.270 | 55 | 20 | 0.18 | 193 | 5.7 | 4.0 | 63 | 29 | 66 | |
| S.123 | 55 | 20 | 0.19 | 249 | 4.9 | 6.25 | 91.8 | 87 | 8 | Catalyst <i>ex</i> S.124; air-treated at 400°, reduced at 350°. |
| S.126 | 55 | 20 | 0.17 | 250 | 5.3 | 6.5 | 98 | 87 | 5 | |

* The standard apparatus was used in all experiments except S.270, for which the jacket apparatus was used.

maximum temperature of about 400°. The peak temperature reached during such treatment is important since the alloy containing 55% of copper melts at 590°. A catalyst which has been worked at such temperatures shows obvious signs of fusion and is rendered permanently inactive.

The effect of temperature on the relative yields of sylvan and furfuryl alcohol was also examined

with the three Cu-Al₂O₃ catalysts A, B, and C. The results are shown graphically in Fig. 5. The hydrogenations were carried out under similar conditions of space velocity and hydrogen : furfuraldehyde ratio to those of Table II. To facilitate the temperature control in the lower range around 200° the jacketed apparatus with decahydronaphthalene (b. p. 190°) as temperature-control liquid was used in these experiments. The results closely resemble those of the alloy catalyst. At around 250° sylvan is formed in high yield, but at 200° furfuryl alcohol is the major product. In the region of 300° fairly rapid catalyst deterioration occurs, and with it a change from sylvan to furfuryl alcohol as the major product. The effect of temperature on pass conversion is shown in Fig. 6. At 200° conversion is not quite complete at a space velocity of 0.27 hr.⁻¹ (S.86) and falls from 80 to 48% (S.101) with an increase in space velocity to 0.66 hr.⁻¹, showing catalyst activity to be the limiting factor. At 250° and the normal space velocity of about 0.2 hr.⁻¹, conversion is practically complete. In the region of 300° the catalyst activity

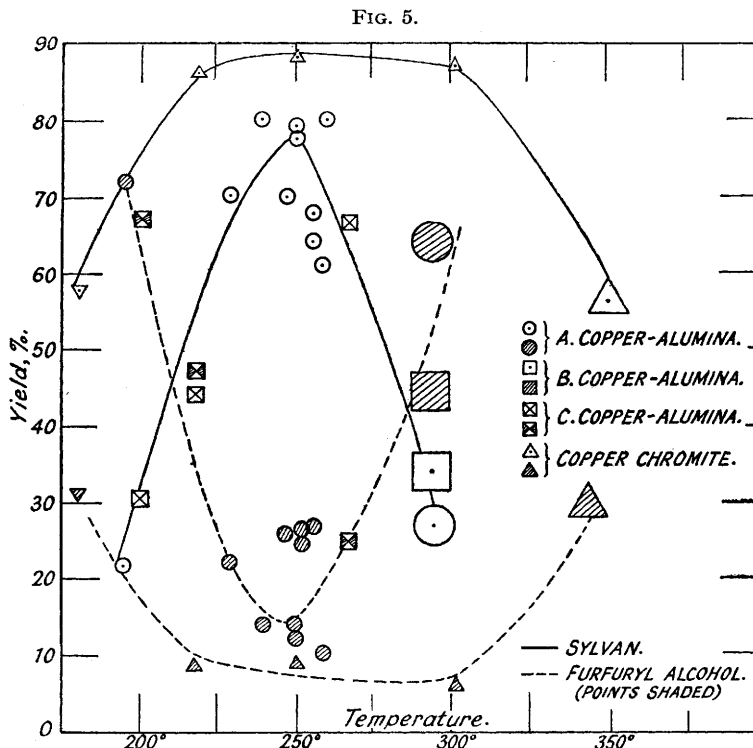

The variations in yield of sylvan and furfuryl alcohol with temperature.

falls away progressively, so the pass conversion depends on the duration of the experiment. Catalysts which have deteriorated in this way may be restored in activity by treatment with air at about 400°, followed by reduction in hydrogen.

The variation in the ratio of sylvan to furfuryl alcohol with temperature is very similar for both the alloy and copper-alumina catalysts. The behaviour of the copper chromite catalyst is qualitatively similar. It is, however, very much less sensitive to temperature variations with regard both to the relative yields of furfuryl alcohol and sylvan and to the onset of deterioration.

The results for this catalyst, given in Table III, show sylvan to be the main product at both 250° and 300°. Even around 200° sylvan is still formed in high yield. A significant increase in the yield of furfuryl alcohol was obtained only by working at even lower temperatures, achieved by substituting furfuraldehyde (b. p. 162°) in the jacket for decahydronaphthalene as temperature-control liquid. In the higher temperature range, the onset of catalyst deterioration with the accompanying formation of furfuryl alcohol occurred only at temperatures near 350°. The results given by the copper chromite catalyst are included in Fig. 5.

(3) *The Effect of Alkalisng the Catalyst on the Ratio of Sylvan to Furfuryl Alcohol.*—At temperatures around 250° different preparations of alkali-precipitated copper catalysts gave sometimes

TABLE III.

Examination of copper chromite catalyst.*

| Expt. No. | Liquid space velocity (hr. ⁻¹). | Temp. | Molar ratio H ₂ /aldehyde. | Duration of expt. (hrs.). | Pass conv. (%) | Yield, %. | | Remarks. |
|-----------|---|-------|---------------------------------------|---------------------------|----------------|-----------|-------------------|-----------------------------------|
| | | | | | | Sylvan. | Furfuryl alcohol. | |
| S.272 | 0.19 | 178° | 5.8 | 4.75 | 97 | 58 | 33 | Furfuraldehyde as control liquid. |
| S.267 | 0.22 | 217 | 4.8 | 5.5 | 92.7 | 85 | 7 | Decahydronaphthalene as control. |
| S.264 | 0.13 | 250 | 7.8 | 5.5 | 99 | 87 | 7 | |
| S.276 | 0.13 | 301 | 6.2 | 4.5 | 98 | 87 | 5 | |
| S.277 | 0.17 | 346 | 4.6 | 5.5 | 48 | 55 | 30 | |

* Jacketed tube apparatus used in first two experiments, and standard apparatus in last three.

FIG. 6.

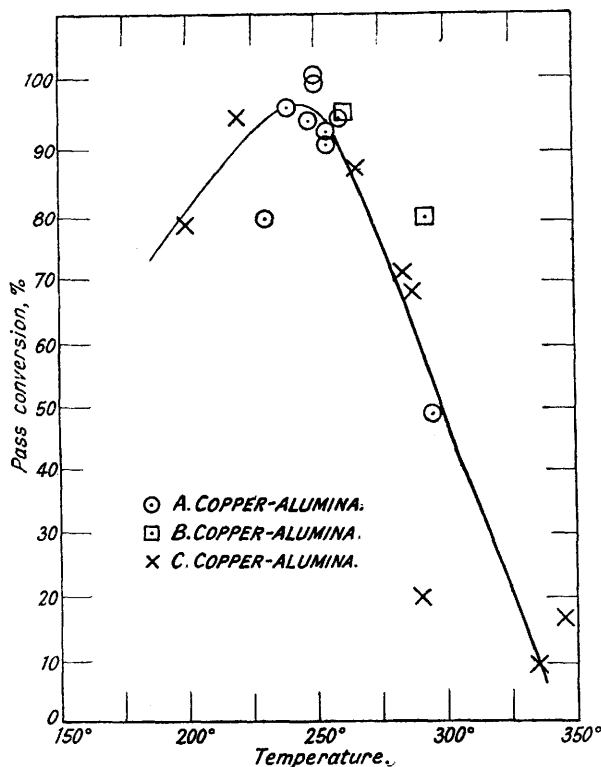

The variation of pass conversion with temperature.

furfuryl alcohol and sometimes sylvan as the main product. It was considered that this might arise from a variation in the extent of washing of the precipitate, an appreciable amount of alkali being left in the final catalyst in some cases. To test this view, alkali additions were made to a 55% copper alloy catalyst. The results given in Table IV show the presence of alkali markedly to affect the course of the hydrogenation reaction.

Simple immersion of the activated alloy in sodium carbonate solution gave on hydrogenation a mixture of sylvan and furfuryl alcohol, and an almost complete change in the course of the action was achieved only by immersion under reduced pressure, to remove occluded gases. As the amount of alkali added under these conditions is not readily assessed, the A type Cu-Al₂O₃ was modified by successively increasing additions of sodium carbonate. This was accomplished by adding an alkaline solution of the requisite concentration to the pellets of volume such that complete absorption occurred, drying them, and then charging them into the catalyst tube. In this way catalysts containing 0.5, 2.5, 4, and 5% of Na₂CO₃ were prepared and examined at space velocities of about 0.2 hr.⁻¹ and a temperature of about 250°. The results obtained

TABLE IV.

*Alkali addition to a copper alloy catalyst.**

| Expt. No. | Liquid space velocity (hr. ⁻¹). | Temp. | Molar ratio H ₂ /aldehyde. | Duration of expt. (hrs.). | Pass conv. (%). | Yield (%). | | Alkalisiation procedure. |
|-----------|---|-------|---------------------------------------|---------------------------|-----------------|------------|-------------------|--|
| | | | | | | Sylvan. | Furfuryl alcohol. | |
| S.185 | 0.16 | 253° | 7.0 | 6.5 | 98.2 | 88 | 2 | Catalyst only slightly water washed after caustic extraction. |
| S.186 | 0.20 | 254 | 5.8 | 6.5 | 96 | 32 | 58 | Catalyst immersed in 5% aqueous Na ₂ CO ₃ for 72 hours at room temp. |
| S.195 | 0.19 | 257 | 4.0 | 2.5 | 89 | 12 | 70 | Catalyst immersed in boiling 5% Na ₂ CO ₃ under reduced pressure. |

* Standard type apparatus throughout.

are shown graphically in Fig. 7. Successive additions of alkali change the product from one consisting almost solely of sylvan, to a mixture of sylvan and furfuryl alcohol. At the higher

FIG. 7.

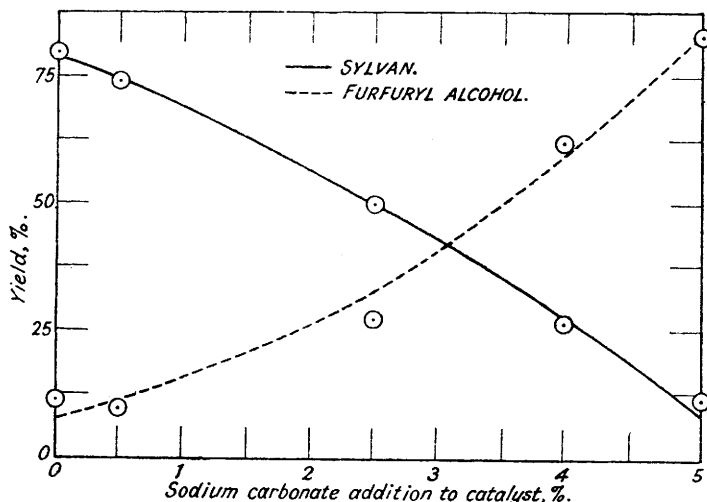

The effect of alkalisating the catalyst on the yields of sylvan and furfuryl alcohol.

alkali additions the alcohol is practically the sole product. That the formation of furfuryl alcohol in this way is due to a high degree of catalyst selectivity was shown by the passage of the alcohol over the catalyst. Sylvan was present in the product to the extent of only 4.8%.

As with temperature variations, the copper chromite catalyst was much less sensitive to alkali addition than the alloy and copper-alumina type catalysts (see Table V).

TABLE V.

*Alkali addition to a copper chromite catalyst.**

| Expt. No. | Liquid space velocity (hr. ⁻¹). | Temp. | Molar ratio H ₂ /aldehyde. | Duration of expt. (hr.). | Pass conv. (%). | Yield (%). | | Alkalisiation. |
|-----------|---|-------|---------------------------------------|--------------------------|-----------------|------------|-------------------|--|
| | | | | | | Sylvan. | Furfuryl alcohol. | |
| S.259 | 0.16 | 242° | 6.9 | 4.75 | 98 | 79 | 7 | 5% Na ₂ CO ₃ added to catalyst before pelleting. |
| S.261 | 0.16 | 250 | 7.0 | 5.5 | 98 | 78 | 5 | 5% Na ₂ CO ₃ added by impregnation of pellets. |
| S.262 | 0.16 | 295 | 6.7 | 6.0 | 99 | 88 | 3 | |
| S.263 | 0.15 | 337 | 6.9 | 5.0 | 61.5 | 38 | 45 | |
| S.279 | 0.18 | 252 | 6.5 | 6.0 | 99 | 66 | 23 | 20% Na ₂ CO ₃ |
| S.280 | 0.19 | 255 | 5.8 | 6.0 | 98 | 47 | 44 | 40% Na ₂ CO ₃ . |

* Standard type apparatus.

The addition of 20% sodium carbonate gave some furfuryl alcohol in addition to sylvan. A striking transformation occurred during the experiment (S.280) in which the alkali content was increased to 40%. At the end of half the time projected for the experiment, during which sylvan was formed in excellent yield, a sudden change occurred and a homogeneous product was obtained containing 88.5% of furfuryl alcohol and 4.5% of furfuraldehyde. There is evidently a conditioning period for such a catalyst.

(4) *The Effect of the Presence of Carbon Monoxide in the Hydrogen on the Ratio of Sylvan to Furfuryl Alcohol.*—It was found that the presence of 7.2% of carbon monoxide in the reacting hydrogen left unchanged the formation of sylvan in high yield with a copper alloy catalyst at 250° and of furfuryl alcohol with an alkalis A type copper-alumina catalyst at 257°. These results are to be considered with the known strong adsorption of carbon monoxide on copper (Pease, *J. Amer. Chem. Soc.*, 1923, **45**, 2296) and its prevention at super-atmospheric pressure of the hydrogenation of aldehydes to alcohols in the Roelen reaction (U.S.P. 2,327,066). We conclude that under appropriate conditions both furfuraldehyde and furfuryl alcohol are strongly adsorbed on the catalyst surface.

(5) *Furfuryl Alcohol as Intermediate in the Formation of Sylvan.*—To show that furfuryl alcohol is an intermediate in the formation of sylvan it is necessary to work at incomplete conversion. The previous experiments show the alcohol to be formed in significant amount where conversion is incomplete owing either to a fall in catalyst activity with low operating temperature or to the incidence of catalyst deterioration at higher temperatures. Incomplete conversion may be achieved at the optimum temperature for the formation of sylvan either by using less than the stoichiometric amount of hydrogen or by working at high space velocities. To investigate the former, a copper alloy catalyst was operated at 250° using hydrogen to furfuraldehyde molar ratios of 1.3 and 0.93 (Expt. Nos. S.273 and S.269). The pass conversions were 78% and 32%, respectively. While for the former the sylvan : furfuryl alcohol ratio was 2 : 1, equal amounts of each were formed at the lower conversion.

A pass conversion of 87% was obtained at 258° by working the copper alloy catalyst at the high space velocity of 1.15 hr.⁻¹ (Expt. No. S.281). Under these conditions furfuryl alcohol constituted 26% of the product. This result is similar to that obtained by working with less than the stoichiometric amount of hydrogen (Expt. No. S.273).

The formation of furfuryl alcohol depends on the pass conversion in the manner to be expected of an intermediate product. Furthermore, the passage of the alcohol over the alloy catalyst gave sylvan in 86% yield (S.278).

(6) *Comparison of Furfuraldehyde with Acetone in Ease of Hydrogenolysis.*—Adkins recognises that carbonyl and hydroxymethyl groups are readily reducible to methylene and methyl groups only when attached to an aromatic nucleus (Gilman, "Organic Chemistry," 2nd Edition, I, 804, 820). This conclusion was based, in the main, on work carried out in the liquid phase at super-atmospheric pressure. That it also holds under the experimental conditions used in this work was demonstrated with acetone. Two experiments (S.164 and S.172) in which hydrogen and acetone were passed over a copper alloy catalyst at 249° and 246° gave liquid products which constituted 93.6 and 100% by weight of the acetone fed. *iso*Propanol and acetone dehydration products were present in the liquids. Evidently the extent of hydrogenolysis of acetone to propane is small.

(7) *Analysis of the Products of Hydrogenation of Furfuraldehyde.*—Sylvan and furfuryl alcohol, prepared in the course of this work, were redistilled to give samples for analysis (see

| Property. | Material. | |
|-----------------------------------|-----------|-------------------|
| | Sylvan. | Furfuryl alcohol. |
| d_4^{20} | 0.9168 | 1.129 |
| n_D^{20} | 1.4340 | 1.4846 |
| B. p. | 63—64° | — |
| H ₂ O content, % | 0.1 | 0.43 |

Table). The unsaturation of the alcohol was measured with the pyridine sulphate-bromine reagent (Found : 304 g. bromine/100 g. Calc. for C₅H₆O₂ : 325 g.).

Small amounts of pentanone-2 formed in some of the experiments were bulked together. The once-distilled material had d_4^{20} 0.809; n_D^{20} 1.393. It reacted with hydroxylamine hydrochloride under pressure (Found : CO, 30.0. Calc. for C₅H₁₀O : CO, 32.5%) (Smith and Bryant, *J. Amer. Chem. Soc.*, 1935, **57**, 57).

(8) *General Discussion of Results.*—An interpretation of the results obtained in this work must account for the following facts : (a) The ease with which the carbonyl group in furfur-

aldehyde may be reduced to the methylene group. (b) The promotion of the formation of sylvan by chromium oxides and its suppression by the presence of alkali. (c) The probable formation of furfuryl alcohol as intermediate in the formation of sylvan. (d) The formation of furfuryl alcohol in the region of 200° and of sylvan at 250°. (e) The decline in catalyst activity when it is operated at temperatures of 300° or higher.

Observations related to some of those given above have been mentioned in the literature. Reduction of the carbonyl and the nitro-group by chemical means gives products whose nature depends on the acidity or alkalinity of the medium. Acid conditions result in complete removal of oxygen to give methylene and amino-groups. Reduction is less complete under alkaline conditions (Hickinbottom, "Reactions of Organic Compounds," Chaps. IV and VIII), thus qualitatively resembling item (b) above.

In the catalytic field the use of alkalis catalysts has received frequent mention in reactions involving the hydroxyl and the amino-group. Where an alcohol is a product or reactant the former group may be removed by a process of dehydration (3) or hydrogenolysis (4):

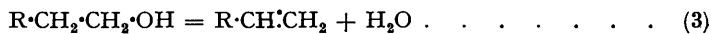

The dehydrogenation of alcohols to aldehydes and ketones is accompanied by little olefin formation if alkalis catalysts are used (B.P.P. 313,093, 318,124; U.S.P.P. 1,895,528, 1,984,884). Conversely the yield of alcohol formed by hydrogenation of aldehydes or ketones is not decreased by dehydration if alkali is present (F.P. 671,705; U.S.P. 1,895,515). In addition to suppressing the dehydration of alcohols, addition of alkali can increase the rate of hydrogenation of aldehydes and ketones to alcohols (Delépine and Horeau, *Compt. rend.*, 1935, 201, 1301; Reasenberg, Lieber, and Smith, *J. Amer. Chem. Soc.*, 1939, 61, 384) and of phenols to cyclohexanols (Armstrong and Hilditch, *Proc. Roy. Soc.*, 1922, 102, A, 21; McLaren, "Microfilm Abstracts," University Microfilms, Ann Arbor, 1944, V, No. 2, 39). The hydrogenation of furfuraldehyde in the liquid phase at super-atmospheric pressure is of interest as the presence of alkali causes the reaction to go smoothly in stepwise fashion through furfuryl alcohol to tetrahydrofurfuryl alcohol (U.S.P.P. 1,906,873, 2,082,025; and unpublished work). In the absence of alkali the hydrogenation rate is slow and the by-product formation large.

The addition of alkali to the chromite catalyst used in the hydrogenation of carbon monoxide improves the yield of alcohols higher than methanol (Morgan, Hardy, and Proctor, *J. Soc. Chem. Ind.*, 1932, 51, 1τ).

That the loss of a hydroxyl group by the mechanism of equation (4) may also be suppressed by the presence of alkali has been shown by Griffith ("Contact Catalysis," Oxford Univ. Press, 1936, 69) in the case of phenol.

The apparently unrelated observations by Wilson (*J.*, 1945, 55, 61) that the copper chromite catalyst which hydrogenated furfuraldehyde to sylvan in good yield also catalysed the dehydration of tetrahydrofurfuryl alcohol to dihydropyran do, in fact, show the similarity of the two reactions depicted by equations (3) and (4). In demonstrating this similarity we should compare the activity of the catalyst for the dehydration of furfuryl alcohol with its ability to hydrogenolyse this alcohol to sylvan. For simplicity we have, however, examined the behaviour of the catalysts used in this work with isopropanol. The extent of its dehydration to propylene ($\Delta H = 16,200$ cal.) would be expected to be large with those catalysts that favour sylvan formation. The formation of acetone by dehydrogenation ($\Delta H = 13,700$ cal.) is to be expected with those catalysts that favour furfuryl alcohol formation. The results of these experiments carried out at 350° and a space velocity of 10 hr.⁻¹ are given in Table VI. Only 10 c.c. of catalyst were used to give approximately isothermal conditions, and the high space velocity was chosen so as to give incomplete conversion. These conditions tend to minimise effects due to the different activation energies of the dehydration and dehydrogenation reactions. The amounts of acetone and propylene formed are expressed by pass yield, *i.e.*, pass conversion \times yield.

The effect of alkaalisation in suppressing the dehydration of isopropanol is evident from the results given in Table VI. The alkalis catalyst, however, shows exceptional behaviour in that it suppresses the dehydration of isopropanol while catalysing the hydrogenolysis of furfuraldehyde. This observation is probably connected with the relative ease of dehydration of isopropanol and furfuryl alcohol, the former occurring the less readily (cf. Storch, *J. Amer. Chem. Soc.*, 1935, 57, 1395).

The use of alkali in the hydrogenation of compounds containing the amino-group includes the hydrogenation of nitrogen to ammonia (Larson and Brooks, *Ind. Eng. Chem.*, 1926, 18,

TABLE VI.

The catalysed dehydration and dehydrogenation of isopropanol.

| Exp. No. | Catalyst. | Product (pass yield, %). | |
|----------|--|--------------------------|------------|
| | | Acetone. | Propylene. |
| D.3 | A copper-alumina | 65.5 | 20.1 |
| D.9 | do. + 5% Na ₂ CO ₃ | 11.5 | 1.6 |
| D.11 | Copper chromite | 39.8 | 18.8 |
| D.5 | do. + 5% Na ₂ CO ₃ | 55.2 | 1.8 |
| D.1 | Cu-Al alloy (20% Al removed) | 65.5 | 4.1 |
| D.7 | do. + Na ₂ CO ₃ | 29.0 | 1.7 |

1305; Almquist and Crittenden, *ibid.*, p. 1307; D.R.-P. 249,447; U.S.P. 1,667,322) and of aromatic amines to the alicyclic derivatives (Winans, *Ind. Eng. Chem.*, 1940, **32**, 1215; U.S.P. 1,927,130).

The rate of hydrogenation of nitrobenzene in the liquid phase is decreased by the presence of alkali (Reasenberg, Lieber, and Smith, *J. Amer. Chem. Soc.*, 1939, **61**, 384).

With regard to (b), Baljassny (*Ukrain. Akad. Nauk. Zapiski Inst. Khem.*, 1935, **2**, 175) has found that, whereas acetophenone may be hydrogenated with a copper catalyst at 250°, the reaction stops completely at 284—289°.

The intermediate formation of furfuryl alcohol, (c), is not in agreement with the theory advanced by Farkas and Farkas (*J. Amer. Chem. Soc.*, 1939, **61**, 1336) as a result of their work on the hydrogenation of acetone with a palladium catalyst at room temperature.

(9) *A Theory of Catalytic Action.*—In formulating a theory of catalysis to account for the observations in this work we have made the following assumptions. (a) Heterogeneous reactions frequently involve the formation, as intermediates, of radicals or radical ions. (b) The radicals and radical ions possess the relative stability accorded them in homogeneous reactions. (c) The behaviour of the radicals will be the same in heterogeneous as in homogeneous reactions.

It seems unnecessary under normal catalytic conditions to postulate the existence of radicals having an independent existence in the addition of hydrogen to a multiple bond (Vavon, *Bull. Soc. chim.*, 1936, **3**, 1021; Farkas, *Trans. Faraday Soc.*, 1939, **35**, 906). It is assumed that independent radicals exist where the addition or removal of a univalent atom or group is concerned as, *e.g.*, where the addition of a hydrogen atom is required to complete the hydrogenation (cf. Ingold and Burton, *J.*, 1929, 2022). Whether the fragment exists as a free radical (R), carbonium ion (R⁺), or carbanion (R⁻), as shown in equations (5) and (6), will depend on the relative stability of these radicals as well as the ability of the catalyst represented by M to provide or remove electrons:



In this way we regard the catalyst as an electron donor or acceptor, *i.e.*, as basic or acidic in the Lewis sense. Any additions to the catalyst which decrease the availability of electrons, *i.e.*, its acidity, will make the existence of a carbonium ion less probable. Furthermore, an increase in temperature will aid the removal of electrons from the catalyst and tend to lead to the formation of carbanions.

On this basis a series of reactions can be set up to represent the hydrogenation of furfuraldehyde to sylvan and furfuryl alcohol. In the following equations we have used the symbol ψ to represent the furyl radical in which the substituent is in the 2-position, and M to represent the catalyst.

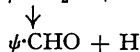
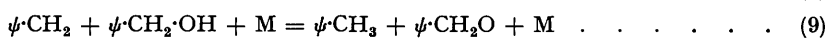
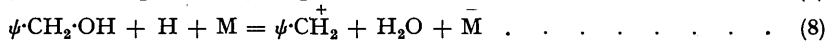
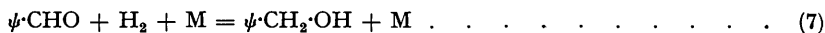

The primary step comprises the formation of furfuryl alcohol by simple addition of hydrogen as in equation (7). Reaction (8), which involves the loss of a hydroxyl group with the formation of a carbonium ion, we regard as an essential step in both dehydration and hydrogenolysis reactions (Hammett, "Physical Organic Chemistry," 1940, Chap. X). In the alkanol series this ion will be relatively unstable, and a breakdown to an olefin with loss of a hydrogen atom will readily occur. The furfuryl radical, however, will be stabilised by resonance and consequently

have a relatively long residence time on the catalyst, during which it will acquire a hydrogen atom to form sylvan.

As is to be expected, hydrogenolysis of tetrahydrofurfuryl alcohol which is much less stabilised by resonance does not, in fact, give tetrahydrosylvan (unpublished work). It seems probable that an appreciable proportion of the hydrogen required for this step is provided by adsorbed furfuryl alcohol molecules as represented by equation (9). A deficiency of hydrogen on a catalyst surface is probable in hydrogenations at atmospheric pressure, more especially where the reaction is carried out in the liquid phase.

The hydrogen atoms of adsorbed alcohol molecules are known to exchange readily (Farkas, *Trans. Faraday Soc.*, 1937, **33**, 678). The hydrogen-transfer reaction represented by equation (9) may most simply be regarded as involving a free furfuryl radical formed by the reverse of reaction (5) (Waters, *J.*, 1946, 409; Hey, *Nature*, 1945, **156**, 36). That the dehydration of furfuryl alcohol does, in fact, give sylvan and furfuraldehyde by a disproportionation reaction similar to (9) has been shown by Paul (*Bull. Soc. chim.*, 1935, **2**, 2220):

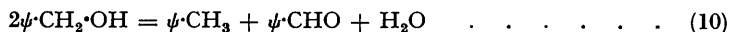

Reaction (8) involving an electron transfer is regarded as a rate-determining one. The presence of chromium oxides will confer greater oxidising power or electron-acceptor characteristics to the catalyst and consequently make reaction (8) more likely. Conversely, alkali will increase the electron-donor characteristics of the catalyst and reduce the rate of the carbonium-ion formation. In these circumstances the alcohol formed will tend to be desorbed from the catalyst. The increased rate at which carbonyl compounds are hydrogenated by alkali addition in the liquid phase may be due to the increased catalyst area made available in this way.

The decreased effectiveness of alkali addition with copper chromite catalysts may be accounted for by the counterbalancing action of the chromium oxides. Conversely, we would expect the effects produced by alkalis on a catalyst to be minimised by addition of chromium oxides. This prediction has, in fact, been demonstrated experimentally for the dehydration of ethanol with an alumina catalyst at 350°. The reduction in pass conversion arising from the presence of 2% of sodium carbonate on the alumina is practically eliminated by the subsequent addition of 2% of chromium sesquioxide.

We account for the change in the main product from furfuryl alcohol to sylvan with rise in temperature by the rate-determining nature of reaction (8). The fall in activity observed by operating at even higher temperatures is due to the accumulation on the catalyst surface of non-volatile material of high molecular weight, presumably formed by the interaction of free radicals or ions with the furyl nucleus (Hammett, *op. cit.*, pp. 307, 373; Hey, *loc. cit.*). Such condensation reactions are particularly evident where stabilisation of the intermediates by resonance is possible. Such an explanation may suitably account for the deterioration in catalyst activity observed by Baljassny during his hydrogenation of acetophenone.

It is hoped to publish an account of the implications of this theory to a wide variety of catalytic reactions.

Some of the work described in this paper has formed the subject of patent applications.

The authors wish to express their appreciation to Dr. K. B. Hutton, Miss M. Allan, Dr. S. Beaumont, Dr. R. R. Coats, and especially Dr. D. G. Jones for their part in the early stages of this work. The preparation and examination of some of the catalysts used was carried out by Dr. P. W. Reynolds, Mr. D. M. Grudgings, and Mr. J. A. Mackenzie. Many helpful discussions on theories of catalytic action were held with Mr. D. A. Dowden.

IMPERIAL CHEMICAL INDUSTRIES LTD., BILLINGHAM DIVISION,
RESEARCH DEPARTMENT, BILLINGHAM, CO. DURHAM.

[Received, November 11th, 1946.]