

**672.** *The Separation of Isotopes by Fractional Distillation. Part I. Fractionating Columns for the Enrichment of the Heavy Isotopes of Oxygen in Water.*

By I. DOSTROVSKY, D. R. LLEWELLYN, and B. H. VROMEN.

The construction and operation of a number of fractionating columns designed for the enrichment of the heavy isotope of oxygen in water are described. One is capable of producing, per day, 200 ml. of 0.6%  $\text{H}_2^{18}\text{O}$ , or 50 ml. of 1.7%  $\text{H}_2^{18}\text{O}$ , or 20 ml. of 3.2%  $\text{H}_2^{18}\text{O}$ . Another, operating as a second stage, has produced 10 ml. of 12%  $\text{H}_2^{18}\text{O}$  per week.

FRACTIONAL distillation was one of the earliest methods applied to the enrichment of isotopic mixtures, though with only limited success. However, recent advances in both the theory and the technique of fractionation seemed to justify re-examination of the method. Separation of the stable isotopes of oxygen is of particular interest because oxygen is one of the few light elements without a long-lived radioactive isotope suitable for tracer studies.

Normal oxygen consists of a mixture of  $^{16}\text{O}$ ,  $^{17}\text{O}$ , and  $^{18}\text{O}$  in the approximate proportions 2500 : 1 : 5, from which it appears that  $^{18}\text{O}$  is more easily separated from  $^{16}\text{O}$ , because of its greater mass and abundance, than is  $^{17}\text{O}$ . Most standard methods have been

employed to investigate their separation, such as electrolysis, chemical exchange, gaseous diffusion, and fractional distillation. Of these, thermal diffusion has been the most effective, but although 99%  $^{18}\text{O}$  was obtained by this method, the yield was only 250 c.c. of gaseous oxygen after  $1\frac{1}{2}$  years (Clusius, Dickel, and Becker, *Naturwiss.*, 1943, **31**, 210). This method is not very suitable for producing large quantities of water with sufficient  $^{18}\text{O}$  content for chemical and biological tracer work.

The enrichment of  $^{18}\text{O}$  and deuterium in water by fractional distillation has been achieved by a number of investigators. Huffman and Urey (*Ind. Eng. Chem.*, 1937, **29**, 531) describe the detailed working of a fractionating column, consisting of alternate stationary and rotating cones, with which they were able to produce 200 c.c. of water containing 0.85 atom-%  $^{18}\text{O}$ ; Watson (see *J.*, 1937, 1969) built a still which produced water with an increased density of 700 parts per million, but only part of this increase was due to  $^{18}\text{O}$ ; Brodski, Alexandrovitch, and Skarra (*Acta Physicochem. U.R.S.S.*, 1937, **7**, 469) report the use of a 200-cm. column; Winter, Carlton, and Briscoe (*J.*, 1940, 131) produced water 200 parts per million heavy in  $^{18}\text{O}$ , and Thode, Smith, and Walkling (*Canad. J. Res.*, 1944, **22**, C, 127), using three columns in cascade, produced 150 c.c. of water enriched 6.5-fold in  $^{18}\text{O}$  (1.3%), in 120 days.

In this paper we describe the construction and operation of a number of improved fractionating columns designed for the enrichment of the heavy isotopes of oxygen in water. These columns have been in operation for several years and some of them are capable of producing, per day, 200 ml. of 0.6%  $\text{H}_2^{18}\text{O}$  or 50 ml. of 1.7%  $\text{H}_2^{18}\text{O}$  or 20 ml. of 3.2%  $\text{H}_2^{18}\text{O}$ . Even when the times necessary to reach these enrichments (see below) are taken into account it will be seen that this represents a considerable improvement over earlier columns. Several of these columns have been operating with efficiencies equivalent to between 400 and 600 theoretical plates.

In the separation of liquids of very similar boiling point, such as isotopic mixtures, by fractionation or chemical exchange, several problems arise which are not met in the more usual industrial and laboratory operations. These are derived from the small value of the unit process separation factor  $\alpha$ , and in most practical cases from the very small concentration of the desired isotopic species in the starting material. The small value of  $\alpha$  leads to the use of columns of very high efficiency which also means columns of large physical dimensions. This in turn creates problems of length of time required to reach concentrations suitable for production, a point which is hardly considered in industrial columns.

The theory of fractionation, as applied to the separation of isotopes, has been developed by Cohen (*J. Chem. Phys.*, 1940, **8**, 588) and by Dostrovsky, Gillis, and Llewellyn (*Bull. Res. Council, Israel*, 1951, **1**, 120; Farkas Memorial Volume, in the press) and has permitted the rational design and operation of columns for this purpose. The present paper is devoted mainly to those features of design and construction which lead to efficient and dependable apparatus; for not the least exacting requirement of any apparatus for isotopic enrichment is long-term dependability and steadiness of operation.

Recent research has resulted in the development of a number of packing materials possessing a high efficiency with a large through-put. One such is Dixon's wire-gauze packing (*J. Soc. Chem. Ind.*, 1949, **68**, 88). Its suitability for use in columns for isotopic work was demonstrated by Dostrovsky, Hughes, and Llewellyn (*Nature*, 1946, **158**, 164; 1948, **161**, 858). It shows a linear relation between the height of equivalent theoretical plates and flow, as required by the theory (Dostrovsky, Gillis, and Llewellyn, *op. cit.*), the height equivalent to a theoretical plate (H.E.T.P.) being  $0.04 \frac{\text{cm. per plate}}{\text{l. per day}}$  for a  $3\frac{1}{2}$ -in. column. Thus for a flow of 25 l. per day the H.E.T.P. of such a column is 1 cm.

Basically three modes of operation are possible and all have been used. In the first (mode 1), the continuous process, the feed stock (usually normal distilled water) is introduced at a constant rate at the top of the column and passes through the packed section to the boiler. Apart from the relatively small quantity of water withdrawn from the boiler as product, all the water is returned to the foot of the column as steam. The steam passes up the packed section to the condensers and the condensate flows to a reservoir and is

discarded (see Fig. 1). The second mode of operation (mode 2) is a batch process. The same arrangement is used as in the continuous process but with a relatively large boiler and with no production taken until the contents of the boiler reach the desired concentration. At this point most of the boiler content is taken as production. The third mode of operation (mode 3), also a batch process, is shown schematically in Fig. 2. Steam from the boiler, after passing through the packed section, is condensed into the reservoir where it displaces an equal volume of water into the top of the column. It follows from the general theory (Dostrovsky, Gillis, and Llewellyn, *loc. cit.*) that the total time necessary to produce a given amount of enriched water is much the same whether the first or the second mode is adopted. The first mode of operation has, however, an obvious advantage which may be of decisive importance in certain circumstances, namely, that, should a breakdown occur in the operation, the material already produced is at least saved. The third mode of operation enjoys the great advantage of simplicity, as no direct flow control is needed. The flow is entirely determined by the heat input to the boiler. Another advantage is that the total amount of water in the system is fixed and so this method is suitable when starting from enriched material. A disadvantage of this mode is that for a

FIG. 1.

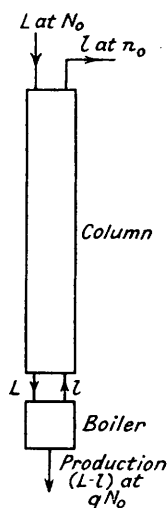

FIG. 2.

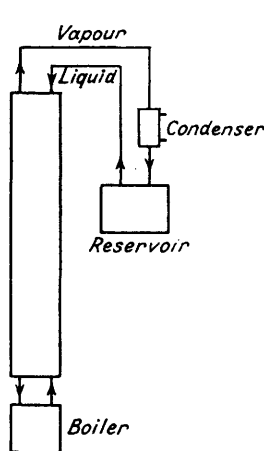
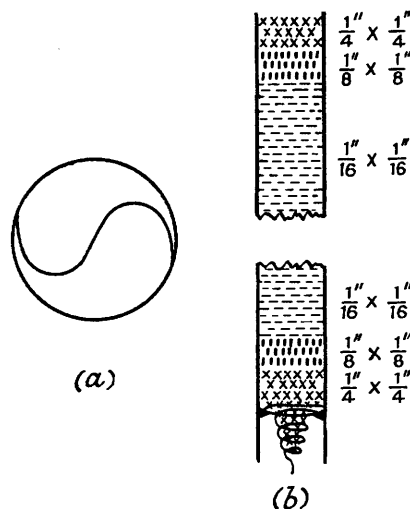

FIG. 3.



given column the enrichment is always less than in the other methods of operation (cf. Dostrovsky, Gillis, and Llewellyn, *loc. cit.*). This mode can be rendered continuous by removing only a small fraction of the boiler water at a time, and adding an equal volume slowly to the reservoir (mode 3a).

The design of the boiler depends on the type of operation required. Those intended for batch operation have a relatively large working volume and are of conventional laboratory design, consisting of a flask fitted with internal heater or external heating mantle.

Boilers intended for continuous production have the minimum working volume consistent with the desired boil-up rate, an essential requirement which follows from consideration of the rate of enrichment. These are most conveniently heated by steam, and a boiler with a boil-up rate of 10 l. of water per hour with a working volume of less than 100 c.c. was used. In electrically heated boilers the heat input is balanced against the inflow of water by a device which maintains a constant water level.

Columns about 1" in diameter were constructed of Pyrex and thermally insulated by vacuum-jackets (Dostrovsky and Jacobs, *Chem. and Ind.*, 1947, 627), while the larger ones, of 3" diameter, were fabricated from copper and insulated with two layers of fibre-glass pipe lagging with compensating heaters between the layers. The condensers were all of the usual design, consisting simply of two water-cooled spirals connected in series. Vapour from the column condensing on these spirals could be led to the distillate reservoir or

returned to the top of the column. The columns were operated under reduced pressure in order to take advantage of the correspondingly higher values of  $\alpha$ .

In designing the stills it was borne in mind that it would be necessary for them to operate for long periods (many months) without continuous attention, and it was necessary to safeguard the equipment from damage and the enriched water from loss consequent upon water or electricity failure or breakdown in parts of the apparatus. Steam-heated stills were designed to be unaffected by failures of a few hours' duration. The flow of feed stock was kept constant by means of an automatic flow controller described elsewhere (cf. Dostrovsky and Llewellyn, *J. Sci. Instr.*, 1948, **25**, 137). Failure of the flow of feed stock in these columns was made to operate magnetic valves which caused the stills to function under total reflux by returning the distillate to the top of the column.

Some results obtained are shown in the annexed Table.

Run	Mode	Mean pressure (mm.)	Flow (l./day)	Enrichment	Production
<i>Column C, 25 ft. high, 3½ in. diam.</i>					
i	1	259	51.7	3.22	150 c.c./day
ii	"	259	50.1	4.10	100 "
iii	"	271	37.9	8.26	30 "
iv	"	274	36.7	11.23	20 "
v	"	265	33.3	11.20	20 "
<i>Column A, 30 ft. high, 3 in. diam.</i>					
i	1	290	95.5	4.07	150 "
ii	"	290	92.5	4.52	115 "
iii	"	290	95.5	5.25	60 "
iv	"	290	92.5	5.98	30 "30
<i>Column B, 50 ft. high, 3 in. diam.</i>					
i	1	290	57.5	3.08	200 "
ii	"	290	57.5	3.74	150 "
iii	"	290	57.5	5.05	100 "
iv	"	290	57.5	8.52	50 "
v	"	290	57.5	16.0	20 "
vi	2	290	84.0	3.2	2 l./day †
				2.3	3 "
				1.8	3 "
<i>Column D, 12 ft. high, ¾ in. diam.</i>					
i	3	200	560 ‡	1.93	500 c.c. in 24 wks.
<i>Column E, 25 ft. high, 1 in. diam.</i>					
i	3a*	160	300 ‡	60	10 c.c./wk.

\* Feedstock, 1.7% H<sub>2</sub><sup>18</sup>O. In other cases, normal water.

‡ C.c./hour.

† After one run of 8 weeks. The product includes some drainage from the column.

The columns were designed for the production of H<sub>2</sub><sup>18</sup>O and the conditions with respect to HDO production were far from optimal. Under conditions C(iv) a deuterium enrichment of  $70 \pm 5$  times the normal value (HDO  $\sim 2.5\%$ ) was obtained and under conditions C(v) an enrichment of  $78 \pm 4$  was obtained.

Some of the results in this Table indicate non-optimal operation of the column. These are runs which were made to test theoretical formulæ and to determine various parameters. A further discussion of these and related questions will appear in subsequent papers.

#### EXPERIMENTAL

*Description of Columns.*—The packing in all the columns described in this paper was made from 100-mesh phosphor-bronze gauze in the form of cylinders  $\frac{1}{16} \times \frac{1}{16}$ " divided down the middle by an S-shaped partition. Fig. 3a shows a cross-section of one of these cylinders. At each end of the packed section there were layers of larger packing,  $\frac{1}{8} \times \frac{1}{8}$  and  $\frac{1}{4} \times \frac{1}{4}$ " (see Fig. 3b, which also shows the method of support of this packing in the column).

The columns themselves and all their connections were made of copper, except for some of the small-diameter columns which were of glass.

As with other types of packing, the material used in our columns functioned most efficiently if thoroughly wetted at the beginning of the operation. In columns designed for continuous operation this was achieved by initially maintaining a rate of flow greater than the rate of boiling, until the flooding was complete. The flow was then reduced until, after deflooding,

a correct balance was restored. In batch columns the flooding was effected by slowly introducing excess of water directly into the boiler. The columns were then deflooded by gradual removal of the surplus water.

(a) *The 3" × 30' Electrically Operated Column.*—This was designed for the three modes of operation and is shown diagrammatically in Fig. 4. It has only been used, however, for continuous production.

The column was made from 3"-bore 16-gauge copper pipe and had a total length of 31 ft. A 30-ft. length of the column was filled with 100-mesh phosphor-bronze packing (2" at each end  $\frac{1}{4} \times \frac{1}{4}$ ", followed by 6" at each end  $\frac{1}{8} \times \frac{1}{8}$ ", and the remainder with  $\frac{1}{16} \times \frac{1}{16}$ "). The remaining length contained a reflux condenser (11) and the outlets of the feed (5) and flood (6) pipes, and was connected at the top to the main condensers (12 and 13) from which a pipe (23) led to a reservoir (14) situated on the level of the base of the column. The water supply to the reflux condenser (11) and to the main condensers (12 and 13) was controlled by separate valves

FIG. 4.

- 1, Mains water supply.
- 2, Distilled water supply.
- 3, Flowmeter.
- 4, Controlling head operated by servo-mechanism of recorder controller.
- 5, Feed pipe.
- 6, Flood pipe.
- 7, Column.
- 8, Boiler.
- 9, Outlet for product.
- 10, 1" Copper tube between boiler and column.
- 11, Reflux condenser.
- 12, 13, Main condensers.
- 14, Reservoir.
- 15, Waste distillate.
- 16, Boiler manometer.
- 17, Differential manometer.
- 18, Manostat.
- 19, Magnetic valve.
- 20, Pumping line.

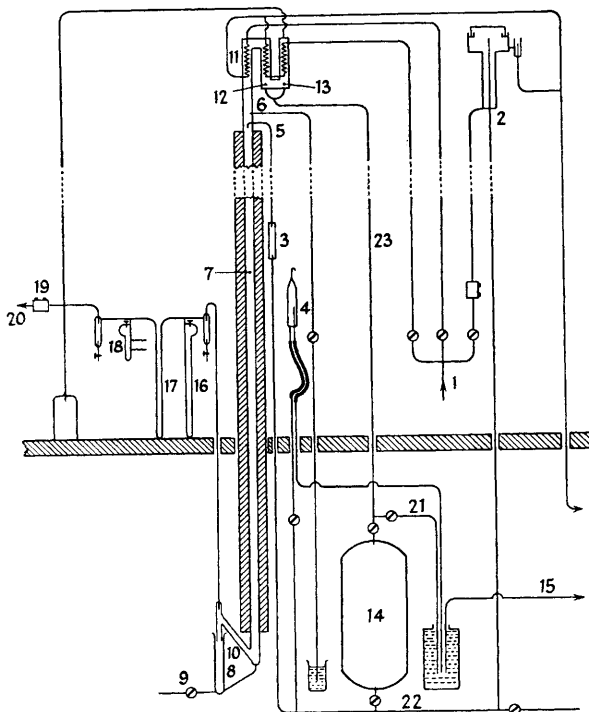

(1). From the reservoir (14) one pipe (21) led to waste, and another (22) connected with the feed pipe (5). Distilled water from the still (2) could be fed directly through a flowmeter (3) to the top of the column.

The flowmeter was of the thermal type, as described by Dostrovsky and Llewellyn (*loc. cit.*). A mechanical servo-mechanism kept the bridge balanced by varying the head of the water (4) flowing into the column. A commercial instrument was used for recording the flow.

Thermal insulation was provided by fibre-glass pipe lagging,  $2\frac{1}{4}$ " thick, built in two layers with an electric heater between them. The input to this heater was controlled so as to compensate for heat losses from the column. Thermocouples were provided throughout the length of the insulation to ensure the correct adjustment of the compensating heater.

Water flowing down the column was led through a glass tube to the bottom of the boiler (8) which was made of a  $2\frac{3}{4}$ "-diam. Pyrex tube, 24" long, containing four 1-kw tubular heaters of the type used in domestic fires. These were supported and electrically connected by two  $\frac{1}{2}$ " glass-sleeved copper rods passing through a rubber bung at the top of the boiler. The vapour was returned to the column through a 1" copper pipe (10), also passing through the bung. Samples of water could be removed from the boiler through a side tube and valve (9).

The boiler had a working volume of 200 ml. of water and it was essential to keep this volume

sensibly constant. This was achieved by incorporating a level-controlling device which consisted of a thermocouple, surrounded by a small low-voltage heater wound on a silica core and inserted in a silica tube of  $\frac{1}{4}$ " diameter, closed at one end and extending two-thirds of the way down the boiler. The temperature indicated by the thermocouple depends on its position relative to the level of the water. With the water slightly above the predetermined level the temperature recorded was about  $300^{\circ}$ ; with the water below this level the temperature rose sharply to  $400^{\circ}$ . The thermocouple was connected to a commercial pyrometer controller set at  $350^{\circ}$ , which below this temperature short-circuited a 2.5-ohm resistance in series with the main heater elements, whereas above this temperature the resistance was in the circuit. In this way the heat input was varied to maintain approximately constant water level. This arrangement compensated for changes in heat input due to line-voltage fluctuations and other causes, and also obviated the necessity for close matching of the constant feed rate with the boiler current. The boiler current was recorded on a 3-point recorder together with the current to the commercial still and the line voltage.

A connection was taken from the 1" copper pipe (10) to the manometer (16) and differential

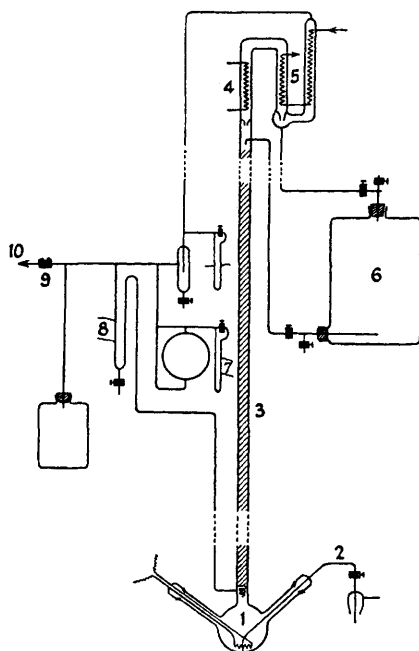

FIG. 5.

- 1, Boiler.
- 2, Outlet for product.
- 3, Column.
- 4, Reflux condenser.
- 5, Main condenser.
- 6, Reservoir.
- 7, Manostat.
- 8, Differential manometer.
- 9, Magnetic valve.
- 10, Pumping line.

manometer (17). The other side of this differential manometer was connected to the top of the condenser (13), to the manostat (18), and to the vacuum line (20). The manometers were of the usual glass U-tube design, and the manostat had two tungsten contacts in the closed arm. These contacts operated an electromagnetic valve situated in the vacuum line between the pump and the column. In this column no provision was made for dealing with breakdowns of electric power supply, but numerous safety devices were incorporated into the still which stopped the operation in the event of any failure of mains-water supply, boiler heating, or flow of feed stock, and suitable alarm signals were provided to indicate serious deviations from the desired running conditions.

(b) *The 3' × 50' Electrically Heated Still.*—This still was very similar to the 30-ft. still previously described. The flow-control system was self-contained and fed a constant flow of water to one end of a 40-ft. U-tube, the other end of which entered the column above the packing.

The boiler was all-metal and heated by three 1.5-kw. kettle-heaters. The capacity of this boiler was reduced by filling most of the free space with brass rod, and the level-sensitive element was designed to switch the top heater. Each heater had its own emergency cut-out and no other safety device on the boiler was necessary.

(c) *The 3½' × 25' Steam-heated Still.*—Like stills (A) and (B), this too was designed for con-

tinuous operation. The use of steam from a large-capacity boiler for heating both the still-boiler and the insulating jacket afforded some protection against extended power cuts. In addition, a small auxiliary generator was used to provide an emergency power supply for maintaining the flow and the various control and safety circuits.

The still-boiler was of tube type, with the steam outside the tubes, and made of copper. Its working volume varied from 30 to 50 ml. and was capable of boiling up to 10 l. of water per hour.

In other respects this column was closely similar to (a) and (b).

(d) *The  $\frac{3}{4}$ "  $\times$  12' Electrically Heated Still.*—This column (see Fig. 5) was designed for batch operation and was of glass. Thermal insulation was provided by sleeve-type vacuum-jackets containing three concentric aluminium reflectors (see Dostrovsky and Jacobs, *loc. cit.*) and a small compensating heater was wound directly on the column.

The boiler was made from a 750-ml. Pyrex flask fitted with two side arms, one carrying an 8-ohm nichrome-wire heater connected to a Variac transformer, and the other fitted with a syphon tube for withdrawal of samples. Vapour reaching the top could be condensed either by the reflux condenser (and returned directly to the column) or by the main condensers, and the condensate led into the reservoir from which an equal volume of water was displaced and fed into the top of the column. It is desirable to have a reservoir as large as possible compared to the contents of the boiler. Reservoirs with capacities of 1–20 l. have been used in accordance with the amount of material available. From the top of the main condenser a tube led to the manostat, manometer, and one side of the differential manometer, similar in design to

FIG. 6.

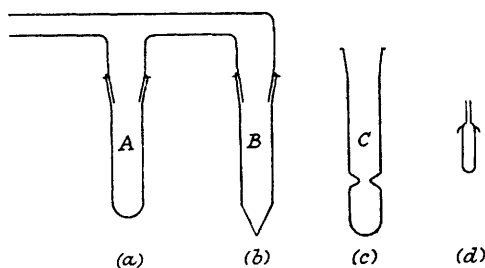

that used in the 3" column. The other side of the differential manometer was connected to the boiler.

The effects of mains-voltage fluctuations were minimised by a resistance in series with the boiler heater which was switched in and out of circuit by means of a hot-wire vacuum-switch actuated by contacts in the differential manometer. The arrangement was such that when the pressure difference decreased below the predetermined value, the extra resistance in the circuit was short-circuited, thereby increasing the boil-up rate until the pressure difference rose above the set value. In this way the average boil-up rate was maintained approximately constant.

The usual safety devices were incorporated. In addition a double-pole double-throw electronic relay was used as a change-over switch to connect the heater to a reserve battery in the event of mains failure.

(e) *The 1"  $\times$  25' Electrically Heated Still.*—This was similar to the  $\frac{3}{4}$ "  $\times$  12' still. The boiler was heated by an external mantle, which enabled the working volume to be reduced considerably, and the column was lagged with fibre-glass.

*Isotopic Analysis.*—Although all of our more recent isotopic analyses of water samples have been carried out mass-spectrometrically (cf. Dostrovsky and Klein, *Analyt. Chem.*, 1952, in the press; Cohn and Urey, *J. Amer. Chem. Soc.*, 1938, **60**, 679), earlier determinations were made by the pycnometric method to be described below. Because of the possible usefulness of this method where a mass spectrometer is not available and also because of the intrinsic interest of some of the techniques involved, a brief description is given.

The pycnometers used were made of Pyrex glass or silica and were of the shape shown in Fig. 6*d*, with a capacity of 2–3 ml. In order to fill and empty these pycnometers it was convenient to have several tubes of the forms shown in Fig. 6*a*, *b*, and *c*. These tubes would be connected to a high-vacuum line by placing cone and socket together dry and sealing them by running Apiezon wax W 80 around the rim.

## 3516 Separation of Isotopes by Fractional Distillation. Part I.

All tubes were normally kept completely immersed in chromic acid and before use were well washed with distilled water, thoroughly steamed internally with steam generated from potassium permanganate solution, and finally dried at the pump.

The pycnometer was cleaned externally after each measurement by holding it with tweezers in a stream of steam and was then inverted into a tube of shape *B* (cf. Fig. 6), attached to the high-vacuum line, and was then pumped dry. The vacuum was then broken, tube *A* (Fig. 6*a*) was removed and replaced by a similar tube containing the frozen sample of water. After a few minutes' pumping, the system was isolated from the pumps, the tube containing the pycnometer was surrounded by acetone-solid carbon dioxide, and the water sublimed from *A* to *B*. This process took 2–3 hours if the surface area of the ice was large and if a reasonable vacuum was attained, and trap *A* was kept de-iced by occasional immersion in ethylene glycol.

When distillation was complete, the system was pumped out for a few minutes, to remove most of residual gas, the freezing-bath was removed, and the ice allowed to melt. The vacuum was then broken, causing the water to flow into the pycnometer. A small bubble (less than 1 mm. in diameter) remained, due to residual gas. The pycnometer was then removed, inverted, and given a vigorous jerk to bring the bubble to the base of the capillary from where it was expelled

FIG. 7.

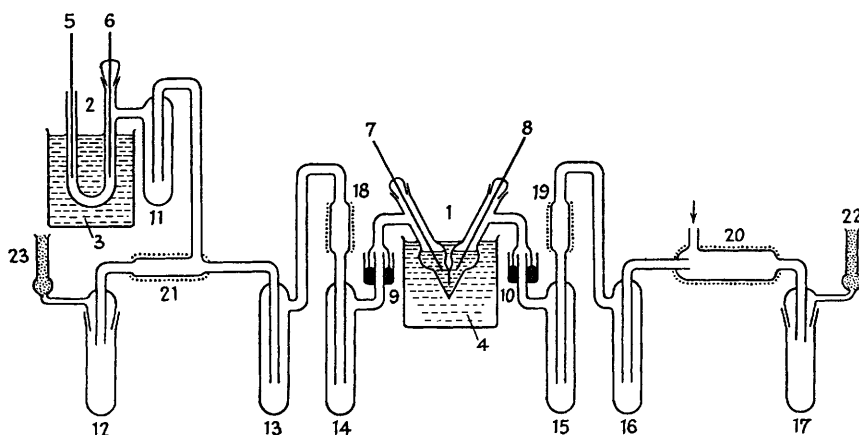

- |                           |  |
|---------------------------|--|
| 1, Cell for heavy water.  | 11–17, Liquid-air traps.               |
| 2, Cell for normal water. | 18, 19, Purification combustion tubes. |
| 3, 4, Cooling tanks.      | 20, 21, Main combustion tubes.         |
| 5–8, Nickel electrodes.   | 22, 23, Phosphoric oxide guard tubes.  |
| 9, 10, Mercury seals.     |  |

on immersion in a thermostat at 25°. After the pycnometer had been for 10 minutes in the thermostat, surplus water was removed from the top of the capillary by touching it with a filter paper, and after a further 5 minutes the pycnometer was wiped with three pieces of chamois leather and transferred to the micro-balance.

The thermostat was kept at constant temperature, within  $\pm 0.001^\circ$ , and a very rigorous schedule of time in the thermostat, sequence of wiping, and time in the balance before weighing was adhered to. With a pycnometer of 3-c.c. capacity results were reproducible within  $\pm 2$  p.p.m. The pycnometer was emptied after removal from the balance by inverting it, shaking it to displace the bubble at the base of the capillary, and then alternately pumping and breaking the vacuum while the pycnometer was inverted in tube *C*.

Determinations of two densities were taken on each sample, one being a total density as represented by the increased concentrations of  $^{18}\text{O}$  and *D*, and the other after normalisation by electrolysis. In each case the water was purified by a double distillation, the first after addition of potassium permanganate and a little sodium, and the second after addition of a little phosphoric oxide. Each distillation was carried out at a slow rate under atmospheric pressure in an all-glass apparatus and each distillation was taken almost to dryness. To determine the total density, a small piece of sodium was added to the sample and 3 ml. were transferred to a clean dry trap *A*. The outlet was closed by a B24 stopper and the water was frozen by immersion in a solid carbon dioxide-acetone bath while the trap was held almost horizontal and rapidly rotated.



The remainder of the sample was converted into about 6N-sodium hydroxide by further additions of small pieces of sodium (cf. Dostrovsky and Llewellyn, *J. Soc. Chem. Ind.*, 1949, 68, 208). It was then electrolysed in the apparatus described below, and the oxygen evolved was combined with purified hydrogen (from a cylinder). The resulting water (3 ml.) was treated with a crystal of silver nitrate and a little sodium, and after freezing was ready for vacuum-sublimation into the pycnometer as already described.

The apparatus for electrolysis and combustion is shown in Fig. 7, which is largely self-explanatory.

The cell for electrolysis of ordinary water was a large U-tube fitted with nickel electrodes, and presented no difficulty. In the cell for electrolysis of heavy water it was essential to keep the volume of water necessary to a minimum but at the same time to prevent boiling of the electrolyte and mixing of the gases while a reasonable current (say 3 amp. was passed). The design shown in Fig. 7 proved very satisfactory. With this cell, 5 ml. of water could be electrolysed down to  $\frac{1}{2}$  ml. at a current of 3 amp. (4.5 amp. could be used for the initial stages). There was slight mixing at the commencement of the electrolysis, but after a few minutes a heavy layer of sodium hydroxide solution seemed to form at the bottom of the cell and mixing was almost completely eliminated. However, a heated tube of platinised pumice was introduced into each line, followed by a trap cooled in solid carbon dioxide, thus ensuring that the oxygen and hydrogen were not contaminated as a result of unobservable mixing (*e.g.*, by solution of the gases).

The combustion chamber for the heavy hydrogen and normal oxygen (in the correct molecular ratio for H<sub>2</sub>O), which was filled with platinised asbestos and heated to 300°, provided no difficulties. In the early stages a similar cell for burning heavy oxygen in excess of hydrogen was inclined to explode. The final device used was the combustion chamber just described but made much larger and filled with platinised and palladised pumice.

The authors express their gratitude to Professor E. D. Hughes, F.R.S., for his valuable advice and comments, to Dr. J. Gillis for helpful discussion during the preparation of this manuscript, and to Drs. C. A. Bunton and F. Klein for carrying out numerous mass-spectrometric analyses. One of them (D. R. Ll.) also acknowledges tenure of an I.C.I. Research Fellowship at University College, London.

UNIVERSITY COLLEGE OF NORTH WALES, BANGOR.  
WILLIAM RAMSAY AND RALPH FORSTER LABORATORIES,  
UNIVERSITY COLLEGE, LONDON, W.C.1.  
WEIZMANN INSTITUTE OF SCIENCE, REHOVOTH, ISRAEL.

[Received, March 19th, 1952.]

---