

312. Calomel-electrode Equilibria.

By S. N. DAS and D. J. G. IVES.

The reasons for the lack of agreement between recent determinations of the standard E.M.F. of the hydrogen-calomel cell have been located in the variable incidence of the disproportionation reaction of calomel. It is found to be necessary to distinguish three kinds of calomel electrode, only one of which is suitable for precise measurements over a range of temperatures. These findings raise some questions of general interest in relation to electrodes of the second kind. Procedures and criteria of acceptability of results are suggested.

THE behaviour of the acid calomel electrode, $\text{Hg}|\text{Hg}_2\text{Cl}_2|\text{HCl}(\text{aq.})$, was improved by Hills and Ives,¹ who identified some of the sources of its former erraticity and obtained a value for its standard molal potential at 25° c of $E_m^0 = 0.26796$ abs. v, with an estimated error of $\pm 10 \mu\text{v}$. Similar results at other temperatures were required before the usefulness of the improved electrode could be fully realised. For this purpose, E.M.F.'s of the hydrogen-calomel cell over a range of temperatures have been determined by Hills,² Grzybowski,³ and by Gupta, Hills, and Ives,⁴ and have been supplemented by a re-investigation of the silver chloride-calomel cell by Pouradier and Chateau.⁵ The E_m^0 values for the calomel electrode so obtained have been compared⁶ and show disagreements much larger than could have been reasonably expected, so that confidence in the merits of the "improved electrode" has been shaken. The reason for this disappointing situation has been identified⁷ (unfortunately not in time to prevent publication of certain unsatisfactory results,⁸ shortly to be withdrawn); it is a peculiar characteristic of the calomel electrode which Hills and Ives failed to recognise in their earlier studies, although the signs of it were present. Fortunately, it has little or no adverse effect upon results obtained at the *single temperature* of 25° c by the technique originally prescribed, and this

¹ Hills and Ives, *J.*, 1951, 311, 319.

² Hills, unpublished, 1957.

³ Grzybowski, *J. Phys. Chem.*, 1958, 62, 550.

⁴ Gupta, Hills, and Ives, in preparation.

⁵ Pouradier and Chateau, *Compt. rend.*, 1953, 237, 711.

⁶ Hills and Ives, "Reference Electrodes," ed. Ives and Janz, Academic Press, New York and London, 1961, p. 138.

⁷ Gupta, Thesis, London, 1957.

⁸ Gupta, Hills, and Ives, *Discuss. Faraday Soc.*, 1957, 24, 147.

is no doubt why the E_m^0 value for this temperature independently measured by Schwabe and Ziegenbalg⁹ coincides with that of Hills and Ives. It has, however, had a very adverse effect upon temperature-dependence studies, and calls for modifications of procedure at some cost of convenience; these modifications have been adopted in redeterminations of E_m^0 on which a preliminary report has been made,⁶ and which are to be described in detail elsewhere. The main purpose of the present paper is to record a detailed study of this characteristic of the calomel electrode, and to recommend means of minimising its inconvenience and guarding against its deleterious effects.

The higher valency state of mercury is an embarrassment in the use of the mercury-calomel couple as an electrode of the second kind reversible to chloride ions, for the disproportionation reaction

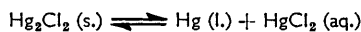

must be established before the electrode can be expected to reach a truly steady potential. The balance of this equilibrium (in which the formation of complex chloro-anions should be included¹⁰) and the rate at which it is attained change markedly with temperature and with acid concentration. Features of half-cell design (such as the ratio of electrode surface area to the volume of half-cell solution) will also be significant in determining how far this generally slow process will proceed in a reasonable interval of time. This very important characteristic of the calomel electrode was overlooked in the earlier work, and is undoubtedly the source of the unfortunate discrepancies.

It is desirable to indicate how Hills and Ives escaped the consequences of this oversight. They found that a freshly set up electrode showed normal behaviour in taking a few hours to reach a potential which remained constant for the rest of the day to within about 10 μv . Slight changes of potential that occurred overnight were rectified by re-filling the cell with the original solution, and further readings gave excellent agreement with the previous day's results; this was adopted as a criterion of acceptability. The overnight changes, thought to be due to inefficient gas pre-saturation, are now attributed to the formation of disproportionation products in the solution; when the old solution was replaced by fresh solution free from these products, the changes were reversed. It is therefore clear that what may be called the "first-day calomel electrode" is not in equilibrium, but, as for a cell with a liquid junction, it is reversible in the sense that the irreversible changes which are slowly taking place and the reversible changes which are occasioned by passing dn faraday of electricity are independent of each other. Since, for a cell, $(E - E^0)$ is of main significance, neither E nor E^0 need be absolutely correct, as long as both are similarly affected by any small departures from true equilibrium conditions. On this basis, the activity coefficients of hydrochloric acid determined by Hills and Ives¹ (and any other results similarly obtained) remain satisfactory. But for such a "non-equilibrium cell" to be serviceable, the irreversible changes to which it is prone must be slow enough, and must have sufficiently small effects on the E.M.F., to give the cell a minimum useful life not less than about 6 hr. This was the case in the original work, in which the temperature did not exceed 25° C, nor the acid concentration about 0.1M. In later work, the calomel electrode was called upon to operate for longer periods at higher temperatures and concentrations, and serious trouble was encountered as a result; solutions were neither substantially free from disproportionation products nor contained them at their proper equilibrium concentrations.

The incidence of disproportionation at the calomel electrode is also clearly shown by a temperature hysteresis due to the slowness of adjustment of equilibrium after temperature change, and by the limited life of the electrode at elevated temperatures when high concentrations of acid are involved. The original suggestion¹ that the high exchange current

⁹ Schwabe and Ziegenbalg, *Z. Elektrochem.*, 1958, **62**, 172.

¹⁰ Sillén, *Svensk. Kem. Tidskr.*, 1940, **58**, 52; *Acta Chem. Scand.*, 1949, **3**, 539; Hietanen and Sillén, *ibid.*, 1952, **6**, 747.

of the improved electrode is due to a special mechanism depending on the existence of an active interfacial film has been strongly supported by anodisation studies.¹¹ It is not surprising that such a film should be specially vulnerable, and it has been found⁷ that under such conditions ($>45^{\circ}\text{C}$; $m_{\text{HCl}} > 1$) the visible film ultimately becomes white and splits, exposing bare mercury. The electrode then becomes erratic, and the special association between calomel and mercury required for adequate reversibility has obviously been destroyed. It is an interesting reflection that, for the calomel electrode, like the hydrogen electrode¹² and perhaps others, there is a conflict between mechanistic and thermodynamic requirements, so that ultimate stability is associated with loss of reversibility. The following experiments have been carried out to clarify these aspects of the behaviour of calomel electrodes.

The studies made by Gupta⁷ of how the E.M.F. of the hydrogen-calomel cell at 25°C changes with time have been extended, using the identical apparatus, which consisted of two calomel and two hydrogen electrodes. Experimental conditions were in each case the same as those prescribed by Hills and Ives,¹ but in the present work, 0.5M-hydrochloric acid was used, instead of 0.1M or 0.01M, in order to accentuate the effects of disproportionation. These experiments, which have already been illustrated,¹³ show an interesting common feature. The initial, faster rise of E.M.F. leads to an almost complete arrest which persists for several hours before the second stage of equilibration takes over, and causes a further rise which is completed in about 24 hr. from the start of the experiment. It leads to an appreciably higher E.M.F. which shows no further change in 48 hr., the longest period of observation. This autocatalytic effect in the disproportionation reaction is not understood, but it may be connected with the observation that mercuric entities in solution facilitate charge transfer at the mercury-hydrochloric acid interface.^{11e} It also provides an extenuating circumstance for the error of omission in the earlier work.

The "second-day electrode" was evidently in a satisfactory (if not ultimate) state of equilibrium at 25°C , but this was no longer the case when the temperature was raised to 40°C . The effect of this change was an abrupt fall in measured E.M.F., an "overshoot," and a rapid recovery leading to a long period of slow increase, clearly due to re-adjustment of the disproportionation equilibrium. Since the reaction concerned must occur in the region of the interfaces between mercury, calomel, and solution, the equilibrium will be approached faster in the diffusion zone of electrolyte close to the electrode surface than elsewhere. This has the effect that the electrode becomes sensitive to disturbance of the solution and, when a stream of gas is directed into it, there is a pronounced "bubbling effect" upon the electrode potential. This effect declines as the bulk of the half-cell solution gradually acquires an increased concentration of soluble disproportionation products. Such an experiment is illustrated in Fig. 1, which also shows the effect on a system at 40°C of a temporary return to 25°C . It may be noted that hydrogen, instead of nitrogen, was often used in the calomel half-cells, but no signs of any homogeneous reduction of mercuric compounds in solution by molecular hydrogen¹⁴ have ever been detected. When, after equilibrium had been established at 40°C , the temperature was restored to 25°C , precisely the reverse effects were observed, each "bubbling test" causing a positive displacement of potential, declining in course of time until the electrode had reduced the excess of mercuric entities which had been generated at the higher temperature. These effects are clearly intelligible and show that temperature hysteresis must be encountered unless, at each temperature, a very long period of equilibration is allowed. It is also established that the bubbling test is a valuable

¹¹ (a) Cousens, Ives, and Pittman, *J.*, 1953, 3972; (b) *Idem, ibid.*, 1953, 3980; (c) *Idem, ibid.*, 1953, 3988; (d) Dibbs, Ives, and Pittman, *J.*, 1957, 3370; (e) Cornish, Thesis, London, 1960.

¹² Hills and Ives, "Reference Electrodes," ed. Ives and Janz, Academic Press, New York and London, 1961, ch. 2.

¹³ Ref. 12, p. 141.

¹⁴ Korinck and Halpern, *J. Phys. Chem.*, 1956, 60, 285; Halpern, *Quart. Rev.*, 1956, 10, 463.

criterion of equilibrium, and it has been adopted as an invariable routine of operation. The "second-day electrode" emerges from this, and from Gupta's work, as probably equal to most thermodynamic requirements, but is one of the most sluggish and inconvenient electrodes on record.

An attempt was made to improve this situation by means of two alternative devices. The first was to stabilise the "first-day electrode" by preventing disproportionation products from accumulating in the solution. The second was to improve the "second-day electrode" by expediting the attainment of the disproportionation equilibrium. To this end, an apparatus was made in which the calomel half-cell solution could, by means of hydrogen lift-pumps, be circulated either over activated charcoal, or over a mercury-calomel dispersion, each contained in separate vessels. These vessels were fitted with sintered filter discs to prevent the transfer of any solid to the half-cell. The charcoal used in these experiments was "Ultrasorb 18/52" (British Carbo-Norit Union, Ltd.) that had

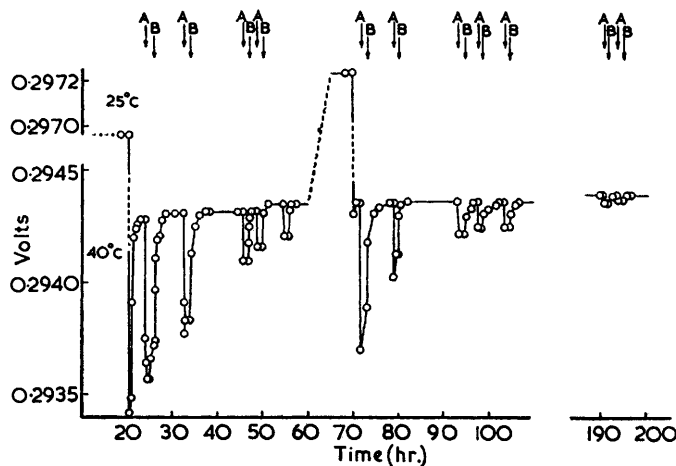

FIG. 1. Gas bubbling and temperature hysteresis effects on a non-equilibrium calomel electrode (0.5M-hydrochloric acid). A, nitrogen bubbled; B, nitrogen by-passed.

been extracted with constant-boiling hydrochloric acid for six weeks, washed continuously with boiling conductance water for a similar period, dried, and ignited to redness in nitrogen. This material has been used for ultra-purification of solutions,¹⁵ carries a positive charge and is particularly effective in adsorbing complex mercuri-anions. The mercury-calomel dispersion was identical with that used for the preparation of the calomel electrode by the dry interaction technique.

For a cell containing 0.5M-hydrochloric acid at 25° c, circulation of the calomel half-cell solution over charcoal led to an unlimited decrease of E.M.F. showing no kind of arrest, with the eventual destruction of the calomel "skin" on the electrode and loss of reversibility. This decisive failure emphasised the role played by mercuric entities in the operation of the calomel electrode, in a way which is not understood. It was also obvious that the "first-day electrode" cannot be stabilised; its potential can only be left to the control of an adventitious steady-state concentration of disproportionation products temporarily established in the diffusion zone. It is of limited life, and is unsuitable for use at temperatures above 25° c; there is no practical possibility of using such an electrode for temperature-dependence studies.

Circulation of the half-cell solution over mercury and calomel in admixture led to quite unexpected results which can best be illustrated in terms of a particular experiment. In 40 hr. the E.M.F. of a similar cell had increased by 130 μ V from its "first-day" value,

¹⁵ Barker, private communication.

and it then remained unchanged for a further 46 hr., when it was considered to have reached equilibrium. It was therefore disconcerting to find that circulation of the half-cell solution over the same mercury-calomel dispersion that had been used to prepare the electrode then caused the E.M.F. to rise again by as much as 140 μ v. That this further change was due to displacement of the conditions at the electrode away from equilibrium was suggested by the fact that the E.M.F. of the cell fell when the circulation was stopped, but rose again when it was resumed. At 40° c this anomalous effect was accentuated, producing a rise of E.M.F. as great as 720 μ v. Disequilibrium in this state was confirmed by the observation of a large, positive "bubbling increment" of electrode potential. After this treatment, restoration of the temperature to 25° c gave rise to a hysteresis effect far larger than any previously encountered, and the positive bubbling increment at the lower temperature exceeded 1 mv. Long storage and continued bubbling led to a slow decrease of E.M.F. as reduction of the undoubtedly large excess of mercuric mercury proceeded spontaneously at the electrode-solution interface. Before this change approached completion, the half-cell solution was replaced by fresh; this produced a fall in E.M.F. of about 1 mv and the cell normally regained its proper "second-day" E.M.F. slowly, both the initial and final values of which were within 20 μ v of that calculated for the solution in terms of the best available E_m^0 .

During the course of these experiments, assessments of electrode reversibility were made by means of cyclic micropolarisation,^{11a,c} with the self-explanatory results shown in

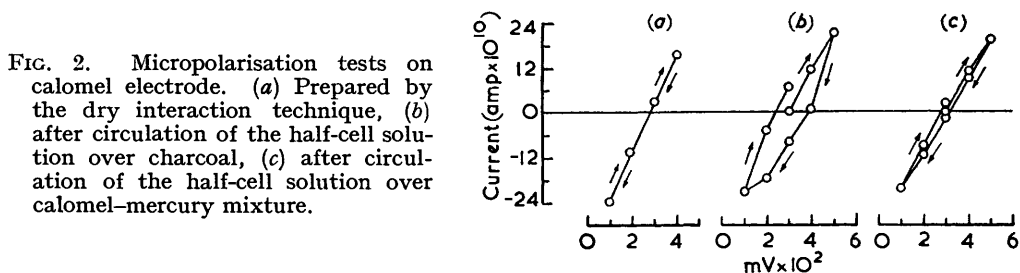

FIG. 2. Micropolarisation tests on calomel electrode. (a) Prepared by the dry interaction technique, (b) after circulation of the half-cell solution over charcoal, (c) after circulation of the half-cell solution over calomel-mercury mixture.

Fig. 2. It is seen that the charcoal treatment of the solution ruined electrode reversibility and, more surprisingly, the mercury-calomel treatment also had a markedly adverse effect upon it.

Disappointment of the failure of this second device (which was in any case too cumbersome to be practical) was secondary to the question it raised of how an electrode system could, under such conditions, spontaneously depart from equilibrium. In so far as this question was nonsensical, the status even of the "second-day" calomel electrode required re-examination. To avoid possible misinterpretation of the results so far obtained, the following further experiments were conducted.

The circulation cell was again set up precisely as before, except that the ancillary vessels were left empty. One of them was used to inject small volumes of 0.001m-mercuric chloride solution prepared in a sample of the cell solution with due precautions against oxygenation. This cell at first behaved normally, showing an initial negative bubbling increment and a slow rise of E.M.F., until additions of mercuric chloride were started. Without detailed description, it was found that positive displacements of E.M.F., change from negative to positive bubbling increments, and slow recovery from higher to lower electrode potentials when kept were all observed. It was, indeed, almost possible to reproduce the results of the previous experiment.

One of the most satisfactory ways of establishing an electrode of the second kind is to prepare the metal and its sparingly soluble derivative separately in the purest, best-defined, and most stable form and to establish equilibrium between them only through a continuously circulated solution phase. This eliminates all complications due to special

interactions, the occurrence of metastable phases, distortions of crystalline forms, and the like. The method is well established by the work of Brönsted,¹⁶ Gerke,¹⁷ Güntelberg,¹⁸ and Roberts and Fenwick,¹⁹ and it was clearly appropriate to apply it to the calomel electrode as a possible means of solving the problems that had arisen. For this purpose, the same circulation apparatus was used, charged with the same 0.5M-hydrochloric acid, but the electrode consisted of a pool of mercury with no calomel upon it. In one of the ancillary vessels was placed a quantity of calomel, free from mercury, carefully prepared by chemical precipitation and exhaustively extracted with the cell solution under anaerobic conditions. The apparatus was equipped with the usual reference and buffer hydrogen electrodes, and particular care was taken to preserve oxygen-free conditions, as far as possible, at all stages.

The initial behaviour of the calomel-free mercury pool electrode approached that of the ideally polarised electrode, except that it spontaneously tended to drift to a potential

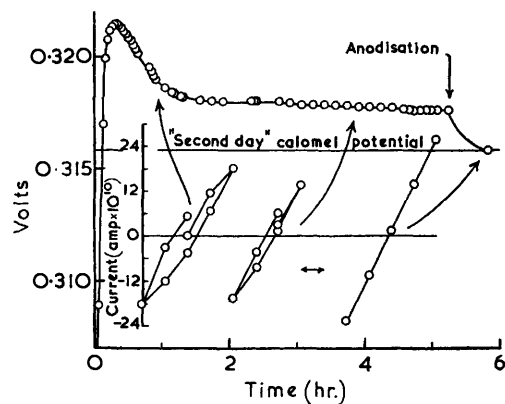

FIG. 3. Potential of mercury pool subjected to continued circulation of half-cell solution over white calomel; inset, micropolarisation tests.

some 20–30 mv negative to the calomel potential appropriate to the solution. This is characteristic of such a system when it has not been subject to the most rigorous de-oxygenation procedures. The electrode could, however, be cathodised by using the large buffer hydrogen electrode as anode, and this procedure was used to bring the initial resting potential to a more negative value when required. Circulation of the half-cell solution over the calomel was then commenced and immediately produced a swoop of potential in the positive direction, past the calomel potential by about 5 or 6 mv to a maximum from which a fairly rapid decline took place, leading to a plateau of potential fairly level at about 2 mv positive to the appropriate calomel value. The sequence of events is typified by Fig. 3, which also shows the reversibility tests that were conducted. They indicate the generation of some sort of calomel electrode, very defective in reversibility and with an excessively positive potential. At the stage indicated, the electrode was given a brief anodisation, 200 μ A for 20 sec.; the potential then fell precisely to the proper "second-day" value, and the electrode became fully reversible.

The significance of these results is enhanced by the fact that they could be indefinitely repeated after thorough cathodisation of the electrode, thus excluding any possibility that they were due to mercuric mercury unwittingly left in the calomel during the course of its preparation. The results are also identical in type with those previously reported^{11a} in relation to anodisation at very low current density of mercury in aqueous hydrochloric acid. They also recall the dramatic effects of anodic pulses of higher current density in producing an unpolarisable electrode from a polarised one.^{11b} Continued experiments of this kind introduce the necessity for calling attention to the existence of a third kind of

¹⁶ Brönsted, *Kgl. danske Videnskab. Selskab, Mat.-fys. Medd.*, 1920, **3**, No. 9.

¹⁷ Gerke, *J. Amer. Chem. Soc.*, 1922, **44**, 1684.

¹⁸ Güntelberg, *Z. phys. Chem.*, 1926, **123**, 199.

¹⁹ Roberts and Fenwick, *J. Amer. Chem. Soc.*, 1928, **50**, 2125.

calomel electrode, for eventually in each experiment a tolerably reproducible potential was reached without the intervention of anodisation. Thus, for the same cell solution (0.5M-hydrochloric acid at 25° c), the following sequence of results (with intervening cathodic strippings) was obtained: 0.31772 v; 0.31771 v; 0.31771 v $\xrightarrow{\text{anodisation}}$ 0.31589 v; 0.31777 v $\xrightarrow{\text{anodisation}}$ 0.31588 v. The potentials attained after anodisation were in agreement (within 10 μ v) with that calculated for the solution from the "second-day" E_m^0 value^{4,6}. The "third calomel electrode," with a potential some 2 mv positive with respect to the others, is not particularly serviceable, for it is poor in reversibility and must have a much smaller exchange current. Its existence, however, raises in acute form the question of what really is the thermodynamic potential of the calomel electrode, determined solely by the properties of pure, bulk phases? No decision seems to be possible in terms of calculations from primary thermodynamic data derived from strictly non-electrochemical sources, for there is none of adequate reliability.

In these circulation experiments, a visible film of calomel soon formed on the mercury and continued to grow, apparently indefinitely. This suggests that the calomel deposited on the mercury must have a lower chemical potential than that of the bulk phase, otherwise transfer would stop after the formation of a very thin, limiting film, enough to destroy the gradient of chemical potential. The transfer was surprisingly rapid. It was roughly estimated in rate by connecting the mercury pool, *via* a galvanometer, to the buffer hydrogen electrode, so that all reducible material arriving at the pool would be reduced and provide a measurable current. For a solution flow estimated at 1 l. hr.⁻¹, this current was about 3 μ A, corresponding to a concentration of reducible substance of about 10⁻⁷ equiv. l.⁻¹. This far exceeds the concentration of mercurous ions that could be produced by "ionic dissolution" of calomel but it does not exceed the total concentration of reducible mercury in a "saturated solution of mercurous chloride in water" as determined by Dry and Gledhill.²⁰ But in such a solution 99.75% of the mercury is in the mercuric state, and its formation involves the precipitation of metallic mercury. In a white calomel-0.5M-aqueous hydrochloride acid system, it is unlikely that this equilibrium will be established in the complete absence of mercury, and it is of interest to calculate what more probable metastable equilibrium state will be approached. For this purpose, the equilibrium constants determined by Sillén *et al.*¹⁰ for a medium of ionic strength 0.5 are suitable, but the calculations can only be approximate because of lack of knowledge of activity coefficients and other differences in conditions. The following data have been used:



Since $\text{Cl}^- = 0.5$; $\text{Hg}_2^{2+} = 5.28 \times 10^{-17}$, where the symbols for the species have been used to represent concentrations. For the homogeneous disproportionation reaction,²¹

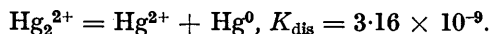

This reaction will be little affected by ionic strength, but the high concentration of hydrochloric acid will not only repress hydrolysis, it will favour the reaction by forming mercuric chloride and anionic complexes derived from it. In absence of any net oxidation or reduction, however, the total bivalent mercury and the zero-valent mercury passing into solution must remain equivalent to each other. The following equilibria will therefore have to be taken into account:

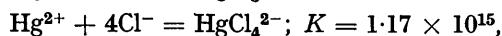
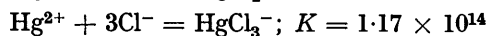

²⁰ Dry and Gledhill, *Trans. Faraday Soc.*, 1955, **57**, 1119.

²¹ Hills and Ives, "Reference Electrodes," ed. Ives and Janz, Academic Press, New York and London, 1961, p. 146.

from which it can be calculated that the total mercuric mercury in solution in whatever form is $\text{Hg}^{\text{II}} = 9.18 \times 10^{13} \times \text{Hg}^{2+}$, and since $\text{Hg}^{\text{II}} = \text{Hg}^0$, it turns out that $\text{Hg}^0 = 3.91 \times 10^{-6}$ g.-atoms l^{-1} . But this exceeds the bulk solubility of mercury in water, which is ²² 3.0×10^{-7} g.-atoms l^{-1} , by an order of magnitude, and this discrepancy represents the tendency of mercury to precipitate. It is suggested, however, that in a mercury-free system precipitation does not occur because of supersaturation. This seems particularly probable because, in the process of aggregation of mercury atoms which must be involved, extremely small droplets must initially be formed and these have a higher chemical potential than that of bulk mercury. This arises because of the high interfacial tension (*ca.* 500 dynes cm^{-1}) which will render nucleation difficult; thus for droplets of 10 Å radius (a size through which the aggregates must pass in growth), the chemical potential is greater than normal by 10 kcal., corresponding with a doubled solubility.

This approximate calculation indicates that there is no mystery about the rapid transfer of "calomel" in the circulation experiments, but it suggests that two processes occur when the solution reaches the mercury pool: reduction of mercuric mercury and deposition of elementary mercury. It is also clear why calomel deposition continues to occur as long as any *white* calomel remains in the system, and perhaps the most important inference is that white calomel is not thermodynamically stable in aqueous systems except in the presence of both of its disproportionation products. This could be the reason why the third kind of calomel electrode has a potential more positive than the others, but, if so, it must be a metastable electrode. This is supported by the fact that an anodic pulse establishes the mechanism by which its metastability can be relieved.

There is, however, another aspect to this problem which must not escape attention. It has been shown ²³ that the anodic generation of calomel on mercury always leads to a deposit of unique orientation, with the {110} calomel plane parallel to the mercury surface. Examination of this process under the polarising, reflecting microscope ^{11e} shows that it always follows a remarkably uniform pattern. It also leads to the formation of a highly reversible electrode, and it seems very likely that it is this unique, oriented association between calomel and mercury which is essential to full reversibility. It is probably attained in the dry interaction technique by an alternative "statistical chance" route. If this is so, it could well be argued that the reversible electrode which has this special feature requires a more detailed description than "calomel electrode," such as "the mercury-{110} plane of calomel electrode." If this is agreed, it could be further argued that calomel in this special situation has a lower chemical potential than bulk-phase calomel, and it then becomes pointless to try to establish too close a correlation between electrode potentials on the one hand and the thermodynamic properties of bulk phases on the other. There are two aspects to this conclusion. Either the electrode is an equilibrium system involving "interphase material," which in the present case might conceivably be classed as a sort of mercury subchloride which has no existence as a bulk phase, or the electrode is a metastable system, in which case its operative life is likely to be limited. This seems to be the case in practice, but no way can be seen of deciding between these alternatives. Similar problems could be associated with other electrodes of the second kind.

Two further experiments in this series are worth reporting. Studies of the anodisation of mercury under the polarising microscope are to be published in due course, and it has already been mentioned that the generation of calomel in this way follows a remarkably regular and characteristic course. The calomel formed on a mercury pool under the conditions of the "calomel circulation experiments" was also examined in this way, and was found to be entirely different. It would not be appropriate to describe this work in detail, but it can be said that deposition was observed after one hour of circulation and

²² Moser and Voigt, *J. Amer. Chem. Soc.*, 1957, **79**, 1837; *J. Inorg. Nuclear Chem.*, 1957, **4**, 354.

²³ Thirsk, *Proc. Phys. Soc.*, 1953, **66**, B, 129.

led eventually to a fluffy aggregation of clumps of ill-defined micro-crystals standing up from, and loosely attached to, the mercury surface. There was hardly any sign of any oriented crystal growth, so characteristic of the electrolytically formed material, and the strong impression was gained that the calomel, far from being closely associated with the mercury, was only "floating" on it.

It seemed appropriate at this stage to repeat an experiment carried out in the early stages of the calomel electrode studies. It was to set up a cell containing two calomel electrodes, one of the now orthodox type prepared by the dry interaction technique and the other, made of the same materials, but with the calomel dropped through the solution on to the initially bare mercury-solution interface. This was carried out with use of

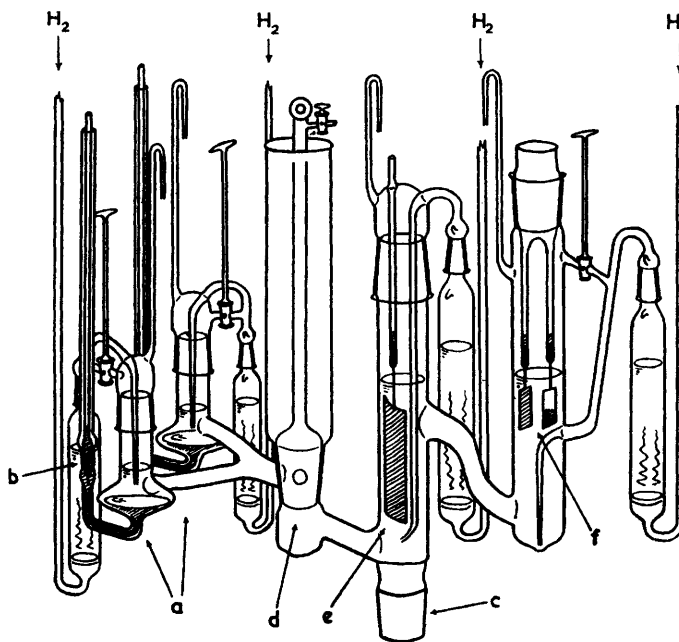

FIG. 4. Revised design of hydrogen-calomel cell. (a) Calomel electrodes, (b) mercury contact, (c) central mounting cone, (d) half-cell isolation tap, (e) buffer hydrogen electrode, (f) reference hydrogen electrodes.

0.5*m*-hydrochloric acid. The first electrode carried the usual uniform, pearly deposit of calomel and showed the usual regular behaviour of the improved electrode. When the calomel was dropped into the other electrode vessel, it drifted through the solution and settled on the mercury, forming a band, mainly round the edges of the pool. It did not spread. Initially, the second electrode was 4 mv positive with respect to the other, but this difference decreased in the course of an hour to 0.2 mv. Thereafter, during 9 hr., the potential fluctuated but always remained positive to the extent of 0.05–0.75 mv. This confirms the earlier findings, but is of renewed interest in representing a sort of "half-way house" between the third kind of calomel electrode and the others. It also emphasises the importance, already indicated in the preceding experiments, of keeping calomel under the strict control of excess of bulk-phase mercury in the attempt to establish an electrode of maximum reproducibility. The "mercury-calomel" circulation experiments showed that this is a matter of some difficulty.

The objective of this work was to arrive at an electrode design which would minimise the difficulties associated with the calomel electrode and be most suitable for measurements of high precision made over a temperature range. It became clear that only the

"second-day electrode" would serve and must always be allowed spontaneously to reach its own equilibrium state, which must be identified by its complete indifference to bubbling. The only way seemed to be to use as large a ratio of electrode surface area to volume of half-cell solution as possible. This is the main feature of the apparatus illustrated in Fig. 4. Attention is drawn to the method of making electrical contact to the mercury pools, designed to eliminate the pulsing tendency inseparable from the use of open-ended capillaries, and to the large, centrally-placed mounting cone which ensures reproducibility of positioning in the thermostat bath and aids in securing vibration-free mounting. Other items of some importance are the tap for isolating the two halves of the cell, the large buffer hydrogen electrode and the pair of reference electrodes, one of which is only half platinised. The latter device is useful in confirming the attainment of equilibrium; normally these two electrodes agree to within $1 \mu\text{v}$, but show a very large divergence in the event of adventitious poisoning, depletion of concentration of dissolved hydrogen, or incipient senility.

This cell was tested by conducting a series of measurements from 5° to 45°C , a very dilute solution of hydrochloric acid being used, so that accurate assessments of E_m^0 could be made with the aid of well-accepted activity coefficients²⁴ not deviating very much from unity. Experimental methods were throughout the same as those previously used. The following schedule of operations, however, may be of interest; the calomel electrode vessels were filled with mercury at zero time.

hr.	min.	
0	10	Calomel "skin" added to mercury.
0	15	Hydrogen electrodes inserted.
0	20	Air swept out of apparatus with nitrogen.
0	30	Hydrogen passed through apparatus.
4	30	Hydrogen-saturated 0.008601M-hydrochloric acid solution introduced; hydrogen bubbled through calomel electrode compartments.
5	10	Temperature of bath adjusted to 5°C .
6	50	Hydrogen by-passed over the surface of the solution in the calomel electrode compartments.
6	55	E.M.F. readings commenced: 0.50469, 0.50470 abs. v
7	15	0.50476, 0.50476 "
8	50	0.50486, 0.50486 "
10	10	0.50491, 0.50491 "
11	30	0.50495, 0.50495 "
12	00	0.50495, 0.50495 "
12	30	0.50495, 0.50495 "

At this stage, periodical bursts of hydrogen bubbling had no effect. The barometric pressure was 747.95 mm. Hg at 0°C , etc.; vapour pressure of solution, 6.54 mm.; bubbler depth in hydrogen electrode half-cell, 70 mm.; corrected E.M.F., 0.50528 abs. v. The collected results of this experiment were as follows:

Temp. ($^\circ \text{C}$)	E , corr. (abs. v)	γ^{25}	E_m^0 (abs. v)	E_m^0 (abs. v) (G, H, & I ⁴)	Δ (μv)
5	0.50528	0.9113	0.27289	0.27289	0
10	0.50850	0.9111	0.27191	0.27191	0
15	0.51165	0.9111	0.27085	0.27082	+30
20	0.51452	0.9109	0.26956	0.26955	+10
25	0.51733	0.9103	0.26816	0.26816	0
30	0.52002	0.9090	0.26661	0.26659	+20
35	0.52250	0.9081	0.26486	0.26485	+10
40	0.52493	0.9074	0.26304	0.26303	+10
45	0.52711	0.9068	0.26103	0.26103	0

It is seen that the mean deviation of the E_m^0 values obtained from this single experiment from those which are believed to be the best available for the "second-day" calomel electrode is only $9 \mu\text{v}$. This greatly improves the former situation of disappointing agreement between different workers using different designs of cell. It is also to be noted that

²⁴ Harned and Owen, "The Physical Chemistry of Electrolyte Solutions," Reinhold Publ. Corp., New York, 1958.

the "second-day" E.M.F. was attained in about 7 hr. after cell filling. The suitability of this cell for precise measurements has recently been demonstrated,²⁵ although some further improvements in accuracy are still to be desired.

One of us records thanks to the authorities of the University of Patna for study leave.

THE GEORGE SENTER LABORATORY, BIRKBECK COLLEGE,
LONDON, W.C.1.

[Received, November 20th, 1961.]

²⁵ Das and Ives, *Proc. Chem. Soc.*, 1961, 373.
