

## Quantification of Effective Polarisability. Applications to Studies of X-Ray Photoelectron Spectroscopy and Alkylamine Protonation

Johann Gasteiger\* and Michael G. Hutchings†

Organisch-Chemisches Institut, Technische Universität München, Lichtenbergstr. 4, D-8046 Garching, West Germany

Two new empirical methods lead to a quantification of polarisability-derived stabilisation of charge in molecules. These take account of the all-important attenuation of substituent influence as it is further from the charged centre. The first is derived from a formula for calculating mean molecular polarisabilities and also takes account of heteroatom substitution. A simple bond-counting procedure is an alternative for unsubstituted alkyl groups. The value of these two models is shown with studies on Cl and Ge ESCA/Auger spectral data, nitrogen 1s binding energy shifts, and with data on the gas phase proton affinities of alkyl substituted amines.

Development of the synthesis and reaction design computer program, EROS,<sup>1</sup> has led us to devise quantitative models of organic chemical reactivity. In an attempt to simplify the chemical systems under study, the initial efforts have been concentrated on gas-phase reactions where the confusing influence of solvent is absent. Much of the work has been oriented towards evaluating the applicability of the charge and residual electronegativity values given by the new iterative Partial Equalisation of Orbital Electronegativity (PEOE) method.<sup>2</sup> However, in the course of this work it became clear that such parameters alone were insufficient to explain much of the data on, for instance, proton-transfer equilibria in the gas phase. Previous discussions of such reactions have concluded that polarisability is of importance in determining the equilibrium,<sup>3</sup> but unfortunately a quantitative examination of this phenomenon has floundered on the absence of a suitable quantitative model. It was thus that we were led to investigate approaches to this problem, the results of which comprise the first part of this paper.

The value of any model can only be estimated by measuring its performance against known data. Thus, in the second part of this paper, the polarisability models are tested against three such sets of experimental data, one chemical (gas phase proton-transfer equilibria of unsubstituted alkylamines), the other two obtained from X-ray photoelectron spectra (N 1s ESCA measurements, and data derived from combined ESCA–Auger experiments). In all cases, the experimental data are taken from the literature, and the systems are studied either by direct correlation or multilinear regression analysis.

Besides being an important effect in gas phase organic chemistry, it is now becoming more apparent, contrary to earlier views, that polarisability is also a source of intramolecular stabilisation of organic ions in solution.<sup>4</sup> The methods described in this paper are thus anticipated to be applicable across a wide range of physical organic chemistry.

### Results and Discussion

**Models of Effective Polarisability.**—Polarisability is a measure of the relative ease of distortion of a dipolar system when exposed to an external electric field. Thus an easily polarised molecule will be distinguished from a less easily polarised molecule by its higher induced dipole moment due to displacement of electron density from the equilibrium distribution around the nuclei in the presence of a field ( $F$ ). The distortion of the electron cloud is always such as to give

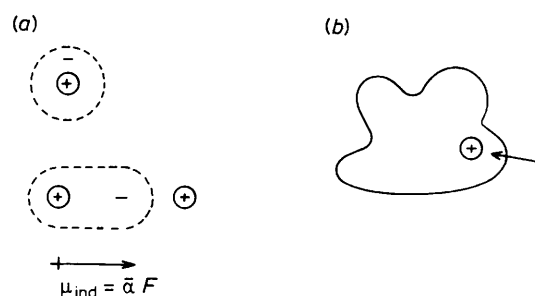

Figure 1. (a) Dipole induced by a remote charge; (b) charge generated within a molecule through attack of a reagent

an induced dipole ( $\mu_{ind}$ ), which stabilises the presence of the charge [Figure 1(a)].  $\bar{\alpha}$  is thus the *mean molecular polarisability* (MMP) of the molecule. Classical electrostatics yields equation (1) for the stabilisation energy ( $E_{cl}$ ) due to charge-induced dipole interaction between a remote charge,  $q$ , and a system of molecular polarisability,  $\bar{\alpha}$ , when the two are separated by a distance,  $r$ , in a medium of dielectric constant,  $\epsilon$ . Thus, stabilisation of charge due to polarisability is highly distance dependent.

$$E_{cl} = \frac{-\alpha \cdot q^2}{2 \cdot \epsilon \cdot r^4} \quad (1)$$

In chemical reactivity, the picture is usually complicated by the fact that the charge is generated *within* the molecule [Figure 1(b)]. This could arise, for instance, as a positive charge in a molecule due to protonation or ionisation, or a negative charge resulting from the attack of a nucleophilic anion. Because of the strong distance dependence of the stabilisation energy  $E_{cl}$ , those parts of the molecule closest to the charge have greater influence on stabilisation than those which are more remote. As the charge already resides on the molecule, mean molecular polarisability (MMP) is no longer the appropriate property to consider when determining charge-induced dipole stabilisation.

In attempting to model the stabilisation resulting from polarisability when the charge is generated within the molecule two particular phenomena must therefore be reproduced: firstly, the attenuation of the effect due to increasing separation, as just outlined; and secondly, the differing relative polarisabilities of the various elements in their different hybridisation states (larger atoms are generally more polarisable than smaller ones).

† Permanent address: I.C.I., Organics Division, Research Department, Blackley, Manchester M9 3DA.

**Table 1.** Atomic polarisability contributions for atoms in various hybridisation states (taken from ref. 6)

Atom	Hybridisation	$\tau_i$
H	$\sigma$	0.314
C	te te te te	1.294
C	tr tr tr $\pi$	1.428
C	di di $\pi$ $\pi$	1.393
N	te <sup>2</sup> te te te	1.435
N	tr <sup>2</sup> tr tr $\pi$	1.262
N	tr tr tr $\pi^2$	1.220
N	di <sup>2</sup> di $\pi$ $\pi$	1.304
O	te <sup>2</sup> te <sup>2</sup> te te	1.290
O	tr <sup>2</sup> tr <sup>2</sup> tr $\pi$	1.216
O	tr <sup>2</sup> tr tr $\pi^2$	1.099
F	$\sigma$	1.046
Cl	$\sigma$	3.130
Br	$\sigma$	5.577
I	$\sigma$	8.820
P	te <sup>2</sup> te te te	3.000
S	te <sup>2</sup> te <sup>2</sup> te te	3.496
S	tr <sup>2</sup> tr <sup>2</sup> tr $\pi$	3.967
S	tr <sup>2</sup> tr tr $\pi^2$	2.982

We have adopted an empirical approach to this problem consistent with the principles underlying the other quantitative models of organic chemistry we have developed. Thus, the method should be rapid in execution, and it should be based on the topology of the molecule, rather than needing a knowledge of the geometry. Methods which enable calculation of MMP seemed a reasonable point from which to start. It has been recognised for quite some time that MMP can be estimated from additive atomic or bond contributions.<sup>5</sup> However, the results are not always particularly accurate. Recently two formulae have appeared that enable the calculation of MMP based on a constant increment for each atom in a particular hybridisation state in a molecule.<sup>6,7</sup>

The Miller-Savchik formula<sup>6</sup> for MMP is given in equation (2), where  $N$  is the total number of electrons in the molecule, and  $\tau_i$  is a polarisability contribution for each atom  $i$ , characteristic of the atom type and its hybridisation state. Values of  $\tau_i$  for many common non-metallic elements are available (Table 1).<sup>6</sup> Results obtained with this formula are in general within 1% of the experimental MMP values.

$$\bar{\alpha} = \frac{4}{N} \left( \sum_i \tau_i \right)^2 \quad (2)$$

Our approach<sup>8</sup> has been to modify the formula of equation (2) by the introduction of a damping factor,  $d^{n_i-1}$ , where  $0 < d < 1$ , which ensures attenuation of the effective polarisability,  $\alpha_d$ , as in equation (3). The exponent,  $n_i$ , is the smallest number of bonds between the charged atomic centre and the atom,  $i$ . It has been found empirically from studies of several systems that a value for  $d$  of 0.75 gives the most satisfactory results.

$$\alpha_d = \frac{4}{N} \left( \sum_i d^{n_i-1} \cdot \tau_i \right)^2 \quad (3)$$

Although  $\alpha_d$  has the dimensions of polarisability, it is taken as a measure of the stabilisation energy resulting from polarisability. This follows from equation (3) since the latter takes account of the important distance-dependent attenuation of stabilisation effect via  $d^{n_i-1}$ . For this reason we refer to  $\alpha_d$  as the effective polarisability. The equation also accounts for different atom and hybridisation types through  $\tau_i$ . Implicit

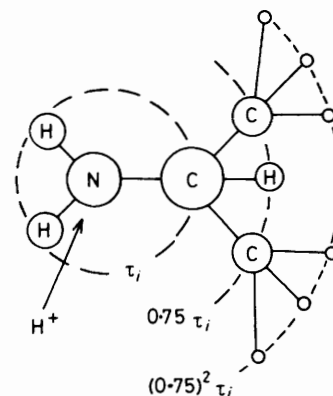
**Figure 2.** Calculations of effective polarisability,  $\alpha_d$ , for reaction at the nitrogen atom of  $\text{Pr}^1\text{NH}_2$ 

in this overall interpretation is the assumption that the dielectric constant,  $\epsilon$ , has a constant, average value within the molecule.

The calculation of  $\alpha_d$  is exemplified for  $\text{Pr}^1\text{NH}_2$  with the assumption that nitrogen is the reaction site (*e.g.*, in protonation). (Note that the atom corresponding to the reaction centre is not included in the calculation.) Figure 2 aids visualisation of this procedure. The result is given by equation (4).

$$\alpha_d(\text{Pr}^1\text{NH}_2) = \frac{4}{9 \times 1 + 3 \times 6} [(\tau_C + 2\tau_H) + 0.75(2\tau_C + \tau_H) + 0.75^2(6\tau_H)]^2 = 3.942 \quad (4)$$

An important feature of equation (3) is that it renders the value of the effective polarisability dependent on the choice of the reaction centre, in contrast to MMP. Thus, if a molecule contains more than one reaction centre, the effective polarisabilities associated with each can be different. For the example of the two possible protonations of  $\text{Me}_2\text{NCH}_2\text{-CH}_2\text{NH}_2$ ,  $\alpha_d = 6.197$  for the  $\text{Me}_2\text{N}$  centre, whereas  $\alpha_d = 3.590$  for the  $\text{NH}_2$  centre.

This example accentuates another important property of equation (3), namely that isomeric groups have different effective polarisabilities. Some of the values recorded in Table 2 exemplify this. Other values are included in this Table to demonstrate the results of successive replacements of hydrogen by chlorine in a methyl group. Furthermore, the influence of substituent position is shown by the entries for various chloropropyl derivatives. Although the higher polarisability of chlorine is clearly reflected by the chloromethyl derivatives, it is also clear that substitution further from the reaction centre in the chloropropyl isomers has correspondingly less effect. Finally, the quantitative effect of various different hetero-substituents is illustrated.

The values in Table 2 can be used for any system where the groups are attached to a monovalent atom, for instance a chlorine atom as in the ESCA-Auger data discussed in more detail later. However, the form of equation (3) implies that the effective polarisability values are not additive if attached to polyvalent reaction centres. A further consequence is that the summation can be terminated at atoms six bonds removed from the reaction centre, as the damping factor ensures that the contributions of more remote atoms are negligible.

The second model for effective polarisability makes use of a simple bond-counting *ansatz*. This *ansatz* has been constructed as a conceptually even simpler model which accounts

**Table 2.** Values of effective polarisabilities,  $\alpha_d$ , and connectivity numbers,  $N_c$ , for various groups

Group	$\alpha_d$	$N_c$
Me	1.779	2.500
Et	2.509	3.250
Pr <sup>n</sup>	2.842	3.625
Pr <sup>l</sup>	3.284	4.000
Bu <sup>n</sup>	2.941	3.813
Bu <sup>s</sup>	3.639	4.375
Bu <sup>l</sup>	3.231	4.000
Bu <sup>t</sup>	4.071	4.750
ClCH <sub>2</sub>	2.706	
Cl <sub>2</sub> CH	3.780	
Cl <sub>3</sub> C	4.877	
1-ClPr <sup>n</sup>	3.904	
2-ClPr <sup>n</sup>	3.280	
3-ClPr <sup>n</sup>	2.847	
FCH <sub>2</sub>	1.529	
BrCH <sub>2</sub>	3.291	
ICH <sub>2</sub>	4.605	
HOCH <sub>2</sub>	1.991	
H <sub>2</sub> NCH <sub>2</sub>	2.401	
HSCH <sub>2</sub>	3.332	

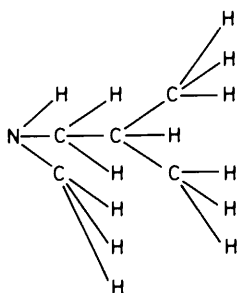

Sphere $n$	1	2	3	4
No. of bonds $b_n$	3	6	3	6
$N_c =$	$(3 \times 1) + (6 \times \frac{1}{2}) + (3 \times \frac{1}{4}) + (6 \times \frac{1}{8}) = 7.5$			

**Figure 3.** Calculation of connectivity number,  $N_c$ , for Bu<sup>l</sup>MeNH, starting at the nitrogen atom

for the attenuation effect. A connectivity number ( $N_c$ ) is calculated by counting bonds starting from the atom of interest (e.g., the protonated centre) and proceeding through the molecule in spheres. The number of bonds in successive spheres is attenuated by a factor of 0.5. Figure 3 exemplifies the procedure for Bu<sup>l</sup>MeNH.

In general,  $N_c$  is given by equation (5) where  $b_n$  is the number of bonds in the  $n$ th co-ordination sphere.

$$N_c = \sum_n b_n (0.5)^{n-1} \quad (5)$$

Clearly, though, this method treats all bonds as equivalent. However, it is found that the  $N_c$  values for a range of alkyl-substituted amines correlate very well with the  $\alpha_d$  values calculated by equation (3) ( $n$  49;  $r$  0.9965;  $s$  0.35  $N_c$  units). Thus it appears that ignoring the difference between the C-C and the C-H bonds has little effect. The method, not unnaturally, is invalid when heteroatoms are introduced into the alkyl groups. Therefore only values for simple alkyl groups are included in Table 2.

**Table 3.** Correlation and regression data ( $n$  = number of data points,  $r$  = regression coefficient,  $s$  = standard deviation)

Set	Parameter	$n$	$r$	$s$
Relaxation energy of organochlorine compounds on core ionisation				
1	$\alpha_d$	14	0.955	0.13 eV
2	$\alpha_d$	13	0.958	0.10 eV
3	$\bar{\alpha}$	14	0.885	0.21 eV
Relaxation energy of organogermanium compounds on core ionisation				
4	$\alpha_d$	8	0.940	0.18 eV
N 1s ESCA				
5	$q_N$	32	0.985	0.53 eV
6	$q_N, \alpha_d$	32	0.995	0.31 eV
Alkylamine proton affinity				
7	$N_c$	49	0.993	2.9 kJ mol <sup>-1</sup>
8	$\alpha_d$	49	0.984	4.2 kJ mol <sup>-1</sup>

If the values yielded by equations (3) and (5) are realistic, they must correlate with suitable experimental data. We now demonstrate their relevance to an interpretation of physical and chemical data for positively charged species. The ideal test case is one where only one effect is operative, and the experimental data can be measured directly. As far as we are aware, no such system satisfies this criterion in the case of effective polarisability. However, for alkylamine proton affinity (PA), electronic effects are so small that polarisability can be regarded as the sole influence on the magnitude of PA. Alternatively, experimental data from various sources can be combined to give secondary data directly related to the physical effect under consideration. This is the case for some ESCA-Auger photoelectron spectroscopic data. Finally, data can be analysed quantitatively in terms of two (or more) effects, as for a series of N 1s ESCA shifts.

*Relaxation Energies derived from Chlorine 2p and Germanium 3d X-Ray Photoelectron and Auger Spectroscopy.*—A recent study has elegantly demonstrated the use of combined Cl 2p X-ray photoelectron spectra (Cl 2p ESCA) and Auger KLL spectra [equation (6)] in determining the relative influence of ground state and relaxation effects on the ease of core ionisation.<sup>9</sup> The shift in the core-ionisation energy between two compounds and the corresponding shift in the Auger kinetic energy can be used to derive experimental values for the so-called final state relaxation energies,  $\Delta R$ , a property directly related to the polarisability of the ligands of the ionised atom.<sup>9</sup> Data for a series of 14 organochlorine derivatives were reported. Such data should be directly proportional to effective polarisability values calculated by equation (3), if the latter is meaningful.

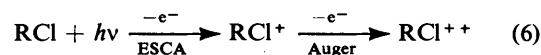

In fact, it is found that there is a satisfyingly good correlation between the experimental values and those calculated from equation (3) (Table 3, set 1, Figure 4). If HCl is regarded as an outlier, the correlation is appreciably improved (Table 3, set 2). Clearly there is some scatter about the correlation line, but we regard the correlation as evidence for the validity of the polarisability values given by equation (3).

If no allowance is made for the attenuation of polarisability

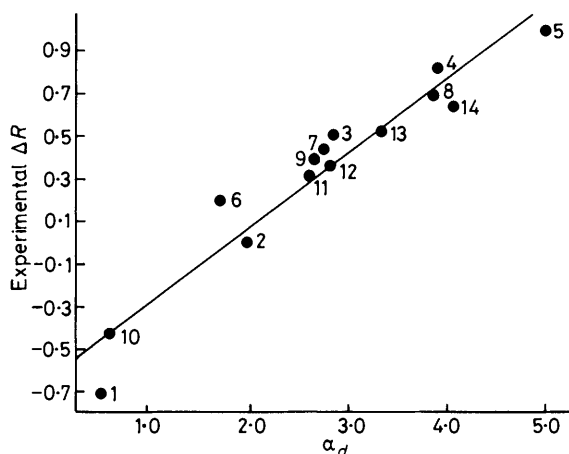

**Figure 4.** Correlation of final state relaxation energies,  $\Delta R$  (ref. 9), with effective polarisability.  $\Delta R = -0.59 + 0.34\alpha_d$ . 1, HCl; 2, MeCl; 3,  $\text{CH}_2\text{Cl}_2$ ; 4,  $\text{CHCl}_3$ ; 5,  $\text{CCl}_4$ ; 6,  $\text{CClF}_3$ ; 7,  $\text{CCl}_2\text{F}_2$ ; 8,  $\text{CCl}_3\text{F}$ ; 9,  $\text{Cl}_2$ ; 10,  $\text{ClF}$ ; 11,  $\text{EtCl}$ ; 12,  $\text{Pr}^n\text{Cl}$ ; 13,  $\text{Pr}^i\text{Cl}$ ; and 14,  $\text{Bu}^i\text{Cl}$

for more distant substituents, and overall MMP values are used [*i.e.*, equation (2)], the correlation becomes much worse (Table 3, set 3).

Since the ligands of the chlorine atom in this series contain a high proportion of heteroatom substituents, the connectivity numbers of equation (5) are obviously inappropriate.

Similar studies on a smaller set of germanium derivatives were also used to derive  $\Delta R$  values, based on Ge  $3d$  ESCA and LMM Auger measurements.<sup>9,10</sup> Again, a satisfactory correlation is obtained between the experimental and calculated [equation (3)] values (Table 3, set 4).

**N 1s ESCA Measurements.**—It has previously been demonstrated that the charge values derived from the PEOE method correlate with C 1s ESCA binding energies with a precision better than *ab initio* MO (STO-3G) charge values.<sup>2</sup> These correlations are consistent with the simple atomic charge potential model for core-electron emission of Siegbahn *et al.*<sup>11</sup> In extending these studies, we investigated the N 1s ESCA shifts of nitrogen derivatives amongst which a substantial number of alkylamines have been measured.<sup>12</sup>

Charge values on nitrogen,  $q_N$ , obtained by the PEOE procedure are shown plotted against the chemical shifts (relative to  $\text{N}_2$ ) of the nitrogen derivatives in Figure 5(a). Consistent with our earlier experiences with C 1s ESCA data<sup>2</sup> a good overall correlation is obtained using just the charge parameter (Table 3, set 5). Thus, the simple charge-potential model appears, at first sight, to be appropriate. It is noticeable, however, that there is a systematic deviation for the alkylamines in that they follow a trend opposite to that defined by the broad range of substituents. On the basis of the simple charge-potential model, this is not surprising since the PEOE procedure calculates that successive alkyl group substitution of  $\text{NH}_3$  leads to a decrease in electron density on the nitrogen atom. This result is of course inconsistent with the corresponding order of N 1s ESCA shifts of the alkylamines. It is, however, in full accord with results of MO and other calculations of various degrees of sophistication, which also predict that the methyl group withdraws electron density from the nitrogen atom of alkylamines.<sup>13</sup>

The charge-only model makes no allowance for relaxation effects, but it is just such behaviour that would be anticipated to account for the stabilising effects of alkyl groups, as already shown for the organochlorine study, above. Thus, during the

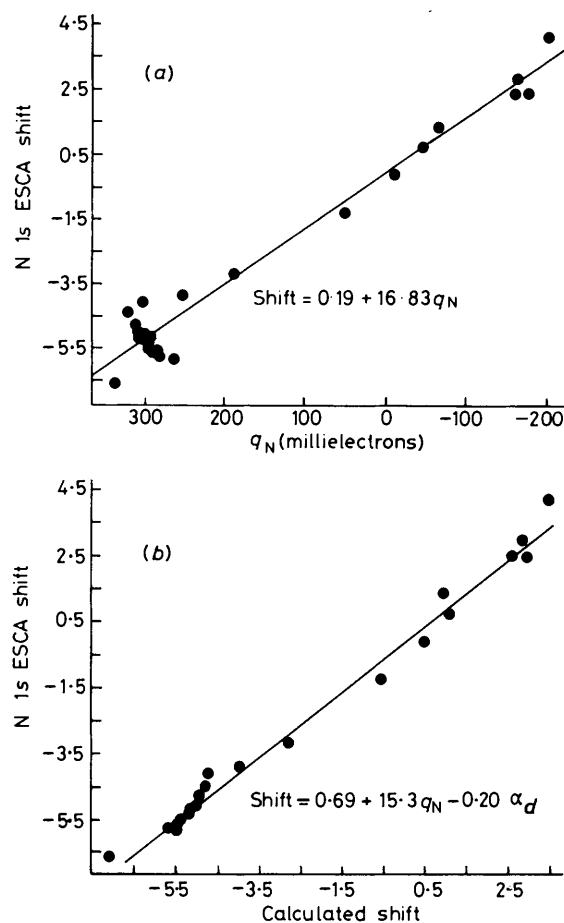

**Figure 5.** Correlation for N 1s ESCA shifts (relative to  $\text{N}_2$ ). (a) Function of charge on N,  $q_N$ , only; and (b) function of charge on N and effective polarisability,  $\alpha_d$

N 1s core electron ejection event of an alkylamine, electron reorganisation, or relaxation, occurs so as to stabilise the developing positive charge. The degree of relaxation is dependent on the relative polarisability of the substituents, where more easily polarisable groups provide greater stabilisation than less polarisable ones.

Use of  $\alpha_d$  values for each molecule along with the charge values  $q_N$  in a multilinear regression analysis led to a dual parameter expression (Table 3, set 6). A glance at the correlation [Figure 5(b)] shows the improvement to be striking. The extra parameter suffices to bring the alkylamine trend into correspondence with the other molecules of the series without particularly perturbing the overall trend, and leads to excellent agreement with experiment.

The suggestion that polarisability reflects stabilisation due to relaxation is not original (see for example ref. 14). However, we believe the quantitative polarisability models we have introduced are sufficiently novel, and moreover simple to apply, that the approach described in this paper offers new possibilities for prediction and interpretation in the field of ESCA spectroscopy. As justification for this claim, we have calculated the N 1s ESCA shifts for two amines whose recent data are not included in the compilation of ref. 12. For quinuclidine, a shift of  $-4.90$  eV is derived from the correlation equation of Figure 5(a) whereas that of Figure 5(b) leads to a value of  $-5.62$  eV, in much better agreement with the experimental shift of  $-5.50$  eV.<sup>15</sup> For 1,4-diazabicyclo-octane

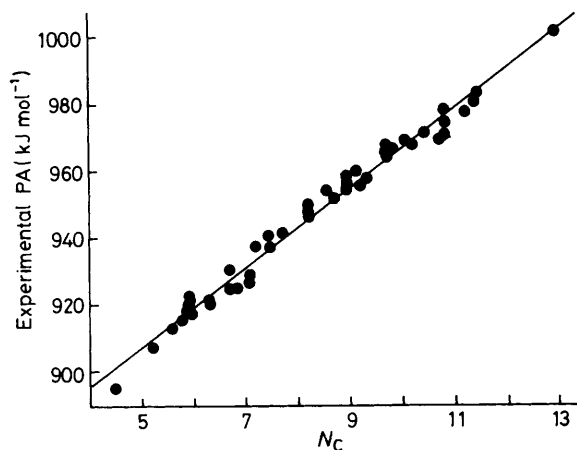
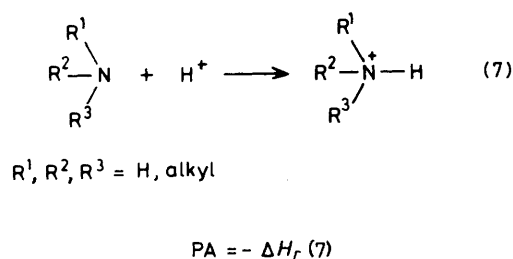

Figure 6. Correlation of proton affinities (PA) of unsubstituted alkyl amines with connectivity number  $N_c$ , calculated with equation (5), starting from the nitrogen atom. PA =  $846.7 + 12.03 N_c$

(DABCO), the corresponding values are  $-4.84$  [Figure 5(a)],  $-5.54$  [Figure 5(b)], and  $-5.26$  eV (experimental<sup>15</sup>).

**Alkylamine Gas-phase Proton Affinity.**—The preceding discussions have concerned physical data on systems where a positive charge is induced through photoionisation. Positive charge can also be introduced into a molecule by protonation and it is such reactions of alkylamines in the gas phase that we consider next [equation (7)]. The proton affinity (PA) of the amine is defined as the negative of the heat of reaction, and many accurate data exist for such reactions, derived mainly from ion cyclotron resonance and high pressure mass spectrometry studies.<sup>3a</sup>

In attempting to minimise coulombic effects (inductive-field effects) due to heterosubstitution in the alkyl substituent, we restricted this study to simple alkylamines. Thus, it is believed that polarisability effects will play the major part in determining the relative ease of stabilisation of the protonated amine.<sup>3</sup> PA data on 49 such alkylamines were collected from the literature<sup>3a,16</sup> and subjected to correlation analyses against the calculated effective polarisability values from equations (3) and (5). In both cases good correlations were obtained [Table 3, sets 7 and 8, Figure 6, equation (8)].

$$PA \text{ (kJ mol}^{-1}\text{)} = 846.7 + 12.03 N_c \quad (8)$$

Previously, equation (1) itself was used for calculating the differences in PA of alkylamines,<sup>17</sup> but the results were only roughly in accord with observation. In addition, the study included only four homologous, primary alkylamines. In the current study, however, amines of a variety of structural types and degrees of substitution (primary, secondary, and tertiary) are included in the analysis, as exemplified by the molecules given in Figure 7.

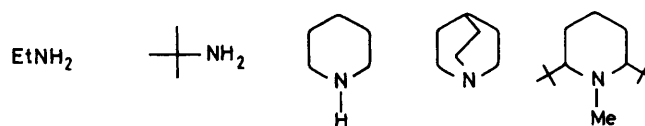

PA (experiment)	906.7	926.8	944.8	967.8	1003.7
PA [equation(8)]	909.9	927.9	939.9	965.5	1003.1

Figure 7. Amines used in present study with PA differences (kJ mol<sup>-1</sup>)

Thus, through simple procedures for calculating effective polarisability, the PA of unsubstituted alkylamines can be calculated with an accuracy close to experimental error. Again, use of mean molecular polarisability values are totally inadequate in correlations with the experimental data.

## Conclusions

The fact that good agreement is obtained between experimental data and the calculated values for effective polarisability leads us to conclude that our models are indeed describing the phenomena for which they have been devised. Values obtained from the models reported in this paper are being found useful, in conjunction with procedures for describing inductive-field effects, for reproducing chemical reactivity data.<sup>18</sup>

Our objective is to develop simple models that account quantitatively for physical organic chemical effects, and that can then be incorporated into the synthesis and reaction design computer program EROS.<sup>1</sup> The models of effective polarisability discussed in this paper comprise a part of that objective.

However, as these models describe an electronic effect operating in molecules they have applications beyond reactivity studies. We believe that the effective polarisabilities describe not only electronic relaxation on introducing charges into molecules but also on binding molecules to receptors. Thus, we are presently studying the use of effective polarisabilities for deriving quantitative relationships between molecular structure and biological activity.

## Acknowledgements

Support of this work by I.C.I., Organics Division is gratefully acknowledged. Computer time was provided by Leibniz Rechenzentrum, München. We thank B. Christoph and K. Hartl for programming assistance.

## References

- J. Gasteiger and C. Jochum, *Top. Curr. Chem.*, 1978, **74**, 93.
- J. Gasteiger and M. Marsili, *Tetrahedron*, 1980, **36**, 3219.
- (a) D. H. Aue and M. T. Bowers, in 'Gas Phase Ion Chemistry,' ed. M. T. Bowers, Academic Press, New York, 1979, vol. 2, p. 1; (b) J. E. Bartmess and R. T. McIver, Jr., *ibid.*, p. 87.
- F. G. Bordwell, G. E. Drucker, and G. J. McCollum, *J. Org. Chem.*, 1982, **47**, 2504; J. F. Wolf, J. L. M. Abboud, and R. W. Taft, *ibid.*, 1977, **42**, 3316.
- R. J. W. Le Fèvre, *Adv. Phys. Org. Chem.*, 1965, **3**, 1.
- K. J. Miller and J. A. Savchik, *J. Am. Chem. Soc.*, 1979, **101**, 7206.
- Y. K. Kang and M. S. Jhon, *Theor. Chim. Acta*, 1982, **61**, 41.
- For a preliminary communication see J. Gasteiger and M. G. Hutchings, *Tetrahedron Lett.*, 1983, **24**, 2537.

- 9 E. J. Aitken, M. K. Bahl, K. D. Bomben, J. K. Gimzewski, G. S. Nolan, and T. D. Thomas, *J. Am. Chem. Soc.*, 1980, **102**, 4873.
- 10 W. D. Perry and W. L. Jolly, *Chem. Phys. Lett.*, 1973, **23**, 529.
- 11 K. Siegbahn, C. Nordling, A. Fahlman, R. Nordberg, K. Hamrin, J. Hedman, G. Johansson, T. Bergmark, S.-E. Karlsson, I. Lindgren, and B. Lindberg, 'ESCA: Atomic, Molecular and Solid State Structure Studied by Means of Electron Spectroscopy,' Almqvist and Wiksells, Uppsala, Sweden, 1967.
- 12 A. A. Bakke, H.-W. Chen, and W. L. Jolly, *J. Electron Spectrosc. Relat. Phenom.*, 1980, **20**, 333.
- 13 H. Umeyama and K. Morokuma, *J. Am. Chem. Soc.*, 1976, **98**, 4400; R. Bonaccorsi and P. Brochen, *Chem. Phys. Lett.*, 1975, **34**, 7; L. Radom, *Aust. J. Chem.*, 1975, **78**, 1; V. V. Zverev, L. L. Ermolaev, and Y. P. Kitaev, *Izv. Akad. Nauk SSSR, Ser. Khim., Engl. Edn.*, 1977, 943; W. L. Jolly and W. B. Perry, *Inorg. Chem.*, 1974, **13**, 2686; *J. Am. Chem. Soc.*, 1973, **95**, 5442; D. W. Davis, M. S. Banna, and D. A. Shirley, *J. Chem. Phys.*, 1974, **60**, 237.
- 14 R. L. Martin and D. A. Shirley, *J. Am. Chem. Soc.*, 1974, **96**, 5299; D. W. Davis and J. W. Rabalais, *ibid.*, 1974, **96**, 5305.
- 15 R. S. Brown and A. Tse, *J. Am. Chem. Soc.*, 1980, **102**, 5222.
- 16 K. N. Hartman, S. Lias, P. Ausloos, H. M. Rosenstock, S. S. Schroyer, C. Schmidt, D. Martinsen, and G. W. A. Milne, 'A Compendium of Gas Phase Basicity and Proton Affinity Measurements,' NBSIR 79-1777, U.S. Department of Commerce, National Bureau of Standards, Washington, DC, 1979; J. C. Day, *J. Am. Chem. Soc.*, 1981, **103**, 7355.
- 17 D. H. Aue, H. M. Webb, and M. T. Bowers, *J. Am. Chem. Soc.*, 1976, **98**, 311.
- 18 M. G. Hutchings and J. Gasteiger, *Tetrahedron Lett.*, 1983, **24**, 2541.

Received 13th June 1983; Paper 3/983