

Synthesis and non-linear optical properties of (*N*-alkylpyrrol-2-yl)squaraine derivatives. Part 2 †



Daniel E. Lynch,^{*,a} Ian R. Peterson,^a Mathias Floersheimer,^b Dominik Essing,^b Li-feng Chi,^b Harald Fuchs,^b Nicholas J. Calos,^{c,d} Barry Wood,^{c,e} Colin H. L. Kennard^c and G. John Langley^f

^a School of Natural and Environmental Sciences, Coventry University, Coventry, UK CV1 5FB

^b Physikalisches Institut, Universität Münster, Wilhelm-Klemm-Strasse 10, 48149 Münster, Germany

^c Department of Chemistry, The University of Queensland, Brisbane Q4072, Australia

^d Centre for Microscopy and Microanalysis, The University of Queensland, Brisbane Q4072, Australia

^e Brisbane Surface Analysis Facility, The University of Queensland, Brisbane Q4072, Australia

^f Department of Chemistry, University of Southampton, Southampton, UK SO17 1BJ

Two squaraine dyes, bis(5-ethyl-1-octadecylpyrrol-2-yl)squaraine (Et-Py) and bis(3,5-dimethyl-4-ethyl-1-octadecylpyrrol-2-yl)squaraine (MeEt-Py) have been synthesised and studied as Langmuir–Blodgett (LB) monolayers using atomic force microscopy (AFM), angle dependent X-ray photoelectron spectroscopy (ADXPS) and grazing incidence X-ray diffraction (GIXD). Additional investigations include both their linear and second-order non-linear optical properties, the latter giving $d_{\text{eff}} = 1.5 \pm 0.2 \text{ pm V}^{-1}$ for Et-Py and $1.1 \pm 0.2 \text{ pm V}^{-1}$ for MeEt-Py. Comparisons with the previously reported dyes, bis(1-octadecylpyrrol-2-yl)squaraine (Py) and bis(3,5-dimethyl-1-octadecylpyrrol-2-yl)squaraine (Me-Py) reveal that Me-Py is the only one of the four which deposits as ordered, densely packed LB films which allows further studies on Me-Py so as to ascertain a valid mechanism for the occurrence of second harmonic generation (SHG) in these centrosymmetric molecules. The results presented demonstrate that the experimentally observed SHG in squaraines arises from a surface induced orientational effect where higher SHG is achieved if the squaraine head-group is essentially perpendicular to the required hydrophilic substrate.

Introduction

With the exception of fluorescence studies on bis(4-acetyl-3,5-dimethylpyrrol-2-yl)squaraine (AcMe-Py),^{1,2} very little has been known about the electro-optic properties of bis(pyrrol-2-yl)squaraines. ‡ This is probably due to the fact that their absorption maxima are below 600 nm and they have been overlooked in favour of other squaraine analogues such as the anilino, indolinium and benzothiazolium series which exhibit absorption maxima from 630 to >700 nm, and are therefore more useful for xerographic purposes.³ However, one synthetic advantage in condensing pyrrole derivatives with squaric acid is that poly(pyrrol-2-yl)squaraine compounds can easily be produced,⁴ if both α -Hs on the pyrrole ring are free. Polymer derivatives of the indolinium and benzothiazolium moieties are possible,⁵ and have been studied for electrical conductivity, but electrically active poly(anilinosquaraine) compounds are proving harder to achieve.^{6,7}

In our previous study⁸ we reported the thin film non-linear optical (NLO) characteristics of two bis(pyrrolyl)squaraine derivatives and one poly(pyrrolylsquaraine) derivative. Of the two bis(pyrrolyl)squaraine compounds; bis(3,5-dimethyl-1-octadecylpyrrol-2-yl)squaraine (Me-Py) was found to form ordered films when deposited using the Langmuir–Blodgett (LB) technique, whereas bis(1-octadecylpyrrol-2-yl)squaraine (Py) exists as an aggregated mixture of 1,2- and 1,3-squarates which subsequently do not form ordered films. Instead, Py formed randomly convoluted films with the squarate head group disordered throughout. These results indicated that substituents were required on the pyrrole rings so that not only

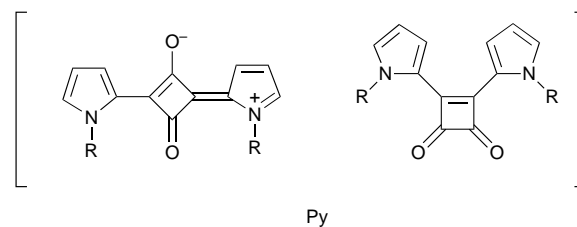
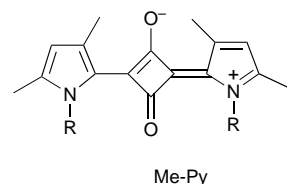

Where R = C₁₈H₃₇

pure 1,3-squarates were formed but also ordered LB films were attained. For these reasons we decided to complete the series by using single and triple ring-substituted pyrroles. Therefore bis(5-ethyl-1-octadecylpyrrol-2-yl)squaraine (Et-Py) and bis(3,5-dimethyl-4-ethyl-1-octadecylpyrrol-2-yl)squaraine (MeEt-Py) were synthesised and their thin film NLO characteristics studied.

In this, the second paper in our series on (*N*-alkylpyrrolyl)squaraines, we report the synthesis, fluorescence and second-order NLO properties of bis(5-ethyl-1-octadecylpyrrol-2-yl)squaraine and bis(3,5-dimethyl-4-ethyl-1-octadecylpyrrol-2-yl)squaraine. We also draw together the results of our first paper with the results presented here to propose a plausible mechanism as to why these centrosymmetric dyes exhibit second harmonic generation (SHG).

† Part 1. *J. Chem. Soc., Perkin Trans. 2*, 1997, 827.

‡ IUPAC name for the resonance form shown on the structure of Me-Py for unsubstituted bis(pyrrol-2-yl)squaraine is 3-oxo-4-(2H-pyrrolium-2-ylidene)-2-(1H-pyrrol-2-yl)cyclobut-1-en-1-olate.

Table 1 Absorption maxima (λ_{\max}), fluorescence maxima (λ_{em}) and oscillator strengths (f) for the four substituted bis(pyrrolyl)squaraines

Dye	λ_{\max}/nm	$\lambda_{\text{em}}/\text{nm}$	f
Py	548.5		0.85
Et-Py	562	587	0.69
Me-Py	579	650	1.20
MeEt-Py	590		1.19

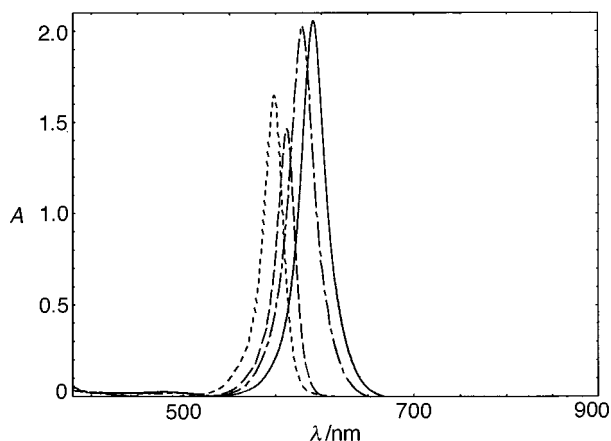
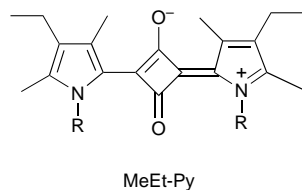
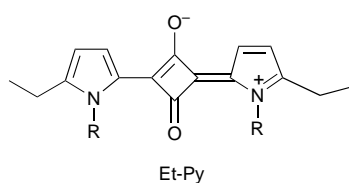

Fig. 1 Visible absorption spectra of Py (----), Et-Py (---), Me-Py (-.-) and MeEt-Py (—) (1×10^{-5} M) in chloroform



where R = C₁₈H₃₇

Results and discussion

Absorption spectra

Fig. 1 shows the comparative visible absorption spectra for all four bis(1-octadecylpyrrolyl)squaraines studied, including Et-Py and MeEt-Py, in chloroform. Additional comparative spectroscopy results, including oscillator strengths (f), for all four compounds are listed in Table 1 and show the increase in absorption maxima with increased pyrrole substitution. In the case of AcMe-Py, which has an attached electron withdrawing group, the absorption maximum is lower [$\lambda_{\max}(\text{CH}_2\text{Cl}_2)$ at 568 nm] compared to MeEt-Py. However, the most notable difference between the dyes studied is shown in Fig. 2 which displays their fluorescence spectra. Et-Py has an emission maximum at 587 nm in chloroform (a shift of 25 nm) while Me-Py has a less intense maximum at ca. 650 nm, but neither Py nor MeEt-Py fluoresce. For comparison, AcMe-Py fluoresces with $\lambda_{\text{em}}(\text{CH}_2\text{Cl}_2)$ at 586 nm.

It should be noted that the absorption spectrum shown for Py (in Fig. 1) is much more intense than that published in our previous paper for the same concentration. We have found that the ring-unsubstituted bis(pyrrol-2-yl)squaraines, over a period of months, undergo further chemical reactions, which precipitate

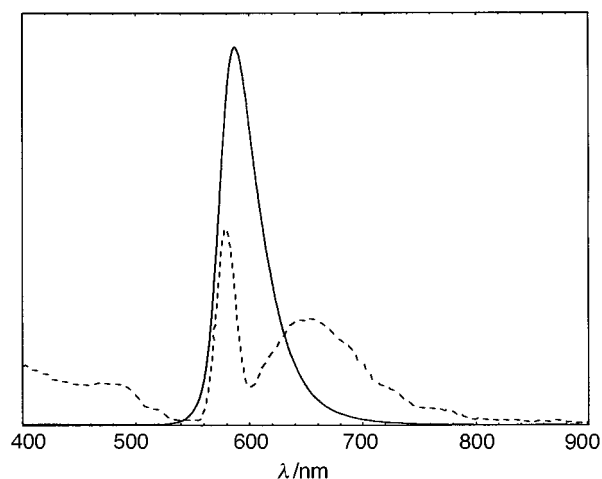
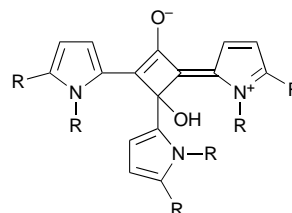

Fig. 2 Fluorescence spectra of Et-Py (—) and Me-Py ($I_{\text{em}} \times 100$) (----) in chloroform. Excitation wavelengths at 562 and 579 nm respectively and using the same concentrations as for absorption spectra. I_{em} = emission intensity.

a dark solid. The dyes therefore need to be used soon after synthesis. The spectrum of Py in Fig. 1 was taken immediately after repurifying the material using the same chromatographic techniques as initially employed soon after the original synthesis. We have observed this change in several compounds of this type and it is suspected that, without the presence of any additional squaric acid, these dyes form complexes and other analogues similar to those already reported⁴ when another molar equivalent of a 2*H*-pyrrole is condensed with a bis(pyrrol-2-yl)squaraine, as shown here. Further cross-linked polymerisation can occur when both α -Hs are free as in our



bis(pyrrolyl)squaraines, producing the observed insoluble material. Care must also be taken when synthesising bis(pyrrolyl)squaraines because an intense colouration is quickly evident yet the collected product may still be predominantly the starting alkylpyrrole, if the reaction is not allowed to proceed for the required time. In this respect, ¹H NMR spectroscopy is an important analytical technique because in the desired squaraine the pyrrole ring is connected to an electron-withdrawing group so that the resultant shifts for both the pyrrole hydrogens and the NCH₂ protons will be downfield.

Bis(5-ethyl-1-octadecylpyrrol-2-yl)squaraine

The surface pressure–area isotherm (π - A curve) for Et-Py (Fig. 3) shows that this material has a lift-off area on the water surface of $\geq 97 \text{ \AA}^2 \text{ mol}^{-1}$. This compares with areas of ca. $20 \text{ \AA}^2 \text{ mol}^{-1}$ for Me-Py and $59.5 \text{ \AA}^2 \text{ mol}^{-1}$ for bis[4-(*N*-methyl-*N*-octadecylamino)phenyl]squaraine.⁹ The isotherm for Et-Py also shows two distinct phases with an inflection just above a surface pressure of 20 mN m^{-1} . Both phases have been studied with monolayer films being deposited at 15, 30 and 35 mN m^{-1} . The visible absorption spectra for monolayers of Et-Py deposited at pressures of 15 and 35 mN m^{-1} are shown in Fig. 4. For Me-Py a colour change in the monolayer was observed from red–violet to purple–blue as the films dried after deposition; no such change was evident with Et-Py. This material was both spread and deposited as a bright red–violet film.

Atomic force microscopy (AFM) studies on monolayers of Et-Py deposited at 15 mN m^{-1} showed the films to consist of two co-existing phases with slightly different heights. The films were also pitted with a thin covering of disordered material across the bottoms of the holes. The height difference between the holes and the film surface was found to be *ca.* $1.1 \pm 0.2 \text{ nm}$. A value for the thickness of the disordered material at the bottom of the holes was unobtainable and consequently the total film thickness for these layers must be slightly greater than the above value. In contrast, monolayers deposited at 35 mN m^{-1} had almost no holes, a uniform height and a large number of aggregates and islands on top of them. The most frequent height of the islands was 3.3 nm . These results show that uniform monolayers of Et-Py will be hard to achieve and may require mixed films containing long chain fatty acids, as with bis(*N*-octadecylindolinio)squaraine which requires up to 1:10 dye–stearic acid mixtures to obtain uniform layers.¹⁰

Similar to our previous study, the model used for angle dependent X-ray photoelectron spectroscopy (ADXPS) depth

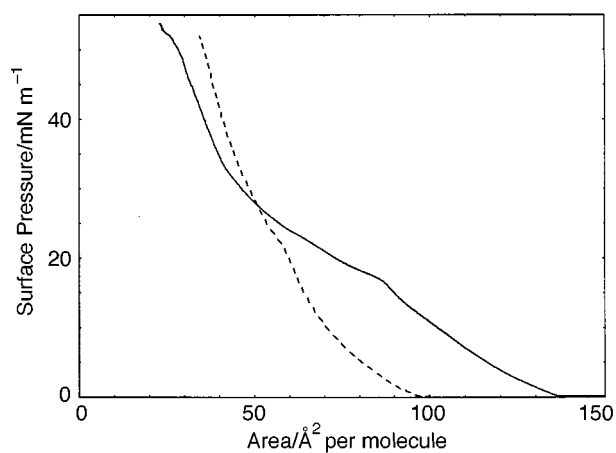

Fig. 3 π - A isotherm for Et-Py (---) and MeEt-Py (—)

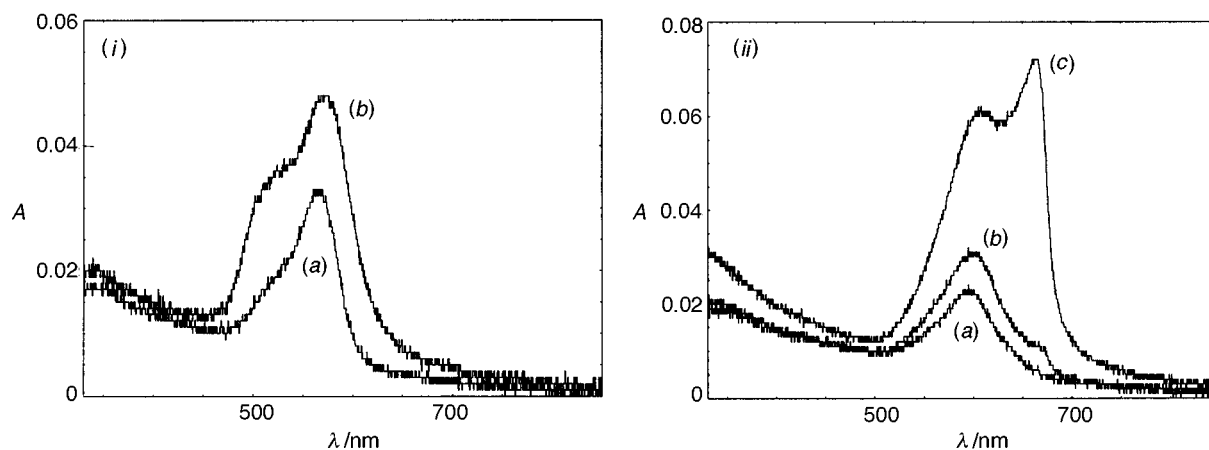

Fig. 4 Visible absorption spectra for monolayers of (i) Et-Py deposited both sides of a glass slide at (a) 15, (b) 35 and (ii) MeEt-Py deposited analogously at (a) 15, (b) 20 and (c) 30 mN m^{-1}

Table 2 ADXPS determined thicknesses and second-order non-linear optical susceptibilities for Et-Py and MeEt-Py

Dye	Depositional pressure/ mN m^{-1}	Thickness/ \AA				
		$-\text{CH}_2-$	Head group	SiO_2	$d_{\text{yzz}}/\text{pm V}^{-1}$	$d_{\text{eff}}/\text{pm V}^{-1}$
Et-Py	15	4.5 ± 1.0	6.5 ± 1.0	19.5 ± 2.0	1.5 ± 0.2	1.4 ± 0.2
	30	10.5 ± 0.5	15.5 ± 0.5	19.0 ± 0.5		
	35	0.4 ± 0.4	27.5 ± 0.5	20.0 ± 1.0		
MeEt-Py	15	7.5 ± 0.5	5.0 ± 1.0	19.5 ± 1.0	1.1 ± 0.2	1.1 ± 0.2
	20	16.5 ± 0.5	4.5 ± 0.5	19.0 ± 0.5	0.53 ± 0.2	0.53 ± 0.2
	30	10.0 ± 0.4	11.0 ± 0.5	20.0 ± 1.0		

profiling consisted of four layers: (a) the alkyl $-\text{CH}_2-$ chain, (b) the nitrogenous aromatic head group, (c) native oxide substrate and (d) elemental silicon. ADXPS results for dye Et-Py are listed in Table 2. Depth profiles were recorded at two pressures in the second phase so as to gain better insight into how the molecules were arranged in this phase. The increasing aromatic underlayer relative to the alkyl top layer implies molecular layering as the aromatic groups are pushed up but the decreasing alkyl overlayer suggests that the top-most molecules are lying essentially parallel to the substrate. Typical thicknesses for octadecyl chains range from *ca.* 19.5 \AA (in octadecyl tetrasulfide)¹¹ to *ca.* 24 \AA (in methyl stearate).¹² The thickness of $19\text{--}20 \text{ \AA}$ for the native oxide, as opposed to the expected 16 \AA ,^{13,14} was confirmed using argon ion etch depth profiling of the silicon wafer, monitored with Auger spectroscopy. An oxide thickness of $16.7 \pm 3.1 \text{ \AA}$ was found. Grazing incidence X-ray diffraction (GIXD) results for Et-Py at 15 mN m^{-1} are consistent with a thin, sparse and disordered monolayer. In contrast, the film at 35 mN m^{-1} is somewhat thicker and more densely packed and highly structured, such that the alkyl chains are tilted toward the surface normal. The intensity in q_z (normal to the wafer) indicates a film thickness of $30.1 \pm 0.8 \text{ \AA}$, as compared to the total thickness by ADXPS of $27.9 \pm 0.9 \text{ \AA}$ and the AFM thickness of 3.3 nm . The diffuse diffraction at $4.27 \pm 0.04 \text{ \AA}$ (d spacing), at $10 \pm 2^\circ$ from the horizontal is attributed to the closest packing of the alkyl chains. The shortest cell dimension of *n*-icosane, for instance, is 4.293 \AA ,¹⁵ corresponding to the linear stacks of $-\text{CH}_2-$ chains. These tail groups are tilted at only 10° to the surface normal.

Differential scanning calorimetry (DSC) results for Et-Py show that this material melts from $89\text{--}104^\circ \text{C}$ and has no initial exothermic phase change as seen in the DSC results for Me-Py.¹

Bis(3,5-dimethyl-4-ethyl-1-octadecylpyrrol-2-yl)squaraine

The surface pressure–area isotherm (π - A curve) for MeEt-Py is given in Fig. 3. The lift-off area at which significant surface

pressure starts to be developed is *ca.* $137 \text{ \AA}^2 \text{ mol}^{-1}$. Although the shape of the curve appears similar to that of Et-Py there are three distinct phases with the first major inflection occurring just above a surface pressure of 18 mN m^{-1} and the second lesser change around 23 mN m^{-1} . Like Et-Py, but unlike Me-Py, the spread and deposited monolayers of MeEt-Py had the same colour. The visible absorption spectra for monolayers of MeEt-Py deposited at 15, 20 and 30 mN m^{-1} are also shown in Fig. 4.

ADXPS results for MeEt-Py are listed in Table 2 and indicate that this material is different to Et-Py when compressed and deposited as a LB film. Films deposited at 15 mN m^{-1} are sparsely packed with an alkyl chain thickness of $7.5 \pm 0.5 \text{ \AA}$ indicating that the long alkyl tails are lying inclined to the substrate surface. However, films deposited at 20 mN m^{-1} display thicknesses similar to LB films of Me-Py except that for MeEt-Py the alkyl chain thickness is less, $16.5 \pm 0.5 \text{ \AA}$ (*cf.* 19 \AA for Me-Py) indicating that the chains are inclined to a greater degree from the surface normal, compared with those for Me-Py. ADXPS results for the third phase show that films deposited at 30 mN m^{-1} have collapsed with a thicker head group depth and a reduced alkyl thickness.

Differential scanning calorimetry (DSC) results for MeEt-Py show that this material melts slowly from $45\text{--}74 \text{ }^\circ\text{C}$. The mass spectroscopy results for Py, Et-Py, Me-Py and MeEt-Py all display $(2M + H)^+$, and for the first three $(2M + Na)^+$, peaks in their electrospray (ES) spectra. In concentrated solutions many organic compounds display at least a $(2M + H)^+$ peak but all the ES spectra for this series were run using $10 \mu\text{l}$ injections of *ca.* $1\text{--}10 \mu\text{g ml}^{-1}$ solutions. The observation of 2M species at such low concentrations suggests that the specific intermolecular interactions between these squaraine dyes are unusually strong. Such peaks have also been observed in the ES spectra for bis[4-(*N*-methyl-*N*-octadecylamino)phenyl]squaraine and bis(*N*-octadecylindolinio)squaraine. More detailed electrospray results for bis(anilino)squaraines have been recently reported by Langley *et al.*¹⁶

Second harmonic generation

Experiments to determine the second-order susceptibilities of Et-Py and MeEt-Py were undertaken as previously described.⁸ Interestingly, the measured SHG intensities for freshly deposited films of Et-Py at surface pressures of 15 and 30 mN m^{-1} were essentially identical. For the calculation of χ^2 thicknesses of 1.1 nm for Et-Py and 1.25 and 2.10 nm for MeEt-Py were used, and it was assumed that the optical non-linearity in this system was due to the electric-dipole interaction of the radiation with matter. This gave the χ^2 values for Et-Py and MeEt-Py which are listed in Table 2. The coordinate system used to describe each sample was chosen such that the *y* axis corresponded to the surface normal and d_{eff} was given for an experimental geometry where plane-polarised light impinged on the film at an angle of 45° and plane-polarised second harmonic light was measured. The symmetry of the films was again found to be C_{2v} .

In a series of related experiments we have found that short alkyl chain analogues of these dyes can be thermally evaporated and form smooth thin films (as shown by preliminary AFM studies). This is most likely related to the planarity of the squaraine head group. Evaporated films on hydrophilic glass substrates also exhibit SHG but not as much as their LB counterparts. Evaporated films of 2,4-bis[4-(*N,N*-dimethylamino)phenyl]cyclobutene-3,4-bis(ylium)-1,3-diolate give *ca.* 5% SHG intensity of LB deposited films of 2,4-bis[4-(*N*-hexyl-*N*-methylamino)phenyl]cyclobutene-3,4-bis(ylium)-1,3-diolate, while evaporated films of bis(3,5-dimethyl-1*H*-pyrrol-2-yl)squaraine give *ca.* 7% SHG intensity of Me-Py. In both cases evaporated films of thicknesses $<5 \text{ nm}$ to *ca.* $0.1 \mu\text{m}$ [determined by small angle X-ray reflectometry (SAXR) methods] exhibit approximately equal SHG intensities, including films built up over a number of evaporations. Furthermore, the experi-

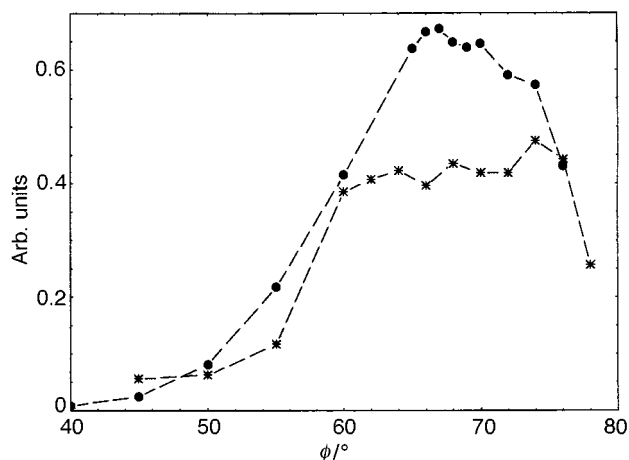

Fig. 5 Plot of SHG intensity versus incidence angle (ϕ) for an LB deposited monolayer of Me-Py at 35 mN m^{-1} (●—●) and a thermally evaporated thin film of bis(3,5-dimethyl-1*H*-pyrrol-2-yl)squaraine (*—*) (Intensity $\times 10$) both deposited on hydrophilic (111)-cut silicon wafers

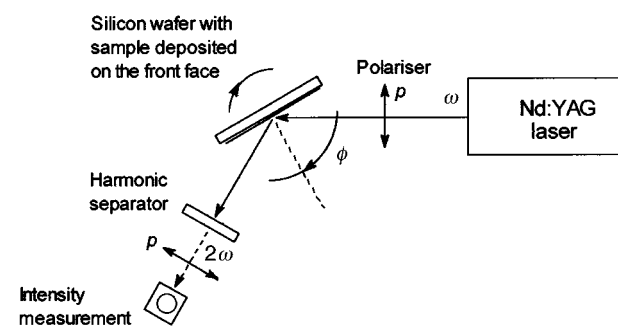

Fig. 6 Experimental geometry used for the collection of angle dependent data plotted in Fig. 5

mentally determined direction of the electric dipole is inclined to the substrate normal. Fig. 5 is a plot of the reflected SHG intensity as a function of incidence angle (experimental configuration shown in Fig. 6) and in both cases the strongest SHG intensity is observed at high incidence angles.

Mechanism for SHG

Two recent articles have proposed a mechanism for SHG in squaraines,^{17,18} involving a charge-transfer interaction in an acentric dimer. Considering that the types of two-legged squaraine dyes which have been studied both here and in other publications⁹ orientate on the substrate surface with the long axis of the squaraine moiety parallel to the substrate then according to this mechanism the direction of the induced dipole should also lie parallel to the substrate. Furthermore, supposed proof of this 'T' interaction lies in the X-ray crystal structure of 2,4-bis[4-(*N,N*-dibutylamino)phenyl]cyclobutene-3,4-bis(ylium)-1,3-diolate (BSQ).¹⁹ However, as it has been shown in the structure of 2-[4-(*N,N*-dibutylamino)-2-hydroxyphenyl]-4-[4-(*N,N*-dibutylamino)phenyl]cyclobutene-3,4-bis(ylium)-1,3-diolate (BHSQ),²⁰ which is isomorphous to BSQ, no interaction of the type described occurs. Instead, molecules associate through hydrogen-bonding interactions in both structures. Additionally, the current mechanism does not account for the fact that only monolayers deposited on hydrophilic substrates exhibit any SHG; subsequent layers make no further contribution to the bulk susceptibilities. Nor does this mechanism explain the origin of SHG in polysquaraines.

The thermal evaporation results rule out the magnetic-dipole SHG mechanism found, for example, in the iron phthalocyanines in which no preferred molecular orientation is required. Studies of evaporation deposited films of these

materials found that SHG could be enhanced with the build-up of thicker films.²¹ It can be concluded that, as in the majority of D- π -A (donor- π -acceptor) intramolecular charge-transfer dyes, the present squaraines require some directional order for non-linear optical activity. A comparison of the SHG values from both LB deposited material and evaporated material is of interest because of the expected differences of this order. Two-legged squaraines will deposit with the head-group approximately perpendicular to the substrate but for the evaporated material the head-group would deposit essentially parallel to the surface. Thus far, both symmetrical two-legged (S-2L) and four-legged squaraine dyes (S-4L) have been studied for

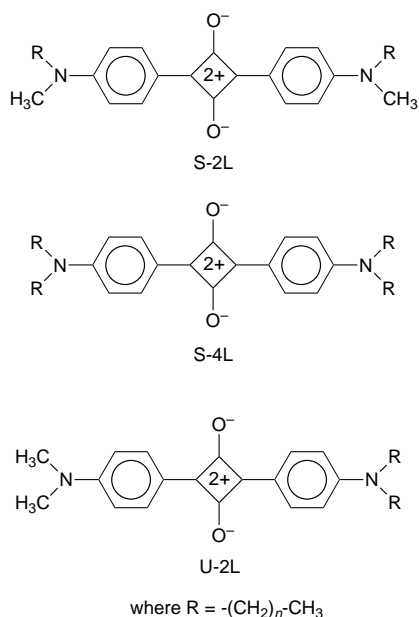

SHG.^{8,19,22} Four-legged dyes are known to deposit with the squaraine moiety essentially parallel to the surface.⁹ Interestingly, both LB films {including poly[(1-octadecylpyrrolyl)squaraine]} and evaporated films of squaraines which align in this manner have lower SHG intensities than their two-legged, LB deposited counterparts. Unsymmetrical two-legged squaraines (U-2L) have not yet been studied for SHG.

An idea of the relative SHG efficiency of LB deposited bis(pyrrolyl)squaraines can be gained from a comparison of their oscillator strengths with that of a traditional NLO material, such as (*E*)-4-[4-(*N,N*-dimethylamino)styryl]-*N*-docosylpyridinium bromide (HEMI). The two-state model²³ yields a

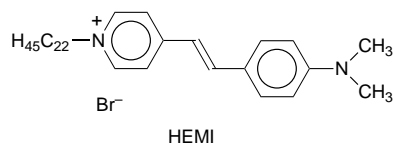

value of hyperpolarisability (β) which has three functionally distinct factors: firstly, an energy-dependent term which is expected to be comparable for materials used in similar applications; secondly, a quantum-geometric factor ($\Delta\mu$); and thirdly, the oscillator strength (f). As a result of their near-symmetry, squaraines are not expected to show favourable values of $\Delta\mu$ but it is plausible that this may be compensated by larger values of f . HEMI has an oscillator strength of 0.46 and LB monolayers of this material exhibit second-order susceptibilities of *ca.* 100 pm V⁻¹.²⁴ This compares to the four squaraines presented in this series which have oscillator strengths approximately twice that of HEMI but exhibit susceptibilities two orders of magnitude less. These results would indicate that either the molecular contribution to the dipole from every molecule is weak or that only a small number of molecules (*ca.* 1 in 500), with large hyperpolarisabilities, are actually contributing

to the effect. The χ^2 values stated for these squaraines could be improved if short alkyl chains were used hence producing thinner films, as in the case of 2,4-bis[4-(*N*-hexyl-*N*-methylamino)phenyl]cyclobutene-3,4-bis(ylium)-1,3-diolate which has a stated χ^2 value of 250 pm V⁻¹ based on a thickness of 4.6 Å.²² The measured SHG signal of Me-Py is *ca.* 70% the intensity of 2,4-bis[4-(*N*-hexyl-*N*-methylamino)phenyl]cyclobutene-3,4-bis(ylium)-1,3-diolate yet Me-Py has a reported χ^2 value of 2 pm V⁻¹.

Conclusions

The experimentally observed SHG in squaraines arises from a surface induced orientational effect. The results presented in this paper and our previous paper⁸ have shown that higher SHG intensity is achieved if the squaraine head-group is essentially perpendicular to the surface. However, it is currently unclear if there is any interaction between the hydrophilic surface and the squarate oxygen. In concurrent studies it has been shown that due to these oxygens, squaraines self-assemble around sodium ions.¹⁶ If the interaction between the surface hydroxy groups and the squarate oxygens gives rise to the molecular hyperpolarisability then head-groups aligned perpendicular to the surface would be preferred for strong SHG.

Experimental

General

IR spectra were recorded as pressed KBr disks on a Nicolet 205 FT-IR spectrometer. J values are given in Hz. UV-VIS measurements were made on a Unicam UV-4 UV-VIS spectrometer. Fluorescence measurements were made on a Perkin-Elmer luminescence spectrometer LS50. ¹H and ¹³C NMR spectra were recorded on a Bruker AC250 NMR spectrometer. Electrospray mass spectra were recorded in positive ion mode on a Micromass Platform mass spectrometer. Samples for differential scanning calorimetry were run on a Perkin-Elmer DSC 1B and heated at 8 °C min⁻¹ from 20–300 °C. Thermally evaporated films were prepared in a vacuum of 10⁻⁶ mbar using an Edwards 306 coating unit. SAXR patterns were recorded on a Philips PW1700 System diffractometer (Cu-K α X-radiation). AFM measurements were made on a Digital Instruments Nanoscope III. Images were obtained using both the tapping and contact modes while thicknesses were obtained using the contact mode with applied forces of *ca.* 10⁻⁸ N.

The electron spectrometer employed for ADXPS studies was a Physical Electronics Industries PHI Model 560 with a double-pass cylindrical mirror analyser, as in the previous study. A Mg anode soft X-ray source was used for excitation, and multiple sweeps of the 1s peaks of C, N and O and 2p of Si were measured at 87.7, 69.9, 51.5 and 34.5° to the surface normal. Escape depths for the photoelectrons calculated according to Ashley²⁵ were used to determine overlayer thicknesses by a derivation of the method of Marshbanks *et al.*²⁶ GIXD patterns were collected on the BIGDIF of the ANBF at BL20B of the Photon Factory, Tsukuba, Japan. The apparatus is described by Foran *et al.*²⁷ Sagittal focussed X-rays of wavelength 1.7389 Å were used, with an incident angle 0.18° and a flat-plate detector geometry. Intensities were extracted and analysed using the NIHIMAGE software package.

Surface pressure-area isotherms for Et-Py and MeEt-Py were run on a Nima Technology series 2000 Langmuir-Blodgett trough. Compounds Et-Py and MeEt-Py were spread from chloroform solutions (*ca.* 0.1 mg ml⁻¹) onto a pure water subphase of a custom-built Nima 'Münster' LB trough. LB monolayers were deposited on (a) mica for AFM studies, (b) both sides of a hydrophilic fused silica substrate and (c) hydrophilic (111)-cut silicon wafers for ADXPS and GIXD studies at compressed surface pressures of 15, 30 and 35 mN m⁻¹ for Et-Py and 15, 20 and 30 mN m⁻¹ for MeEt-Py on the upstroke

by passing the substrate through the floating monolayer at 25 mm min⁻¹. Frequency-doubling experiments were run using a Spectra Physics GCR 190/30 laser at a wavelength of 1064 nm and intensity of 1.5 MW cm⁻².

Syntheses

2-Ethyl-1-octadecylpyrrole was synthesised using the following procedure: a solution of 2-ethylpyrrole (1.0 g, 10.5 mmol) in dry toluene (25 cm³) was added under argon to a stirred suspension of potassium *tert*-butoxide (1.3 g, 11.6 mmol) and dibenzo-18-crown-6 (300 mg) in dry toluene (75 cm³). After 1 h, 1-bromooctadecane (3.3 g, 10 mmol) in dry toluene (25 cm³) was added and the resultant mixture refluxed for 12 h. Upon cooling, water (50 cm³) was added and the organic phase separated after which the aqueous phase was extracted three times with toluene (50 cm³). The combined organic phases were then washed three times with water and then dried using anhydrous magnesium sulfate. After removal of toluene the crude 2-ethyl-1-octadecylpyrrole was purified by column chromatography (Al₂O₃) using light petroleum (bp 40–60 °C) (yield 3.3 g, 95%). δ_{H} (250 MHz; CDCl₃; SiMe₄) 0.87 (3 H, t, *J* 7, CH₃), 1.18 (3 H, t, *J* 7, 2-CH₃), 1.26 (30 H, br s, CH₂), 1.69 (2 H, br m, NCH₂CH₂), 2.55 (2 H, quartet, *J* 7, 2-CH₂), 3.75 (2 H, t, *J* 7, NCH₂), 5.89 (1 H, m, 4-H), 6.06 (1 H, t, *J* 2, 3-H), 6.56 (2 H, t, *J* 2, 5-H).

Bis(5-ethyl-1-octadecylpyrrol-2-yl)squaraine (Et-Py) was synthesised by refluxing squaric acid (200 mg, 1.75 mmol) and 2-ethyl-1-octadecylpyrrole (1.2 g, 3.5 mmol) in ethanol (50 cm³) for 2 h and was purified by column chromatography (Al₂O₃) using incremented amounts of chloroform in light petroleum (bp 40–60 °C) (yield 610 mg, 45%) (Found: C, 81.0; H, 11.4; N, 3.6. C₅₂H₈₈N₂O₂ requires C, 80.8; H, 11.5; N, 3.6%; *M*, 772); ν_{max} /cm⁻¹ 1623 and 1609 (C–O); λ_{max} (CHCl₃)/nm 562; δ_{H} (250 MHz; CDCl₃; SiMe₄) 0.87 (6 H, t, *J* 7, CH₃), 1.25 (60 H, br s, CH₂), 1.33 (6 H, t, *J* 7, 5-CH₃), 1.66 (4 H, quintet, *J* 7, NCH₂CH₂), 2.71 (4 H, quartet, *J* 7, 5-CH₂), 4.62 (4 H, t, *J* 7, NCH₂), 6.33 (2 H, d, *J* 4, 4-H), 7.81 (2 H, d, *J* 4, 3-H); δ_{C} (62.9 MHz; CDCl₃) 172.89 (0), 152.13 (1), 128.41 (1), 123.96 (1), 113.48 (1), 77.23 (2), 46.81 (2), 32.14 (2), 31.94 (2), 29.72 (2), 29.56 (2), 29.49 (2), 29.38 (2), 26.52 (2), 22.70 (2), 20.48 (2), 14.12 (3), 12.29 (3); *m/z* 773 (MH⁺, 100%) and 795 (MNa⁺, 20).

2,4-Dimethyl-3-ethyl-1-octadecylpyrrole was synthesised using the following procedure: a solution of 2,4-dimethyl-3-ethylpyrrole (1.0 g, 10.5 mmol) in dry toluene (25 cm³) was added under nitrogen to a stirred suspension of potassium *tert*-butoxide (1.3 g, 11.6 mmol) and dibenzo-18-crown-6 (300 mg) in dry toluene (75 cm³). After 1 h, 1-bromooctadecane (3.3 g, 10 mmol) in dry toluene (25 cm³) was added and the resultant mixture refluxed for 12 h. Upon cooling, water (50 cm³) was added and the organic phase separated after which the aqueous phase was extracted three times with toluene (50 cm³). The combined organic phases were then washed three times with water and dried using anhydrous magnesium sulfate. After removal of toluene the crude 2,4-dimethyl-3-ethyl-1-octadecylpyrrole was purified by column chromatography (Al₂O₃) using light petroleum (40–60 °C) (yield 3.3 g, 95%). δ_{H} (250 MHz; CDCl₃; Me₃Si) 0.88 (3 H, t, *J* 7, CH₃), 1.06 (3 H, t, *J* 7, 3-CH₃), 1.26 (30 H, br s, CH₂), 1.64 (2 H, br m, NCH₂CH₂), 2.02 (3 H, s, 4-CH₃), 2.10 (3 H, s, 2-CH₃), 2.37 (2 H, quartet, *J* 7, 3-CH₂), 3.66 (2 H, t, *J* 7, NCH₂), 6.30 (1 H, s, 5-H).

Bis(3,5-dimethyl-4-ethyl-1-octadecylpyrrol-2-yl)squaraine (MeEt-Py) was synthesised by refluxing squaric acid (150 mg, 1.3 mmol) and 2,4-dimethyl-3-ethyl-1-octadecylpyrrole (1.0 g, 2.7 mmol) in ethanol (50 cm³) for 2 h and was purified by column chromatography (Al₂O₃) using incremented amounts of chloroform in light petroleum (40–60 °C) (yield 512 mg, 47%) (Found: C, 81.0; H, 11.5; N, 3.5. C₅₆H₉₆N₂O₂ requires C, 81.1; H, 11.7; N, 3.4%; *M*, 828); ν_{max} /cm⁻¹ 1609 (C–O); λ_{max} (CHCl₃)/nm 590; δ_{H} (250 MHz; CDCl₃; Me₃Si) 0.88 (6 H, t, *J* 7, CH₃), 1.04 (6 H, t, *J* 7, CH₃), 1.25 (60 H, br s, CH₂), 1.54 (4 H, br m, NCH₂CH₂), 2.27 (6 H, s, 2-CH₃), 2.39 (4 H, quartet, *J* 7,

3-CH₂), 2.59 (6 H, s, 4-CH₃), 4.63 (4 H, t, *J* 7, NCH₂); δ_{C} (62.9 MHz; CDCl₃) 177.09 (0), 174.05 (0), 144.19 (0), 135.48 (0), 129.81 (0), 126.34 (0), 46.73 (2), 31.92 (2), 31.77 (2), 29.71 (2), 29.66 (2), 29.63 (2), 29.56 (2), 29.45 (2), 29.36 (2), 26.69 (2), 22.68 (2), 17.66 (3), 14.81 (3), 14.10 (3), 12.15 (3), 11.19 (3); *m/z* 829 (MH⁺, 100%) and 851 (MNa⁺, 6).

Acknowledgements

The authors acknowledge financial support from the School of Natural and Environmental Sciences (Coventry University, UK) and would like to thank A. Pearse for running DSC, J. Bickerton for ¹H and ¹³C NMR spectroscopy, J. Lovering for preparing the thermally evaporated samples and B. Hollyoak for the collection of SAXR data. ADXPS measurements were performed at the Brisbane Surface Analysis Facility. GIXD work was performed at the Australian National Beamline Facility (Japan) with the help of Garry Foran and David Cookson. ADXPS was performed at the Brisbane Surface Analysis Facility. Dr Darren G. Hamilton (Cambridge) is also thanked for helpful discussion.

References

- 1 B. Patrick, M. V. George, P. V. Kamat, S. Das and K. G. Thomas, *J. Chem. Soc., Faraday Trans.*, 1992, **88**, 671.
- 2 S. Das, K. G. Thomas, P. V. Kamat and M. V. George, *Proc. Indian Acad. Sci., Chem. Sci.*, 1993, **105**, 513.
- 3 K.-Y. Law, *Chem. Rev.*, 1993, **93**, 449.
- 4 A. Treibs and K. Jacob, *Angew. Chem., Int. Ed. Engl.*, 1965, **4**, 694.
- 5 E. E. Havinga, W. ten Hoeve and H. Wynberg, *Synth. Met.*, 1993, **55**, 299.
- 6 Y.-Y. Chen and H. K. Hall, *Polym. Bull. (Berlin)*, 1986, **16**, 419.
- 7 D. E. Lynch, U. Geissler, J. Kwiatowski and A. K. Whittaker, *Polym. Bull. (Berlin)*, 1997, **38**, 493.
- 8 D. E. Lynch, U. Geissler, I. R. Peterson, M. Floersheimer, R. Terbrack, L. F. Chi, H. Fuchs, N. J. Calos, B. Wood, C. H. L. Kennard and G. J. Langley, *J. Chem. Soc., Perkin Trans. 2*, 1997, 827.
- 9 K.-Y. Law and C. C. Chen, *J. Phys. Chem.*, 1989, **93**, 2533.
- 10 Y. Kawabata, T. Sekiguchi, M. Tanaka, T. Nakamura, H. Komizu, K. Honda and E. Manda, *J. Am. Chem. Soc.*, 1985, **107**, 5270.
- 11 R. Gilardi and J. L. Flippen-Anderson, *Acta Crystallogr., Sect. C*, 1985, **41**, 591.
- 12 C. H. MacGillavry and M. Wolthius-Spuy, *Acta Crystallogr., Sect. B*, 1970, **26**, 645.
- 13 T. L. Marshbanks, H. K. Jugduth, W. N. Deglass and E. I. Franses, *Thin Solid Films*, 1993, **232**, 126.
- 14 T. J. Sarapatka, *Thin Solid Films*, 1993, **226**, 219.
- 15 S. C. Nyburg and A. R. Gerson, *Acta Crystallogr., Sect. B*, 1992, **48**, 103.
- 16 G. J. Langley, E. Hecquet, I. P. Morris and D. G. Hamilton, *Rapid Commun. Mass Spectrosc.*, 1997, **11**, 165.
- 17 J. L. Brédas and F. Meyers, *Nature (London)*, 1995, **375**, 362.
- 18 G. Ashwell, *Adv. Mater.*, 1996, **8**, 248.
- 19 G. J. Ashwell, G. S. Bahra, C. R. Brown, D. G. Hamilton, C. H. L. Kennard and D. E. Lynch, *J. Mater. Chem.*, 1996, **6**, 23.
- 20 D. G. Hamilton, D. E. Lynch and G. Smith, *Aust. J. Chem.*, 1996, **49**, 1339.
- 21 T. Yamada, H. Hoshi, K. Ishikawa, H. Takezoe and A. Fukuda, *Jpn. J. Appl. Phys.*, 1995, **34**, L-229.
- 22 G. J. Ashwell, G. Jefferies, D. G. Hamilton, D. E. Lynch, M. P. S. Roberts, G. S. Bahra and C. R. Brown, *Nature (London)*, 1995, **375**, 385.
- 23 R. T. Bailey, F. R. Cruickshank, P. J. Halfpenny, D. Pugh, J. N. Sherwood and G. S. Simpson, in *Principles and Applications of Nonlinear Optical Materials*, ed. R. W. Munn and C. N. Ironside, Blackie Academic and Professional, London, 1993, p. 146.
- 24 I. R. Girling, N. A. Cade, P. V. Kolinski, J. D. Earls and G. H. Cross, *Thin Solid Films*, 1985, **132**, 101.
- 25 J. C. Ashley, *IEEE Trans. Nucl. Sci.*, 1980, **27**, 1454.
- 26 T. L. Marshbanks, H. K. Jugduth, W. N. Deglass and E. I. Franses, *Thin Solid Films*, 1993, **232**, 126.
- 27 G. J. Foran, J. B. Peng, R. Steitz, G. T. Barnes and I. R. Gentle, *Langmuir*, 1996, **12**, 774.

Paper 7/08892B

Received 10th December 1997

Accepted 27th January 1998