

Gold(I) dimethyl- and diphenyl-dithiophosphate complexes

Max Preisenberger, Andreas Bauer, Annette Schier and Hubert Schmidbaur*

Anorganisch-chemisches Institut der Technischen Universität München, Lichtenbergstrasse 4, D-85747 Garching, Germany

In an attempt to carry out polyauration of dithiophosphate units, diphenyldithiophosphinic acid, $\text{Ph}_2\text{P}(\text{S})\text{SH}$, was treated with the reagents $\{[(\text{R}'_3\text{P})\text{Au}]_3\text{O}\}^+\text{BF}_4^-$ to give compounds $\{\text{Ph}_2\text{P}[\text{SAu}(\text{PR}'_3)]_2\}^+\text{BF}_4^-$ with $\text{R}' = \text{Ph}$, Me or *o*-tolyl (*o*-Tol) (**1–3**). The symmetrical $\text{Au} \cdots \text{Au}$ bonded structure of complex **1** was confirmed by a single-crystal X-ray diffraction study. Intercationic contacts are found only between gold and sulfur atoms. The analogous reaction with $\text{PhP}(\text{S})(\text{SSiMe}_3)_2$ gave an unstable product of the composition $\{\text{PhP}[\text{SAu}(\text{PPh}_3)]_3\}^+\text{BF}_4^-$ **4**, for which a solution structure with mirror-symmetry is proposed on the basis of low-temperature NMR data. Attempts to polyaurate dimethyldithiophosphinic acid led to cleavage of the P–S bonds with formation of known trigold sulfonium salts. (Phosphine)gold(I) dithiophosphinates $\text{Me}_2\text{P}(\text{S})\text{SAu}(\text{PR}'_3)$ were obtained from $\text{Me}_2\text{P}(\text{S})\text{SNa}$ and chloro(phosphine)gold complexes ($\text{R}' = \text{Me}$, Ph or *o*-Tol, **5–7** respectively). The crystal and molecular structure of compound **5** was determined. In the crystal, the compound forms two crystallographically independent, centrosymmetrical dimers with $\text{Au} \cdots \text{Au}$ contacts [3.1152(5) and 3.1466(5) Å] between ‘crossed’ monomers. With $(\text{Me}_2\text{S})\text{AuCl}$ as a precursor, the product of the reaction with $\text{Me}_2\text{P}(\text{S})\text{SNa}$ was $[\text{Me}_2\text{P}(\text{S})\text{SAu}]_2$ **8**. Compound **8** is a dinuclear complex with an elongated eight-membered ring structure in a chair conformation. The crystal-structure analysis reveals the expected transannular $\text{Au} \cdots \text{Au}$ contacts [3.1949(9) Å], but no intermolecular contacts are discernible.

Most prominent applications of gold chemistry in modern technology and medicine are based on gold–sulfur compounds.¹ Sulfide and thiolate anions, and the anions of various inorganic and organic thioacids, appear as ligands for gold(I) in gilding pastes, components of electroplating baths or of mixtures for electroless plating, as well as in pharmaceutical preparations.^{2,3} Thio-phosphates, -phosphonates and -phosphinates in particular were also included in several of the early studies of the usage of gold(I) compounds as lubrication additives.^{4–7} The determination of the molecular structure of one of these compounds gave an early example of supramolecular chemistry based on a phenomenon which is now addressed as the ‘auriophilicity’ effect and is currently attracting considerable interest.^{8–10}

However, it appears that in the past there has not been any systematic study of the chemistry of gold(I) dithiophosphinates. Dithiophosphinic acid anions $[\text{R}_2\text{PS}_2]^-$ are potential bidentate ligands and should form efficient clustering centers for gold(I) cations. While monoaurated dithiophosphinates and the related dithiophosphates are well documented, no attempt to induce polyauration is reported in the literature.^{11–13} Present knowledge of the structural chemistry of gold(I)–sulfur compounds suggests that steric effects play a major role in determining the supramolecular aggregation of these polynuclear species.^{14–21} We have therefore become interested in gold(I) complexes with the smallest dialkylphosphinate ligands, for which there was no information in the literature.^{22,23} The present paper is mainly an account of gold(I) dimethylphosphinates with or without auxiliary ligands, but a few diphenylphosphinate analogues have also been included. Formal replacement of an alkyl or aryl substituent in dithiophosphinates by a sulfide group yields trithiophosphonates. A first example of a trinuclear complex of these homologues is also included.

Preparative Results

Diphenyldithiophosphinates and phenyltrithiophosphonates

Diphenyldithiophosphinic acid $\text{Ph}_2\text{P}(\text{S})\text{SH}$ is a compound of low thermal stability. Rapid elimination of hydrogen sulfide is observed at room temperature, and therefore this reagent is best

prepared *in situ* and used immediately for reactions with other substrates. For this purpose the reaction of diphenylphosphine Ph_2PH with elemental sulfur offers a number of advantages.²⁴ We therefore used this method to generate the precursor for the reactions with aurating agents.

Treatment of a solution of $\text{Ph}_2\text{P}(\text{S})\text{SH}$ in dichloromethane at 0 °C with a solution of tris[(triphenylphosphine)gold(I)]-oxonium tetrafluoroborate in the molar ratio 3:2 in the presence of excess NaBF_4 leads to a complex reaction mixture, which contains tris[(triphenylphosphine)gold(I)]sulfonium tetrafluoroborate and μ -diphenyldithiophosphinatobis[(triphenylphosphine)gold(I)] tetrafluoroborate **1** [equation (1)].

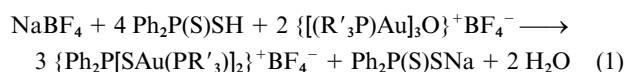

Crystals of compound **1** can be obtained by crystallization from dichloromethane–diethyl ether (yield 40%, m.p. 161 °C with decomposition). The analogous reactions with oxonium salts containing trimethylphosphine or tri(*o*-tolyl)phosphine give the corresponding complexes with Me_3P and (*o*-Tol)₃P (*o*-Tol = $\text{C}_6\text{H}_4\text{Me-}o$) as the auxiliary ligands [**2**: 44%, m.p. 153 °C; **3**: 39% yield, m.p. 171 °C; equation (1)]. Compounds **1–3** have been characterized by their analytical and spectroscopic data (Experimental section).

Phenyltrithiophosphonic acid $\text{PhP}(\text{S})(\text{SH})_2$ cannot be used as a reagent owing to its low stability, but its trimethylsilyl ester is readily available. The reaction with equimolar amounts of the oxonium salt (with Ph_3P ligands) yields compound **4** [equation (2)] as a white solid which is stable below –40 °C, but

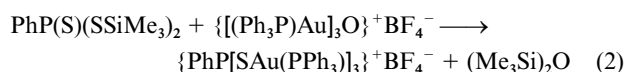

decomposes rapidly in solution. Only preliminary data could be obtained for this compound. Its ³¹P-¹H NMR spectrum (in CDCl_3 at –20 °C) has two resonances in the intensity ratio 1:3, but at –60 °C the Ph_3P resonance is split further into two signals of relative intensity 1:2 (see Experimental section).

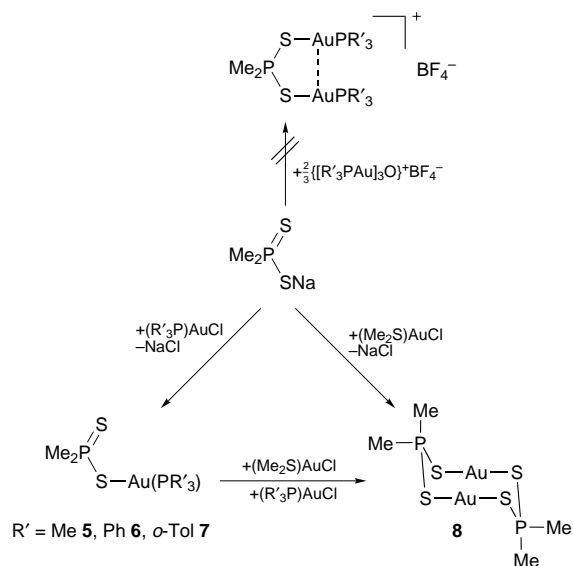

Scheme 1

These data suggest a fluxional structure with a ground state configuration as proposed below, but no final conclusion could be reached as yet.

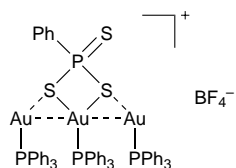

Dimethyldithiophosphinates

For the preparation of all derivatives of dimethyldithiophosphinic acid, $\text{Me}_2\text{P}(\text{S})\text{SH}$, the sodium salt $\text{Me}_2\text{P}(\text{S})\text{SNa}$ was used. Its reaction with $\{[(\text{R}'_3\text{P})\text{Au}]_3\text{O}\}^+\text{BF}_4^-$ (molar ratio 3:2) leads only to cleavage products. It thus appears that compounds with methyl substituents undergo more facile cleavage of P–S bonds than their phenyl analogues. However, the reactions of $\text{Me}_2\text{P}(\text{S})\text{SNa}$ with the chlorogold(I) complexes of Me_3P , Ph_3P and (*o*-Tol) $_3\text{P}$ in tetrahydrofuran afford almost quantitative yields of colorless crystalline products of the composition $\text{Me}_2\text{P}(\text{S})\text{SAu}(\text{PR}'_3)$ with $\text{R}' = \text{Me}$ (**5**, 94%, m.p. 169 °C), Ph (**6**, 97%, m.p. 186 °C) and *o*-Tol (**7**, 96%, m.p. 178 °C, all with decomposition) (Scheme 1). All compounds gave satisfactory analytical and spectroscopic data (see Experimental section).

The presence of a non-co-ordinated second sulfur atom in compound **5** seemed to offer a chance for further auration. Instead, the reaction with $(\text{Me}_2\text{S})\text{AuCl}$ leads to the cyclic dinuclear complex $[\text{Me}_2\text{P}(\text{S})\text{SAu}]_2$ **8**. When chloro(dimethyl sulfide)gold(I) was treated with $\text{Me}_2\text{P}(\text{S})\text{SNa}$ this gold(I) dimethyldithiophosphinate **8** was also obtained (53% yield, m.p. 183 °C) (Scheme 1). According to crystallographic data, this compound is a dimer in the solid state, and there is no reason to assume that dissociation occurs in solution. Owing to the high symmetry of the dimer, the NMR spectra are very simple and fully consistent with the proposed structure (see Experimental section and below). The pattern of the ^1H NMR spectrum (in CD_2Cl_2) is unchanged in the temperature range +30 to –90 °C. It appears that the auracycle undergoes rapid inversion on the NMR time-scale even at very low temperature. Otherwise the two diastereotopic P-bound methyl groups would give rise to separate doublet signals.

The Structural Chemistry of Gold(I) Dithiophosphinates

Compound **1** crystallizes (from dichloromethane–diethyl ether)

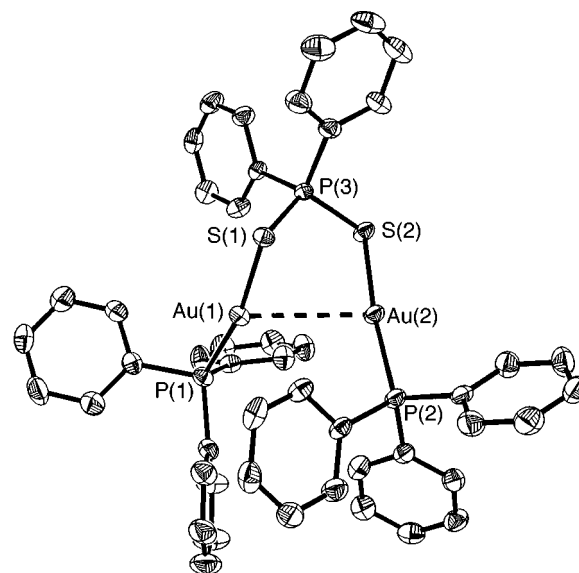

Fig. 1 Molecular structure of the dinuclear cation of compound **1** with atomic numbering (ORTEP,²⁵ hydrogen atoms omitted). Selected bond lengths (Å) and angles (°): Au(1)⋯Au(2) 3.2385(4), Au(1)–S(1) 2.3240(12), Au(2)–S(2) 2.3398(11), Au(1)–P(1) 2.2568(12), Au(2)–P(2) 2.2583(12), P(3)–S(1) 2.038(2), P(3)–S(2) 2.035(2), Au(2)⋯S(2') 3.595 (Fig. 2); P(1)–Au(1)–S(1) 168.23(4), P(2)–Au(2)–S(2) 173.31(4), Au(1)–S(1)–P(3) 99.92(6), Au(2)–S(2)–P(3) 101.86(6), S(1)–P(3)–S(2) 115.29(7)

in the monoclinic space group $P2_1/c$ with 4 formula units and four molecules of CH_2Cl_2 in the unit cell. The lattice is composed of independent dichloromethane molecules, disordered tetrafluoroborate anions and $\{\text{Ph}_2\text{P}[\text{SAu}(\text{PPh}_3)]_2\}^+$ cations, which are related by a crystallographic center of inversion. The cations have no crystallographically imposed symmetry, but the structure approaches rather closely the symmetry requirement of point group C_2 , with the two-fold axis passing through the phosphorus atom of the diphenyldithiophosphinate group [P(3), Fig. 1]. The two Au(Ph_2P) units are attached to the two different sulfur atoms with P–Au–S angles deviating significantly from the ideal angle of 180° [P(1)–Au(1)–S(1) 168.23(4), P(2)–Au(2)–S(2) 173.31(4)]. The two gold atoms are clearly drawn together to reach a distance of Au(1)⋯Au(2) = 3.2385(4) Å typical for aurophilic bonding. The angles at the sulfur atoms are similar with individual values of Au(1)–S(1)–P(3) 99.92(6) and Au(2)–S(2)–P(3) 101.86(6)°. The shortest contacts between the cations are not associated with distant metal–metal interactions. The gold atoms are approached by sulfur atoms of neighbouring molecules instead, but the resulting parallelogram [Au(2)–S(2)–Au(2')–S(2')], Fig. 2] has two very long edges [Au(2)⋯S(2') 3.595(2) Å] not much shorter than the sum of the van der Waals radii of gold(I) and sulfur.

Compound **5** crystallizes (from dichloromethane–pentane) in the monoclinic space group $C2/c$ with 16 formula units in the unit cell. The lattice contains two independent monomers, which are associated in pairs, the components of which are related by a crystallographical two-fold axis. The dimerization occurs through short gold–gold contacts [Au(1)⋯Au(1') 3.1152(5) Å, Au(2)⋯Au(2') 3.1466(5) Å] (Fig. 3). The two dimers are almost superimposable and their structural details are marginally different (see caption to Fig. 3). From the projection of the molecules down their Au⋯Au bonds the crossing of the two P–Au–S axes (like the crossing of swords) in each of the dimers is easily discernible (Fig. 4). There is ample precedence for this crossed type of interaction in the aggregates of many other gold(I) complexes. The packing of the dimers in the crystal is not associated with any close intermolecular contacts between gold atoms or between gold and sulfur atoms.

Compound **8** crystallizes (from dichloromethane–pentane) in the orthorhombic space group $Pbca$ with 8 molecules in the

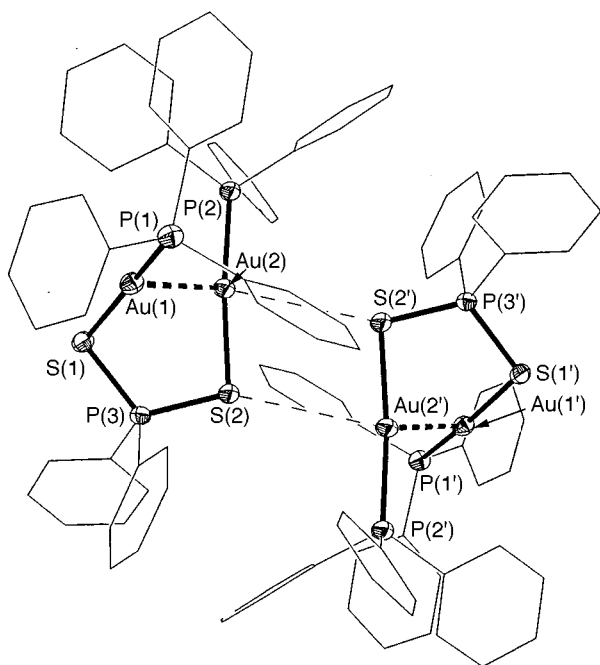

Fig. 2 View of the molecular structure of compound **1** showing the shortest contacts between the cations

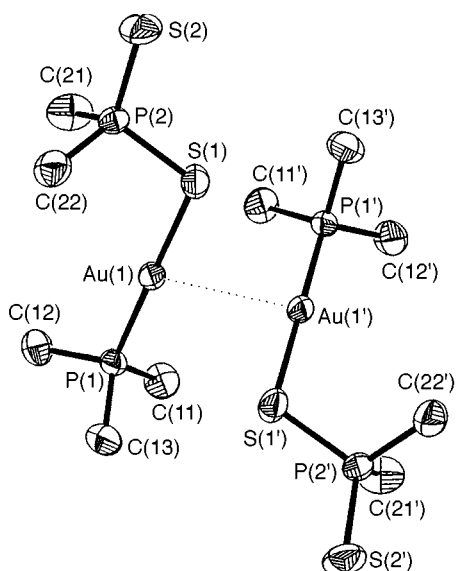

Fig. 3 Molecular structure of one of the two crystallographically independent molecules of compound **5** with atomic numbering (ORTEP,²⁵ hydrogen atoms omitted). Selected bond lengths (Å) and angles (°) (the corresponding values of the second molecule are given in square brackets): Au(1)⋯Au(1') 3.1152(5) [3.1466(5)], Au(1)–S(1) 2.318(2) [2.315(2)], Au(1)–P(1) 2.2568(14) [2.2580(14)], S(1)–P(2) 2.042(2) [2.049(2)], S(2)–P(2) 1.955(2) [1.958(2)]; P(1)–Au(1)–S(1) 178.53(7) [179.52(6)], P(2)–S(1)–Au(1) 105.50(8) [105.34(7)]

unit cell. The lattice contains dimeric molecules with a cyclic structure arising from the symmetrical double-bridging of the two gold atoms by the dimethyldithiophosphinate groups (Fig. 5). The eight-membered ring is in an elongated chair conformation with a short transannular gold–gold contact [Au⋯Au' 3.1949(9) Å], associated with an inward bending of the S(1)–Au–S(2) angle to 173.86(11)°. Through narrow angles at the sulfur atoms [P–S(1)–Au 98.5(2)°, P'–S(2)–Au 102.8(2)°] the folding of the chair is very pronounced. Contrary to the related bis[μ-(diphenyldithiophosphinato)digold(I)] complex⁸ there are no close intermolecular contacts in the lattice.

Conclusion

In the present work it has been demonstrated that dimethyl-

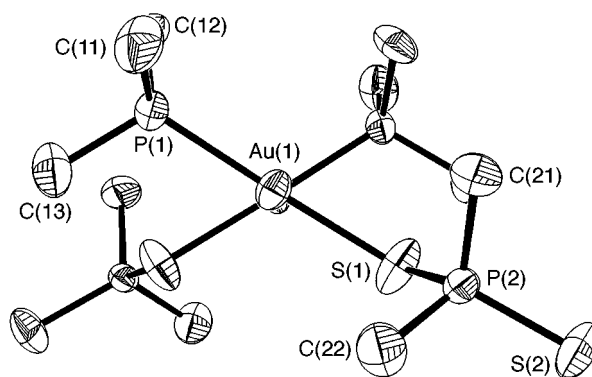

Fig. 4 Projection of compound **5** down its Au⋯Au bond (only one of the two independent molecules is shown)

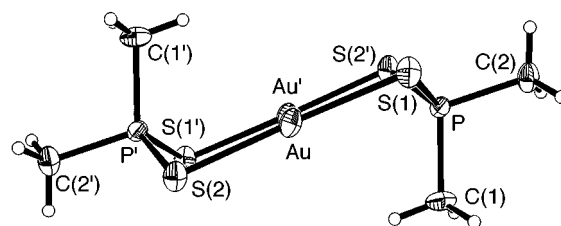
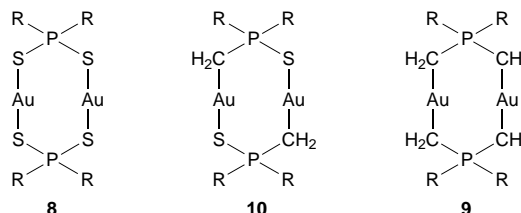

Fig. 5 Molecular structure of compound **8** with atomic numbering (ORTEP,²⁵ hydrogen atoms omitted). Selected bond lengths (Å) and angles (°): Au⋯Au' 3.1949(9), Au–S(1) 2.303(3), Au–S(2) 2.290(3), S(1)–P 2.030(4), S(2)–P' 2.033(4); S(1)–Au–S(2) 173.86(11), P–S(1)–Au 98.5(2), P'–S(2)–Au 102.8(2), S(1)–Au–Au' 95.78(8), S(2)–Au–Au' 90.22(8)



dithiophosphinate anions [Me₂PS₂][−] are readily mono-aurated at one of the sulfur atoms using standard (R'₃P)AuCl reagents to give (phosphine)gold(I) dithiophosphinates of the general formula Me₂P(S)SAu(PR'₃) (R' = Me **5**, Ph **6**, *o*-Tol **7**) (Scheme 1). If PR'₃ is replaced by the ligand Me₂S with better leaving group properties, there is complete exchange of both Me₂S and Cl. Thus compound **8** is the sole product of the reaction of [Me₂PS₂][−] with (Me₂S)AuCl, where the poorer dimethyl sulfide ligand is liberated quantitatively (Scheme 1).

In complexes of the type Me₂P(S)SAu(PR'₃) the gold atom is attached to only one of the two sulfur atoms. The structural data obtained for the compound with R' = Me (**5**) provide no evidence for S,S-chelation. Instead, the individual molecules with their linear P–Au–S axis are associated into dimers, with short Au⋯Au contacts connecting 'crossed' monomers (Fig. 3). Similar Au⋯Au contacts are present in the cyclic structure of the dimer [Me₂P(S)SAu]₂ **8**, and again there is neither internal sulfur chelation of the gold atoms nor are there any discernible intermolecular gold–sulfur interactions. The auracycle of compound **8** shows a very pronounced folding, but the molecules still undergo rapid inversion in solution as demonstrated in low-temperature NMR experiments. The two diastereotopic P-bound methyl groups are NMR equivalent even at −90 °C in dichloromethane solution (Fig. 5).

The gold(I) dithiophosphinate **8** is an isoelectronic analogue of the corresponding gold(I) phosphonium-bis(methylides) **9** discovered about 20 years ago.²⁶ The structures are closely related and show only very minor differences. Finally, the 'intermediate' species with mixed CH₂/S bridges (**10**), prepared by Mazany and Fackler²² in 1984, are a blend of the two sym-

metrical counterparts and follow the same pattern of structure and bonding.

Attempts to accomplish polyauration of diorganodithio-phosphinate anions with more powerful aurating agents like the oxonium reagents $\{(R'_3P)Au_3O\}^+BF_4^-$ are only successful with the phenyl compound $[Ph_2PS_2]^-$ [equation (1)]. The resulting dinuclear compound ($R' = Ph$ **1**) has the two gold atoms attached to the two different sulfur atoms, but there are close contacts between these gold centers which clearly stabilize the overall arrangement of the cation $\{Ph_2P[SAu(PR'_3)]_2\}^+$ (Fig. 1). The cations show weak intermolecular interactions *via* distant $Au \cdots S$ contacts. The analogous reaction of trigold-oxonium salts with dimethylphosphinate as a nucleophile leads to P–S cleavage and gives trigold-sulfonium salts of the type $\{(R'_3P)Au_3S\}^+BF_4^-$. The electronic effects of methyl and phenyl groups at phosphorus are thus sufficiently different to induce a quite different course of the auration reaction.

The trimethylsilyl diester of phenyltrithiophosphonic acid was found to undergo triauration with the oxonium reagent [equation (2)], but the product (**4**) is a very unstable species which undergoes rapid decomposition both in solution and as a solid. On the basis of the low-temperature ^{31}P NMR spectrum the compound is assigned a mirror-symmetrical structure in solution where two of the three sulfur atoms are bridging the three gold atoms in a symmetrical array, but this proposal is as yet only tentative.

Experimental

General

All experiments were carried out under an atmosphere of dry, purified nitrogen. Glassware was dried and filled with nitrogen, solvents were distilled and kept under nitrogen; NMR: JEOL-GX 270 (109.4 MHz), $SiMe_4$ as internal standard, phosphoric acid as external standard; mass spectrometer: Finnigan MAT 90; microanalyses: in-house analyzers (by combustion techniques). Starting materials were either commercially available or were prepared following literature procedures: $\{(Ph_3P)Au_3O\}^+BF_4^-$,²⁷ $\{(Me_3P)Au_3O\}^+BF_4^-$,²⁸ $\{[(o-Tol)_3P]Au_3O\}^+BF_4^-$,²⁹ $Ph_2P(S)SH$,²⁴ $(Me_2S)AuCl$,³⁰ $(Ph_3P)AuCl$,³¹ $(Me_3P)AuCl$,²⁸ $\{(o-Tol)_3P\}AuCl$,³² $Me_2P(S)SNa$,³³ $PhP(S)(SSiMe_3)_2$.³⁴

Syntheses

$\{Ph_2P[SAu(PPh_3)]_2\}^+BF_4^-$ 1. To a solution of S_8 (13 mg, 0.053 mmol) in toluene (5 ml) was added Ph_2PH (39 mg, 0.21 mmol) dissolved in toluene (5 ml). After stirring for 6 h at 80 °C the solvent was removed *in vacuo*. The remaining green oil was dissolved in dichloromethane (10 ml) and added at 0 °C to a solution of $\{(Ph_3P)Au_3O\}^+BF_4^-$ (209 mg, 0.14 mmol) in dichloromethane (10 ml). After addition of $NaBF_4$ (100 mg, 0.91 mmol) and stirring for 2 h the solution was filtered. Evaporation of the solvent from the filtrate *in vacuo* to leave a volume of *ca.* 5 ml and addition of diethyl ether led to the precipitation of a colourless 1:1 mixture of complex **1** and $\{[(Ph_3P)Au_3S]\}^+BF_4^-$. Crystals suitable for X-ray studies of complex **1** could be obtained from dichloromethane solution by layering with diethyl ether (yield 104 mg, 40%), m.p. 161 °C (decomp.) (Found: C, 46.12; H, 3.19; S, 4.94. $C_{48}H_{40}Au_2BF_4P_3S_2$ requires C, 45.95; H, 3.21; S, 5.11%). NMR ($CDCl_3$): 1H , δ 7.41–7.89 (m, Ph); ^{31}P - $\{^1H\}$ (room temperature) δ 70.8 (s, 1 P, Ph_2P), 37.1 (s, 2 P, Ph_3PAu); (–60 °C) δ 70.7 [t, $J(PP)$ 10, 1 P, Ph_2P], 36.4 [d, $J(PP)$ 10, 2 P, Ph_3PAu]; ^{13}C - $\{^1H\}$, δ 132.8 (s), 129.0 [d, $J(CP)$ 13], 130.8 [d, $J(CP)$ 12] (*para*-, *meta*-, *ortho*-C of Ph_2P), 132.5 [d, $J(CP)$ 3], 129.5 [d, $J(CP)$ 12], 133.9 [d, $J(CP)$ 14 Hz] (*para*-, *meta*-, *ortho*-C of Ph_3PAu), *ipso* C atoms were not observed with certainty. FAB mass spectrum: m/z 1168 (28, $[M + 1]^+$), 905 (22%, $[M - PPh_3]^+$).

$\{Ph_2P[SAu(PMe_3)]_2\}^+BF_4^-$ 2. The synthesis was analogous to that of **1** with Ph_2PH (23 mg, 0.14 mmol), S_8 (9 mg, 0.04 mmol), $NaBF_4$ (100 mg, 0.91 mmol) and $\{(Me_3P)Au_3O\}^+BF_4^-$ (85 mg, 0.14 mmol) to give 54 mg (44%) of **2**. The compound is air stable and soluble in dichloromethane and chloroform, but insoluble in pentane and diethyl ether. Crystals could be obtained from dichloromethane solution by layering with pentane, m.p. 153 °C (decomp.) (Found: C, 23.30; H, 3.30; S, 6.56. $C_{19}H_{30}Au_2BCl_2F_4P_3S_2$ requires C, 23.30; H, 3.09; S, 6.55%). NMR ($CDCl_3$): 1H , δ 7.53–8.12 (m, 10 H, Ph), 1.67 [d, $J(HP)$ 11 Hz, 18 H, CH_3]; ^{31}P - $\{^1H\}$, δ 72.7 (s, 1 P, Ph_2P), –3.5 (s, 2 P, Me_3PAu); ^{13}C - $\{^1H\}$, δ 132.5 (s), 128.8 [d, $J(CP)$ 13], 130.8 [d, $J(CP)$ 12] (*para*-, *meta*-, *ortho*-C of Ph_2P), *ipso* C atoms were not observed with certainty, 16.0 [d, $J(CP)$ 39 Hz, $AuPMe_3$]. FAB mass spectrum: m/z 795 (100%, $[M]^+$).

$\{Ph_2P[SAu\{P(o-Tol)_3\}]_2\}^+BF_4^-$ 3. The synthesis was analogous to that of **1** with Ph_2PH (43 mg, 0.23 mmol), S_8 (15 mg, 0.06 mmol), $NaBF_4$ (100 mg, 0.91 mmol) and $\{[(o-Tol)_3P]Au_3O\}^+BF_4^-$ (249 mg, 0.16 mmol) to give 120 mg (39%) of **3**. The compound is air stable and soluble in dichloromethane and chloroform, but insoluble in pentane and diethyl ether. Yellow crystals could be obtained from dichloromethane solution by layering with diethyl ether, m.p. 171 °C (decomp.) (Found: C, 46.13; H, 3.86; S, 3.98. $C_{55}H_{54}Au_2BCl_2F_4P_3S_2$ requires C, 46.40; H, 3.82; S, 4.50%). NMR ($CDCl_3$): 1H , δ 6.84–7.91 (m, 34 H, aryl H), 2.30 (s, 18 H, Me); ^{31}P - $\{^1H\}$, δ 67.6 (s, 1 P, Ph_2P), 14.0 [s, 2 P, (*o-Tol*) $_3PAu$]. FAB mass spectrum: m/z 1251 (100, $[M]^+$), 947 (30, $[M - \{P(o-Tol)_3\}]^+$), 750 (9%, $[M - AuP(o-Tol)_3]^+$).

$\{PhP[SAu(PPh_3)]_3\}^+BF_4^-$ 4. To a solution of $PhP(S)(SiMe_3)_2$ (58 mg, 0.17 mmol) in dichloromethane (10 ml) were added $\{(Ph_3P)Au_3O\}^+BF_4^-$ (245 mg, 0.17 mmol) in dichloromethane (10 ml) and $NaBF_4$ (100 mg, 0.91 mmol) at –30 °C. After stirring for 2 h the solution was filtered. Evaporation of the solvent from the filtrate *in vacuo* to leave a volume of *ca.* 5 ml and addition of pentane led to the precipitation of complex **4** as a white solid. The solid compound is stable at –40 °C, but is unstable in solution. NMR ($CDCl_3$): 1H (–20 °C) δ 7.07–7.32 (m, Ph); ^{31}P - $\{^1H\}$ (–20 °C) δ 86.9 (s, 1 P, PhP), 37.2 (s, 3 P, $AuPPh_3$); (–60 °C) δ 86.7 (s, 1 P, PhP), 37.4 (s, 1 P, $AuPPh_3$), 36.7 (s, 2 P, $AuPPh_3$). FAB mass spectrum: m/z 1581 (4%, $[M]^+$).

$Me_2P(S)SAu(PMe_3)$ 5. To a solution of $Me_2P(S)SNa$ (48 mg, 0.32 mmol) in thf (10 ml) was slowly added $(Me_3P)AuCl$ (99 mg, 0.32 mmol) dissolved in thf (10 ml). After stirring for 1 h the solvent was removed *in vacuo* and the white precipitate was extracted with dichloromethane (10 ml). Addition of pentane to the filtrate led to the precipitation of 120 mg (94%) of **5** as a white solid. The compound is air stable and stable in solution, soluble in dichloromethane and chloroform, but insoluble in pentane and diethyl ether. Crystals could be obtained from dichloromethane solution by layering with pentane, m.p. 169 °C (decomp.) (Found: C, 15.03; H, 3.81; S, 15.94. $C_5H_{15}AuP_2S_2$ requires C, 15.08; H, 3.80; S, 16.10%). NMR ($CDCl_3$): 1H , δ 2.13 [d, $J(HP)$ 13, 6 H, $P(S)Me_2$], 1.60 [d, $J(HP)$ 11 Hz, 9 H, $AuPMe_3$]; ^{31}P - $\{^1H\}$, δ 60.8 [s, 1 P, $Me_2P(S)$], –4.2 (s, 1 P, Me_3PAu); ^{13}C - $\{^1H\}$, δ 33.0 [d, $J(CP)$ 54, $Me_2P(S)$], 15.9 [d, $J(CP)$ 37 Hz, Me_3PAu]. FAB mass spectrum: m/z 398 (66%, $[M]^+$).

$Me_2P(S)SAu(PPh_3)$ 6. The synthesis was analogous to that of **5** with $Me_2P(S)SNa$ (35 mg, 0.24 mmol) and $(Ph_3P)AuCl$ (117 mg, 0.24 mmol) to give 134 mg (97%) of **6**. Crystals could be obtained from dichloromethane solution by layering with pentane, m.p. 186 °C (decomp.) (Found: C, 42.01; H, 3.91. $C_{20}H_{21}AuP_2S_2$ requires C, 41.10; H, 3.62%). NMR ($CDCl_3$): 1H , δ 7.15–7.73 (m, 15 H, Ph), 2.14 [d, $J(HP)$ 13 Hz, 6 H, Me]; ^{31}P - $\{^1H\}$, δ 57.2 [s, 1 P, $Me_2P(S)$], 35.8 (s, 1 P, Ph_3PAu). FAB mass spectrum: m/z 584 (37%, $[M]^+$).

Table 1 Crystal data, data collection, and structure refinement for compounds **1**, **5** and **8**

	1	5	8
Crystal data			
Formula	C ₄₈ H ₄₀ Au ₂ BF ₄ P ₃ S ₂ ·CH ₂ Cl ₂	C ₅ H ₁₅ AuP ₂ S ₂	C ₂ H ₆ AuPS ₂
<i>M_r</i>	1339.50	398.20	322.12
Crystal system	Monoclinic	Monoclinic	Orthorhombic
Space group	<i>P</i> 2 ₁ / <i>c</i>	<i>C</i> 2/ <i>c</i>	<i>Pbca</i>
<i>a</i> /Å	13.245(1)	19.464(2)	11.093(1)
<i>b</i> /Å	14.576(1)	12.277(1)	10.673(1)
<i>c</i> /Å	25.643(1)	20.626(2)	11.402(1)
<i>α</i> /°	90	90	90
<i>β</i> /°	104.39(1)	98.73(1)	90
<i>γ</i> /°	90	90	90
<i>U</i> /Å ³	4795.6(8)	4871.7(8)	1349.9(2)
<i>D_c</i> /g cm ⁻³	1.855	2.172	3.170
<i>Z</i>	4	16	8 (monomers)
<i>F</i> (000)	2584	2976	1152
<i>μ</i> (Mo-Kα)/cm ⁻¹	64.6	126.3	225.20
Data collection			
<i>T</i> /°C	-74	-74	-74
Scan mode	ω	ω	ω
<i>hkl</i> Ranges	-16 to 16, -18 to 0, 0-30	0-25, 0-16, -27 to 26	0-14, -13 to 0, 0-14
Sin(θ/λ) _{max} /Å ⁻¹	0.64	0.64	0.64
Measured reflections	9576	6016	1464
Unique reflections (<i>R</i> _{int})	9364 (0.0187)	5843 (0.0223)	1463
Reflections used for refinement	9358	5783	1441
Absorption correction	ψ Scans	ψ Scans	ψ Scans
<i>T</i> _{min} ; <i>T</i> _{max}	0.54, 0.99	0.54, 0.99	0.72, 0.99
Refinement			
Refined parameters	580	181	55
H atoms (found, calculated)	0, 42	0, 30	0, 6
Final <i>R</i> values [<i>I</i> > 2σ(<i>I</i>)]			
<i>R</i> 1 ^a	0.0292	0.0311	0.0459
<i>wR</i> 2 ^b	0.0617	0.0571	0.1075
(Shift/error) _{max}	<0.001	<0.001	<0.001
ρ(maximum, minimum)/e Å ⁻³	0.82, -0.73	0.88, -1.22	1.86, -2.73

^a $R = \sum(|F_o| - |F_c|)/\sum|F_o|$. ^b $wR2 = [\sum w(F_o^2 - F_c^2)^2/\sum w(F_o^2)^2]^{1/2}$; $w = 1/[\sigma^2(F_o^2) + (aP)^2 + bP]$; $P = (F_o^2 + 2F_c^2)/3$; $a = 0.0248$ (**1**), 0.0168 (**5**), 0.0459 (**8**); $b = 10.6$ (**1**), 24.9 (**5**), 23.17 (**8**). ^c The residual electron densities are located around the gold atoms.

Me₂P(S)SAu{P(*o*-Tol)}₃ **7.** The synthesis was analogous to that of **5** with Me₂P(S)SNa (35 mg, 0.24 mmol) and {(*o*-Tol)₃-P}AuCl (127 mg, 0.24 mmol) to give 147 mg (96%) of **7**. Crystals could be obtained from dichloromethane solution by layering with pentane, m.p. 178 °C (decomp.) (Found: C, 44.21; H, 4.40; S, 9.37. C₂₃H₂₇AuP₂S₂ requires C, 44.09; H, 4.34; S, 10.23%). NMR (CDCl₃): ¹H, δ 6.93–7.76 (m, 12 H, aryl H), 2.32 (s, 9 H, C₆H₄Me), 2.12 [d, *J*(HP) 13 Hz, 6 H, P(S)Me₂]; ³¹P-¹H}, δ 57.5 [s, 1 P, Me₂P(S)], 17.1 [s, 1 P, (*o*-Tol)₃PAu]. FAB mass spectrum: *m/z* 626 (50%, [M]⁺).

[Me₂P(S)SAu]₂ **8.** The compound was prepared from Me₂P(S)SNa (50 mg, 0.34 mmol) and (Me₂S)AuCl (99 mg, 0.34 mmol) in tetrahydrofuran (20 ml), as described for **5**, to give 58 mg (53%) of **8**. Crystals suitable for X-ray studies could be obtained from dichloromethane solution by layering with pentane, m.p. 183 °C (decomp.) (Found: C, 7.57; H, 2.04; S, 19.80. C₂H₆AuPS₂ requires C, 7.46; H, 1.88; S, 19.91%). NMR (CD₂Cl₂): ¹H (room temperature) δ 2.26 [d, *J*(HP) 10]; (−90 °C) δ 2.22 [d, *J*(HP) 10 Hz]; ³¹P-¹H}, δ 64.7 (s); ¹³C-¹H}, δ 29.6 [d, *J*(CP) 55 Hz]. FAB mass spectrum: *m/z* 644 (3.7%, [M]⁺).

Crystal structure determinations

Suitable single crystals of compounds **1**, **5** and **8** were sealed in glass capillaries and used for measurement of precise cell constants and intensity data collection. During data collection, three standard reflections were measured periodically as a general check of crystal and instrument stability. No significant changes were observed for any of the compounds. Diffraction intensities were corrected for Lorentz, polarization and absorption effects. The structures were solved by direct methods (**1**)

and Patterson methods (**5** and **8**), and refined by full-matrix least-squares calculations against *F*².³⁵ The thermal motion of all non-hydrogen atoms was treated anisotropically except for the highly disordered BF₄[−] anion of compound **1**. The disorder was resolved into 12 split fluorine positions (8 F positions with site occupation factor of 0.25, 4 F positions with site occupation factor of 0.5) with idealized geometry. All hydrogen atoms were calculated in idealized positions and their isotropic thermal parameters were tied to that of the adjacent carbon atom by a factor of 1.5. Details of crystal data, data collection and structure refinement are summarized in Table 1. Important interatomic distances and angles are given in the corresponding figure captions.

CCDC reference number 186/759.

Acknowledgements

This work was supported by Deutsche Forschungsgemeinschaft, by Fonds der Chemischen Industrie, and, through the donation of chemicals, by Degussa AG and Heraeus GmbH. The authors are grateful to Mr. J. Riede for establishing the X-ray data sets and Mr. D. Schoen for his experimental support.

References

- W. S. Rapson and T. Groenewald, *Gold Usage*, Academic Press, London, 1978.
- F. A. Cotton and G. Wilkinson, *Advanced Inorganic Chemistry*, Wiley, London, 4th edn., 1980.
- J. Weinstock, B. M. Sutton, G. Y. Kuo, D. T. Walz and M. J. DiMartino, *J. Med. Chem.*, 1974, **74**, 139.

- 4 S. L. Lawton, W. J. Rohrbaugh and G. T. Kokotailo, *Inorg. Chem.*, 1972, **11**, 2227.
- 5 S. L. Lawton and G. T. Kokotailo, *Inorg. Chem.*, 1969, **8**, 2410.
- 6 W. Kuchen and H. Hertel, *Angew. Chem.*, 1969, **81**, 127 and refs. therein.
- 7 J. R. Wasson, G. M. Woltermann and H. J. Stoklosa, *Fortschr. Chem. Forsch.*, 1973, **35**, 65.
- 8 G. Siasios and E. R. T. Tiekink, *Z. Kristallogr.*, 1995, **210**, 698.
- 9 H. Schmidbaur, *Chem. Soc. Rev.*, 1995, **24**, 391.
- 10 F. Scherbaum, A. Grohmann, B. Huber, C. Krüger and H. Schmidbaur, *Angew. Chem.*, 1988, **100**, 1602.
- 11 W. Kuchen and H. Mayatepek, *Chem. Ber.*, 1986, **101**, 3454.
- 12 S. Heinz, H. Keck and W. Kuchen, *Org. Mass Spectrom.*, 1984, **19**, 82.
- 13 F. Bonati, A. Burini, B. R. Pietroni and E. Giorgini, *J. Organomet. Chem.*, 1988, **344**, 119.
- 14 I. Schröttner and J. Strähle, *Chem. Ber.*, 1991, **124**, 2161.
- 15 W. Wojnowski, B. Becker, J. Sassmannshausen, E.-M. Peters, K. Peters and H. G. v. Schnering, *Z. Anorg. Allg. Chem.*, 1994, **620**, 1417.
- 16 C. Lensch, P. G. Jones and G. M. Sheldrick, *Z. Naturforsch., Teil B*, 1982, **37**, 944.
- 17 H. Schmidbaur, A. Kolb, E. Zeller, A. Schier and H. Beruda, *Z. Anorg. Allg. Chem.*, 1993, **619**, 1575.
- 18 K. Angermaier and H. Schmidbaur, *Chem. Ber.*, 1994, **127**, 2387.
- 19 F. Canales, M. C. Gimeno, P. G. Jones and A. Laguna, *Angew. Chem.*, 1994, **106**, 811.
- 20 A. Sladek and H. Schmidbaur, *Inorg. Chem.*, 1996, **35**, 3268.
- 21 R. J. Staples, S. Wang, J. P. Fackler, jun., S. O. Grim and E. de Laubenfels, *Acta Crystallogr., Sect. C*, 1994, **50**, 1242.
- 22 A. M. Mazany and J. P. Fackler, jun., *J. Am. Chem. Soc.*, 1984, **106**, 801.
- 23 S. Wang and J. P. Fackler, jun., *Organometallics*, 1988, **7**, 2415.
- 24 G. Peters, *J. Org. Chem.*, 1962, **27**, 2198.
- 25 C. K. Johnson, ORTEP, Report ORNL-5138, Oak Ridge National Laboratory, Oak Ridge, TN, 1976.
- 26 H. Schmidbaur and R. Franke, *Inorg. Chim. Acta*, 1975, **13**, 85.
- 27 A. N. Nesmeyanov, E. G. Perevalova, Y. T. Struchkov, M. Y. Antipin, K. I. Grandberg and V. P. Dyadchenko, *J. Organomet. Chem.*, 1980, **201**, 343.
- 28 K. Angermaier, E. Zeller and H. Schmidbaur, *J. Organomet. Chem.*, 1994, **472**, 371.
- 29 Y. Yang, V. Ramamoorthy and P. R. Sharp, *Inorg. Chem.*, 1993, **32**, 1946.
- 30 K. C. Dash and H. Schmidbaur, *Chem. Ber.*, 1973, **106**, 1221.
- 31 N. C. Baenziger, W. E. Bennet and D. M. Soboroff, *Acta Crystallogr., Sect. B*, 1976, **32**, 962.
- 32 A. K. Al-Saady, C. A. McAuliffe, R. V. Parish and J. A. Sandbank, *Inorg. Synth.*, 1985, **23**, 191.
- 33 W. Kuchen, K. Strolenberg and J. Metten, *Chem. Ber.*, 1963, **96**, 1733.
- 34 J. Hahn and T. Nataniel, *Z. Anorg. Allg. Chem.*, 1986, **543**, 7.
- 35 G. M. Sheldrick, SHELXL 93, Universität Göttingen, 1993.

Received 18th August 1997; Paper 7/06033E