

# Carbanions as Intermediates in the Formation of Grignard Reagents

Gerard P. M. van Klink,<sup>\*,†,‡</sup> Henricus J. R. de Boer,<sup>†</sup> Gerrit Schat,<sup>†</sup>  
Otto S. Akkerman,<sup>†</sup> Friedrich Bickelhaupt,<sup>\*,†</sup> and Anthony L. Spek<sup>§,||</sup>

*Scheikundig Laboratorium, Vrije Universiteit Amsterdam, De Boelelaan 1083,  
1081 HV Amsterdam, The Netherlands, and Bijvoet Center for Biomolecular Research,  
Department of Crystal and Structural Chemistry, and Department of Metal-Mediated  
Synthesis, Utrecht University, Padualaan 8, 3584 CH Utrecht, The Netherlands*

Received December 20, 2001

The reaction between certain aryl bromides RBr having substituents with group 14 elements and magnesium in THF to form the corresponding Grignard reagents RMgBr were found to be accompanied by unusual migrations of the group 14 functionality; it partially exchanges position with that of the original aryl bromide function. This migration is purely intramolecular for organosilicon derivatives but both intra- and intermolecular for the corresponding tin compounds. For example, 1-bromo-2-((trimethylsilyl)methyl)benzene (**1b**) gives rise to 1-(bromomagnesium)-2-((trimethylsilyl)methyl)benzene (**2b**) and to its intramolecular rearrangement product 1-((bromomagnesium)methyl)-2-(trimethylsilyl)benzene (**3b**), whereas the trimethylstannyl analogue **1a** forms, in addition to the two corresponding Grignard reagents **2a** and **3a** formed by the intramolecular pathway, the intermolecular exchange products 1-(trimethylstannyl)-2-((trimethylstannyl)methyl)benzene (**4a**) and 1-(bromomagnesium)-2-((bromomagnesium)methyl)benzene (**5'**). These results, together with those from analogous reactions of compounds such as 1-bromo-2-(trimethylstannyl)benzene (**18**), its 5-methyl derivative **23**, 2-bromo-2'-(trimethylstannyl)biphenyl (**40**), and its silicon analogue **57**, can be convincingly explained by invoking the intermediate formation of the highly reactive carbanion R<sup>-</sup>, which may in some cases be slightly stabilized by formation of an (intra- or intermolecular) stannate (or silicate) complex. Another serious candidate for such migrations would have been the radical R<sup>•</sup>, the occurrence of which is well-documented in Grignard reactions. However, this alternative route could be excluded by producing this radical in an unambiguous fashion from **1a** and samarium(II) diiodide; under these conditions, hydrogen abstraction by R<sup>•</sup> strongly predominated, and minor quantities of rearranged products were shown to be due to further reduction of R<sup>•</sup> to R<sup>-</sup>.

## Introduction

Over 100 years have elapsed since the discovery by Victor Grignard that organic halides RX react with metallic magnesium to furnish organomagnesium halides RMgX, generally known as Grignard reagents.<sup>1</sup> Usually, this reaction occurs with ease and in high yield, according to the deceptively simple overall Equation (1).



In view of the importance of Grignard reagents as synthetic tools, their structure and chemistry have been intensively investigated. This also holds for their mechanism of formation, which, not surprisingly, does not proceed by simple insertion of one magnesium atom into

the carbon–halogen bond. Rather, a number of steps and intermediates are involved, and the investigations are hampered by the heterogeneous nature of the reaction. It is, therefore, not surprising that, despite considerable efforts, a number of unresolved issues and even controversies still persist. Partial consensus has been reached on most of the steps depicted in Scheme 1.<sup>2–5</sup> Several additional features and alternative routes have been proposed; these will be addressed below.

Step 1 is believed to be an outer-sphere electron transfer from the magnesium surface to the organic halide RX, resulting in the formation of the radical

(2) (a) Kharasch, M. S.; Reinmuth, O. In *Grignard Reactions of Nonmetallic Substances*; Prentice Hall: New York, 1954. (b) Lindsell, W. E. In *Comprehensive Organometallic Chemistry*, 2nd ed.; Abel, E. W., Stone, F. G. A., Wilkinson, G., Eds.; Elsevier: Oxford, U.K., 1995; Vol. 1, Chapter 3, pp 57–63. (c) Nützel, K. In *Methoden der Organischen Chemie (Houben Weyl)*; Müller, E., Ed.; Georg Thieme Verlag: Stuttgart, Germany, 1973; Vol. 13/2a, pp 47–528.

(3) Hamdouchi, C.; Walborsky, H. M. In *Handbook of Grignard Reagents*; Silverman, G. S., Rakita, P. E., Eds.; Dekker: New York, 1996; Chapter 10, pp 145–218.

(4) Garst, J. F.; Ungváry, F. In *Grignard Reagents, New Developments*; Richey, H. G., Ed.; Wiley: Chichester, U.K., 2000; Chapter 7, pp 185–275.

(5) van Klink, G. P. M. Thesis, Vrije Universiteit, Amsterdam, 1998.

\* To whom correspondence should be addressed. E-mail: G.P.M.v.K., g.p.m.vanklink@chem.uu.nl; F.B., bicklht@chem.vu.nl. Fax: G.P.M.v.K., +31-30-2523615.

<sup>†</sup> Vrije Universiteit Amsterdam.

<sup>‡</sup> Department of Metal-Mediated Synthesis, Utrecht University.

<sup>§</sup> Department of Crystal and Structural Chemistry, Utrecht University.

<sup>||</sup> Address correspondence pertaining to crystallographic studies to this author. E-mail: A.L.Spek@chem.uu.nl.

(1) Grignard, V. *C. R. Hebd. Seances Acad. Sci.* **1900**, *130*, 1322.

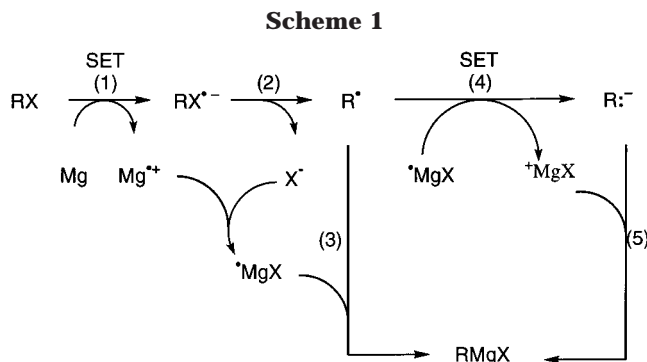

anion  $RX^{\bullet-}$ .<sup>6–10</sup> Although  $RX^{\bullet-}$  has been suggested to occur as a discrete intermediate along the reaction coordinate,<sup>3,6</sup> such species have never been detected directly.<sup>7c,d,9c,11</sup> Therefore, certainly for alkyl halides, they probably resemble a transition state rather than an intermediate. Kinetic investigations have shown that the outer-sphere electron transfer is the rate-determining step.<sup>7b–f</sup> The second stage involves a rapid dissociation of  $RX^{\bullet-}$  into  $R^{\bullet}$  and  $X^-$  (step 2); the latter may combine with  $Mg^{2+}$  at the electron-deficient magnesium surface<sup>2,3,12</sup> to give the (probably surface-bound) magnesium halide  $\bullet MgX$ . The intermediate occurrence of radicals  $R^{\bullet}$  has been well-established.<sup>6–9,12–18</sup> In step 3,  $R^{\bullet}$  combines with  $\bullet MgX$  to form  $RMgX$ . The possibility that  $R_2Mg$  might be the initially generated species has

been ruled out in at least one case.<sup>18</sup> It is still a matter of controversy whether  $R^{\bullet}$  remains coordinated to the magnesium surface<sup>3,6,15</sup> or whether most of the radicals diffuse from the magnesium surface into the solution, where they may either perform typical radical reactions such as hydrogen abstraction, dimerization, etc. or return to the magnesium surface to give (additional)  $RMgX$ .<sup>4,7,13,16,19</sup>

One aspect of Scheme 1 has so far received much less attention. It is conceivable that a (second) single-electron transfer occurs to  $R^{\bullet}$  with formation of the carbanion  $R:^-$  (step 4); formally, this is accompanied by oxidation of  $\bullet MgX$  to  $^+MgX$ . As early as 1959, Prévost et al. proposed that  $RX$  was reduced to  $R:^-$  in a *single* step, i.e., without the intermediate formation of radicals, which after combination of  $R:^-$  with  $^+MgX$  would lead to  $RMgX$  (step 5).<sup>20</sup> However, relevant experimental evidence for his proposal was not supplied and as in the meantime the radical nature of the Grignard reagent formation reaction has been unambiguously established, such a direct formation of a carbanion is not in accord with current thought.

A major problem is that carbanions, even if they are true intermediates, cannot be detected by kinetics because they are generated after the rate-determining step (1).<sup>7,16,19</sup> However, evidence for the transient formation of carbanions was accidentally obtained from an unprecedented rearrangement occurring during the reaction of 1-bromo-2-((trimethylstannyl)methyl)benzene (**1a**) with magnesium in THF (vide infra).<sup>21</sup> Independent support for a carbanionic species was provided by the formation of crown ether cleavage products during the synthesis of [2-(bromomagnesio)-1,3-xylylene]-18-crown-5 from the corresponding bromide and magnesium in THF.<sup>22</sup>

## Results and Discussion

**Intra- and Intermolecular Migration of Stannyl Groups.** It was previously shown that when **1a** was allowed to react with magnesium in THF, **2a** (15%), **3a** (29%), **4a** (28%), and **5** (28%) were formed. These compounds were characterized as **6a**, **7a**, **4a**, and **8**, respectively, on quenching with chlorotrimethylgermane (Scheme 2).<sup>21</sup> The ratio of these products did not change even after keeping the primary reaction mixture at room

(6) (a) Walborsky, H. M.; Young, A. E. *J. Am. Chem. Soc.* **1961**, *83*, 2595. (b) Walborsky, H. M.; Young, A. E. *J. Am. Chem. Soc.* **1964**, *86*, 3288. (c) Walborsky, H. M.; Aronoff, M. F. *J. Organomet. Chem.* **1973**, *51*, 31. (d) Walborsky, H. M.; Banks, R. M. *Bull. Soc. Chim. Belg.* **1980**, *89*, 849. (e) Walborsky, H. M. *Tetrahedron* **1981**, *37*, 1625. (f) Walborsky, H. M.; Rachon, J. *J. Am. Chem. Soc.* **1989**, *111*, 1896. (g) Rachon, J.; Walborsky, H. M. *Tetrahedron Lett.* **1989**, *30*, 7345.

(7) (a) Rogers, H. R.; Mitchell, H. L.; Fujiwara, Y.; Whitesides, G. M. *J. Org. Chem.* **1974**, *39*, 857. (b) Rogers, H. R.; Deutch, J. E.; Whitesides, G. M. *J. Am. Chem. Soc.* **1980**, *102*, 226. (c) Rogers, H. R.; Rogers, R. J.; Mitchell, H. L.; Whitesides, G. M. *J. Am. Chem. Soc.* **1980**, *102*, 231. (d) Barber, J. J.; Whitesides, G. M. *J. Am. Chem. Soc.* **1980**, *102*, 239. (e) Rogers, H. R.; Hill, C. L.; Fujiwara, Y.; Whitesides, G. M. *J. Am. Chem. Soc.* **1980**, *102*, 271. (f) Lawrence, L. M.; Whitesides, G. M. *J. Am. Chem. Soc.* **1980**, *102*, 2493. (g) Root, K. S.; Deutch, J. E.; Whitesides, G. M. *J. Am. Chem. Soc.* **1981**, *103*, 5475.

(8) Vogler, E. A.; Stein, R. A.; Hayes, J. M. *J. Am. Chem. Soc.* **1978**, *100*, 3163.

(9) (a) Garst, J. F. *Acc. Chem. Res.* **1971**, *4*, 400. (b) Garst, J. F.; Roberts, R. D.; Pacifici, J. A. *J. Am. Chem. Soc.* **1977**, *99*, 3528. (c) Becker, J. Y. In *The Chemistry of Functional Groups*; Patai, S., Rappoport, Z., Eds.; Wiley: New York, 1983; Supplement D, Chapter 6, pp 204–287.

(10) Canadell, E.; Karafolou, P.; Salem, L. *J. Am. Chem. Soc.* **1980**, *102*, 855.

(11) (a) Andrieux, C. P.; Callardo, I.; Saveant, J. M.; Su, K. B. *J. Am. Chem. Soc.* **1986**, *108*, 638. (b) Andrieux, C. P.; Savéant, J. M.; Su, K. B. *J. Phys. Chem.* **1986**, *90*, 3815.

(12) Bodewitz, H. W. H. J.; Blomberg, C.; Bickelhaupt, F. *Tetrahedron* **1973**, *29*, 719.

(13) (a) Garst, J. F.; Easton, L. K.; Batlaw, J.; Boone, J. R.; Ungváry, F. *Inorg. Chim. Acta* **1994**, *222*, 365. (b) Garst, J. F.; Ungváry, F.; Baxter, J. T. *J. Am. Chem. Soc.* **1997**, *119*, 253.

(14) (a) Rüdhardt, C.; Trautwein, H. *Ber. Bunsen-Ges. Phys. Chem.* **1962**, *95*, 1197. (b) Patel, D. J.; Hamilton, C. L.; Roberts, J. D. *J. Am. Chem. Soc.* **1965**, *87*, 5144. (c) Lamb, R. C.; Ayers, P. W.; Toney, M. K.; Garst, J. F. *J. Am. Chem. Soc.* **1970**, *92*, 6609. (d) Grootveld, H. H.; Blomberg, C.; Bickelhaupt, F. *Tetrahedron Lett.* **1971**, 1999. (e) Buske, G. R.; Ford, W. T. *J. Org. Chem.* **1976**, *41*, 1998. (f) Grovenstein, E.; Cottingham, A. B.; Gelbaum, L. T. *J. Org. Chem.* **1978**, *43*, 3332. (g) Jones, L. A.; Kirby, S. L.; Kean, D. M.; Campbell, G. L. *J. Organomet. Chem.* **1985**, *284*, 159.

(15) (a) Dubois, J. E.; Molle, G.; Tourillon, G.; Bauer, P. *Tetrahedron Lett.* **1979**, 5069. (b) Molle, G.; Dubois, J. E. *J. Org. Chem.* **1982**, *47*, 4120.

(16) (a) Bodewitz, H. W. H. J.; Blomberg, C.; Bickelhaupt, F. *Tetrahedron Lett.* **1972**, 281. (b) Bickelhaupt, F. *J. Organomet. Chem.* **1994**, *475*, 1 and references cited therein.

(17) (a) Chanon, M. *Bull. Soc. Chim. Fr.* **1982**, 7–8, 197. (b) Chanon, M.; Négrel, J. C.; Bodineau, N.; Mattalia, J. M.; Péralez, E. *Macromol. Symp.* **1998**, *134*, 13. (c) Péralez, E.; Négrel, J. C.; Goursot, A.; Chanon, M. *Main Group Met. Chem.* **1998**, *21*, 69. (d) Péralez, E.; Négrel, J. C.; Goursot, A.; Chanon, M. *Main Group Met. Chem.* **1999**, *22*, 185. (e) Péralez, E.; Négrel, J. C.; Goursot, A.; Chanon, M. *Main Group Met. Chem.* **1999**, *22*, 201. (f) Bodineau, N.; Mattalia, J. M.; Thimokin, V.; Handoo, K.; Négrel, J. C.; Chanon, M. *Org. Lett.* **2000**, 2303.

(18) Bodewitz, H. W. H. J.; Blomberg, C.; Bickelhaupt, F. *Tetrahedron Lett.* **1975**, 2003.

(19) (a) Garst, J. F.; Deutch, J. E.; Whitesides, G. M. *J. Am. Chem. Soc.* **1986**, *108*, 2490. (b) Ashby, E. C.; Oswald, J. *J. Org. Chem.* **1988**, *53*, 6068. (c) Garst, J. F.; Swift, B. L.; Smith, D. W. *J. Am. Chem. Soc.* **1989**, *111*, 234. (d) Garst, J. F.; Swift, B. L. *J. Am. Chem. Soc.* **1989**, *111*, 241. (e) Root, R. S.; Lawrence, L. M.; Whitesides, G. M. *J. Am. Chem. Soc.* **1989**, *111*, 5405.

(20) (a) Prévost, C.; Gaudemar, M.; Miginiac, L.; Gaudemar, F.; Andrac, M. *Bull. Soc. Chim. Fr.* **1959**, 679. (b) Andrac, M.; Gaudemar, F.; Gaudemar, M.; Gross, B.; Miginiac, L.; Miginiac, P.; Prévost, C. *Bull. Soc. Chim. Fr.* **1963**, 1385.

(21) de Boer, H. J. R.; Akkerman, O. S.; Bickelhaupt, F. *Angew. Chem.* **1988**, *100*, 735.

(22) Markies, P. R.; Akkerman, O. S.; Bickelhaupt, F.; Smeets, W. J. J.; Spek, A. L. *J. Am. Chem. Soc.* **1988**, *110*, 4284.

Scheme 2

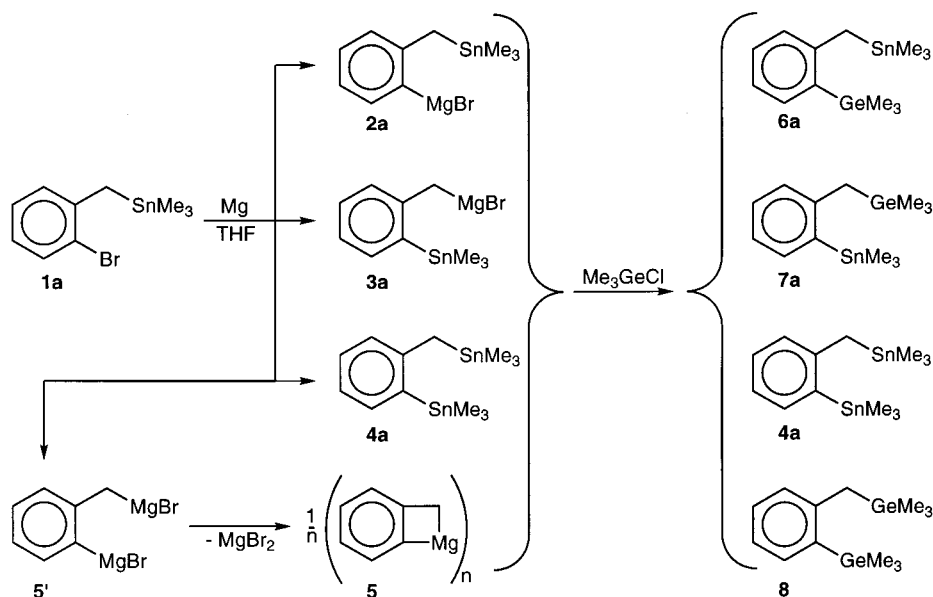

Scheme 3

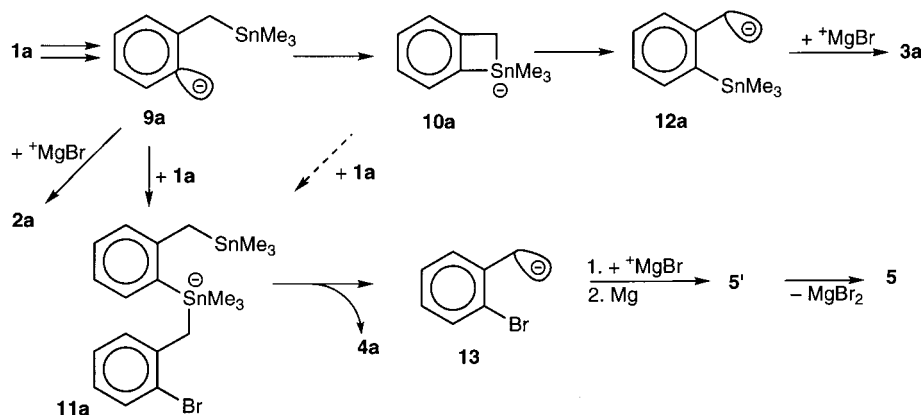

temperature for about 2 weeks before quenching. In the meantime, we checked that these product ratios were not due to the establishment of a rapid equilibrium in THF as follows: after the reaction of **1a** with magnesium in THF had reached completion, the resulting slurries were decanted from the excess magnesium, the solvent was evaporated, and the residues were stirred for 1 week in benzene or anisole, followed by evaporation of the benzene or anisole, rapid readdition of THF, and quenching with chlorotrimethylgermane; the ratio of products was unchanged within the limits of error (about 3%).

The intramolecular (**3a**) and intermolecular (**4a** and **5**) migration of the original stannyl substituent of **1a** was rationalized to be initiated by the carbanion **9a** (Scheme 3), which corresponds to  $R^-$  formed in step 4 of Scheme 1. When it attacks a tin atom, **9a** will form an ate complex; this may happen either intramolecularly to give **10a** or intermolecularly to give **11a**. The reaction proceeds further by cleavage of the weakest bond, i.e., the benzylic carbon–tin bond, to afford the carbanions **12a** and **13**, respectively. In line with this reasoning, the reaction of 2-(trimethylstannyl)benzyl chloride with magnesium under the same reaction

conditions provided the chloro analogue of **3a** without any products derived from tin migration.<sup>23</sup>

Combination of **12a** with  $+MgBr$  yields **3a**; reaction of **13** with  $+MgBr$  followed by transformation of its aryl bromide function to the Grignard functionality ultimately furnishes **5** (**5'** is the primary product, but it disproportionates in THF to magnesium bromide and **5**, which precipitates<sup>24</sup>). Such metal–metal exchange reactions were unknown for organomagnesium compounds, except in reactions with strained four-membered stannacycles,<sup>24a,25</sup> but are well-known for the more strongly carbanionoid organolithium compounds.<sup>26</sup>

Interestingly, when the reaction between **1a** and magnesium in THF was performed at 60 °C, it gave a clearly different product distribution: 28% **6a**, 4% **7a**,

(23) de Boer, H. J. R. Thesis, Vrije Universiteit, Amsterdam, 1988.

(24) (a) de Boer, H. J. R.; Akkerman, O. S.; Bickelhaupt, F. J. *Organomet. Chem.* **1987**, *321*, 291. (b) de Boer, H. J. R.; Akkerman, O. S.; Bickelhaupt, F. In *Organometallic Synthesis*; Eisch, J. J., King, R. B., Eds.; Elsevier: New York, 1988; Vol. 4, p 396.

(25) (a) Seetz, J. W. F. L.; Akkerman, O. S.; Bickelhaupt, F. *J. Am. Chem. Soc.* **1983**, *105*, 3336. (b) Bruin, J. R.; Schat, G.; Akkerman, O. S.; Bickelhaupt, F. *J. Organomet. Chem.* **1983**, *228*, 13.

(26) (a) Gilman, H.; Rosenberg, S. D. *J. Org. Chem.* **1959**, *24*, 2063. (b) Seyferth, D.; Suzuki, R.; Murphy, C. J.; Sabet, C. R. *J. Organomet. Chem.* **1964**, *2*, 431. (c) Bott, R. W.; Eaborn, C.; Walton, D. R. M. *J. Organomet. Chem.* **1964**, *2*, 154. (d) Maercker, A.; Stötzl, R. *Chem. Ber.* **1987**, *120*, 1695.

Scheme 4

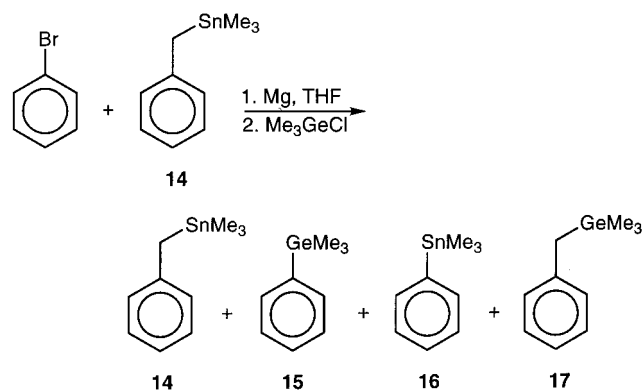

34% **4a**, and 34% **8**, respectively, were obtained on quenching with Me<sub>3</sub>GeCl; note that, in accordance with the intermolecular exchange mechanism of Scheme 3, **4a** and **8** were again formed in a 1:1 ratio. The low yield of **7a** indicates that intramolecular stannyl migration is less favored at elevated temperatures at the expense of all other products. This can be rationalized as follows. The intramolecular rearrangement of **9a** to **10a** is favored by entropy. At higher temperature, this advantage becomes less important, and the intermolecular transformations of **9a** to **2a** or **11a** become more competitive.

A problem with the mechanism proposed in Scheme 3 is that one must assume that a "naked" carbanion such as **9a** is quite reactive in order to facilitate the unusual attack on a tetraorganylstannane functionality, while on the other hand, it has to be sufficiently long-lived to encounter another **1a** (for the formation of **11a**) rather than, for example, cleave a THF molecule, a reaction well-known for the presumably less reactive organolithium reagents, certainly at higher temperatures.

For that reason, we also looked for other examples of intermolecular tin exchange in the formation reaction.<sup>21</sup> The preparation of phenylmagnesium bromide from bromobenzene and magnesium in THF in the presence of 1 equiv of benzyltrimethylstannane (**14**) followed by quenching of the reaction mixture with Me<sub>3</sub>GeCl gave not only the expected **15** and unreacted **14** (both in 84% yield) but also the unexpected products **16** and **17** (both in 14% yield) (Scheme 4); note that, like **4a** and **8**, **16** and **17** were again obtained in a 1:1 ratio. While **15** is the derivatization product from the expected phenylmagnesium bromide, **16** and **17**—the latter derived from benzylmagnesium bromide—are formed by intermolecular exchange at the intermediate carbanion stage via an ate complex. In an independent experiment, the reaction mixture was deuteriolized to yield 12% deuterated toluene (the analogue of **17**), 76% **14**, and 12% **16** (deuteriobenzene, the analogue of **15**, could not be separated from the solvents and was not determined). These exchange reactions must also occur during the formation process, because phenylmagnesium bromide was found to be inert toward **14** under these conditions.<sup>21</sup>

Intermolecular migrations are not restricted to **14**, as was shown by the reaction depicted in Scheme 5. After **18** was reacted with magnesium in THF, using 1,2-dibromoethane as entrainer, tin migration was estab-

lished by derivatization with Me<sub>3</sub>GeCl, which revealed that, in addition to the expected **19** (77%), **20** (7%) and **21** (7%) had been formed. As in the previous cases, **20** and **21** occur in the ratio 1:1, as required for intermolecular exchange.

Intramolecular rearrangement is obviously not detectable in this experiment, because if the primarily formed carbanion **22** did rearrange, this would lead to the indistinguishable **22'**, both of which lead to the identical product **19**. Therefore, it was decided to synthesize **23**. Intramolecular rearrangement should now be detectable, because the rearranged and unrearranged products would not be identical. Synthesis of **23** started from 2-bromo-4-methylaniline, which was converted to the iodide **24** by a diazotization reaction; selective lithium iodine exchange of **24** with *n*-butyllithium, in a mixture of diethyl ether and THF at -100 °C, followed by derivatization with Me<sub>3</sub>SnCl resulted in the formation of **23**.

Surprisingly, reaction of **23** with sublimed magnesium in THF was extremely slow. Only after 1 month was the reaction complete. Use of 1,2-dibromoethane as an entraining agent did not accelerate the reaction. The reason for this strongly reduced reactivity cannot be ascribed to steric factors, because the non-methyl-substituted **18** reacted within 1 day. Quenching of a sample with Me<sub>3</sub>GeCl revealed the formation of **25** (96%), **26** (2%), and **27** (2%); the last two are derived from intermolecular rearrangement (Scheme 6).

Separation of the product mixture by GLC and analysis by <sup>1</sup>H NMR spectroscopy unambiguously confirmed that only **25** had been formed, and no rearranged **28** (Scheme 7). The reason for the absence of **28** is the ring strain that would be involved in the intermediate stannate complex **30**; its trigonal-bipyramidal structure would be highly distorted with an axial-equatorial angle of 60° instead of the ideal 90°. The barrier for the formation of **30** is apparently so high that an intramolecular exchange does not occur. Thus, once the carbanionic intermediate **29** has been formed, its only option is *intermolecular* stannate complexation, followed by expulsion of **26** and recombination with <sup>+</sup>MgBr to give (after Me<sub>3</sub>GeCl quench) **27**; this should result in formation of **26** and **27** in a 1:1 ratio as experimentally observed (Scheme 7).

We also investigated the reaction of **31** with magnesium in THF in order to test the above-mentioned speculation that reaction of **23** with magnesium was slow due to the steric hindrance of the *o*-trimethylstannyl group (Scheme 8). Furthermore, **28** could thus be obtained in an unambiguous way, and its data could be used to prove its absence in the reaction of **23** with magnesium.

Again, the reaction was slow, though slightly faster than that of **23**; it gave **33** quantitatively after 2 weeks, as confirmed by quenching a sample with D<sub>2</sub>O followed by <sup>1</sup>H NMR spectroscopy and GCMS analysis, which showed the quantitative formation of **32**. A second sample was derivatized with Me<sub>3</sub>SnCl; <sup>1</sup>H and <sup>13</sup>C NMR spectroscopy as well as GCMS showed the quantitative conversion of **31** to **28**. Reexamination of the analytical data for the reaction of **23** with magnesium unambiguously confirmed the absence of **28** in the tin case and thus once again underlined that intramolecular stannyl

Scheme 5

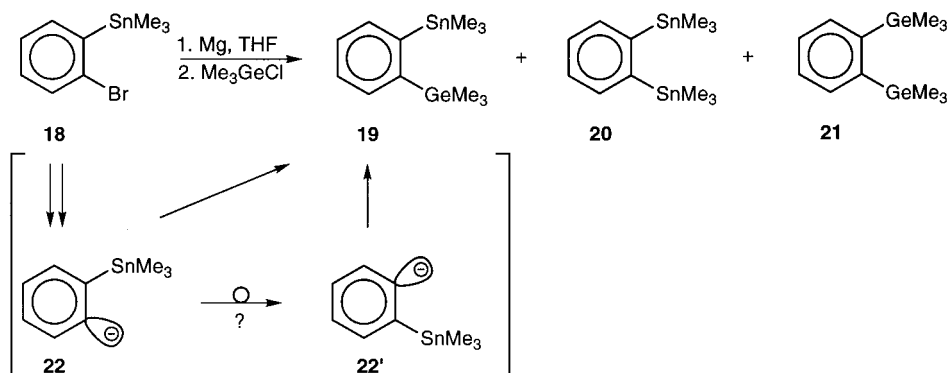

Scheme 6

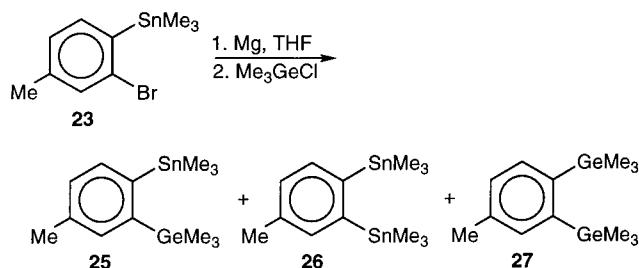

migration did not occur in the reaction of **23** with magnesium.

In another attempt to define the factors responsible for the interplay between intra- and intermolecular transformations, the behavior of 1-bromo-2-((tri-*n*-butylstannyl)methyl)benzene (**34**) under the conditions of Grignard reagent formation was investigated. The choice of **34** was based on the consideration that, by introducing the (*n*-Bu) $_3$ Sn substituent at the benzylic position, both the intermediate radical and the carbanion might have longer lifetimes due to the sterically more demanding substituent. This was expected not only to favor reduction of the radical to the carbanion but also to increase the extent of intramolecular rearrangement due to the bulkier stannyl substituent, which would impede a bimolecular encounter. When **34** was allowed to react with magnesium in THF, this was indeed observed (Scheme 9). Quenching a sample of the reaction mixture with  $\text{D}_2\text{O}$  yielded 18% [2-D]((tri-*n*-butylstannyl)methyl)benzene (**35**) and 82% 1-[D]methyl-2-(tri-*n*-butylstannyl)benzene (**36**).

Derivatization of a sample with  $\text{Me}_3\text{GeCl}$  showed similar results: 16% **37** and 64% **38**; in addition, also 10% **39** and 10% **8** were detected. The conclusion is justified that, due to the bulky tri-*n*-butylstannyl group, the possibility for a bimolecular coupling is diminished. Furthermore, due to the longer lifetime of the intermediate carbanion, intramolecular rearrangement to the more stable carbanion is enhanced.

In an attempt to prove that it is the high ring strain energy of the stannate complex **30** which is responsible for the nonoccurrence of the intramolecular rearrangement, and not the greater strength of the aryl carbon–tin bond (as compared to the benzylic carbon–tin bond in **10a**), **40** was synthesized from 2,2'-dibromobiphenyl<sup>27</sup> by monolithiation followed by derivatization with  $\text{Me}_3$ -

SnCl. While reaction of **40** with magnesium in diethyl ether did not occur, in THF an unforeseen ring closure was observed. Quenching of a sample with  $\text{Me}_3\text{GeCl}$  afforded **41** in only 21% yield (Scheme 10). Besides **41**, **42** was formed in 9% yield. Surprisingly, the ring-closed 9,9-dimethylstannafluorene (**43**) was the major product (70% yield). Deuteriolysis of another sample gave comparable results (see Experimental Section).

With respect to a conceivable intramolecular rearrangement in the reaction of **40** with magnesium, the situation is similar to that of **18**: both would not be discernible by simple product analysis because the initial carbanion **45** (Scheme 11) and its intramolecular rearrangement product would be equivalent. It was, however, expected that the intramolecular ring closure to give the stannate complex **46** would be facilitated by the favorable geometric arrangement of the biphenyl system spanning the equatorial–axial position of the trigonal bipyramid in a five-membered ring. Indeed, this step appears to proceed with great ease, and this is the origin of the high yield of **43**, as rationalized in Scheme 11. The difference with the previously encountered stannyl migrations is that, in **46**, it is not an aryl carbon–tin bond which is cleaved but the methyl carbon–tin bond dissociates with formation of **43**; simultaneously, methylmagnesium bromide is produced in 97% yield with respect to **43**, as determined by  $^1\text{H}$  and  $^{13}\text{C}$  NMR spectroscopy. Apparently, in the cleavage of **46**, the greater stability of the carbanion functionality ( $\text{Ar}^- > \text{Me}^-$ ) is more than compensated by the favorable entropy due to the formation of the five-membered ring and of two particles.

The formation of **43** is not the only anomaly in this reaction. Another surprise was the occurrence of **42**, the derivatization product of the corresponding di-Grignard reagent (**49**; see Scheme 12). While **42** is formally analogous to **8**, **17**, and **21**, all of which indicate the occurrence of an intermolecular exchange process analogous to  $\mathbf{9} \rightarrow \mathbf{11} \rightarrow \mathbf{13}$  (Scheme 3), the corresponding distannyl derivative **44** (Scheme 10) is missing!

We rationalize the formation of **42** as follows (Scheme 12). While the intermolecular attack of carbanion **45** on the tin atom of **40** or **43** is probably impossible due to steric crowding, the transfer of a formal methyl anion from the ate complex **46** to **40** is sterically less demanding and furnishes, besides **43**, the ate complex **47**. The latter is cleaved by  $\text{MgBr}^+$  preferentially at the aryl carbon–tin bond, the (formal) aryl anion being more stable than the methyl anion. The products are  $\text{Me}_4\text{Sn}$

(27) Gilman, H.; Gaj, B. J. *J. Org. Chem.* **1957**, *22*, 447.

Scheme 7

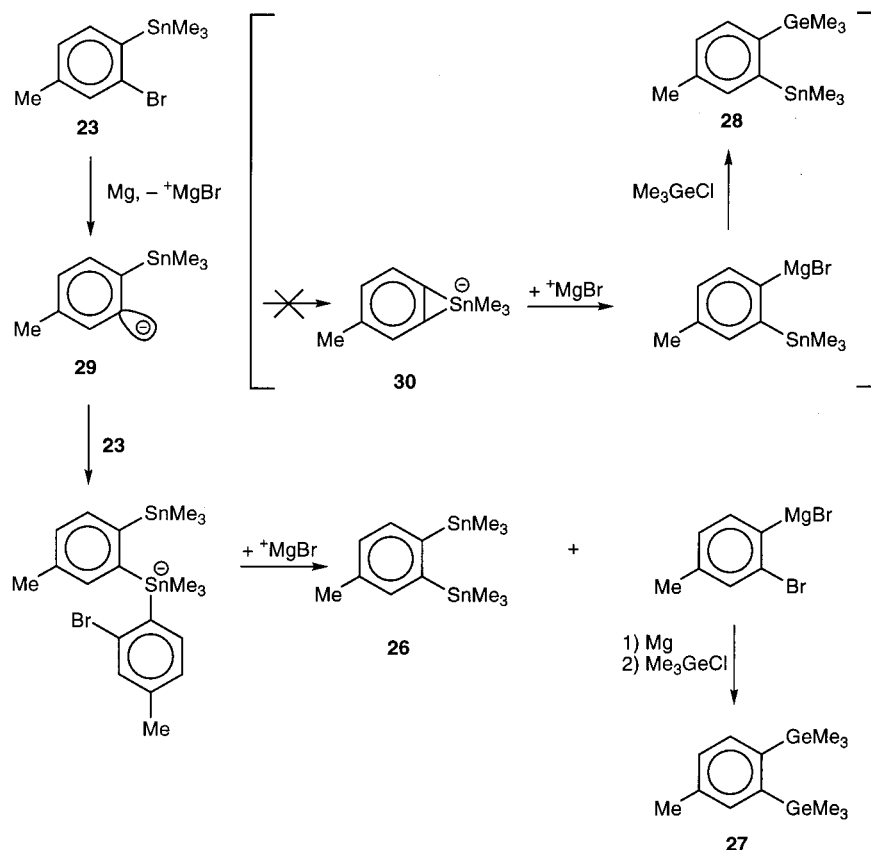

Scheme 8

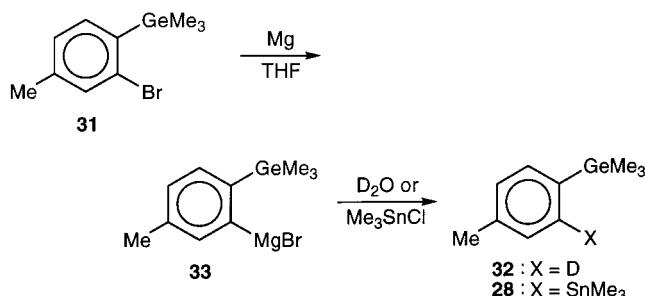

and **48**. Further reaction of **48** with magnesium yields **49**, which, by derivatization with  $\text{Me}_3\text{GeCl}$ , gives **42**. In support of this interpretation,  $\text{Me}_4\text{Sn}$  was identified and determined by  $^1\text{H}$  NMR spectroscopy. While stoichiometry requires the ratio  $\text{Me}_4\text{Sn}:\mathbf{42}$  to be 1:1, it was in fact observed to be 1:3; this may be due to technical problems, in particular by the volatility of  $\text{Me}_4\text{Sn}$  (bp  $78^\circ\text{C}$ ).

In this case also, the product distribution did not alter from the initial one upon standing at room temperature or heating at  $70^\circ\text{C}$  (apart from the amount of  $\text{Me}_4\text{Sn}$ , which appeared to vary between the different  $^1\text{H}$  NMR measurements). To confirm the nonexistence of an equilibrium between **43** and  $\text{MeMgBr}$ , a sample of pure **43** was mixed with  $\text{MeMgBr}$  in THF and stirred for several hours under reflux. After it was cooled to room temperature, the mixture was deuteriolized and, after standard workup, analyzed by  $^1\text{H}$  NMR spectroscopy and GCMS; **43** was recovered quantitatively, and no [2-D]-2'-(trimethylstannyl)biphenyl was observed.

Additional proof for the assigned (monomeric) structure of **43** came from an X-ray structure determination of a single crystal. The tin atom is tetracoordinated in a distorted tetrahedron, with a small C8a–Sn9–C9a angle (Figure 1). The tin atom is positioned only slightly above the biphenylene plane. The bond angles around tin (deg) are C8a–Sn9–C9a =  $84.0(3)$ , C8a–Sn9–C10 =  $115.4(3)$ , and C10–Sn9–C11 =  $110.5(4)$ ; selected bond lengths ( $\text{\AA}$ ) are C8a–Sn9 =  $2.142(9)$ , C9a–Sn9 =  $2.129(8)$ , C10–Sn9 =  $2.133(9)$ , and C11–Sn9 =  $2.139(10)$ . To our knowledge, the dibenzostannole **43** is only the second example of a small stannacycle ( $\text{SnC}_4$ ) with a tetraorganylstannane center for which a crystal structure has been determined. Recently, the crystal structure of 1,1,2,3,4,5-hexaphenylstannacyclopentadiene was published.<sup>28</sup> Molecular models show that the formation of an  $\text{SnC}_4$  ring must involve substantial angle strain, and such strain has been invoked to explain the enhanced heterolytic and homolytic reactivity of the  $\text{SnC}_4$  ring system.<sup>29</sup>

The formation of **43** is explained in terms of a carbanion rather than a radical intermediate for two reasons. In the first place, reaction of 2,2'-dilithiobiphenyl with 2 equiv of  $\text{Me}_3\text{SnCl}$  has been reported to result in the formation of **43**; this undoubtedly must be a carbanion process.<sup>30</sup> Second, treatment of 2-(bro-

(28) Ferman, J.; Kakareka, J. P.; Klooster, W. T.; Mullin, J. L.; Quattrucci, J.; Ricci, J. S.; Tracy, H. J.; Vining, W. J.; Wallace, S. *Inorg. Chem.* **1999**, *38*, 2464.

(29) Davies, A. G.; Tse, M. W.; Kennedy, J. D.; McFarlane, W.; Pyne, G. S.; Ladd, M. F. C.; Povey, D. C. *J. Chem. Soc., Perkin Trans. 2* **1981**, 369.

(30) (a) Neugebauer, W.; Kos, A. J.; Schleyer, P. v. R. *J. Organomet. Chem.* **1982**, *228*, 107. (b) Reich, H. J.; Phillips, N. H. *J. Am. Chem. Soc.* **1986**, *108*, 2102.

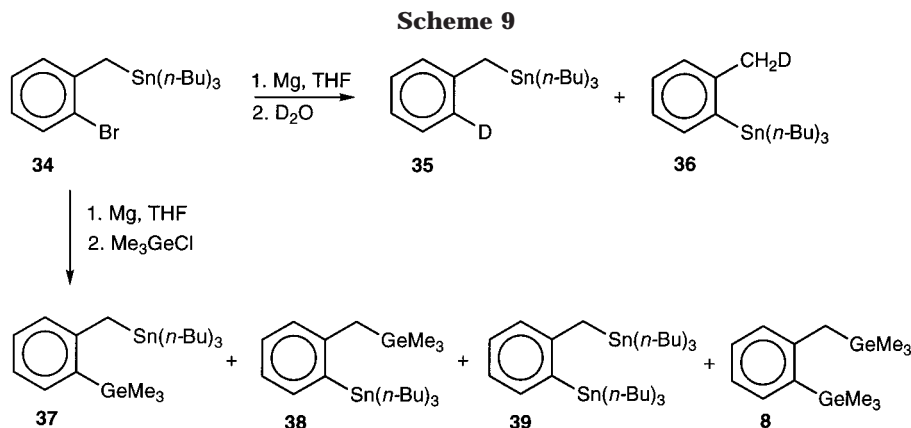
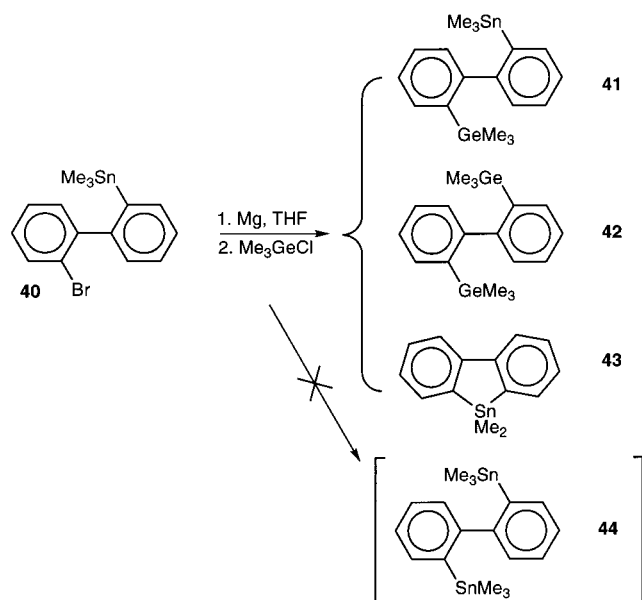
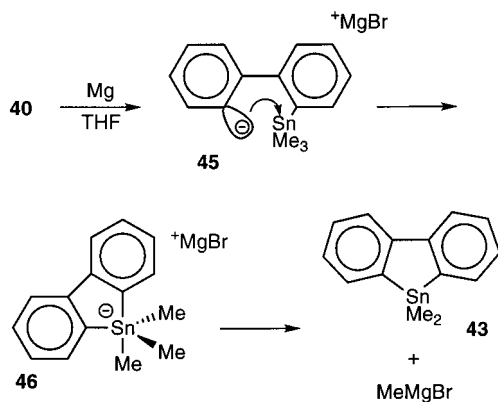
**Scheme 10****Scheme 11**

momethyl)-2'-iodobiphenyl with methyllithium yielded fluorene; a detailed mechanistic investigation revealed that this cyclization, too, most likely proceeded by a carbanion route rather than via radical intermediates.<sup>31</sup>

**Intramolecular Migration of Silyl Groups.** For comparison with the rearrangements observed for organotin compounds, we also briefly investigated the behavior of analogous silicon derivatives. Surprisingly, in this class, only *intramolecular* migrations occurred.

Thus **1b**, the silicon analogue of **1a** (Scheme 2), reacted quantitatively on stirring for 24 h with magnesium in THF. However, deuteriolysis followed by GCMS and NMR spectroscopy proved that in fact two Grignard reagents had been formed, as both **50** (22%) and **51** (67%) were obtained (Scheme 13); on prolonged standing at room temperature before deuteriolysis, the composition remained unchanged. Treatment of the Grignard mixture with  $Me_3SnCl$  gave a mixture of **52** and **53** which, unfortunately, could not be separated or reliably analyzed. However, **4a** and **4b**, the products of intermolecular exchange of silyl groups, were clearly absent.

Therefore, one may conclude the reaction of **1b** with magnesium leads not only to the unrearranged Grignard reagent **2b** but also to the rearranged **3b** (Scheme 14); this process occurs only during the formation reaction and not afterward, and this again is ascribed to the highly reactive carbanionic intermediate **9b** analogous to **9a** (Scheme 3). We recently reported that in the related case of the formation of di-Grignard reagents from **54**, only intramolecular migration of the trimethylsilyl group occurred, leading to a mixture of **55** and **56**.<sup>32</sup>

The high percentage of ring closure to **43** in the reaction of **40** with magnesium induced us to perform the same reaction with the silyl analogue **57**. As **1b** gave intramolecular rearrangements exclusively, it was envisaged that 9,9-dimethyl-9-silafluorene (**58**) would be obtained in even higher yield. Indeed, reaction of **57** with 2 equiv of magnesium in THF led to the formation of **58** in 91% yield. Also in this case, again no products resulting from intermolecular silyl migration were found (Scheme 15).

The difference in behavior between the silyl and stannyl derivatives was not foreseen, but in retrospect it gives additional support to our proposal that relatively free, and therefore highly reactive, carbanions such as **9a** (Scheme 3) are responsible for the observed anomalous rearrangements. In the first place, strongly carbanionic species such as organolithium or higher organoalkali-metal compounds react rapidly with ethers with proton abstraction;<sup>33</sup> THF is particularly notorious in this regard. Against this background, it is surprising that the possibly even more reactive carbanions would be sufficiently long-lived to survive in THF in order to encounter another organotin compound, as required for

(31) Altman, L. J.; Erdman, T. R. *J. Org. Chem.* **1970**, *35*, 3237.

(32) de Boer, H. J. R.; Plugge, M.; Akkerman, O. S.; Bickelhaupt, F. *Main Group Met. Chem.* **2001**, *24*, 93.

(33) Wittig, G. *Angew. Chem.* **1958**, *70*, 65.

Scheme 12

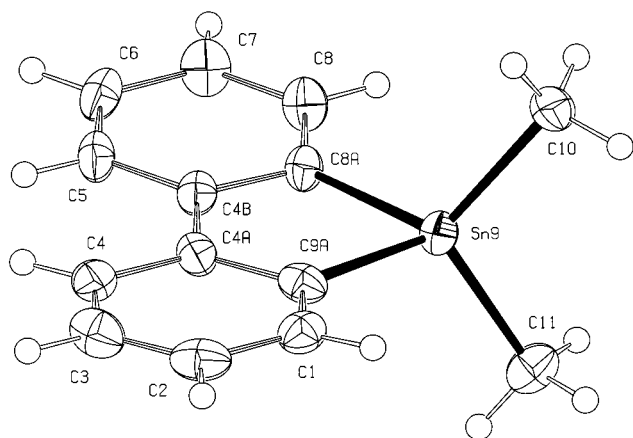
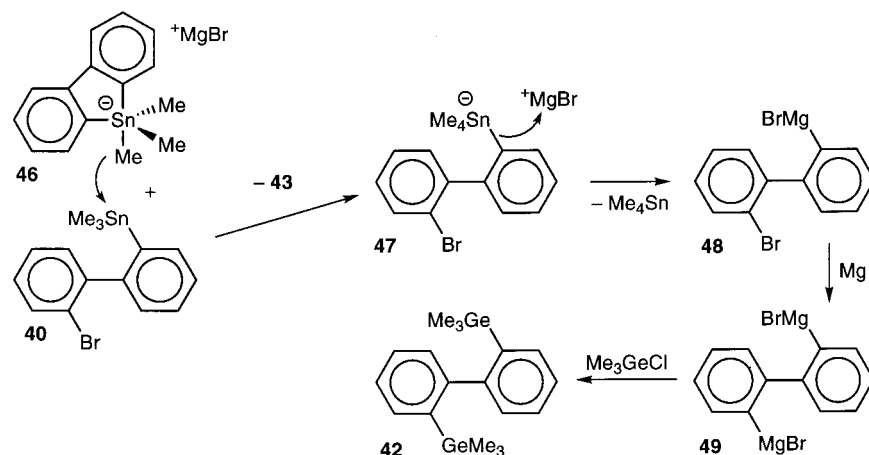

**Figure 1.** Displacement ellipsoid plot (50% probability level) of **43**. Only one out of the two crystallographically independent molecules is shown.

the intermolecular tin exchange via the ate complex **11a** (Scheme 3). Therefore, we suggested<sup>21</sup> that, in these cases, the free carbanion (e.g. **9a**) is to some extent protected against immediate reactions, such as combination with  $^+\text{MgX}$  (Scheme 1) or protonation, by intramolecular attack at the group 14 element to give a cyclic ate complex such as **10a**. The latter forms a pool for subsequent quasi-carbanionoid species giving rise to the observed intra- or intermolecular exchange. Without such intramolecular protection, the level of intermolecular exchange in the tin series is much lower, as in the case of **18** (7%; Scheme 5) or **23** (2%; Schemes 6 and 7).

This hypothesis also explains why, in the silicon series, intramolecular migration is the only mode observed. In general, pentacoordinate organosilicates are much less stable than their stannate analogues.<sup>30,34</sup> More in particular, silicates carrying only carbon<sup>35</sup> or carbon and hydrogen<sup>35c,36</sup> as ligating atoms at silicon are much less stable than their stannate analogues and have, with a few exceptions, been described only recently. For this reason, the silicate complex **10b**, analogous to the stannate complex **10a** (Scheme 3), will be formed less readily and will have an insufficient lifetime to allow an intermolecular encounter with the tetraorganosilane **1b** with formation of **11b**, and hence intermolecular exchange does not occur. In the absence of intramolecular stabilization, the attack of the car-

bation on the silicon function of a second molecule is even less likely, and only the normal reaction pattern does occur: i.e., combination with  $^+\text{MgX}$ . It should, however, be pointed out that in all reactions which lead to the unrearranged product, the reaction may proceed directly via steps 1–3 of Scheme 1 without the necessity of invoking the carbanion intermediate  $\text{R}^-$  (Scheme 1, pathway proceeding via steps 1, 2, 4, and 5).

**Noncarbanionic Rearrangements Are Unlikely.** The evidence presented so far can be explained convincingly by invoking a highly reactive carbanion intermediate as the initiator of intra- and intermolecular migrations of group 14 substituents. Nevertheless, alternative reaction pathways might be equally attractive to rationalize the experimental results. For this reason, we shall consider three a priori feasible possibilities which we will briefly indicate as the dianion, the magnesium cluster, and the radical mechanisms.

The dianion mechanism involving the dianion  $^-\text{R}-\text{X}^-$  as an intermediate has been suggested in the reduction of 2,2-diphenylcyclopropyl halides with alkali-metal naphthalenes<sup>4,37</sup> and in the reaction of 2-(3-butenyl)phenyl halides with magnesium.<sup>38</sup> The mech-

(34) (a) Chuit, C.; Corriu, R. J. P.; Reye, C.; Young, J. C. *Chem. Rev.* **1993**, *93*, 1371. (b) Holmes, R. R. *Chem. Rev.* **1996**, *96*, 927. (c) Deiters, J. A.; Holmes, R. R. *Organometallics* **1996**, *15*, 3944. (d) Kost, D.; Kalikhman, I. In *The Chemistry of Organic Silicon Compounds*; Rappoport, Z., Apeloig, Y., Eds.; Wiley: Chichester, U.K., 1998; Vol. 2, Part 2, Chapter 23, p 1339. (e) Bassindale, A. R.; Taylor, P. G.; Glynn, S. J.; Taylor, P. G. In *The Chemistry of Organic Silicon Compounds*; Rappoport, Z., Apeloig, Y., Eds.; Wiley: Chichester, U.K., 1998; Vol. 2, Part 2, Chapter 9, p 495. (f) Takeuchi, Y.; Takayama, T. In *The Chemistry of Organic Silicon Compounds*; Rappoport, Z., Apeloig, Y., Eds.; Wiley: Chichester, U.K., 1998; Vol. 2, Part 2, Chapter 6, p 267. (g) Hermanns, J.; Schmidt, B. *J. Chem. Soc., Perkin Trans. 1* **1999**, 81. (h) Maggiora, N.; Tyrra, W.; Naumann, D.; Kirij, N. V.; Yagupolski, Y. L. *Angew. Chem.* **1999**, *111*, 2392; *Angew. Chem., Int. Ed.* **1999**, *38*, 2252.

(35) (a) de Keijzer, A. H. J. F.; de Kanter, F. J. J.; Schakel, M.; Schmitz, R. F.; Klumpp, G. W. *Angew. Chem.* **1996**, *108*, 1183; *Angew. Chem., Int. Ed. Engl.* **1996**, *35*, 1127. (b) de Keijzer, A. H. J. F.; de Kanter, F. J. J.; Schakel, M.; Osinga, V. P.; Klumpp, G. W. *J. Organomet. Chem.* **1997**, *548*, 29. (c) Rot, N.; Nijbacker, T.; Kroon, R.; de Kanter, F. J. J.; Bickelhaupt, F.; Lutz, M.; Spek, A. L. *Organometallics* **2000**, *19*, 1319.

(36) (a) Hajdasz, D. J.; Squires, R. R. *J. Am. Chem. Soc.* **1986**, *108*, 3139. (b) Hajdasz, D. J.; Ho, Y.; Squires, R. R. *J. Am. Chem. Soc.* **1994**, *116*, 10751. (c) Hong, J.-H.; Boudjouk, P. *Organometallics* **1995**, *14*, 574.

(37) (a) Boche, G.; Schneider, D. R. Wintermayr, H. *J. Am. Chem. Soc.* **1980**, *102*, 5697. (b) Boche, G.; Walborsky, H. M. In *The Chemistry of the Cyclopropyl Group*; Rappoport, Z., Ed.; Wiley: Chichester, U.K., 1987; pp 701–808.

(38) Garst, J. F.; Boone, J. R.; Webb, L.; Lawrence, K. E.; Baxter, J. T.; Ungváry, F. *Inorg. Chim. Acta* **1999**, *296*, 52.



Scheme 13

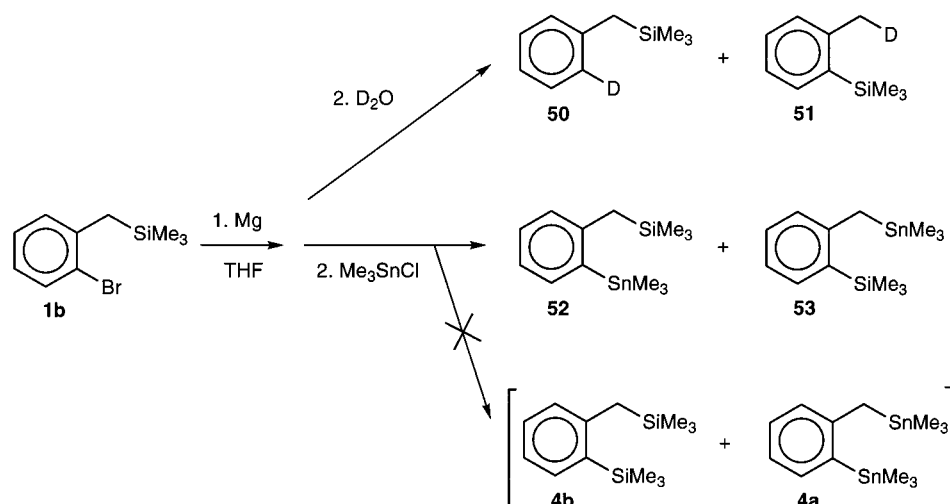

Scheme 14

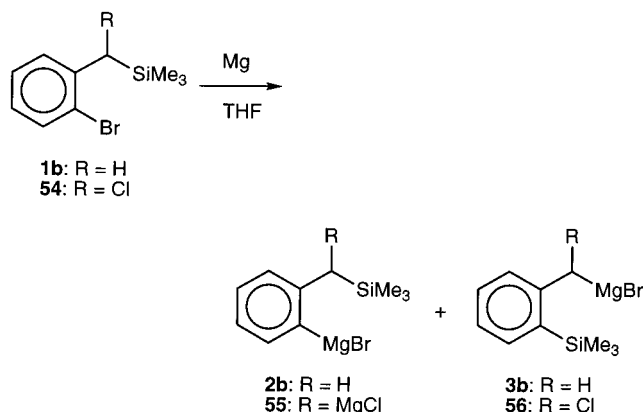

Scheme 15

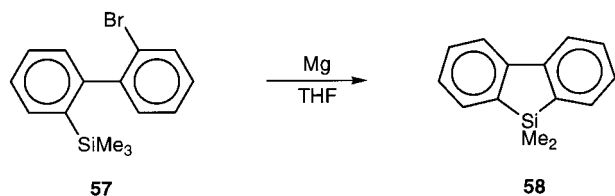

anism proposed includes prior reduction of an aryl group R to the radical anion  $R^{\cdot-}$  followed by a second single-electron transfer to the  $\sigma^*$  orbital of the R–X bond (step 1 of Scheme 1). We consider this course of events highly unlikely because of electrostatic repulsion in  $^{\cdot-}R-X^{\cdot-}$ . This applies even more in the present cases, where both electron transfers would have to take place to two organic entities which are directly connected, namely the aryl group and the halogen attached to it. Moreover, the usual radical intermediate  $R^{\cdot}$  has recently been shown to be a more likely alternative than the dianion in the related reaction of 2-(4-phenyl-3-butenyl)phenyl halides with magnesium.<sup>17f</sup>

Occasionally, organomagnesium clusters such as  $RMg_n$ <sup>17b-d</sup> and  $RMg_nX$ <sup>39</sup> have been suggested as intermediates in the reaction between halides and magnesium, in particular  $RMg_4X$ .<sup>39b</sup> Recently, it has been considered<sup>40</sup> that, instead of the carbanion  $R^{\cdot-}$ ,  $RMg_nX$  might be responsible for the group 14 migrations described above. However, such clusters have been

encountered under conditions which strongly deviate from the usual Grignard reactions, namely in metal vapor cryosynthesis, and without the presence of polar solvents such as ethers.<sup>39</sup> Furthermore, we feel that it would be difficult to argue that in such clusters the carbanionoid R group should exhibit a more pronounced carbanionic character than that of ordinary Grignard reagents  $RMgX$ , let alone that it would exceed the carbanionic reactivity of organolithium compounds.

The final candidate as an alternative to the carbanion  $R^{\cdot-}$  is the radical  $R^{\cdot}$ , especially as radicals have been unambiguously identified as intermediates in this reaction. While the unusual group 14 rearrangements described above appear to fit much better into a carbanion mechanism, it was clearly desirable to prove by direct experimental evidence that authentic  $R^{\cdot}$  formed by an alternative and unequivocal route does not give rise to the rearranged products obtained in the reaction of R–X with magnesium.

For that purpose, we had initially tried to create the aryl radical **59** (Scheme 17) from **1a** by photolysis of its aryl–bromine bond. However, due to the partial cleavage of the benzylic carbon–tin bond, the results were not unambiguous.<sup>21</sup> Similarly, experiments wherein phenyl radicals (generated by reduction of bromobenzene and the “complex reducing agent”  $NaH/Ni(OAc)_2/tert$ -amyl alcohol, by reduction of phenylmercury bromide with sodium borohydride, or by photochemical decomposition of dibenzoyl peroxide) were unsuccessful or gave unidentified products.<sup>23</sup>

We next considered samarium(II) iodide ( $SmI_2$ ) as an attractive reagent to react with **1a** under formation of **59** without affecting the benzylic carbon–tin bond, because  $SmI_2$  is a unique single-electron reducing agent for a number of functional groups in organic synthesis. Various mechanisms have been suggested for the reaction of organic halides with  $SmI_2$  (Scheme 16).<sup>41</sup> Outer- or inner-sphere electron transfer between  $Sm(II)$  and the organic halide R–X will lead to the radical  $R^{\cdot}$  through loss of the halide ion. When R is a primary or

(39) (a) Smirnov, V. V.; Tjurina, L. A.; Beletskaya, I. P. In *Grignard Reagents, New Developments*; Richey, H. G., Ed.; Wiley: Chichester, U.K., 2000; Chapter 12, pp 395–410. (b) Tjurina, L. A.; Smirnov, V. V.; Barkovskii, G. B.; Nikolaev, E. N.; Esipov, S. E.; Beletskaya, I. P. *Organometallics* **2001**, *20*, 2449.

(40) See ref 4, p. 238.

## Scheme 16

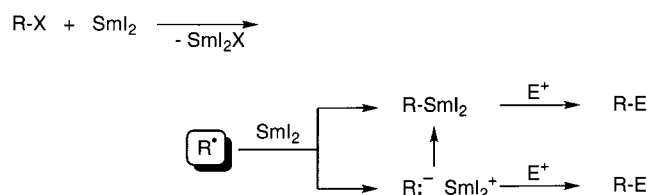

a secondary alkyl group, subsequent reaction with a second molecule of  $\text{SmI}_2$  will afford an organosamarium reagent which reacts with electrophilic species such as carbonyl compounds in the same way as Grignard reagents.

The addition of HMPA enhances the reduction of organic halides by the  $\text{SmI}_2$ -THF system. The reduction of aryl halides by a  $\text{SmI}_2$ -THF-HMPA solution rapidly produces aryl radicals, but in comparison with the outcome of the reactions of alkyl halides, further reduction to the corresponding aryl anion as the result of a two-electron reduction is less pronounced. Since 1 equiv of HMPA does not suffice to enhance reactivity, HMPA is generally used as a cosolvent (5–10%). HMPA complexes to  $\text{Sm(II)}$ , displacing THF from the  $\text{Sm(II)}$  coordination sphere; in this fashion, it effectively shields the reacting organic halide from hydrogen atom donors, thus enhancing the lifetime of the radical.<sup>41b</sup>

When **1a** was stirred in a solution of  $\text{SmI}_2$  in THF for several days, no reaction was observed; after hydrolysis and workup, **1a** was recovered quantitatively. However, when **1a** was added to a solution of  $\text{SmI}_2$  containing 10% HMPA as cosolvent, the reaction could be monitored visually, as the solution color turned from the typical purple to brown. Analysis of the reaction mixture by GCMS revealed only the presence of benzyltrimethylstannane (**14**); 1-methyl-2-(trimethylstannyl)benzene (**60**) was not detected (Scheme 17).

When the same reaction was performed on a larger scale in order to facilitate separation and characterization of the reaction products, the formation of 10% **60** was observed. The formation of **60** may be explained by further reduction of **59** to **9a**, which, as in the case of the Grignard formation reaction of **1a**, is responsible for the observed tin migrations. This further reduction might be induced by  $\text{SmI}_2$ , which was available in excess,<sup>41b,c</sup> but more likely it is the result of reduction by samarium metal which is present in the  $\text{SmI}_2$  solution to stabilize the  $\text{SmI}_2$  and to make it more reactive;<sup>41i</sup> in our experience, different batches of  $\text{SmI}_2$  showed different rates of reduction, probably due to

different amounts of free samarium metal present in solution. To ensure that it was the samarium Grignard reaction via the carbanion which was responsible for the observed tin migration, the reaction was repeated in the presence of *t*-BuOD or  $\text{CH}_3\text{OD}$ . Though in this case conversion of **1a** was not quantitative, it provided convincing evidence for the origin of the rearrangement product **60**. According to GCMS, **60** showed deuterium incorporation (*t*-BuOD: 78%;  $\text{CH}_3\text{OD}$ : 73%), indicating that **60** resulted from deuteration of a carbanionic intermediate. Since **14** did not incorporate any deuterium, it must originate from a radical species: i.e., **59**. Thus, finally proof was obtained that the observed rearrangements are due to carbanionic intermediates and that these carbanions are actual intermediates in the formation of the Grignard reagent.

Reaction of **1a** with  $\text{SmI}_2$  in the presence of  $\text{CD}_3\text{OH}$  confirmed that the non-rearranged **14** resulted from a radical precursor. This assumption is made on the basis that **14** was found to be 56% deuterated, presumably at the aryl ortho position. The relatively low degree of deuteration can be ascribed to the fact that the excess of THF competes with the  $\text{CD}_3\text{OH}$  as a hydrogen donor.

A control experiment showed that **14** did not react with a solution of  $\text{SmI}_2$  in a mixture of THF and HMPA. However, adding bromobenzene to a mixture of **14** and  $\text{SmI}_2$  in THF-HMPA did result in a reaction. Analysis of the mixture by  $^1\text{H}$  NMR spectroscopy and GCMS revealed, besides the presence of **14** (78%), also that of **16** (22%; cf. Scheme 4). In this case, too, the relatively high yield of **16** is explained by intermediate formation of carbanion **9a** due to a larger excess of Sm (see Experimental Section), leading to overreduction of the phenyl radical to the phenyl anion. Formation of toluene was also observed, but because of its high volatility and low yield (22% according to stoichiometry of the proposed reaction mechanism), a quantitative estimate was not feasible.

## Conclusion

The intermediate formation of reactive carbanions in the formation of the Grignard reagent appears to be well supported by the occurrence of inter- and/or intramolecular migrations of organotin and organosilicon groups. Organolithium compounds with their highly ionic metal-carbon bonds exhibit striking parallels in their reaction behavior, whereas radicals generated independently showed a different behavior. The high percentage of rearrangement reactions is an indication that these anionic species are not located on a minor pathway; at least in the cases studied here, they make a major contribution to the overall reaction, especially when they are stabilized as stannate complexes. The combination of high reactivity and selectivity of the carbanion might be explained by coordination to the (positively charged) magnesium surface, as recently proposed for the ortho metalation of anisole by sodium.<sup>42</sup> Thus, a high steady-state concentration of carbanions can be achieved, resulting in an enhanced possibility to react with neutral starting molecules.

(41) (a) Girard, P.; Namy, J. L.; Kagan, H. B. *J. Am. Chem. Soc.* **1980**, *102*, 2693. (b) Molander, G. A.; McKie, J. A. *J. Org. Chem.* **1992**, *57*, 3132. (c) Curran, D. P.; Fevig, T. L.; Jasperse, C. P.; Totleben, M. J. *Synlett* **1992**, 943. (d) Curran, D. P.; Totleben, M. J. *J. Am. Chem. Soc.* **1992**, *114*, 6050. (e) Molander, G. A.; Harris, C. R. *Chem. Rev.* **1996**, *96*, 307. (f) Cappella, L.; Montevicchi, P. C.; Navacchia, M. L. *J. Org. Chem.* **1995**, *60*, 7424. (g) Inanaga, J.; Ishikawa, M.; Yamaguchi, M. *Chem. Lett.* **1987**, 1485. (h) Inanaga, J.; Ujikawa, O.; Yamaguchi, M. *Tetrahedron Lett.* **1991**, *32*, 1737. (i) Ogawa, A.; Nanke, T.; Takami, N.; Sumino, Y.; Ryu, I.; Sonoda, N. *Chem. Lett.* **1994**, 379. (j) Evans, W. J.; Gummshheimer, T. S.; Ziller, J. W. *J. Am. Chem. Soc.* **1995**, *117*, 8999. (k) Hou, Z.; Wakatsuki, Y. *J. Chem. Soc., Chem. Commun.* **1994**, 1205. (l) Shabangi, M.; Flowers, R. A., II. *Tetrahedron Lett.* **1997**, *38*, 1137. (m) Evans, W. J.; Allen, N. T. *J. Am. Chem. Soc.* **2000**, *122*, 2118. (n) Enemærke, R. J.; Hertz, T.; Skrydstrup, T.; Daasbjerg, K. *Chem. Eur. J.* **2000**, *6*, 3747. (o) Miquel, N.; Doisneau, G.; Beau, J.-M. *Angew. Chem.* **2000**, *112*, 4277; *Angew. Chem., Int. Ed.* **2000**, *39*, 4111. (p) Miller, R. S.; Sealy, J. M.; Shabangi, M.; Kuhlman, M. L.; Fuchs, J. R.; Flowers, R. A., II. *J. Am. Chem. Soc.* **2000**, *122*, 7718.

(42) Gissot, A.; Becht, J.-M.; Desmurs, J. R.; Pèvere, V.; Wagner, A.; Mioskowski, C. *Angew. Chem., Int. Ed.* **2002**, *41*, 340.

Scheme 17

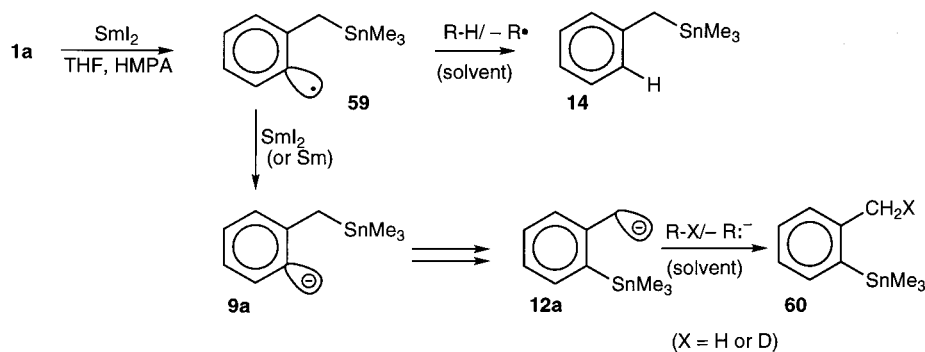

### Experimental Section

**General Procedures and Materials.** Manipulations involving the reactions with magnesium were, unless stated otherwise, conducted in fully sealed glassware using standard high-vacuum techniques.<sup>43,44</sup> The magnesium used was doubly sublimed. Amounts of "total base" and  $Mg^{2+}$  in organomagnesium samples were determined, after hydrolysis of a sample, by titration with HCl and EDTA, respectively.<sup>43,44</sup> Solvents were distilled from  $LiAlH_4$  after predrying on KOH or in sealed glassware, distilled from sodium-potassium alloy. The starting materials 1-bromo-2-(bromomethyl)benzene (Aldrich), bromobenzene (Merck), 1,2-dibromobenzene (Aldrich), 2-bromo-4-methylaniline (Aldrich), 1,2-dibromoethane (Merck),  $MeMgBr$  (Aldrich),  $SmI_2$  (Aldrich), Sm (40 mesh, Aldrich),  $CH_2I_2$  (Janssen), HMPA (Aldrich), and Florisil (Janssen) were commercially available. GLC and quantitative NMR analyses were performed using hexamethylbenzene as internal standard. NMR spectra were recorded on a Bruker AC 200 spectrometer ( $^1H$  NMR, 200.1 MHz;  $^{13}C$  NMR, 50.32 MHz), on a Bruker WM 250 spectrometer ( $^1H$  NMR, 250 MHz;  $^{13}C$  NMR, 63 MHz) or on a Bruker MSL 400 spectrometer ( $^1H$  NMR, 400.1 MHz;  $^{13}C$  NMR, 100.6 MHz;  $^{119}Sn$  NMR, 149.2 MHz). GCMS analyses were performed on a HP 5890 GC/5970 MS combination, operating at 70 eV and equipped with a Chrompack CpSil 5CB 50 m/0.20 mm<sup>2</sup> column. The ions containing Si, Ge, or Sn showed the expected isotope patterns, but only the  $m/z$  values containing the most abundant isotope(s) ( $^{28}Si$ ,  $^{74}Ge$ , and  $^{120}Sn$ ) are listed. HRMS measurements were performed on a Finnigan MAT 90 spectrometer (direct inlet). Elemental analyses were carried out by Mikroanalytisches Labor Pascher, Remagen, Germany.

**1-Bromo-2-((trimethylstannyl)methyl)benzene (1a).**<sup>45</sup> A solution of 25.00 g (100 mmol) of 1-bromo-2-(bromomethyl)benzene in 50 mL of diethyl ether was added dropwise under nitrogen to 2.55 g (105 mmol) of doubly sublimed magnesium covered with 150 mL of diethyl ether in 5 h at room temperature. After the addition was completed, stirring was continued for 1 h. The yellow solution was carefully siphoned from the residual magnesium into another reaction flask; then it was cooled to 0 °C followed by the addition of a solution of 19.93 g (100 mmol) of  $Me_3SnCl$  in 100 mL of pentane. Immediately a white precipitate formed. After the addition was completed, the mixture was stirred for 1 h, after which 20 mL of saturated  $NH_4Cl$  was added. The organic fraction was separated and the aqueous fraction extracted with diethyl ether. The extracts were combined, washed (water), dried ( $MgSO_4$ ), filtered, and evaporated to dryness. The residual oil was purified by fractional distillation. The product was collected at 103 °C at 3 mbar to give 20.70 g (62.0 mmol, 62% yield) of a colorless oil.

(43) Vreugdenhil, A. D.; Blomberg, C. *Recl. Trav. Chim. Pays-Bas* **1963**, *82*, 453.

(44) Vreugdenhil, A. D.; Blomberg, C. *Recl. Trav. Chim. Pays-Bas* **1963**, *82*, 461.

(45) Alexander, R.; Attar-Bashi, M. T.; Eaborn, C.; Walton, D. R. M. *Tetrahedron* **1974**, *30*, 899.

**1a:**  $^1H$  NMR ( $CDCl_3$ , 200.1 MHz, reference  $CHCl_3$  7.27 ppm)  $\delta$  0.10 (s,  $^2J(Sn-H) = 53.9, 51.5$  Hz, 9H,  $SnCH_3$ ), 2.49 (s,  $^2J(Sn-H) = 63.0$  Hz, 2H,  $CH_2$ ), 6.87 (ddd,  $^3J = 8.0, 7.1$  Hz,  $^4J = 2.0$  Hz, 1H, aryl H), 7.08 (dd,  $^3J = 7.6$  Hz,  $^4J = 2.0$  Hz, 1H, aryl H), 7.14 (ddd,  $^3J = 7.6, 7.1$  Hz,  $^4J = 1.3$  Hz, 1H, aryl H), 7.47 (dd,  $^3J = 8.0$  Hz,  $^4J = 1.3$  Hz, 1H, aryl H);  $^{13}C$  NMR ( $CDCl_3$ , 50.32 MHz, reference  $CDCl_3$  77.00 ppm)  $\delta$  -8.9 (q,  $^1J = 129$  Hz,  $^1J(Sn-C) = 332, 317$  Hz,  $SnCH_3$ ), 22.3 (t,  $^1J = 132$  Hz,  $^1J(Sn-C) = 276, 264$  Hz,  $CH_2$ ), 122.6 (bs,  $^3J(Sn-C) = 26$  Hz, C1), 124.6 (dd,  $^1J = 164$  Hz,  $^3J = 8$  Hz,  $^5J(Sn-C) = 15$  Hz, 1C, C5), 127.2 (dd,  $^1J = 161$  Hz,  $^3J = 8$  Hz,  $^4J(Sn-C) = 13$  Hz, 1C, C4), 128.2 (ddd,  $^1J = 159$  Hz,  $^3J = 6$  Hz,  $^3J(Sn-C) = 21$  Hz, 1C, C3), 132.4 (dd,  $^1J = 164$  Hz,  $^3J = 7$  Hz,  $^4J(Sn-C) = 13$  Hz, 1C, C6), 143.4 (bs,  $^2J(Sn-C) = 40$  Hz, 1C, C2);  $^{119}Sn$  NMR ( $CHCl_3$ , 149.21 MHz, reference  $Me_4Sn$  0.000 ppm)  $\delta$  8.621; GCMS  $m/z$  (relative intensity) 334 ( $M^+$ ,  $C_{10}H_{15}^{79}Br^{120}Sn$ , 3), 319 (82), 289 (6), 229 (13), 199 (34), 169 (20), 165 (100), 150 (13), 135 (41), 120 (17), 105 (26), 90 (39), 89 (50); HRMS calcd for  $C_{10}H_{15}^{79}Br^{118}Sn$  333.9378, obsd 333.9398  $\pm$  0.0006. Anal. Calcd for  $C_{10}H_{15}BrSn$ : C, 35.98; H, 4.53; Br, 23.94. Found: C, 36.02; H, 4.55; Br, 23.8.

**Reaction of 1a with Magnesium in Diethyl Ether.** A mixture of 3.0 g (9.0 mmol) of **1a**, 0.243 g (10.0 mmol) of triply sublimed magnesium, and 150 mL of diethyl ether was stirred for 72 h at room temperature. A sample was hydrolyzed and analyzed by titration, which revealed that no reaction had occurred. The reaction vessel was opened and the mixture worked up, after which **1a** was recovered quantitatively.

**Reaction of 1a with Magnesium in THF.** A mixture of 3.0 g (9.0 mmol) of **1a**, 0.36 g (15.0 mmol) of triply sublimed magnesium, and 180 mL of THF was stirred for 22 h at room temperature. During stirring, the mixture turned yellow within a few minutes and a white precipitate slowly formed. A sample was hydrolyzed and analyzed by titration, which revealed the formation of 8.6 mmol of base and 8.8 mmol of  $Mg^{2+}$ . At the same time, a sample was deuterated ( $D_2O$ ) and worked up by addition of diethyl ether, separation of the organic and aqueous fractions, and drying of the organic fraction ( $MgSO_4$ ); it was analyzed by GCMS (relative yields).

1-Deuterio-2-(deuteriomethyl)benzene, 24% yield: GCMS  $m/z$  (relative intensity) 95 (6), 94 ( $M^+$ ,  $C_7H_6D_2$ , 82), 93 (100), 92 (25), 91 (3), 90 (3).

1-(Deuteriomethyl)-2-(trimethylstannyl)benzene ([D]**60**), 26% yield:  $^1H$  NMR ( $CDCl_3$ , 250 MHz, reference  $CHCl_3$  7.27 ppm)  $\delta$  0.36 (s,  $^2J(Sn-H) = 54, 52$  Hz, 9H,  $SnCH_3$ ), 2.43 (t,  $^2J(D-H) = 2$  Hz, 2H,  $CH_2$ ), 7.04–7.33 (m, 3H, aryl H); GCMS  $m/z$  (relative intensity) 242 ( $[M - CH_3]^+$ , 100), 212 (36), 135 (18), 92 (30).

2-Deuterio-1-((trimethylstannyl)methyl)benzene ([2-D]**14**), 18% yield: GCMS  $m/z$  (relative intensity) 257 ( $M^+$ , 8), 242 (8), 212 (5), 165 (100), 135 (27), 120 (16), 92 (78).

1-(Trimethylstannyl)-2-(trimethylstannyl)methyl)benzene (**4a**),<sup>24a</sup> 32% yield.

These analyses (titration and deuteriolysis) were repeated after 34, 108, and 300 h, but all values remained constant. According to the mass spectra, the deuterated compounds

contained more than 97% deuterium. After 300 h, a sample was taken from the mixture in order to identify the white precipitate. For that purpose, the precipitate was separated from the yellow solution by decantation and treated with an excess of  $\text{Me}_3\text{SnCl}$  in THF. After workup, GLC analysis of the organic fraction revealed that **4a** had been formed in 95% yield with respect to **5**.

In an independent experiment, 150 mL of a similar mixture was derivatized with 8.0 mmol of  $\text{Me}_3\text{GeCl}$  (1.2 g) and stirred for 1 h at room temperature; upon addition of  $\text{Me}_3\text{GeCl}$ , the mixture turned clear and colorless within seconds. The reaction vessel was opened, followed by the addition of diethyl ether and saturated  $\text{NH}_4\text{Cl}$ . The organic fraction was separated and the aqueous fraction extracted with diethyl ether. The organic fractions were combined, dried ( $\text{MgSO}_4$ ), filtered, and evaporated to dryness, yielding 3.4 g of a colorless liquid. The product distribution and yields were determined by quantitative  $^1\text{H}$  NMR analysis (pulse delay 15 s). The compounds were isolated by preparative GLC; however, **6a** and **7a** could not be separated from each other.

**4a**, 28% yield.

1-(Trimethylgermyl)-2-((trimethylstannyl)methyl)benzene (**6a**),<sup>21</sup> 15% yield.

1-(Trimethylgermyl)methyl)-2-(trimethylstannyl)benzene (**7a**),<sup>21</sup> 29% yield.

1-(Trimethylgermyl)-2-((trimethylgermyl)methyl)benzene (**8**),<sup>24a</sup> 28% yield.

**1-(Trimethylgermyl)-2-((trimethylstannyl)methyl)benzene (6a)**.<sup>46</sup> A solution of 3.0 mmol of *tert*-butyllithium in 2 mL of pentane was cooled to  $-80^\circ\text{C}$ , and 10 mL of diethyl ether was added. This solution was stirred for 15 min, and then 0.5 mmol of **1a** (167 mg) was added. The mixture became immediately yellow and was stirred for 1.5 h at  $-80^\circ\text{C}$ . Addition of 3.0 mmol of  $\text{Me}_3\text{GeCl}$  (462 mg) gave an almost colorless solution and a white precipitate. The mixture was warmed to room temperature, followed by the addition of saturated  $\text{NH}_4\text{Cl}$  and workup. Yield: 89%.

**Solvent Dependence of the Product Mixture Obtained from 1a with Magnesium.** A mixture of 3.16 g (9.47 mmol) of **1a**, 0.262 g (10.8 mmol) of triply sublimed magnesium, and 180 mL of THF was stirred for 1 day at room temperature. From the mixture, two 10 mL samples were taken and evaporated to dryness. To each residue anisole or benzene was added, and both mixtures were subsequently stirred for 1 week. Both mixtures were divided into two 5 mL samples. For each solvent, one sample was quenched with  $\text{Me}_3\text{GeCl}$ , stirred for 1 day, and, after standard workup, analyzed by  $^1\text{H}$  NMR spectroscopy, GLC, and GCMS. Product distributions were as follows: for benzene, 18.3% **6a**, 24.8% **7a**, 28.6% **4a**, and 28.3% **8**; for anisole, 19.1% **6a**, 24.4% **7a**, 28.1% **4a**, and 28.4% **8**. The remaining two samples were evaporated to dryness, 10 mL of THF was added, and the mixture was stirred for 1 week and then quenched with  $\text{Me}_3\text{GeCl}$ . Analysis of the product distribution revealed no significant differences from those previously determined.

**Reaction of 1a with Magnesium at 60 °C.** A mixture of 0.194 g (0.582 mmol) of **1a**, 0.0320 g (1.32 mmol) of triply sublimed magnesium, and 10 mL of THF was stirred at  $60^\circ\text{C}$ . After 24 h, the mixture was quenched with  $\text{Me}_3\text{GeCl}$ . After workup, the product distribution and yields were determined by  $^1\text{H}$  NMR spectroscopy, GLC, and GCMS analysis. Yields: 34% **4a**, 28% **6a**, 4% **7a** and 34% **8**.

**Reaction of Bromobenzene with Magnesium in the Presence of Benzyltrimethylstannane (14).** A mixture of 0.86 g (5.7 mmol) of bromobenzene, 1.46 g (5.7 mmol) of **14**, 0.14 g (5.7 mmol) of triply sublimed magnesium, and 150 mL of THF was stirred for 26 h at room temperature. A sample of

the colorless mixture was hydrolyzed and analyzed by titration, which revealed the formation of 5.6 mmol of base and 5.6 mmol of  $\text{Mg}^{2+}$ . A 130 mL amount of the mixture was quenched with 4.9 mmol of  $\text{Me}_3\text{GeCl}$  (0.88 g); after workup, 2.3 g of a colorless liquid was isolated. The product distribution and the yields were determined by quantitative  $^1\text{H}$  NMR analysis. The compounds were separated by preparative GLC: Benzyltrimethylstannane (**14**) was obtained in 84% yield.

Trimethylphenylgermane (**15**), colorless liquid, 84% yield:  $^1\text{H}$  NMR ( $\text{CDCl}_3$ , 250 MHz, reference  $\text{CHCl}_3$  7.27 ppm)  $\delta$  0.28 (s, 9H,  $\text{GeCH}_3$ ), 7.27–7.58 (m, 5H, aryl H); GCMS *m/z* (relative intensity) 196 ( $\text{M}^+$ ,  $\text{C}_8\text{H}_{14}^{74}\text{Ge}$ , 4), 181 (100), 151 (20), 91 (12), 89 (13).

Trimethylphenylstannane (**16**), colorless liquid, 14% yield:  $^1\text{H}$  NMR ( $\text{CDCl}_3$ , 250 MHz, reference  $\text{CHCl}_3$  7.27 ppm)  $\delta$  0.27 (s,  $^2J(\text{Sn}-\text{H}) = 56$ , 54 Hz, 9H,  $\text{SnCH}_3$ ), 7.27–7.58 (m, 5H, aryl H). GCMS *m/z* (relative intensity) 242 ( $\text{M}^+$ ,  $\text{C}_9\text{H}_{14}^{120}\text{Sn}$ , 1), 227 (100), 197 (34), 135 (14), 120 (18).

Benzyltrimethylgermane (**17**), colorless liquid, 14% yield:  $^1\text{H}$  NMR ( $\text{CDCl}_3$ , 250 MHz, reference  $\text{CHCl}_3$  7.27 ppm)  $\delta$  0.11 (s, 9H,  $\text{GeCH}_3$ ), 2.21 (s, 2H,  $\text{CH}_2$ ), 6.91–7.35 (m, 5H, aryl H); GCMS *m/z* (relative intensity) 210 ( $\text{M}^+$ ,  $\text{C}_9\text{H}_{14}^{74}\text{Ge}$ , 12), 195 (12), 119 (100), 91 (51), 89 (38).

**1-Bromo-2-(trimethylstannyl)benzene (18).** A mixture of 8.33 g (35.0 mmol) of 1,2-dibromobenzene, 6.63 g (35.0 mmol) of 1,2-dibromoethane, and 35 mL of diethyl ether was added dropwise to 1.68 g (70.0 mmol) of sublimed magnesium covered with 5 mL of diethyl ether in 2 h at  $0^\circ\text{C}$ . The mixture turned orange immediately, and slowly a white precipitate formed. After the addition was completed, the stirring was continued for another 1.5 h at  $0^\circ\text{C}$ ; then a solution of 7.19 g (35.0 mmol) of  $\text{Me}_3\text{SnCl}$  in 50 mL of diethyl ether was added over 1 h. Stirring was continued for 20 h at room temperature. After workup, 10.3 g of a brown viscous oil was isolated. High-vacuum distillation ( $49^\circ\text{C}$  at 0.08 mbar) afforded 3.13 g (9.8 mmol, 38% yield) of a colorless oil of **18**.

**18:**  $^1\text{H}$  NMR ( $\text{CDCl}_3$ , 250 MHz, reference  $\text{CHCl}_3$  7.27 ppm)  $\delta$  0.38 (s,  $^2J(\text{Sn}-\text{H}) = 56$ , 54 Hz, 9H,  $\text{SnCH}_3$ ), 7.18 (m, 3H, aryl H), 7.60 (m, 1H, aryl H);  $^{13}\text{C}$  NMR ( $\text{CDCl}_3$ , 63 MHz, reference  $\text{CDCl}_3$  77.00 ppm)  $\delta$  -7.9 (q,  $^1J = 129$  Hz,  $^1J(\text{Sn}-\text{C}) = 364$  Hz,  $\text{SnCH}_3$ ), 126.5 (dd,  $^1J = 161$  Hz,  $^3J = 7$  Hz, C4), 130.4 (dd,  $^1J = 161$  Hz,  $^3J = 8$  Hz, C5), 131.8 (dd,  $^1J = 161$  Hz,  $^3J = 25$  Hz,  $^3J = 8$  Hz, C6), 133.3 (bs, C1), 137.5 (dd,  $^1J = 161$  Hz,  $^3J = 8$  Hz,  $^2J(\text{Sn}-\text{C}) = 32$  Hz, C3), 146.4 (bs, C2); GCMS *m/z* (relative intensity) 305 ( $[\text{M} - \text{CH}_3]^+$ , 100), 290 (8), 275 (7), 229 (13), 199 (40), 135 (10), 120 (9), 91 (71). Anal. Calcd for  $\text{C}_9\text{H}_{13}\text{BrSn}$ : C, 33.80; H, 4.10. Found: C, 34.07; H, 4.12.

**Reaction of 18 with Magnesium.** A mixture of 0.500 g (1.56 mmol) of **18** and 0.587 g (3.12 mmol) of 1,2-dibromoethane was added to 0.112 g (4.69 mmol) of triply sublimed magnesium covered with 10 mL of THF, and the mixture was stirred for 1.5 h at room temperature. A sample was hydrolyzed and analyzed by GLC, which revealed that **18** was completely consumed. The mixture was quenched with 0.241 g (1.56 mmol) of  $\text{Me}_3\text{GeCl}$  and worked up as usual, yielding 0.430 g of a colorless liquid. The product distribution and yields were determined by quantitative  $^1\text{H}$  NMR analysis. The products were separated by preparative GLC.

1-(Trimethylgermyl)-2-(trimethylstannyl)benzene (**19**), colorless liquid, 77% yield:  $^1\text{H}$  NMR ( $\text{CDCl}_3$ , 250 MHz, reference  $\text{CHCl}_3$  7.27 ppm)  $\delta$  0.32 (s,  $^2J(\text{Sn}-\text{H}) = 55$ , 53 Hz,  $\text{SnCH}_3$ ), 0.38 (s, 9H,  $\text{GeCH}_3$ ), 7.41 (m, 4H, aryl H)  $^{13}\text{C}$  NMR ( $\text{CDCl}_3$ , 63 MHz, reference  $\text{CDCl}_3$  77.00 ppm)  $\delta$  -6.3 (q,  $^1J = 128$  Hz,  $\text{SnCH}_3$ ), 0.4 (q,  $^1J = 126$  Hz,  $\text{GeMe}_3$ ), 127.7 (dd,  $^1J = 160$  Hz,  $^3J = 7$  Hz,  $^3J(\text{Sn}-\text{C}) = 47$  Hz, C4,5), 134.3 (d,  $^1J = 164$  Hz,  $^2J(\text{Sn}-\text{C}) = 58$  Hz, C3), 137.1 (d,  $^1J = 161$  Hz,  $^3J(\text{Sn}-\text{C}) = 43$  Hz, C6), 148.4 (bs, C2), 151.0 (bs, C2); GCMS *m/z* (relative intensity) 354 (68), 343 (100), 327 (13), 311 (6), 297 (3), 281 (17), 227 (16), 165 (53), 119 (53), 91 (33). Anal. Calcd for  $\text{C}_{12}\text{H}_{22}\text{GeSn}$ : C, 40.31; H, 6.20. Found: C, 40.39; H, 5.99.

(46) de Boer, H. J. R.; Akkerman, O. S.; Bickelhaupt, F. *Organometallics* **1990**, *9*, 2898.

1,2-Bis(trimethylstannyl)benzene (**20**), colorless liquid, 7% yield:<sup>47</sup> <sup>1</sup>H NMR (CDCl<sub>3</sub>, 250 MHz, reference CHCl<sub>3</sub> 7.27 ppm)  $\delta$  0.34 (s, <sup>2</sup>*J*(Sn–H) = 53, 51 Hz, 18H, SnCH<sub>3</sub>), 7.05–7.75 (m, 4H, aryl H); GCMS *m/z* (relative intensity) 391 (65), 389 (100), 375 (2), 359 (6), 329 (6), 314 (6), 241 (34), 226 (3), 211 (21), 197 (5), 165 (41), 135 (24), 120 (9), 91 (22).

1,2-Bis(trimethylgermyl)benzene (**21**), 7% yield: <sup>1</sup>H NMR (CDCl<sub>3</sub>, 250 MHz, reference CHCl<sub>3</sub> 7.27 ppm)  $\delta$  0.39 (s, 18H, GeMe<sub>3</sub>), 7.40–7.43 (m, 4H, aryl H); GCMS *m/z* (relative intensity) 299 (70), 297 (100), 283 (2), 180 (45), 150 (15), 119 (51), 89 (33).

**2-Bromo-1-iodo-4-methylbenzene (24)**. A solution of 4.55 g (65.9 mmol) of NaNO<sub>2</sub> in 40 mL of water was added dropwise to an ice-cooled solution of 10.67 g (57.4 mmol) of 2-bromo-4-methylaniline in 40 mL of concentrated hydrochloric acid while maintaining the temperature below 5 °C. After addition, stirring was continued for 15 min and then a solution of 33.2 g (200 mmol) of KI in 100 mL of water was added over 15 min. After it was stirred overnight at room temperature, the black suspension was extracted with diethyl ether. The combined organic fractions were washed with 10% NaOH (four times with 25 mL portions), water, and saturated Na<sub>2</sub>S<sub>2</sub>O<sub>3</sub> (three times with 30 mL portions), dried (MgSO<sub>4</sub>), filtered, and evaporated to dryness. The residual oil was purified by fractional distillation in the dark. The product was collected at 91 °C at 4 mbar to give 8.89 g (29.8 mmol, 52% yield) of a colorless oil.

**24**: <sup>1</sup>H NMR (CDCl<sub>3</sub>, 200.1 MHz, reference CHCl<sub>3</sub> 7.27 ppm)  $\delta$  2.29 (s, 3H, CH<sub>3</sub>), 6.82 (ddd, <sup>3</sup>*J* = 8.1 Hz, <sup>4</sup>*J* = 2.0 Hz, *J* = 0.6 Hz, 1H, ArH(5)), 7.47 (dd, <sup>4</sup>*J* = 1.0 Hz, <sup>5</sup>*J* = 1.0 Hz, 1H, ArH(3)), 7.62 (d, <sup>3</sup>*J* = 8.1 Hz, 1H, ArH(6)); <sup>13</sup>C NMR (CDCl<sub>3</sub>, 50.32 MHz, reference CDCl<sub>3</sub> 77.00 ppm)  $\delta$  20.67 (qt, <sup>1</sup>*J* = 127.3 Hz, <sup>3</sup>*J* = 4.4 Hz, CH<sub>3</sub>), 96.82 (tq, <sup>3</sup>*J* = 9.3 Hz, <sup>5</sup>*J* = 1.1 Hz, C1), 129.28 (ddd, <sup>3</sup>*J* = 9.7 Hz, <sup>2</sup>*J* = 3.1 Hz, <sup>4</sup>*J* = 1.6 Hz, C2), 129.44 (ddq, <sup>1</sup>*J* = 160.5 Hz, <sup>3</sup>*J* = 7.2 Hz, <sup>3</sup>*J* = 5.0 Hz, C5), 133.25 (ddq, <sup>1</sup>*J* = 164.8 Hz, <sup>3</sup>*J* = 7.4 Hz, <sup>3</sup>*J* = 2.5 Hz, C3), 139.73 (dd, <sup>1</sup>*J* = 166.4 Hz, <sup>2</sup>*J* = 1.9 Hz, C6), 139.76 (dq, <sup>3</sup>*J* = 8.4 Hz, <sup>2</sup>*J* = 6.1 Hz, C4); GCMS *m/z* (relative intensity) 296 (M<sup>+</sup>, C<sub>7</sub>H<sub>6</sub><sup>79</sup>BrI, 100), 217 (C<sub>7</sub>H<sub>6</sub>I<sup>+</sup>, 15), 169 (C<sub>7</sub>H<sub>6</sub><sup>79</sup>Br<sup>+</sup>, 9), 127 (I<sup>+</sup>, 7), 90 (C<sub>7</sub>H<sub>6</sub><sup>+</sup>, 17).

**2-Bromo-4-methyl-1-(trimethylstannyl)benzene (23)**. To a solution of 5.94 g (20.0 mmol) of **24** in a mixture of 50 mL of diethyl ether and 50 mL of THF at –110 °C was added from a syringe 12.45 mL of a 1.6 M solution of *n*-BuLi (19.9 mmol) in hexane. After addition, stirring was continued for 5 min. The mixture turned yellow and was subsequently quenched with 3.98 g of Me<sub>3</sub>SnCl (20.0 mmol, 1 M solution in pentane). After addition, the mixture was warmed and hydrolyzed with 50 mL of a 1 M NaOH solution. The organic fraction was separated and the aqueous fraction extracted with diethyl ether. The extracts were combined, washed (water), dried (MgSO<sub>4</sub>), filtered, and evaporated to dryness. The residual oil was purified by fractional distillation. The product was collected at 108 °C at 4 mbar to give 3.90 g (11.7 mmol, 58% yield) of a colorless oil.

**23**: <sup>1</sup>H NMR (CDCl<sub>3</sub>, 200.1 MHz, reference CHCl<sub>3</sub> 7.27 ppm)  $\delta$  0.43 (s, <sup>2</sup>*J*(Sn–H) = 56.1, 53.7 Hz, 9H, ArCH<sub>3</sub>), 2.37 (s, 3H, CH<sub>3</sub>), 7.09 (d, <sup>3</sup>*J* = 7.4 Hz, ArH(6)), 7.23 (d, <sup>3</sup>*J* = 7.4 Hz, ArH(5)), 7.37 (bs, 1H, ArH(3)); <sup>13</sup>C NMR (CDCl<sub>3</sub>, 50.32 MHz, reference CDCl<sub>3</sub> 77.00 ppm)  $\delta$  –7.99 (q, <sup>1</sup>*J* = 128.7 Hz, <sup>1</sup>*J*(Sn–C) = 364.2 Hz, 348.0 Hz, SnCH<sub>3</sub>), 20.99 (qt, <sup>1</sup>*J* = 126.9 Hz, *J* = 4.4 Hz, CH<sub>3</sub>), 127.32 (d, <sup>1</sup>*J* = 159.4 Hz, <sup>3</sup>*J*(Sn–C) = 40.5 Hz, C5), 132.27 (d, <sup>1</sup>*J* = 162.3 Hz, <sup>3</sup>*J*(Sn–C) = 26.7 Hz, C3), 132.94 (d, <sup>3</sup>*J* = 7.8 Hz, C2), 137.13 (d, <sup>1</sup>*J* = 161.2 Hz, <sup>2</sup>*J*(Sn–C) = 32.0 Hz, C6), 140.49 (bs, C4), 142.06 (bs, C1); GCMS *m/z* (relative intensity) 319 ([M – CH<sub>3</sub>]<sup>+</sup>, C<sub>9</sub>H<sub>12</sub><sup>79</sup>Br<sup>120</sup>Sn, 100), 304 (C<sub>8</sub>H<sub>9</sub>BrSn<sup>+</sup>, 7), 287 (4), 199 (BrSn<sup>+</sup>, 43), 135 (CH<sub>3</sub>Sn<sup>+</sup>, 6), 105 (C<sub>8</sub>H<sub>9</sub><sup>+</sup>, 37); HRMS calcd for C<sub>10</sub>H<sub>15</sub><sup>79</sup>Br<sup>118</sup>Sn 333.9378, obsd

333.9392 ± 0.0007. Anal. Calcd for C<sub>10</sub>H<sub>15</sub>BrSn: C, 35.98; H, 4.53. Found: C, 36.02; H, 4.55.

**Reaction of 23 with Magnesium in THF**. A mixture of 0.3602 g (1.079 mmol) of **23**, 0.1 mL of 1,2-dibromoethane, 100  $\mu$ L of tridecane, and 5 mL of THF was added dropwise, under an atmosphere of argon, to 0.2180 g (8.97 mmol) of magnesium covered with 5 mL of diethyl ether over 15 min at room temperature. The mixture was stirred for 24 h, and then a sample was hydrolyzed and analyzed by titration, which revealed that no reaction had occurred. After 1 week, the mixture was deuteriolized and analyzed by GCMS, which revealed that no reaction had occurred. In an independent experiment, a mixture of 1.660 g (4.97 mmol) of **23**, 0.158 g (6.58 mmol) of Mg, and 30 mL of THF was stirred in fully sealed glassware. After 1 day, a sample was deuteriolized (D<sub>2</sub>O) and worked up by the addition of diethyl ether, separation of the organic fraction, and drying of the organic fraction (MgSO<sub>4</sub>); then it was analyzed by GCMS (relative yields of converted product (4%)).

**2-Deuterio-4-methyl-1-(trimethylstannyl)benzene (32)**, 94%: <sup>1</sup>H NMR (CDCl<sub>3</sub>, 200.1 MHz, reference CHCl<sub>3</sub> 7.27 ppm)  $\delta$  0.40 (s, <sup>2</sup>*J*(Sn–H) = 55.0, 52.7 Hz, SnCH<sub>3</sub>), 2.46 (s, CH<sub>3</sub>), 7.30 (bs, 2H, aryl H), 7.49–7.53 (m, 1H, aryl H); GCMS 257 (M<sup>+</sup>, C<sub>10</sub>H<sub>15</sub>D<sup>120</sup>Sn, 1), 242 (C<sub>9</sub>H<sub>12</sub>DSn<sup>+</sup>, 100), 212 (C<sub>7</sub>H<sub>6</sub>DSn<sup>+</sup>, 40), 135 (C<sub>10</sub>H<sub>15</sub><sup>+</sup>, 15), 120 (Sn<sup>+</sup>, 32), 106 (C<sub>8</sub>H<sub>8</sub>D<sup>+</sup>, 10), 92 (C<sub>7</sub>H<sub>6</sub>D<sup>+</sup>, 19).

**4-Methyl-1,2-bis(trimethylstannyl)benzene (26)**, 5.9% yield: GCMS *m/z* (relative intensity) 405 ([M – CH<sub>3</sub>]<sup>+</sup>, C<sub>12</sub>H<sub>21</sub><sup>120</sup>Sn<sub>2</sub>, 80), 375 (C<sub>10</sub>H<sub>15</sub>Sn<sub>2</sub><sup>+</sup>, 5), 345 (C<sub>8</sub>H<sub>9</sub>Sn<sub>2</sub><sup>+</sup>, 5), 330 (C<sub>7</sub>H<sub>6</sub>Sn<sub>2</sub><sup>+</sup>, 6), 255 (C<sub>10</sub>H<sub>15</sub>Sn<sup>+</sup>, 26), 225 (C<sub>8</sub>H<sub>9</sub>Sn<sup>+</sup>, 13), 165 (C<sub>3</sub>H<sub>9</sub>Sn<sup>+</sup>, 15), 135 (C<sub>10</sub>H<sub>15</sub><sup>+</sup>, 6), 120 (Sn<sup>+</sup>, 5), 105 (C<sub>8</sub>H<sub>9</sub><sup>+</sup>, 9). These analyses were repeated after 5, 11, and 25 days, which showed 18%, 45%, and quantitative conversion, respectively, of **23**. An aliquot was quenched with Me<sub>3</sub>GeCl and, after standard workup, analyzed by <sup>1</sup>H NMR spectroscopy, GLC, and GCMS analysis.

**4-Methyl-2-(trimethylgermyl)-1-(trimethylstannyl)benzene (25)**, 96% yield: <sup>1</sup>H NMR (CDCl<sub>3</sub>, 200.1 MHz, reference CHCl<sub>3</sub> 7.27 ppm)  $\delta$  0.33 (s, <sup>2</sup>*J*(Sn–H) = 53.3, 50.9 Hz, 9H, SnCH<sub>3</sub>), 0.43 (s, 9H, GeCH<sub>3</sub>), 2.34 (s, 3H, CH<sub>3</sub>), 7.13 (dd, <sup>2</sup>*J* = 7.5 Hz, <sup>4</sup>*J* = 1.4 Hz, 1H, ArH(5)), 7.38 (d, <sup>4</sup>*J* = 1.4 Hz, 1H, ArH(3)), 7.45 (d, 7.5 Hz, 1H, ArH(6)); GCMS *m/z* (relative intensity) 359 ([M – CH<sub>3</sub>]<sup>+</sup>, C<sub>12</sub>H<sub>21</sub><sup>74</sup>Ge<sup>120</sup>Sn<sup>+</sup>, 78), 329 (C<sub>10</sub>H<sub>15</sub>-GeSn, 5), 299 (5), 241 (C<sub>9</sub>H<sub>13</sub>Sn<sup>+</sup>, 16), 209 (13), 195 (11), 165 (C<sub>3</sub>H<sub>9</sub>Sn<sup>+</sup>, 28), 150 (6), 135 (23), 119 (45), 105 (26); HRMS calcd for C<sub>12</sub>H<sub>21</sub><sup>118</sup>Sn<sup>70</sup>Ge ([M – CH<sub>3</sub>]<sup>+</sup>) 352.9904, obsd 352.9893 ± 0.0010. Anal. Calcd for C<sub>15</sub>H<sub>24</sub>GeSn: C, 42.02; H, 6.51. Found: C, 42.21; H, 6.63.

**4-Methyl-2-(trimethylstannyl)-1-(trimethylstannyl)benzene (26)**, 2% yield: GCMS *m/z* (relative intensity) 405 ([M – CH<sub>3</sub>]<sup>+</sup>, C<sub>12</sub>H<sub>21</sub><sup>120</sup>Sn<sub>2</sub>, 80), 375 (C<sub>10</sub>H<sub>15</sub>Sn<sub>2</sub><sup>+</sup>, 5), 345 (C<sub>8</sub>H<sub>9</sub>Sn<sub>2</sub><sup>+</sup>, 5), 330 (C<sub>7</sub>H<sub>6</sub>Sn<sub>2</sub><sup>+</sup>, 6), 255 (C<sub>10</sub>H<sub>15</sub>Sn<sup>+</sup>, 26), 225 (C<sub>8</sub>H<sub>9</sub>Sn<sup>+</sup>, 13), 165 (C<sub>3</sub>H<sub>9</sub>Sn<sup>+</sup>, 15), 135 (C<sub>10</sub>H<sub>15</sub><sup>+</sup>, 6), 120 (Sn<sup>+</sup>, 5), 105 (C<sub>8</sub>H<sub>9</sub><sup>+</sup>, 9).

**4-Methyl-1,2-bis(trimethylgermyl)benzene (27)**, 2% yield: GCMS *m/z* (relative intensity) 328 (M<sup>+</sup>, C<sub>13</sub>H<sub>24</sub><sup>74</sup>Ge<sub>2</sub>, 4), 313 (C<sub>12</sub>H<sub>21</sub>Ge<sub>2</sub><sup>+</sup>, 80), 297 (C<sub>11</sub>H<sub>17</sub>Ge<sub>2</sub><sup>+</sup>, 22), 195 (C<sub>9</sub>H<sub>13</sub>Ge<sup>+</sup>, 28), 119 (C<sub>3</sub>H<sub>9</sub>Ge<sup>+</sup>, 17), 105 (C<sub>8</sub>H<sub>9</sub><sup>+</sup>, 14).

**2-Bromo-4-methyl-1-(trimethylgermyl)benzene (31)**. With 2-bromo-4-methylaniline (6.28 g, 21.1 mmol) as starting material, the procedure was analogous to that described for **23**, using Me<sub>3</sub>GeCl (3.37 g, 22.0 mmol) instead of Me<sub>3</sub>SnCl. The product was collected at 81 °C at 3 mbar to give 3.91 g (13.6 mmol, 64% yield) of a colorless oil.

**31**: <sup>1</sup>H NMR (CDCl<sub>3</sub>, 200.1 MHz, reference CHCl<sub>3</sub>)  $\delta$  0.49 (s, 9H, GeCH<sub>3</sub>), 2.31 (s, 3H, CH<sub>3</sub>), 7.08 (d, <sup>3</sup>*J* = 7.5 Hz, <sup>4</sup>*J* = 0.8 Hz, 1H, ArH(5)), 7.25 (d, <sup>3</sup>*J* = 7.5 Hz, 1H, ArH(6)), 7.37 (d, <sup>4</sup>*J* = 1.0 Hz, 1H, ArH(3)); <sup>13</sup>C NMR (CDCl<sub>3</sub>, 50.32 MHz, reference CDCl<sub>3</sub> 77.00 ppm)  $\delta$  –0.64 (qt, <sup>1</sup>*J* = 126.1 Hz, *J* = 1.8 Hz, GeCH<sub>3</sub>), 20.81 (qt, <sup>1</sup>*J* = 126.9 Hz, <sup>3</sup>*J* = 4.5 Hz, CH<sub>3</sub>), 127.34 (ddq, <sup>1</sup>*J* = 158.6 Hz, <sup>3</sup>*J* = 5.0 Hz, <sup>3</sup>*J* = 4.0 Hz, C5), 130.43 (ddd, <sup>3</sup>*J* = 12.9 Hz, <sup>2</sup>*J* = 2.9 Hz, <sup>4</sup>*J* = 1.4 Hz, C2), 133.08

(47) (a) Eisch, J. J.; Kotowicz, B. W. *Eur. J. Inorg. Chem.* **1998**, 761. (b) Seyferth, D.; White, D. L. *J. Organomet. Chem.* **1972**, *34*, 119.

(dq,  $^1J = 163.0$  Hz,  $^3J = 5.0$  Hz,  $^3J = 1.2$  Hz, C3), 134.92 (dd,  $^1J = 160.1$  Hz,  $^2J = 1.1$  Hz, C6), 139.90 (m, C4), 140.43 (bs, C1); GCMS  $m/z$  (relative intensity) 288 ( $M^+$ ,  $C_{10}H_{15}Br^{74}Ge$ , 3), 273 ( $C_9H_{12}BrGe$ , 55), 153 (14), 119 ( $C_3H_9Ge^+$ , 3), 105 ( $C_8H_9^+$ , 100), 89 (11); HRMS calcd for  $C_{10}H_{15}^{70}Ge^{79}Br$  283.9600, obsd 283.960  $\pm$  0.001. Anal. Calcd for  $C_{10}H_{15}GeBr$ : C, 41.74; H, 5.26; Br, 27.8. Found: C, 41.82; H, 5.33; Br, 27.4.

**Reaction of 31 with Magnesium.** A mixture of 2.44 g (8.47 mmol) of **31**, 0.36 g (15 mmol) of magnesium, and 50 mL of THF was stirred for 2 weeks at room temperature. A sample was deuteriolized ( $D_2O$ ) and analyzed by  $^1H$  NMR spectroscopy and GCMS. 2-Deuterio-4-methyl-1-(trimethylgermyl)-benzene (**32**), 100% yield:  $^1H$  NMR ( $CDCl_3$ , 200.1 MHz, reference  $CHCl_3$  7.27 ppm)  $\delta$  0.54 (s, 9H,  $GeCH_3$ ), 2.51 (s, 3H,  $CH_3$ ), 7.32–7.35 (m, 2H, ArH(3,5)), 7.55 (d,  $^3J = 8.0$  Hz, 1H, ArH(6)); GCMS  $m/z$  (relative intensity) 211 ( $M^+$ ,  $C_{10}H_{15}D^{74}Ge$ , 5), 196 ( $C_9H_{12}DGe^+$ , 100), 166 ( $C_7H_6DGe$ , 16), 106 ( $C_8H_8D^+$ , 6), 92 ( $C_8H_6D^+$ , 9).

A second sample was derivatized with  $Me_3SnCl$  and stirred for 1 week at room temperature. After the standard workup, the residue was characterized by  $^1H$  NMR and GCMS as pure **28**.

**28:**  $^1H$  NMR ( $CDCl_3$ , 200.1 MHz, reference  $CHCl_3$  7.27 ppm)  $\delta$  0.34 (s,  $^2J(Sn-H) = 53.2$  Hz, 51.0 Hz, 9H,  $SnCH_3$ ), 0.42 (s, 9H,  $GeCH_3$ ), 2.34 (s, 3H,  $CH_3$ ), 7.13 (d,  $^3J = 7.5$  Hz, 1H, ArH(6)), 7.37 (bs, 1H, ArH(3)), 7.46 (d,  $^3J = 7.6$  Hz, ArH(5));  $^{13}C$  NMR ( $CDCl_3$ , 50.32 MHz, reference  $CDCl_3$  77.00 ppm)  $\delta$  -6.17 (qt,  $^1J = 128.6$  Hz,  $J = 1.8$  Hz,  $^1J(Sn-C) = 341.8$  Hz, 326.6 Hz,  $SnCH_3$ ), 0.44 (qt,  $^1J = 125.4$  Hz,  $J = 1.9$  Hz,  $GeCH_3$ ), 21.30 (qt,  $^1J = 126.3$  Hz,  $J = 4.4$  Hz,  $CH_3$ ), 128.40 (ddt,  $^1J = 157.8$  Hz,  $^3J = 5.5$  Hz,  $J = 4.9$  Hz,  $^4J(Sn-C) = 12.4$  Hz, C4), 134.08 (d,  $^1J = 157.8$  Hz,  $^3J(Sn-C) = 61.4$  Hz, C6), 137.02 (qq,  $^1J = 6.4$  Hz,  $J = 6.4$  Hz, C4), 137.83 (ddq,  $^1J = 154.9$  Hz,  $^3J = 5.0$  Hz,  $^3J = 5.0$  Hz,  $^2J(Sn-C) = 21.4$  Hz, C3), 146.97 (bs, C1), 148.06 (bs, C2); GCMS  $m/z$  (relative intensity) 359 ( $[M - CH_3]^+$ ,  $C_{12}H_{21}^{74}Ge^{120}Sn$ , 79), 329 ( $C_{10}H_{15}GeSn^+$ , 6), 297 ( $C_8H_7GeSn^+$ , 7), 284 ( $C_7H_6GeSn^+$ , 4), 241 (12), 165 (8), 135 (5), 119 (7), 105 (3).

**1-Bromo-2-((tri-*n*-butylstannyl)methyl)benzene (34).** A solution of 10.00 g (40.0 mmol) of 1-bromo-2-(bromomethyl)-benzene in 250 mL of diethyl ether was added dropwise under nitrogen to 0.973 g (40.0 mmol) of doubly sublimed magnesium covered with 50 mL of diethyl ether over 6 h at room temperature. After the addition was complete, stirring was continued for 1 h. The yellow solution was carefully siphoned from the residual magnesium into another reaction flask; then it was cooled to 0 °C followed by the addition of 13 g (40 mmol) of (*n*-Bu) $_3$ SnCl. A white precipitate slowly formed. The mixture was stirred for 2 days, and then 20 mL of saturated  $NH_4Cl$  was added. The organic fraction was separated and the aqueous fraction extracted with diethyl ether. The extracts were combined, washed (water), dried ( $MgSO_4$ ), filtered, and evaporated to dryness. The residual oil was purified by fractional distillation. The product was collected at 78 °C at 3 mbar to give 7.24 g (15.7 mmol, 39% yield) of a colorless oil.

**34:**  $^1H$  NMR ( $CDCl_3$ , 200.1 MHz, reference  $CHCl_3$  7.27 ppm)  $\delta$  0.83–0.95 (m, 15H), 1.19–1.33 (m, 6H,  $CH_2CH_3$ ), 1.37–1.54 (m, 6H,  $SnCH_2CH_2$ ), 2.48 (s,  $^2J(Sn-H) = 55.8$  Hz, 2H, Ar $CH_2$ ), 6.81–6.91 (m, 1H, ArH(5)), 7.07–7.14 (m, 2H, aryl H), 7.45–7.49 (m, 1H, ArH(6));  $^{13}C$  NMR ( $CDCl_3$ , 50.32 MHz, reference  $CDCl_3$  77.00 ppm)  $\delta$  10.04 (t,  $^1J = 126.5$  Hz,  $SnCH_2$ ), 13.56 (qt,  $^1J = 138.4$  Hz,  $^2J = 6.0$  Hz,  $CH_3$ ), 20.08 (t,  $^1J = 131.1$  Hz, Ar $CH_2$ ), 27.20 (m,  $^3J(Sn-C) = 54.6$  Hz,  $CH_2CH_3$ ), 28.85 (m,  $^2J(Sn-C) = 20.4$  Hz,  $SnCH_2CH_2$ ), 122.41 (bs, C1), 124.30 (dd,  $^1J = 162$  Hz, C5), 127.10 (dd,  $^1J = 162$  Hz, C4), 128.29 (dt,  $^1J = 163.2$  Hz,  $^3J = 3.7$  Hz, C3), 132.23 (dd,  $^1J = 163$  Hz, C6), 143.86 (bs, C2);  $^{119}Sn$  NMR ( $CHCl_3$ , 149.21 MHz, reference  $Me_4Sn$  0.000 ppm)  $\delta$  -8.254. GCMS  $m/z$  (relative intensity) 403 ( $[M - C_4H_9]^+$ ,  $C_{15}H_{24}^{79}Br^{120}Sn$ , 93), 347 ( $C_{11}H_{16}BrSn^+$ , 12), 291 ( $C_7H_8BrSn^+$ , 38), 235 ( $C_9H_7Sn^+$ , 55), 199 ( $BrSn^+$ , 58), 179 (100), 177 ( $C_4H_9Sn^+$ , 98), 120 ( $Sn^+$ , 24), 91 ( $C_7H_7^+$ , 21).

**Reaction of 34 with Magnesium in THF.** A mixture of 2.30 g (5.0 mmol) of **34**, 0.146 g (6.00 mmol) of magnesium, and 50 mL of THF was stirred at room temperature; a white suspension slowly formed. After 24 h, a sample was deuteriolized ( $D_2O$ ) and worked up by addition of diethyl ether, separation of the organic and aqueous fractions, and drying of the organic fraction ( $MgSO_4$ ), after which it was analyzed by GCMS and  $^1H$  NMR spectroscopy.

2-Deuterio-1-((tri-*n*-butylstannyl)methyl)benzene (**35**, 89% deuterated), 18% yield:  $^1H$  NMR ( $CDCl_3$ , 200.1 MHz, reference  $CHCl_3$  7.27 ppm)  $\delta$  2.46 (t,  $^2J(D-H) = 2.3$  Hz, 2H,  $CH_2$ ); GCMS  $m/z$  (relative intensity) 326 ( $[M - C_4H_9]^+$ ,  $C_{15}H_{24}D^{120}Sn^+$ , 38), 291 ( $C_{12}H_{22}Sn^+$ , 29), 270 ( $C_{11}H_{16}DSn^+$ , 16), 235 ( $C_9H_7Sn^+$ , 47), 212 ( $C_7H_6DSn^+$ , 48), 179 (100), 177 ( $C_4H_9Sn^+$ , 97), 121 (57), 92 (36).

1-(Deuteriomethyl)-2-(tri-*n*-butylstannyl)benzene (**36**), 82% yield:  $^1H$  NMR ( $CDCl_3$ , 200.1 MHz, reference  $CHCl_3$  7.27 ppm)  $\delta$  2.38 (s, 2H,  $CH_2$ ); GCMS  $m/z$  (relative intensity) 326 ( $[M - C_4H_9]^+$ ,  $C_{15}H_{24}D^{120}Sn^+$ , 57), 291 ( $C_{12}H_{27}Sn^+$ , 5), 270 ( $C_{11}H_{16}DSn^+$ , 37), 235 ( $C_9H_7Sn^+$ , 6), 212 ( $C_7H_6DSn^+$ , 100), 177 ( $C_4H_9Sn^+$ , 12), 120 ( $Sn^+$ , 27), 92 ( $C_7H_6D^+$ , 28). Comparison with an authentic sample (vide infra) of 1-methyl-2-(tri-*n*-butylstannyl)benzene revealed a deuterium incorporation of 96%.

Another 10 mL of the reaction mixture was derivatized with 1.5 mmol of  $Me_3GeCl$  and after standard workup was analyzed by  $^1H$  NMR spectroscopy and GCMS. **8** was obtained in 10% yield.

2-(Tri-*n*-butylstannyl)methyl-1-(trimethylgermyl)benzene (**37**), 16% yield:  $^1H$  NMR ( $CDCl_3$ , 200.1 MHz, reference  $CHCl_3$  7.27 ppm)  $\delta$  0.43 (s, 9H,  $GeCH_3$ ), 2.37 (s, 2H,  $CH_2$ ); GCMS  $m/z$  (relative intensity) 500 ( $M^+$ ,  $C_{22}H_{42}^{74}Ge^{120}Sn$ , 1), 443 ( $C_{18}H_{33}^{74}Ge^{120}Sn^+$ , 2), 291 ( $C_{12}H_{27}Sn^+$ , 100), 249 (13), 235 ( $C_8H_{19}Sn^+$ , 65), 207 (15), 193 (16), 177 ( $C_4H_9Sn^+$ , 68), 135 (21), 119 ( $C_3H_9Sn^+$ , 32), 105 (9), 91 (7).

1-(Tri-*n*-butylstannyl)-2-(trimethylgermyl)methylbenzene (**38**), 64% yield:  $^1H$  NMR ( $CDCl_3$ , 200.1 MHz, reference  $CHCl_3$  7.27 ppm)  $\delta$  0.14 (s, 9H,  $GeCH_3$ ), 2.28 (s,  $^4J(Sn-H) = 5.7$  Hz,  $CH_2$ ); GCMS  $m/z$  (relative intensity) 443 ( $[M - C_4H_9]^+$ ,  $C_{18}H_{33}^{74}Ge^{120}Sn$ , 38), 249 ( $MeSnBu_2^+$ , 100), 207 (35), 193 (49), 177 (8), 135 (27), 119 (25), 105 (4), 91 (6).

1-(Tri-*n*-butylstannyl)-2-(tri-*n*-butylstannyl)methylbenzene (**39**), 10% yield:  $^1H$  NMR ( $CDCl_3$ , 200.1 MHz, reference  $CHCl_3$  7.27 ppm)  $\delta$  2.44 (s, 2H,  $CH_2$ ); GCMS  $m/z$  (relative intensity) 361 (5), 324 (12), 291 (100), 268 (13), 235 (46), 211 (33), 177 (52), 121 (21). Complete assignment of the other signals was not possible, due to the complexity of the spectrum.

**1-Methyl-2-(tri-*n*-butylstannyl)benzene.** For comparison with **36** (vide supra), a solution of 1.71 g (10.0 mmol) of 2-bromotoluene in 50 mL of THF was added dropwise under nitrogen to 0.24 g (10 mmol) of magnesium covered with 10 mL of THF. After the addition was completed, stirring was continued for 1 h and then the mixture was quenched with 3.25 g (10.0 mmol) of (*n*-Bu) $_3$ SnCl. 1-Methyl-2-(tri-*n*-butylstannyl)benzene: GCMS  $m/z$  (relative intensity) 325 ( $[M - C_4H_9]^+$ ,  $C_{15}H_{25}^{120}Sn$ , 81), 269 ( $C_{15}H_{26}Sn^+$ , 46), 211 ( $C_7H_7Sn^+$ , 100), 120 ( $Sn^+$ , 24), 91 ( $C_7H_7^+$ , 22).

**2,2'-Dibromobiphenyl.**<sup>27</sup> To a solution of 47.08 g (0.200 mol) of *o*-dibromobenzene in 400 mL of THF was added dropwise, under an atmosphere of nitrogen, 64 mL of a 1.6 M solution of *n*-BuLi (0.10 mmol) in *n*-hexane while the temperature was maintained below -65 °C. After addition, the mixture was warmed to 0 °C and subsequently hydrolyzed with 100 mL of a 1 M HCl solution. The organic solvents were removed by rotary evaporation, and the residue was extracted with diethyl ether. The combined organic layers were washed (brine), dried ( $MgSO_4$ ), filtered, and evaporated to dryness. The brown residue was crystallized from EtOH, yielding 22.72 g (72.8 mmol, 73% yield, lit.<sup>27</sup> 74%) of a white solid (mp 78.8–79.2 °C, lit.<sup>27</sup> 80–81 °C) which was characterized by  $^1H$  NMR spectroscopy and GCMS as pure 2,2'-dibromobiphenyl:  $^1H$  NMR ( $CDCl_3$ , 200.1 MHz, reference  $CHCl_3$  7.27 ppm)  $\delta$  7.23–

7.44 (m, 6H), 7.66–7.71 (m, 2H); GCMS  $m/z$  (relative intensity) 310 ( $M^+$ ,  $C_{12}H_8^{79}Br_2$ , 25), 231 ( $C_{12}H_8Br^+$ , 64), 152, ( $C_{12}H_8^+$ , 100).

**2-Bromo-2'-(trimethylstannyl)biphenyl (40).** To a solution of 6.31 g (20.2 mmol) of 2,2'-dibromobiphenyl in 125 mL of THF was added dropwise, under an atmosphere of argon, 12.5 mL of a 1.6 M solution of *n*-BuLi (20.0 mmol) in *n*-hexane while the temperature was maintained below  $-65^\circ\text{C}$ . After addition, the mixture was stirred for 5 min and subsequently quenched with 3.98 g of  $Me_3SnCl$  (20.0 mmol, 1 M solution in pentane). The mixture was warmed to room temperature, and a saturated solution of  $NH_4Cl$  in water was added. Subsequently, the organic solvent was removed by distillation and the residue was extracted with diethyl ether. The combined organic layers were washed (brine), dried ( $MgSO_4$ ), filtered, and evaporated to dryness. The residue was recrystallized from EtOH, yielding 6.17 g (15.6 mmol, 77% yield) of a white solid (mp  $45.0$ – $45.6^\circ\text{C}$ ), which was characterized by  $^1H$  NMR spectroscopy and GCMS as pure **40**.

**40:**  $^1H$  NMR ( $C_6D_6$ , 400.1 MHz, reference  $C_6D_5H$  7.17 ppm); the chemical shifts and coupling constants were determined by simulation using the PANIC program,<sup>48</sup> a version of the LAOCOON type of programs<sup>49</sup>  $\delta$  0.043 (s,  $^2J(Sn-H) = 54.74$ , 52.38 Hz, 9H,  $SnCH_3$ ), 6.717 (ddd,  $^3J = 8.07$  Hz,  $^3J = 7.47$  Hz,  $^4J = 1.80$  Hz, 1H, ArH(4)), 6.88 (td,  $^3J = 7.55$  Hz,  $^3J = 7.47$  Hz,  $^4J = 1.24$  Hz, 1H, ArH(5)), 7.047 (ddd,  $^3J = 7.55$  Hz,  $^4J = 1.80$  Hz,  $^5J = 0.30$  Hz, 1H, ArH(6)), 7.211 (td,  $^3J = 7.39$  Hz,  $^3J = 7.36$  Hz,  $^4J = 1.32$  Hz, 1H, ArH(5')), 7.211 (td,  $^3J = 7.57$  Hz,  $^3J = 7.29$  Hz,  $^4J = 0.62$  Hz, 1H, ArH(4')), 7.256 (dt,  $^3J = 7.57$  Hz,  $^4J = 1.34$  Hz,  $^4J = 1.32$  Hz, 1H, ArH(6')), 7.421 (ddd,  $^3J = 8.07$  Hz,  $^4J = 1.24$  Hz,  $^5J = 0.3$  Hz, 1H, ArH(3)), 7.574 (ddd,  $^3J = 7.36$  Hz,  $^4J = 1.34$  Hz,  $^5J = 0.62$  Hz, 1H, ArH(3'));  $^{13}C$  NMR ( $CDCl_3$ , 100.6 MHz, reference  $CDCl_3$  77.00 ppm)  $\delta$  -8.46 (q,  $^1J = 128.8$  Hz,  $^2J = 1.1$  Hz,  $^2J(Sn-C) = 351.9$  Hz, 336.2 Hz, C7), 124.01 (bs,  $^4J(Sn-C) = 3.6$  Hz, C2), 126.89 (dd,  $^1J = 162.6$  Hz,  $^2J = 7.8$  Hz, C5), 126.92 (ddt,  $^1J = 162.4$  Hz,  $^2J = 7.0$  Hz,  $J = 0.9$  Hz, C6'), 127.76 (dd,  $^1J = 160.0$  Hz,  $^3J = 7.5$  Hz, C5'), 128.90 (dd,  $^1J = 162.5$  Hz,  $^2J = 8.9$  Hz, C4), 129.17 (dt,  $^1J = 167.6$  Hz,  $J = 4.5$  Hz, C4'), 131.41 (ddt,  $^1J = 161.7$  Hz,  $^2J = 8.3$  Hz,  $J = 1.3$  Hz, C6), 132.52 (dddd,  $^1J = 165.6$  Hz,  $^3J = 7.9$  Hz,  $^2J = 1.8$  Hz,  $^4J = 1.0$  Hz, C3), 135.92 (ddd,  $^1J = 157.7$  Hz,  $^3J = 4.9$  Hz,  $^2J = 0.8$  Hz,  $^2J(Sn-C) = 35.8$  Hz, 34.2 Hz, C3'), 142.10 (bs, C1), 144.93 (bs, C2), 148.91 (bs,  $^1J(Sn-C) = 29.1$  Hz, 27.8 Hz, C2');  $^{119}Sn$  NMR ( $CHCl_3$ , 149.21 MHz, reference  $Me_4Sn$  0.000 ppm)  $\delta$  -30.321; GCMS  $m/z$  (relative intensity) 381 ( $[M - CH_3]^+$ , 100) 351 (6,  $C_{12}H_8^{79}Br^{120}Sn^+$ ), 287 (3,  $C_{13}H_{11}Sn^+$ ), 229 (5,  $C_{12}H_8Br^+$ ), 199 (10) 152 (6,  $C_{12}H_8^+$ ), 120 (1,  $Sn^+$ ); HRMS calcd for  $C_{14}H_{14}^{79}Br^{118}Sn$  ( $[M - CH_3]^+$ ) 378.9297, obsd 378.929  $\pm$  0.001. Anal. Calcd for  $C_{15}H_{17}BrSn$ : C, 45.44; H, 4.33; Br, 20.6. Found: C, 45.51; H, 4.33; Br, 20.2.

**Reaction of 40 with Magnesium in Diethyl Ether.** A mixture of 0.262 g (0.662 mmol) of **40**, 0.048 g (2.0 mmol) of doubly sublimed magnesium, and 10 mL of diethyl ether was stirred for several days at room temperature. A sample was hydrolyzed and analyzed by titration, which revealed that no reaction had occurred. Subsequently, the reaction mixture was stirred for 2 days under reflux. The reaction vessel was opened and the mixture worked up to give **40** quantitatively.

**Reaction of 40 with Magnesium in THF.** A mixture of 2.020 g (5.1 mmol) of **40**, 0.267 g (11 mmol) of doubly sublimed magnesium, and 50 mL of THF was stirred for 1 day. Within a few hours the mixture turned green. After settling of the magnesium dust, the clear yellow solution was decanted into a second reaction vessel. A sample of the crude Grignard solution was quenched with  $D_2O$ . After hydrolysis, the solvent was evaporated, the residue was extracted with diethyl ether, and the organic fractions were combined, dried ( $MgSO_4$ ),

filtered, and evaporated to dryness. The product distribution and yields were determined by  $^1H$  NMR spectroscopy, GLC, and GCMS.

2,2'-Dideuteriobiphenyl, 10% yield:  $^1H$  NMR ( $CDCl_3$ , 200.1 MHz, reference  $CHCl_3$  7.27 ppm)  $\delta$  7.07–7.40 (m, 6H, aryl H), 7.49–7.60 (m, 2H, aryl H); GCMS  $m/z$  (relative intensity) 156 ( $M^+$ ,  $C_{12}H_8D_2$ , 100), 77 (10).

2-Deuterio-2'-(trimethylstannyl)biphenyl, 12% yield:  $^1H$  NMR ( $CDCl_3$ , 200.1 MHz, reference  $CHCl_3$  7.27 ppm)  $\delta$  0.00 (s,  $^2J(Sn-H) = 54.8$ , 52.4 Hz, 9H,  $SnCH_3$ ), 7.34–7.40 (m, 6H, aryl H), 7.57–7.62 (m, 1H, ArH(3')); GCMS  $m/z$  (relative intensity) 304 ( $[M - CH_3]^+$ ,  $C_{14}H_{14}D^{120}Sn^+$ , 100), 274 ( $C_{12}H_9DSn^+$ , 35), 166 ( $C_3H_8DSn^+$ , 4), 153 ( $C_{12}H_7D^+$ , 13), 120 ( $Sn^+$ , 11).

9,9-Dimethyl-9-stannafluorene (**43**), 78% yield:  $^1H$  NMR ( $CDCl_3$ , 400 MHz, reference  $CHCl_3$  7.27 ppm)  $\delta$  0.557 (s,  $^2J(Sn-H) = 60.63$ , 54.93 Hz, 6H,  $SnCH_3$ ), 7.309 (td,  $^3J = 7.25$  Hz,  $^3J = 7.00$  Hz,  $^4J = 1.10$  Hz,  $^4J(Sn-H) = 13.56$  Hz, 2H, ArH(2)), 7.426 (td,  $^3J = 7.47$  Hz,  $^3J = 7.25$  Hz,  $^4J = 1.46$  Hz,  $^5J(Sn-H) = 6.17$  Hz, 2H, ArH(3)), 7.694 (ddd,  $^3J = 7.00$  Hz,  $^4J = 1.46$  Hz,  $^5J = 0.63$  Hz,  $^3J(Sn-H) = 38.45$  Hz, 37.08 Hz, 2H, ArH(1)), 7.976 (dt,  $^3J = 7.37$  Hz,  $^4J = 1.10$  Hz,  $^5J = 0.63$  Hz,  $^4J(Sn-H) = 11.1$  Hz, 2H, ArH(4));  $^{13}C$  NMR ( $CDCl_3$ , 50.323 MHz, reference  $CDCl_3$  77.00 ppm)  $\delta$  -8.59 (qq,  $^1J = 131.3$  Hz,  $^3J = 1.0$  Hz,  $^2J(Sn-C) = 362$  Hz, 346 Hz,  $SnCH_3$ ), 122.42 (ddt,  $^1J = 155.2$  Hz,  $^3J = 7.3$  Hz,  $^3J = 1.7$  Hz,  $^3J(Sn-C) = 38.9$  Hz, C4), 127.43 (dd,  $^1J = 161.4$  Hz,  $^3J = 7.1$  Hz,  $^3J(Sn-C) = 42.3$  Hz, C1), 129.10 (dd,  $^1J = 158.6$  Hz,  $^3J = 7.4$  Hz, C3), 136.24 (dd,  $^1J = 161.8$  Hz,  $^3J = 7.5$  Hz,  $^3J(Sn-C) = 44.3$  Hz, C1), 140.81 (bs, C4a), 148.15 (bs, C8a);  $^{119}Sn$  NMR ( $CHCl_3$ , 149.21 MHz, reference  $Me_4Sn$  0.000 ppm)  $\delta$  -30.950 ppm; GCMS  $m/z$  (relative intensity) 302 (25,  $M^+$ ,  $C_{14}H_{14}^{120}Sn$ ) 287 (100,  $C_{13}H_{11}Sn^+$ ), 272 (23,  $C_{12}H_8Sn^+$ ), 165 (5,  $C_3H_9Sn^+$ ), 120 (1,  $Sn^+$ ); HRMS calcd for  $C_{14}H_{14}^{118}Sn$  300.0114, obsd 300.0114  $\pm$  0.0004. Anal. Calcd for  $C_{14}H_{14}Sn$ : C, 55.87; H, 4.69. Found: C, 55.75; H, 4.67.

Another sample was quenched with  $Me_3GeCl$  and, after standard workup, analyzed by  $^1H$  NMR spectroscopy and GCMS. **43** was obtained in 70% yield.

2-(Trimethylgermyl)-2'-(trimethylstannyl)biphenyl (**41**), 21% yield:  $^1H$  NMR ( $CDCl_3$ , 200.1 MHz, reference  $CHCl_3$  7.27 ppm)  $\delta$  -0.03 (s,  $^2J(Sn-H) = 54.7$ , 52.4 Hz, 9H,  $SnCH_3$ ), 0.08 (s, 9H,  $GeCH_3$ ), 7.15–7.53 (m, 8H, aryl H); GCMS  $m/z$  (relative intensity) 419 ( $[M - CH_3]^+$ ,  $C_{17}H_{23}^{74}Ge^{120}Sn$ , 51), 287 ( $C_{13}H_{11}Sn^+$ , 100), 241 (16), 165 ( $C_3H_9Sn^+$ , 67), 152 ( $C_8H_8^+$ , 10), 135 ( $CH_3Sn^+$ , 12), 119 ( $C_3H_9Ge^+$ , 18).

2,2'-Bis(trimethylgermyl)biphenyl (**42**), 9% yield:  $^1H$  NMR ( $CDCl_3$ , 200.1 MHz, reference  $CHCl_3$  7.27 ppm)  $\delta$  0.09 (s, 18H,  $GeCH_3$ ), 7.24–7.81 (m, 8H, aryl H); GCMS  $m/z$  (relative intensity) 375 ( $[M - CH_3]^+$ ,  $C_{17}H_{23}^{74}Ge_2$ , 10), 241 ( $C_{13}H_{11}Ge^+$ , 100), 226 ( $C_{12}H_8Ge^+$ , 7), 119 ( $C_3H_9Ge^+$ , 46), 89 (6).

In an independent experiment, a mixture of 0.0880 g (0.22 mmol) of **40**, 0.0186 g (0.78 mmol) of triply sublimed magnesium, and 0.6 mL of THF- $d_6$  was stirred in a sealed NMR tube at room temperature. After 1 h, the contents of the tube were analyzed by  $^1H$  NMR spectroscopy. The following compounds were observed: 2-(bromomagnesio)-2'-(trimethylstannyl)biphenyl (12.0%), **43** (40.6%), 2,2'-bis(bromomagnesio)biphenyl (6.7%),  $Me_4Sn$  (1.2%), and  $MeMgBr$  (39.4%). These compounds resulted in the following composition: 20.2% 2-(bromomagnesio)-2'-(trimethylstannyl)biphenyl, 11.2% 2,2'-bis(bromomagnesio)biphenyl, and 68.5% **43**. All signal intensities remained constant in time, with the exception for the signal assigned to  $Me_4Sn$ , which varied up to 3 times its original height.

$MeMgBr$ , 97% yield (with respect to **43**):  $^1H$  NMR (THF- $d_6$ , 200.1 MHz, reference THF- $d_7$  1.75 ppm)  $\delta$  -1.64 (s, 3H,  $CH_3$ );  $^{13}C$  NMR (THF- $d_6$ , 50.32 MHz, reference THF- $d_6$  24.00 ppm)  $\delta$  -17.80 (s,  $CH_3$ ).

$Me_4Sn$ :  $^1H$  NMR (THF- $d_6$ , 200.1 MHz, reference THF- $d_7$  1.75 ppm)  $\delta$  0.09 (s,  $^2J(Sn-H) = 54.4$ , 52.1 Hz, 12H,  $SnCH_3$ );

(48) Program PANIC, Bruker program library.

(49) Castellano, S.; Bothner-By, A. A. *J. Chem. Phys.* **1964**, *41*, 3863.

$^{13}\text{C}$  NMR (THF- $d_6$ , 50.32 MHz, reference THF- $d_6$  24.00 ppm)  $\delta$  -10.84 (s, SnCH<sub>3</sub>).

In another experiment, a mixture of 0.0830 g (0.210 mmol) of **40**, 0.0197 g (0.81 mmol) of triply sublimed magnesium, and 0.6 mL of THF- $d_6$  was stirred in a sealed NMR tube at 5 °C. The following distribution was established, as derived from  $^1\text{H}$  NMR spectroscopy: 22.5% 2-(bromomagnesio)-2'-(trimethylstannyl)biphenyl, 8.8% 2,2'-bis(bromomagnesio)biphenyl, and 68.7% **43**.

**Reaction of 43 with MeMgBr.** To a solution of 0.301 g (1.0 mmol) of **43** in 15 mL of THF was added 3.3 mL of a 3 M solution of MeMgBr (10 mmol) in diethyl ether. The mixture was heated under reflux for 4 h and, after it was cooled to room temperature, deuteriolized (D<sub>2</sub>O). The organic solvents were removed by rotary evaporation, and the residue was extracted with diethyl ether. The organic layers were combined, washed (brine), dried (MgSO<sub>4</sub>), filtered, and evaporated to dryness. The white solid residue was characterized by  $^1\text{H}$  NMR spectroscopy and GCMS as pure **43**.

**1-Bromo-2-((trimethylsilyl)methyl)benzene (1b).**<sup>50</sup> The synthesis of **1b** was performed by the procedure described by Brandsma et al.<sup>51</sup> A solution of 41.3 mmol of 2-bromotoluene (7.1 g) and 50.0 mmol of chlorotrimethylsilane (5.4 g) in 20 mL of THF was added to a solution of 41.3 mmol of LDA in 40 mL of THF/*n*-hexane (ratio 1/1) over 20 min at -100 °C. After the addition was complete, the mixture was stirred for another 20 min at -100 °C; then it was warmed to room temperature within 1 h. Meanwhile, the mixture became yellow while a white precipitate formed. Stirring was continued at room temperature for 24 h, and then 25 mL of water was added. The organic fraction was separated, and the aqueous fraction was extracted three times with diethyl ether. The organic fractions were combined, washed with 2 M HCl and 1 M NaHCO<sub>3</sub> and finally with water until neutral. After the organic fraction had been dried (MgSO<sub>4</sub>), the solvents were evaporated and the residue subjected to fractional distillation. The product was collected at 90 °C at 9 mbar to give 4.62 g (19.0 mmol, 46% yield) of a colorless oil.<sup>50</sup>

**1b:**  $^1\text{H}$  NMR (CDCl<sub>3</sub>, 200.1 MHz, reference CHCl<sub>3</sub> 7.27 ppm)  $\delta$  -0.01 (s,  $^2J(\text{Si}-\text{H}) = 6$  Hz, 9H, CH<sub>3</sub>), 2.22 (s, 2H, CH<sub>2</sub>), 6.70–7.10 (m, 3H, arom), 7.32–7.50 (m, 1H, aryl H); GCMS *m/z* (relative intensity) 242 (19, M<sup>+</sup>), 227 (15), 169 (2), 145 (7), 73 (100).

**Reaction of 1b with Magnesium.** A mixture of 4.8 mmol (1.6 g) of **1b**, 0.58 g of triply sublimed magnesium (24 mmol), and 60 mL of THF was stirred for 24 h at room temperature. A sample of the colorless mixture was hydrolyzed and analyzed by titration, which revealed the formation of 4.8 mmol of base and 4.8 mmol of magnesium. The reaction mixture was quenched with 2 mL of D<sub>2</sub>O and worked up as usual, yielding a colorless liquid. The product distribution was determined by GCMS, and the products were separated by preparative GLC.

2-Deuterio-1-((trimethylsilyl)methyl)benzene (**50**), 22% yield:  $^1\text{H}$  NMR (CDCl<sub>3</sub>, 200.1 MHz, reference CHCl<sub>3</sub> 7.27 ppm)  $\delta$  0.01 (s, 9H,  $^2J(\text{Si}-\text{H}) = 6$  Hz, CH<sub>3</sub>), 1.99 (s, 2H, CH<sub>2</sub>), 7.10 (m, 4H, aryl H);  $^{13}\text{C}$  NMR (CDCl<sub>3</sub>, 50.32 MHz, reference CDCl<sub>3</sub> 77.00 ppm)  $\delta$  -1.9 (C8), 27.1 (C7), 123.8 (C5), 128.0 (C3), 128.1 (C4, C6), 140.5 (C2) (the signal of C1 was not observed due to the long relaxation time of C1); GCMS *m/z* (relative intensity) 165 (21, M<sup>+</sup>), 150 (11), 73 (100).

1-(Deuteriomethyl)-2-(trimethylsilyl)benzene (**51**), 67% yield:  $^1\text{H}$  NMR (CDCl<sub>3</sub>, 200.1 MHz, reference CHCl<sub>3</sub> 7.27 ppm)  $\delta$  0.28 (s, 9H,  $^2J(\text{Si}-\text{H}) = 6$  Hz, CH<sub>3</sub>), 2.41 (bs, 2H, CH<sub>2</sub>), 7.00–7.30 (m, 3H, aryl H), 7.35–7.48 (m, 1H, aryl H);  $^{13}\text{C}$  NMR (CDCl<sub>3</sub>, 50.32 MHz, reference CDCl<sub>3</sub> 77.00 ppm)  $\delta$  -0.1 (C8), 22.7 (t,

$^1J(\text{C}-\text{D}) = 17$  Hz, C7), 124.9 (C4), 129.1 (C6), 129.7 (C5), 134.3 (C3), 138.4 (C2), 143.5 (C1); GCMS *m/z* (relative intensity) 165 (18, M<sup>+</sup>), 150 (100), 121 (23).

**2-Bromo-2'-(trimethylsilyl)biphenyl (57).** To a solution of 9.36 g (30.0 mmol) of 2,2'-dibromobiphenyl<sup>27</sup> (vide supra) in THF at -70 °C was added dropwise, under an atmosphere of argon, 19 mL of a 1.6 M solution of *n*-BuLi (30.4 mmol) in hexane. After addition, the mixture was stirred for 15 min and 3.26 g (30.0 mmol) of Me<sub>3</sub>SiCl was added dropwise. The mixture was warmed to room temperature, a saturated solution of NH<sub>4</sub>Cl in water added, and the mixture extracted with diethyl ether. The organic fractions were combined, washed (brine), dried (MgSO<sub>4</sub>), filtered, and evaporated to dryness. The residual oil was purified by fractional distillation. The product was collected at 98 °C at 4 mbar to give 6.78 g (22.2 mmol, 74% yield) of a colorless oil.

**57:**  $^1\text{H}$  NMR (CDCl<sub>3</sub>, 200.1 MHz, reference CHCl<sub>3</sub> 7.27 ppm)  $\delta$  0.03 (s, 9H, SiCH<sub>3</sub>), 7.11–7.42 (m, 6H, aryl H), 7.59–7.66 (m, 2H, aryl H);  $^{13}\text{C}$  NMR (CDCl<sub>3</sub>, 50.32 MHz, reference CDCl<sub>3</sub> 77.00 ppm)  $\delta$  0.05 (SiCH<sub>3</sub>), 124.36 (C2), 126.47 (C6'), 126.85 (C4'), 128.28 (C6), 128.92 (C4), 129.66 (C5), 131.60 (C5), 132.34 (C3), 134.54 (C3'), 139.10 (C2'), 144.32 (C1), 147.42 (C1'); GCMS *m/z* (relative intensity) 304 (M<sup>+</sup>, C<sub>15</sub>H<sub>17</sub><sup>79</sup>BrSi, 1), 289 (C<sub>14</sub>H<sub>14</sub>BrSi<sup>+</sup>, 100), 273 (C<sub>13</sub>H<sub>11</sub>BrSi<sup>+</sup>, 10), 210 (41), 195 (62), 181 (11), 165 (30), 152 (13).

**Reaction of 57 with Magnesium.** A mixture of 1.53 g (5.00 mmol) of **57**, 0.266 g (10.9 mmol) of sublimed magnesium, and 50 mL of THF was stirred for 1 day. After hydrolysis, the solvent was evaporated, the residue was extracted with diethyl ether, and the organic fractions were combined, dried (MgSO<sub>4</sub>), filtered, and evaporated to dryness. The resulting residue was crystallized from EtOH, yielding 0.96 g (4.55 mmol, 91% yield) of a white solid which was characterized by  $^1\text{H}$  NMR spectroscopy and GCMS as pure **58**.

9,9-Dimethyl-9-silafluorene (**58**): mp 52.8–53.7 °C, lit.<sup>30a</sup> mp 56–57 °C;  $^1\text{H}$  NMR (CDCl<sub>3</sub>, 200.1 MHz, reference CHCl<sub>3</sub> 7.27 ppm)  $\delta$  0.44 (s,  $^2J(\text{Si}-\text{H}) = 3.4$  Hz, 6H, SiCH<sub>3</sub>), 7.30 (td,  $^3J = 6.7$  Hz,  $^4J = 1.0$  Hz, 2H, ArH(3)), 7.46 (td,  $^3J = 7.5$  Hz,  $^4J = 1.4$  Hz, 2H, ArH(2)), 7.65 (d,  $^3J = 6.4$  Hz, 2H, ArH(1)), 7.85 (d,  $^3J = 7.7$  Hz, 2H, ArH(4));  $^{13}\text{C}$  NMR (CDCl<sub>3</sub>, 50.32 MHz, reference CDCl<sub>3</sub> 77.00 ppm)  $\delta$  -3.28 (qq,  $^1J = 121.0$  Hz,  $^3J = 2.0$  Hz,  $^1J(\text{Si}-\text{C}) = 52.3$  Hz, SiCH<sub>3</sub>), 120.78 (C6), 127.31 (C4), 130.13 (C5), 132.68 (d,  $^1J = 159.6$  Hz, C3), 138.87 (bs,  $^1J(\text{Si}-\text{C}) = 66.5$  Hz, C2), 147.75 (m, C1); GCMS *m/z* (relative intensity) 210 (M<sup>+</sup>, C<sub>14</sub>H<sub>14</sub>Si, 43), 195 (C<sub>13</sub>H<sub>11</sub>Si<sup>+</sup>, 100), 179 (4), 165 (19).

**Reaction of 1a with SmI<sub>2</sub>.** HMPA (0.4 mL) was added, under an atmosphere of nitrogen, to 10 mL of a commercially available 0.1 M solution of SmI<sub>2</sub> (1 mmol) in THF. After the mixture was stirred for 10 min, 0.100 g (0.30 mmol) of **1** was added; within 45 min the color of the mixture changed from purple to yellow. The mixture was quenched with saturated aqueous NaHCO<sub>3</sub>, and the aqueous layer was extracted with diethyl ether. The combined organic layers were washed (water), dried (MgSO<sub>4</sub>), filtered, and evaporated to dryness. The residual oil was characterized by  $^1\text{H}$  NMR spectroscopy and GCMS as pure **14**.

**Large-Scale Reaction of 1a with SmI<sub>2</sub>.** A mixture of 1.504 g (10.0 mmol) of Sm, 2.410 g (9 mmol) of freshly distilled CH<sub>2</sub>I<sub>2</sub>, and 100 mL of THF was stirred at room temperature for 2 h. The mixture turned gradually from yellow (SmI<sub>3</sub>) to blue-green. HMPA (11 mL, 64 mmol) was added, and the resulting purple solution was stirred for 10 min. To the mixture was added 1.075 g (3.22 mmol) of **1a**; the mixture turned brown within 30 min. It was quenched with saturated aqueous NaHCO<sub>3</sub>, and the aqueous layer was extracted with diethyl ether. The organic layers were combined, dried (MgSO<sub>4</sub>), filtered, and evaporated to dryness. Final purification involved filtration through a column of Florisil using pentane as eluent to remove residual HMPA. After evaporation of the

(50) Bott, R. W.; Eaborn, C.; Rushton, B. M. *J. Organomet. Chem.* **1965**, *3*, 448.

(51) Andriagan, H.; Heus-Koos, Y.; Brandsma, L. *J. Organomet. Chem.* **1987**, *336*, C41.



solvent, 0.76 g of a colorless oil was isolated, which was characterized by quantitative  $^1\text{H}$  NMR spectroscopy and GCMS.

**14**, 90% yield:  $^1\text{H}$  NMR ( $\text{CDCl}_3$ , 200.1 MHz, reference  $\text{CHCl}_3$  7.27 ppm)  $\delta$  0.05 (s,  $^2J(\text{Sn}-\text{H}) = 54, 52$  Hz, 9H,  $\text{SnCH}_3$ ), 2.32 (s,  $^2J(\text{Sn}-\text{H}) = 63, 61$  Hz, 2H,  $\text{CH}_2$ ), 6.91–7.32 (m, 5H, aryl H); GCMS  $m/z$  (relative intensity) 256 ( $\text{M}^+$ ,  $\text{C}_{10}\text{H}_{16}^{120}\text{Sn}$ , 14), 241 ( $\text{C}_9\text{H}_{13}\text{Sn}^+$ , 17), 211 (11), 165 (100), 135 (34), 120 (18), 91 (42); identical with an authentic sample of **14**.

**60**, 10% yield:  $^1\text{H}$  NMR ( $\text{CDCl}_3$ , 200.1 MHz, reference  $\text{CHCl}_3$  7.27 ppm)  $\delta$  0.30 (s,  $^2J(\text{Sn}-\text{H}) = 54, 52$  Hz, 9H,  $\text{SnCH}_3$ ), 2.40 (s,  $^4J(\text{Sn}-\text{H}) = 6$  Hz, 3H,  $\text{CH}_3$ ), 7.03–7.53 (m, 4H, aryl H); GCMS  $m/z$  (relative intensity) 256 ( $\text{M}^+$ ,  $\text{C}_{10}\text{H}_{16}^{120}\text{Sn}$ , 2), 241 ( $\text{C}_9\text{H}_{13}\text{Sn}^+$ , 100), 211 (29), 165 (2), 135 (9), 120 (10), 91 (8); identical with an authentic sample of **60**.<sup>23</sup>

#### Reaction of **1a** with $\text{SmI}_2$ in the Presence of *t*-BuOD.

With **1a** (0.963 g, 2.88 mmol) as starting material, the procedure was analogous to that described above, but before addition of **1a**, 5 g (67 mmol) of *t*-BuOD was added to the mixture. After addition of **1a**, the mixture turned brown within 3 h. After standard workup (vide supra), product distribution and yields were determined by  $^1\text{H}$  NMR spectroscopy and GCMS.

**1a** was obtained in 74% yield and **14** in 19% yield. [D]**60** (78% deuterium incorporation), 6% yield: GCMS  $m/z$  (relative intensity) 242 ( $\text{C}_9\text{H}_{13}\text{D}^{120}\text{Sn}^+$ , 100), 212 (33), 135 (75), 120 (29), 116 (11), 92 (28).

#### Reaction of **1a** with $\text{SmI}_2$ in the Presence of $\text{CH}_3\text{OD}$ .

With **1a** (0.918 g, 2.75 mmol) as starting material, the procedure was analogous to that described above, but before addition of **1a**, 1 g (30 mmol) of  $\text{CH}_3\text{OD}$  was added to the reaction mixture. After addition of **1a**, the mixture turned brown within 2 h. After standard workup (vide supra), product distribution and yields were determined by  $^1\text{H}$  NMR spectroscopy and GCMS.

**1a** was obtained in 67% yield, **14** in 24% yield, and [D]**60** (74% deuterium incorporation) in 9% yield.

#### Reaction of **1a** with $\text{SmI}_2$ in the Presence of $\text{CD}_3\text{OH}$ .

With **1a** (0.600 g, 1.8 mmol) as starting material, the procedure was analogous to that described above, but before addition of **1a**, 1 g (29 mmol) of  $\text{CD}_3\text{OH}$  was added to the reaction mixture. After addition of **1a**, the mixture turned brown within 4 h. After standard workup (vide supra), product distribution and yields were determined by  $^1\text{H}$  NMR spectroscopy and GCMS.

**1a** was obtained in 78% yield, [D]**14** (56% deuterium incorporation) in 18% yield, and **60** in 4% yield.

**Reaction of **14** with  $\text{SmI}_2$ .** A mixture of 0.938 g (6.24 mmol) of Sm, 1.602 g (5.98 mmol) of freshly distilled  $\text{CH}_2\text{I}_2$ , and 50 mL of THF was stirred at room temperature for 2 h. HMPA (5 mL, 29 mmol) was added, and the resulting purple solution was stirred for 10 min. To the mixture was added 0.512 g (2.01 mmol) of **14**; then the mixture was stirred for 2 h. The mixture was quenched, and after workup, **14** was recovered quantitatively.

**Reaction of Bromobenzene with  $\text{SmI}_2$  in the Presence of **14**.** A mixture of 0.906 g (6.02 mmol) of Sm, 1.262 g (4.71 mmol) of freshly distilled  $\text{CH}_2\text{I}_2$ , and 50 mL of THF was stirred at room temperature for 2 h. HMPA (5 mL, 29 mmol) was added, and the resulting purple solution was stirred for 10 min. To the mixture were added 0.497 g (1.95 mmol) of **14** and, after 10 min, 0.336 g (2.14 mmol) of bromobenzene. The mixture turned brown within 1 h. After standard workup (vide supra), product distribution and yields were determined by  $^1\text{H}$  NMR spectroscopy and GCMS.

**14** was obtained in 78% yield and **16** in 22% yield, identical with an authentic sample of **16**.

**Table 1. Crystal Data and Structure Refinement Details for **43****

| Crystal Data                                                            |                                       |
|-------------------------------------------------------------------------|---------------------------------------|
| formula                                                                 | $\text{C}_{14}\text{H}_{14}\text{Sn}$ |
| fw                                                                      | 300.96                                |
| cryst syst                                                              | monoclinic                            |
| space group                                                             | $P2_1/c$ (No. 14)                     |
| <i>a</i> (Å)                                                            | 17.020(2)                             |
| <i>b</i> (Å)                                                            | 8.5876(8)                             |
| <i>c</i> (Å)                                                            | 16.5142(12)                           |
| $\alpha$ (deg)                                                          | 90                                    |
| $\beta$ (deg)                                                           | 91.528(7)                             |
| $\gamma$ (deg)                                                          | 90                                    |
| <i>V</i> (Å <sup>3</sup> )                                              | 2412.9(4)                             |
| <i>Z</i>                                                                | 8                                     |
| <i>D</i> (calcd) (g/cm <sup>3</sup> )                                   | 1.657                                 |
| $\mu$ (Mo K $\alpha$ ) (mm <sup>-1</sup> )                              | 2.080                                 |
| <i>F</i> (000)                                                          | 1184                                  |
| crystal size (mm)                                                       | 0.12 $\times$ 0.12 $\times$ 0.63      |
| Data Collection                                                         |                                       |
| temp (K)                                                                | 150                                   |
| radiation (Å)                                                           | Mo K $\alpha$ , 0.710 73              |
| min, max $\theta$ (deg)                                                 | 1.2, 27.5                             |
| data set                                                                | –22 to +14; –11 to 0; –21 to +21      |
| total, unique no. of data; <i>R</i> (int)                               | 6805, 5541; 0.038                     |
| no. of obsd data ( <i>I</i> > 2.0 $\sigma$ ( <i>I</i> ))                | 4077                                  |
| Refinement                                                              |                                       |
| <i>N</i> <sub>ref</sub> , <i>N</i> <sub>par</sub>                       | 5502, 275                             |
| <i>R</i> <sub>1</sub> , w <i>R</i> <sub>2</sub> , <sup>a</sup> <i>S</i> | 0.0591, 0.1642, 1.13                  |
| max, av shift/error                                                     | 0.00, 0.00                            |
| min, max resd dens (e/Å <sup>3</sup> )                                  | –0.90, 1.09                           |

$$^a w^{-1} = \sigma^2(F_o^2) + (0.0349P)^2 + 29.13P.$$

**Crystal Structure Determination of **43**.** Crystals of the title compound are colorless. The crystal used for data collection was cut from a larger specimen and transferred in the cold dinitrogen stream of a Nonius CAD4T diffractometer on a rotating anode. The structure was solved by Patterson techniques (DIRDIF<sup>52</sup>) and refined on *F*<sup>2</sup> with SHELXL93.<sup>53</sup> Absorption correction was done with the PLATON/DELABS procedure.<sup>54</sup> Numerical details have been collected in Table 1. Crystallographic data (excluding structure factors) have been deposited with the Cambridge Data Centre as Supplementary Publication No. CCDC 114259. Copies of the data can be obtained free of charge on application to the CCDC, 12 Union Road, Cambridge CB21EZ, U.K. (fax, (+44) 1223-336-033; e-mail, deposit@ccdc.cam.ac.uk).

**Acknowledgment.** Dr. B. L. M. van Baar is gratefully acknowledged for performing the HRMS measurements and Dr. F. J. J. de Kanter for the NMR experiments.

**Supporting Information Available:** Details of the X-ray crystal structure analysis of compound **43**. This material is available free of charge via the Internet at <http://pubs.acs.org>.

OM011083A

(52) Beurskens, P. T.; Admiraal, G.; Beurskens, G.; Bosman, W. P.; Garcia-Grande, S.; Gould, R. O.; Smits, J. M. M.; Smykalla, C. The DIRDIF Program System; Technical Report of the Crystallography Laboratory; University of Nijmegen, Nijmegen, The Netherlands, 1992.

(53) Sheldrick, G. M. SHELXL93: Program for Crystal Structure Refinement; University of Göttingen, Göttingen, Germany, 1993.

(54) Spek, A. L. PLATON: A Multipurpose Crystallographic Tool; Utrecht University, Utrecht, The Netherlands, 2001.