

Contents

REPORT

Non-conventional methodologies for transition-metal catalysed carbon-carbon coupling: a critical overview. Part 1: The Heck reaction pp 11771–11835

Francisco Alonso,* Irina P. Beletskaya* and Miguel Yus*

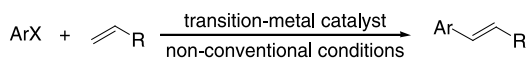

non-conventional conditions: ligandless, solid support, supercritical fluids, ionic liquids, aqueous solvents, microwave, ultrasound, high pressure, micelles, electrochemical activation, nanofiltration, microreactors, etc.

ARTICLES

Aza Diels-Alder reactions utilizing 4-iodo-2-trimethylsilyloxy-butadiene

pp 11837–11842

Cody Timmons, Adishesu Kattuboina, Lauren McPherson, James Mills and Guigen Li*

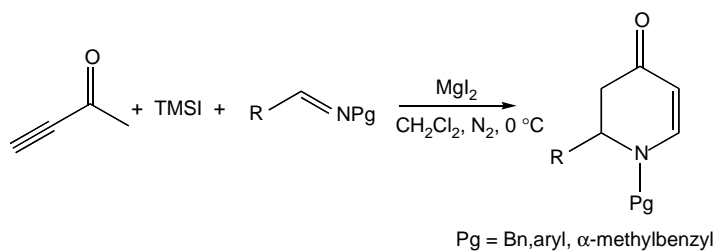

New bioactive cyclic peroxides from the Caribbean marine sponge *Plakortis zygompha*

pp 11843–11849

Fabrice Berru , Olivier P. Thomas, Corinne Funel-Le Bon, Fernando Reyes and Philippe Amade*

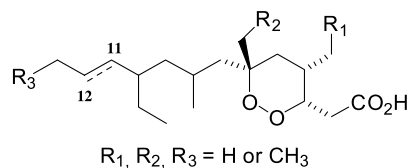

Seven new cyclic aliphatic peroxides have been isolated from the little studied marine sponge *Plakortis zygompha*. The structural elucidations were based on NMR and MS studies. The new plakortides showed cytotoxicity against human tumor cell lines.

Synthetic studies on nucleoside-type muraymycins antibiotics based on the use of sulfur ylides.

pp 11850–11865

Synthesis of bioactive 5'-epimuraymycin analogues

Francisco Sarabia* and Laura Martín-Ortiz

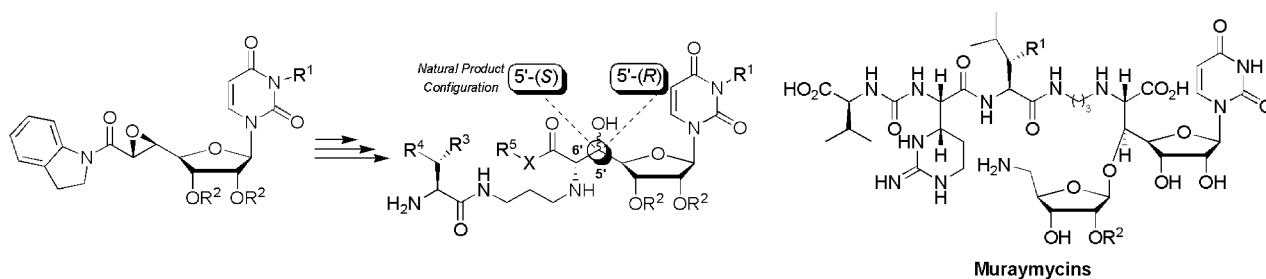
**Reaction of (2-amino-5,10,15,20-tetraphenylporphyrinato)nickel(II) with quinones**

pp 11866–11872

Cristina M. A. Alonso, Maria G. P. M. S. Neves, Augusto C. Tomé, Artur M. S. Silva and José A. S. Cavaleiro*

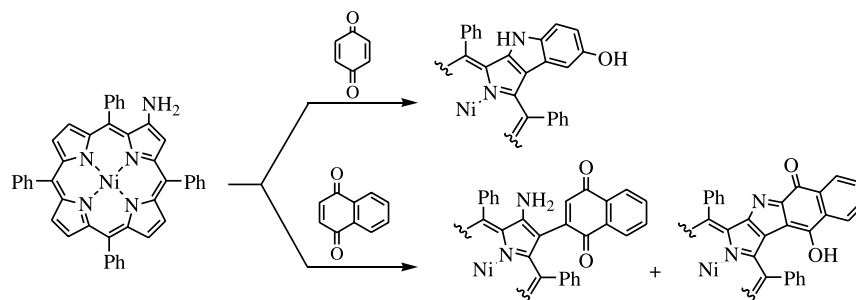
**Synthesis and solvent dependence of the photophysical properties of [60]fullerene–sugar conjugates**

pp 11873–11881

Roger F. Enes, Augusto C. Tomé,* José A. S. Cavaleiro, Ali El-Agamey and David J. McGarvey*

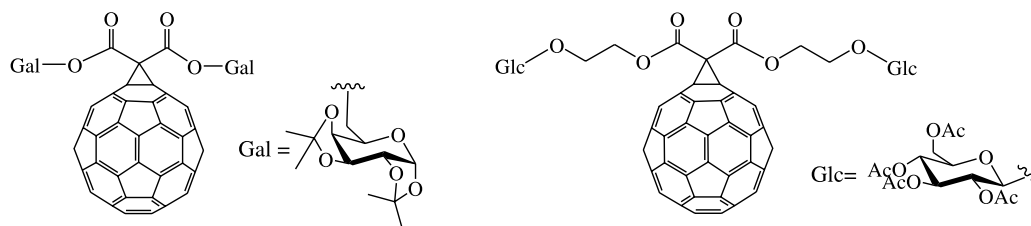
**Efficient construction of novel α -keto spiro ketal and the total synthesis of (\pm)-terreinol**

pp 11882–11886

Wan-Guo Wei, Yong-Xia Zhang and Zhu-Jun Yao*

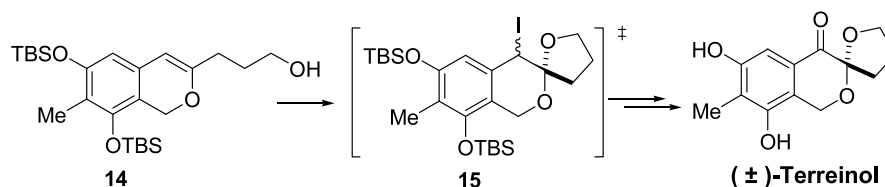

Organocatalysts of tertiary-phosphines and amines catalyzed reactions of α -keto esters with cyclopent-2-enone

pp 11887–11894

Min Shi* and Wen Zhang

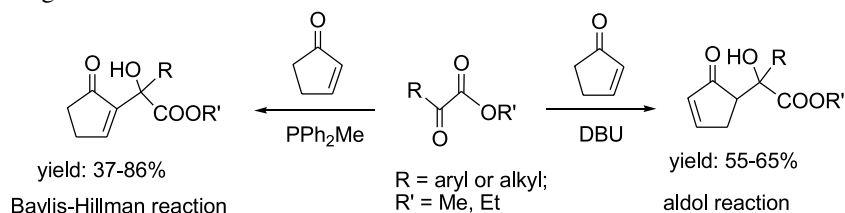

The reaction of α -keto esters with cyclopent-2-enone catalyzed by tertiary-phosphine organocatalyst of diphenylmethylphosphine provides the corresponding Baylis–Hillman adducts in higher yields. While the similar reaction of α -keto esters with cyclopent-2-enone furnishes the corresponding aldol adducts in the presence of tertiary-amine organocatalyst of DBU.

Novel DNA bis-intercalators of isoquinolino[4,5-*bc*]acridines: design, synthesis and evaluation of cytotoxic activity

pp 11895–11901

Peng Yang, Qing Yang and Xuhong Qian*

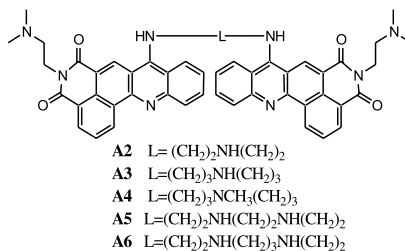
**Enantiopure arenesulfenic acids as intermediates in stereoselective synthesis**

pp 11902–11909

Maria C. Aversa, Paola Bonaccorsi,* Cristina Faggi, Giuseppe Lamanna and Stefano Menichetti*

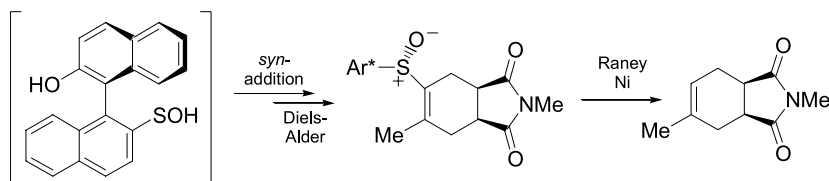
**Palladium mediated spiroketal synthesis: application to pheromone synthesis**

pp 11910–11923

Jeremy C. Conway, Peter Quayle,* Andrew C. Regan and Christopher J. Urch

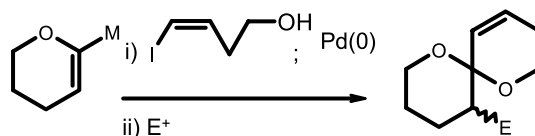

The application of Stork–Stille sequences to the synthesis of spiroketals is described.

Apteniols A–F, oxynolignans from the leaves of *Aptenia cordifolia*

pp 11924–11929

Marina DellaGreca,* Cinzia Di Marino, Lucio Previtiera, Raffaella Purcaro and Armando Zarrelli

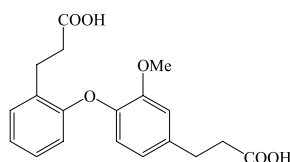

Six new oxynolignans have been isolated from the plant *Aptenia cordifolia*. Structure determination by NMR spectroscopy is described. Their effects on germination and growth of *Lactuca sativa* L. have been studied in the range concentration 10^{-4} – 10^{-7} M.

Enantiomerically pure 4-amino-1,2,3-trihydroxybutylphosphonic acids

pp 11930–11938

Andrzej E. Wróblewski* and Iwona E. Głowacka

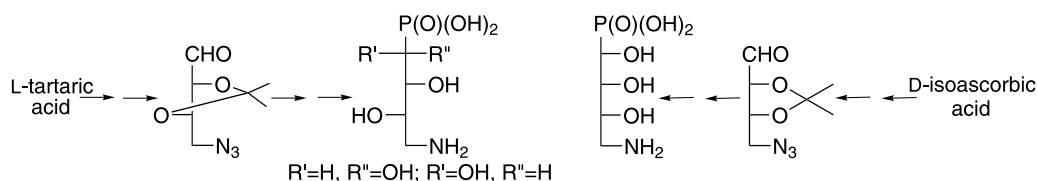
**The synthesis of a single enantiomer of a major α -mycolic acid of *M. tuberculosis***

pp 11939–11951

Juma'a R. Al Dulayymi, Mark S. Baird* and Evan Roberts

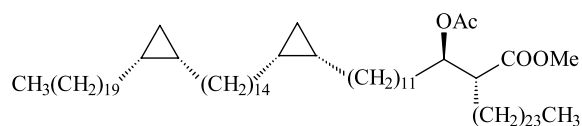

The first synthesis of an in-tact α -mycolic acid is reported.

Oxidative nucleophilic substitution of hydrogen in nitroarenes with phenylacetic acid derivatives

pp 11952–11964

Mieczysław Mąkosza,* Krystyna Kamińska-Trela, Maciej Paszewski and Małgorzata Bechcicka

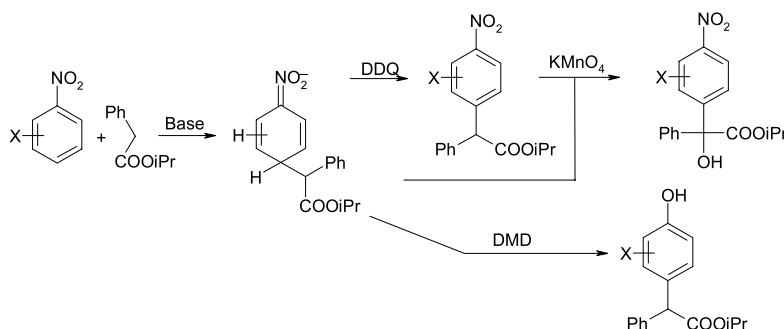

New acyclic receptors containing pyridazine units. The influence of π -stacking on the selective transport of lipophilic phenethylamines pp 11965–11975

Lucrecia Campayo, Fabián Calzado, M. Carmen Cano, María J. R. Yunta, Mercedes Pardo,* Pilar Navarro, M. Luisa Jimeno, Fernando Gómez-Contreras and Ana M. Sanz

Four new series of acyclic heteroaromatic receptors are described, and their ability for the selective transport of phenethylamine and homoveratrylamine is evaluated. The relative influence of π -stacking and hydrogen bonding on complexation is discussed with the help of molecular modelling.

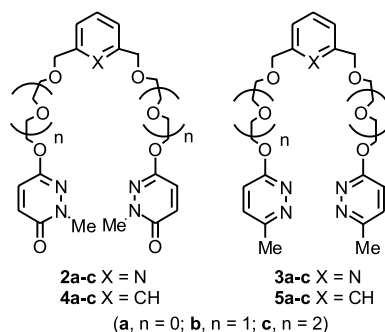

Synthesis of novel C4-linked imidazole ribonucleoside phosphoramidites pp 11976–11985

Lisa Araki, Shinya Harusawa,* Maho Yamaguchi, Sumi Yonezawa, Natsumi Taniguchi, David M. J. Lilley, Zheng-yun Zhao and Takushi Kurihara

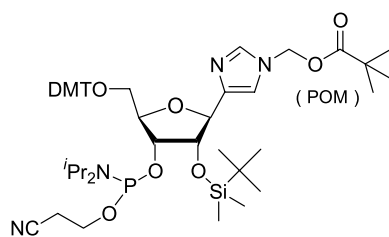

New enantioselective method for hydration of alkenes using cyclodextrins as phase transfer catalyst pp 11986–11990

Artur R. Abreu, Iva Costa, Carla Rosa, Luísa M. Ferreira, Ana Lourenço and Pedro P. Santos*

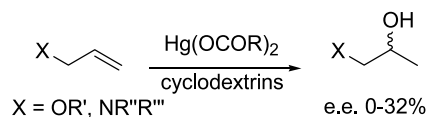

Synthesis of tricyanovinyl-substituted thienylpyrroles and characterization of the solvatochromic, electrochemical and non-linear optical properties pp 11991–11998

M. Manuela M. Raposo,* Ana M. R. C. Sousa, G. Kirsch, F. Ferreira, M. Belsley, E. de Matos Gomes and A. Maurício C. Fonseca



Comparative reactivity of *N'*-(5-benzoyl/ethoxycarbonyl)thiazol-2-yl-*N,N*-dimethylformamidines with ketenes pp 11999–12005

Parvesh Singh, Alka Marwaha, Harmeet Singh and Mohinder P. Mahajan*

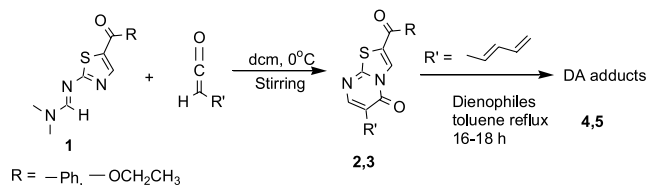

Amine side arm effect on the ion selectivity of 12-crown-O₃N derivatives with an amine arm pp 12006–12011

Katsuhiko Okano, Hiroshi Tsukube and Kenzi Hori*

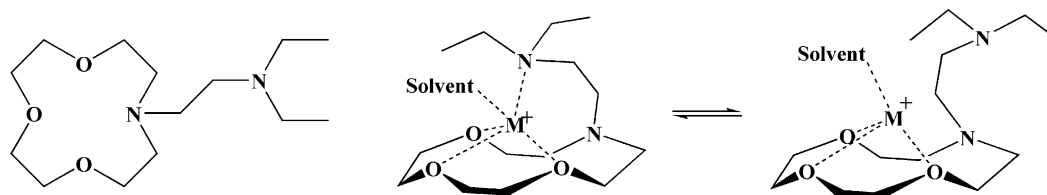

OTHER CONTENTS

Tetrahedron reports on organic chemistry
Contributors to this issue
Instructions to contributors

pp I–XXVIII
p XXIX
pp XXXI–XXXIV

*Corresponding author

Supplementary data available via ScienceDirect

Indexed/Abstracted in: AGRICOLA, Beilstein, BIOSIS Previews, CAB Abstracts, Chemical Abstracts, Chemical Engineering and Biotechnology Abstracts, Current Biotechnology Abstracts, Current Contents: Life Sciences, Current Contents: Physical, Chemical and Earth Sciences, Current Contents Search, Derwent Drug File, Ei Compendex, EMBASE/Excerpta Medica, Medline, PASCAL, Research Alert, Science Citation Index, SciSearch



Tetrahedron report number 743

Non-conventional methodologies for transition-metal catalysed carbon–carbon coupling: a critical overview.

Part 1: The Heck reaction

Francisco Alonso,^{a,*} Irina P. Beletskaya^{b,*} and Miguel Yus^{a,*}

^a*Departamento de Química Orgánica, Facultad de Ciencias and Instituto de Síntesis Orgánica (ISO), Universidad de Alicante, Apdo. 99, E-03080 Alicante, Spain*

^b*Department of Chemistry, Lomonosov Moscow State University, Vorob'evy Gory, 119992 Moscow, Russia*

Received 10 August 2005

Available online 29 September 2005

Contents

1. General introduction	11772
1.1. Substrates	11773
1.2. Catalytic systems	11773
1.3. Solvents	11774
1.3.1. Supercritical fluids (SCFs)	11774
1.3.2. Ionic liquids (ILs)	11774
1.3.3. Fluorous media	11775
1.3.4. Aqueous solvents	11775
1.4. Reaction conditions	11775
1.4.1. Physical activation	11776
1.4.1.1. Microwave	11776
1.4.1.2. Ultrasound	11776
1.4.1.3. High pressure	11776
1.4.2. Physicochemical activation	11776

Keywords: Heck reaction; Supercritical fluids; Ionic liquids; Fluorous media; Aqueous solvents; Microwave; Ultrasound; High pressure; Nanofiltration; Microreactors; Ball-milling conditions.

Abbreviations: A, ampere; AAEMA, deprotonated form of 2-(acetoacetoxy)ethyl methacrylate; acac, acetylacetonate; Ad, adamantyl; A336, tricaprylmethylammonium chloride; atm, atmosphere; bbim, 1,3-di-*n*-butylimidazolium; *b*, block copolymer; bmim, 1-butyl-3-methylimidazolium; BINAP, 2,2'-bis(diphenylphosphino)-1,1'-binaphthyl; Boc, *tert*-butoxycarbonyl; BTF, benzotrifluoride (α,α,α -trifluorotoluene); Cbz, benzyloxycarbonyl; *co*, copolymer; COD, 1,5-cyclooctadiene; Cy, cyclohexyl; DAB, 1,4-diaminobutane; dba, dibenzylideneacetone; DBU, 1,8-diazabicyclo[5.4.0]undec-7-ene; DEA, *N,N*-diethylacetamide; DEC, dendrimer-encapsulated catalyst; dendr, dendrimer; DIPEA, diisopropylethylamine; DMA, *N,N*-dimethylacetamide; DMF, dimethylformamide; DMG, *N,N*-dimethylglycine; dppp, 1,3-diphenylphosphinopropane; EDG, electron-donating group; EWG, electron-withdrawing group; Fc, ferrocenyl; F-dppp, fluorine-tagged 1,3-bis(diphenylphosphino)propane; HDAPS, *N*-hexadecyl-*N,N*-dimethyl-3-ammonio-2-propanesulfonate; Hex, hexyl; IL, ionic liquid; LDH, layered double hydroxide; M, metal; MCM-41, hexagonally packed mesoporous molecular sieves; MW, microwave; Nf, nonaflate (nonafluoro-*n*-butane-1-sulfonyl); NMP, *N*-methylpyrrolidinone; P_c , critical pressure; PAMAM, poly(amidoamine); PEG, poly(ethylene glycol); pmim, 1-*n*-pentyl-3-methylimidazolium; PNIPAM, poly(*N*-isopropylacrylamide); PNP, *p*-nitrophenyl; PS, polystyrene; Py, pyridyl; RCM, ring-closing metathesis; ROMP, ring-opening metathesis polymerisation; rt, room temperature; SAPO, silico aluminophosphate; sc, supercritical; SCF, supercritical fluid; SCM, shell cross-linked micelles; SDS, sodium dodecyl sulfate; TBAA, tetra-*n*-butyl ammonium acetate; TBAB, tetra-*n*-butyl ammonium bromide; TBAC, tetra-*n*-butyl ammonium chloride; TBAF, tetra-*n*-butyl ammonium fluoride; TEAC, tetraethylammonium chloride; Tf, trifluoromethanesulfonyl; TPPDS, bis(*p*-sulfonatophenyl)phenylphosphane dipotassium salt; Na-TPPMS, mono(*m*-sulfonatophenyl)diphenylphosphane monosodium salt; *m*-TPPTC, tris(*m*-carboxyphenyl)phosphane trilithium salt; TPPTS, tris(*m*-sulfonatophenyl)phosphane trisodium salt; TXPTS, tris(4,6-dimethyl-3-sulfonatophenyl)phosphane trisodium salt; T_c , critical temperature; THF, tetrahydrofuran; THP, tetrahydropyranyl; TFA, trifluoroacetic acid; Tol, tolyl; TOF, turnover frequency (mol of product per mol of catalyst h^{-1}); TON, turnover number (mol of product per mol of catalyst); Ts, *p*-toluenesulfonyl; ttmp, tris-(2,4,5-trimethoxyphenyl)phosphane; wt, weight; XAFS, X-ray absorption fine structure.

* Corresponding authors. Tel./fax: +34 965903549; (F.A.; M.Y.); fax: +7 95 9381844; (I.P.B.);

e-mail addresses: falonso@ua.es; beletska@org.chem.msu.ru; yus@ua.es

1.4.2.1. Micellar solutions	11776
1.4.2.2. Microemulsions	11777
1.4.3. Electrochemical activation	11777
1.5. Miscellaneous non-conventional techniques	11777
1.5.1. Nanofiltration	11777
1.5.2. Microreactors	11777
1.5.3. Ball-milling conditions	11778
2. Objectives and organisation	11778
3. Introduction to the Heck reaction	11778
4. Substrates	11778
4.1. Alternative arylating agents	11778
4.2. Supported substrates	11782
5. Catalytic systems	11785
5.1. Ligands: ligand-free catalytic systems	11785
5.2. Catalysts: supported catalysts	11787
5.2.1. Carbon	11787
5.2.2. Metal oxides and other inorganic materials	11788
5.2.3. Clays, zeolites and molecular sieves	11795
5.2.4. Polymers	11798
5.2.5. Dendrimeric systems	11803
6. Solvents	11806
6.1. Supercritical fluids	11806
6.2. Ionic liquids	11808
6.3. Fluorous media	11814
6.4. Aqueous solvents	11817
7. Reaction conditions	11820
7.1. Physical activation	11820
7.1.1. Microwave	11820
7.1.2. Ultrasound	11822
7.1.3. High pressure	11822
7.2. Physicochemical activation	11823
7.2.1. Micellar solutions	11823
7.2.2. Electrochemical activation	11824
8. Miscellaneous non-conventional techniques	11824
8.1. Nanofiltration	11824
8.2. Microreactors	11825
8.3. Ball-milling conditions	11826
9. General conclusions	11826
References and notes	11826
Biographical sketches	11835

1. General introduction

The formation of carbon–carbon bonds is a fundamental reaction in organic synthesis the efficiency of which has interested organic chemists for a long time ago. Aryl–aryl bond formation has been known for more than a century and was one of the first reactions involving a transition metal.¹ Modern synthetic chemistry is also sustained by the use of transition-metal catalysts as powerful tools for carbon–carbon bond-forming processes.² Among these, carbon–carbon coupling reactions through the activation of carbon–hydrogen bonds,³ as well as addition reactions,⁴ have experienced an increasing interest in the preparation of molecules, the access to which is not so straightforward using other methodologies. On the other hand, the transition-metal catalysed carbon–carbon bond formation developed in the 1970s represented a milestone in synthetic organic chemistry that allowed the cross coupling of substrates in ways that would have previously been thought impossible.⁵ This protocol has been substantially improved

and expanded over the past 30 years, providing an indispensable and simple methodology for preparative organic chemists (Scheme 1).

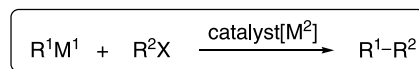

M¹ = Li (Murahashi)
 Mg (Kumada-Tamao, Corriu)
 B (Suzuki-Miyaura)
 Al (Nozaki-Oshima, Negishi)
 Si (Tamao-Kumada, Hiyama-Hatanaka)
 Zn (Negishi)
 Cu (Normant)
 Zr (Negishi)
 Sn (Migita-Kosugi, Stille).....
 M² = Fe, Ni, Cu, Pd, Rh,.....
 X = I, Br, Cl, OSO₂R,.....

Scheme 1.

In spite of the fact that it would seem that most of the research on developing carbon–carbon coupling strategies has been done, some new challenges on this topic have emerged in the narrow boundary between the 20th and 21st century. A new mentality of the organic chemist is focussed on the design of new tendencies and methodologies able to make the already known chemical transformations simpler, faster, cheaper, greener and in general, more efficient processes. In particular, increasing attention has been paid to the ‘green chemistry’ of these processes, this concept being understood as the set of principles⁶ that reduce or eliminate the use or generation of hazardous substances.⁷ The idea of atom-economical reactions may be also a useful concept in helping to promote thinking in the direction of sustainable chemistry.⁸ In order to achieve all the goals mentioned above, several valuable and distinctive techniques,⁹ which do not find daily use in the laboratory, can be applied by the organic chemist to operate at different levels including (a) the type of substrates, (b) the catalyst, (c) the solvent, (d) the reaction conditions, (e) the separation techniques and (d) the reaction vessel. An introductory commentary to remark the importance of any of these parameters follows.

1.1. Substrates

The majority of studies of metal-catalysed cross-coupling reactions involve a halide or sulfonate as the electrophile and an organometallic reagent as the nucleophile in which the carbon atoms to be coupled are all sp^2 -hybridized. There is, however, a substantial need for the development of successful cross-coupling reactions involving either alkyl halides or sulfonates. Organic halides also take part in Heck-type reactions. On the other hand, all these processes have in common some lack of atom economy,⁸ since the corresponding inorganic salts are obtained and require proper isolation and treatment.

In the past decade, there have been developments in palladium-catalysed coupling systems for Heck, Suzuki, Stille and Sonogashira reactions among others, as a consequence of the great interest in the development of coupling partners that are both more economical and readily accessible. In spite of the fact that organoboranes and organostannanes have been the reagents of choice for some of these reactions, there are still some drawbacks in their use: certain organostannanes such as the trimethyltins, Me_3SnX and their by-products are toxic, whereas organoboranes have a lack of stability, particularly alkyl- and alkenylboranes.

Consequently, the search for novel substrates for the cross-coupling reactions has been the focus of much attention, for example, carboxylic acids, anhydrides and esters, as well as sulfonium salts, thiol esters and thioethers, have emerged as interesting alternatives to aryl halides.¹⁰ In particular, carboxylic acids do not generate large amounts of waste and they work in the absence of phosphane ligands. There is, however, no general advantage in terms of atom economy and their generation is not always readily accessible, producing stoichiometric amounts of salts as by-products. The Stille, Suzuki and Kumada reactions with alkyl and aryl fluorides is a recent and promising research area leading to

the cross-coupled products under generally mild reaction conditions.¹¹ The stability of vinylic tellurides has also been used in palladium-catalysed cross-coupling reactions for the preparation of stereochemically defined enynes and enediynes. The fact that these reagents work in the presence of sensitive functional groups and under mild reaction conditions makes them interesting substitutes for vinylic halides and triflates.¹²

On the other hand, potassium trifluoro(organo)borates are promising alternatives to the use of the known organoboronic acids, exhibiting higher reactivity and exceptional stability.¹³ Germanium reagents have been recently used in cross-coupling reactions,¹⁴ exhibiting intermediate reactivity between that of organotin¹⁵ and organosilicon compounds,¹⁶ avoiding the toxicity of certain organotin reagents and being more reactive than silicon.

In recent years, an increasing interest has been shown in the possibility of anchoring the substrates to a solid support, facilitating their use in automated parallel synthesis in a combinatorial manner. The main advantages of these solid-phase transformations are the avoidance of tedious workup procedures, the quasi high-dilution effect (high yields by employing an excess of reagent), amenability to automatization and the non-interference of various functionalities in the building blocks on a solid support.¹⁷

1.2. Catalytic systems

The form in which the catalyst is present in the reaction media is fundamental to drive the reaction in an effective manner. A wide range of possibilities can be explored, depending on the different combinations of the components of the catalytic system, for example, the catalyst can be present as nanoparticles, ligandless, unsupported, supported, etc.

Transition-metal nanoparticles have attracted a great deal of attention during the last 10 years as catalytic systems with great potential, due to the large surface area of the particles. It has been suggested that metal colloids are very efficient catalysts because of the ratio of atoms remaining at the surface. In fact, these catalysts are microheterogeneous systems bearing nanoparticles. The application of transition-metal nanoparticles to the formation of carbon–carbon bonds is still, however, in its infancy.¹⁸

Recent interest in the development of environmentally benign syntheses and in minimising the cost of the precious metal catalysts has led to the development of polymer-bound metal catalysts for the carbon–carbon coupling reaction that maintain high activity and selectivity. The supported complexes can be recovered from the reaction mixtures, they do not contaminate the product solution and they can be recycled and used for the rapid production of compound libraries. Often, however, there is metal leaching during the course of the reaction and they are often not recyclable. As a result, many efforts have been focussed on the development of new ligand-derivatised polymeric supports for the attachment of metals and on the design of new methods to increase both the activity and the selectivity.¹⁹ In particular, dendrimers as soluble supports

have recently attracted much attention in homogeneous catalysis, since these well-defined macromolecular structures enable the construction of precisely controlled catalyst structures. Moreover, the globular shapes of the higher generations of dendrimers are particularly suited for membrane filtration.²⁰

Alternatively, the immobilisation of catalysts can be effected on inorganic matrices, having several important potential advantages such as: (a) the remarkable ease of handling and use, (b) reduced product contamination by having the catalyst fully bound to the solid support, (c) relatively safe handling owing to full chemisorption of the possible toxic chemicals, (d) reduced environmental impact upon work-up, (e) good thermal and chemical stabilities, (f) good dispersion of the active catalytic sites, with a significant improvement in the reactivity and (g) improvement in the reaction selectivity, due to the constraints of the pores and the characteristics of surface adsorption.²¹ In general, they offer superior chemical, mechanical and thermal stability compared with the use of organic polymeric supports.

1.3. Solvents

Since most of the chemical reactions are performed in the solution phase, the solvent plays a crucial role to implement any transformation, either on a laboratory or industrial scale.²² For a given process, the solvent will always condition the work-up, recycling and disposal techniques employed for the appropriate treatment of the reaction mixture and every one of its components. Within the context of green and sustainable chemistry, the endeavour to replace volatile organic solvents in organometallic catalysis for alternative more practical and environmentally friendly solvents must be highlighted.²³ Interesting approaches include catalysis based on aqueous systems, ionic liquids, supercritical media, or fluorinated phases.

Nonetheless, it is known that many reactions proceed efficiently in the solid state. In fact, in some cases, solid-state organic reactions occur more efficiently and selectively than their solution counterparts, since molecules in a crystal are arranged tightly and regularly. In addition, the solvent-free reactions make syntheses simpler for process and handling, saving energy and preventing solvent waste, hazards and toxicity.²⁴

1.3.1. Supercritical fluids (SCFs). Supercritical fluids are well established as useful solvents for extraction, chromatography and a few specialised reactions.²⁵ In spite of the fact that they have been used for large-scale industrial production for most of the 20th century, only during the last decade have their special properties made them attractive solvents for modern synthetic chemistry.^{25d,26} The properties of SCFs are different from those of ordinary liquids and gases and are tunable simply by changing the pressure and temperature. They form a single-phase mixture with gaseous reactants, sometimes avoiding a rate-limiting mass-transfer step and therefore, enhance the reaction rates.

scCO₂ is readily accessible, with a T_c of 31 °C and a P_c of 73 atm and is abundant, inexpensive, non-flammable, non-

toxic and environmentally benign. Non-polar organic solvents have a high solubility in scCO₂ and the solubility of polar, ionic, or polymeric compounds can be increased by the addition of a polar additive or an appropriate surfactant. In addition, scCO₂ facilitates the separation of reactants, catalysts and products, being a substitute for environmentally less acceptable solvents.²⁷

Water near its critical point (T_c 374 °C and P_c 218 atm) also offers environmental advantages and possesses properties very different from those of ambient liquid water. The dielectric constant is much lower and the formation of hydrogen bonds is less favoured. As a result, high temperature water behaves like many organic solvents in allowing a high solubility of organic compounds in near-critical water and complete miscibility in supercritical water.²⁸

1.3.2. Ionic liquids (ILs). Ionic liquids can be generally defined as liquid electrolytes composed entirely of ions. By applying the melting point criterion, they can be considered as salts with a melting point below the boiling point of water. They are, however, better described as liquid compounds that display ionic-covalent structures. Most ILs have an organic cation and an inorganic polyatomic anion. The most commonly used cations in room temperature ionic liquids are alkylammonium, alkylphosphonium,²⁹ *N,N'*-dialkylimidazolium and *N*-alkylpyridinium cations and the most commonly utilised alkyl chains are methyl, ethyl, butyl, hexyl, octyl and decyl. Although the pyridinium- and imidazolium-based chloroaluminate ionic liquids share the disadvantage of being reactive with water, the more recent tetrafluoroborate, hexafluorophosphate, nitrate, sulfate and acetate salts are stable towards hydrolysis. Their physical and chemical properties can be finely tuned for a range of applications by varying the cations or anions.³⁰

This fascinating group of chemicals exhibits a great potential to improve development in organic chemistry, due to their particular properties: a very wide liquid range, relatively wide electrochemically stable window, good electrical conductivity, high ionic mobility with strong ion–ion interactions, negligible vapour pressure, non-flammability, excellent chemical and thermal stability and ability to act as catalysts. Reactions in ILs have different thermodynamic and kinetic behaviour, which often lead to improved process performance. Moreover, ILs allow an enhanced stability of organometallic reagents and biocatalysts and an easy recovery, as well as possible recycling of homogeneous catalysts.

The potential for recyclability, ability to dissolve a variety of materials and the non-volatile nature of the ILs are some of their unique attributes responsible for their popularity. Although originally studied in electrochemistry, ILs are currently being explored as environmentally benign solvent substitutes in a variety of applications such as chemical synthesis, liquid–liquid separations, extractions, dissolution processes, catalysis, biocatalysis and polymerisation.³¹ More recently, they have also found application in asymmetric synthesis,³² as well as in the synthesis of nanoparticles and other inorganic nanostructures.³³

It has recently been shown that there is a possibility of performing chemical reactions in ILs in conjunction with microwave irradiation,³⁴ as well as with separation routes utilising binary ionic liquid–scCO₂ systems.³⁵

In spite of the fact that ILs are generally considered as environmentally friendly substitutes for volatile organic solvents, the environmental fate and any potential toxicity issues for most ionic liquids are not known, particularly with respect to alkylimidazolium systems.³⁶ In fact, so far, only a few toxicological and ecotoxicological data are available for this group of chemicals. More information seems to be needed in order to assess ILs with regard to sustainability and the principles of green chemistry.³⁷ On the other hand, although ILs are easy to obtain, their conventional preparation involves an excess of solvents and alkyl halides and, therefore, new efforts have emerged in a direction to minimize, at least, the amount of solvents in the reaction medium.³⁸

1.3.3. Fluorous media. Fluorous chemistry can be considered as a complementary type of liquid-phase synthetic and separation methodology involving the use of fluorine-containing reagents and solvents.³⁹ Fluorous solvents offer a unique perspective on a chemical reaction that allows one or more stages to be carried out without the need for volatile or noxious organic solvents, making the process simpler and more energy efficient and reducing the separation steps. Perfluoroalkanes, perfluorodialkyl ethers and perfluorotrialkylamines are the most common fluorous solvents used, which are practically non-toxic. These solvents can be used in conjunction with a fluorous reaction component (reagent, catalyst, pre-catalyst, ligand, product, scavenger, protecting group, etc.), to which a fluorous tag has been deliberately attached in order to make it soluble in fluorous solvents. It must be taken into account that the attachment of fluorous ponytails can significantly change the reactivity of the fluorous reaction component, the insertion of two or three methylene groups before the fluorous ponytail being necessary, in many cases, to decrease their strong electron-withdrawing effects.

The foundation of this methodology resides in the fact that the fluorous solvent has a low miscibility with common organic solvents. At a certain increased temperature, it is miscible with organic solvents but, when cooled, it splits into a biphasic system. A fluorous biphasic system can therefore, consist of a fluorous phase containing a fluorous-soluble reaction component and a second product phase, which may be any organic or non-organic solvent with limited solubility in the fluorous phase.⁴⁰ The fluorous biphasic reaction at the operating temperature can proceed either in the fluorous phase or at the interface of the two phases, depending on the solubilities of the reactants in the fluorous phase. When the reaction is complete, simply cooling the system makes the fluorous solvent immiscible in the organic phase. The fluorous biphasic system therefore, combines the advantages of a one-phase reaction with biphasic product separation.

The fluorous biphasic concept has been successfully applied in stoichiometric chemical reactions utilising organic, inorganic, or organometallic fluorous-soluble reagents. Because of the nature of the fluorous media, the application

of fluorous reagents is limited to apolar substrates, since the reactions of polar substrates may be too slow for practical applications. This concept has also found application in catalysis (where only transition-metal complexes have been converted into fluorous soluble entities through ligand modification), in multistep organic synthesis and in combinatorial chemistry.⁴¹

The fluorous phase, together with ionic liquid approaches and supercritical fluid systems, offers a whole new repertoire of solvents that overcome many of the problems of volatile organics.

1.3.4. Aqueous solvents. In the most recent decades, the use of water as a reaction solvent or co-solvent has received much attention in synthetic organic chemistry, with sometimes surprising and unforeseen results.⁴² Despite the different advantages that the previous mentioned solvents can offer, water can still be considered as a unique solvent. Moreover, water is the ‘solvent of Nature’ and, therefore, its use in common chemistry can be regarded as biomimetic and biocompatible. There are many potential reasons to replace the classical organic solvents by water, such as cost, safety and environmental concern. In fact, aqueous procedures are often referred to as green, environmentally friendly, or benign. In addition, the unique solvation properties of water have been shown to have beneficial effects on many types of organic reactions in terms of both the rate and selectivity. Furthermore, experimental procedures may be simplified, since isolation of organic products and recycling of water-soluble catalysts and other reagents can be achieved by simple phase separation.

The main obstacle to the use of water as reaction solvent is the negligible solubility of the majority of organic compounds in water. This problem can be addressed by using aqueous organic solvents or phase-transfer agents. As will be shown in this review, aqueous-phase transition-metal catalysis, including asymmetric catalysis, has emerged as an important tool in the formation of carbon–carbon bonds.⁴³

1.4. Reaction conditions

While some reactions occur spontaneously, most of them require activation. For carbon–carbon coupling reactions, chemical activation modes (i.e., catalysis) are indispensable in order to make processes effective and selective. The association of several activation modes, however, emerges as a powerful synthetic strategy when the respective kinetic effects are convergent. Besides the classical thermal activation mode, new methods have emerged in the recent years, such as physical or physicochemical activation techniques, among others. Thus, microwaves and ultrasonic and high-pressure techniques have been added to the chemist’s repertoire as physical methods for accelerating chemical reactions. On the other hand, physicochemical activation results from interactions between the medium and the reactive molecules and can arise from the solvent or from added complexing molecules. Physicochemical activation can be applied through the action of solvophobic effects (microemulsions and vesicles), host–guest chemistry, etc.

1.4.1. Physical activation.

1.4.1.1. Microwave. Microwaves are a form of electromagnetic radiation. When molecules with a permanent dipole are placed in an electric field, they become aligned with that field. If the electric field oscillates, then the orientations of the molecules will also change in response to each oscillation. Most microwave ovens operate at 2.45 GHz, wavelength at which oscillations occur 4.9×10^9 times per second. Molecules subjected to this microwave radiation are extremely agitated as they align and realign themselves with the oscillating field, creating an intense internal heat that can escalate as quickly as 10°C per second. Non-polar molecules such as toluene, carbon tetrachloride, diethyl ether and benzene are microwave inactive, while polar molecules such as DMF, acetonitrile, dichloromethane, ethanol and water are microwave active. This technique proves to be excellent in cases where traditional heating has a low efficiency because of poor heat transmission and, hence, local overheating is a major inconvenience.⁴⁴

Microwave-assisted synthesis is a relatively young science of increasing research interest, as evidenced by the number of papers and reviews appearing in the literature.⁴⁵ The most important advantage of microwave-enhanced chemistry is the reduction in the reaction times. Reactions that require hours or days of conventional heating may often be accomplished in minutes under microwave heating. Moreover, reactions are not only faster, but proceed with higher purity and, consequently, higher yields. The dramatic acceleration and increased purity and yields of microwave-assisted reactions make them attractive to the increased demands in industry and, in particular, for combinatorial drug discovery.⁴⁶ In addition to being energy efficient, the possibility of employing milder and less toxic reagents and solvents, or even solvent-free systems, offers a further advantage of this heating technology.

1.4.1.2. Ultrasound. Ultrasound generally designates acoustic waves with frequencies in the range of 20–100 MHz. This energy is insufficient to cause chemical reactions, but when ultrasound travels through media a series of compressions and rarefactions are created, the rarefaction of liquids leading to cavities. During rarefaction, the negative pressure developed by power ultrasound is enough to overcome the intermolecular forces binding the fluid and tear it, producing cavitation bubbles. The succeeding compression cycle can cause the microbubbles to collapse almost instantaneously with the release of large amounts of energy. The enormous rise in local temperatures and pressures produces a dramatic beneficial effect of reaction acceleration, with relatively short times being required for completing the reaction such that the decomposition of thermally labile products is minimised.⁴⁷

The frequency of ultrasound has surprisingly little influence on the reactions within the range in which cavitation occurs. Of significance is the fact that ultrasound affects both homogeneous and heterogeneous reactions.

1.4.1.3. High pressure. Pressure represents a mild non-destructive activation mode, generally respecting the molecular structure by limiting decomposition or further

evolution of the products. Therefore, the specific effects of high pressure can be of important value for organic synthesis.⁴⁸ The kinetic pressure effect is primarily determined by the variation of volume due to changes in the nuclear positions of the reactants during the formation of the transition state. Related to volume requirements are steric effects since the bulkiness of the molecules involved in the transition state conditions the magnitude of the steric interactions. As a consequence, pressure affects volume changes and should have an effect on steric congestion.

As a mild activation mode, pressure may be considered of value in the synthesis of thermally fragile molecules, permitting a lowering of the temperature. In addition, the selectivity is generally preserved or even improved under such conditions.

On the other hand, pressure can be combined with solvophobic effects. The effect of pressure on organic reactions in aqueous solutions is complex. The activation volume relative to hydrophobic effects is positive (meaning deceleration by pressure), whereas the activation volume due to hydrogen bonding is negative. In addition, electrostatic effects may also be involved in many reactions (negative activation mode). Nevertheless, the combination of pressure and solvophobic activation may be an interesting method to increase the reactivity of reluctant polar molecules.

1.4.2. Physicochemical activation.

1.4.2.1. Micellar solutions. Micelles are dynamic colloidal aggregates formed by amphiphilic surfactant molecules. These molecules can be ionic, zwitterionic, or non-ionic, depending on the nature of their head groups, their micelles being classified in the same way. In dilute solutions, amphiphile molecules exist as individual species in the media and these solutions have completely ideal physical and chemical properties. As the amphiphile concentration increases, aggregation of monomers into micelles occurs and, as a consequence, these properties deviate gradually from ideality. This concentration is called the critical micellisation concentration.

During the formation of micelles, head group repulsions are balanced by hydrophobic attractions and for ionic micelles, also by attractions between head groups and counterions. Hydrogen bonds can be also formed between adjacent head groups.

It is well known that the rates and pathways of all kinds of chemical reactions can be altered by performing the reactions in micellar media instead of pure bulk solvents.⁴⁹ Micelles are able to (a) concentrate the reactants within their small volumes, (b) stabilise substrates, intermediates or products and (c) orientate substrates so that ionisation potentials and oxidation–reduction properties, dissociation constants, physical properties, quantum efficiencies and reactivities are changed. Thus, they can alter the reaction rate, mechanism and the regio- and stereochemistry. For many reactions, rate increments of 5–100-fold over the reactions in homogeneous solutions have been reported. In some cases, rate increments may be much higher and increments in the order of 10^6 -fold have been observed.

1.4.2.2. Microemulsions. When water is mixed with an organic liquid immiscible with water and an amphiphile, generally a turbid milky emulsion is obtained which, after some time, separates again into an aqueous and an organic phase. On the water-rich side, the mixtures consist of stable dispersions of oil droplets in water, which coagulate with rising temperature. A spongelike structure is obtained if the mixtures contain approximately equal amounts of water and oil. On the oil-rich side, dispersed water droplets are found, which coagulate with decreasing temperature. The size of the domains is a function of the amphiphile concentration and the volume fractions of water and oil.⁵⁰

Since microemulsions contain both a polar component (water) and a non-polar component (oil), they are capable of solubilising a wide spectrum of substrates. The mechanism of solubilisation is similar to that in micellar solutions. The micelles are replaced by the oil domains, which are capable of solubilising all kinds of hydrophobic substances. The solubilisation of polar substances takes place analogously through the aqueous domains of the microemulsion. The solubilisation capacity of microemulsions is generally superior to that of the micellar solutions and can therefore, affect the rate and course of a certain reaction.

1.4.3. Electrochemical activation. Electrochemistry represents a convenient synthetic method in which electrons constitute clean and energetically efficient reactants. The development of the potentialstat turned electrochemistry into a common tool for organic synthesis.⁵¹ In spite of the procedural simplicity, absence of side products derived from reagents and high ability for accomplishing selective oxidoreductions under very mild conditions, electro-synthesis still appears to be undervalued, even though some industrial-scale work has demonstrated its appealing features.

The apparatus required for electrosynthesis can be as simple as a beaker containing a pair of electrodes connected to a direct-current voltage source. A stirrer, thermometer, jacket, inert gas inlet, or any combination, can be added. For some reactions, the separation of the electrodes by a diaphragm is mandatory to prevent the products from one electrode diffusing to the other and being destroyed. A proper solvent and supporting electrolyte will be also required.

In some cases, chemical techniques turn out to be quite difficult in the preparation of certain organometallic species. Electrochemistry can, however, provide an easy way to generate a desired oxidation state of a metal complex that becomes the active catalytic species for an organic reaction. In the particular case of redox processes, the active catalytic species can be recycled continually by the electrode oxidation or reduction reactions. In these processes, the electrons are consumed stoichiometrically with respect to the substrate. Therefore, it is the electrons that are used as clean, controlled and non-polluting redox agents. In non-redox reactions, electrochemistry is used only to generate the catalytic system. It has been observed that electro-generated species can be more reactive than their chemically prepared analogues.⁵²

1.5. Miscellaneous non-conventional techniques

The techniques mentioned below are rather specific and so far have only been described for a limited number of examples.

1.5.1. Nanofiltration. It is important to recognise that the total efficiency of synthesis is also conditioned by the ability to separate the products from the unchanged starting materials, excess reagents and catalysts. Within the green chemistry context, it is also interesting to develop techniques that enable the separation and re-use of catalysts and reagents. Thus, separation protocols additional to those described above (i.e., perfluorinated systems, sc fluids, ionic liquids, solid-phase supported reagents and catalysts, etc.), which are easily automated to enable rapid purification by simple operations, are welcome.⁵³

In the field of homogeneous catalysis, separation of the catalyst from the product mixture is rather complicated, preventing large-scale industrial processes. An interesting and promising development in the area of homogeneous catalyst recycling is the attachment of homogeneous catalysts to soluble organic supports. In this way, macromolecular catalysts anchored on soluble supports such as polymers and dendrimers are created, which can be recovered by ultra- or nanofiltration techniques and re-used again.

Recently, solvent-stable ultra- and nanofiltration membranes have been introduced showing high retentions for medium-sized soluble molecules.⁵⁴ In the field of membrane filtration, ultra- and nanofiltration techniques are defined to retain macromolecules with dimensions between 8–800 and 0.5–8 nm, respectively.

1.5.2. Microreactors. Microreactor devices consist of a network of micron-sized channels (10–300 μm), with a high surface-area-to-volume, etched into a solid substrate.⁵⁵ For solution-based chemistry, the channel networks are connected to a series of reservoirs containing chemical reagents and products to form the complete device with overall dimensions of a few cm. Reagents can be brought together in a specific sequence, mixed and allowed to react for a specified time in a controlled region of the channel network using electrokinetic (electro-osmotic and electrophoretic) or hydrodynamic pumping. For electrokinetically driven systems, electrodes are placed in the appropriate reservoirs to which specific voltage sequences can be delivered under automated computer control. This control offers an effective method of moving and separating reagents within a microreactor, without the need for moving parts. Hydrodynamic pumping uses conventional, or microscale, pumps to manoeuvre solutions around the channel network, but, this technique has the disadvantage of requiring either large external pumps or complex fabrication of small moving parts.

Many reactions have been demonstrated to show altered reactivity, product yield and selectivity when performed in microreactors, as compared with conventional benchtop glassware. In fact, the desired product is often produced in higher yield and purity and more quickly. Process

parameters such as pressure, temperature, residence time and flow rate are more easily controlled, thus minimising risk and side reactions. Furthermore, solvent-free mixing, in situ reagent generation and integrated separation techniques can all help to make the chemistry greener.⁵⁶ One of the immediate applications is therefore in drug and process discovery, where the generation of compounds with different reagents under variable conditions is an essential factor and also allows, in a short time and with greater safety, a process to be transferred to the pilot and production scale.⁵⁷

1.5.3. Ball-milling conditions. Ball-mill chemistry is of interest because of the mild conditions under which it operates and also the absence of any solvent and easy work up. This technique has, however, been scarcely studied and applied to very few reactions.⁵⁸ Apparently, the rotation of the steel balls creates a high pressure in contact with the walls of the container, allowing the reagents to interact and promoting the process.

2. Objectives and organisation

In principle, we wanted to present in this report the application of recent non-conventional methodologies to the transition metal-catalysed carbon–carbon coupling reaction. Heck, Suzuki, Sonogashira, Stille, Negishi and Kumada reactions, among others, were the reactions originally to be covered. Because of the abundant literature found on this topic, however, we decided to dedicate this first part only to the Heck reaction, whereas the rest of the reactions will be studied in the second part in due course. Nonetheless, the above introduction is common for any of the parts of the review. Other carbon–carbon bond forming reactions such as the transition-metal catalysed coupling reactions through the activation of carbon–hydrogen bonds, nucleophilic substitution (Tsuji–Trost reaction), or acylation of carbon nucleophiles are beyond the scope of this review. Some of the reports dealing with the diverse topics to be tackled here have been previously and properly reviewed elsewhere and will not be covered to their full extent. Instead, a summary together with the more recent contributions until 2004 will be provided. The review is organised according to the sub-headings presented in the general introduction, taking into account the different components and variety of conditions involved in the Heck reaction. Many of the contributions to this review are also analysed from a critical point of view, with the aim of discussing the advantages and disadvantages that the different techniques offer and trying to select the best choice, when possible. A short conclusion can be found at the end of each section.

3. Introduction to the Heck reaction

The Heck reaction is broadly defined as Pd(0)-mediated coupling of an aryl or vinyl halide or sulfonate with an alkene under basic conditions. Since its discovery, this methodology has been found to be very versatile and applicable to a wide range of aryl species and a diverse range of olefins (Scheme 2).⁵⁹ The major steps of the

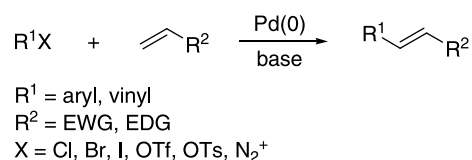

Scheme 2.

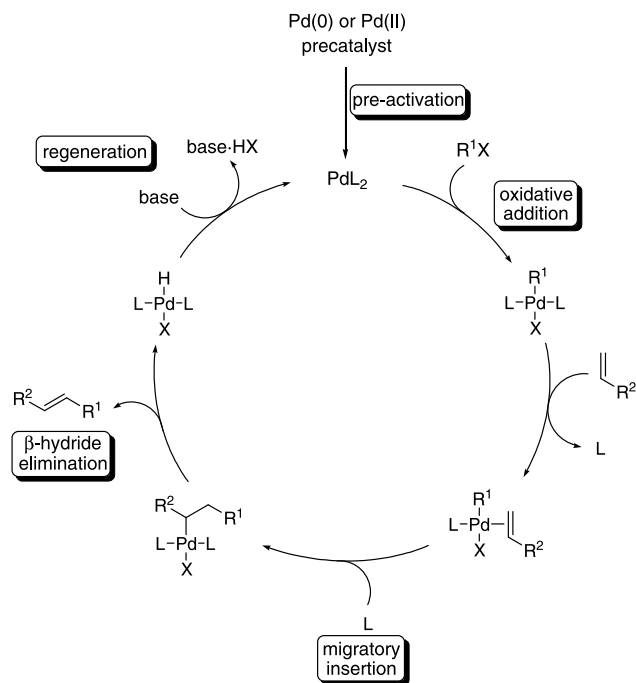

Scheme 3.

general and traditional mechanism for the Heck reaction are depicted in Scheme 3.⁶⁰

4. Substrates

4.1. Alternative arylating agents

In all the Heck reactions described in Scheme 2, a stoichiometric amount of base is required to neutralise the acid that is formed during the reaction (see Scheme 3). As a consequence, the corresponding equivalent amount of halide salt is obtained as waste. In the search for a cheap aryl source that does not lead to the formation of halide salts, de Vries et al. introduced the use of aromatic carboxylic anhydrides as the arylation source.⁶¹ For instance, heating benzoic anhydride and *n*-butyl acrylate in a *N*-methylpyrrolidinone (NMP) solution containing PdCl₂ and NaBr at 160 °C for 90 min, led to the formation of (*E*)-*n*-butyl cinnamate with high conversion, 90% selectivity and good yield. Although a catalytic amount of a chloride or bromide was necessary for optimal activity, phosphane ligands were not required. *p*-Methoxybenzoic anhydride and 2-furanoic acid anhydride were also successfully used as arylation agents. A variety of olefins were arylated under similar conditions at 140–190 °C (Scheme 4). Olefins with electron-withdrawing groups gave better yields, although, due to the relatively high reaction temperature, double-bond isomerisations and less

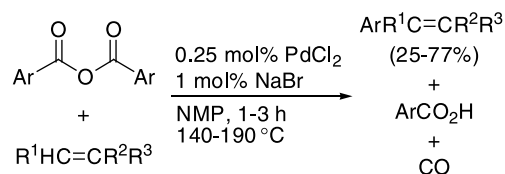

Ar = Ph, *p*-MeOC₆H₄, 2-furyl
 R¹ = H, OCy, CO₂Buⁿ, N(CH₂)₃CO
 R² = H, Me, CO₂Buⁿ
 R³ = H, Ph, CO₂Buⁿ, CN, *n*-C₈H₁₇

Scheme 4.

regioselective arylations were observed in some cases. It is noteworthy that the only side products in the reaction are benzoic acid (easily recovered by extraction with hot water) and carbon monoxide (which could be transformed into carbon dioxide in industrial processes).

Further investigation on this topic by Schmidt and Smirnov showed that the use of lithium chloride instead of sodium bromide increased the catalyst activity and productivity, since chloride accelerates CO elimination from the oxidative addition product more than bromide.⁶²

Gooßen et al. studied the decarbonylative olefination of aryl esters in an attempt to minimise the production of waste.⁶³ Starting from the *p*-nitrophenyl ester of the carboxylic acid, the corresponding alcohol formed in the Heck reaction could be recycled back into the starting ester, with CO and water being the only by-products in the overall reaction.^{63a} Lithium chloride and isoquinoline proved to increase the effectiveness and stability of the catalyst in such a manner that higher yields were obtained. A wide variety of benzoates of electron-deficient phenols (e.g., *p*-nitrophenol) were found to be suitable substrates, whereas both electron-rich and electron-poor olefins gave similar yields, with regioselectivities ranging from 4:1 to 20:1 (Scheme 5). If we compare this methodology with that described above, the scope of this Heck olefination seems to be wider. The catalytic system, however, requires larger amounts of all of its components, as well as the presence of a substantial amount of isoquinoline that must be removed at the end of the process. The lower reactivity of the benzoic esters in comparison with the benzoic anhydrides is also reflected in the reaction times.

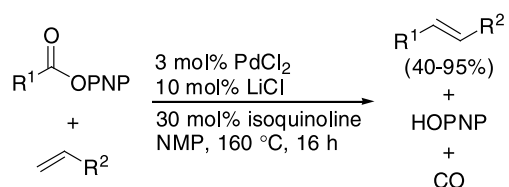

PNP = *p*-nitrophenyl
 R¹ = *p*-YC₆H₄ (Y = MeO, NC, MeCO, CHO, CF₃, Cl, PrⁱOCO), *m*-YC₆H₄ (Y = Me, NO₂, AcO), *o*-FC₆H₄, 2-naphthyl, 3-thienyl, 3-pyridyl, *trans*-cinnamyl
 R² = H, Ph, CO₂Buⁿ, CONHPrⁱ, CN, 2-norbornyl

Scheme 5.

The above idea was extended recently to the use of isopropenyl arenecarboxylates as arylating agents in a salt-free medium.^{63b} These arylating reagents were synthesised through a waste-free reaction involving ruthenium-catalysed addition of the carboxylic acids to propyne. Concerning the coupling reaction, instead of waste salts, CO and acetone are the only by-products, the volatility of which allows easy workup. Electron-rich and electron-deficient aryl, heteroaryl and vinyl carboxylic acid esters were coupled with several olefins (styrene in most cases) in good to excellent yields (Scheme 6). In contrast to the beneficial features of the whole process, the reaction temperature is rather high and is probably the reason for the moderate regioselectivities generally obtained (5:1–15:1), except in the case of *n*-butyl acrylate (> 50:1).

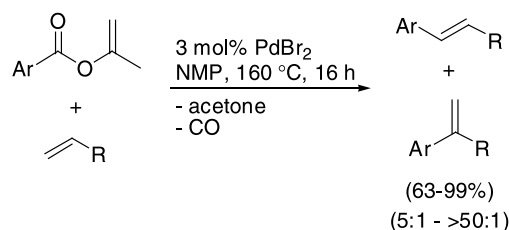

Ar = Ph, *p*-YC₆H₄ (Y = CHO, Cl, MeO, MeCO, CF₃), *m*-YC₆H₄ (Y = CN, OAc, NO₂), *o*-FC₆H₄, 2-naphthyl, 3-thienyl
 R = Ph, CO₂Buⁿ, 2-norbornyl

Scheme 6.

In the examples shown in Schemes 4 and 5, there is the necessity to generate the starting material in an extra reaction step and separate the olefin products from the carboxylic acids or phenols, these being practical disadvantages for small-scale preparations. Gooßen et al. utilised mixed anhydrides of carbonic and aromatic carboxylic acids, easily prepared in situ by mixing the carboxylic acids with di-*tert*-butyl dicarbonate (Boc₂O), as arylating agents in the Heck olefination.⁶⁴ Different aromatic and heteroaromatic carboxylic acids (including electron-rich carboxylic acids) were coupled mainly with styrene, to give the expected products in moderate to good yields (45–88%) and selectivities (5:1–28:1) (Scheme 7). The reaction could be performed at a lower temperature (120 °C), in comparison to the examples described above, although γ -picoline was necessary to stabilise the palladium

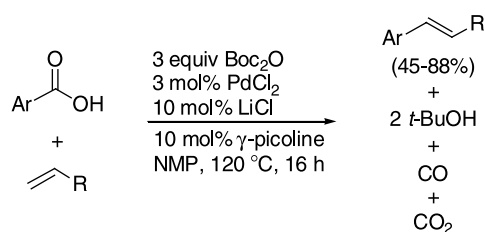

Ar = *p*-YC₆H₄ (Y = MeO, Cl), *m*-YC₆H₄ (Y = Me, MeCO₂), *o*-FC₆H₄, 3,4,5-tri-MeOC₆H₂, 2-naphthyl, 2-thienyl, 2-furyl, 3-thienyl, 3-furyl
 R = Ph, CO₂Bu^t, 2-norbornyl

Scheme 7.

and to avoid precipitation and loss of activity at reasonable reaction rates.

Myers et al. subjected a wide range of arenecarboxylates to efficient Heck-type decarboxylative coupling with olefinic substrates under relatively mild reaction conditions and in short reaction times (Scheme 8).⁶⁵ The key additive, silver(I) carbonate, presumably functions both as a base and as a stoichiometric oxidant, enlarging the lifetime of the active catalyst. Good yields of the coupled products were obtained for both electron-rich and electron-withdrawing substituents on the aromatic carboxylic acid and olefinic partners such as styrene, acrylates, (*E*)-ethyl crotonate and cyclohexenone. Certainly this methodology allows the direct use of aromatic carboxylic acids without any previous transformation, although the experiments suggested that at least one *ortho* substituent is necessary for successful decarboxylative palladation to occur. The relatively high catalyst loading and the large amount of the silver salt used are the main disadvantages of this methodology, which probably would limit its application to a laboratory scale.

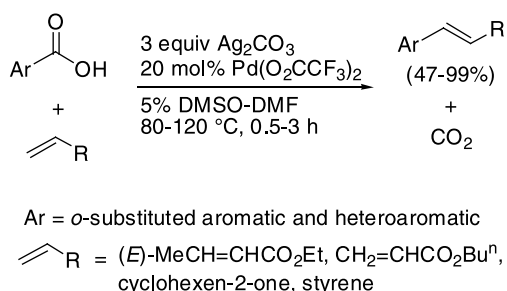

Scheme 8.

In 1982, Blaser and Spencer demonstrated that aryl chlorides could react with activated alkenes, under Pd(OAc)₂ catalysis in the presence of a tertiary amine at 120–130 °C, to give the expected (*E*)-aryllkenes stereospecifically and in high yields.⁶⁶ More recently, Miura et al. have utilised the rhodium complex [(C₂H₄)₂RhCl]₂ for the catalytic decarboxylative Heck-type coupling of aryl chlorides with styrene and *n*-butyl acrylate.⁶⁷ This methodology is very interesting, since the reactions are carried out in the absence of any phosphane ligand and base and with low catalyst loading, although refluxing *o*-xylene (143–145 °C) is needed to obtain the products with good yields at reasonable reaction times (Scheme 9). In addition, the workup seems to be significantly simple, that is, filtration, evaporation and washing with an appropriate

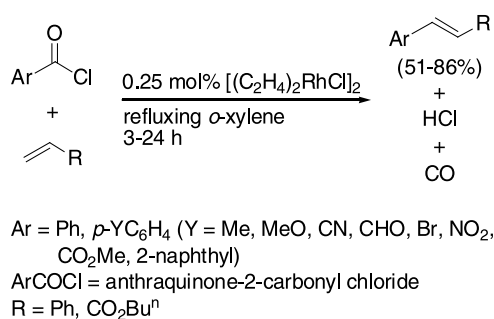

Scheme 9.

solvent such as methanol. A slow stream of nitrogen is, however, required to sweep away the HCl and CO evolved during the reaction, what can be a limitation for large-scale processes. Under similar conditions, cyclic alkenes such as norbornenes also reacted with aryl chlorides accompanied by cyclisation to afford the indanone derivatives.

Andrus et al. have recently applied a palladium-catalysed decarboxylative Heck-type reaction of aryl chlorides to the synthesis of resveratrol using palladium acetate, an imidazolium carbene-type ligand and a non-coordinating amine base, *N*-ethylmorpholine.⁶⁸ The overall yield starting from the inexpensive resorcylic acid (53%) was higher compared to the aryldiazonium or mixed anhydride approach.

Boronic acids have been used as arylating agents in Heck-type reactions by several groups.^{4b} Uemura et al. showed, in 1994, that arylboronic acids reacted with alkenes in acetic acid at 25 °C in the presence of a catalytic amount of palladium(II) acetate, together with sodium acetate, to give the corresponding aryl-substituted alkenes in high yields.⁶⁹ Alkenylboronic acids also reacted with alkenes under similar conditions to give the corresponding conjugated dienes stereospecifically, but the product yields were lower compared with those from the arylboronic acids. A similar treatment of sodium tetraphenylborate (NaBPh₄) with alkenes afforded the corresponding phenylated alkenes in high yields, together with biphenyl and benzene as side products. Oxidative addition of a carbon–boron bond to Pd(0), formed in situ, to give an organopalladium(II) species was assumed to be the key step of these cross-coupling reactions.

More recently, Lautens et al. utilised a rhodium complex to catalyse the coupling reaction of arylboronic acids and styrenes in an aqueous media (Scheme 10).⁷⁰ The best results were obtained with [Rh(COD)Cl]₂ and TPPDS as the water-soluble ligand. It was, however, necessary to add 0.5 equiv of sodium dodecyl sulfate (SDS) as a phase-transfer agent to avoid hydrolytic deboronation when the arylboronic acid had polar functional groups. Genêt et al. found out that, using *m*-TPPTC [tris(*m*-carboxyphenyl)phosphane trilitium salt] as the water-soluble ligand instead of TPPDS, no SDS was necessary, due to the inherent surfactant effect of *m*-TPPTC.⁷¹ This ligand exhibited a similar performance in comparison with TPPDS, but was shown to be superior to TPPTS under the same conditions depicted in Scheme 10, but in the absence of SDS. Lautens' methodology was very recently extended to the coupling of a wide variety of aryl- and hetero-arylboronic acids with acrylates, acrylamides and vinyl sulfones.⁷² The high selectivities and yields obtained were

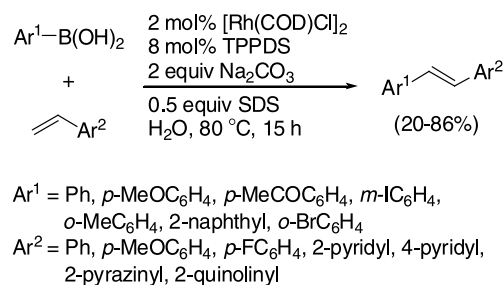

Scheme 10.

believed to result from the use of the bulky, electron-rich, water-soluble ligand *tert*-butyl-amphos chloride [*N*-2-(*di-tert*-butylphosphino)ethyl-*N,N,N*-trimethylammonium chloride].

Different catalytic systems have been developed recently for the Heck-type reaction of boronic acids and electron-deficient olefins (Scheme 11). Pd(OAc)₂, [Ru(*p*-cymene)Cl₂]₂ and RhCl₃ were utilised as catalysts by Mori,⁷³ Brown,⁷⁴ Zou,⁷⁵ and their corresponding co-workers, respectively. Despite the palladium and rhodium catalytic systems exhibiting better yields, higher temperatures were also required in comparison with the ruthenium catalytic system. Stoichiometric amounts of Cu(OAc)₂ were needed as a re-oxidising agent for palladium and ruthenium, the latter including 3-quinuclidinone as a base in order to obtain the highest turnover.

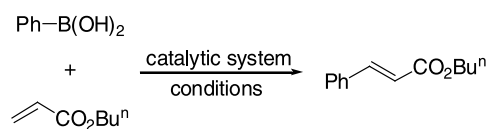

Catalytic system	Conditions	Yield
10 mol% Pd(OAc) ₂ 2 equiv Cu(OAc) ₂ 3 equiv LiOAc	DMF 100 °C 3 h	84%
2.5 mol% [Ru(<i>p</i> -cymene)Cl ₂] ₂ 2.5 equiv Cu(OAc) ₂ 2.5 equiv 3-quinuclidinone	CH ₂ Cl ₂ rt 24 h	66%
3 mol% RhCl ₃ 12 mol% Ph ₃ P	PhMe, H ₂ O 100 °C, 20 h	83%

Scheme 11.

The groups of Jung and Larhed independently introduced molecular oxygen as a re-oxidising agent in the palladium(II)-catalysed coupling of organoboron compounds and olefins. The optimised catalytic system reported by Jung et al. was composed of 10 mol% Pd(OAc)₂, O₂ and Na₂CO₃ in DMF at 50 °C for 3–10 h.⁷⁶ Under these conditions, electron-rich and electron-poor olefins could be coupled with several boronic acids and esters, with generally good yields and stereo- and regioselectivities. The catalyst loading was diminished to 1 mol% by Larhed et al. in a catalytic system composed of Pd(OAc)₂, O₂, *N*-methylmorpholine and 1.2 mol% 2,9-dimethyl-1,10-phenanthroline in MeCN at 50 °C for 3–24 h. This oxidative Heck protocol was applied to the coupling of arylboronic acids with unsubstituted acrylates^{77a} and electron-rich olefins.^{77b} The internal regioselectivity observed for the coupling with *n*-butyl vinyl ether and enamides was attributed to the phenanthroline ligand, which also seemed to mediate the re-oxidation of palladium(0) with molecular oxygen, allowing a low catalyst loading.

Together with boronic acids, arylsilanols⁷⁸ and arylstannanes^{78c,79} have been used as arylating agents in the Heck reaction with electron-deficient olefins. There are, however, some evident disadvantages of these materials, when compared with the carboxylic acid derivatives. Firstly, these starting materials are not so readily available, their

preparation involving less common and more expensive reagents, with the corresponding generation of waste. Secondly, boric acid, silanols and stannanes are formed as by-products in the Heck reactions, which can make the purification of the products difficult with a low possibility of recycling. Thirdly, the presence of large amounts of Cu(II) salts as re-oxidants, phosphanes and organic bases is required for a maximum efficiency.

Uemura et al. found that diphenyltellurium(IV) dichloride reacted with a variety of olefins in the presence of a catalytic amount of PdCl₂, together with NaOAc in HOAc to afford the corresponding arylated (*E*)-olefins in variable yields (3–98%) (Scheme 12).⁸⁰ A suitable oxidant such as *tert*-butyl hydroperoxide or copper(I) or copper(II) chloride had to be added for the reaction to proceed catalytically on palladium. The stereoselectivity was very high, except for acrylonitrile (*Z/E* 26:74). Transmetalation of tellurium with palladium was suggested as the key step of the reaction. Alternatively, diaryltellurides could be used as arylating agents for a variety of olefins in the presence of Et₃N as base and AgOAc as oxidant (40–99% product yield).⁸¹

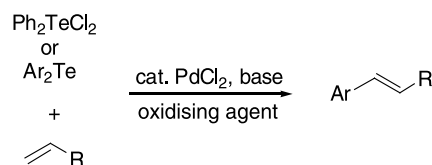

Scheme 12.

As an alternative to the above reagents, Kamigata et al. used aryl dimethyltellurium iodides for the palladium-catalysed Heck-type reaction with electron-deficient olefins and styrene, in the presence of a stoichiometric amount of silver(I) acetate.⁸² For the telluronium salt partner, the best results were obtained when the aryl moiety bore electron-donating substituents at the *para* position, those at the *ortho* position retarding the reaction (Scheme 13). The yields are good to excellent, although a 3-fold excess (with respect to the olefin) of the expensive silver acetate is needed for the anion exchange and oxidation steps in the catalytic cycle. In contrast with the reactions with organic tellurides, for which the crude mixtures must be purified to remove the excess reagent, in the reactions with the telluronium salts the pure products were obtained by simple filtration using silica gel to remove the solids in the reaction mixture.

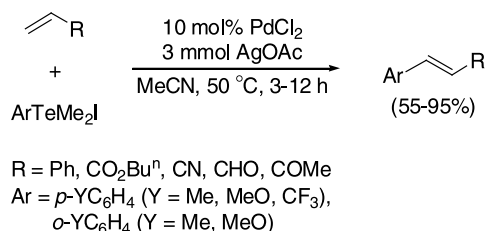

Scheme 13.

Unfortunately, the organic tellurides and tellurium salts are not commercially available. Diaryltellurium(IV) dihalides are normally prepared from TeCl₄ with activated arenes, arylmercury chlorides or arenediazonium salts.

Symmetrical diaryltellurides can be prepared from alkali tellurides and non-activated aryl halides, sodium telluride or potassium tellurocyanate and arenediazonium fluoroborates, tellurium(IV) halides and arylmagnesium halides, or elemental tellurium and diarylmercury compounds. Alkyl aryl tellurides are the precursors of the corresponding telluronium salts and are generally prepared by sequential arylation–alkylation of sodium telluride or from organyl tellurolates, generated by tellurium insertion into organomagnesium or organolithium reagents.⁸³ In short, the preparation of these aryating agents represents a major disadvantage that adds to the toxic and mutagenic properties of the starting materials, tellurium and TeCl₄, respectively, and to the possible toxicity of the organotellurium compounds.⁸⁴

A variety of organoantimony compounds have also found application in the arylation of olefins with different catalytic systems, including: (a) triphenylstibine with AgOAc and catalytic Pd(OAc)₂,⁸⁵ (b) diphenyl- and phenylantimony chloride with catalytic Pd(OAc)₂ under air,⁸⁶ (c) triarylantimony diacetates under PdCl₂(MeCN)₂ catalysis⁸⁷ and (d) triarylstibines⁸⁸ or tetraphenylantimony(V) carboxylates⁸⁹ in the presence of equimolecular amounts of a peroxide and catalytic amounts of Li₂PdCl₄ or PdCl₂ (see some selected examples in Scheme 14). In spite of the fact that these antimony compounds cannot be considered as usual reagents, all of them have an interesting feature in common, namely that the coupling reactions can be carried out under very mild reaction conditions, normally at room temperature or 50 °C.

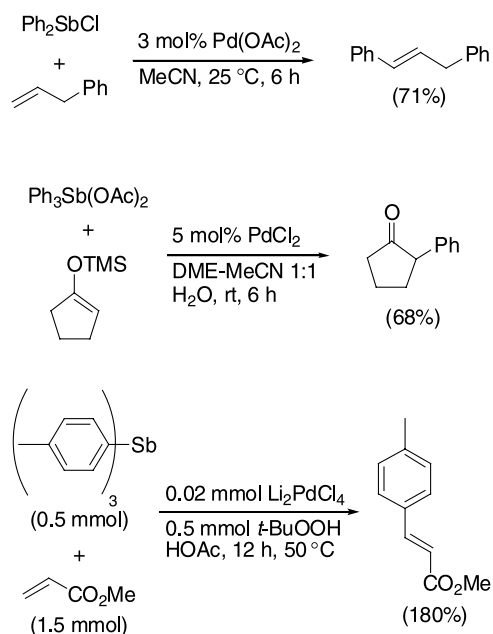

Scheme 14.

Less common is the use of organolead(IV) compounds as aryating agents for olefins. Kang et al. described in 1998 for the first time that aryllead triacetates could be coupled with a variety of electronically different olefins under mild reaction conditions and palladium catalysis (see one example in Scheme 15).⁹⁰ Most of the reactions proceeded at room temperature with moderate to good yields, although

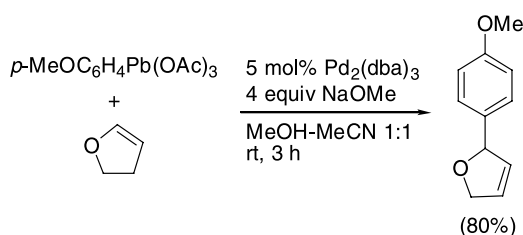

Scheme 15.

the homocoupling reaction competed in some of the experiments reported. It was presumed that the oxidative addition step was facilitated by the formation of the organolead trimethoxide, ArPb(OMe)₃, to give a polar reactive intermediate, ArPdPb(OMe)₃, which allowed the coupling under mild conditions. On the other hand, the aryllead triacetates are not commercially available and are rather toxic reagents.

Most of the alternative aryating agents presented in this report have the main advantage of minimising by-product formation, therefore facilitating the work-up. Except in the case of the carboxylic acids, however, the rest of the reagents are not commercially available and the generation of waste in their preparation is inevitable. In addition, rather high temperatures are needed for the coupling reactions in order to achieve reasonable conversions.

4.2. Supported substrates

Intermolecular Heck reactions on solid supports have been extensively used in synthetic organic and combinatorial chemistry, due to the easy accessibility of the starting haloalkenes or -arenes and alkenes. The reactions involve immobilised aryl halides, mostly iodides, or iodonium salts with soluble alkenes, or immobilised alkenes with soluble aryl halides. When performed on the same type of resin and with the same catalytic system, the immobilisation of aryl iodides appears to be more beneficial than that of alkenes. Two main protocols have been applied: (a) the standard Heck conditions [Pd(OAc)₂, Ph₃P or (*o*-Tol)₃P, DMF, 80–100 °C], 2–24 h] and (b) the Jeffery conditions [Pd(OAc)₂, Ph₃P, TBAC, K₂CO₃, DMF, 20–80 °C]. The intramolecular Heck reaction on solid supports has found application in the preparation of macrocycles and heteroatom-containing five-, six- and seven-membered rings, as well as in the construction of indoles, benzofurans, dihydroisoquinolines and benzazepines. The pseudo dilution effect exhibited by the starting material in the intramolecular version has led to an increased yield. Both inter- and intramolecular Heck reactions on a solid support have been recently reviewed¹⁷ and, therefore, it is not our objective to repeat all of this information here. Instead, we will deal with the more recent and representative examples and present a general conclusion at the end of this section.

Morphy et al. observed that the use of low solvent volumes in solid-phase Heck reactions resulted in large increases in yield, compared with the standard dilution conditions.⁹¹ 3-Iodobenzoyl chloride was reacted with Wang resin, the resulting aryl halide being coupled with ethyl acrylate under palladium catalysis, followed by resin cleavage with TFA.

After reaction at 60 °C for 2 h at standard dilution (1 ml), a conversion of 40% was observed, compared to 80% when only 0.05 ml of solvent was used. The reaction was complete after 18 h for a low solvent volume with only 54% conversion under standard dilution conditions (Scheme 16). The optimal amount of solvent represented $\leq 2 \mu\text{L}/\text{mg}$ of resin, significantly less than that required to totally swell the resin used and lead to a separate solvent phase. This methodology is certainly advantageous, since it minimises the use of solvent and provides high conversions under mild reaction conditions. Unfortunately, all reactions were performed on a very small scale (0.05 mmol of resin-bound 3-iodobenzoic acid) with excess of ethyl acrylate (2 equiv) and Et_3N (5 equiv) and, therefore, the behaviour of this catalytic system on a larger scale remains uncertain.

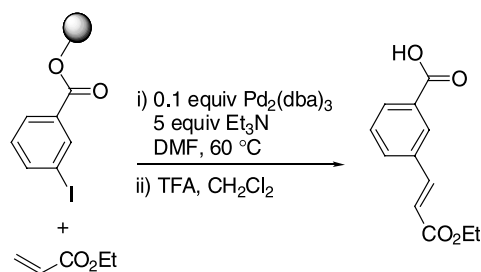

DMF (ml)	t (h)	Conversion (%)
1	2	40
0.05	2	80
1	18	54
0.05	18	> 95

Scheme 16.

A small library of cinnamate esters was prepared by Genêt et al., based on the use of a new stable silylated polystyrene, PS-SiMe₂CH₂Cl.⁹² This chloromethyl resin was esterified with various iodobenzoic acids (*o*-, *m*- and *p*-derivatives),

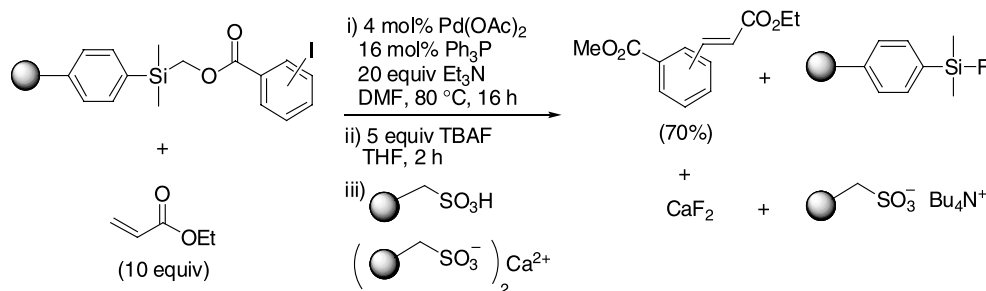

Scheme 17.

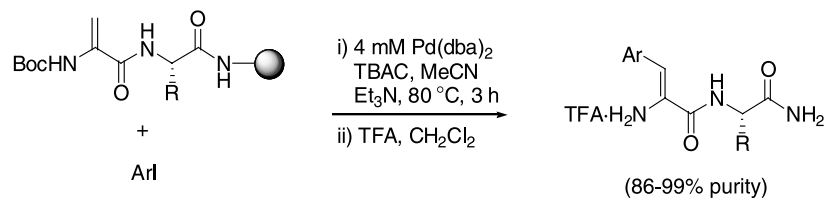

R = H, Me, Bu^t

Ar = *p*-MeOC₆H₄, *o*-MeC₆H₄, *m*-MeC₆H₄, *p*-MeC₆H₄, 1-naphthyl

Scheme 18.

followed by a cross-coupling reaction with ethyl acrylate in DMF in the presence of Pd(OAc)₂-PPh₃ as the catalytic system, the latter transformation taking place with complete conversion. The expected esters were released from the resin by treatment with TBAF in THF (Scheme 17). Owing to the difficulties of eliminating the excess of TBAF, however, further treatment with Amberlyst A-15 and its calcium salt as scavengers was needed to purify the reaction mixture. Despite the final products being obtained in good yields and the mild resin-cleavage step, this methodology does not seem to introduce any advantage with respect to the use of the more conventional resins. Firstly, the silylated resin is not commercially available and had to be prepared from a 1% divinylbenzene–styrene copolymer by lithiation and trapping with chloro(chloromethyl)dimethylsilane, a relatively expensive electrophile. Secondly, the cesium carboxylate had also to be prepared to increase its nucleophilicity in the S_N2 reaction to attach the resin. Thirdly, a special resin-cleavage protocol was needed, leading to more waste (additional to the excess of reagents) and to the generation of a new silylated resin with no chance of being recycled.

Takahashi et al. recently described the stereoselective synthesis of 36 peptides containing unnatural amino acids, utilising the Pd(0)-catalysed Mizoroki–Heck reaction of dehydroalanine derivatives in combination with an asymmetric hydrogenation on polymer support.⁹³ In this case, the alkene partner was supported on Synphase Rink-amino PS-Crowns™, whereas the aryl iodides were in solution. It was found that 4 mM Pd(dba)₂ in MeCN at 80 °C for 3 h in the presence of TBAC and Et₃N were the optimal reaction conditions. Products were obtained with a high purity, except for aryl iodides bearing electron-withdrawing substituents, where a low purity (45–60%, *p*-AcC₆H₄I) or no reaction (*p*-NO₂C₆H₄I) was observed (Scheme 18). Asymmetric hydrogenation and final cleavage with TFA–CH₂Cl₂ furnished the corresponding phenylalanine

derivatives with high stereocontrol. Unfortunately, the authors did not give any information about the isolated yields of the final products, making it difficult to evaluate the efficiency of the whole process.

Portnoy et al. synthesised various poly(aryl benzyl ether) dendrimers on a solid support, based on the initial immobilisation of commercially available 5-hydroxyisophthalate onto the Wang resin, followed by ester reduction. Repetitive Mitsunobu coupling and ester reduction led to the formation of a second and third-generation of dendrimers.⁹⁴ The three resins were subjected to Mitsunobu reaction with *p*-iodophenol, followed by Heck coupling with methyl acrylate, with complete conversions being achieved for every resin. Only moderate yields and fair purities were, however, obtained for any of the resins tested upon TFA-induced cleavage (Scheme 19). In fact, this methodology has no advantage with respect to that developed by Hanessian et al.⁹⁵ in which the aryl iodide was directly attached to the Wang resin. In this case, the free cinnamic ester was obtained in 90% overall yield under the same reaction conditions, but minimising the number of steps and consequently, the generation of waste, making the process more economic and time saving.

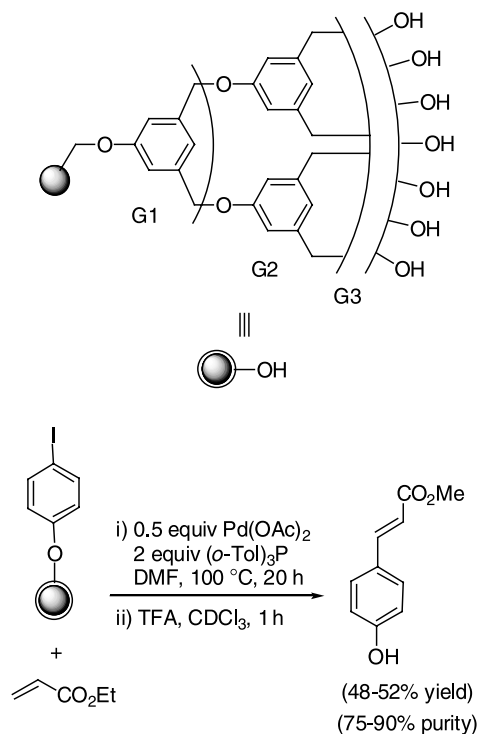

Scheme 19.

In a study on indole synthesis, Kondo et al. described the palladium-catalysed intramolecular cyclisation of enaminoesters in the solution phase and on solid supports.⁹⁶ In the solution phase, the expected ethyl 3-phenyl-2-indolecarboxylate was obtained in 56% yield after treatment with a catalytic amount of Pd₂(dba)₃, (*o*-Tol)₃P and Et₃N in DMF at 120 °C for 2 h (Scheme 20). The polymer-supported version of this reaction involved the attachment of the substrate to a hydroxymethyl-polystyrene resin, treatment with the same catalytic system at 110 °C for 12 h, and final transesterification of the resulting polymer-bound indole carboxylate using NaOMe in MeOH–THF. In this case, the product was obtained in 48% yield after further purification by column chromatography. It seems clear that the solution-phase reaction is advantageous, since it reduces the reaction time in the intramolecular coupling, less steps are used, and the yield is slightly improved. Similar solid-phase indole synthetic strategies have been published recently by the same research group.⁹⁷

It is clear that the main reason for immobilising a molecule on a solid support for the Heck or any other reaction relies on the simple separation of the intermediates and, finally, of the products from the reagents and soluble by-products. This fact, which represents a major advantage, compared to the solution-phase chemistry, may hide some inherent inconveniences and limitations that can curtail the whole efficiency of the process, for example, (a) reactions can be driven to completion in most cases, but only in return for consuming an excess of reagent, (b) suitable, robust and versatile linkers are required, which have to be cleaved selectively under mild reaction conditions without destroying the product, (c) a second functionality in the starting material is normally necessary for attachment to the support, as exemplified by the intermolecular Heck reaction, in which the polymer-bound aryl iodides must bear an additional group (carboxy, hydroxy, amino, etc.) that remains at the end in the product, whereas most of the polymer-bound alkenes studied are derived from α,β -unsaturated carboxylic acid derivatives, (d) the selection of usable solvents and the temperature range can be quite restricted (100 °C is at the upper limit), (e) the chemistry involving heterogeneous catalysts such as palladium on charcoal is incompatible with solid-phase synthesis methods, (f) the difficulty of analysing the outcome of a given reaction makes it necessary for the cleavage of the products from the support to be analysed by normal methods and (g) in the case of solid-phase combinatorial chemistry, additional investment is essential for laboratory automation, robotics and mechanical and tag-reading/sorting devices enabling the simultaneous performance of multiple tasks. In short, there is a need for more solid-phase methodology, including the development of traceless linkers.

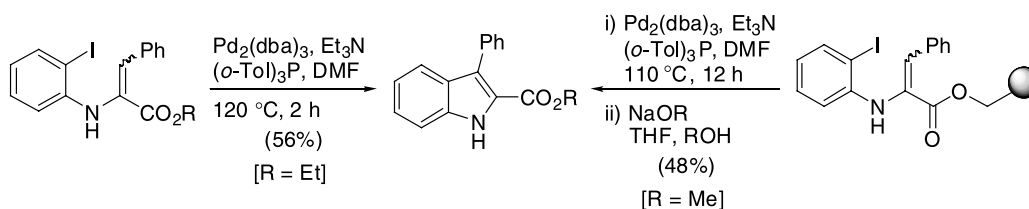

Scheme 20.

5. Catalytic systems

The selection of a proper catalytic system is fundamental for achieving the best efficiency in a given Heck reaction. In order to design such an efficient catalytic system, however, we have to focus not only on its catalytic activity or selectivity, but also on other important topical issues, such as the possibility of recovery of the components, or their toxicity and environmental impact, especially for application to an industrial scale. In fact, industrial applications are rare, because the cheap aryl chlorides or many readily available bromides do not react with sufficiently high yields, turnover numbers and selectivities, even in the presence of the traditional phosphane catalysts.⁹⁸ Significant efforts have been made in recent years to develop more efficient catalytic systems, trying to simplify these reactions as much as possible.

5.1. Ligands: ligand-free catalytic systems

Tertiary phosphane ligands have traditionally been used to ensure catalyst stability, in spite of the fact that they can have some detrimental effect on the rate of the individual steps of the coupling reaction. The use of phosphorus ligands in fine-chemical and industrial processes, however, is less desirable. They are usually toxic, unrecoverable and frequently hamper the isolation and purification of the desired product, as well as the performance of consecutive catalytic steps of the total synthesis. In spite of the fact that numerous phosphane-free ligand systems have been developed, including palladacycles, nucleophilic carbene ligands and others,⁹⁹ these catalytic systems suffer from some drawbacks. The high ligand sensitivity to air and moisture, their tedious multistep synthesis, the high cost of the ligands and the use of various additives curtails their applications. On the other hand, the ligand-free Heck catalytic systems have very recently emerged as more advantageous at all levels, operationally, economically and environmentally.¹⁰⁰

We have described in Section 4.1 a series of methodologies involving the use of alternative arylating agents to aryl halides in the Heck reaction, most of which have a common and advantageous feature, that is, no ligand was added to the reaction mixture. The ligandless approach to carbon–carbon coupling was, however, pioneered independently by Beletskaya¹⁰¹ and Jeffery.¹⁰² The latter author reported, in 1984, the palladium-catalysed vinylation of organic iodides under solid–liquid phase-transfer conditions at, or near, room temperature, using TBAC as the phase-transfer agent and sodium hydrogen carbonate as a base in the absence of any ligand.^{102a} The reactions proceeded with excellent yields (85–98%) and with high regio- and stereoselectivity. Aryl iodides furnished the (*E*)-products exclusively (Scheme 21), whereas (*E*)-1-iodohexen-1-ene gave a 1:15 diastereomeric mixture in favour of the (*E,E*)-product. The mild conditions allowed this type of reaction to be generalised to thermally unstable vinylic substrates such as methyl vinyl ketone or acrolein. Fortunately, the vinylation of vinylic iodides was greatly accelerated (1–5 h) by using potassium carbonate instead of sodium hydrogen carbonate as the inorganic base, with a parallel improvement of the stereoselectivity.^{102b}

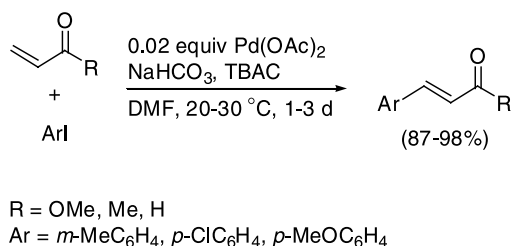

Scheme 21.

More recently, a slightly modified catalytic system was applied by Crisp et al. to the Heck coupling of the chiral non-activated alkenes, 2-aminobut-3-en-1-ols, with cyclohexenyl triflate.¹⁰³ In this case, tetra-*n*-butylammonium triflate was used instead of TBAC under mild reaction conditions, the produced dienes being isolated in moderate to good yields and with little or no racemisation (Scheme 22). The high reactivity observed with tetra-*n*-butylammonium triflate was attributed to the high rate of dissociation of the triflate anion from the neutral palladium(II) intermediate and the formation of a very reactive cationic palladium species. Some beneficial influence was observed when a small amount of water (5 equiv) was added to the reaction mixture. Little can be said about the scope of this reaction, since cyclohexenyl triflate was the only triflate tested.

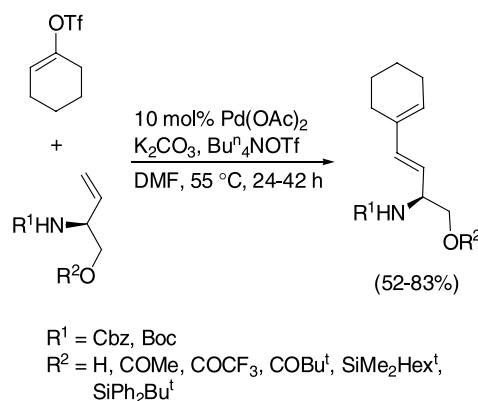

Scheme 22.

A very simple catalytic system was used by Gundersen et al. in the coupling of vinylpurine with a variety of aryl iodides (Scheme 23).¹⁰⁴ Better results were obtained when Pd(OAc)₂ alone was employed as the catalyst compared with catalysts containing phosphane ligands such as triphenylphosphane. All the couplings were highly stereoselective, including the coupling of vinylpurine with (*E*)-methyl 3-iodo-2-methylacrylate.

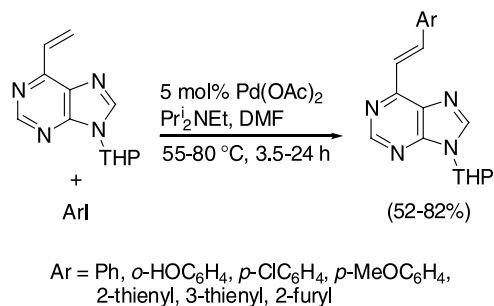

Scheme 23.

system, the relatively low solvent volume used and the easy workup procedure, makes it very attractive for large-scale production.

As an example of a specific application, a ligand-free palladium-catalysed Heck reaction of methyl 2-acetamidoacrylate and aryl bromides was used by de Vries et al. as the key step in the synthesis of enantiopure substituted phenylalanines.¹¹¹ All reactions were performed in NMP at 125 °C in the presence of Pd(OAc)₂, BnNEt₃Br and Pr₂NEt or NaOAc as base. A variety of aryl bromides with different electronic character was tested, giving rise to the corresponding products, purified by simple crystallisation, in moderate yields (Scheme 28). It is noteworthy that one of the reactions took place in 55% yield, even in the absence of the tetraalkylammonium salt, simplifying the catalytic system even more.

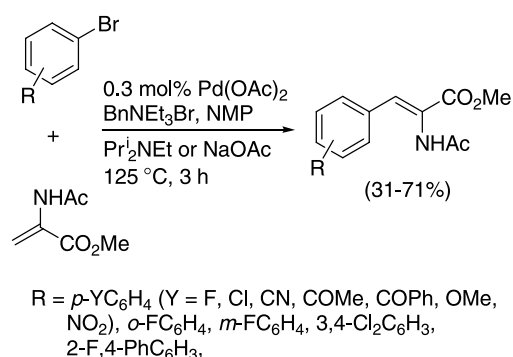

Scheme 28.

The absence of any ligand in the reaction medium, especially phosphane ligands, is very desirable. This absence, however, normally implies the presence of other additives to stabilise the in situ generated palladium species, which nonetheless can be removed more easily. At any rate, more efforts are needed for the ligand-free Heck reaction in order to decrease the reaction temperature, above all in the coupling of aryl bromides.

5.2. Catalysts: supported catalysts

Although the Heck reaction is also very attractive also for industrial applications, the homogeneous Heck reaction has no practical application in industry.¹¹² The loss of catalyst, which usually cannot be recovered and the need for aryl bromides or iodides as the starting materials are the major drawbacks that have prevented a more extensive exploitation of this reaction at an industrial level. The loss of catalyst could perhaps be tolerated if the cheaper and much more readily available aryl chlorides could be employed as the starting materials.

In principle, heterogeneous catalysts or heterogenised homogeneous catalysts can be used to solve some of the above-mentioned technical applications in the Heck reaction.¹¹³ Among the heterogeneous catalysts we should mention the supported metal catalysts, zeolite-encapsulated catalysts, colloid-nanoparticles and intercalated metal compounds. The homogeneous metal complexes catalysts can be heterogenised using modified silica catalysts,

polymer-supported catalysts, biphasic catalysts, supported liquid-phase catalysts, non-ionic liquid solvents, perfluorinated solvents and re-usable homogeneous complexes. All these types of catalysts can be easily recovered from the reaction mixture and recycled, if they do not deactivate too quickly under duty. In addition, the palladium in heterogeneous catalysts would already be present as metal crystallites dispersed onto the solid support, so that precipitation of palladium black should not occur. In general, the heterogeneous catalysts have a major drawback of lower selectivity towards Heck coupling and metal leaching, whereas the heterogenised metal complexes operate under milder reaction conditions.

Since an important part of this topic has been tackled in diverse reviews, we are going to deal mainly with some selected examples of the most recent literature covering the study of catalysts supported on carbon, metal oxides, molecular sieves, clays, zeolites, polymeric and dendrimeric materials, among others.

5.2.1. Carbon. Palladium on carbon proved to be active for Heck coupling under several different conditions and is one of the most frequently investigated catalysts.¹¹³ In general, carbon-supported catalysts do not seem to differ significantly in activity from their homogeneous counterparts, since the proportion of the metal to the limiting reagent, reaction temperatures, times and yields are comparable to those observed for homogeneous catalysts. Palladium supported on carbon, however, often causes unwanted hydrodehalogenation of the haloaromatic compounds and suffers from substantial palladium leaching.¹¹⁴ Palladium leaching is also relevant to the mechanism of Pd/C-catalysed Heck couplings. In fact, it is still the subject of debate as to whether the reaction takes place on the solid palladium surface or the true catalyst is the dissolved palladium that has been leached from Pd/C, which acts simply as a palladium reservoir.

It is worth mentioning the publication by Beller et al. which described the first Heck reaction of aryldiazonium salts using heterogeneous catalysts.¹¹⁵ Palladium on carbon was shown to be a very effective catalyst in this reaction under very mild conditions (40–60 °C) (Scheme 29). There was no need to add stoichiometric amounts of base or stabilising ligands such as phosphanes and these are major advantages. Unfortunately, the catalyst exhibited an important reduction in activity after its first use. The lack of commercial availability of the starting anilines and the additional step of conversion into the corresponding aryldiazonium salts

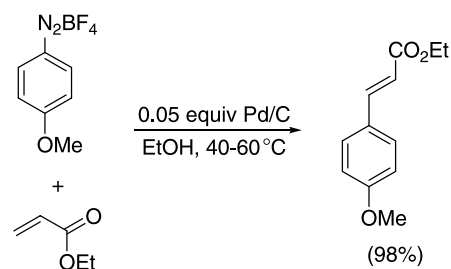

Scheme 29.

would be the only possible disadvantages of this methodology.

A very interesting and detailed study was reported by Köhler et al. concerning the Heck reaction of aryl bromides with olefins in the presence of a variety of Pd/C catalysts.¹¹⁶ The activity of the catalysts was shown to be strongly dependent upon the palladium dispersion, palladium oxidation state in the fresh catalyst, the water content and the conditions of catalyst preparation. A high palladium dispersion, low degree of palladium reduction, high water content and uniform palladium impregnation led to the most active catalyst. The fact that uniformly impregnated Pd/C catalysts showed higher activities than eggshell catalysts supported the hypothesis that leached palladium is the active species, for which the solid Pd/C acts as a reservoir that delivers catalytically active palladium species into solution. In fact, Arai et al. have demonstrated that palladium exists on the support, in solution and in the form of free colloidal particles during and after the Heck reaction, which can be redeposited on the support.¹¹⁷ The optimised Pd/C catalyst exceeded by at least one order of magnitude the activity of any heterogeneous palladium catalyst reported in the literature in the reaction of bromoarenes with olefins (Scheme 30). In general, all the catalysts studied exhibited a high activity and selectivity, without the exclusion of air and moisture, extremely low palladium concentrations, easy and complete separation from the product mixture, easy and quantitative recovery of palladium and commercial availability. Although the TONs were still lower than those of the most active homogeneous catalytic systems for the activation of aryl bromides, the TOFs were higher, the activity at the beginning of the reaction being extremely high before deactivation of the catalyst occurred. In contrast to the results of Arai et al.,¹¹⁸ who observed up to 80% hydrodehalogenation, no hydrodehalogenation of bromoarenes was observed in any experiment.

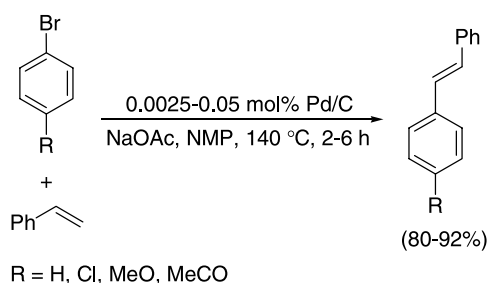

Scheme 30.

Hara et al. obtained quasi 2-dimensional palladium nanoparticles encapsulated into graphite, which proved to be active catalysts for the Heck reaction.¹¹⁹ Thus, an 82% yield of the coupled product, stilbene, was isolated by reacting 1 mmol of styrene with 2 mmol of iodobenzene in the presence of 4 mmol of potassium carbonate, 2 mmol of tetra-*n*-butylammonium bromide and 10.2 mg of the quasi two-dimensional palladium particles encapsulated in graphite (37%) in DMF using a sealed tube at 100 °C for 4 days (Scheme 31). No coupling product was observed with chlorobenzene. The nanoparticles remained inside the

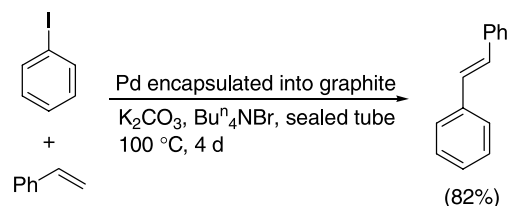

Scheme 31.

carbon lattice after the Heck reaction and could not be washed out, the catalyst therefore being stable. Despite this catalytic system completely avoiding palladium leaching, its preparation is rather time consuming and somewhat complex. In addition, harsh reaction conditions and long reaction times are required.

For the application of Pd/C in combination with ionic liquids, see Section 6.2.

5.2.2. Metal oxides and other inorganic materials. The catalytic activity and selectivity of palladium supported on various metal oxides in the Heck reaction have attracted the interest of many research groups, both the nature of the oxide support and the Pd dispersion playing a crucial role in the activity of the catalytic system.¹²⁰ On the other hand, there is a considerable interest in determining the heterogeneous or homogeneous nature of the mechanisms involved in these reactions.¹²¹

Silica, within the family of metal oxides, has been, by far, the most utilised support in the Heck reaction.¹²² In one of the first reports on this topic, Strauss et al. used 0.18% palladium on porous glass tubing for Heck reactions conducted continuously or batchwise.¹²³ This support offered resistance to oxidative deterioration and could be re-used several times for repeating, or for different, reactions, but the regio- and stereoselectivity was lower than expected. In parallel with this work, Mirza et al. developed a supported liquid-phase catalytic system for the Heck reaction of iodobenzene and methyl acrylate in a batch reactor, based on a combination of sulfonated triphenylphosphine–palladium complexes (Na-TPPMS and PdCl₂) supported upon porous glass beads and solvated with ethylene glycol (Scheme 32). Under these conditions, the catalyst complex was held in solution, whilst the reactants and products were restricted to a nonmiscible solvent phase.¹²⁴ Leaching was eliminated to the limits of detection, but the activity of the supported liquid-phase catalyst decreased significantly after recycling. With regard to the nature of the catalysis occurring within the system, evidence suggests that this is predominantly homogeneous via the formation of an organic-soluble catalyst complex. Alternatively, potassium acetate was used by Arai et al. as an inorganic base instead of triethylamine in a very similar

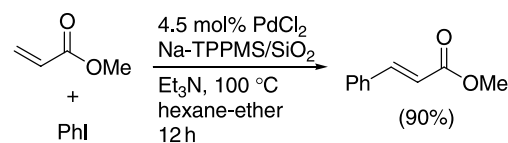

Scheme 32.

catalytic system,¹²⁵ whilst tri-*n*-butylamine gave higher reaction rates than triethylamine.¹²⁶

A supported palladium catalyst on glass beads, generated from a guanidinium phosphane and palladium acetate, showed a high activity and low leaching of catalyst in the Heck reaction of aryl iodides and alkenes (Scheme 33).¹²⁷ The low catalyst loading, as well as the high yields achieved and the low leaching maintained over four reaction cycles, are clear advantages of this catalytic system. The main inconvenience is the preparation of the ligand which involves four steps, that is, Grignard reaction of commercially available 2-(*N,N*-bis-trimethylsilylamino)phenylmagnesium chloride with phosphorus trichloride, nitrogen deprotection, hydrochloride formation and condensation with dimethyl cyanamide.

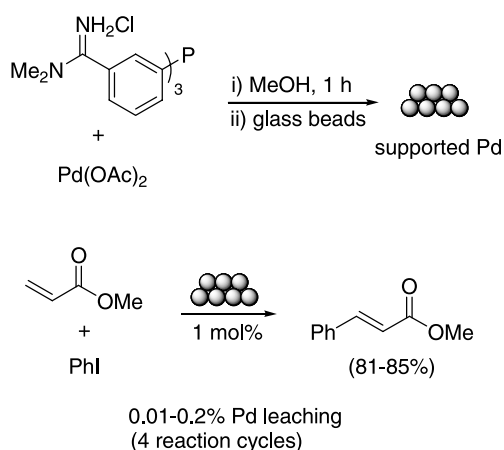

Scheme 33.

The same research group prepared a new catalyst by treatment of reverse-phase silica beads with Pd(OAc)₂ and Ph₃P in cyclohexane.¹²⁸ The reverse-phase bead catalyst formed was assumed to contain (Ph₃P)₂Pd(OAc)₂ and was stable in air and easy to handle. This catalyst was applied to the Heck reaction between iodobenzoic acid and acrylic acid, the expected product being obtained in a high yield and with low palladium leaching (Scheme 34). Heteroaromatic halides were also coupled with methyl acrylate with lower yields and low palladium leaching. The reverse-phase beads could be recovered from the reaction mixture and were

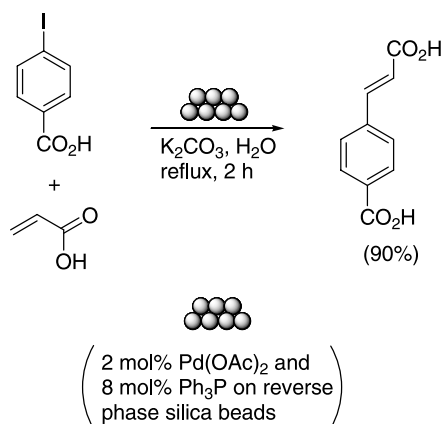

Scheme 34.

re-used seven times without any apparent loss of activity. Some reactions could be performed in water or with no added solvent. The real advantage of using the reverse-phase silica support seems to be that more polar substrates can be employed.

The catalysts shown in Chart 1 are all stable and active heterogeneous catalysts based on chemically modified silica, prepared by building up a suitable ligand structure, containing an aminopropyl moiety, on the surface of the silica, followed by complexation to the M(II). All of these catalysts have been recently reported and shown to be effective in Heck reactions, complex **1** furnished 82% conversion in the coupling of iodobenzene and methyl acrylate with Et₃N in MeCN at 82 °C for 24 h.¹²⁹ This catalyst was successfully re-used without a noticeable loss of activity and with no detectable amounts of palladium leached. The same complex **1**, but prepared from PdCl₂ instead of Pd(OAc)₂ on ordered mesoporous silica FSM-16, was active for the coupling of aryl iodides and bromides with methyl acrylate, giving 100% conversion in 1–5 h at 130 °C. Aryl bromides with electron-donating substituents were particularly sluggish in their reactivity, but the reactivity could be increased by the addition of TBAB. Seven reaction cycles were applied in the vinylation of 4-bromoacetophenone with methyl acrylate without a significant loss of reactivity.¹³⁰ Complex **2** was prepared by heating 3-(4,5-dihydroimidazol-1-yl)-propyltriethoxysilanedichloropalladium(II) with mesoporous silica nanotube particles.¹³¹ A 1.5% palladium-imidazoline complex **2**

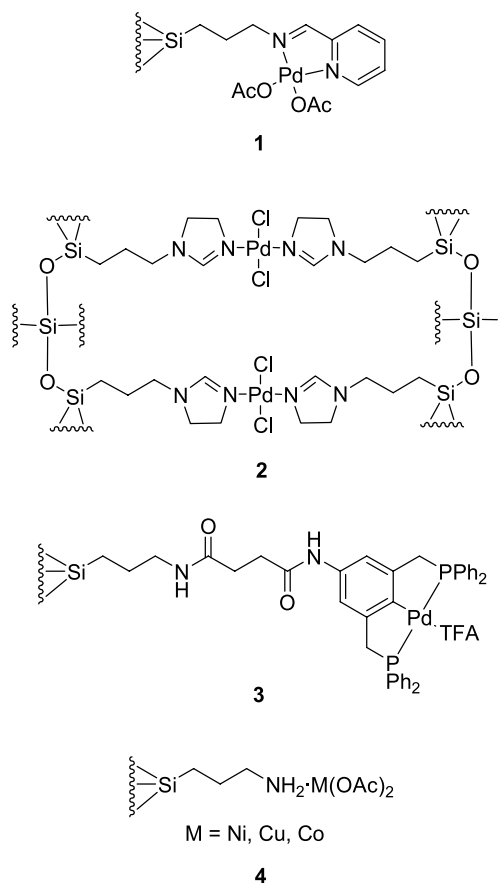

Chart 1.

with Cs_2CO_3 in dioxane at 80°C for 2–3 h gave excellent yields (79–94%) of coupled products obtained for a wide array of bromides or iodides with styrene. In all cases where recycling of the catalyst was attempted, however, small decreases in activity were observed from one run to the next. A higher reaction temperature (140°C) was required for catalyst **3** in the reaction of iodobenzene and *n*-butyl acrylate using sodium carbonate as base in NMP.¹³² High TONs were obtained and the catalyst was recycled three times with high activity, whereas a lower reactivity was observed for styrene, with both *E/Z* stilbenes being formed in a 7:1 ratio. A higher loading of catalyst was necessary in the case of 4-bromotoluene and a lower yield was found after three runs. Zheng et al. prepared silica-supported poly- γ -aminopropylsilane-transition metal complexes **4**, which were also active and stereoselective for the Heck vinylation reaction of aryl iodides with olefins at 120 – 150°C .¹³³ All of the complexes were treated with KBH_4 –EtOH before use. The supported Ni complex furnished the expected products in 86–98% yield and the Co and Cu complexes in 71–96% yield, although the reaction of iodobenzene and styrene gave stilbene in only 40% yield with the latter complexes. An induction period of >2 h was observed for these catalysts. The reaction temperature could be reduced by up to 70 – 100°C using a similar, but new, silica-supported poly- γ -aminopropylsilane- Cu^{2+} - Pd^{2+} complex.¹³⁴

Although there is no doubt about the efficiency and the possibility of recycling of the above-described catalysts, a comment must be made concerning their preparation. A minimum of three reaction steps are involved in the preparation of the catalysts (10 steps for catalyst **3**) and, in addition, other multiple operations such as filtration, washing, drying under vacuum or high temperature, or conditioning by refluxing in a solvent, as well as long reaction times, are needed for some of the steps (up to 4 days). Therefore, taking into account the yield reduction when increasing the number of steps, as well as the waste produced along the synthesis of the catalysts and the price of the starting materials and metallic salts, the catalysts **4** seem to be the most convenient from a practical point of view and for the larger-scale preparations.

In relation to the above catalytic system described by Zheng et al. this research group prepared silica-supported palladium(0) complexes from γ -chloropropyl- and γ -aminopropyltriethoxysilane via immobilisation on fumed silica, followed by reaction with ethylenediamine and salicylaldehyde and then reaction with PdCl_2 and reduction with KBH_4 .¹³⁵ In this case, the reaction temperature was reduced to 90°C for the Heck reaction of aryl iodides (*p*- $\text{RC}_6\text{H}_4\text{I}$, $\text{R} = \text{H}, \text{MeO}, \text{CO}_2\text{H}$) with acrylic acid, methyl acrylate and styrene. The catalysts could be recovered and re-used without loss of activity. A comparable performance was observed for the silica-supported palladium(0) complex similarly prepared from poly- γ -cyanopropyltriethoxysilane.¹³⁶

N,N-di(pyrid-2-yl)norborn-2-ene-5-ylcarbamide was surface grafted or coated onto various silica-based carriers through a ring-opening metathesis polymerisation (ROMP) in the presence of $\text{Mo}(N\text{-}2,6\text{-Me}_2\text{C}_6\text{H}_3)(\text{CHCMe}_2\text{Ph})[\text{OCMe}(\text{CF}_3)_2]_2$.¹³⁷ The silica-based materials were used

in slurry reactions under standard conditions, as well as under microwave irradiation, the latter case leading to a drastic reduction of the reaction times. A quantitative conversion was achieved for iodoarenes, while activated bromoarenes required prolonged reaction times. Typically, less than 2.5% palladium was leached into the reaction mixture. Nonetheless, the preparation of the supported catalysts is very sophisticated in order to finally achieve similar results to those obtained with simpler supported catalytic systems. An example using 0.3 mol% of the silica-based slurry is depicted in Scheme 35.

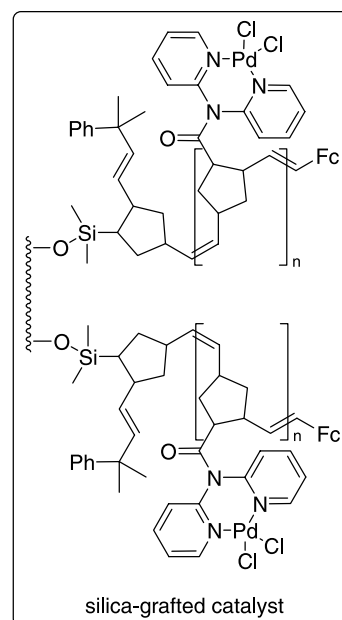
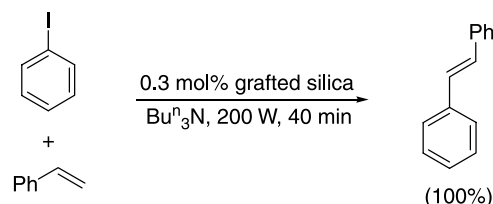

Scheme 35.

In 1997, Cai et al. described the preparation of a silica-supported poly- γ -mercaptopropylsiloxane-palladium(0) complex that gave high yields (86–96%) in the arylation of styrene and acrylic acid (Bu_3N , xylene, 100°C , 6 h) and could be recovered and re-used with a low decrease in activity.¹³⁸ The same ligand, but supported on FSM-16 mesoporous silica, was shown to be an active and stable catalyst for the Heck reaction of 4-bromoacetophenone and ethyl acrylate (KOAc, NMP, 130°C , 92% yield), the catalyst being re-used at least five times with no indication of catalyst deactivation. The less reactive electron-rich aryl bromides, 4-bromoanisole and bromobenzene, however, resulted in moderate yields (58 and 62%, respectively), whereas 4-chloroacetophenone gave a low yield (18%).¹³⁹

Based on the above original methodology and, more recently, Cai's group has prepared a silica-supported bidentate arsine-palladium(0) complex from 4-oxa-6,7-dichloroheptyltriethoxysilane via immobilisation on fumed

silica, followed by reaction with potassium diphenylarsenide and palladium chloride and then reduction with hydrazine hydrate.¹⁴⁰ This complex exhibited a high activity in the stereoselective arylation of styrene and acrylic acid with aryl halides, affording a variety of *trans*-stilbenes and substituted *trans*-cinnamic acids in high yields (Scheme 36). The arylation of styrene with aryl iodides proceeded smoothly at 100 °C, whereas that of aryl bromides took place at 140 °C with added triphenylphosphane. The substituent effects in aryl iodides appeared to be less significant than those in aryl bromides, the reactivity of the latter with electron-withdrawing substituents being higher than that of aryl bromides with electron-donating substituents. The bidentate arsine ligand seems to efficiently prevent palladium leaching, since a yield variation of only 91 to 89% was observed after four consecutive runs. Similar results to those described above were obtained in the coupling of aryl halides with acrylic acid. It is worthy of note that the catalyst activity did not remarkably decrease after exposure to air for 7 days. The methodology was extended to the arylation of acrylonitrile, furnishing (*E*)-cinnamitriles in high yields.¹⁴¹ Some disadvantages include the fact that the starting 4-oxa-6,7-dichloroheptyltriethoxysilane and potassium diphenylarsenide are not commercially available and must be prepared, the potential toxicity of the arsenic products and waste, and the higher temperature and presence of Ph₃P required for aryl bromides. The same group prepared a silica-supported poly- γ -methylselenopropylsiloxane-palladium(0) complex (from poly- γ -chloropropylsiloxane and sodium methylselenolate, followed by reaction with PdCl₂ and final reduction with hydrazine hydrate), which was also a highly active and stereoselective catalyst for the arylation of conjugated alkenes.¹⁴²

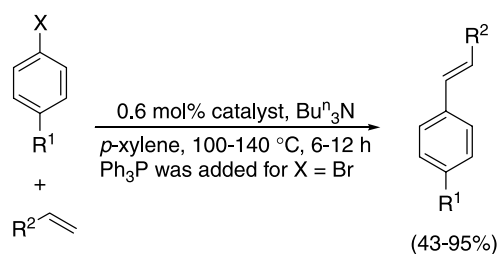

R¹ = H, Cl, Me, MeO, NO₂, MeOCO
R² = Ph, CO₂H
X = Br, I

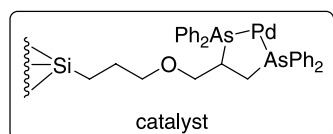

Scheme 36.

A palladium(II)–SCS–pincer complex was immobilised on porous silica and the resulting catalyst **5** was applied to the reaction of iodobenzene and *n*-butyl acrylate with Et₃N in DMF at 120 °C for 1.5 h.¹⁴³ The catalyst was recycled three times with high yields (>99, 97 and 94%, respectively), with induction periods between subsequent runs indicating that the silica-immobilised catalyst acted as a precatalyst,

with the real active species being generated in situ during the reaction. It would worthwhile knowing about the substrate scope and limitations of this catalytic system.

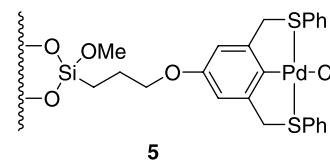

Molnár et al. prepared two series of catalysts by modifying silica with various chlorohydrosilanes, followed by reaction with a saturated solution of PdCl₂ or a 1.25 × 10⁻³ PdCl₂ solution to obtain five palladium-on-silica catalysts with different Pd loadings and another five palladium catalysts with an equal palladium loading of 0.3 wt%, respectively.¹⁴⁴ These catalysts were found to exhibit a high activity in the Heck coupling of aryl halides with styrene or methyl acrylate to afford the corresponding *E* isomers with good to excellent selectivities. The 0.3 wt% Pd-silica catalysts showed a lower activity, but increased selectivities, with 0.3 wt% Pd/SiO₂Ph being the best catalyst (Scheme 37). The catalytic performance seemed to be related to the organophilicity of the surface, since the catalysts prepared from precursors with a single organic group as the surface modifier (Pd/SiO₂Me and Pd/SiO₂Ph) showed a higher activity than those containing two organic groups (Pd/SiO₂Me₂ and Pd/SiO₂Ph₂). In a comparative study, the properties of these organically modified silicas were considered to be identical with those of 10 wt% Pd/C. Despite the reactions being carried out in a sealed tube at 150 °C, the experimental procedure for the preparation of these catalysts is very straightforward and their performance is remarkable. In addition, the catalyst performance did not change in successive experiments in which no special precaution was taken to exclude air or moisture.

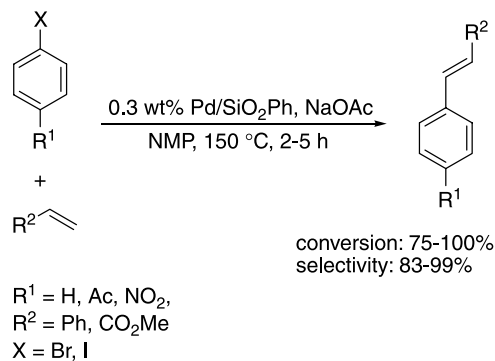

R¹ = H, Ac, NO₂,
R² = Ph, CO₂Me
X = Br, I

Scheme 37.

Rotello et al. reported a highly reactive, recyclable, heterogeneous catalyst in which palladium mixed monolayer protected clusters were simultaneously used as building blocks and active catalytic units.¹⁴⁵ Palladium nanoparticle **6** (obtained by place exchange of 11-mercaptoundecanoic acid onto 1 nm octanethiol-covered particles) was dissolved in MeOH and, to this, was added silica particles **7** and amine polymer **8**. The active catalysts were prepared through calcination of the nanocomposite materials, providing total removal of organics and

preserving intact the highly porous nature of the systems. The calcinated **6·7·8** was able to catalyse the Heck reaction of activated and neutral bromoarenes with styrene and methyl acrylate (Scheme 38). A large difference in reactivity was observed for bromobenzene and *p*-nitro-bromobenzene, the former leading to much lower yields (25–30%). The main drawbacks of this catalytic system seem to be the fact that the starting materials are not readily available and the relatively long reaction times required for the coupling reaction (1–2 days).

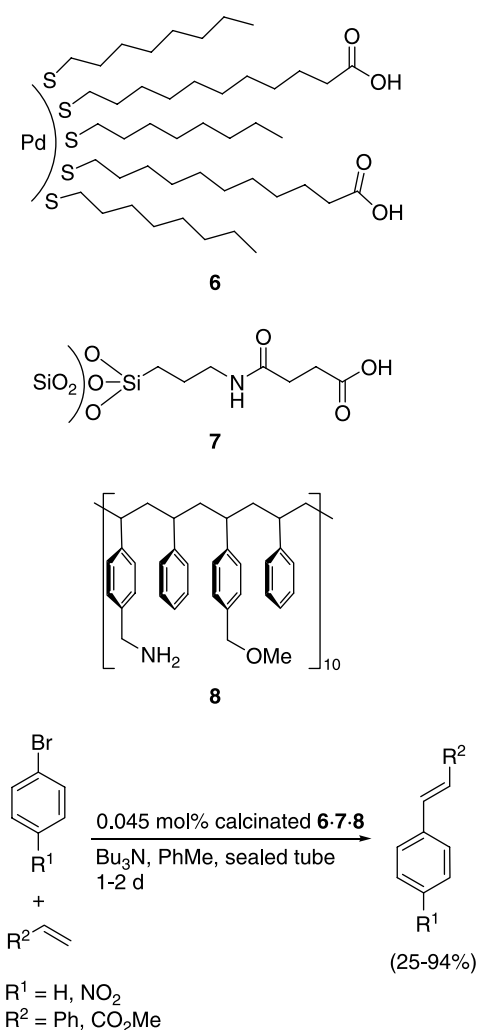

Scheme 38.

More recently, the introduction of a hydrosilane function on the pore channels of a mesoporous silica SBA-15 allowed the obtention of a highly dispersed palladium colloid layer on the pore walls of the support material.¹⁴⁶ This heterogeneous catalyst system was successfully applied to the Heck coupling of styrene and methyl acrylate with iodobenzene and electron-deficient aryl bromides, although bromobenzene gave poor conversions. The catalyst (0.02 mol% Pd-SBA-15) showed a high stability against leaching of the active species into the liquid phase and could be recycled (by filtration, washing and drying) without any apparent decrease in its catalytic activity. On the other hand, the reaction temperatures were rather high (120–170 °C,

20 min–48 h) and the catalytic system had a narrow range of substrate applicability.

Blum et al. described the easy preparation of silica sol-gel entrapped $\text{PdCl}_2(\text{PPh}_3)_2$ as a heterogeneous catalyst for the coupling of iodobenzene and *p*-nitroiodobenzene with styrenes and acrylic acid derivatives.¹⁴⁷ The reactions were performed with Pr_3N as a base in toluene at 90–110 °C for 8–12 h and both the yields and stereoselectivities ranged from low to good, the aryl bromides reacting sluggishly. Recycling of the catalyst (by filtration and sonication) without any loss of activity was only possible in the reaction of styrene and iodobenzene. The arylation products derived from acrylonitrile were accompanied by some polymerisation products.

Ionic liquids have been used to immobilise palladium on porous silica supports and applied to ligandless Heck reactions. Exploiting the unique properties of ionic liquids, Marr et al. prepared a silica aerogel structure containing palladium nanoparticles that led to 100% conversion in the Heck reaction of *n*-butyl acrylate and iodobenzene in 2 h at 80 °C.¹⁴⁸ The selectivity towards *trans*-*n*-butyl cinnamate remained at 100% after catalyst recycling by filtration, washing and drying. In this context, Hagiwara et al. supported $\text{Pd}(\text{OAc})_2$ on amorphous silica with the aid of the ionic liquid $[\text{bmim}]\text{PF}_6$ through a simple procedure.¹⁴⁹ In this case, the Heck reactions involved cyclohexyl acrylate and aryl halides of different electronic character (59–96% yield), and were carried out in a hydrocarbon solvent in order to prevent removal of the ionic liquid layer from the silica (the best result is shown in Scheme 39). The catalyst was air- and thermally-stable and was re-used six times, giving high yields. The reaction temperature was, however, rather high and it would be interesting to know the possibility of application of the methodology to other more conventional acrylates and other olefins. In fact, methyl acrylate furnished low to moderate yields of the coupled product with iodobenzene.

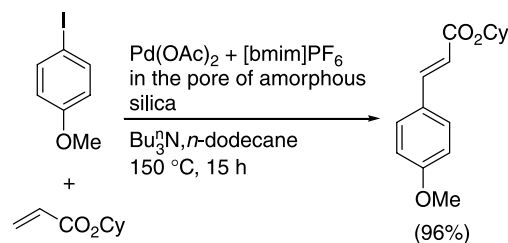

Scheme 39.

Recently, palladium nanoparticles were generated from $\text{Pd}(\text{PPh}_3)_4$ in a mixture of tetra(ethylene glycol) and tetramethoxysilane, followed by encapsulation in a silica matrix by treatment with water. The only reported application to the Heck reaction was for the coupling of methyl *p*-iodobenzoate with styrene using 0.75 mol% catalyst and NaOAc , in DMF at 120 °C for 17 h, leading to the expected product in 80% yield. The possible re-usability of the catalyst in the Heck reaction was not tested.¹⁵⁰

Besides silica, other metal oxides and inorganic compounds have proved to be useful supports for palladium in Heck reactions.¹⁵¹ Iyer et al. studied the activity of Ni/Al₂O₃, Ni/HY-zeolite, Cu/Al₂O₃ and Co/Al₂O₃ in the reaction of aryl iodides (RC₆H₄I, R=MeO, Cl, NO₂) with styrene, ethyl acrylate and ethyl methacrylate in the presence of K₂CO₃ in NMP at 150 °C for 5–48 h.¹⁵² With few exceptions, the behaviour of all catalysts was quite similar, giving a variable yield of products. The reaction temperature was rather high, taking into account that only iodides could be activated, none of the catalysts being able to activate aryl bromides or chlorides. A considerable amount of the heterogeneous catalyst underwent leaching under the reaction conditions, with a consequent loss in activity in the recycling.

Köhler et al. carried out a detailed study on the coupling of aryl bromides with olefins catalysed by palladium supported on various metal oxides.¹⁵³ In this case, all the supports were commercially available or easily prepared and fixation of palladium to the oxide support was easily accomplished by hydrogen reduction of a Pd(acac)₂ solution in the presence of the support, followed by thermal treatment. The yields of the coupled products varied from low to excellent, depending upon the substituents in the starting materials, the selectivity being high in all cases (Scheme 40). The alkenes, butyl acrylate and (the uncommon) ethylene, could also be converted, although with lower yields than for styrene. Roughly, the order of activity followed the trend TiO₂ > ZrO₂ > MgO > ZnO > SiO₂. The catalysts could be recycled and reused without loss of activity. According to the authors, there were some indications of a heterogeneous reaction mechanism, but, the participation of resolved palladium species (colloids or complexes) was not excluded. In fact, this group has recently brought out clear experimental evidence for the correlation between the dissolution of palladium from the supported catalyst surface and the reaction rate.¹⁵⁴

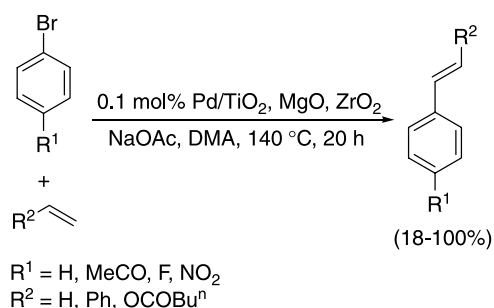

Scheme 40.

The above-mentioned oxides, together with a variety of zeolites and carbon, were used as supports in the palladium-catalysed Heck arylation of cyclohexene and cyclopentene with 4-bromoacetophenone at 120–140 °C for 20 h.¹⁵⁵ In general, almost all catalysts gave mixtures of the three possible regioisomers, although less hydrodehalogenation was observed for the zeolite-entrapped molecular palladium species than for the supported Pd(0) particles. The former catalyst also prevented double arylation, probably due to shape selectivity. Certainly, this thorough research is

interesting from a comparative and mechanistic point of view, and involves some less well-studied olefins. The generally moderate to low regioselectivity, however, and the predictable difficulties in separating the regioisomers make any of these methodologies of little practical application.

A 5% Pd/MgO catalyst was shown to be superior to Pd/γ-Al₂O₃ and Pd/C in the Heck arylation of acrylonitrile with iodobenzene.¹⁵⁶ Cinnamionitrile was the major product in an acetonitrile medium with Pd(acac)₂ and Pd/MgO catalysts in impregnated and reduced forms. 3,3-Diphenylacrylonitrile was formed as a minor product, although, very interestingly, it turned out to be the major product by changing the solvent to methanol. On the other hand, Pd/Al₂O₃ was very active catalyst in the Heck reaction of 4-chloroacetophenone with *n*-butyl acrylate in DMA at 120 °C for 3 h (Scheme 41).¹⁵⁷ The high amount of leached palladium (79%) was utilised in additional tests exhibiting practically the same activity as in the original catalyst, and this representing strong evidence that heterogeneous palladium metal catalysts employed for Heck reactions are mainly sources of soluble palladium(II) complexes, which are the actual catalytic species.¹⁵⁸

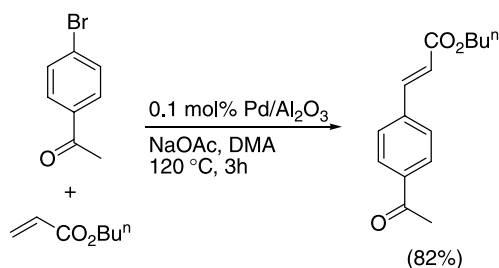

Scheme 41.

Chang et al. observed that the supported zerovalent ruthenium catalyst Ru/Al₂O₃ was superior to the homogeneous precursor [RuCl₂(*p*-cymene)]₂ in the Heck olefination of aryl iodides and an alkenyl bromide (Scheme 42).¹⁵⁹ In fact, the immobilised species displayed a wider substrate scope and higher selectivity, even under milder reaction conditions, what was related to catalysis by ruthenium colloids of the zero oxidation state. The supported catalyst was quantitatively recovered at the end of the reaction by simple centrifugation and could be re-used for an additional three runs with constant reactivity. Ruthenium leaching from the support was negligible.

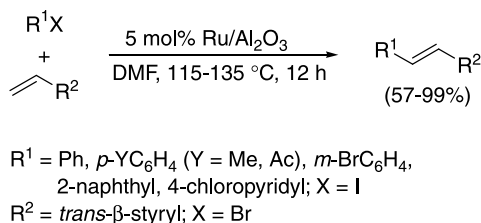

Scheme 42.

Villemin et al. prepared a palladium complex supported on zirconium phosphite–phosphonate from triphenylphosphane–phosphonic acid.¹⁶⁰ The phosphonic acid was

complexed with palladium(II) chloride, treated with zirconium chloride octahydrate (heated for 3 days), and reduced to palladium(0) with triethylsilane to give the supported catalyst. This catalyst exhibited a high activity in the coupling of iodobenzene and methyl acrylate under relatively mild reaction conditions (Scheme 43). Unfortunately, the catalyst was oxygen sensitive and had to be kept under an inert atmosphere in order to avoid deactivation and maintain its high activity over several runs.

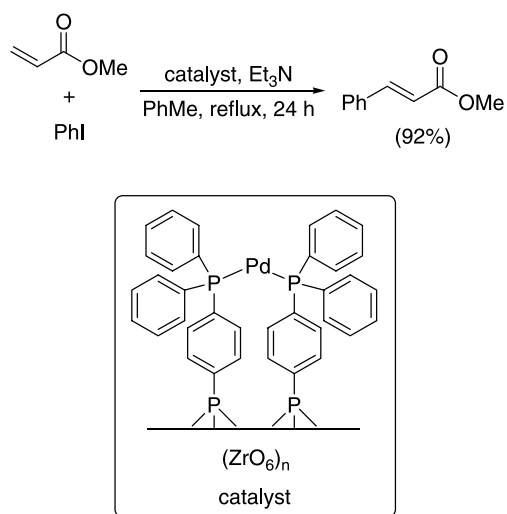

Scheme 43.

A hydroxyapatite-supported palladium complex was obtained by treatment of the non-stoichiometric Ca-deficient hydroxyapatite Ca₉(HPO₄)(PO₄)₅(OH) with an acetone solution of PdCl₂(PhCN)₂.¹⁶¹ This catalyst exhibited a remarkable activity in the Heck reaction of aryl bromides with olefins, high TONs and excellent yields being obtained independently of the electronic character of the substituents (Scheme 44). The fact that no palladium leaching was observed indicated that the reaction proceeded on the Pd/hydroxyapatite surface and not with dissolved palladium species. Additional experiments seemed to support this Heck reaction not proceeding via the traditional Pd⁰/Pd^{II} cycle, but via the Pd^{II}/Pd^{IV} mechanism. The hydroxyapatite, although not commercially available, was easily prepared by a precipitation method from Ca(NO₃)₂·4H₂O and (NH₄)₂HPO₄, the only limitation of this methodology being that the reactions must be performed in an argon atmosphere.

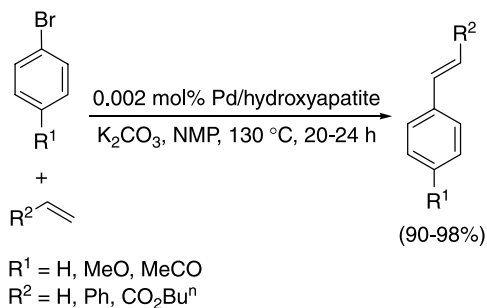

Scheme 44.

Various palladium-containing Mg–Al hydrotalcites were synthesised from the soluble metal salts by the coprecipitation method, and were applied to the Heck reaction of aryl iodides and bromides with styrenes and methyl acrylate.¹⁶² Reactions with aryl iodides proceeded in the presence of a 4% Pd loading and Et₃N in DMF at 120 °C for 5–20 h (59–88% yield). The less reactive aryl bromides required a higher temperature (150 °C) and catalyst loading in the presence of K₂CO₃ in NMP. The catalyst was recycled in the case of iodobenzene and methyl acrylate without any treatment, but some decrease in the yield was observed.

A very interesting study must be highlighted carried out by the group of Choudary et al., who prepared a layered double hydroxide (LDH)-supported nanopalladium catalyst as a unique and highly effective catalyst for the Heck reaction of chloroarenes and olefins.¹⁶³ The reactions were conducted in TBAB as the solvent, in place of the most commonly used NMP, at 130 °C. The products were obtained with excellent yields and >99% trans-selectivity, albeit requiring relatively long reaction times. The duration of the experiments was, however, dramatically reduced under microwave conditions from 10–40 to 0.5–1 h without affecting the yields and selectivity (Scheme 45). The activity of the Pd/LDH was demonstrated to be higher than that of Pd/C, Pd/Al₂O₃ and Pd/SiO₂, the basicity of the support facilitating the oxidative addition of palladium(0) to the starting aryl chloride. As in the above example, the heterogeneity studies disclosed that the reaction occurred at the heterogeneous surface of the nanopalladium particle. In spite of the support not being commercially available and the higher catalyst loading, its recovery by simple filtration and re-use with consistent activity makes it a prime choice for the high-performance coupling of chloroarenes and olefins. LDH-supported Pd(TPPTS)₂Cl₂ was also successfully used in the Heck arylation of olefins with bromo- and iodobenzenes in the presence of Et₃N in DMF at 120 °C under a nitrogen atmosphere.¹⁶⁴ The re-usability of this catalyst for five cycles was excellent.

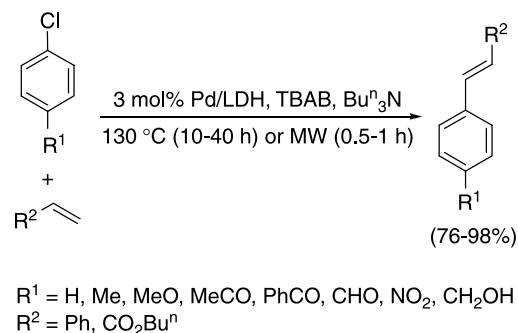

Scheme 45.

Recently, a study of the preparation of 3 mol% Cu-, Ni- and Pd- containing silicoaluminophosphate-31 (SAPO-31) materials and their catalytic activity in the coupling of iodobenzene and aryl chlorides with several styrenes and acrylates has been reported.¹⁶⁵ The Ni and Cu catalysts exhibited a lower activity than the Pd catalyst, the latter giving complete conversion of iodobenzene in the Heck

coupling reaction with methyl acrylate after 1.5 h in DMF and K_2CO_3 at 120 °C. More interesting was the activity shown by the Pd catalyst for chlorobenzenes, although long reaction times and the presence of electron-withdrawing groups were needed in order to achieve good aryl chloride conversions (Scheme 46). A phenomenon of palladium leaching and redeposition was observed and the Pd-SAPO-31 catalyst could be recovered by filtration and recycled three times without significant loss in activity. This catalyst was found to be more active and efficient than other heterogeneous catalysts such as Pd/C, Pd/graphite, Pd/MgO, or Pd/Al₂O₃.

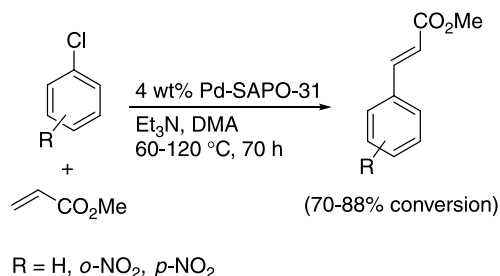

Scheme 46.

Natural and alkali-exchanged sepiolites containing PdCl₂ behaved as bifunctional catalysts in the Heck reaction of iodobenzene and bromobenzene with styrene in *o*-xylene at 145 °C for 24 h in the absence of base.¹⁶⁶ Only iodobenzene gave good yields, but, a considerable decrease in activity was observed in a second cycle after filtration. This decrease in activity could be due to the deactivation of the metal or to the consumption of the basic sites.

Arisawa et al. prepared a palladium catalyst on sulphur-terminated GaAs(001), using an ammonium sulfide solution followed by the adsorption of Pd(PPh₃)₄ at 100 °C.¹⁶⁷ This novel catalyst was applied only to the coupling of iodobenzene and methyl acrylate with Et₃N as a base in MeCN at 100 °C for 12 h. Repeated use of the catalyst resulted in a decrease in its catalytic activity (93–57% after five runs), which could be restored in part by further treatment with a Pd(PPh₃)₄ solution (89–30% after ten runs).

5.2.3. Clays, zeolites and molecular sieves. Clay minerals consist of layered silicates which occur abundantly in nature and their high surface area, sorptive and ion-exchange properties have been exploited for catalytic applications for decades. In particular, clay-supported reagents and catalysts have found application in a wide range of organic transformations,^{21c} although very little utility in carbon-carbon coupling reactions.

The group of Choudary was one of the pioneers in the application of clays to the Heck reaction in the early 1990s. This group discovered that a montmorillonite-ethylsilyldiphenylphosphane-palladium(II) chloride complex was a highly active and stereoselective heterogenised homogeneous catalyst for the arylation of stilbene and acrylates with iodobenzene in Bu₃N at 100 °C for 2–8 h.¹⁶⁸ The coupled products were obtained in excellent yields (90–98%) and with near-quantitative *trans*-selectivity. In

addition, the clay-anchored catalyst could be recycled four times with very little deactivation (98–92% yield). The performance of this catalytic system has subsequently been difficult to equal.

More recently, Varma et al. prepared a palladium(II) chloride and tetraphenylphosphonium bromide intercalated clay by simply refluxing (48 h) the sodium-exchanged clay with a PdCl₂ solution and tetraphenylphosphonium bromide, filtration, washing and drying at 100–110 °C overnight.¹⁶⁹ The catalyst gave excellent yields in the coupling at 140 °C of aryl bromides and iodides with styrenes bearing either electron-withdrawing or electron-releasing substituents (Scheme 47). The re-use of the catalyst without loss in activity and the faster reactivity, when compared to the corresponding homogeneous reaction conditions, makes this a useful and attractive protocol.

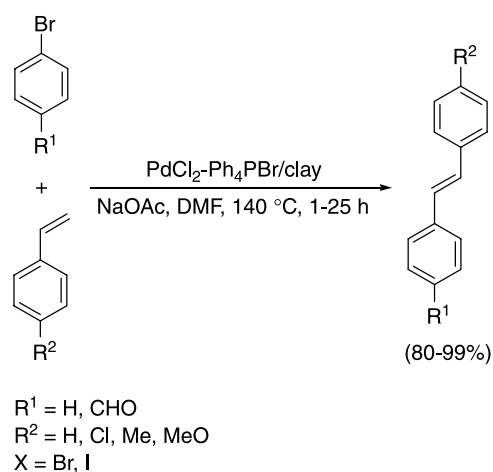

Scheme 47.

A variation of the Heck reaction was introduced by Rigo et al. involving the reaction of different anilines with vinyl acetate, catalysed by palladium(II) chloride- and copper(II) nitrate-intercalated montmorillonite K10 (MK10) clay.¹⁷⁰ The corresponding methyl cinnamates were obtained in fair yields, without the formation of by-products (Scheme 48). The catalyst was easily prepared by exchanging the clay with dilute aqueous PdCl₂ and Cu(NO₃)₂ at room temperature for 24 h, followed by washing and drying at 110 °C for 12 h, and could be re-used without losing its activity. This catalyst had already demonstrated activity in the vinylation of aryl halides, mainly iodides.¹⁷¹ With

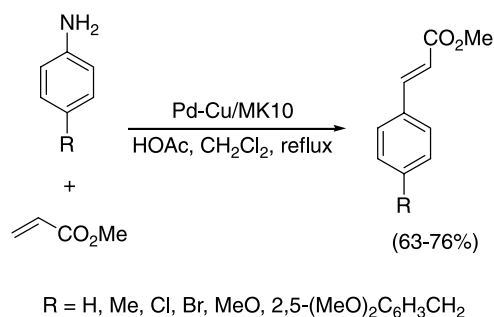

Scheme 48.

respect to the aryl iodides, however, anilines are more readily available and, consequently cheaper, which together with the absence of adding base, makes this an interesting alternative for the larger-scale applications of the Heck vinylation of substituted aromatics.

A series of bis-carbene-pincer complexes of palladium(II) have been immobilised on montmorillonite K10 and utilised in a standard Heck reaction (Scheme 49).¹⁷² The supported catalyst, obtained by the solvent impregnation method, showed a catalytic activity similar to that of its homogeneous counterparts. The leaching observed was practically negligible and, consequently, the catalyst could be recycled up to ten times, without significant loss of activity. The same catalytic system was applied to the more unreactive aryl halides, bromobenzene and 4-bromobenzaldehyde, yielding very high conversions in the presence of TBAB, but 4-chlorobenzaldehyde gave only 15% of the expected coupled product.

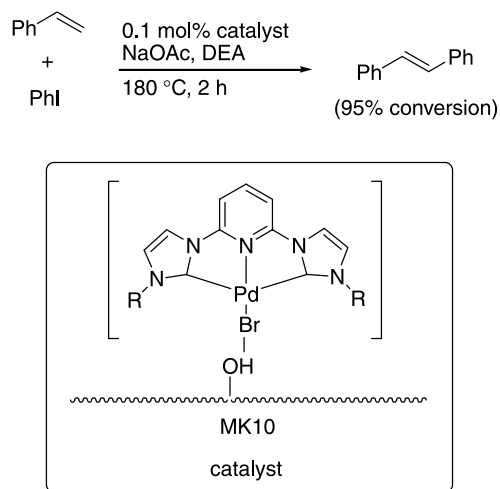

Scheme 49.

The group of Djakovitch has studied in detail the capability of palladium complex-loaded zeolites of catalysing the Heck reaction of aryl bromides with olefins, using standard reaction conditions. The high activity exhibited by these palladium-modified zeolites has been recently reviewed.^{21b} Summarising the characteristics of these catalysts, it may be stated that the most studied NaY zeolites utilise low amounts of palladium (0.1 mol%), which can be easily separated and re-used after washing. In general, no remarkable palladium leaching was observed, the stability of the palladium active species against leaching apparently being correlated with the temperature of decomposition of the immobilised palladium complexes in the zeolite cages. It is worthy of note that even aryl chlorides can be directly activated by this type of catalyst, which is an additional advantage, besides that of the simple preparation of the palladium loaded zeolites.

Mordenite is one of the rarer, but still somewhat more widespread, members of the zeolite group of minerals. More specifically, it is a hydrated calcium sodium potassium aluminium silicate. $\text{Pd}(\text{NH}_3)_4^{2+}$ /mordenite and $\text{Pd}(0)$ /mordenite behaved as truly heterogeneous catalysts in the

Heck reaction of iodobenzene and aryl bromides with styrene and acrylates, using Bu_3N as a base in toluene at $130\text{ }^\circ\text{C}$.¹⁷³ The best results were obtained for the coupling of iodobenzene with *n*-butyl acrylate, the other examples furnishing low to moderate conversions with rather long reaction times. The possibility of catalyst re-use was not tested. An in-depth study included the reaction of 4-bromoacetophenone and *n*-butyl acrylate under the above conditions.¹⁷⁴ Despite the conversions still being low, a continuous Heck experiment was designed to obtain 3.5 g product per g Pd and per h with hardly detectable palladium leaching.

Djakovitch et al. described the Heck arylation of acrylic compounds, including the little-studied acrolein, using the homogeneous Herrmann's palladacycle and the zeolite-supported palladium catalyst $[\text{Pd}(\text{NH}_3)_4]^{2+}\text{-NaY}$.¹⁷⁵ In general, better conversions and yields were obtained with the palladacycle, although the supported catalyst was more specific for the monoarylation reactions (Scheme 50). At any rate, lower yields were observed for acrolein and acrylamide than for *n*-butyl acrylate for both catalysts.

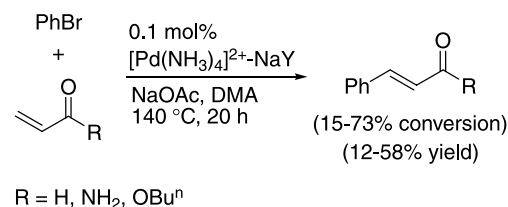

Scheme 50.

García et al. reported the preparation of K^+ - and Cs^+ -exchanged X zeolites containing PdCl_2 , which behaved as bifunctional catalysts in the Heck reaction of iodo- and bromobenzene with styrene.¹⁷⁶ The reactions were performed in toluene or polymethylbenzenes at reflux without any extrinsic base, due to the basic character of these zeolites. The reaction of PhI and styrene produced variable amounts of 1,1-diphenylethene in all cases, $\text{PdCl}_2\text{-CsX}$ giving predominantly 1,1-diphenylethene. On the other hand, the reaction of PhBr and styrene in the presence of $\text{PdCl}_2\text{-KX}$ provided 97% stilbene with a long reaction time (72 h) (Scheme 51). Although no leaching of palladium was observed, the activity of the basic zeolites decreased after the second use, albeit a notable recovery of the activity being achieved by washing the zeolites with KOH or CsOH solutions. When methyl acrylate was used instead of styrene, the PhI conversion was not complete, due to partial polymerisation of methyl acrylate under the reaction conditions.

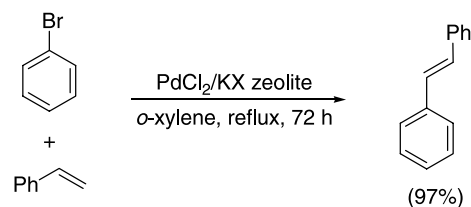

Scheme 51.

Platinum and palladium nanoparticles bound at high surface coverage on (3-aminopropyl)trimethoxysilane NaY zeolites catalysed the Heck arylation of iodobenzene with styrene in the presence of Et₃N in DMA at 120 °C for 2 h.¹⁷⁷ High conversions (~95%) were achieved, even after filtration of the catalyst in a third cycle. The stereoselectivity was low, however, giving about a 10:90 cis–trans ratio. The palladium nanoparticles were shown to be firmly bound to the zeolite support, predominantly through the amine groups, preventing leaching during the different reactions.

Mesoporous molecular sieves (MCM-41) are also of particular interest for catalysis involving bulky substrates because of their large pore sizes (> 20 Å) and they have been a challenge for zeolitic materials, due to their pore-opening restrictions (4–12 Å).^{21b} In the context of the application of these materials in the Heck reaction, Ying et al. synthesised a palladium-grafted mesoporous material that utilised mesoporous Nb-MCM-41 as the support framework for the deposition of the catalytically active species.¹⁷⁸ A vapour-grafting method followed by reduction was employed for the preparation of the active catalyst, which, in addition, was silanised to reduce the palladium content, while maintaining a uniform palladium distribution. The new material Pd-TMS11 catalysed the Heck reaction of activated and non-activated aryl bromides with styrene and *n*-butyl acrylate in air at 120–170 °C. The activated aryl bromides reacted rapidly (20 min–8 h) and with excellent conversions and yields, whilst bromobenzene and chlorobenzene led to lower conversions (16–67%) with longer reaction times (32–48 h), the selectivity being remarkably high in all cases. A selected example is depicted in Scheme 52. These studies revealed a reaction mechanism based on a heterogeneous catalytic cycle. The main drawbacks of this methodology are the rather complex preparation of the active catalyst, the use of the expensive niobium(V) ethoxide, the removal of the high-boiling-point solvents, dodecane and DMA and the agglomeration of palladium and partial structural damage of the Nb-MCM-41 support shown after filtration.

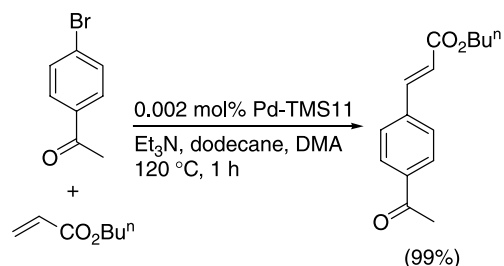

Scheme 52.

A new MCM-41-supported aminopropylsiloxane-palladium(0) complex was prepared by Zhou et al., which was a highly active and stereoselective catalyst for the Heck reaction of aryl iodides and conjugated olefins.¹⁷⁹ The catalyst was easily prepared from the MCM-41-supported aminopropylsiloxane and PdCl₂ in EtOH, followed by reduction with NaBH₄. The corresponding products were obtained exclusively with trans stereochemistry and in high yields after 2–5 h at 70 °C (Scheme 53). Unfortunately, the catalyst was not effective with bromo- and chlorobenzene.

Concerning its re-use, a 1–3% decrease in yield was observed after each recycle. A very similar behaviour was observed for an MCM-41 supported aminopropylsiloxane-palladium acetate catalyst.¹⁸⁰

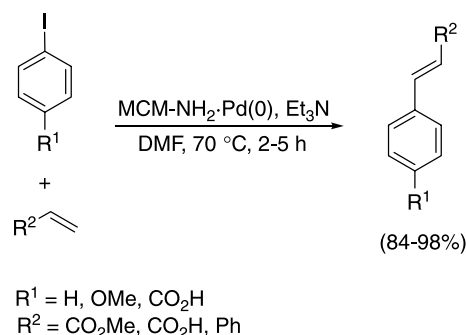

Scheme 53.

A C-metallated palladacycle, prepared in the pores of (3-hydroxypropyl)triethoxysilane-functionalised MCM-41 has recently found application in the coupling of bromobenzene and styrene.¹⁸¹ Four steps were used for the preparation of the catalyst, the final of which involved palladation of the hydroxypropyl moiety of the MCM-41 with Li₂PdCl₄ and NaOAc in MeOH under reflux for 2 days. The highest conversion in the Heck reaction (90%) was achieved at 160 °C for 5 h with K₂CO₃ in NMP (Scheme 54), which was much superior (but proceeded at a higher temperature) to that achieved with the Pd-TMS11 catalyst described above. Unfortunately, little can be said about the scope of the reaction, since no other starting materials have been studied.

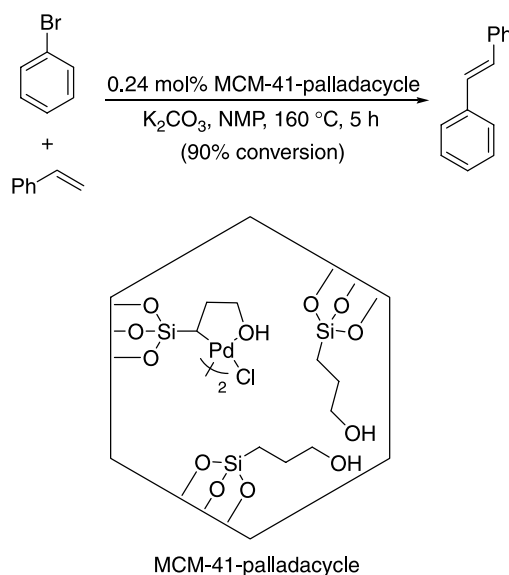

Scheme 54.

Many other research groups have recently focussed their attention on the development of new palladium(II) complexes anchored on MCM-41, with the aim of obtaining efficient and recyclable catalysts for the Heck reaction. Iglesias et al. prepared various catalysts of the type 9 (Chart 2), which were applied to the coupling of

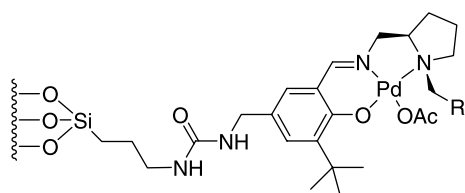

R = Ph, 1-naphthyl, 2-naphthyl

9

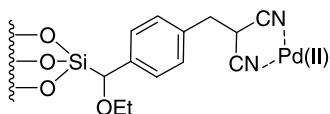

10

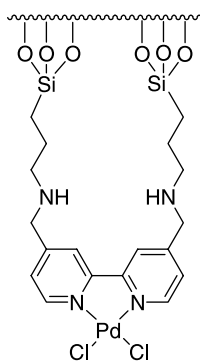

11

Chart 2.

iodobenzene with α -methylstyrene and two acrylates in a biphasic mode (ethylene glycol–toluene) with KOAc at 140 °C for 24 h.¹⁸² Despite the fact that the catalyst was air and moisture stable, and that it could be recycled (by separation of the ethylene glycol phase) at least six times without apparent loss of activity, the conversions were low (10–64%). In addition, the catalysts and their preparation were rather sophisticated. The dicyano-functionalised MCM-41-anchored palladium complex **10** demonstrated a good catalytic activity towards the vinylation of aryl iodides and bromides with methyl acrylate, in the presence of Et₃N and DMF for 4–8 h at 70–120 °C.¹⁸³ Exclusive formation of the trans products was achieved in 87–92% yield, the activity being constant through four cycles, due to the very little palladium leaching observed. The palladium-bipyridyl complex **11**, anchored inside the channels of nanosized MCM-41, exhibited a generally good performance in the Heck reaction of aryl iodides and bromides with styrene and alkyl acrylates,¹⁸⁴ most of the yields ranging from 70 to 98% by using Bu₃N in NMP at 100–170 °C for 16–96 h. The catalytic activity remained intact after four re-use runs. High TONs were reached in most cases (up to 10⁶ for each cycle), although the aryl bromide activation required harsher reaction conditions and the coupling with styrene was not completely stereoselective (~90:10 cis–trans).

A palladium-loaded ETS-10 molecular sieve exhibited good activity and selectivity towards the carbon–carbon coupling of aryl halides with olefins at low concentrations of Pd (0.009–1.4 mol%). In the case of the coupling of ethyl

acrylate with iodobenzene, 96% conversion of iodobenzene with >98% selectivity could be obtained within 1 h over a 0.2 wt% Pd-loaded catalyst. The catalyst activated both aryl bromides and chlorides, and appeared to be heterogeneous.¹⁸⁵

5.2.4. Polymers. In the introductory section, we have already highlighted the ongoing interest in immobilising palladium on polymeric supports in organic synthesis and, in particular, in carbon–carbon coupling reactions.¹⁹ The Heck reaction using polystyrene-bound phosphanes was pioneered by Teranishi et al.¹⁸⁶ and studied in detail by Andersson et al. in the mid-1980s.¹⁸⁷ It is also worthwhile mentioning that Zhang et al. developed in the late-1980s a [poly(styryl)phenanthroline]palladium(0) catalyst that exhibited a high activity in the Heck reaction of olefins with substituted iodobenzenes and that could be recycled up to ten times with no decrease in activity.¹⁸⁸

An interesting publication by Fox et al. appeared in 1994 comparing the catalytic efficiency of monomeric and polystyrene-supported 1,2-bis(diisopropylphosphino)benzene-palladium(II) in the Heck reaction.¹⁸⁹ The coupling of iodobenzene and methyl acrylate was used as a model reaction (Scheme 55), which led to the following conclusions in favour of the palladium-supported version: (a) the polymer-supported palladium(II) complex showed a higher activity than the analogous monomeric complex, (b) the products were easily separated from the heterogeneous catalyst by simple filtration and (c) the recycled polymer-supported complex was stable to air and retained its original catalytic activity after many turnovers.

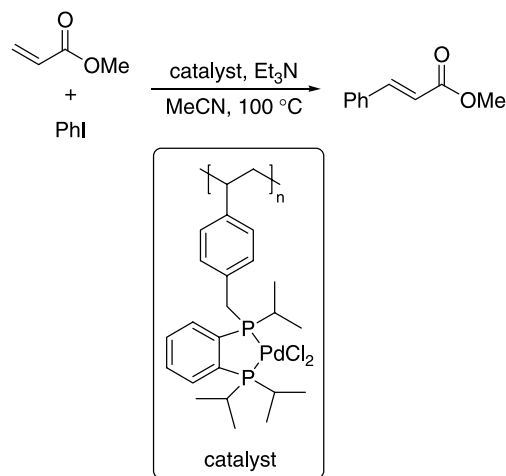

Scheme 55.

More recently, Uozumi et al. developed an amphiphilic polystyrene-poly(ethylene glycol) resin-supported palladium–phosphane complex that exhibited a very high performance in the Heck reaction of aryl iodides and olefins in water.¹⁹⁰ A wide array of electronically different aryl iodides and alkenes were tested under very mild reaction conditions (25–80 °C), most of the yields being >92% (Scheme 56). Bromobenzene showed a lower reactivity (52%), even at 80 °C. Although the palladium loading was high (10 mol%), recyclability of the catalyst was successful, leading to a 92% average yield after five continuous runs.

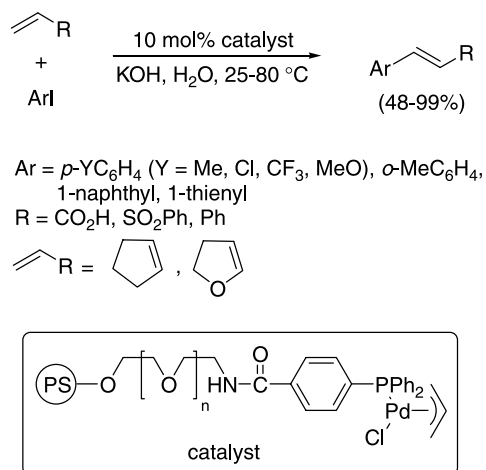

Scheme 56.

Bergbreiter et al. synthesised various pincer-type SCS ligands that were attached to soluble poly(ethylene glycol) via ether or amide linkages. Both the PEG-bound 5-oxo (**12**) and 5-amido (**13**) palladium complexes were active as catalysts in the Heck reaction of aryl iodides and acceptor alkenes in DMF and air at 110 °C for 5–6 h using 0.1 mol% of catalyst (71–99% product yield) (Chart 3).¹⁹¹ Catalyst **12**, however, slowly decomposed, leading to a black precipitate of palladium that precluded the possibility of recycling. In contrast, the PEG-bound 5-amido-SCS-Pd complex **13** was recycled three times via solvent precipitation (in diethyl ether) with no observed catalyst deactivation. Perhaps the main inconvenience of this methodology is the large number of steps needed for the synthesis of the catalysts, although the yields are generally high. Based on this methodology, different thiol pincer groups attached to four different resins were complexed with palladium and their performance tested in the coupling of 4-bromoacetophenone with styrene.¹⁹² The best conversion (88%) was obtained for the cyclohexyl-bearing thiol pincer ligand bound to polystyrene in a dioxane-NaOAc system.

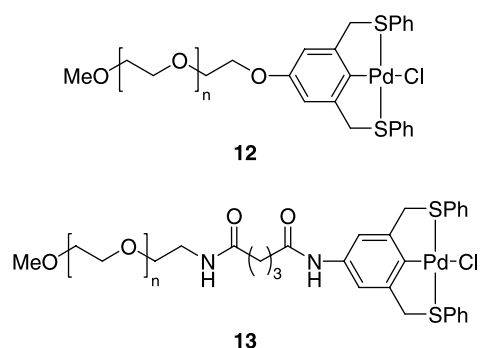

Chart 3.

Bergbreiter's group studied a new technique of product isolation and catalyst recovery, based on liquid–liquid biphasic systems that exhibit an increase in phase miscibility at elevated temperature, together with soluble polymer-bound catalysts that have a strong phase preference at ambient temperature. The catalysis in this type of system was termed thermomorphic catalysis. The Heck reactions of aryl iodides and olefins were conducted in the presence of a

poly(*N*-isopropylacrylamide) (PNIPAM)-bound phosphane or a polymer-supported tridentate SCS-Pd catalyst,¹⁹³ for example, using 2 mol% (PNIPAM-PPh₂)₄Pd(0) (**14**) and Et₃N in heptane-90% aqueous EtOH, iodobenzene and *tert*-butyl acrylate completely reacted within 48 h at 70 °C (Chart 4). The system was allowed to cool to room temperature to induce phase separation. Removal of the heptane phase and solvent evaporation furnished the expected product in 71% yield. Catalyst recycling was achieved by adding a fresh heptane solution of the reactants and reheating the system to 70 °C for an additional 48 h. Interestingly, the yields increased in each cycle, becoming virtually quantitative after the third cycle. This catalyst was, however, air sensitive. The recyclability and application of catalyst **14** in aqueous or aqueous-organic media were confirmed by other workers.¹⁹⁴ A DMA-heptane system was used for the thermomorphic catalysis with the PNIPAM-bound methyl red dye **15** (2 mol%) (Chart 4). In this case, complete conversion in the reaction between iodobenzene and styrene was observed after 48 h at 90 °C. Catalyst **13** (0.2 mol%) was also shown to be effective in coupling various aryl iodides and alkenes in a DMA-heptane system at 95 °C with Et₃N, with the advantage of being an air-stable catalyst. A similar performance to catalyst **13** was observed for catalyst **16** (Chart 4).

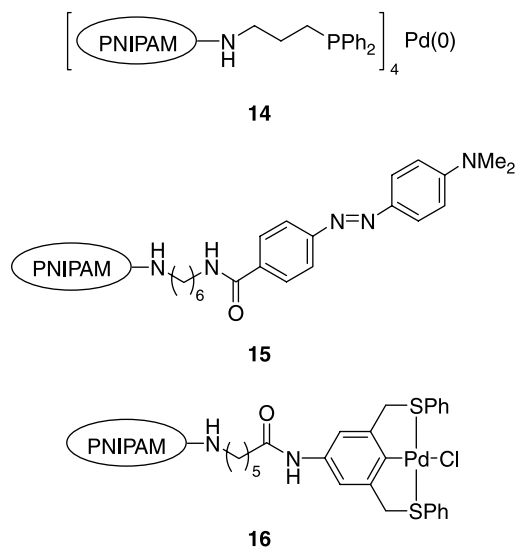

Chart 4.

By changing the *N*-alkyl group in PNIPAM to the more lipophilic octadecyl, the polymer solubility was inverted so that it selectively dissolved in the non-polar phase of a biphasic mixture, but stayed in solution at elevated temperature (inverse thermomorphic separation).¹⁹⁵ Thus, poly(*N*-octadecyl-acrylamide-*co*-*N*-acryloxysuccinimide) was prepared and modified to support an air- and heat-stable SCS-Pd(II) Heck catalyst **17** (Chart 5). This polymer-bound catalyst was active in a thermomorphic heptane-DMA mixture at 110 °C, its activity being comparable to that of the PNIPAM-bound SCS-Pd(II) catalyst **16**. In fact, it was used for up to nine cycles in the formation of cinnamic acid from iodobenzene and acrylic acid, showing a 90% conversion in the ninth cycle at 24 h. The palladacycles **18**, derived from an azo dye ligand coupled to either a

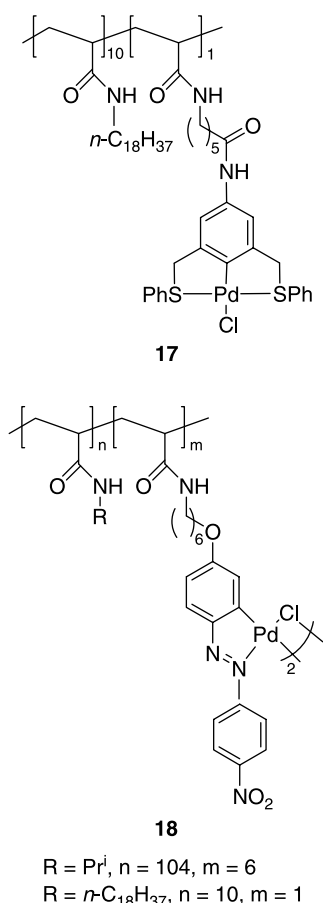

Chart 5.

poly(*N*-isopropylacrylamide) or a poly(*N*-octadecylacrylamide), were also active Heck catalysts (Chart 5).¹⁹⁶ While the polymer recovery was very high (>99.9%) and easily assayed by UV spectroscopy, however, a small amount of catalyst decomposition was observed, making these palladacycles less suitable than the above-described catalysts.

Herrmann et al. attached palladium(II) complexes of *N*-heterocyclic carbenes to polystyrene-based Wang resins through ether linkages (Chart 6).¹⁹⁷ The catalysts **19** exhibited a high activity in the coupling of aryl bromides with styrene and *n*-butyl acrylate. Full conversions were obtained for *p*-bromoacetophenone after 15 h with a low catalyst loading (0.02–0.15 mol%). Even deactivated bromobenzenes bearing electron-donating groups were converted with TONs of 10³–10⁴. When styrene was employed as the vinylic substrate, however, the conversions were lower and substantial amounts of isomeric compounds were obtained. Unfortunately, chlorobenzenes did not react, even under harsh reaction conditions. Despite the fact that catalyst preparation was not straightforward (even the starting *N,N'*-diimidazolylmethane had to be synthesised), the catalyst was used 15 times without a detectable loss of activity and was not sensitive to air and moisture. In contrast, catalyst **20** was readily prepared in two steps from commercially available aminomethyl-functionalised polystyrene beads and its activity studied in the coupling reaction of iodobenzene and styrene in NMP with Pr₃N as a base at 100–140 °C.¹⁹⁸ This catalyst showed a comparable

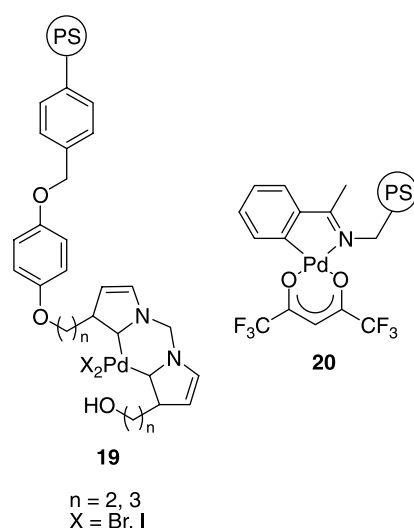

Chart 6.

level of activity in the first run (140 °C, 11 h, 100% yield, TON 15625) to that of some homogeneous analogues. It proved, however, to be completely inactive in a consecutive run. This provided evidence about the soluble character of the catalytically active species, which must be formed under loss of the ligand. In fact, **20** proved to be thermally labile to such an extent that even moderate heating during the synthesis of the palladacycle caused precipitation of some palladium black.

A PS-supported palladium catalyst (PS-C₆H₄CH₂PPh₂...[Pd]) was also applied in intramolecular Heck reactions after RCM of a series of *N*-alkenyl-*N*-allyl-2-bromo(or iodo)benzenesulfonamides. The corresponding bridged ring systems were obtained in 40–69% yield after treatment of the RCM products with 10% mol PS-bound palladium catalyst and 2 equiv of Ti₂CO₃ in toluene at 110 °C for 16 h.¹⁹⁹ Despite the attractiveness of this cascade process, the use of 2 equiv of Ti₂CO₃ is a clear disadvantage, due to its high toxicity (mutagen and reproductive effector).

A β-ketoesterato polymeric palladium complex, obtained by co-polymerisation of Pd(AAEMA)₂ [AAEMA is the deprotonated form of 2-(acetoacetoxy)ethyl methacrylate] with ethyl methacrylate and ethylene glycol dimethacrylate, was also active in the Heck reaction of activated and non-activated iodo- and bromoarenes with styrene, acrylonitrile and methyl acrylate.²⁰⁰ The reactions with aryl iodides were performed with KOAc in DMF at 90 °C for 2–6 h, giving high yields of products, but moderate trans-selectivity. In the case of aryl bromides with styrene, the reactions were carried out at 160 °C in the presence of DMG for 10–12 h, the yields also being high with improved trans-selectivity. A negligible loss of activity was observed after five recycles of the catalyst.

A palladium complex of a pendant cyclophosphazene-containing cross-linked polymer was synthesised by Chandrasekhar et al. by reacting hexachlorocyclotriphosphazene with 1 equiv of 4-hydroxy-4'-vinylbiphenyl, followed by reaction with 5 equiv of *p*-diphenylphosphinophenol, copolymerisation with divinylbenzene,

palladium complexation and final reduction.²⁰¹ This polymer-supported catalyst was successfully used in the coupling reaction of iodobenzene with several olefins, giving the expected products with exclusive trans stereochemistry (Scheme 57). Slightly longer reaction times were needed in comparison with the monomeric catalyst and bromobenzene did not react. It is worthy of note that even the 1,1-disubstituted olefin, methyl methacrylate, reacted stereoselectively and in good yield (79%). The recovered catalyst tested in three successive cycles maintained almost the original activity, which was in agreement with the fact that the reaction took place due to the polymeric catalyst and not to the leached palladium species.

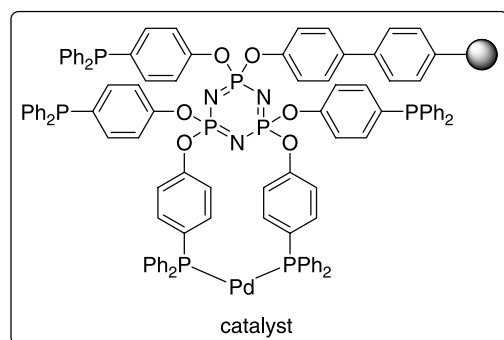
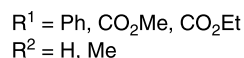
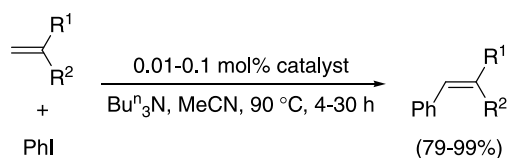

Scheme 57.

The structures in Chart 7 were both obtained by a ring-opening ROMP metathesis polymerisation strategy of norbornene derivatives. The synthesis of ligand **21** was achieved in four steps from *p*-benzoquinone and was applied to the Heck reaction of iodobenzene and methyl acrylate in the presence of Pd(OAc)₂ (5 mol%) and TBAA in DMF at 80 °C for 12 h (95% yield).²⁰² A 10% decrease in yield was observed after five catalytic cycles. The preparation of complex **22** was not so straightforward, since even the starting bis(pyrimid-2-yl)amine had to be prepared by palladium-catalysed amination of 2-chloropyrimidine.²⁰³ This catalyst, however, showed a high activity in the coupling of activated 4-bromobenzonitrile and 4-chloroacetophenone with styrene (DMA, Bu₃N, 150 °C, 72 h) to afford 4-cyanostilbene and 4-acetylstilbene in 98 and 70% isolated yields, respectively. The addition of TBAB was needed for the effective coupling of the aryl chloride.

More recently, Portnoy et al. have prepared representative members of five different families of supported phosphane and phosphinite ligands from common polymer-bound aminoalcohols.²⁰⁴ These include β-aminophosphines, *N*,β-diphosphinoamines, α,β-diphosphinoamines, β-amino-phosphinites and *N*-phosphino-β-aminophosphinites. The

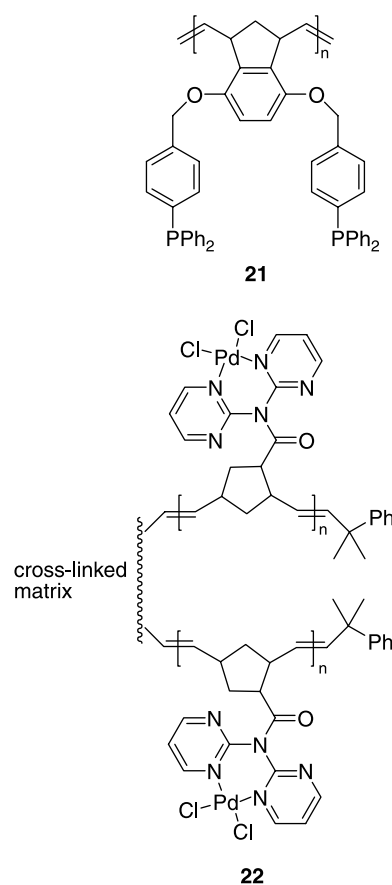

Chart 7.

ligands were complexed with Pd(OAc)₂ and tested in the Heck reaction of iodo- and bromobenzene with methyl acrylate in the presence of Et₃N in NMP at 110 °C for 18 h. All ligands furnished equally high yields (90%) in the Heck reaction of iodobenzene. Low to moderate conversions (8–63%) and yields (1–56%) were, however, obtained in the reaction with bromobenzene, showing clear differences in the activity of the various ligands tested.

A polymer (fibre)-supported palladium catalyst containing imidazolyl rings was synthesised easily from commercially available polyacrylonitrile fibre.²⁰⁵ The catalyst (0.01 mol%) was successfully used in the Heck reaction of iodobenzene with different alkyl acrylates in the presence of Et₃N in dioxane at 100 °C for 1–2 h (94–97% yield). The fibre catalyst could be recycled more than 20 times without any loss of activity or selectivity.

Ikegami et al. developed a supramolecular complex prepared from a self-assembly of (NH₄)₂PdCl₄ and a non-cross-linked amphiphilic phosphine polymer poly[(*N*-isopropylacrylamide)₅-*co*-(4-diphenylstyrylphosphine)] (**23**).^{206a} This catalyst was shown to be very effective in the coupling of electronically different aryl iodides with alkyl acrylates and styrene. The reactions proceeded with Et₃N as a base in toluene at 100 °C for 5–20 h, the yields being in all cases above 90%. Very high TONs were reached (up to 1,150,000) and the complex could be recycled up to five times, still retaining its activity with only 5 × 10⁻⁵ mol equiv. In this case, the polymer is not commercially available and

must be synthesised by radical copolymerisation of *N*-isopropylacrylamide and the expensive diphenyl(4-styryl)phosphine, but this is compensated for the effectiveness of the catalyst. This methodology was applied to the synthesis of resveratrol and was demonstrated to also work effectively using water as a solvent.^{206b}

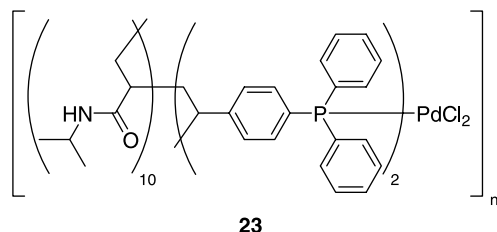

The polystyrene-supported palladacycle **24** was obtained in 20% overall yield after six steps from 4-methylacetophenone.²⁰⁷ This catalyst (0.002–0.05 equiv) promoted the Heck reaction of methyl acrylate with iodobenzene and aryl bromides containing either electron-rich or electron-withdrawing groups, in the presence of NaOAc in DMA at 100 °C for 8–48 h in excellent yields (92–99%). In a model reaction, the yield of the product was > 80% after recycling the catalyst four times using ether as the solvent to precipitate the catalyst.

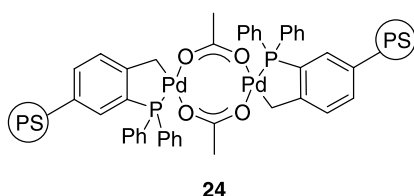

Plenio et al. reported the synthesis of a polymer-enlarged catalyst formed from (1-Ad)₂P-substituted poly(methylstyrene) (**25**) and a suitable palladium source [Pd(dba)₂].²⁰⁸ The polymer **25** was obtained by anionic polymerisation of 4-methylstyrene, bromination and reaction with (1-Ad)₂PH. The catalyst (0.5 mol%) was utilised in the coupling of 4-bromoacetophenone, 4-bromoanisole and bromobenzene with *n*-butyl acrylate in NMP–Pr₂NH at 100 °C for 16 h. The coupling yields were 80–87%, but, the catalyst could not be recycled, since attempting nanofiltration in the highly polar and aprotic medium resulted in severe membrane damage.

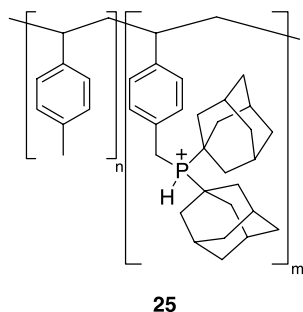

Poly(vinylpyridine) nanospheres were used by Thompson et al. as a stable support for dispersing polymer-stabilised palladium nanoparticles (1–4 nm) by a one-step adsorption from colloidal solution.²⁰⁹ Monodispersed nanospheres

were prepared by emulsifier-free emulsion polymerisation techniques under free-radical initiation of the monomer with 4 wt% divinylbenzene as the cross-linking agent. The catalyst (0.1 mol%) was successfully applied to the coupling of 4-nitrobromobenzene and *n*-butyl acrylate in DMA and Et₃N at 120 °C for 12 h. The catalyst was found to be air-stable and did not show any decrease in activity after six months stored in air. Although there was no substantial palladium loss or swelling under the reaction conditions, the coverage and palladium loading over the beads were relatively higher, compared to those of Antonietti's system described below (see Section 7.2.1). It would be interesting to know about the scope of the catalytic system when applied to other haloarenes and olefins.

The palladium complex supported on Tenta Gel[®] resin **26** (Chart 8), containing a pyridylbis-*N*-heterocyclic carbene ligand derived from isonicotinic acid, could be recycled up to 14 times (by filtration, washing and drying) in the Heck coupling of iodobenzene and methyl acrylate.²¹⁰ The different cycles were carried out with 1 mol% **26**, Et₃N and DMA at 165 °C for 48 h under an inert atmosphere to avoid Pd black formation. Very low levels of palladium leaching from the resin were detected. The reaction conditions are, however, still rather harsh (165 °C, sealed tube, 48 h) and the methodology seems to be restricted to only iodobenzene and methyl acrylate. Buchmeiser et al. have reported the synthesis of new polymer-supported palladium(II)bis(3,4,5,6-tetrahydropyrimidin-2-ylidenes) of the type **27** (Chart 8), derived from Merrifield resin, Wang resin and crosslinked poly(norbor-2-ene).²¹¹ These supported catalysts were used in the Heck reaction of *n*-butyl acrylate and styrene with various aryl iodides and bromides in DMA at 145 °C. No general trend in terms of optimum support was, however, observed under the chosen conditions, most of the yields being rather low. The strong variations in reactivity seem to support the coupling

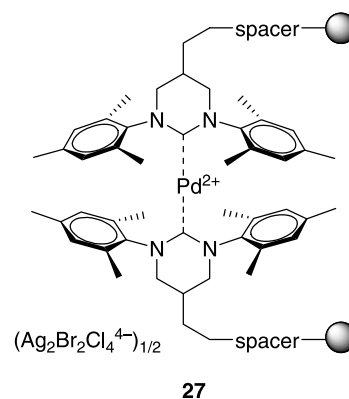
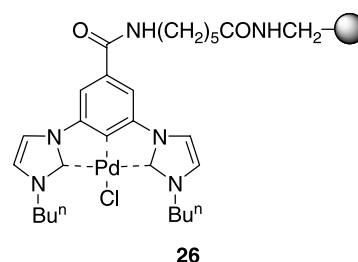
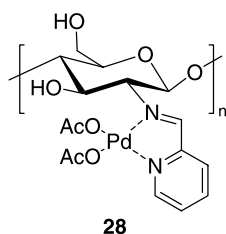

Chart 8.

reactions proceeded via supported species. In addition, catalyst deactivation and leaching of palladium were observed when re-used, this precluding any possible catalyst recycling.

Chitosan or poly[β -(1-4)-2-amino-2-deoxy-D-glucan] is produced by deacetylation of chitin, a major naturally occurring biopolymer. Recently, different groups have used it as a support in the palladium-catalysed Heck reaction. Macquarrie et al. modified chitosan by the introduction of a palladium iminopyridyl complex.²¹² The resulting complex **28** catalysed the reaction of iodobenzene and *n*-butyl acrylate, in the presence of Et₃N, giving *n*-butyl cinnamate in 82% yield after 42 h at 100 °C (for a substrate-to-Pd molar ratio of 1325). The coupling of styrene and bromobenzene was accomplished at a substrate-to-Pd ratio of 1420, giving stilbene in 88% yield after 42 h. By doubling the amount of catalyst, the reaction times were reduced by 50%. But the possibility of catalyst recycling was not explored in the Heck reaction. A chitosan-immobilised palladium(0) complex was prepared by other workers by refluxing chitosan with PdCl₂ in EtOH and this was also applied to the Heck reaction with yields varying from 12 to 99%.²¹³ For the application of palladium on chitosan in ionic liquids, see Section 6.2.



The inorganic and polymeric supported catalysts reported here were demonstrated to be very advantageous from the point of view of catalyst recycling and product purification. The generally high reaction temperatures needed in order to obtain reasonable conversions and the often observed palladium leaching are still, however, the main limitations of these methodologies.

5.2.5. Dendrimeric systems. The synthesis of dendrimers with defined inner and outer structural elements provides access to macromolecular materials having special properties and functions that can be useful for applications in catalysis.²¹⁴ Such materials can be at the interface between homogeneous and heterogeneous catalysis. Dendrimers are particularly attractive hosts for catalytically active nanoparticles since (a) the dendrimer templates yield well-defined nanoparticle replicas, (b) the nanoparticles are stabilised by encapsulation within the dendrimer and do not agglomerate, (c) the nanoparticles are retained within the dendrimer primarily by steric effects and, therefore, a substantial fraction of their surface is unpassivated, (d) the dendrimer branches can be used as selective gates to control the access of small molecules to the encapsulated nanoparticles and (e) the dendrimer periphery can be tailored to control the solubility of the hybrid nanocomposite and to facilitate linking to surfaces and other polymers.²¹⁴ Metal-containing dendrimers have, however,

been scarcely prepared for use as catalysts in the Heck reaction.

In 1997, Reetz et al. reported the preparation of a dendritic diphosphane-metal complex from a commercially available DAB-based (DAB = 1,4-diaminobutane) polyamino dendrimer DAB-dendr-(NH₂)₁₆, by double phosphinomethylation of each of the primary amino groups and metal complexation.²¹⁵ Coupling of bromobenzene and styrene in the presence of 0.125 mol% catalyst furnished 89% stilbene, together with 11% 1,1-diphenylethylene at a conversion of 85–90% (Scheme 58). The catalyst could be recovered by precipitation with diethyl ether and used once more with comparable catalytic activity. Unfortunately, the selectivity of the method is not very high.

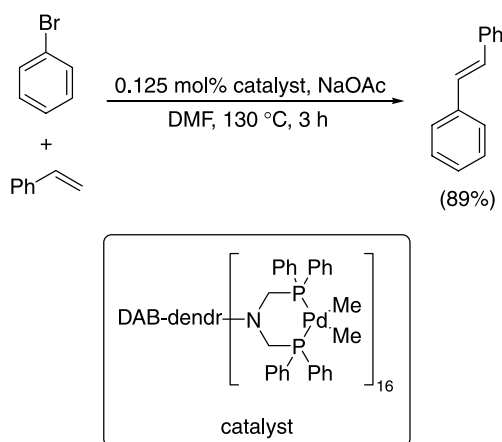

More recently, Screttas et al. have described the synthesis of the iminophosphane ligand, DAB-dendr-[1,2-*N*=CHC₆H₄-PPh₂]₃₂ (DAB-32-imiphos), from the polyamino dendrimer DAB-dendr-(NH₂)₃₂ and 2-diphenylphosphinobenzaldehyde, which was tested in the palladium-catalysed reaction between *p*-anisyl bromide and styrene.²¹⁶ The highest conversion (93%) was achieved under the reaction conditions specified in Scheme 59. An equimolar mixture of a tertiary amine and acetic acid was shown to be superior to any other solvent tried, this solvent system

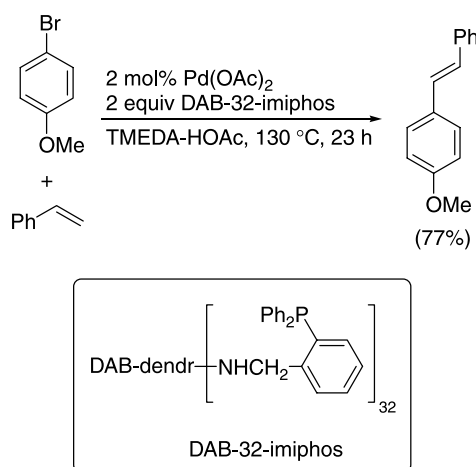

behaving as an ionic liquid. It must be pointed out that this catalytic system is not recoverable, due to degradation of the ligand and extensive formation of palladium black under the reaction conditions.

Portnoy et al. synthesised various poly(aryl benzyl ether) and polythioether dendronised polystyrene resins in which the terminal hydroxyl groups were esterified with 4-(diphenylphosphino)benzoic acid, followed by complexation with Pd(0) using a Pd(dba)₂ precursor (Chart 9). In the polyether series, the maximum conversion (100%), yield (100%) and selectivity (>200) in the Heck reaction of bromobenzene and methyl acrylate was achieved with the third-generation-derived catalyst at 80 °C for 72 h in NMP–Et₃N.²¹⁷ A similar behaviour was observed for styrene as the substrate, although the effect on the activity and selectivity was somewhat smaller. In the case of *n*-butyl vinyl ether, three isomeric products were obtained in all cases. Precipitation of palladium occurred during the reaction, indicating that, probably, the catalysis is performed by palladium nanoparticles stabilised inside the dendritic matrix. In the polythioether series, the starting monomer is not commercially available and was synthesised from the corresponding oxygenated derivative.²¹⁸ In this case, the third-generation of the polystyrene-polythioether dendron/Pd(0)-phosphane (2.5% Pd) was effective in the reaction of bromobenzene and methyl acrylate in NMP–Et₃N at 120 °C for 14 h (89% yield). Moreover, for iodobenzenes as substrates, there was no need for phosphino groups on the dendron, since each isophthalate-derived unit in the interior of the dendron can serve as a precursor to the pincer complex of the SCS monoanionic tridentate ligand, which behaves as an efficient and recyclable catalyst.

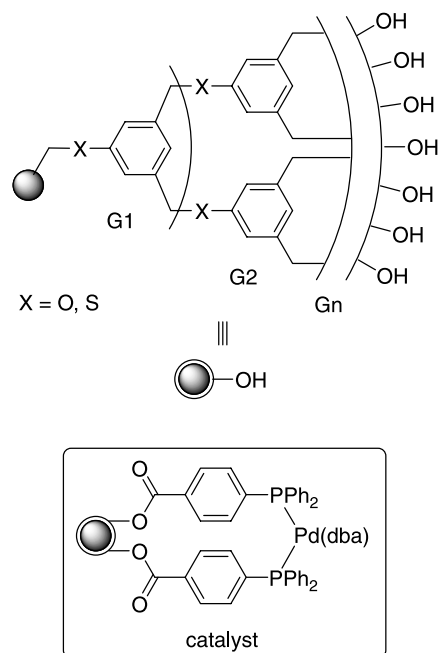

Chart 9.

Christensen et al. studied the behaviour of palladium nanoparticles encapsulated in poly(amidoamine) (PAMAM) dendrimers in the Heck reaction of aryl iodides

and bromobenzene with acrylic acid.²¹⁹ Thus, 0.025 mol% Pd in the form of Pd₆₀[G4PAMAM-OH] catalysed the coupling of different substituted aryl iodides and acrylic acid in DMA–NaOAc at 140 °C for 12 h, furnishing the corresponding *trans*-cinnamic acids in 67–92% isolated yields. A much lower yield was obtained for bromobenzene (35%), whereas chlorobenzene did not react. On the other hand, the lifetime of the catalyst was not satisfactory, as a loss of catalytic activity was observed, due to a gradual thermal degradation of the dendrimer.

A palladium-nanoparticle-cored G3 dendrimer, derived from Fréchet-type dendritic polyaryl ether disulfide of generation three, was found to possess approximately 300 Pd atoms in the metallic core and an average diameter of 2 nm, to which were attached 14 G3 dendrons.²²⁰ These dendrons inhibited metal agglomeration without adversely affecting the chemical reactivity. In fact, nearly 90% of the metal nanoparticle surface was unpassivated and available for catalysis, for example, the Pd-G3 dendrimer (2×10^{-3} mol%) catalysed the Heck reaction of iodobenzene and ethyl acrylate in toluene–Et₃N at reflux for 24 h, giving ethyl *trans*-cinnamate in 75% yield. The use of styrene as the substrate, however, led to a mixture of stilbene and 1,1-diphenylethylene in rather low yields, 38 and 8%, respectively. The reactions took place under homogeneous conditions, and, after removal of the toluene and addition of ether, the Pd-G3 catalyst was easily removed, and was shown to be stable for several months, both as a powder and as a dilute solution in dichloromethane.

Alper et al. developed dendritic silica-supported bidentate phosphine ligands of the type PPh₂-PAMAM-SiO₂, obtained from a commercial aminopropylsilica gel by Michael addition of the pre-existing amino group to methyl acrylate, amidation of the ester units with ethylenediamine, phosphinomethylation of each terminal amino group, and palladium complexation.²²¹ The second-generation Pd-PPh₂-G2-PAMAM-SiO₂ dendrimer showed the highest catalytic activity and found application in the coupling of different bromoarenes and iodobenzene with *n*-butyl acrylate (Scheme 60).²²² In contrast to the expected behaviour, electron-withdrawing substituents on the arene gave relatively low yields and conversions, while electron-donating groups gave moderate to good yields of the coupled products.

Kaneda et al. recently described the immobilisation of a palladium complex catalyst within the cavity of poly(propylene imine) dendrimers through ionic bonds.²²³ The peripheral groups on the third to fifth-generation of the dendrimer were modified with decanoyl chloride and 3,4,5-triethoxybenzoyl chloride, respectively, to give the alkylated and arylated dendrimers. The dendritic palladium complexes catalysed the Heck reaction of iodobenzene with *n*-butyl acrylate in the presence of KOAc in toluene at 100 °C, the reaction rates increasing with increasing generations of dendrimers. The fifth-generation dendrimer complex was also applied to the high-yielding coupling of 1-iodonaphthalene with *n*-butyl acrylate and styrene. It is worthy of note that, in the reaction of *p*-diiodobenzene with *n*-butyl acrylate, the monosubstituted product was obtained

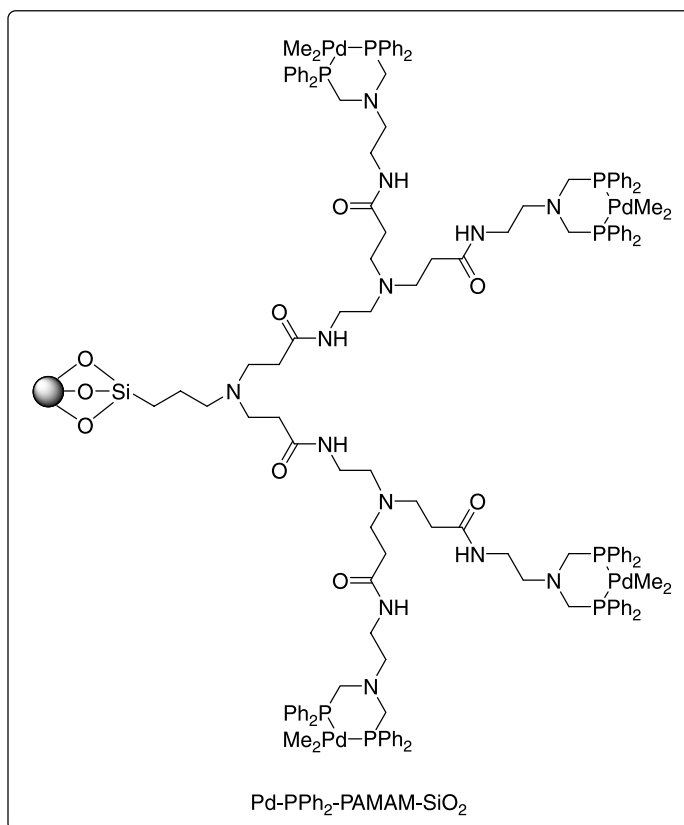
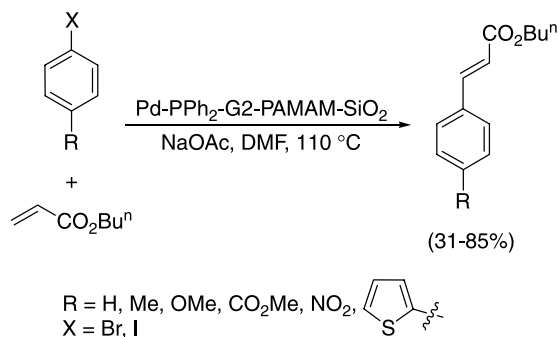

Scheme 60.

with 92% selectivity. The possibility of catalyst recycling in the Heck reaction was not, however, tested.

Poly(ether imine) dendrimer peripheries were modified with alkyldiphenylphosphine ligandies and converted into catalytically active phosphine–Pd(II) complexes.²²⁴ The first to third-generation of dendrimeric catalysts found application in the Heck coupling of iodobenzene with a variety of conjugated olefins (see one example in Scheme 61). In general, an increase in the substrate conversion could be noticed for the first-generation palladium catalyst, although, for styrene, the reaction was sluggish and took longer than for any other substrate. The catalytic performance of the regenerated catalysts decreased, when compared to the corresponding fresh catalyst, limiting the possibilities of their being re-used.

Dendritic poly(propyleneimine)-iminopyridyl-palladium complexes achieved high conversions in the reaction of iodobenzene with methyl acrylate, styrene and 1-octene.²²⁵

In particular, the pyridylimine palladium dendrimer **29** achieved high conversions in refluxing acetonitrile, although electronic factors seem to play a decisive role in determining the regiochemistry of the reaction. The reactions with methyl acrylate yielded mainly β -arylated

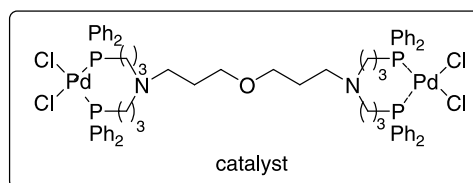
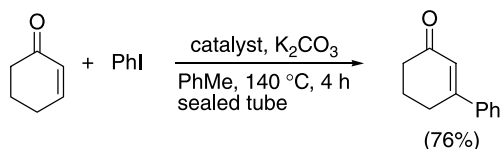

Scheme 61.

products, whereas 1-octene yielded a mixture of *cis*–*trans* isomers and β,β -disubstituted compounds. At any rate, the dendritic complex **29** exhibited a higher conversion and the reactions proceeded faster, compared to the reaction with the mononuclear iminopyridyl-palladium analogue or PdCl_2 . Unfortunately, iodobenzene was the only aryl halide tested and no recycling studies were carried out.

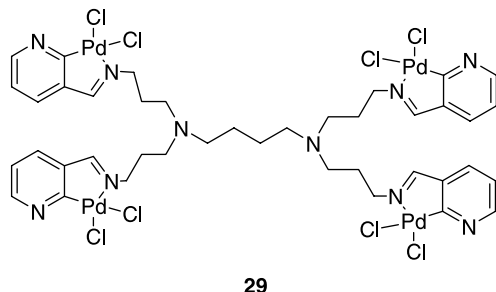
**29**

In general, the catalytic activity and selectivity exhibited by dendrimeric systems as catalysts in the Heck reaction are comparable, or even lower, than those observed for other unsupported or supported systems. It is clear that the easy separation of the catalyst by precipitation in a proper solvent is very advantageous from the re-utilisation point of view. The preparation of the catalysts, especially those of higher generations, is, however, not straightforward in most cases, involving sometimes non-commercially available substrates and different synthetic steps with the concomitant generation of waste.

6. Solvents

The standard Heck reaction uses a conventional solvent to place the different components in close proximity, allowing the reaction to take place either under homogenous or heterogeneous conditions. Recently, however, Cacchi et al. reported an interesting study on the Heck reaction of butenone with aryl iodides under solvent-free conditions.²²⁶ A number of aryl iodides containing electron-donating and electron-withdrawing substituents gave the corresponding vinylic substitution products in good to excellent yields (67–98%) (Scheme 62). Only iodoanisole produced the Heck derivative in a low yield (32%). The presence of both a proton sponge and *tris*-(2,4,5-trimethoxyphenyl)-phosphane (ttmpp) was required in order to obtain the best results, minimising the formation of hydroarylation products. The absence of a solvent reduced the toxicity and flammability, and simplified the work-up.

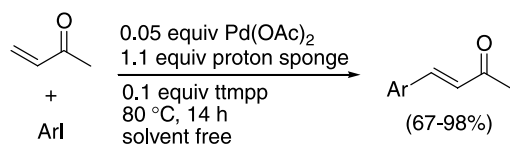

Ar = *p*-Y-C₆H₄ (Y = Me, OMe, Cl, MeCO), *o*-MeOC₆H₄,
m-Y-C₆H₄ (Y = Me, OMe, CF₃), 4-Me-3-O₂NC₆H₃

Scheme 62.

Chandrasekhar et al. found that PEG having a molecular weight of 2000 was an efficient medium for the palladium-

catalysed Heck reaction of aryl bromides with ethyl acrylate, styrene, and *n*-butyl vinyl ether.²²⁷ The reactions were carried out with 5 mol% $\text{Pd}(\text{OAc})_2$ and Et_3N at 80 °C for 8–16 h (80–95% yield). Interestingly, and in sharp contrast to the results obtained when the reaction was performed in ionic liquids (see Section 6.2), exclusive attack of the arylpalladium species on the β -carbon of *n*-butyl vinyl ether was observed (*Z/E* 70:30–100:0). The reaction mixture was extracted with diethyl ether and the PEG and $\text{Pd}(\text{OAc})_2$ were solidified and subjected to subsequent runs with a low decrease in yield (88–70% for six runs).

6.1. Supercritical fluids

Highly fluorinated compounds have been shown to have an unusually high solubility in scCO_2 , and their incorporation into phosphane-based ligands was expected to improve the solubility of the corresponding metal complexes. The groups of Holmes and Tumas independently reported^{228,229} in 1998 the first palladium-catalysed carbon–carbon coupling reactions in scCO_2 using fluorinated ligands. Holmes et al. demonstrated that the Heck reaction of iodobenzene and methyl acrylate in scCO_2 with $(\text{C}_6\text{F}_{13}\text{CH}_2\text{CH}_2)_2\text{PPh}$ as the ligand occurred in a superior yield to that reported for conventional solvents. Under these reaction conditions intramolecular processes were also possible (Scheme 63).²²⁸ Despite the work-up procedure being easy, the reaction time was considerably long and the fluorinated ligand had to be prepared from $\text{C}_6\text{F}_{13}\text{CH}_2\text{CH}_2\text{MgI}$ and PhPCl_2 . Very high conversions and selectivities were also obtained by Tumas et al. in the coupling of iodobenzene with either methyl acrylate or styrene in the presence of $\text{Pd}(\text{OAc})_2$ and the ligands, $[3,5-(\text{CF}_3)_2\text{C}_6\text{H}_3]_3\text{P}$ or $(\text{C}_6\text{F}_5)_3\text{P}$.²²⁹ In this case, a slightly lower temperature (90 °C) and a shorter reaction time (24 h) were reported, but applying a 5-fold pressure (345 bar).

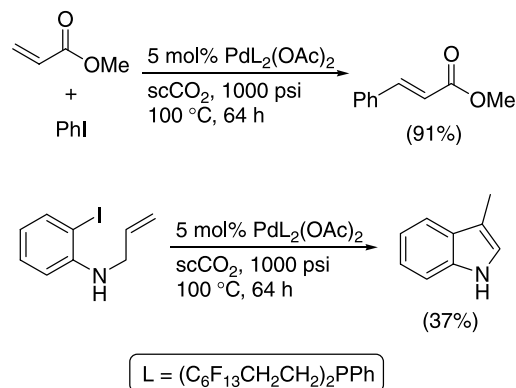
**Scheme 63.**

Cacchi et al. introduced Pd/C as a catalyst in the reaction of iodobenzene with methyl acrylate, styrene and acrylonitrile in scCO_2 to give the vinylic substitution products in moderate to good yields (Scheme 64).²³⁰ Unfortunately, the reaction of iodobenzene, *p*-iodoanisole and *p*-iodoacetophenone with butenone gave rise to a mixture of the vinylic substitution products and hydroarylation (formal conjugate addition) products, whereas the reaction of *p*-iodoanisole with *n*-butyl vinyl ether afforded a mixture of α - and β -arylation products.

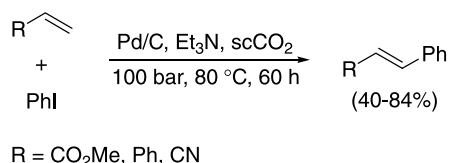

Scheme 64.

Rayner et al. demonstrated that the use of fluorinated palladium sources for Heck reactions in scCO₂ gave superior results to those previously reported, including a low catalyst loading at moderate temperatures and commercially available ligands.²³¹ Conversions of >95% were obtained for the reaction of iodobenzene with methyl acrylate or styrene with catalytic Pd(OCOCF₃)₂ or Pd(F₆-acac)₂ and (2-furyl)₃P as a ligand, and DIPEA as a base, at 75–80 °C for 15–17 h, under 1600 psi CO₂. These catalysts, however, gave dark precipitates in the crude product, presumably due to metallic palladium residues obtained by decomposition. The same group applied the above catalytic system to significantly reduce double-bond isomerisation in intramolecular Heck reactions (Scheme 65).²³² A comparative study using conventional solvents and scCO₂ demonstrated that double-bond migration was suppressed to a large extent by using scCO₂ as the reaction medium.

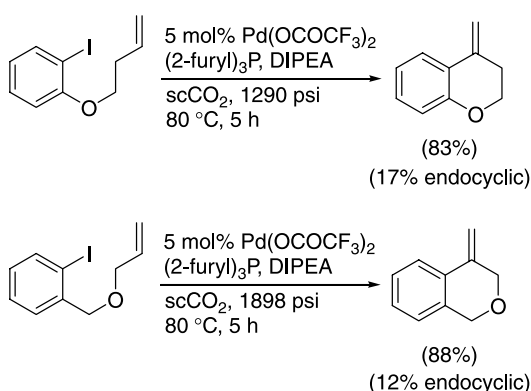

Scheme 65.

The group of Arai et al. has concentrated much effort on the development of efficient Heck reactions based on the use of multiphase catalysis and supercritical carbon dioxide.²³³ In one contribution, they highlight the significant enhancement in the solubility of the substrates in scCO₂ by the addition of a co-solvent such as water or ethylene glycol to the reaction medium. Heck vinylation of iodobenzene with butyl acrylate and styrene was carried out in scCO₂ at 80 and 140 bar, respectively, in the presence of Pd(OAc)₂, TPPTS, Et₃N and water or ethylene glycol, for 17 h. In spite of the good catalyst stability, high selectivity and easy separation of the reactants and products (in the organic phase) from the catalyst (in the co-solvent phase), the conversions were very disappointing (<29%).

The same group studied the palladium-catalysed Heck reaction of iodobenzene and styrene in compressed CO₂ (12 MPa) using different fluorinated-phosphine compounds as ligands at 70 °C.²³⁴ Although the solubility of the fluorinated ligands was very high in dense CO₂, marginal improvements were found in this reaction, when compared

with the non-fluorinated ligand, triphenylphosphane. The activity exhibited by the palladium complexes was shown to strongly depend on the type of phosphane used, following the trend bis(pentafluorophenyl)phenylphosphane > triphenylphosphane, tris(pentafluorophenyl)phosphane > diphenyl(pentafluorophenyl)phosphane, tris(*p*-fluorophenyl)phosphane > tris(*p*-trifluoromethyl phenyl)phosphane, 1,2-bis[bis(pentafluorophenyl)phosphino]ethane. This order of effectiveness was different from that obtained in conventional organic solvents.

Ikariya et al. reported the Mirozoki–Heck arylation of ethylene catalysed by palladium complexes bearing triphenyl phosphite ligands in an scCO₂–liquid biphasic system, giving rise to a mixture of arylated products (styrene, stilbene and 1,1-diarylethylene derivatives).²³⁵ PdCl₂[P(OPh)₃]₂ was the best choice of catalyst for the arylation, because of its excellent activity and suitable solubility under the reaction conditions at 130 °C and 100 atm (Scheme 66). Very high conversions were obtained either for iodobenzene or for the less reactive *p*-bromotoluene, using Et₃N or a mixture of DBU and 1-ethylpiperidine as bases, respectively. Notably, the yield and selectivity were higher in comparison with other reaction media, the selectivity for the styrene formation being remarkably improved with an increase in the pressure of CO₂ above the critical pressure. As an additional advantage, the product was effectively extracted into the scCO₂ phase, because of its reasonable high vapour pressure and high solubility in scCO₂ under the reaction conditions.

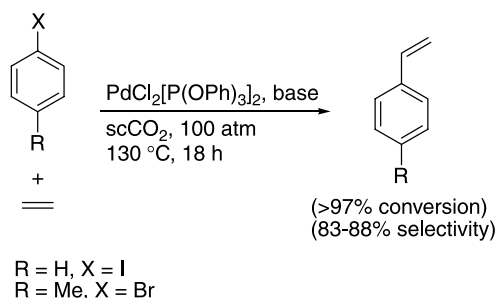

Scheme 66.

Palladium nanoparticles sequestered within fifth-generation poly(propylene imine) dendrimers, having perfluoro-2,5,8,11-tetramethyl-3,6,9,12-tetraoxapentadecanoyl perfluoropolyether chains covalently attached to their periphery, could be easily solubilised in scCO₂. These dendrimer-encapsulated catalysts (DECs) were shown to be active in the Heck coupling of iodobenzene and methyl acrylate in the presence of Et₃N at 75 °C and 5000 psi.²³⁶ In contrast to the other methodologies, methyl 2-phenylacrylate was obtained as the only reaction product, instead of the regioisomeric methyl cinnamate (Scheme 67). The high selectivity obtained was attributed in part to the steric environment that the dendrimer template imposes on the reaction intermediate, although, primarily, it was suggested to result from the scCO₂ solvent. Unfortunately, this study was limited to the coupling shown in Scheme 67, the behaviour of other substrates remaining unknown.

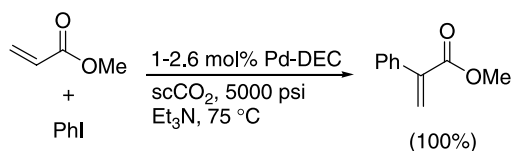

Scheme 67.

Holmes et al. showed that the combination of Pd(OAc)₂ with Bu₃P catalysed the Heck coupling of iodobenzene with methyl and *n*-butyl acrylate in scCO₂. This completely non-fluorous catalytic system (5–10 mol% Pd) furnished the coupling products in 77–92% isolated yields using Et₃N or DIPEA as bases at 100 °C for 16 h.²³⁷ Alternatively, and taking advantage of the ability of scCO₂ to plasticise polymers, the acrylate substrate was supported on an REM resin, which underwent a Heck reaction with iodobenzene employing a catalytic system of Pd(OAc)₂ and the highly fluorinated phosphane, (C₆F₁₃CH₂CH₂)₂PPh, to give (*E*)-methyl cinnamate in 74% yield after resin cleavage (Scheme 68).

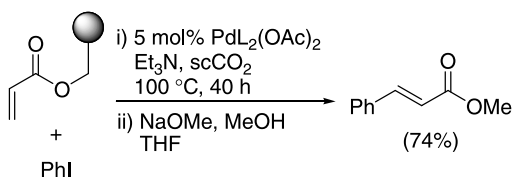

Scheme 68.

The same research group carried out some investigations on the Heck reaction in scCO₂, where the base or the catalyst were immobilised on commercially available supports.²³⁸ A polystyrene-supported amine base (PS-NEt₂) was shown to be as effective as other CO₂-soluble amine bases (e.g., DIPEA) in the coupling of differently substituted iodoarenes with *n*-butyl acrylate using Pd(OAc)₂ or Pd(TFA)₂ with or without Bu₃P at 80–100 °C and 3000 psi for 16 h. The novelty of this approach is based on the easy work-up, in which both the amine and the bulk of the palladium trapped in the polymer matrix can be removed by filtration of the solvent, into which the CO₂ reaction mixture is vented. Successful experiments were also carried out by using a polymer-supported phosphane catalyst, resin-PPh₂-Pd(OAc)₂. It is noteworthy that, in this case, the less reactive bromobenzene, *p*-nitrobromobenzene and even *p*-nitrochlorobenzene reacted with *n*-butyl acrylate, in the presence of tetra-*n*-butylammonium acetate (TBAA), to give the expected products in good to excellent yields (Scheme 69). Alternatively, palladium(II) acetate was

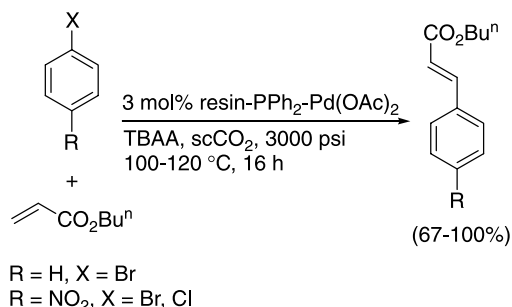

Scheme 69.

microencapsulated in polyurea, furnishing a heterogeneous catalyst able to effectively catalyse the cross-coupling reaction of aryl halides (iodides, bromides and chlorides) with styrene and *n*-butyl acrylate in scCO₂ under similar conditions to those reported above.²³⁹ The catalyst could be recovered by simple filtration and recycled up to four times.

Heck reactions involving various arenes and alkenes were also studied in supercritical water at 400 °C.²⁴⁰ These reactions were shown to be more sensitive to steric hindrance and electronic effects than the analogous reactions in organic solvents. Supercritical water promoted the loss of alkene functionality to a much greater extent than normal organic conditions. Bromide, chloride, carboxylate and, to some extent, hydroxyl losses were all observed in scH₂O. Moreover, hydrogenolysis and hydrogenation processes were favoured under these supercritical conditions, leading to increased side products and, therefore, to a poor selectivity.

It is worthy of note that the Heck coupling of iodobenzene with styrene could be promoted in scH₂O without using any catalyst.²⁴¹ The conversion reached 70% within 10 min in the presence of KOAc as a base, the yield of stilbene being 56%, as a 1:4 mixture of *cis*- and *trans*-diastereoisomers. Again, the selectivity was very low and, therefore, these reactions in scH₂O, although very interesting, seem not to be very practical.

From the information presented in this section, it can be inferred that the main advantage of using SCFs is the easy work-up. No liquid–liquid partition is necessary, since a simple pressure change in the sc reactor allows the gaseous–liquid reaction medium to be vented. On the other hand, it must be taken into account that an expensive stainless steel reactor with sapphire windows is needed to perform reactions in sc media and the CO₂ or H₂O used must be of a very high purity, which consequently increases their prices. The presence of fluorinated compounds, dendrimeric-encapsulated catalysts, or polymer-supported substrates and reagents normally increases the reactivity in the sc system and facilitates the purification step. Additional synthetic chemistry is, however, needed for their preparation. Finally, and in contrast with the supported catalysts described in the previous section, there is a lack of information about the possibility of catalyst recycling in most of the sc systems studied, which, in our opinion, must be a very important topic to be taken into account in any new non-conventional methodology developed.

6.2. Ionic liquids

Ionic liquids have been widely studied as alternative solvents in the Heck reaction, since the pioneering work by Kaufmann et al. in 1996.²⁴² In particular, ionic liquids such as 1-butyl-3-methylimidazolium hexafluorophosphate ([bmim][PF₆]) are virtually insoluble in water and alkanes, but dissolve many transition metal catalysts. Such biphasic liquid systems enable the products of the reaction to be separated from the ionic liquid and catalyst by solvent extraction with an organic solvent or by distillation from the reaction vessel. Furthermore, if a hydrophobic IL is chosen (e.g., [bmim][PF₆]), then water can also be used as an

extraction solvent to remove the salt by-products formed in the reaction.

Kaufmann et al. found that Heck reactions proceeded in a melt of hexadecyltri-*n*-butylphosphonium bromide, tetra-*n*-butylammonium bromide and tetra-*n*-octylammonium bromide with high efficiency.²⁴² Different palladium(0) catalyst precursors such as $(\text{Ph}_3\text{P})_2\text{PdCl}_2$, PdCl_2 or $\text{Pd}(\text{OAc})_2$ were appropriate for the Heck reactions without additive ligands. Bromobenzene and *p*-methoxybromobenzene reacted with *n*-butyl acrylate in high yields in the presence of Et_3N at 100 °C, chlorobenzene did not react under these conditions, whereas *p*-nitrochlorobenzene gave a 52% yield of the expected product. The observed activity for these reactions was explained by a stabilising effect of the palladium(0) by the phosphonium or ammonium salts.

Later, in 1999, Earle et al. reported the Heck reaction in a number of low-melting-point *N,N'*-dialkylimidazolium or *N*-alkylpyridinium ILs with halide, hexafluorophosphate, or tetrafluoroborate anions. For the cations, 1-butyl-3-methylimidazolium (bmim), 1-*n*-pentyl-3-methylimidazolium (pmim), or *N-n*-hexylpyridinium (HexPy) species were chosen.²⁴³ The Heck reaction of iodobenzene and ethyl acrylate in ionic liquids with 2 mol% $\text{Pd}(\text{OAc})_2$ in the presence of Et_3N or NaHCO_3 furnished *trans*-ethyl cinnamate in excellent yields. For the reactions carried out in the chloride salts, the *N-n*-hexylpyridinium salts led to higher yields than the corresponding reactions in imidazolium salts. The reactions carried out in hexafluorophosphate or tetrafluoroborate ILs needed higher temperatures, the tetrafluoroborate IL giving the higher yields. In contrast to the chloride-based systems, the addition of a phosphine ligand (such as Ph_3P) promoted the reaction in the imidazolium salt, [bmim][PF₆]. Even more interesting was the use of benzoic anhydride as a source of the aryl moiety, since a base was not required for the reaction and the by-products were CO_2 and CO. The reaction of *n*-butyl acrylate with benzoic anhydride gave *trans-n*-butyl cinnamate in 90–95% yield. A considerable difference in reactivity was observed between imidazolium and pyridinium ILs, although relatively high temperatures were needed in both cases (Scheme 70). Typically, the product and by-product could be extracted with ether and fresh reagents could be added to re-use both the IL and the catalyst.

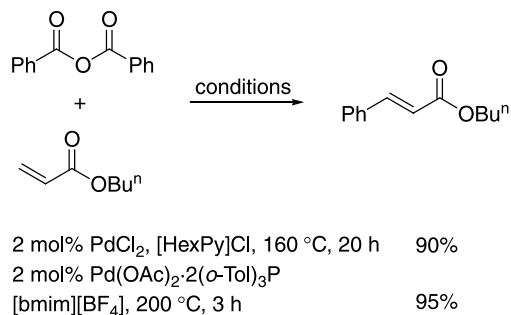

Scheme 70.

In almost parallel studies, Howarth et al. demonstrated that the IL, [bmim]PF₆, could replace DMF in the Heck coupling of aryl bromides and iodobenzene with methyl acrylate.²⁴⁴

The reactions were performed with $\text{Pd}(\text{OAc})_2$ and Ph_3P in the presence of NaOAc as the base at 140 °C for 17 h, affording the corresponding cinnamates exclusively as the *E*-isomers. It is worthy of note that the products could be distilled under high vacuum directly from the reaction mixture, after separation from the aqueous layer, avoiding the use of an extraction solvent. Both the solvent and catalyst were re-usable several times.

Herrmann et al. carried out a detailed study on the Heck vinylation of aryl halides using non-aqueous ILs.²⁴⁵ In particular, TBAB improved the catalyst efficiencies, compared to all of the previously described molecular solvents. The phospho-palladacycle **30** (Herrmann's catalyst), or even the less active PdCl_2 , were able to catalyse the coupling of chloroarenes, bromoarenes, iodoarenes and benzoic acid anhydride with *n*-butyl acrylate, different substituted styrenes, *n*-butyl vinyl ether and the disubstituted α -methyl-*n*-butyl acrylate (Scheme 71). In general, the activity for the electron-rich *n*-butyl vinyl ether and 4-methoxystyrene was lower. Electron-rich substrates (e.g., *p*-bromoanisole) favoured α -arylation, whereas electron-poor aryl derivatives (e.g., *p*-bromoacetophenone) strongly favoured β -arylation. Perhaps one main inconvenience of this methodology is the low regio- and stereoselectivity achieved in those cases. The excellent yields obtained in the coupling of chloroarenes with styrene (except for *p*-chloroanisole) must, however, be highlighted. The insoluble by-products such as NaBr and palladium black could be separated by filtration after several recycling runs, whereas the soluble catalyst and the $[\text{NBu}_4^+]\text{Br}$ could be re-used, although a decrease in the product yields was observed. An additional inconvenience was that careful drying and degasification of the IL was necessary for optimum results.

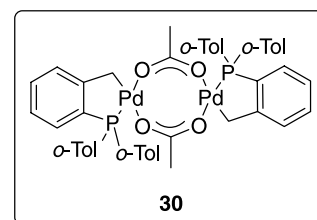
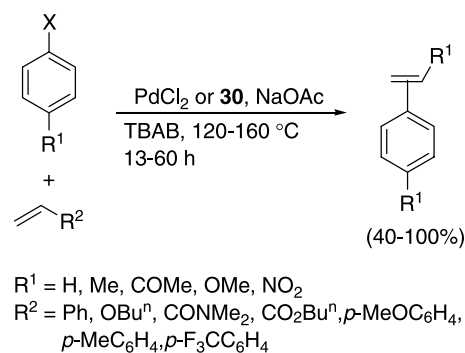

Scheme 71.

Xiao et al. studied the olefination of aryl halides in [bmim][Br] and [bmim][BF₄] by heating (90–125 °C) a mixture of the aryl halide and an acrylate or styrene, in the presence of NaOAc and 1 mol% $\text{Pd}(\text{OAc})_2$, in the IL for 24 h.²⁴⁶ As

expected, the reactions proceeded more efficiently with aryl iodides and activated aryl bromides, whereas a low or no conversion was observed for the less reactive bromobenzene and chlorobenzene, respectively. The coupling reactions were found to be markedly more efficient in [bmim][Br] than in [bmim][BF₄], decomposition of the latter salt being observed with the formation of palladium black. The most important feature of this publication is, however, the finding that the IL, [bmim][Br], reacts readily with Pd(OAc)₂ to give *N*-heterocyclic carbene complexes of palladium, which are active catalysing the Heck reaction. The carbene complex **31** was isolated as a mixture of rotamers and applied, under similar conditions to those used with Pd(OAc)₂, to the olefination of iodobenzene and *p*-bromobenzaldehyde by acrylates in [bmim][Br] (Scheme 72). Surprisingly, complex **31** showed a very low activity in the Heck reaction in [bmim][BF₄].

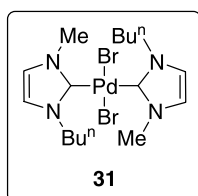
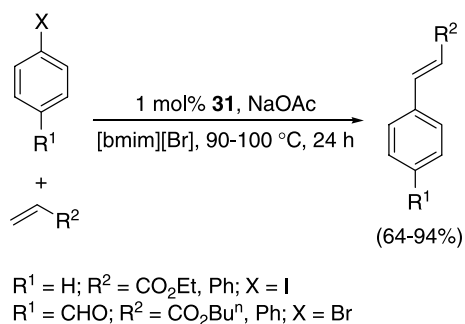

Scheme 72.

Calò et al. synthesised a palladium catalyst **32** with benzothiazole carbenes as ligands, which proved to be effective for a variety of Heck reactions in ILs.²⁴⁷ Thus, 1 mol% of catalyst at 130 °C and 2% of sodium formate (as reducing agent for palladium) in TBAB as solvent catalysed the coupling of aryl bromides and *n*-butyl acrylate in the presence of NaHCO₃ as a base for 1–5 h, to furnish the corresponding cinnamic esters in high yields (85–95%).²⁴⁸ Even *p*-nitrochlorobenzene gave the nitrocinnamic ester in 95% yield after 1 h. Styrene also reacted with 4-bromotoluene in <2 h under the above-mentioned conditions, but leading to a 9:1 mixture of *trans*-4-methylstilbene and 1-(4-methylphenyl)-1-phenylethene, respectively. The same catalytic system was applied to the coupling of *trans*-cinnamates with both electron-rich and electron-poor aryl bromides and *p*-nitrochlorobenzene, affording the tri-substituted olefins with 100% conversion, but with very poor stereoselectivity.²⁴⁹ Several β,β-diarylacrylates were, however, obtained in a one-pot synthesis by the reaction of an excess of aryl bromides with *n*-butyl acrylate under the above conditions (Scheme 73).

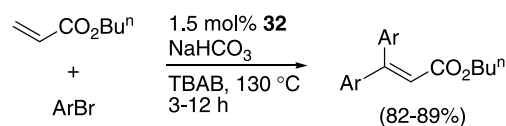

Ar = Ph, *p*-MeC₆H₄, *p*-MeOC₆H₄, 1-naphthyl

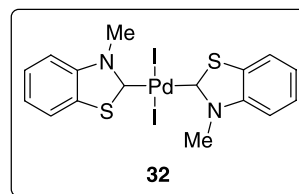

Scheme 73.

The problem of the low diastereoselectivity observed in the reaction of *trans*-cinnamates with aryl halides (mainly aryl bromides) was overcome by using palladium nanoparticles, generated by the reaction of catalyst **32** or Pd(OAc)₂ with TBAA dissolved in TBAB.²⁵⁰ The corresponding β-aryl-substituted cinnamic esters were obtained in excellent yields and remarkable diastereoselectivity (see one example in Scheme 74). The observed stereoselectivity was ascribed not only to a better solubility of TBAA in TBAB, but also to an intramolecular neutralisation of PdH, still ligated to the olefin, by an acetate ion in the metal coordination shell through a five-membered transition state. The absence of acetate in the coordination shell would allow the PdH isomerisation, leading to a thermodynamic mixture of isomeric olefins. This palladium nanoparticle-catalysed Heck arylation was extended to *n*-butyl methacrylate and α-methylstyrene. Unfortunately, a 3:1 mixture of regioisomers was obtained in favour of the terminal olefins, together with variable amounts of double-arylated products.²⁵¹

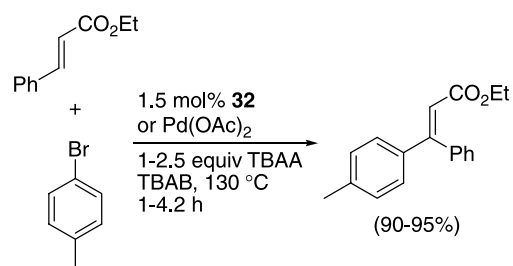

Scheme 74.

Closely related to the work described above, Cacchi et al. conducted the coupling of aryl iodides and methyl cinnamate with catalytic Pd(OAc)₂ in a molten TBAA–TBAB mixture at 100 °C, obtaining the corresponding β-aryl-substituted cinnamic esters also with excellent (*E*)-stereoselectivity.²⁵²

Catalyst **32** also allowed the reaction of various bromoaromatics with hydroxymethylenealkanoates to give β-arylketones, but not the expected Heck products, β-oxoalkanoates (Scheme 75).²⁵³ The exclusive formation of the former ketones was rationalised in terms of a fast decarboxylation in TBAB of the expected β-oxoalkanoates.

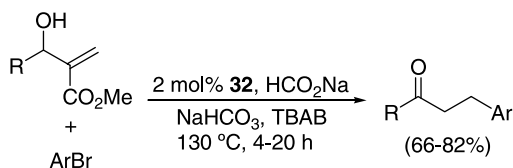

R = Me, Ph, Prⁿ, Prⁱ, *n*-C₈H₁₇
 Ar = Ph, *p*-YC₆H₄ (Y = Me, Ac, OMe), 1-naphthyl

Scheme 75.

The catalyst could be recycled maintaining a roughly equal activity after three cycles.

The group of Xiao et al. focussed on the palladium-catalysed arylation of the electron-rich olefin, *n*-butyl vinyl ether, in the IL, [bmim][BF₄], using aryl iodides and bromides as the arylating agents.²⁵⁴ The reactions proceeded with excellent conversion, yield and regioselectivity, regardless of the nature of the substituents on the aromatic ring, giving exclusively the α -arylated products, which were hydrolysed to the corresponding aryl methyl ketones (Scheme 76). Although the reaction conditions were relatively mild (80–120 °C), 2 equiv of dppp were needed for maximum efficiency. It was suggested that an IL effect stabilising the active palladium-phosphine species was involved in these reactions.

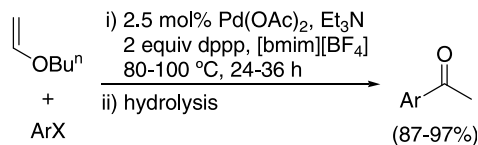

Ar = Ph, *p*-YC₆H₄ (Y = Me, OMe, COMe, CO₂Me, CHO, CN, F), 1-naphthyl; X = Br
 Ar = 1-naphthyl; X = I

Scheme 76.

Recently, Kabalka et al. have reported the palladium-catalysed reaction of methyl acrylate and methyl acrylonitrile with arenediazonium salts in the IL, [bmim][PF₆].²⁵⁵ The reactions could be performed at room temperature for methyl acrylate and at 50 °C for acrylonitrile in the absence of base and in relatively short reaction times (Scheme 77). The catalytic system was recycled at least four times without loss of activity, although electron-rich olefins did not react and styrenes produced dimerisation products.

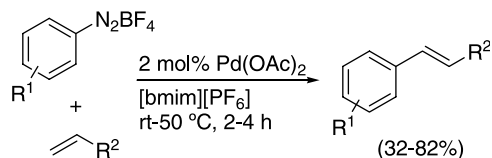

R¹ = H, *p*-X (X = Br, Cl, I, OMe), *o*-CN
 R² = CO₂Me, CN

Scheme 77.

The phosphonium salt IL, trihexyl(tetradecyl)phosphonium chloride, proved to be an excellent medium for the Heck

reaction of aryl iodides and bromides with acrylates and styrene with catalytic Pd(OAc)₂ (1–4 mol%), NaOAc–H₂O or Et₃N at 50–100 °C for 2–4 h.²⁵⁶ The products were obtained in very high yields (81–99%) with complete stereo- and β -regioselectivity. The IL layer containing the palladium catalyst was used in three consecutive recycled rounds with a low decrease in activity (98–94%).

Substituted benzofurans were obtained in modest to good yields by palladium-catalysed intramolecular Heck reaction in [bmim][BF₄] (see one example in Scheme 78).²⁵⁷ It seemed that the less hindered the double bond or the better the aryl leaving group, the lower the yield of the benzofuran. In general, the yields of the substrates with a substituent on the aryl group were lower, although the character of the substituent did not have a significant effect on the reaction yield. The catalyst in the IL phase could be re-used by the addition of another portion of substrate, Bu₃N and HCO₂NH₄, the catalytic activity varying from 71 to 57% after four cycles.

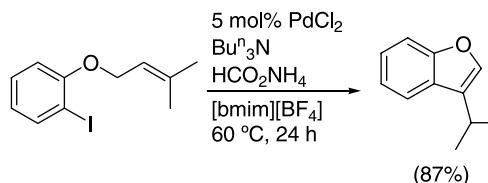

Scheme 78.

The low viscosity IL, [bmim][NTf₂], exhibited a comparable efficiency to the frequently used high-viscosity ILs, such as [bmim][PF₆] and [bmim][BF₄], in the coupling of aryl iodides with *n*-butyl acrylate using a palladium-carbene complex as catalyst (Scheme 79).²⁵⁸ After separation of the product by a triphasic workup (hexane-water-IL), the IL phase containing the palladium catalyst was recycled for six runs without any detectable loss of activity. Despite the high yields obtained for the *trans*-cinnamates, no information was provided about the possibility of application to other aryl halides or electronically different olefins. This methodology was extended to a microflow system with efficient catalyst recycling for the coupling of iodobenzene with *n*-butyl acrylate (see also Section 8.2).²⁵⁹

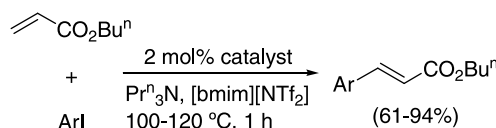

Ar = Ph, *p*-YC₆H₄ (Y = Me, MeO, MeCO, NO₂),
o-MeC₆H₄, *m*-MeC₆H₄

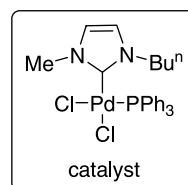

Scheme 79.

The first ultrasound-promoted Heck reaction in ILs at ambient temperature (30 °C) was reported by Srinivasan et al.²⁶⁰ The reaction took place smoothly for the coupling of iodobenzenes with methyl acrylate, ethyl acrylate and styrene to furnish the corresponding trans products in short reaction times and high yields (Scheme 80). The products were separated from the catalyst by extraction with 10% EtOAc in petroleum ether, leaving the palladium catalyst in the dissolved state in the immiscible ionic liquid. The recovered catalyst as a solution in the IL was re-used up to three times without loss of activity. The products, however, required further purification by column chromatography. Under the sonochemical conditions, the conversion of a Pd-biscarbene complex to a highly stabilised cluster of zero-valent palladium nanoparticles was also established.

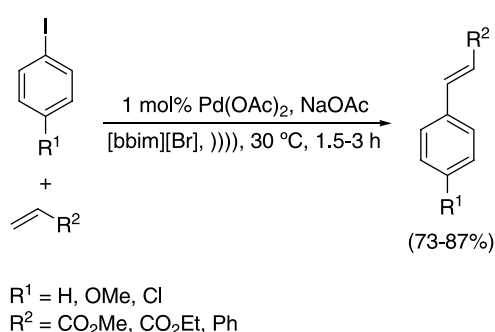

Scheme 80.

Microwave heating in sealed tubes was found to accelerate the Heck arylation of iodobenzene and different aryl and heteroaryl bromides with *n*-butyl acrylate and *n*-butyl vinyl ether in ILs (Scheme 81).²⁶¹ The presence of (*o*-Tol)₃P was necessary for the coupling with *n*-butyl acrylate, whereas the bidentate ligand dppp controlled the internal arylation of *n*-butyl vinyl ether. The ionic catalyst phase could be recycled at least five times.

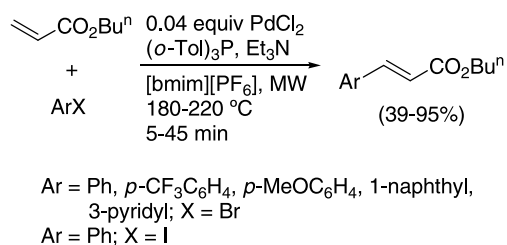

Scheme 81.

Pd/C (3 mol%) was found to disperse well in [bmim][PF₆] and to catalyse the Heck reaction of aryl iodides and bromides with olefins (acrylonitrile, styrene, methyl acrylate, methyl vinyl ketone and ethyl vinyl ketone) in the presence of Et₃N at 100 °C for 1–24 h.²⁶² The yields obtained ranged from moderate to high, except in the case of the vinyl ketones, where they were low. The products were extracted by stirring with *n*-hexane or diethyl ether, followed by decantation. The IL containing Pd/C could be re-used although a certain decrease in the yields was observed, due to accumulation of triethylammonium iodide. Washing the IL with water, however, recovered the catalytic activity to the same level as in the fresh system. A Pd(II)/

SiO₂ catalyst with 2 equiv of Et₃N in [bmim][PF₆] was shown, in general, to be more active than Pd/C and Pd(0)/SiO₂ in [bmim][PF₆], or supported palladium catalysts in DMF, for the Heck reaction of iodobenzene and 4-methyl-iodobenzene with alkyl acrylates.²⁶³ The easy product separation and catalyst recycling without loss of activity are, again, the main advantages of this study.

More recently, Perosa et al. reported a 10-fold acceleration in the Pd/C-catalysed Heck coupling of aryl iodides with electron-deficient olefins and styrene in the presence of the liquid phase-transfer catalyst, Aliquat 336 (A336) and Et₃N at 100 °C.²⁶⁴ This enhancement was also observed when A336 was used in catalytic amounts in a multiphase isooctane-water system. Under these conditions, A336 forms a third phase that allows the catalyst, products and reagents and the base (Et₃N), to be kept separate. The reaction seems not to be of general applicability, however, since the conversion and product distribution are very dependent on the substituents on the aryl moiety and the olefin. Aryl bromides reacted even more sluggishly, only the more reactive bromides undergoing the Heck reaction.

Pd/C (3 mol%) was used in conjunction with the ionic liquid, 1-octanyl-3-methylimidazolium tetrafluoroborate and microwave heating in the absence of phosphane ligands for the coupling of aryl halides with acrylates and styrene.²⁶⁵ Despite the possibility of re-using the catalytic system and the short reaction times (1.5–2.0 min), good product yields were only achieved for very specific activated substrates, aryl chlorides being very reluctant to couple, even on increasing the power of the microwave radiation and the reaction time.

Muzart et al. described the Heck coupling of aryl iodides and bromides with allylic alcohols at 80–120 °C in molten TBAB using NaHCO₃ as base and PdCl₂ as catalyst without extra ligands, leading to the corresponding β-arylated carbonyl compounds regioselectively and in moderate yields.²⁶⁶ No reaction was observed with chlorobenzene or employing benzoic anhydride as the arylating agent, whereas re-use of PdCl₂ and TBAB in the reaction with iodobenzene exhibited an important decrease in the isolated yield. Nonetheless, a successful application of this methodology to the synthesis of the nonsteroidal anti-inflammatory drug, nabumethone, was reported (Scheme 82).

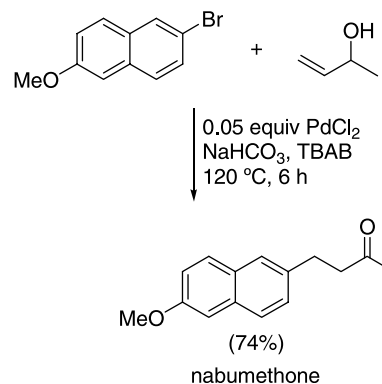

Scheme 82.

The new palladium complex **33** was synthesised by Alper et al. and proved to be an effective catalyst for the Heck reaction using [bmim][PF₆] as the solvent under phosphane-free conditions (Chart 10).²⁶⁷ The versatility of the complex **33** was demonstrated in the high yields and conversions achieved in the coupling of bromobenzene, iodobenzene and a variety of iodoarenes containing electron-withdrawing or electron-donating substituents with several alkyl acrylates, *t*-butyl vinyl ether, styrene and 4-chlorostyrene. The reactions were generally performed with 2 mol% **33** and 1.5 equiv of Et₃N, in [bmim][PF₆] at 120 °C, giving exclusively the corresponding (*E*)-cinnamates. In addition, a double Heck reaction could be effected, either by using an excess of iodoarene, or sequentially (with different types of arenes), leading to β,β- or β,β'-diarylacrylates, respectively. The catalytic system was recycled five times without any loss of catalytic activity, the only inconvenience being that the complex has to be prepared in three steps (30% overall yield) from *N*-methylimidazole, although it is insensitive to oxygen or moisture. The cyclopalladated complex **34** also exhibited a good performance in the coupling of iodoarenes with methyl acrylate in [bmim][BF₄] (Chart 10). In this case, the catalyst was recycled more than ten times, maintaining a satisfactory catalytic activity.²⁶⁸

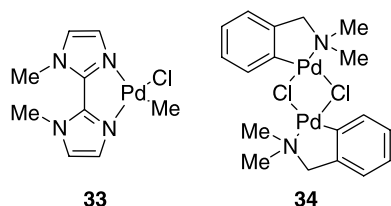
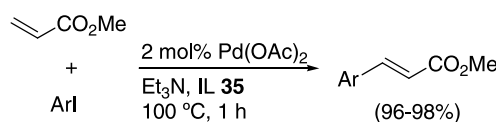

Chart 10.

Zou's group has reported an aqueous-ionic liquid biphasic reaction medium based on high-melting-point hydrophobic alkylammonium tetrafluoroborates and its application to the Heck reaction with a ligandless palladium catalyst.²⁶⁹ Thus, 2 mol% PdCl₂ in a water- or toluene-ammonium biphasic system (ammonium = Bu₄N⁺ or C₅H₁₀NBu₂⁺) catalysed the Heck coupling of iodobenzene with *n*-butyl acrylate, in the presence of K₂CO₃ or Et₃N, giving the expected *trans*-cinnamate in 84–93% yield. Bromobenzene was, however, almost inactive and re-use of the catalytic system remained unclear.

Handy et al. have utilised fructose as the starting material for the preparation of a new class of room temperature ILs, which were obtained in four steps (about 45% overall yield) as a 9:1 mixture of regioisomers.²⁷⁰ The behaviour of these ILs was excellent in the Heck reaction of three aryl iodides and methyl acrylate at 100 °C (Scheme 83). The reactions were fast (about 1 h) and the catalytic system could be recycled up to five times, by extracting the cinnamate products with cyclohexane, maintaining the original high performance. Unfortunately, the reaction was limited to iodoarenes, with no reaction being observed for bromobenzene, even at 140 °C. When compared with the [bmim] salts, the IL **35** showed a slower reaction rate, although the



Ar = H, *p*-MeCOC₆H₄, *p*-MeOC₆H₄

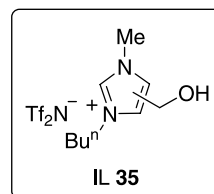

Scheme 83.

magnitude of this difference was less than a factor of two. An interesting accelerating effect of catalytic amounts of certain halide ions on the coupling of iodobenzene and methyl acrylate was observed.²⁷¹

The chitosan support described in Section 5.2.4 was also utilised by Calò et al. to immobilise palladium nanocolloids that were applied to the Heck reaction of iodobenzene, aryl bromides and activated aryl chlorides with *n*-butyl acrylate in TBAB as solvent and TBAA as base at 100–130 °C (Scheme 84).²⁷² The reactions were very fast (15 min in most cases) and gave very high yields of products, which were extracted with cyclohexane, leaving both the IL and catalyst ready to be recycled. Unfortunately, the efficiency of the catalyst decreased after each cycle, with concomitant leaching of palladium from the complex.

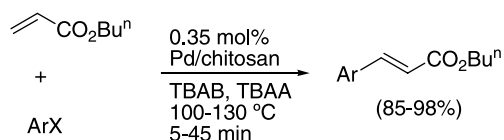

Ar = Ph; X = I
Ar = Ph, *p*-MeC₆H₄, *p*-MeOC₆H₄, 6-MeO-2-naphthyl;
X = Br
Ar = *p*-NO₂C₆H₄, *p*-PhCOC₆H₄; X = Cl

Scheme 84.

New catalysts have been recently developed with the aim of increasing their ionophilicities by the introduction of an imidazolium group covalently attached to the rest of the palladium complex. Corma et al. reported the four-step synthesis of complex **36**, which was soluble in [bmim][PF₆] and not extractable by ether.²⁷³ Unfortunately, the catalytic activity of this palladium complex was unsatisfactory, providing very low yields (<26%) in the coupling of halobenzenes with styrene (NaOAc as a base at 130 °C). A marginal increase in the catalytic activity was observed when the reaction was performed in [bmim][PF₆]-scCO₂, which reduced the medium viscosity. The low activity of complex **36** was attributed to the poor stability of imidazolium ILs to bases.

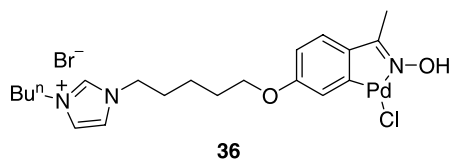

Shreeve et al. showed that the monoquaternary product of 2, 2'-biimidazole with iodobutane was an IL that could act both as a solvent and a ligand in the palladium-catalysed Heck reaction.²⁷⁴ The palladium complex prepared from the ionic liquid **37** and PdCl₂, **38**, gave good to high yields (75–91%) in the coupling of iodo- and chlorobenzene with methyl acrylate and styrene (2 mol% **38**, Na₂CO₃, IL **37**, 100 °C, 4 h). The products were easily separated from the reaction mixture by simple extraction with ether. The catalyst-IL could be recovered by washing with water to remove the sodium salt and drying under vacuum before using. The high performance exhibited by the catalytic system even after ten cycles and using the less reactive chlorobenzene, must be highlighted.

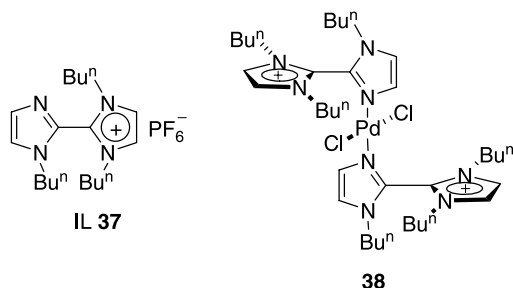

Hardacre et al. carried out an interesting investigation on the palladium species present during the Heck reaction in room temperature ILs based on XAFS.²⁷⁵ A variety of ILs was tested using palladium ethanoate as a palladium metal source and their behaviour was studied in the presence or absence of the reagents or a phosphane. In general, palladium clusters of diameters between 0.8–1.6 nm were formed, the size and stability of which varied according to the system in which they were present. The stabilising effect exerted by the IL on the palladium clusters allowed complete recyclability and simple product separation without the incorporation of palladium in the product or the loss of catalyst from the reaction medium.

It can be concluded in this section that the Heck reaction based on the use of ILs is clearly advantageous from the point of view of product separation and re-use of the catalytic system. The overall effect is a reduction in the number of separation steps required, the product being directly distilled in some cases from the IL without any solvent extraction. In addition, most of the reactions can be performed in the absence of added phosphane ligands. We must not, however, ignore other features of these solvents that can curtail their use, above all on a larger scale. ILs are rather expensive solvents and are therefore used in small-scale reactions, normally involving 1–2 g of the IL. Careful drying and degasification of the IL were also necessary in order to achieve good results. Moreover, and especially when Et₃N is used as a base, by re-utilising the catalytic system it becomes more viscous, due the high concentration

of triethylammonium salts. Therefore, further washing with water and drying in vacuo is required in order to return the IL to its original state.

6.3. Fluorous media

The Heck reaction in fluorous systems is a very young field of research, as demonstrated by the fact that practically all the related reports have been published in the 21st century. The pioneering work in this field was described by Sinou et al. in 1999,²⁷⁶ this group carrying out the palladium-catalysed reaction of aryl iodides with methyl acrylate in a biphasic system with the perfluorocarbon-soluble triarylphosphanes **39–41** (Scheme 85). The fluorous-soluble palladium complexes were prepared by stirring Pd₂(dba)₃ or Pd(OAc)₂ and a solution of the perfluorinated phosphanes in the perfluorinated solvent D-100 (mainly *n*-perfluorooctane). An acetonitrile solution of the aryl iodide and methyl acrylate was added, the biphasic system being stirred at 80 °C for 4 h. The coupling product, in the acetonitrile phase, was easily separated by decantation, whereas the palladium catalyst remained in the fluorous phase. Both the conversion and selectivity were high in the first run, but a decrease in the conversion was observed after recycling of the catalyst, due to the formation of some metallic palladium or the loss of the perfluorinated ligand in the acetonitrile phase.

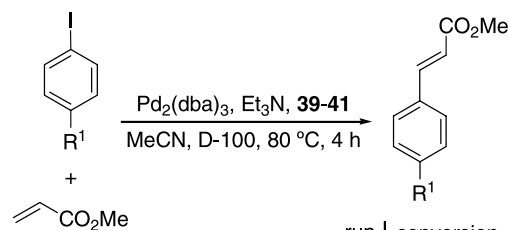

R¹ = H, NO₂, MeO

run	conversion
1	84–100%
2	60–93%
3	40–70%

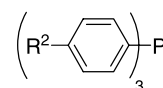

R² = OCH₂(*n*-C₇F₁₅) (**39**)

R² = *n*-C₆F₁₃ (**40**)

R² = O(CH₂)₂OCH₂CF₂[CF(CF₃)CF₂]_m(OCF₂)_nOCF₃;
m = 3.38; n = 0.11 (**41**)

Scheme 85.

A fluorous biphasic system was also used for intramolecular Heck reactions after RCM of a series of *N*-alkenyl-*N*-allyl-2-bromo- or -2-iodobenzenesulfonamides. The corresponding bridged-ring systems were obtained in 0–67% yield after treatment of the RCM products with 10 mol% Pd(OAc)₂, 20 mol% **40** and 2 equiv of Ti₂CO₃ in the perfluorous system at 110 °C for 16 h.¹⁹⁹ The yields were lower in comparison with those obtained with a PS-bound palladium catalyst. As already mentioned in Section 5.2.4, the use of 2 equiv of Ti₂CO₃ is a clear disadvantage in this methodology, due to its high toxicity (mutagen and reproductive effector).

The group of Moreno-Mañas and Pleixats discovered the stabilisation effect exerted by fluorous compounds on palladium nanoparticles and studied their activity as recoverable catalysts under fluorous biphasic conditions in the Heck reaction of iodobenzene with ethyl acrylate, ethyl cinnamate and cinnamitrile.²⁷⁷ The palladium nanoparticles, generated from the ligand, 1,5-bis[4,4'-bis(per-fluorooctyl)phenyl]-1,4-pentadien-3-one and PdCl₂ using MeOH as the reducing agent, were shown to be soluble in perfluorinated solvents through the stabilisation by the fluorinated ligand. The reaction with ethyl acrylate proceeded in 49–71% yield for five consecutive runs (Scheme 86), whereas the reactions with ethyl cinnamate and cinnamitrile did not reach completion, the final product being accompanied by the starting alkene and minor amounts of biphenyl. Despite the ligand being easily prepared by aldol condensation of 4-perfluorooctylbenzaldehyde with acetone, the former starting material was not commercially available and had to be prepared in three steps from methyl 3-iodobenzoate.

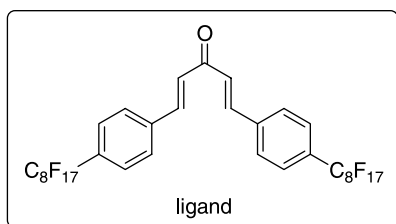
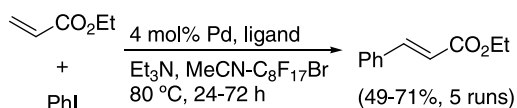

Scheme 86.

The palladacycles **42** and **43**, which were prepared by Gladysz et al. in seven steps from *p*-iodobenzaldehyde, behaved as catalyst precursors in the Heck reaction of aryl bromides and iodides with methyl acrylate and styrene.²⁷⁸ The turnover TONs exceeded 10⁶ with iodobenzene under homogeneous conditions, in the presence of Et₃N at 140 °C and in the absence of fluorous solvents, freshly distilled DMF being used. The catalytic system could be recycled after the addition of the fluorous solvent, *n*-C₈F₁₇Br, to give a biphasic system, albeit with a progressive loss of activity being observed after each cycle. Transmission electron microscopy indicated the formation of soluble, highly active palladium nanoparticles. The most important feature of this catalytic system is the remarkable TONs achieved, although its re-use is not as effective as desired and the synthetic route for the ligands is rather long.

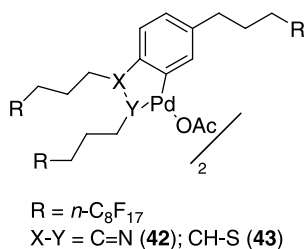

New bidentate, fluorous-tagged 1,3-bis(diphenylphosphino)propane (F-dppp) ligands were synthesised by Curran, et al. and their efficiency was checked in the Heck vinylation of enamides and arylation of *n*-butyl vinyl ether.²⁷⁹ As an example, the Heck reaction of the enol triflate derived from 4-*tert*-butylcyclohexanone with the electron-rich enamide, *N*-methyl-*N*-vinylacetamide, was conducted under the conditions specified in Scheme 87, in the presence of the F-dppp ligand **44**. The performance of this ligand was very similar to that of the nonfluorous dppp, although the selectivity was slightly lower. The free ligand, palladium-complexed ligand and oxidised ligand were all removed from the reaction medium by direct solid fluorous phase separation using the MeOH–H₂O eluting system. The MeOH was removed under reduced pressure and the salts were withdrawn by water–ether extraction. Unfortunately, attempts to re-use the isolated phosphine mixture as the catalytic mixture in a second vinylation failed, with no Heck product being detected. The ligand **44** was also shown to be as effective as dppp in the internal arylation of *n*-butyl vinyl ether with 1-naphthyl triflate (100% conversion, >99:1 selectivity, 5 h), whereas F-dppp ligands bearing larger fluorous tails reduced the reaction rate and selectivity. The synthesis of the F-dppp ligands was accomplished in 56–62% isolated yields (three steps) from the corresponding fluorinated aryl bromides, which are not commercially available.

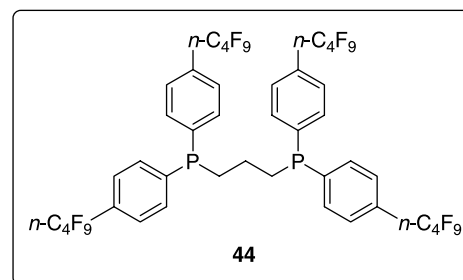
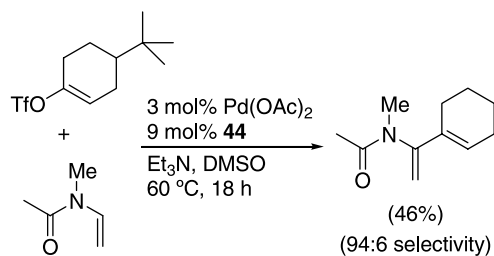

Scheme 87.

A fluorous chiral BINAP, (*R*)-F₁₃BINAP, was prepared and applied to the asymmetric Heck reaction between 2,3-dihydrofuran and 4-chlorophenyl triflates in benzonotrifluoride (BTF, α,α,α -trifluorotoluene).²⁸⁰ The reaction rate was lower and the enantioselectivity similar, compared to the original reaction with (*R*)-BINAP. The expected coupling product was obtained in 59% yield together with the corresponding 2,5-dihydrofuran derivative (8%) (Scheme 88). By carrying out the reaction in benzene or in a benzene/FC-72 biphasic system, the enantioselectivity was slightly higher (93% ee), but the chemical yield and selectivity were much lower. The (*R*)-F₁₃BINAP could be

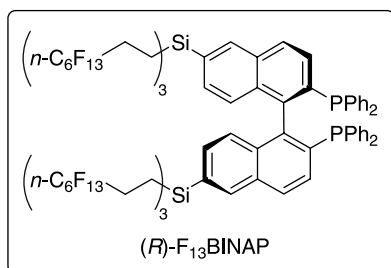
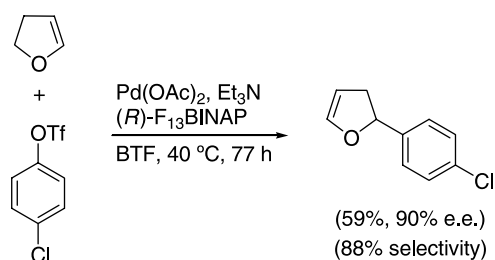

Scheme 88.

recovered, mainly as the corresponding oxide, in 70% yield by using a fluorous reverse-silica gel. In fact, the test for recycling of the catalyst failed, probably due to inactivation by ligand oxidation. Therefore, this study does not contribute to any improvement of the original work²⁸¹ since the catalyst could not be recycled, the ligand had to be synthesised, and the fluorinated solvents are rather expensive.

The above-depicted reaction was also studied by Sinou et al. under the same reaction conditions, but in the presence of the ligand **45** instead of (*R*)-F₁₃BINAP.²⁸² Quantitative conversion was observed after 89 h at 40 °C to furnish the product, 2-(chlorophenyl)-2,3-dihydrofuran, in better regioselectivity (97%), but worse enantioselectivity (68%), compared with the use of the ligands, (*R*)-F₁₃BINAP or (*R*)-BINAP. Again, a long synthetic sequence was needed to prepare the ligand and re-use of the catalyst seems unclear, since ligand **45** does not contain enough fluorine to be used in a fluorous biphasic system.

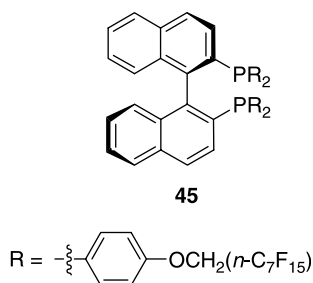

A new fluorous SCS pincer palladium complex was recently synthesised by Curran et al. and this was shown to efficiently promote the Heck reaction under thermal or microwave heating.²⁸³ Aryl bromides, iodides and a single triflate were coupled with methyl acrylate and styrene in short reaction times and high yields at 140 °C (Scheme 89). The catalyst could be recovered largely intact by fluorous solid-phase extraction and re-used, either crude or after crystallisation. The fluorous complex was prepared in three

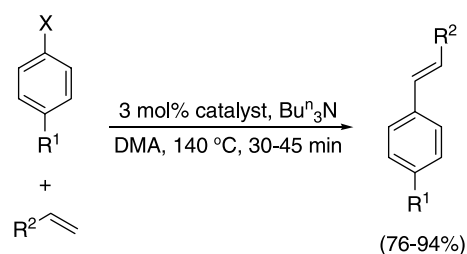

X = Br, I, OTf
R¹ = H, MeO, CN, COMe, NO₂
R² = CO₂Me, Ph

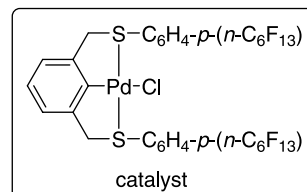

Scheme 89.

steps (21% overall yield) from a commercially available perfluoroalkylaryl bromide and shown to be a stable solid.

The fluorous ether, 1*H*,1*H*,2*H*,2*H*-perfluorooctyl 1,3-dimethylbutyl ether (F-626), was used by Ryu et al. as the sole reaction medium in the Heck β-arylation of α,β-unsaturated acids and esters with aryl iodides, in the presence of a fluorous palladium carbene complex (that can be prepared in situ).²⁸⁴ The insolubility of the acid-type coupling products in F626 allowed facile separation by simple filtration, whereas, for the ester-type coupling products, a traditional fluorous-organic biphasic work-up using EtOH-perfluorohexanes was necessary to separate the products and the fluorous ether F-626 containing the fluorous catalyst. The recovered F-626 phase, containing the palladium catalyst, was re-used for a further five runs without any detectable loss in catalytic activity (Scheme 90). The fluorous solvent utilised, although recyclable, is rather sophisticated and is not readily available.

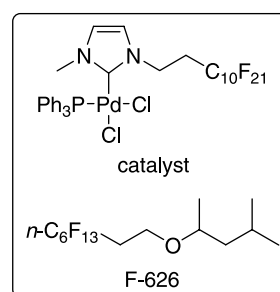
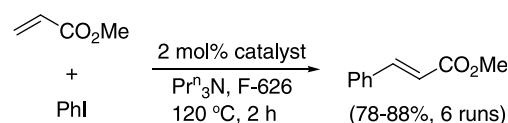

Scheme 90.

In a different context, Crooks et al. reported the preparation of perfluorinated polyether-derivatised poly(propyleneimine) dendrimers containing Pd⁰ nanoparticles by

introducing Pd²⁺ into the interiors of amine-terminated poly(propyleneimine) dendrimers, which were previously end-group derivatised (>90%) with perfluorinated polyether chains.²⁸⁵ Two generations of dendrimer-encapsulated nanoparticle catalysts were investigated for the coupling of iodobenzene, bromobenzene and *p*-bromonitrobenzene with *n*-butyl acrylate using a fluorocarbon–hydrocarbon solvent-based catalyst recovery system. All reactions proceeded with 100% trans-selectivity, the best result being obtained for iodobenzene (70% yield) in the presence of Et₃N (59% in its absence) at 90 °C. Unfortunately, a large decrease in reactivity was observed for the coupling of aryl bromides, whereas aryl chlorides were unreactive. The nanoreactors were recovered after each reaction, the fluorous phase retaining the dark-coloured catalyst with no palladium leaching. The catalytic activity decreased significantly, however, upon successive recovery-catalysis cycles, probably due to changes in the morphology of the palladium nanocluster surface.

From the information presented above, it can be concluded that the application of fluorous media methodologies requires the preparation of the perfluorinated ligands, in most cases through long synthetic pathways and from relatively expensive starting materials. The fluorinated solvents used are also rather expensive and are not always readily available. In addition, the recycling of the catalyst through the fluorous biphasic technique is not always as effective as expected, and this difficulty cannot compensate the economic and time investment in these methodologies.

6.4. Aqueous solvents

The pioneering work in this field was carried out by Beletskaya et al. in 1989.²⁸⁶ Her group discovered that the palladium-catalysed coupling reaction of aryl halides with acrylic acid and acrylonitrile in the presence of a base (NaHCO₃ or K₂CO₃) in water at 80–100 °C provided a novel and efficient method for the synthesis of substituted cinnamic acids and cinnamitriles in high yields. The reactions could be carried out alternatively faster and at a lower temperature (50–60 °C) using KOAc as a base.

Since then, the transition-metal-catalysed Heck reaction in aqueous solvents has been developed following three major protocols: (a) methods without phosphane ligands using transition-metal salts in neat water or aqueous organic solvents, (b) aqueous phosphane-assisted methods using hydrophilic phosphane ligands in aqueous organic solvents and (c) recyclable phase-separation methods using heterogeneous systems with the aqueous phase holding the catalyst, and the hydrophobic organic phase holding the stock of substrates and receiving the products of the reaction. Some other protocols involving the use of superheated or subcritical water were also reported, but showed, in general, very poor selectivity.²⁸⁷

This subject has been properly tackled in the multiple reviews which have essentially covered the bibliographic data published until 2000.^{42,43} Therefore, and in order to avoid an oversized review, we will deal only with the most representative publications which have appeared since 2001.

One of the most attractive protocols uses neat water as solvent in the presence of a proper phase-transfer agent. In this context, Xia et al. used PEG both as a polymeric support and phase-transfer catalyst for the Heck coupling of PEG-supported 4-iodobenzoate with styrene and acrylic acid.²⁸⁸ The reactions were performed with 5 mol% Pd(OAc)₂ and Na₂CO₃ in water at 60 °C for 1–4 h, and, after resin cleavage, afforded the expected products in 94 and 76% yield, respectively.

The combination of water as solvent with microwave irradiation proved to be very efficient in the coupling of a series of aryl iodides (ArI, Ar = *p*-HO₂CC₆H₄, *p*-O₂NC₆H₄, *o*-O₂NC₆H₄, *p*-MeC₆H₄) with styrene, methyl acrylate and acrylic acid,²⁸⁹ 5 mol% Pd(PPh₃)₂Cl₂ being used as catalyst, together with TBAB and K₂CO₃ in water under MW irradiation (375 W) for 10 min in an argon atmosphere. The work-up of these reactions was readily carried out by simple extraction with diethyl ether, the coupled products being obtained exclusively as the trans-diastereoisomers in high yields (86–93%).

Cai et al. described the Heck arylation of acrylonitrile with a variety of aryl iodides in neat water.²⁹⁰ The reactions proceeded smoothly for aryl iodides bearing both electron-donating and electron-withdrawing substituents, leading to the corresponding (*E*)-cinnamitriles in good yields (Scheme 91). This methodology was extended to the Heck arylation of *n*-butyl acrylate and acrylamide with aryl iodides, giving the corresponding (*E*)-cinnamates and (*E*)-cinnamamides in good yields.²⁹¹

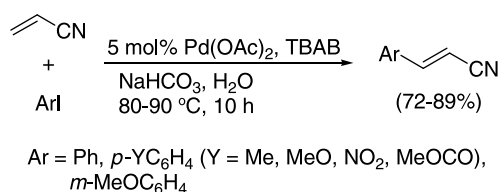

Scheme 91.

Amberlite IRA-400 (basic) was found to have a dual role in assisting the Heck reaction as a base and as a phase-transfer catalyst after salt formation.²⁹² This catalytic system exhibited a good performance in the stereoselective Heck reaction of bromobenzene, *p*-iodotoluene and *p*-iodoanisole with a representative variety of olefins (Scheme 92). The

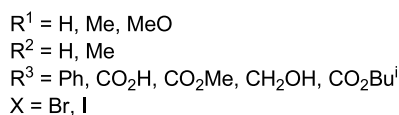
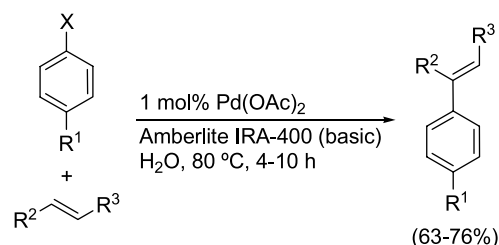

Scheme 92.

work-up procedure was very simple and the resin could be regenerated and recycled.

An insoluble phosphane-free cyclopalladated ferrocenyl-imine, at very low concentrations, was successfully applied to the Heck coupling of aryl iodides and bromides with different olefins in neat water (Scheme 93).²⁹³ The optimised reaction conditions involved the use of TBAB and Et₃N as the phase-transfer agent and base, respectively. All the reactions were conducted in air under reflux, furnishing the expected coupled products in moderate to excellent yields (most of the yields were >90%). In spite of the fact that the catalyst had to be prepared from the relatively expensive, acetyl ferrocene, the amounts used in each reaction were very low.

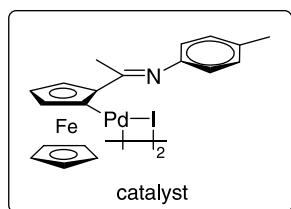
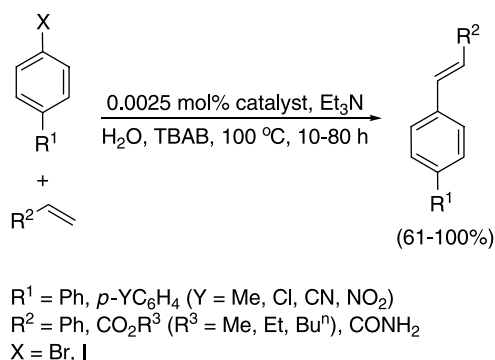

Scheme 93.

Another protocol consists of using an aqueous biphasic medium (instead of neat water), also in the absence of phosphane ligands. Williams et al. studied in detail the Heck reaction between iodobenzene and *n*-butyl acrylate with various combinations of polar solvent, solvent-water mixtures, ligand and added base.²⁹⁴ The results showed that DMF or DMF–H₂O were the solvents of choice, the origin of the catalyst [Pd(OAc)₂ or Pd(dba)₂] making little difference to the yield. *n*-Butyl cinnamate was obtained in 95% yield using 0.1 equiv Pd(OAc)₂ and Et₃N in a 1:1 DMF/H₂O mixture at 80 °C for 24 h in the absence of any added ligand. Unfortunately, the reaction with bromobenzene or 4-bromobenzene failed under the above reaction conditions.

Based on a similar catalytic system, Hallberg et al. reported a highly asymmetric chelation-controlled Heck arylation of a prolinol vinyl ether, as an alternative approach to the synthesis of 2-aryl-2-methylcyclopentanones.²⁹⁵ The phosphane-free catalytic system, utilised in a 1:10 H₂O/DMF solvent mixture and under air, provided moderate to good yields and excellent enantioselectivities of the isolated cyclopentanones (Scheme 94). An *N*-chelated

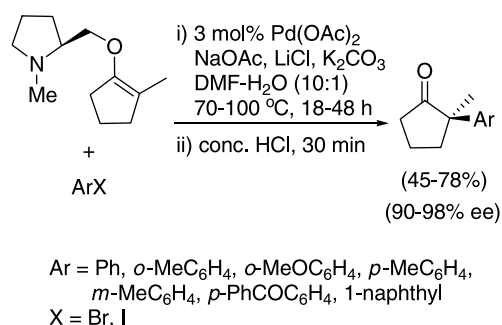

Scheme 94.

π -intermediate was suggested to account for the excellent regio- and stereochemical outcome of the arylation.

A different protocol was applied by the same group concerning the palladium-catalysed regioselective internal arylation of alkyl vinyl ethers with aryl and heteroaryl bromides, which was carried out in aqueous DMF, with K₂CO₃ as base and dppp as bidentate ligand.²⁹⁶ The arylated products were transformed into the corresponding aryl methyl ketones after acidic treatment, which were obtained in good to high yields and excellent regioselectivities (Scheme 95). In addition, vinyl bromides were converted into the corresponding α,β -unsaturated methyl ketones, albeit with rather low yields. Contrary to the internal couplings with aryl bromides, the analogous aryl iodides delivered essentially nonselective regioisomeric product mixtures. Unfortunately, the reaction times are quite long, although an example was reported in which the reaction time was shortened to 1 h at 122 °C in a microwave synthesiser.

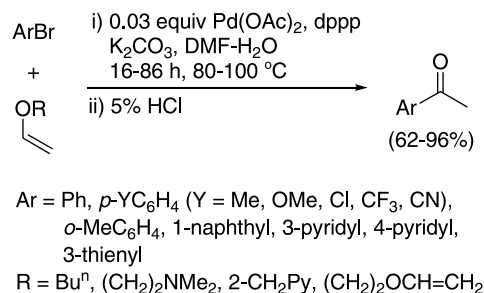

Scheme 95.

A new water-soluble phosphane ligand bearing carboxylate groups, *m*-TPPTC, was prepared by Genêt et al. and tested in the Heck arylation of ethyl acrylate and styrene with iodobenzene in aqueous organic solvents.²⁹⁷ Complete conversion of ethyl acrylate was achieved in the presence of 1 mol% Pd(OAc)₂ and 3 mol% ligand, using Et₃N as a base in a 6:1 MeCN/H₂O mixture at 80 °C for 45 min. For styrene, 76% conversion was obtained using the same catalytic system, but with Pr₂NH as a base, at 80 °C for 22 h. Alternatively, an NMP–H₂O solvent mixture also provided good results at a higher temperature (110 °C). The palladium-catalysed coupling of 4-methoxyiodobenzene with 2,3-dihydrofuran, using 5 mol% Pd(OAc)₂ and 15 mol% ligand in a MeCN–H₂O mixture at 40 °C, led to the corresponding 2,3-dihydrofuran derivative in 95% yield and 95:5 regioselectivity. Moreover, when this catalytic

system was applied to the intramolecular Heck reaction of two iodoanilides, the desired lactams were obtained in 99% isolated yields after 1 h at 80 °C (Scheme 96).

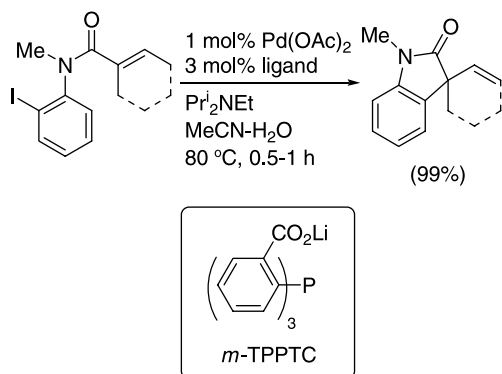

Scheme 96.

The sterically demanding, water-soluble tris(4,6-dimethyl-3-sulfonatophenyl)phosphane trisodium salt (TXPTS), was applied by Shaughnessy et al. to the aqueous-phase Heck coupling of aryl bromides with styrene and sodium acrylate.²⁹⁸ The catalyst derived from TXPTS gave higher yields, in comparison with the more common TPPTS, and under relatively mild reaction conditions (Scheme 97). Both electron-donating and electron-withdrawing substituents on the aryl bromide gave high yields of products, whereas an ortho substituent decreased the yield. Due to partial hydrolysis under the coupling reactions, sodium acrylate had to be used instead of the corresponding *n*-butyl ester. Under very similar reaction conditions, the ligand, 2-(di-*tert*-butylphosphino)ethyltrimethylammonium chloride, was also found to be superior to TPPTS.²⁹⁹ Attempts to couple an activated aryl chloride, as well as to use other solvents such as water or water–toluene, were, however, unsuccessful. As a result, the catalyst could not be recycled.

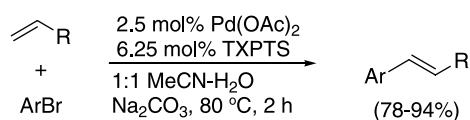

Ar = *p*-YC₆H₄ (Y = Me, MeO, MeCO), *o*-MeC₆H₄,
2-Me,4-MeOC₆H₃
R = Ph, CO₂Na

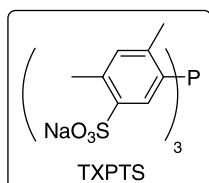

Scheme 97.

Nájera et al. designed a new palladium-dipyridylmethylamine complex that found application in the homogeneous Heck reaction of iodo-, bromo- and chlorobenzene with acrylates and *p*-chlorostyrene in DMF, NMP–H₂O and H₂O.³⁰⁰ TBAB had to be added to the reaction mixture in the case of bromo- and chlorobenzene. In general, very high yields were obtained for the coupled products derived from

iodobenzene and bromobenzene, either in neat water or in a 3:1 NMP/H₂O mixture (Scheme 98). Chlorobenzene, however, only reacted with *p*-chlorostyrene in NMP–H₂O at 160 °C using 0.5 mol% catalyst, leading to a 2:1 mixture of regioisomers. Despite the ligand being readily prepared after four steps (62% overall yield) and the TONs being high, the TOFs are rather low and relatively harsh reaction conditions are required, in comparison to the above-described methodologies.

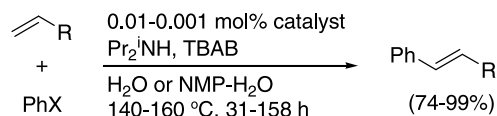

R = CO₂Bu^t, CO₂Bu^t, *p*-ClC₆H₄
X = Br, I

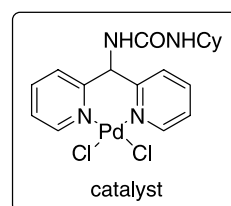

Scheme 98.

More recently, Nájera's group reported the mono- and β,β-diarylation of α,β-unsaturated carbonyl compounds with electron-deficient and electron-rich aromatic iodides in water, under the catalysis of a *p*-hydroxyacetophenone oxime-derived palladacycle.³⁰¹ The reactions were carried out in refluxing water or under microwave heating using (dicyclohexyl)methylamine as a base and a low catalyst loading (≤ 1 mol%), the expected products being obtained in moderate to excellent yields (Scheme 99). The mono- and diarylation reactions could be controlled in most of the cases, although they both failed when aryl bromides were used instead of aryl iodides. In general, lower yields were obtained for the diarylated products, the diarylation only failing with *p*-fluorobenzene. The catalyst remained active

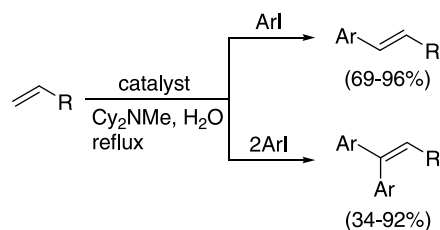

R = CO₂Bu^t, CONMe₂, CN, COMe
Ar = Ph, *p*-XC₆H₄ (X = F, Cl, MeO)

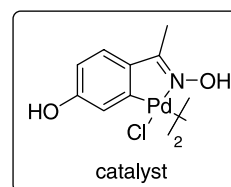

Scheme 99.

upon addition of more substrates in both the mono- and diarylation processes, with total conversion after four consecutive cycles. This methodology, applied to the arylation of different styrenes, allowed the preparation of methylated resveratrol and analogues in high yields, with total *E* stereoselectivity and variable regioselectivity.³⁰²

Sinou et al. described the asymmetric arylation of 2,3-dihydrofuran with aryl triflates in water, in the presence of the surfactant, *n*-C₁₆H₃₃N⁺Me₂(CH₂)₃SO₃⁻ (HDAPS) and (*R*)-BINAP as the chiral ligand.³⁰³ The reactions proceeded with high regioselectivity under mild conditions, but both the conversion and the enantiomeric excess were moderate (Scheme 100).

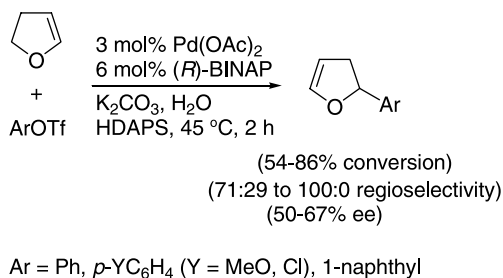

Scheme 100.

We have already commented in Section 5.2.4 on the high performance exhibited by an amphiphilic polystyrene-poly(ethylene glycol) resin-supported palladium-phosphane complex in the Heck reaction of aryl iodides and olefins in water (see Scheme 56). In contrast to some of the examples presented above, the catalyst could be recycled, leading to a 92% average yield after five continuous runs.¹⁹⁰

In the context of heterogeneous palladium-catalysed Heck reactions, Sasson et al. reported the reaction of aryl chlorides, bromides and iodides with styrene, catalysed by Pd/C in water.³⁰⁴ The reactions were carried out with catalytic amounts of Pd/C (0.7 mol%) and PEG-400 (8.5 mol%) in the presence of sodium formate as reducing agent and water as solvent in an autoclave (100 °C) for 5.5 h. In addition to the expected Heck products (12–61%), the formation of the hydrogenated Heck products (2–25%), together with some hydrogenation of styrene to ethylbenzene (8–22%), plus the respective homocoupling (9–43%) and hydrodehalogenation (11–76%) products, were observed. Filtration experiments demonstrated that the Pd/C alone was responsible for the catalysis. This methodology, although interesting from the point of view of the separation and possible re-use of the catalyst, needs to be improved as regards the conversion and selectivity, in order to have a more practical application.

It is noteworthy that Heck-type reactions involving arylboronic acids and styrenes could be carried out under rhodium catalysis in aqueous media. This methodology is based on the use of water-soluble ligands such as TPPDS, TPPTS or *m*-TPPTC and has been studied independently by the groups of Lautens⁷⁰ and Genêt (see Scheme 10 and comments in Section 4.1).⁷¹ Despite the advantageous properties shown by *m*-TPPTC in Genêt's report, the

coupling reactions of boronic acids and styrene derivatives proceeded with better yields in the absence of any phosphane ligand under the same reaction conditions, this certainly being the main improvement in this methodology (Scheme 101).

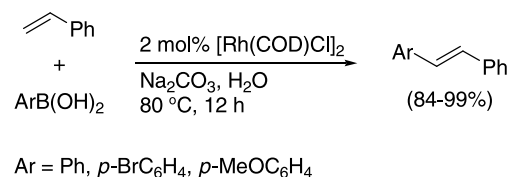

Scheme 101.

To use water to replace totally or partially an organic solvent is, without any doubt, beneficial from the environmental point of view. The advantage of using water (mainly as the cosolvent) in Heck reactions is also confirmed by the introduction of this methodology as a crucial step in total synthesis.³⁰⁵ Nonetheless, we believe that the trend in the near future of the Heck reaction in aqueous media must improve and combine the use of neat water (limiting the use of organic solvents only for extraction, if necessary), together with a recoverable and re-usable catalyst.

7. Reaction conditions

7.1. Physical activation

7.1.1. Microwave. During the preparation of this manuscript, a book about microwave-assisted organic synthesis has been published,⁴⁵ⁿ in which Larhed and Kristofersson have dedicated one chapter to review and update the microwave assisted carbon-carbon coupling reactions, including the Heck reaction. This revision, in addition to some other recent revisions which have appeared in the literature,^{45j-p} make it unnecessary to present herein the different studies carried out in this area. Instead, a short analysis of the application of this non-conventional technique to the Heck reaction, together with some contributions in 2004, follows.

The first examples of Heck reactions promoted by microwave heating were conducted by the group of Larhed in 1996 in a single-mode cavity in septum-sealed Pyrex vessels.³⁰⁶ Since then, MW heating has been applied extensively in the Heck reaction using different substrates, catalysts and reaction conditions.^{45j-p} Aryl bromides, iodides and triflates, as well as vinyl triflates, worked well and regioselectively in the coupling with both electron-poor and electron-rich olefins, including even enols. The versatility of MW allowed the Heck couplings to be performed following different protocols such as in water under phase-transfer conditions or utilising water-soluble ligands, with ligand-free catalytic systems, under heterogeneous conditions with supported catalysts, in the absence of solvent or, most commonly, in solvents. In general, the same product patterns were essentially observed as in the reactions performed with thermal heating. The rapid heating induced by the radiation, however, led to the formation of

products under mild reaction conditions with short reaction times, avoiding decomposition or side reactions, and sometimes increasing the yields.

As a recent example of microwave-promoted Heck reactions, Bergbreiter et al. utilised an air-stable, water-soluble oligo(ethylene glycol)-bound SCS palladacycle to catalyse the coupling of several aryl halides and alkenes at 150 °C employing microwave heating.³⁰⁷ Either DMA or D₂O were used as the solvents for organic-soluble or water-soluble coupling partners. The products were obtained in moderate to good yields and in short reaction times (Scheme 102). Catalyst recycling was carried out using a thermomorphic solvent mixture consisting of aqueous DMA–heptane, the products being directly isolated from the heptane phase. No added solvent was necessary for the product and catalyst isolation and the catalyst recycling only required the addition of a fresh substrate solution to the mixed aqueous solution of catalyst.

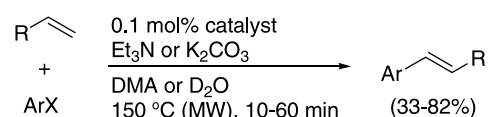

R = Ph, 4-pyridyl, CO₂H, CO₂Me, CO₂Bu^t, CONMe₂
 Ar = Ph, *m*-HO₂CC₆H₄, 2-Me,5-HO₂CC₆H₃,
 1-naphthyl
 X = Br, I

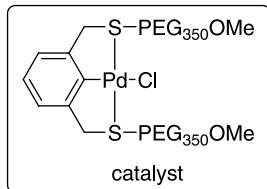

Scheme 102.

Larhed et al. have recently developed a rapid protocol for microwave-assisted regioselective double β -arylation of the chelating vinyl ether *N,N*-dimethyl-(2-ethenyloxy)ethanamine, using Herrmann's catalyst **30** as the palladium source.³⁰⁸ By proper selection of the experimental parameters, it was possible to achieve symmetrical and nonsymmetrical terminal β,β -diarylations with both electron-rich and electron-poor aryl bromides. The symmetrical diarylation was carried out in sealed vessels under air, affording mixtures of the α,β - and β,β -diarylated products in a 29:71–5:95 ratio (Scheme 103). Fortunately, the latter products could be purified by column chromatography.

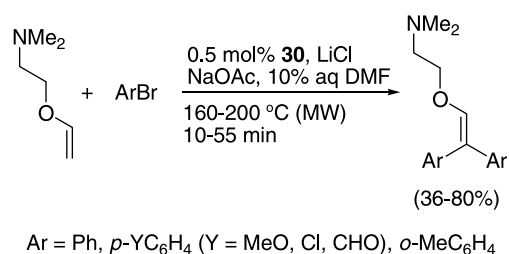

Scheme 103.

Classic heating at 180 °C furnished almost identical reaction results to microwave heating. Using almost identical reaction conditions, aryl bromides were reacted with β -arylated olefins, giving rise to unsymmetrical β,β -diarylated products with a β,β selectivity of >91:9, but a low stereoselectivity.

As a recent example of microwave-assisted intramolecular Heck cyclisation, Gracias et al. subjected several γ,δ -unsaturated amino esters, derived from an Ugi four-component reaction and bearing a haloaryl moiety, to Heck cyclisation under microwave heating.³⁰⁹ In this case, the reaction required the presence of Ph₃P, the resulting nitrogenated heterocyclic compounds being obtained in high yields and short reaction times (see one example in Scheme 104).

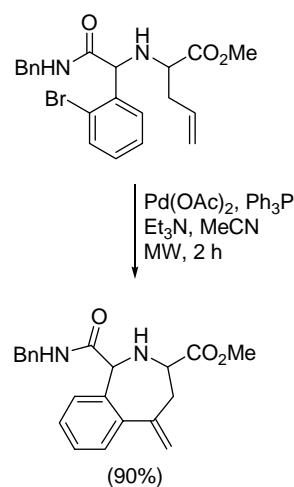

Scheme 104.

Despite the clear advantages that microwave-assisted synthesis offers,³¹⁰ there are still some issues which require further studies in order to be properly addressed. The health hazards of microwave radiation are still under investigation and it is not yet known whether a low-level exposure is detrimental. The recommended safety levels tend to move in the direction of lower doses of radiation, so great care should be taken to minimise microwave leakage. Another potential hazard is the formation of electric arcs in the cavity. Although microwave-heated organic reactions can be smoothly conducted in open vessels, closed vessels sealed under an inert gas atmosphere to reduce the risk of explosions are recommended, especially if superheating or high-pressure conditions are desired.

Both the multi- and monomode microwave reactors have been shown to work successfully for small-scale organic synthesis, in particular for the rapid optimisation of reaction conditions and in the context of the drug-discovery process. There is, however, a clear need to develop larger-scale microwave-assisted organic synthesis techniques, which can ultimately provide products on a kilogram scale. In this context, it is worthy of note that the feasibility of direct scale-up from a single-mode microwave reactor to a larger multimode system has been recently demonstrated by Kappe et al. in the Heck reaction.³¹¹ For scale-up, both

homogeneous and heterogeneous palladium-coupling conditions were employed for experiments on a 4×20 mmol scale in the multimode batch reactor, the yields obtained closely agreeing with those in the small-scale experiments.

7.1.2. Ultrasound. Standard Heck reactions, which are carried out in polar solvents such as DMF and NMP, generally involve long reaction times (8–72 h) at temperatures ranging from 80 to 140 °C. Even in ILs, these parameters are still high. To the best of our knowledge, Srinivasan et al. have reported the only example of a Heck reaction promoted by ultrasound using an IL as solvent at ambient temperature.²⁶⁰ The reactions were carried out in a thermostatted ultrasonic cleaning bath of frequency 50 KHz at 30 °C with complete conversion of iodobenzenes in 1.5–3 h (see Scheme 80 and the corresponding comments). No reaction, even in trace amounts, could be observed under ambient conditions in the absence of ultrasound. Unfortunately, the reaction did not proceed with aryl chlorides and bromobenzene under the reported sonochemical conditions.

Bräse et al. developed a traceless linker system of the triazene type to immobilise aryl halides, with application to the Heck reaction with a variety of olefins under ultrasonic conditions (Scheme 105).³¹² The halogenated resins were air and water stable, they could be stored for long periods without loss of activity, and the recovered resins could be re-used with a slight loss of activity (<10%). In this case, no comment was made about the advantages of using ultrasound, compared to the standard Heck conditions.

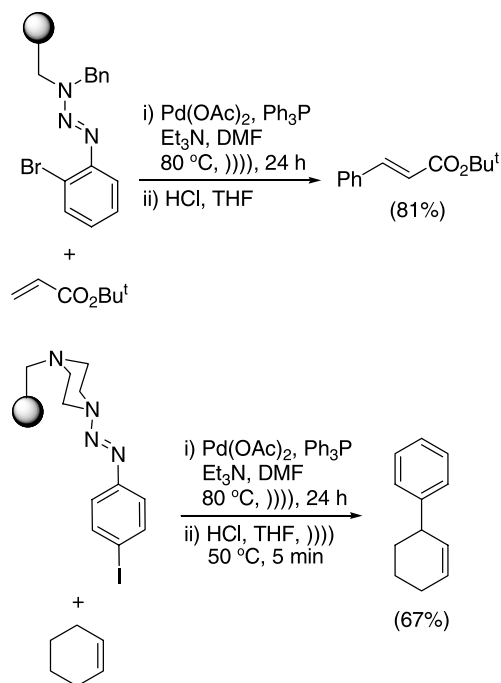

Scheme 105.

On the other hand, ultrasound was also utilised to induce the reduction of Pd(II) salts to Pd(0), the activity of the latter species being examined in the Heck reaction. When a 1:2 mixture of Pd(OAc)₂ and myristyltrimethylammonium bromide was subjected to sonochemical reduction in THF

or MeOH at room temperature, nanoscale particles of palladium metallic clusters were obtained.³¹³ Apart from its stabilising effect, the ammonium salt was suggested to act as a reducing agent, probably due to the decomposition that occurs at the liquid-phase region immediately surrounding the collapsing cavity, providing reducing radicals. The sonochemical reduction of Pd(II) could be enhanced by the addition of 0.2 M EtOH–MeOH in the THF process, its highly volatile nature producing various reducing radicals inside the collapsing bubble. UV–vis spectroscopic analysis revealed the initial formation of a Pd(II)–NR₄X complex, which, in turn, was reduced to Pd(0). Elemental analysis of the resulting solid after sonication showed that the THF process yielded NR₄X stabilised-palladium clusters, whereas the methanol process produced pure Pd agglomerates. These Pd nanoclusters, either in situ supported on charcoal or NR₄X stabilised, were catalytically active towards the Heck reaction between bromobenzene and styrene in the absence of phosphine ligands, but to a moderate extent of 30% conversion.

The little work published on ultrasound applied to the Heck reaction makes it difficult to balance the advantages and disadvantages. Some of the advantages have been clearly demonstrated in the above examples, together with some other more general benefits such as the simplicity of the method, involving little work-up, its adaptability to heterogeneous reactions and the possibility of it being applied to large-volume reactions. On the other hand, the lack of generality, cost of equipment and hazardous temperature control may be mentioned as general disadvantages of this technique.

7.1.3. High pressure. Pressure in the range of 1–20 kbar strongly influences the rate and equilibrium position of processes accompanied by a decrease in volume such as carbon–carbon bond formation. These processes, in which the distance between two carbon atoms decreases from the van der Waals distance of ca. 3.6 Å to the bonding distance of ca. 1.5 Å, are accelerated by pressure and the equilibria are shifted towards the side of the products.

Considering the generally accepted mechanism for the Heck reaction, it is evident that several steps in the catalytic cycle should be pressure dependent. The following steps are considered to be accelerated under high-pressure conditions, because they might have negative activation volumes: (a) formation of the active Pd(0) species, (b) oxidative addition of Pd(0) to the carbon–halogen bond, (c) complexation of palladium species with the olefin and (d) formation of the quaternary ammonium salt. The insertion, migration and re-insertion steps should be invariant, whereas the reductive elimination and decomplexation of the catalyst should be disfavoured by pressure. The net volume balance has a negative sign and, therefore, pressure may be a very useful parameter to activate Heck reactions, which otherwise would not occur or would take place only sluggishly. In addition, the activity of the palladium catalyst does not decrease at high pressure, which is capable of stabilising PdL_n species by enforcing ligand coordination.³¹⁴

Pioneering work in this field was carried out by the groups

of Reiser³¹⁵ and de Meijere³¹⁶ in 1993 and 1994, respectively. Reiser et al. described the dramatic influence on the regioselectivity and the ligand-induced enantioselectivity of the palladium-catalysed arylation of 2,3-dihydrofuran by high pressure.³¹⁵ Firstly, it was observed that, at normal pressure, the addition of triphenylphosphane led to little change in the regioselectivity, and this was always in favour of the 2,3-dihydrofuran derivative. In contrast, the 2,5-dihydrofuran derivative became the major product by adding triphenylphosphane at 10 kbar. This behaviour was also observed when Pd-BINAP was used as a chiral catalyst, together with a substantial improvement in the enantioselectivity for the 2,3-dihydrofuran derivative (Scheme 106).

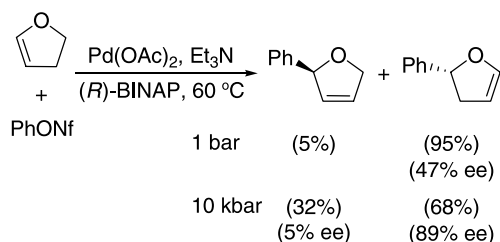

Scheme 106.

De Meijere et al. also studied the palladium-catalysed coupling of 2-bromocyclohexene with styrene under 10 kbar to furnish 1-styrylcyclohexene in 82% yield after 2 days at 20 °C, whereas a control experiment under ambient pressure led only to traces of the product (Scheme 107).³¹⁶ Alternatively, the product was obtained in 51% yield starting from 1-(trifluoromethylsulfonyloxy)cyclohexene, instead of the bromide, under the same reaction conditions. Coupling of styrene to dienyhalides under 10 kbar at 20–60 °C afforded the 1,6-disubstituted 1,3,5-hexatrienes in near-quantitative yields, while no product was observed under the same conditions at ambient pressure (Scheme 107). Moreover, when 1,2-dibromocyclopentene, 1,2-dibromocyclohexene and *o*-dibromobenzene were treated with styrene under these conditions, but at 55 °C, the 2-fold coupling products were obtained in 18–82% yield, no product being formed at ambient pressure (Scheme 108).

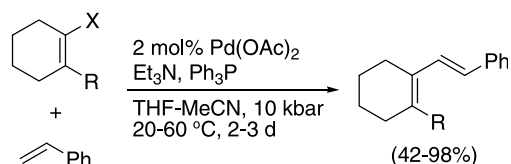

R = H, CH=CHCN, CH=CHCO₂Me
X = Br, Cl, OTf

Scheme 107.

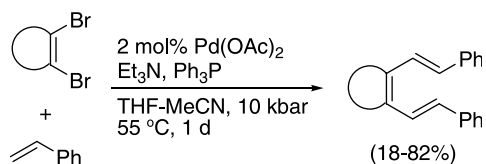

Scheme 108.

The different advantages of using high pressure on Heck reactions were additionally supported by the studies of Sugihara et al. in the coupling of aryl iodides with ethyl acrylate,³¹⁴ of Reiser et al. in the coupling of iodobenzene with 2,3-dihydrofuran, *N*-ethoxycarbonyl-2,3-dihydropyrrole and cyclopentene,³¹⁷ and of Tietze et al. in the intramolecular Heck reaction for the synthesis of isochromanes, isoquinolines and benzazepines.³¹⁸ These publications were recently reviewed in detail by Reiser et al.³¹⁹ In general, the catalyst performance was improved by high pressure, leading to higher yields, better TONs numbers and rates, and increased selectivity, demonstrating that the ligand exchange on catalytic species is viable under pressure.

More recently, a very interesting and detailed contribution by de Meijere et al. was reported, in order to better understand the mechanism and influence of high pressure on the Heck reaction.³²⁰ To achieve a more accurate kinetic analysis, this group applied quantitative on-line FT-IR spectroscopy for measuring concentrations in the Heck reaction of iodobenzene with methyl, ethyl and *tert*-butyl acrylate, and of both 4-nitrophenyl iodide and 4-nitrophenyl triflate. The results obtained revealed that the activation volumes correlated with the degrees of steric congestion for the variation of the alkyl groups in the acrylates and of the leaving group in the nitrophenyl derivatives. The more highly congested systems provided more negative activation volume values, while the activation enthalpies and entropies were virtually independent of the reactants. The rate coefficients for the coupling of iodobenzene with the alkyl acrylates followed the trend: *tert*-butyl > ethyl > methyl acrylate, while those for the coupling of the nitrophenyl derivatives with methyl acrylate followed the trend: *p*-nitrophenyl triflate > *p*-nitrophenyl iodide. These orders were consistent with the notion that the coordination and insertion steps of the acrylate are rate determining. Therefore, the rate-determining step of the overall catalytic cycle of the Heck reaction under high-pressure conditions is not the oxidative addition, as this is assumed to be the rate-determining step at ambient pressure.

It has been shown that the high-pressure technique not only activates the Heck reaction, but also can have a decisive role in controlling the regio- and stereoselectivity of the process. This technique is normally excellent in reproducibility although it is mainly applied to low-volume and homogeneous reactions, because of the difficulty of mixing. In addition, the cost of equipment and the safety issues can limit its application.

7.2. Physicochemical activation

7.2.1. Micellar solutions. Hybrid palladium colloids in the core of amphiphilic block copolymer micelles showed catalytic activity in the Heck reaction. These dispersions of nanometer-sized palladium colloids were prepared in block copolymer micelles of polystyrene-*b*-poly-4-vinylpyridine and exhibited a very high stability.³²¹ The activities of these colloids compared well with those of the standard materials. The yields were high in the coupling of activated bromoarenes with styrene and *n*-butyl acrylate (60–99%) at 140 °C in toluene and Bu₃N. In general, however, the

reactions were very slow (up to 5 days), very low yields being obtained for non-activated haloarenes, and no comment was made concerning the possibility of catalyst recycling.

Sakurai et al. prepared shell cross-linked micelles (SCM), where the polysilane core was surrounded by a partially cross-linked shell of poly(methacrylic acid), and used then as the template for the synthesis of metal nanoparticles.³²² Reduction of Pd(II) with the polysilane SCM produced Pd(0) particles, which were highly dispersed in water. SCM–Pd (0.01 mol%) catalysed the Heck reaction of styrene or methyl acrylate with iodobenzene in DMF and Et₃N at 120 °C, giving the coupled products in 82 and 96% yield, respectively. Despite the very interesting nature of this catalytic system, its preparation is rather sophisticated, involving some non-commercially available starting materials and reagents.

7.2.2. Electrochemical activation. Electrochemical reactions with catalytic amounts of low-valent nickel and palladium species, generated in situ from Ni(II) or Pd(II) precursors, have found application in one step coupling processes.³²³ These electrolyses are conducted generally at relatively low reduction potentials, avoiding the direct reduction of the organic compounds. Most synthetic applications in electrochemically assisted nickel- and palladium-catalysed carbon–carbon bond-forming reactions have, however, been carried out in the field of reductive coupling, while the electrochemical version of the Heck reaction has been little studied.

In 1996 Reetz et al. devised an electrochemical process to transform palladium bulk into nanostructured palladium clusters, using a palladium sacrificial anode as the metal source in a simple electrolysis cell containing NaCl in propylene carbonate (with 5% ethanol) at 60 °C.³²⁴ The electrochemical process involved the anodic dissolution of the palladium sheet with the intermediate formation of Pd(II) ions, which migrate to the cathode, where they were reduced back to the zero-valent state. Propylene carbonate was used as a stabilising agent for the clusters to prevent metal powder formation. These palladium clusters showed a good performance in the Heck reaction of activated bromobenzenes with styrene at 130 °C (70–100% conversion, 79–96% yield), whereas unactivated bromo- and chlorobenzene showed only poor to moderate conversion even at 160 °C (Scheme 109). The black palladium cluster solution was stable at 155 °C for several days, although any other manipulation (removal of the solvent or immobilis-

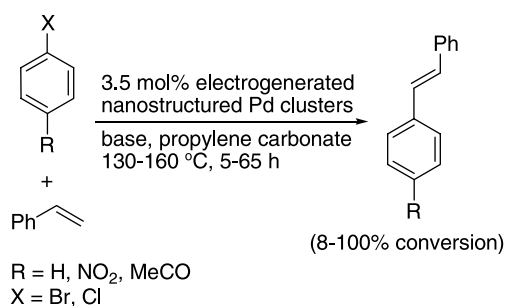

Scheme 109.

ation on a solid support) led to large amounts of palladium powder that could not be redispersed in propylene carbonate.

More recently, Gosmini et al. developed a consumable anode process for the electrochemical Heck reaction between aromatic or vinylic halides and acrylic esters, using cobalt(II) bromide as catalyst associated with 2,2'-bipyridine as ligand, in a mixture of MeCN–Et₃N–pyridine at 70 °C (Scheme 110).³²⁵ All reactions were conducted in a one-compartment cell at a constant current intensity of 0.2 A with an iron consumable anode, associated with a stainless-steel grid as the cathode, in the presence of tetra-*n*-butylammonium tetrafluoroborate to ensure ionic conductivity. Unfortunately, the reaction showed little selectivity leading to a mixture of the expected substitution and conjugate addition products, together with some other minor by-products. The presence of triethylamine, pyridine and 2,2'-bipyridine enabled a higher substitution versus addition product ratio.

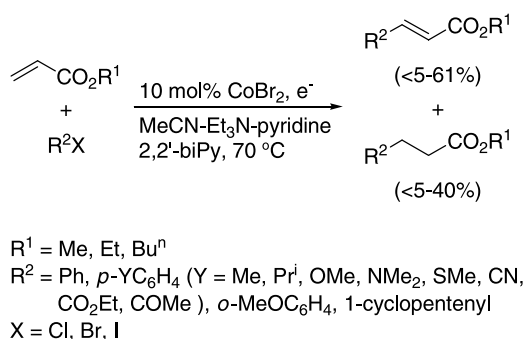

Scheme 110.

Despite the advantages of the electrochemical methods outlined in the introductory section, very little research has emerged on this technique applied to the Heck reaction. Much effort is still required in order to improve both the yield and selectivity of the work reported so far, as well as to have a better knowledge of the scope and limitations of this technique.

8. Miscellaneous non-conventional techniques

8.1. Nanofiltration

Livingston et al. developed a new approach for the separation and recycling of homogeneous Heck catalysts from post-reaction mixtures, based on the use of solvent-resistant nanofiltration membranes.³²⁶ Different catalytic systems were tested for the standard Heck coupling of iodobenzene and styrene. In contrast with the continuous operation mode for nanofiltration-coupled catalysis, the catalysis and nanofiltration stages were still coupled, but operated independently, allowing more flexible operating conditions and lower reactor occupancy. For all the reactions studied, neither the product nor the remaining reactants were retained during the filtration, the membrane selectivity towards the catalyst being high ($\leq 96\%$ palladium rejection). The ammonium salt formed as a

by-product precipitated out and could be easily removed from the reactor, before refilling it for the subsequent run. Consequently, a cleaner form of the product in the corresponding solvent was obtained on the permeate side. In the first catalytic system, $\text{Pd}(\text{OAc})_2(\text{PPh}_3)_2$ was recycled 6-fold before the reaction rate dropped below 20% of the original value, with a cumulative TON of 690 in 120 h. Substantial improvements in the system performance were obtained by employing catalysts with a greater chemical stability. An imidazolydinene catalyst yielded an equal TON for six recycles in 40 h with less reaction rate decline, whereas $\text{Pd}(\text{OAc})_2$ stabilised by a quaternary phosphonium salt gave six recycles under 30 h. The higher reaction rates achieved with the two latter catalytic systems minimised both the reactor occupancy and the waste generated by downstream processing.

Zeolite membranes were utilised by Santamaría et al. to separate palladium complexes in mixtures representing possible post-Heck scenarios.³²⁷ The reaction of 4-bromobenzonitrile with methyl acrylate was chosen as a Heck example reaction, the catalyst being $[\text{Pd}(\mu\text{-Cl})(\text{PPh}_3)_2]_2(\text{BF}_4)_2$. Separation experiments using a first mixture composed of the Pd complex, DMA and the product were unsuccessful. In contrast with this work, good separation was attained in experiments where dichloromethane was used as the solvent. Complete retention of the Pd complex occurred with simultaneous permeation of both the solvent and the product.

We have already commented in Section 5.2.4 on the application of a polymer-enlarged catalyst, formed from (1-Ad)₂P-substituted poly(methylstyrene) (**25**) and $[\text{Pd}(\text{dba})_2]$, to the Heck reaction of aryl bromides with *n*-butyl acrylate.²⁰⁸ Nanofiltration of the NMP solution was estimated to render less than 0.5% polymer leaching, with a retention of the catalyst by the membrane >99.95%. Even after diluting the NMP solution with a large amount of cyclohexane, the catalyst performance decreased significantly after the second cycle. The coupling yields were 80–87%, but the catalyst could not be recycled since attempting nanofiltration in the highly polar and aprotic medium resulted in severe membrane damage.

The membrane technology seems to be a very promising technique for the Heck reaction using homogeneous catalysts. Its application involves the design of special reactors together with the selection of optimum parameters such as the membrane pore and composition, solvent and flux system, or the transmembrane pressure. At any rate, the development of more resistant membranes and improving the reactor technology is desirable, since these factors largely determine the applicability of membrane technology in homogenous catalyst recycling.

8.2. Microreactors

Two examples of the application of continuous-flow microreactors to the Heck reaction have appeared recently in the literature. Kirschning et al. developed a continuous-flow microreactor with an interior monolithic glass-polymer composite that was loaded with palladium particles by ion exchange, followed by reduction.³²⁸ This microreactor

allowed the coupling of 4-iodoacetophenone with *n*-butyl acrylate and of 4-iodoanisole with isobutyl acrylate in DMF as solvent and Et_3N as base at 110–130 °C for 0.5–2.5 h (>78% yield). The work-up was very simple and the catalytic system could be re-used more than 20 times after washing.

The methodology developed by Ryu et al. for the coupling of aryl iodides with *n*-butyl acrylate using the low-viscosity IL, $[\text{bmim}][\text{NTf}_2]$ (see Scheme 111),²⁵⁸ was extended to a continuous microflow system and applied to the particular Heck reaction of iodobenzene with *n*-butyl acrylate.²⁵⁹ A CPC CYTOS Lab System was used as the microreaction apparatus, in combination with a microextraction-catalyst recycling system, to continuously recycle the reaction medium. A palladium–carbene complex soluble in the IL was used as the catalyst, the low viscosity of the IL being essential to ensure a smooth flow by the action of the pump. The temperature of both the microreactor and the residence time unit was controlled at 130 °C, with a residence time of 17 min at a total flow rate of 1.0 ml/min. The ammonium salt could be removed from the resulting IL layer by washing with copious amounts of water. Under these reaction conditions, yields >90% were obtained and the recovered IL could be used again in the next run without any drop in the product yield (90–99%). Alternatively, microextraction units were attached to the microflow reaction system in order to facilitate the extraction of the product and the ammonium salt and to pump back the IL layer containing the palladium catalyst. A total of 115.3 g of *n*-butyl cinnamate could be prepared in 80% yield at a rate of 10 g/h. Scheme 111 represents a schematic drawing of the automated microflow apparatus. The whole methodology is remarkable in the sense that the great effort needed to design the apparatus in an automatic manner was compensated for the possibility of a multi-ten gram-scale preparation of *n*-butyl cinnamate, a task very difficult to achieve using any other of the methodologies described in this review. Nonetheless, the complete apparatus has a high economical cost and the product required further purification by silica gel chromatography, with the consequent and proportional use of silica gel and eluting solvents (for 115 g of product).

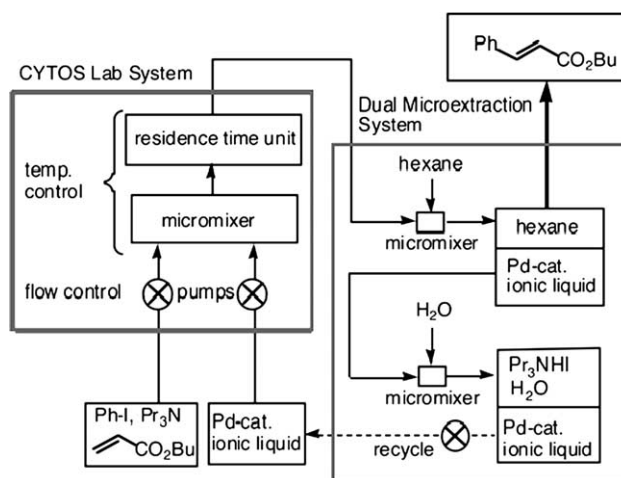

Scheme 111.

8.3. Ball-milling conditions

To the best of our knowledge, the only Heck reaction under ball-milling conditions has been recently reported by Frejd et al., involving the synthesis of unsaturated unnatural amino acids from protected amino acrylates and aryl halides.³²⁹ These reactions were performed using a Fritsch Planetary Micro Mill model, housing two stainless-steel cups, each containing eight stainless steel balls, and sealed by a stainless-steel lid fitted with a Teflon gasket. The presence of TBAC was crucial for the success of the reaction, whereas the addition of sodium formate as a reductant for Pd(II) improved the yields. The Z-products were obtained in yields ranging from low to good for aryl iodides and bromides, but no reaction was observed for aryl chlorides (Scheme 112).

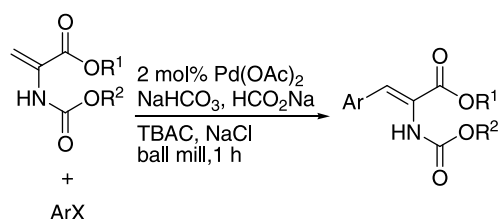

R¹ = Me, Bn

R² = Boc

Ar = Ph, *p*-YC₆H₄ (Y = NH₂, MeO), *m*-NCC₆H₄,
3-furyl, 2-thienyl

X = Br, I

Scheme 112.

9. General conclusions

We have presented in this report some recent trends in the Heck reaction that highlight the efforts and interest in developing more efficient processes according to the new requirements of the chemistry of the 21st century. A vast array of methodologies has been described, any of which intervenes in a non-conventional way over one or more of the different parameters involved in the reaction: substrates, catalytic system, solvent, reaction conditions, or work-up. Very often, however, the dynamic of the research seems to be driven more because of the current fashions than because of the real need in achieving practical procedures. As a result, we can enjoy a variety of methodologies that are very interesting from an academic point of view, but most of these are useless from a practical point of view.

Anyway, we would like to point to a series of present issues, that in our opinion, still need to be addressed, as well as to outline the possible future direction of the research in order to achieve the goals mentioned in the introduction section. (a) Most of the methodologies which have appeared in this review deal with the simpler reactions involving the most reactive substrates, that is, the reaction of aryl iodides or activated aryl bromides with acrylates; in contrast, little work has been done concerning the use of the more desirable, but reluctant to react, aryl chlorides or other olefinic substrates (e.g., electron-rich olefins). (b) Only highly regio- and stereoselective reactions are worthwhile, the formation of by-products being a procedural and

economical problem due to the additional purification steps and the difficulty of separating compounds of similar polarity. (c) Whenever possible, commercially available starting materials, reagents, ligands, catalysts, or solvents must be used; it is contradictory that we try to recycle a catalytic system (e.g., to minimise waste generation and to make the process more economical) and that rather long or minimally-effective experimental work is needed to prepare the different reaction components. (d) The catalyst must be recyclable and/or display high TONs; high TONs are essential to avoid contamination problems, above all on a larger scale and in the pharmaceutical industry. (e) Ligandless catalysts, recoverable ligands or stabilised nanoparticles allow better recovery and lower cost; in this sense, heterogeneous catalysts are preferable, above all when metal leaching is prevented. (f) It is very rare to find a genuine catalyst for the Heck reaction, in which filtration of the reaction mixture produces a catalytically active solid and an inactive filtrate; this is the only case that can be considered a strictly recyclable catalyst. (g) The usual high reaction temperatures (> 120 °C), sometimes imposed by the high stability of the catalyst (e.g., palladacycles), are often detrimental for the selectivity. (h) In general, reproducible, as well as atom-economy, low-cost, scalable and practical procedures, are needed to extend the methodologies from the academic laboratory to the industrial plant; most of the reactions reported in this review were carried out on a few mmol scale and the scale up was not attempted. (i) The expensive equipment or reaction medium utilised in some methodologies cannot compensate for the little or no improvement observed in many cases with respect to the conventional methodologies; in addition, the application of these methodologies is normally restricted to a small scale. (j) Finally, further research must be undertaken in order to clarify the reaction mechanisms involved in the different processes, which remain unclear in most cases; it is crucial to have a better knowledge of the nature and properties of the real catalytic species in order to improve any given reaction.

We are very grateful to our current Spanish Ministerio de Educación y Ciencia (MEC) for continuous and generous financial support. I. P. B. also thanks the MEC for funding her stay at the University of Alicante during the preparation of this review.

References and notes

- Hassan, J.; Sévignon, M.; Gozzi, C.; Schulz, E.; Lemaire, M. *Chem. Rev.* **2002**, *102*, 1359–1469.
- (a) *Handbook of Organopalladium Chemistry for Organic Synthesis*; Negishi, E., Ed.; Wiley-Interscience: Hoboken, USA, 2002. (b) Söderberg, B. C. G. *Coord. Chem. Rev.* **2003**, *241*, 147–247.
- For reviews, see: (a) Guari, Y.; Sabo-Étienne, S.; Chaudret, B. *Eur. J. Inorg. Chem.* **1999**, 1047–1055. (b) Dyker, G. *Angew. Chem., Int. Ed.* **1999**, *38*, 1699–1712. (c) Ritleng, V.; Sirlin, C.; Pfeffer, M. *Chem. Rev.* **2002**, *102*, 1731–1769.
- (a) Hayashi, T. *Synlett* **2001**, 879–887. (b) Fagnou, K.; Lautens, M. *Chem. Rev.* **2003**, *103*, 169–196.

5. (a) *Cross-coupling Reactions. A Practical Guide*; Miyaura, N., Ed.; Springer: Berlin, 2002. (b) See the special issue: '30 Years of the cross-coupling reaction'; Tamao K.; Hiyama, T.; Negishi, E., Eds.; *J. Organomet. Chem.* **2002**, *653* (1–2). (c) Littke, A. F.; Fu, G. C. *Angew. Chem., Int. Ed.* **2002**, *41*, 4176–4221. (d) *Metal-Catalysed Cross-Coupling Reactions*; de Meijere, A., Diederich, F., Eds. 2nd ed.; Wiley-VCH: Weinheim, 2004. (e) Beletskaya, I. P.; Cheprakov, A. V. *J. Organomet. Chem.* **2004**, *689*, 4055–4082. (f) See the special issue: 'Cross-coupling and Heck issue'; Farina, V.; Miyaura, N.; Buchwald, S. L., Eds.; *Adv. Synth. Catal.* **2004**, *346* (13–15).
6. Anastas, P. T.; Warner, J. C. *Green Chemistry: Theory and Practice*; Oxford University Press: New York, 1998; p 30.
7. For reviews and monographs, see: (a) Anastas, P. T.; Williamson, T. C. *Green Chemistry: Designing Chemistry for the Environment*; ACS: Washington, DC, 1996. (b) *Green Chemical Synthesis and Processes*; Anastas, P. T., Heine, L. G., Williamson, T. C., Eds.; ACS: Washington, DC, 2000. (c) Ritter, S. K. *Chem. Eng. News* **2001**, 27–34. (d) Anastas, P. T.; Kirchhoff, M. M. *Acc. Chem. Res.* **2002**, *35*, 686–694. (e) Lancaster, M. *Green Chemistry: An Introductory Text*; RSC: Cambridge, 2002. (f) Yamamoto, A. *Pure Appl. Chem.* **2002**, *74*, 1–5. (g) Eissen, M.; Metzger, J. O. *Chem. Eur. J.* **2002**, *8*, 3580–3585.
8. (a) Trost, B. M. *Science* **1991**, *251*, 1471–1477. (b) Trost, B. M. *Angew. Chem., Int. Ed. Engl.* **1995**, *34*, 259–281. (c) Trost, B. M. *Acc. Chem. Res.* **2002**, *35*, 695–705. (d) See the special issue: 'Atom Efficient Organic Synthesis'; Mingos, D. M. P.; Beletskaya, I. P., Eds.; *J. Organomet. Chem.* **2004**, *689* (23).
9. Ho, T.-L. *Distinctive Techniques for Organic Synthesis. A Practical Guide*; World Scientific Publishing: Singapore, 1998.
10. For a minireview, see: Zapf, A. *Angew. Chem., Int. Ed.* **2003**, *42*, 5394–5399.
11. (a) Böhm, V. P. W.; Gstöttmayr, C. W. K.; Weskamp, T.; Herrmann, W. A. *Angew. Chem., Int. Ed.* **2001**, *40*, 3387–3389. (b) Kim, Y. M.; Yu, S. *J. Am. Chem. Soc.* **2003**, *125*, 1696–1697. (c) Terao, J.; Ikumi, A.; Kuniyasu, H.; Kambe, N. *J. Am. Chem. Soc.* **2003**, *125*, 5646–5647.
12. Zeni, G.; Braga, A. L.; Stefani, H. A. *Acc. Chem. Res.* **2003**, *36*, 731–738.
13. For a microreview, see: Darses, S.; Genêt, J.-P. *Eur. J. Org. Chem.* **2003**, 4313–4327.
14. (a) Nakamura, T.; Kinoshita, H.; Shinokubo, H.; Oshima, K. *Org. Lett.* **2002**, *4*, 3165–3167. (b) Faller, J. W.; Kultyshev, R. G.; Parr, J. *Tetrahedron Lett.* **2003**, *44*, 451–453.
15. For a recent review on the Stille reaction, see: Espinet, P.; Echavarren, A. M. *Angew. Chem., Int. Ed.* **2004**, *43*, 4707–4734.
16. For a recent review, see: Denmark, S. E. *Aldrichimica Acta* **2003**, *36*, 75–85.
17. For recent reviews, see: (a) Lorscheid, B. A.; Kurth, M. J. *Chem. Rev.* **1999**, *99*, 1549–1581. (b) Franzen, R. *Can. J. Chem.* **2000**, *78*, 957–962. (c) Sammelson, R. E.; Kurth, M. J. *Chem. Rev.* **2001**, *101*, 137–202. (d) Bräse, S.; Köbberling, J.; Griebenow, N. In Negishi, E., Ed.; *Handbook of Organopalladium Chemistry for Organic Synthesis*; Wiley-Interscience: Hoboken, USA, 2002; Vol. 2, Chapter X.3. (e) Uozumi, Y.; Hayashi, T. In Nicolaou, K. C., Hanko, R., Hartwig, W., Eds.; *Handbook of Combinatorial Chemistry*; Wiley-VCH: Weinheim, 2002; Vol. 1, pp 531–573. (f) Bräse, S.; Kirchhoff, J. H.; Köbberling, J. *Tetrahedron* **2003**, *59*, 885–939. (g) *Polymeric Materials in Organic Synthesis*; Buchmeiser, M. R., Ed.; Wiley-VCH: Weinheim, 2003; pp 165–168.
18. See, for instance: (a) Reetz, M. T.; Westermann, E. *Angew. Chem., Int. Ed.* **2000**, *39*, 165–168. For recent reviews, see (b) Roucoux, A.; Schulz, J.; Patin, H. *Chem. Rev.* **2002**, *102*, 3757–3778. (c) Moreno-Mañas, M.; Pleixats, R. *Acc. Chem. Res.* **2003**, *36*, 638–643. (d) Johnson, B. F. G. *Top. Catal.* **2003**, *24*, 147–159. (e) *Nanoparticles: From Theory to Application*; Schmid, G., Ed.; Wiley-VCH: Weinheim, 2004.
19. For reviews, see: (a) Pittman, C. U., Jr. *Polym. News* **2001**, *26*, 14–16. (b) Pittman, C. U., Jr. *Polym. News* **2001**, *26*, 50–53. (c) Clapham, B.; Reger, T. S.; Janda, K. D. *Tetrahedron* **2001**, *57*, 4637–4663. (d) Zhang, T. Y. In *Handbook of Organopalladium Chemistry for Organic Synthesis*; Negishi, E., Ed.; Wiley-Interscience: Hoboken, USA, 2002, Chapter X.2. (e) Uozumi, Y.; Hayashi, T. In Nicolaou, K. C., Hanko, R., Hartwig, W., Eds.; *Handbook of Combinatorial Chemistry*; Wiley-VCH: Weinheim, 2002; Vol. 1, Chapter X.2, pp 573–581. (f) Leadbeater, N. E.; Marco, M. *Chem. Rev.* **2002**, *102*, 3217–3274. (g) McNamara, C. A.; Dixon, M. J.; Bradley, M. *Chem. Rev.* **2002**, *102*, 3275–3300. (h) Dickerson, T. J.; Reed, N. N.; Janda, K. D. *Chem. Rev.* **2002**, *102*, 3325–3344. (i) Bergbreiter, D. E. *Chem. Rev.* **2002**, *102*, 3345–3384. (j) Uozumi, Y. *Top. Curr. Chem.* **2004**, *242*, 77–112.
20. For recent books and reviews, see: (a) van Koten, G.; Jastrzberski, J. T. B. H. *J. Mol. Catal. A: Chem.* **1999**, *146*, 317–323. (b) *Dendrimers and Other Dendritic Polymers*; Fréchet, J. M. J., Tomalia, D. A., Eds.; Wiley: New York, 2001. (c) Newkome, G. R.; Moorefield, C. N.; Vögtle, F. *Dendrimers and Dendrons: Concepts, Syntheses, Applications*; Wiley-VCH: Weinheim, 2001. (d) Oestrom, G. E.; Reek, J. N. H.; Kamer, P. C. J.; van Leeuwen, P. W. N. M. *Angew. Chem., Int. Ed.* **2001**, *40*, 1828–1849. (e) Astruc, D.; Chardac, F. *Chem. Rev.* **2001**, *101*, 2991–3023. (f) Kreiter, R.; Kleij, A. W.; Gebbink, R. J. M. K.; van Koten, G. *Top. Curr. Chem.* **2001**, *217*, 163–199. (g) Twyman, L. J.; King, A. S. H.; Martin, I. K. *Chem. Soc. Rev.* **2002**, *31*, 69–82. (h) Twyman, L. J.; King, A. S. H. *J. Chem. Res. (S)* **2002**, 43–59. (i) van Heerbeek, R.; Kamer, P. C. J.; van Leeuwen, P. W. N. M. *Chem. Rev.* **2002**, *102*, 3717–3756. (j) Tomalia, D. A. *Aldrichimica Acta* **2004**, *37*, 39–57.
21. For reviews, see: (a) Song, C. E.; Lee, S. *Chem. Rev.* **2002**, *102*, 3495–3524. (b) De Vos, D. E.; Dams, M.; Sels, B. F.; Jacobs, P. A. *Chem. Rev.* **2002**, *102*, 3615–3640. (c) Varma, R. S. *Tetrahedron* **2002**, *58*, 1235–1255.
22. Reichardt, C. *Solvents and Solvent Effects in Organic Chemistry*; Wiley-VCH: Weinheim, 2002.
23. (a) See the special issue: 'Green Solvents for Catalysis'; *Green Chemistry* **2003**, *5* (2). (b) Adams, D. J.; Dyson, P. J.; Tavener, S. J. In *Chemistry in Alternative Reaction Media*; Wiley: New York, 2004.
24. (a) Tanaka, K.; Toda, F. *Chem. Rev.* **2000**, *100*, 1025–1074. (b) Tanaka, K. In *Solvent-free Organic Synthesis*; Wiley-VCH: Weinheim, 2003.
25. (a) Savage, P. E.; Gopalan, S.; Mizan, T. I.; Martino, J.; Brock, E. E. *AIChE J.* **1995**, *41*, 1723–1778. (b) Clifford, A. A. *Fundamentals of Supercritical Fluids*; Oxford University Press: Oxford, 1998. (c) Stewart, I. H.; Derouane, E. G. *Curr. Top. Catal.* **1999**, *2*, 17. (d) For a monographic issue, see: 'Supercritical Fluids'; Noyori, Ed.; *Chem. Rev.*

- 1999, 99 (2). (e) Schmieder, H.; Dahmen, N.; Schön, J.; Wiegand, G. In *Chemistry Under Extreme or Non-classical Conditions*; Eldik, R., Hobbar, C. D., Eds.; Wiley: New York, 1997; pp 273–316. (f) Perrut, M. *Ind. Eng. Chem. Res.* **2000**, 39, 4531–4535. (g) Jung, J.; Perrut, M. *J. Supercrit. Fluids* **2001**, 20, 179–219.
26. (a) Dinjus, E.; Fornika, R.; Scholz, M. In *Chemistry under Extreme or Non-classical Conditions*; Eldik, R., Hobbar, C. D., Eds.; Wiley: New York, 1997; pp 219–272. (b) *Chemical Synthesis using Supercritical Fluids*; Jessop, P. G., Leitner, W., Eds.; Wiley-VCH: Weinheim, 1999. (c) Scott Oakes, R.; Clifford, A. A.; Rayner, C. M. *J. Chem. Soc., Perkin Trans. 1* **2001**, 917–941. (d) Prajapati, D.; Gohain, M. *Tetrahedron* **2004**, 60, 815–833.
27. For a review on scCO₂, see: Leitner, W. *Acc. Chem. Res.* **2002**, 35, 746–756.
28. Savage, P. E. *Chem. Rev.* **1999**, 99, 603–621.
29. Bradaric, C. J.; Downard, A.; Kennedy, C.; Robertson, A. J.; Zhou, Y. *The Strem Chemiker* **2003**, 20, 2–11.
30. (a) Freemantle, M. *Chem. Eng. News* **1998**, 76, 32–37. (b) Rogers, R. D.; Seddon, K. R. In *Ionic Liquids: Industrial Applications to Green Chemistry*; Rogers, R. D., Seddon, K. R., Eds.; ACS Symposium Series 818; American Chemical Society: Washington, DC, 2002, p 13. (c) *Green Industrial Applications of Ionic Liquids*; Rogers, R. D., Seddon, K. R., Volkov, S., Eds.; Kluwer Academic: Dordrecht, 2002. (d) See the special issue on ionic liquids: *Green Chem.* **2002**, 4 (2). (e) Davis, J. H., Jr.; Fox, P. A. *Chem. Commun.* **2003**, 1209–1212. (f) For a review, see: Davis, J. H., Jr. *Chem. Lett.* **2004**, 33, 1072–1077.
31. For reviews, see: (a) Welton, T. *Chem. Rev.* **1999**, 99, 2071–2083. (b) Olivier-Bourbigou, H.; Magna, L. *J. Mol. Catal. A: Chem.* **2002**, 182–183, 419–437. (c) Zhao, H.; Malhotra, S. V. *Aldrichimica Acta* **2002**, 35, 75–83. (d) Dupont, J.; Souza, R. F.; Suarez, P. A. Z. *Chem. Rev.* **2002**, 102, 3667–3692. (e) *Ionic Liquids in Synthesis*; Wasserscheid, P., Welton, T., Eds.; Wiley-VCH: Weinheim, 2003. (f) Song, C. E. *Chem. Commun.* **2004**, 1033–1043.
32. For a review, see: Baudequin, C.; Baudoux, J.; Levillain, J.; Cahard, D.; Gaumont, A.-C.; Plaquevent, J.-C. *Tetrahedron: Asymmetry* **2003**, 14, 3081–3093.
33. For a minireview, see: Antonietti, M.; Kuang, D.; Smarsly, B.; Zhou, Y. *Angew. Chem., Int. Ed.* **2004**, 43, 4988–4992.
34. See, for instance: Leadbeater, N.; Ondrushka, B. *Green Chem.* **2003**, 5, 677–678 and references cited therein.
35. See, for instance: (a) Kazarian, S. G.; Sakellarios, N.; Gordon, C. M. *Chem. Commun.* **2002**, 1314–1315. (b) Dzyuba, S. V.; Bartsch, R. A. *Angew. Chem., Int. Ed.* **2003**, 42, 148–150.
36. Salzer, A. *Chem. Eng. News* **2002**, 80, 4–6.
37. (a) Jastorff, B.; Störmann, R.; Ranke, J.; Mölter, K.; Stock, F.; Oberheitmann, B.; Hoffmann, W.; Hoffmann, J.; Nüchter, M.; Ondruschka, B.; Filser, J. *Green Chem.* **2003**, 5, 136–142. (b) Swatloski, R. P.; Holbrey, J. D.; Rogers, R. D. *Green Chem.* **2003**, 5, 361–363.
38. See, for instance: Namboodiri, V. V.; Varma, R. S. *Org. Lett.* **2002**, 4, 3161–3163 and references cited therein.
39. (a) Gladysz, J. A.; Curran, D. P. *Tetrahedron* **2002**, 58, 3823–3825. (b) For a special issue, see: ‘Fluorous Chemistry’; Gladysz, J. A.; Curran, D. P., Eds.; *Tetrahedron* **2002**, 58 (20). For a recent review, see: (c) Zhang, W. *Tetrahedron* **2003**, 59, 4475–4489.
40. For a review on fluorous biphasic chemistry, see: Horváth, I. T. *Acc. Chem. Res.* **1998**, 31, 641–650.
41. See, for instance: (a) Zhang, Q.; Rivkin, A.; Curran, D. P. *J. Am. Chem. Soc.* **2002**, 124, 5774–5781. (b) Zhang, W.; Luo, Z.; Chen, C. H.-T.; Curran, D. P. *J. Am. Chem. Soc.* **2002**, 124, 10443–10450.
42. (a) Li, C.-J.; Chan, T.-H. *Organic Reactions in Water*; Wiley: New York, 1997. (b) *Organic Synthesis in Water*; Grieco, P. A., Ed.; Blackie Academic and Professional: London, 1998. (c) Yorimitsu, H.; Shinokubo, H.; Oshima, K. *Synlett* **2002**, 674–686. (d) Lindström, U. M. *Chem. Rev.* **2002**, 102, 2751–2772. (e) *Aqueous-phase Organometallic Catalysis*; Cornils, B., Herrmann, W. A., Eds. 2nd ed.; Wiley-VCH: Weinheim, 2004.
43. (a) Ref. 42a, Chapter 5. (b) Beletskaya, I. P.; Cheprakov, A. V. In *Organic Synthesis in Water*; Grieco, P. A., Ed.; Blackie Academic and Professional: London, 1998; Chapter 5. (c) Herrmann, W. A.; Reisinger, C.-P. In *Aqueous-phase Organometallic Catalysis*; Cornils, B., Herrmann, W. A., Eds.; Wiley-VCH: Weinheim, 1998; Chapter 6.4. (d) Genêt, J. P.; Savignac, M. *J. Organomet. Chem.* **1999**, 576, 305–317. (e) Li, C.-H. *Acc. Chem. Res.* **2002**, 35, 533–538. (f) Manabe, K.; Kobayashi, S. *Chem. Eur. J.* **2002**, 8, 4095–4101. (g) Beletskaya, I. P.; Cheprakov, A. V. In *Handbook of Organopalladium Chemistry for Organic Synthesis*; Negishi, E., Ed.; Wiley-Interscience: Hoboken, USA, 2002; Chapter X.1.
44. (a) Thuéry, J. In *Microwaves: Industrial, Scientific, and Medical Applications*; Grant, E. H., Ed.; Artech House: Boston, 1992. (b) Kingston, H. M.; Haswell, S. J. *Microwave Enhanced Chemistry. Fundamentals, Sample Preparation and Applications*; American Chemical Society: Washington, 1997.
45. For reviews and monographs, see: (a) Mingos, D. P. M.; Baghurst, D. R. *Chem. Soc. Rev.* **1991**, 20, 1–47. (b) Strauss, C. R.; Trainor, R. W. *Aust. J. Chem.* **1995**, 48, 1665–1692. (c) Caddik, S. *Tetrahedron* **1995**, 51, 10403–10432. (d) Langa, F.; de la Cruz, P.; de la Hoz, A.; Díaz-Ortiz, A.; Díez-Barra, E. *Contemp. Org. Synth.* **1997**, 373–386. (e) Galema, S. A. *Chem. Soc. Rev.* **1997**, 26, 233–238. (f) Loupy, A.; Petit, A.; Hamelin, J.; Texier-Boulet, F.; Jacquault, P.; Mathé, D. *Synthesis* **1998**, 1213–1234. (g) Deshayes, S.; Liagre, M.; Loupy, A.; Luche, J.-L.; Petit, A. *Tetrahedron* **1999**, 55, 10851–10870. (h) Varma, R. S. *Green Chem.* **1999**, 43–55. (i) Perreux, L.; Loupy, A. *Tetrahedron* **2001**, 57, 9199–9223. (j) Lidström, P.; Tierney, J.; Wathey, B.; Westman, J. *Tetrahedron* **2001**, 57, 9225–9283. (k) *Microwave in Organic Synthesis*; Loupy, A., Ed.; Wiley-VCH: Weinheim, 2002. (l) Larhed, M.; Moberg, C.; Hallberg, A. *Acc. Chem. Res.* **2002**, 35, 717–727. (m) Getwoldsen, G. S.; Elander, N.; Stone-Elander, S. A. *Chem. Eur. J.* **2002**, 8, 2255–2260. (n) *Microwave Assisted Organic Synthesis*; Tierney, J., Lidstrom, P., Eds.; Blackwell: Oxford, 2004. (o) Hayes, B. L. *Aldrichimica Acta* **2004**, 37, 66–76. (p) Kappe, C. O. *Angew. Chem., Int. Ed.* **2004**, 43, 6250–6284.
46. For a review, see: Lew, A.; Krutzik, P. O.; Hart, M. E.; Chamberlin, A. R. *J. Comb. Chem.* **2002**, 4, 95–105.
47. (a) Margulis, M. A. *Sonochemistry and Cavitation*; Taylor and Francis: London, 1995. (b) Luche, J.-L.; Bianchi, C. *Synthetic Organic Sonochemistry*; Plenum: New York, 1998. (c) *Advances in Sonochemistry*; Mason, T. J., Ed.; Elsevier Science: Oxford, 1999. (d) *Sonochemistry and Sonoluminescence (NATO asi series. Series C, Mathematical and Physical*

- Sciences*, No. 524.); Crum, L. A., Mason, T. J., Reisse, J. L., Suslick, K. S., Eds.; Kluwer Academic Publishers: Amsterdam, 1999. (e) Mason, T. J.; Lorimer, J. P.; *Applied Sonochemistry: Uses of Power Ultrasound in Chemistry and Processing*; VCH: Weinheim, 2002. (f) Mason, T. J.; Peters, D. *Practical Sonochemistry: Uses and Applications of Ultrasound*; Albion Horwood Publishing House: London, 2004.
48. (a) *High Pressure Chemical Synthesis*; Jurczak, J., Baranowski, B., Eds.; Elsevier: Amsterdam, 1989. (b) *High Pressure Chemistry, Biochemistry and Materials Science*; Winter, R., Jonas, J., Eds.; Kluwer Academic: Dordrecht, 1993. (c) Jenner, G. *Tetrahedron* **1997**, *53*, 2669–2695. (d) *High Pressure Molecular Science*; Winter, R., Jonas, J., Eds.; Kluwer Academic: Dordrecht, 1999. (e) *High Pressure Chemistry. Synthetic, Mechanistic and Supercritical Applications*; van Eldik, R., Klärner, F. G., Eds.; Wiley-VCH: Weinheim, 2002. (f) Jenner, G. *Tetrahedron* **2002**, *58*, 5185–5202.
49. Taşcıoğlu, S. *Tetrahedron* **1996**, *52*, 11113–11152.
50. Schwuger, M.-J.; Stickdorn, K.; Schomäker, R. *Chem. Rev.* **1995**, *95*, 849–864.
51. Ref. 9, Chapter 6.
52. Torii, S. *Novel Trends in Electroorganic Synthesis*; Springer: Tokyo, 1998.
53. (a) See the special issue: ‘Recoverable Catalysts and Reagents’; Gladysz, J. A., Ed.; *Chem. Rev.* **2002**, *102* (10). (b) See also the review: Tzschucke, C. C.; Market, C.; Bannwarth, W.; Roller, S.; Hebel, A.; Haag, R. *Angew. Chem., Int. Ed.* **2002**, *41*, 3964–4000.
54. (a) Mulder, M. *Basic Principles of Membrane Technology*; Kluwer: Dordrecht, 1996. (b) Vankelecom, I. F. J. *Chem. Rev.* **2002**, *102*, 3779–3810. (c) Dijkstra, H. P.; van Klink, G. P. M.; van Koten, G. *Acc. Chem. Res.* **2002**, *35*, 798–810.
55. (a) Ehrfeld, W.; Hessel, V.; Löwe, H. *Microreactors: New Technology for Modern Chemistry*; Wiley-VCH: Weinheim, 2000. (b) Hessel, V.; Hardt, S.; Löwe, H. *Chemical Micro Process Engineering*; Wiley-VCH: Weinheim, 2004.
56. For a review, see: Haswell, S. J.; Watts, P. *Green Chem.* **2003**, *5*, 240–249.
57. For a review on chemistry in microstructured reactors, including industrial applications, see: Jähnisch, K.; Hessel, V.; Löwe, H.; Baerns, M. *Angew. Chem., Int. Ed.* **2004**, *43*, 406–446.
58. See for instance: (a) Rasmussen, M. O.; Axelsson, O.; Tanner, D. *Synth. Commun.* **1997**, *27*, 4027–4030. (synthesis of diphenols by oxidative coupling). (b) Nielsen, S. F.; Peters, D.; Axelsson, O. *Synth. Commun.* **2000**, *30*, 3501–3509. (Suzuki coupling). (c) Balema, V. P.; Wiench, J. W.; Pruski, M.; Pecharsky, V. K. *J. Am. Chem. Soc.* **2002**, *124*, 6244–6245. (Wittig reaction). (d) Wang, G.-W.; Zhang, T.-H.; Li, P.; Zhang, H.; Liu, Y.-C.; Murata, Y.; Komatsu, K. *Tetrahedron Lett.* **2003**, *44*, 4407–4409.
59. For reviews, see: (a) de Meijere, A.; Meyer, F. E. *Angew. Chem., Int. Ed. Engl.* **1994**, *33*, 2379–2411. (b) Gibson, S. E.; Middleton, R. J. *Contemp. Org. Synth.* **1996**, *3*, 447–471. (c) Withcombe, N. J.; Hii, K. K.; Gibson, S. E. *Tetrahedron* **2001**, *57*, 7449–7476. (d) Beletskaya, I. P.; Cheprakov, A. V. *Chem. Rev.* **2000**, *100*, 3009–3066. (e) Ref. 2a; Vol. 1, Chapter IV.2. (f) Dounay, A. B.; Overman, L. E. *Chem. Rev.* **2003**, *103*, 2945–2963. (g) Farina, V. *Adv. Synth. Catal.* **2004**, *346*, 1553–1582.
60. For other mechanistic proposals, see for instance: Amatore, C.; Jutand, A. *Acc. Chem. Res.* **2000**, *33*, 314–321.
61. Stephan, M. S.; Teunissen, A. J. J. M.; Verzijl, G. K. M.; de Vries, J. G. *Angew. Chem., Int. Ed.* **1998**, *37*, 662–664.
62. (a) Schmidt, A. F.; Smirnov, V. V. *Kinet. Catal.* **2000**, *41*, 743–744. (b) Schmidt, A. F.; Smirnov, V. V. *Kinet. Catal.* **2002**, *43*, 195–198.
63. (a) Gooßen, L. J.; Paetzold, J. *Angew. Chem., Int. Ed.* **2002**, *41*, 1237–1241. (b) Gooßen, L. J.; Paetzold, J. *Angew. Chem., Int. Ed.* **2004**, *43*, 1095–1098.
64. Gooßen, L. J.; Paetzold, J.; Winkel, L. *Synlett* **2002**, 1721–1723.
65. Myers, A. G.; Tanaka, D.; Mannion, M. R. *J. Am. Chem. Soc.* **2002**, *124*, 11250–11251.
66. Blaser, H. U.; Spencer, A. *J. Organomet. Chem.* **1982**, *233*, 267–274.
67. (a) Sugihara, T.; Satoh, T.; Miura, M.; Nomura, M. *Angew. Chem., Int. Ed.* **2003**, *42*, 4672. (b) Sugihara, T.; Satoh, T.; Miura, M.; Nomura, M. *Adv. Synth. Catal.* **2004**, *346*, 1765–1772.
68. Andrus, M. B.; Liu, J.; Meredith, E. L.; Nartey, E. *Tetrahedron Lett.* **2003**, *44*, 4819–4822.
69. Cho, C. S.; Uemura, S. *J. Organomet. Chem.* **1994**, *465*, 85–92.
70. Lautens, M.; Roy, A.; Fukuoka, K.; Fagnou, K.; Martín-Matute, B. *J. Am. Chem. Soc.* **2001**, *123*, 5358–5359.
71. Amengual, R.; Michelet, V.; Genêt, J.-P. *Tetrahedron Lett.* **2002**, *43*, 5905–5908.
72. Lautens, M.; Mancuso, J.; Grover, H. *Synthesis* **2004**, 2006–2014.
73. Du, X.; Suguro, M.; Hirabayashi, K.; Mori, A. *Org. Lett.* **2001**, *3*, 3313–3316.
74. Farrington, E. J.; Brown, J. M.; Barnard, C. F. J.; Rowsell, E. *Angew. Chem., Int. Ed.* **2002**, *41*, 169–171.
75. Zou, G.; Wang, Z.; Zhu, J.; Tang, J. *Chem. Commun.* **2003**, 2438–2439.
76. Jung, Y. C.; Mishra, R. K.; Yoon, C. H.; Jung, K. W. *Org. Lett.* **2003**, *5*, 2231–2234.
77. (a) Andappan, M. M. S.; Nilsson, P.; Larhed, M. *Chem. Commun.* **2004**, 218–219. (b) Andappan, M. M. S.; Nilsson, P.; von Schenck, H.; Larhed, M. *J. Org. Chem.* **2004**, *69*, 5212–5218.
78. (a) Hirabayashi, Y.; Nishihara, Y.; Mori, A.; Hiyama, T. *Tetrahedron Lett.* **1998**, *39*, 7893–7896. (b) Hirabayashi, K.; Kondo, T.; Toriyama, F.; Nagatsuta, Y. *Bull. Chem. Soc. Jpn.* **2000**, *73*, 749–750. (c) Hirabayashi, K.; Ando, J.; Kawashima, J.; Nishihara, Y.; Mori, A.; Hiyama, T. *Bull. Chem. Soc. Jpn.* **2000**, *73*, 1049–1417.
79. Hirabayashi, Y.; Ando, J.; Nishihara, Y.; Mori, A.; Hiyama, T. *Synlett* **1999**, 99–101.
80. Uemura, S.; Wakasugi, M.; Okano, M. *J. Organomet. Chem.* **1980**, *194*, 277–283.
81. Nishibayashi, Y.; Cho, S. C.; Uemura, S. *J. Organomet. Chem.* **1996**, *507*, 197–200.
82. Hirabayashi, K.; Nara, Y.; Shimizu, T.; Kamigata, N. *Chem. Lett.* **2004**, *33*, 1280–1281.
83. Petragnani, N. *Tellurium in Organic Synthesis*; Academic: London, 1994; Chapters 3.1 and 3.9.
84. For a review on the toxicology and pharmacology of organotellurium compounds, see: Nogueira, C. W.; Zeni, G.; Rocha, J. B. T. *Chem. Rev.* **2004**, *104*, 6255–6285.
85. (a) Cho, C. S.; Tanabe, K.; Uemura, S. *Tetrahedron Lett.*

- 1994, 35, 1275–1278. (b) Cho, C. S.; Motofusa, S.; Ohe, K.; Uemura, S. *Bull. Chem. Soc. Jpn.* **1996**, 69, 2341–2348.
86. Matoba, K.; Motofusa, S.; Cho, C. S.; Ohe, K.; Uemura, S. *J. Organomet. Chem.* **1999**, 574, 3–10.
87. Kang, S.-K.; Ryu, H.-C.; Hong, Y.-T. *J. Chem. Soc., Perkin Trans. 1* **2000**, 3350–3351.
88. (a) Moiseev, D. V.; Morugova, V. A.; Gushchin, A. V.; Dodonov, V. A. *Tetrahedron Lett.* **2003**, 44, 3155–3157. (b) Moiseev, D. V.; Gushchin, A. V.; Morugova, V. A.; Dodonov, V. A. *Russ. Chem. Bull.* **2003**, 52, 2081–2082.
89. Moiseev, D. V.; Morugova, V. A.; Gushchin, A. V.; Shavirin, A. S.; Kursky, Y. A.; Dodonov, V. A. *J. Organomet. Chem.* **2004**, 689, 731–737.
90. Kang, S.-K.; Choi, S.-C.; Ryu, H.-C.; Yamaguchi, T. *J. Org. Chem.* **1998**, 63, 5748–5749.
91. Morphy, J. R.; Rankovic, Z.; York, M. *Tetrahedron Lett.* **2002**, 43, 5973–5975.
92. Duboc, R.; Savignac, M.; Genêt, J.-P. *J. Organomet. Chem.* **2002**, 643–644, 512–515.
93. Doi, T.; Fujimoto, N.; Watanabe, J.; Takahashi, T. *Tetrahedron Lett.* **2003**, 44, 2161–2165.
94. Dahan, A.; Portnoy, M. *Macromolecules* **2003**, 36, 1034–1038.
95. Hanessian, S.; Xie, F. *Tetrahedron Lett.* **1998**, 39, 737–740.
96. Yamazaki, K.; Kondo, Y. *Chem. Commun.* **2002**, 210–211.
97. (a) Yamazaki, K.; Nakamura, Y.; Kondo, Y. *J. Chem. Soc., Perkin Trans. 1* **2002**, 2137–2138. (b) Yamazaki, K.; Kondo, Y. *J. Comb. Chem.* **2002**, 4, 191–192.
98. Cornils, B.; Herrmann, W. A. *Applied Homogeneous Catalysis with Organometallic Compounds*; VCH: Weinheim, 1996.
99. For recent examples, see: (a) Gruber, A. S.; Zim, D. Z.; Ebeling, G.; Monteiro, A. L.; Dupont, J. *Org. Lett.* **2000**, 2, 1287–1290. (b) Bergbreiter, D. E.; Osburn, P. L.; Wilson, A.; Sink, E. *J. Am. Chem. Soc.* **2000**, 122, 9058–9064. (c) Bourisson, D.; Guerret, O.; Gabbaï, F. P.; Bertrand, C. B. *Chem. Rev.* **2000**, 100, 39–92. (d) Gruber, A. S.; Pozebon, D.; Monteiro, A. L.; Dupont, J. *Tetrahedron Lett.* **2001**, 42, 7345–7348. (e) Muñoz, M. P.; Martín-Matute, B.; Fernández-Rivas, C.; Cárdenas, D. J.; Echavarren, A. M. *Adv. Synth. Catal.* **2001**, 343, 338–342. (f) Beletskaya, I. P.; Kashin, A. N.; Karlstedt, N. B.; Mitin, A. V.; Cheprakov, A. V.; Kazankov, G. M. *J. Organomet. Chem.* **2001**, 622, 89–96. (g) Herrmann, W. A. *Angew. Chem., Int. Ed.* **2002**, 41, 1290–1309. (h) Alonso, D. A.; Nájera, C.; Pacheco, M. C. *Adv. Synth. Catal.* **2002**, 343, 172–183. (i) Consorti, C. S.; Zanini, M. L.; Leal, S.; Ebeling, G.; Dupont, J. *Org. Lett.* **2003**, 5, 983–986.
100. Reetz, M. T.; de Vries, J. G. *Chem. Commun.* **2004**, 1559–1563.
101. Beletskaya, I. P. *J. Organomet. Chem.* **1983**, 250, 551–564.
102. (a) Jeffery, T. *J. Chem. Soc., Chem. Commun.* **1984**, 1287–1289. (b) Jeffery, T. *Tetrahedron Lett.* **1985**, 26, 2667–2670.
103. Crisp, G. T.; Gebauer, M. G. *Tetrahedron* **1996**, 52, 12465–12474.
104. Bräthe, A.; Gundersen, L.-L.; Rise, F.; Eriksen, A. B.; Vollsnæs, A. V.; Wang, L. *Tetrahedron* **1999**, 55, 211–228.
105. Gürtler, C.; Buchwald, S. L. *Chem. Eur. J.* **1999**, 5, 3107–3112.
106. Reetz, M.; Westermann, E.; Lohmer, R.; Lohmer, G. *Tetrahedron Lett.* **1998**, 39, 8449–8452.
107. Schmidt, A.; Smirnov, V. V. *J. Mol. Catal. A: Chem.* **2003**, 203, 75–78.
108. Yao, Q.; Kinney, E. P.; Yang, Z. *J. Org. Chem.* **2003**, 68, 7528–7531.
109. de Vries, A. H. M.; Parlevliet, F. J.; de Vondervoort, L. S.; Mommers, J. H. M.; Henderickx, H. J. W.; Walet, M. A. M.; de Vries, J. G. *Adv. Synth. Catal.* **2002**, 344, 996–1002.
110. de Vries, A. H. M.; Mulders, J. M. C. A.; Mommers, J. H. M.; Henderickx, H. J. W.; de Vries, J. G. *Org. Lett.* **2003**, 5, 3285–3288.
111. Willans, C. E.; Mulders, J. M. C. A.; de Vries, J. G.; de Vries, A. H. M. *J. Organomet. Chem.* **2003**, 687, 494–497.
112. For one example, see: Baumeister, P.; Meyer, W.; Örtle, K.; Siefert, G.; Siegrist, U.; Steiner, H. *Chimia* **1997**, 51, 144–146.
113. For reviews, see: (a) Wall, V. M.; Eisenstadt, A.; Ager, D. J.; Laneman, S. A. *Platinum Met. Rev.* **1999**, 43, 138–145. (b) Bhanage, B. M.; Arai, M. *Catal. Rev. Sci. Eng.* **2001**, 43, 315–344. (c) Biffis, A.; Zecca, M.; Basato, M. *J. Mol. Catal. A: Chem.* **2001**, 173, 249–274.
114. Eisenstadt, A.; Hasharon, R.; Keren, Y.; Motzkin, K. US Patent 5,187,303, 1993; *Chem. Abstr.* **1993**, 118, 191351c.
115. Beller, M.; Kühlein, K. *Synlett* **1995**, 441–442.
116. (a) Heidenreich, R. G.; Krauter, J. G. E.; Pietsch, J.; Köhler, K. *J. Mol. Catal. A: Chem.* **2002**, 182–183, 499–509. (b) Köhler, K.; Heidenreich, R. G.; Krauter, J. G. E.; Pietsch, J. *Chem. Eur. J.* **2002**, 8, 622–631. (c) Heidenreich, R. G.; Köhler, K.; Krauter, J. G. E.; Pietsch, J. *Synlett* **2002**, 1118–1122. (d) Krauter, J. G. E.; Pietsch, J.; Köhler, K.; Heidenreich, R. G. *Chemical Industries (Dekker)* **2003**, 89, 379–392.
117. (a) Zhao, F.; Murakami, K.; Shirai, M.; Arai, M. *J. Catal.* **2000**, 194, 479–483. (b) Zhao, F.; Shirai, M.; Ikushima, Y.; Arai, M. *J. Mol. Catal. A: Chem.* **2002**, 180, 211–219.
118. Zhao, F.; Bhanage, B. M.; Shirai, M.; Arai, M. *Chem. Eur. J.* **2000**, 6, 843–848.
119. Walter, J.; Heiermann, J.; Dyker, G.; Hara, S.; Shioyama, H. *J. Catal.* **2000**, 189, 449–455.
120. Augustine, R. L.; O’Leary, S. T. *J. Mol. Catal. A: Chem.* **1995**, 95, 277–285.
121. (a) Wagner, M.; Köhler, K.; Djakovitch, L.; Weinkauff, S.; Hagen, V.; Muhler, M. *Top. Catal.* **2000**, 13, 319–326. (b) Davies, I. W.; Matty, L.; Hughes, D. L.; Reider, P. J. *J. Am. Chem. Soc.* **2001**, 123, 10139–10140.
122. Macquarrie, D. J.; Gotov, B.; Toma, Š. *Platinum Met. Rev.* **2001**, 45, 102–110.
123. Li, J.; Mau, A. W.-H.; Strauss, C. R. *Chem. Commun.* **1997**, 1275–1276.
124. (a) Tonks, L.; Anson, M. S.; Hellgardt, K.; Mirza, A. R.; Thompson, D. F.; Williams, J. M. J. *Tetrahedron Lett.* **1997**, 38, 4319–4322. (b) Mirza, A. R.; Anson, M. S.; Hellgardt, K.; Leese, M. P.; Thompson, D. F.; Tonks, L.; Williams, J. M. J. *Org. Process Res. Dev.* **1998**, 2, 325–331.
125. Bhanage, B. M.; Shirai, M.; Arai, M. *J. Mol. Catal. A: Chem.* **1999**, 145, 69–74.
126. Fujita, S.; Yoshida, T.; Bhanage, B. M.; Arai, M. *J. Mol. Catal. A: Chem.* **2002**, 188, 37–43.
127. Leese, M. P.; Williams, J. M. J. *Synlett* **1999**, 1645–1647.
128. Anson, M. S.; Mirza, A. R.; Tonks, L.; Williams, J. M. J. *Tetrahedron Lett.* **1999**, 40, 7147–7150.
129. Clark, J. H.; Macquarrie, D. J.; Mubofu, E. B. *Green Chem.* **2000**, 5, 53–55.
130. (a) Raja, T.; Horniakova, J.; Jacob, N. E.; Jha, R. K.; Kubota,

- Y.; Sugi, Y. *Mater. Sci. Forum* **2003**, 426–432, 4623–4628.
- (b) Horniakova, J.; Raja, T.; Kubota, Y.; Sugi, Y. *J. Mol. Catal. A: Chem.* **2004**, 217, 73–80.
131. Gurbuz, N.; Özdemir, I.; Çetinkaya, B.; Seçkin, T. *Appl. Organomet. Chem.* **2003**, 17, 776–780.
132. Chanthateyanonth, R.; Alper, H. *J. Mol. Catal. A: Chem.* **2003**, 201, 23–31.
133. (a) Yang, Y.; Zhou, R.; Zhao, S.; Li, Q.; Zheng, X. *J. Mol. Catal. A: Chem.* **2003**, 192, 303–306. (b) Yang, Y.; Zhou, R.; Zhao, S.; Zheng, X. *Catal. Lett.* **2003**, 85, 87–90.
134. Zhou, R. X.; Zhao, S. F. *Chin. Chem. Lett.* **2004**, 15, 856–858.
135. (a) Zhao, S.; Zhou, R.; Yang, Y.; Zheng, X. *React. Kinet. Catal. Lett.* **2003**, 79, 333–340. (b) Zhao, S.; Zhou, R. X.; Zheng, X. M. *J. Mol. Catal. A: Chem.* **2004**, 211, 139–142.
136. Zhao, S.; Zhou, R.; Yang, Y. F.; Zheng, X. *Indian J. Chem., Sect. A* **2002**, 41A, 2274–2276.
137. Buchmeiser, M. R.; Lubbad, S.; Mayr, M.; Wurst, K. *Inorg. Chim. Acta* **2003**, 345, 145–153.
138. Cai, M.; Song, C.; Huang, X. *Synthesis* **1997**, 521–523.
139. Shimizu, K.; Koizumi, S.; Hatamachi, T.; Yoshida, H.; Komai, S.; Kodama, T.; Kitayama, Y. *J. Catal.* **2004**, 228, 141–151.
140. (a) Cai, M.; Huang, Y.; Zhao, H.; Song, C. *J. Organomet. Chem.* **2003**, 682, 20–25. (b) Cai, M.; Huang, Y.; Zhao, H.; Song, C. *React. Funct. Polym.* **2004**, 59, 81–86.
141. Cai, M.; Tong, X.; Chen, J.; Huang, Y. *J. Chem. Res. (S)* **2004**, 622–623.
142. Cai, M.; Zhou, J.; Zhao, H.; Song, C. *J. Chem. Res. (S)* **2002**, 76–78.
143. Yu, K.; Sommer, W.; Weck, M.; Jones, C. W. *J. Catal.* **2004**, 226, 101–110.
144. Molnár, A.; Papp, A.; Miklós, K.; Forgo, P. *Chem. Commun.* **2003**, 2626–2627.
145. Gallow, T. H.; Drechsler, U.; Hanson, J. A.; Rotello, V. M. *Chem. Commun.* **2002**, 1076–1077.
146. Li, L.; Shi, J.; Yan, J. *Chem. Commun.* **2004**, 1990–1991.
147. Hamza, K.; Abu-Reziq, R.; Avnir, D.; Blum, J. *Org. Lett.* **2004**, 6, 925–927.
148. Anderson, K.; Cortiñas Fernández, S.; Hardacre, C.; Marr, P. C. *Inorg. Chem. Commun.* **2004**, 7, 73–76.
149. Hagiwara, H.; Sugawara, Y.; Isobe, K.; Hoshi, T.; Suzuki, T. *Org. Lett.* **2004**, 6, 2325.
150. Kim, N.; Kwon, M. S.; Park, C. M.; Park, J. *Tetrahedron Lett.* **2004**, 45, 7057–7059.
151. See, for instance: Wali, A.; Pillai, M.; Satish, S. *React. Kinet. Catal. Lett.* **1997**, 60, 189–194.
152. Iyer, S.; Thakur, V. V. *J. Mol. Catal. A: Chem.* **2000**, 157, 275–278.
153. Köhler, K.; Wagner, M.; Djakovitch, L. *Catal. Today* **2001**, 66, 105–114.
154. Pröckl, S. S.; Kleist, W.; Gruber, M. A.; Köhler, K. *Angew. Chem., Int. Ed.* **2004**, 43, 1881–1882.
155. Djakovitch, L.; Wagner, M.; Hartung, C. G.; Beller, M.; Köhler, K. *J. Mol. Catal. A: Chem.* **2004**, 219, 121–130.
156. Wali, A.; Pillai, S. M.; Kaushik, V. K.; Satish, S. *Appl. Catal. A: Gen.* **1996**, 135, 83–93.
157. Biffis, A.; Zecca, M.; Basto, M. *Eur. J. Inorg. Chem.* **2001**, 1131–1133.
158. (a) Schmidt, A. F.; Mametova, L. V. *Kinet. Catal.* **1996**, 37, 406–408. (b) Davies, I. W.; Matty, L.; Hughes, D. L.; Reider, P. J. *J. Am. Chem. Soc.* **2001**, 123, 10139–10140.
159. Na, Y.; Park, S.; Han, S. B.; Ko, S.; Chang, S. *J. Am. Chem. Soc.* **2004**, 126, 250–258.
160. Villemin, D.; Jaffrès, P.-A.; Nechab, B.; Courivaud, F. *Tetrahedron Lett.* **1997**, 38, 6581–6584.
161. Mori, K.; Yamaguchi, K.; Hara, T.; Mizugaki, T.; Ebitani, K.; Kaneda, K. *J. Am. Chem. Soc.* **2002**, 124, 11572–11573.
162. Bennur, T. H.; Ramani, A.; Bal, R.; Chanda, B. M.; Sivasanker, S. *Catal. Commun.* **2002**, 3, 493–496.
163. Choudary, B. M.; Madhi, S.; Chowdari, N. S. *J. Am. Chem. Soc.* **2002**, 124, 14127–14136.
164. Choudary, B. M.; Lakshmi Kantam, M.; Mahender Reddy, N.; Gupta, N. M. *Catal. Lett.* **2002**, 82, 79–83.
165. Srivastava, R.; Venkatathri, N.; Srinivas, D.; Ratnasamy, P. *Tetrahedron Lett.* **2003**, 44, 3649–3651.
166. Corma, A.; García, H.; Leyva, A.; Primo, A. *Appl. Catal. A: Gen.* **2004**, 257, 77–83.
167. Takamiya, I.; Tsukamoto, S.; Shimoda, M.; Miyashita, N.; Arisawa, M.; Arakawa, Y.; Nishida, A. *Chem. Lett.* **2004**, 33, 1208–1209.
168. (a) Choudary, B. M.; Sarma, M. R.; Rao, K. K. *Tetrahedron Lett.* **1990**, 31, 5781–5784. (b) Choudary, B. M.; Sarma, M. R.; Rao, K. K. *Tetrahedron* **1991**, 48, 719–726.
169. Varma, R. S.; Naicker, K. P.; Liesen, P. J. *Tetrahedron Lett.* **1999**, 40, 2075–2078.
170. Waterlot, C.; Couturier, D.; Rigo, B. *Tetrahedron Lett.* **2000**, 41, 317–319.
171. Ramchandani, R. K.; Uphade, B. S.; Vinod, M. P.; Wakharkar, R. D.; Choudhary, V. R.; Sudalai, A. *Chem. Commun.* **1997**, 2071–2072.
172. Poyatos, M.; Márquez, F.; Peris, E.; Claver, C.; Fernández, E. *New J. Chem.* **2003**, 425–431.
173. Dams, M.; Drijkoningen, L.; De Vos, D.; Jacobs, P. *Chem. Commun.* **2002**, 1062–1063.
174. (a) Dams, M.; De Vos, D.; Drijkoningen, L.; Jacobs, P. *Stud. Surf. Sci. Catal.* **2001**, 135, 3589–3596. (b) Dams, M.; Drijkoningen, L.; Pauwels, B.; Van Tendeloo, G.; De Vos, D. E.; Jacobs, P. A. *J. Catal.* **2002**, 209, 225–236.
175. Nejjar, A.; Pinel, C.; Djakovitch, L. *Adv. Synth. Catal.* **2003**, 345, 612–619.
176. Corma, A.; García, H.; Leyva, A.; Primo, A. *Appl. Catal. A: Gen.* **2003**, 247, 41–49.
177. Mandal, S.; Roy, D.; Chaudhari, R. V.; Sastry, M. *Chem. Mater.* **2004**, 16, 3714–3724.
178. (a) Mehnert, C. P.; Ying, J. Y. *Chem. Commun.* **1997**, 2215–2216. (b) Mehnert, C. P.; Weaver, D. W.; Ying, J. Y. *J. Am. Chem. Soc.* **1998**, 120, 12289–12296.
179. Zhou, J.; Zhou, R.; Mo, L.; Zhao, S.; Zheng, X. *J. Mol. Catal. A: Chem.* **2002**, 178, 289–292.
180. Zhou, J.; Zhou, R.; Mo, L.; Zhao, S.; Zheng, X. *Chin. J. Chem.* **2001**, 19, 987–990.
181. Venkatesan, C.; Singh, A. P. *Catal. Lett.* **2003**, 88, 193–197.
182. González-Arellano, C.; Corma, A.; Iglesias, M.; Sánchez, F. *Adv. Synth. Catal.* **2004**, 346, 1758–1764.
183. Yang, H.; Zhang, G.; Hong, X.; Zhu, Y. *J. Mol. Catal. A: Chem.* **2004**, 210, 143–148.
184. Tsai, F.-Y.; Wu, C.-L.; Mou, C.-Y.; Chao, M.-C.; Lin, H.-P.; Liu, S.-T. *Tetrahedron Lett.* **2004**, 45, 7503–7506.
185. Waghmode, S. B.; Waghlikar, S. G.; Sivasanker, S. *Bull. Chem. Soc. Jpn.* **2003**, 76, 1989–1992.
186. Terasawa, M.; Kaneda, K.; Imanaka, T.; Teranishi, S. *J. Organomet. Chem.* **1978**, 162, 403.
187. Andersson, C. M.; Karabelas, K.; Hallberg, A.; Andersson, C. *J. Org. Chem.* **1985**, 50, 3891.

188. (a) Zhang, Z. Y.; Hu, H. W.; Kao, T. Y. *React. Polym. Ion Exch. Sorbents* **1988**, *9*, 249–255. (b) Zhang, Z. Y.; Hu, H. W.; Kao, T. Y. *React. Polym.* **1990**, *12*, 229–235. (c) Zhang, Z. Y.; Pan, Y.; Hu, H. W.; Kao, T. Y. *Synthesis* **1991**, 539–542.
189. Wang, P.-W.; Fox, M. A. *J. Org. Chem.* **1994**, *59*, 5358–5364.
190. (a) Uozumi, Y.; Watanabe, T. *J. Org. Chem.* **1999**, *64*, 6921–6923. (b) Uozumi, Y.; Kimura, T. *Synlett* **2002**, 2045–2048.
191. Bergbreiter, D. E.; Osburn, P. L.; Liu, Y.-S. *J. Am. Chem. Soc.* **1999**, *121*, 9531–9538.
192. McNamara, C. A.; King, F.; Bradley, M. *Tetrahedron Lett.* **2004**, *45*, 8239–8243.
193. Bergbreiter, D. E.; Osburn, P. L.; Wilson, A.; Sink, E. M. *J. Am. Chem. Soc.* **2000**, *122*, 9058–9064.
194. Koshti, N.; Naik, S.; Parab, B. *Indian J. Chem., Sect. B* **2004**, *43B*, 852–856.
195. Bergbreiter, D. E.; Osburn, P. L.; Frels, J. D. *J. Am. Chem. Soc.* **2001**, *123*, 11105–11106.
196. Bergbreiter, D. E.; Osburn, P. L.; Li, C. *Org. Lett.* **2002**, *4*, 737–740.
197. Schwarz, J.; Böhm, V. P. W.; Gardiner, M. G.; Grosche, M.; Herrmann, W. A.; Hieringer, W.; Raudaschl-Sieber, G. *Chem. Eur. J.* **2000**, *6*, 1773–1780.
198. Nowotny, M.; Hanefeld, U.; van Koningsveld, H.; Maschmeyer, T. *Chem. Commun.* **2000**, 1877–1878.
199. Grigg, R.; York, M. *Tetrahedron Lett.* **2000**, *41*, 7255–7258.
200. (a) Dell'Anna, M. M.; Mastroilli, P.; Muscio, F.; Nobile, C. F.; Suranna, G. P. *Eur. J. Org. Chem.* **2002**, 1094–1099. (b) Dell'Anna, M. M.; Mastroilli, P.; Muscio, F.; Nobile, C. F. *Stud. Surf. Sci. Catal.* **2003**, *145*, 133–136.
201. Chandrasekhar, V.; Athimoolam, A. *Org. Lett.* **2002**, *4*, 2113–2116.
202. Yang, Y.-C.; Luh, T.-Y. *J. Org. Chem.* **2003**, *68*, 9870–9873.
203. (a) Buchmeiser, M. R.; Schareina, T.; Kempe, R.; Wurst, K. *J. Organomet. Chem.* **2001**, *634*, 39–46. For closely related ligands, see: (b) Buchmeiser, M. R.; Wurst, K. *J. Am. Chem. Soc.* **1999**, *121*, 11101–11107. (c) Silberg, J.; Schareina, T.; Kempe, R.; Wurst, K.; Buchmeiser, M. R. *J. Organomet. Chem.* **2001**, *622*, 6–18.
204. Mansour, A.; Portnoy, M. *Tetrahedron Lett.* **2003**, *44*, 2195–2198.
205. Lin, K.; Song, M.; Cai, D.; Hao, X.; Wu, Y. *Tetrahedron Lett.* **2003**, *44*, 3955–3957.
206. (a) Yamada, Y. M. A.; Takeda, K.; Takahashi, H.; Ikegami, S. *Tetrahedron Lett.* **2003**, *44*, 2379–2382. (b) Yamada, Y. M. A.; Takeda, K.; Takahashi, H.; Ikegami, S. *Tetrahedron* **2004**, *60*, 4097–4105.
207. Lin, C.-A.; Luo, F.-T. *Tetrahedron Lett.* **2003**, *44*, 7565–7568.
208. Datta, A.; Ebert, K.; Plenio, H. *Organometallics* **2003**, *22*, 4685–4691.
209. Pathak, S.; Greci, M. T.; Kwong, R. C.; Mercado, K.; Prakash, G. K. S.; Olah, G. A.; Thompson, M. E. *Chem. Mater.* **2000**, *12*, 1985–1989.
210. Steel, P. G.; Teasdale, C. W. T. *Tetrahedron Lett.* **2004**, *45*, 8977–8980.
211. Mayr, M.; Buchmeiser, M. R. *Macromol. Rapid Commun.* **2004**, *25*, 231–236.
212. Hardy, J. J. E.; Hubert, S.; Macquarrie, D. J.; Wilson, A. J. *Green Chem.* **2004**, *6*, 53–56.
213. Liu, P.; Wang, L.; Li, L.-M.; Wang, X.-Y. *Chin. J. Org. Chem.* **2004**, *24*, 59–62.
214. For reviews, see: (a) Crooks, R. M.; Zhao, M.; Sun, L.; Chechik, V.; Yeung, L. K. *Acc. Chem. Res.* **2001**, *34*, 181–190. (b) Niu, Y.; Crooks, R. M. C. R. *Chimie* **2003**, *6*, 1049–1059.
215. Reetz, M. T.; Lohmer, G.; Schwickardi, R. *Angew. Chem., Int. Ed. Engl.* **1997**, *36*, 1526–1529.
216. Catsoulacos, D. P.; Steele, B. R.; Heropoulos, G. A.; Michascrettas, M.; Screttas, C. G. *Tetrahedron Lett.* **2003**, *44*, 4575–4578.
217. Dahan, A.; Portnoy, M. *Org. Lett.* **2003**, *5*, 1197–1200.
218. Dahan, A.; Weissberg, A.; Portnoy, M. *Chem. Commun.* **2003**, 1206–1207.
219. Rahim, E. H.; Kamounah, F. S.; Frederiksen, J.; Christensen, J. B. *Nano Lett.* **2001**, *1*, 499–501.
220. Gopidas, K. R.; Whitesell, J. K.; Fox, M. A. *Nano Lett.* **2003**, *3*, 1757–1760.
221. Bourque, S. C.; Maltais, F.; Xiao, W.-J.; Tardiff, O.; Alper, H.; Arya, P.; Manzer, L. E. *J. Am. Chem. Soc.* **1999**, *121*, 3035–3038.
222. Alper, H.; Arya, P.; Bourque, S. C.; Jefferson, G. R.; Manzer, L. E. *Can. J. Chem.* **2000**, *78*, 920–924.
223. Ooe, M.; Murata, M.; Mizugaki, T.; Ebitani, K.; Kaneda, K. *J. Am. Chem. Soc.* **2004**, *126*, 1604–1605.
224. Krishna, T. R.; Jayaraman, N. *Tetrahedron* **2004**, *60*, 10325–10334.
225. Smith, G. S.; Mapolie, S. F. *J. Mol. Catal. A: Chem.* **2004**, *213*, 187–192.
226. Cacchi, S.; Fabrizi, G.; Goggiamani, A. *Arkivoc* **2003**, *13*, 58–66.
227. Chandrasekhar, S.; Narsihmulu, C.; Shameem Sultana, S.; Ramakrishna Reddy, N. *Org. Lett.* **2002**, *4*, 4399–4401.
228. Carroll, M. A.; Holmes, A. B. *Chem. Commun.* **1998**, 1395–1396.
229. Morita, D. K.; Pesiri, D. R.; David, S. A.; Glaze, W. H.; Tumas, W. *Chem. Commun.* **1998**, 1397–1398.
230. Cacchi, S.; Fabrizi, G.; Gasparrini, F.; Villani, C. *Synlett* **1999**, 345–347.
231. Shezad, N.; Oakes, R. S.; Clifford, A. A.; Rayner, C. M. *Tetrahedron Lett.* **1999**, *40*, 2221–2224.
232. Shezad, N.; Clifford, A. A.; Rayner, C. M. *Tetrahedron Lett.* **2001**, *42*, 323–325.
233. For a recent account, see: Bhanage, B. M.; Fujita, S.; Arai, M. *J. Organomet. Chem.* **2003**, *687*, 211–218.
234. Fujita, S.; Yuzawa, K.; Bhanage, B. M.; Ikushima, Y.; Arai, M. *J. Mol. Catal. A: Chem.* **2002**, *180*, 35–42.
235. Kayaki, Y.; Noguchi, Y.; Ikariya, T. *Chem. Commun.* **2000**, 2245–2246.
236. Yeung, L. K.; Lee, C. T., Jr.; Johnston, K. P.; Crooks, R. M. *Chem. Commun.* **2001**, 2290–2291.
237. Early, T. R.; Gordon, R. S.; Carroll, M. A.; Holmes, A. B.; Shute, R. E.; McConvey, I. F. *Chem. Commun.* **2001**, 1966–1967.
238. Gordon, R. S.; Holmes, A. B. *Chem. Commun.* **2002**, 640–641.
239. Ley, S. V.; Ramarao, C.; Gordon, R. S.; Holmes, A. B.; Morrison, A. J.; McConvey, I. F.; Shirley, I. M.; Smith, S. C.; Smith, M. D. *Chem. Commun.* **2002**, 1134–1135.
240. Reardon, P.; Metts, S.; Crittendon, C.; Daugherty, P.; Parsons, E. J. *Organometallics* **1995**, *14*, 3810–3816.
241. (a) Zhang, R.; Zhao, F.; Sato, M.; Ikushima, Y. *Chem. Commun.* **2003**, 1548–1549. (b) Zhang, R.; Sato, O.; Zhao,

- F.; Sato, M.; Ikushima, Y. *Chem. Eur. J.* **2004**, *10*, 1501–1506.
242. Kaufmann, D. E.; Nouroozian, M.; Henze, H. *Synlett* **1996**, 1091–1092.
243. Carmichael, A. J.; Earle, M. J.; Holbrey, J. D.; McCormac, P. B.; Seddon, K. R. *Org. Lett.* **1999**, *1*, 997–1000.
244. Howarth, J.; Dallas, A. *Molecules* **2000**, *5*, 851–855.
245. (a) Herrmann, W. A.; Böhm, V. P. W. *J. Organomet. Chem.* **1999**, *572*, 141–145. (b) Böhm, V. P. W.; Herrmann, W. A. *Chem. Eur. J.* **2000**, *6*, 1017–1025.
246. Xu, L.; Chen, W.; Xiao, J. *Organometallics* **2000**, *19*, 1123–1127.
247. Calò, V.; Nacci, A. *Z. Naturforsch.* **2001**, *56a*, 702–706.
248. Calò, V.; Nacci, A.; Lopez, L.; Mannarini, N. *Tetrahedron Lett.* **2000**, *41*, 8973–8976.
249. Calò, V.; Nacci, A.; Monopoli, A.; Lopez, L.; di Cosmo, A. *Tetrahedron* **2001**, *57*, 6071–6077.
250. Calò, V.; Nacci, A.; Monopoli, A.; Laera, S.; Cioffi, N. *J. Org. Chem.* **2003**, *68*, 2929–2933.
251. Calò, V.; Nacci, A.; Monopoli, A.; Detomaso, A.; Iliade, P. *Organometallics* **2003**, *22*, 4193–4197.
252. Battistuzzi, G.; Cacchi, S.; Fabrizi, G. *Synlett* **2002**, 439–442.
253. Calò, V.; Nacci, A.; López, L.; Napola, A. *Tetrahedron Lett.* **2001**, *42*, 4701–4703.
254. Xu, L.; Chen, W.; Ross, J.; Xiao, J. *Org. Lett.* **2001**, *3*, 295–297.
255. Kabalka, G. W.; Dong, G.; Venkataiah, B. *Tetrahedron Lett.* **2004**, *45*, 2775–2777.
256. Gerritsma, D. A.; Robertson, A.; McNulty, J.; Capretta, A. *Tetrahedron Lett.* **2004**, *45*, 7629–7631.
257. Xie, X.; Chen, B.; Lu, J.; Han, J.; She, X.; Pan, X. *Tetrahedron Lett.* **2004**, *45*, 6235–6237.
258. Liu, S.; Fukuyama, T.; Sato, M.; Ryu, I. *Synlett* **2004**, 1814–1816.
259. Liu, S.; Fukuyama, T.; Ryu, I. *Org. Process Res. Dev.* **2004**, *8*, 477–481.
260. Deshmukh, R. R.; Rajagopal, R.; Srinivasan, K. V. *Chem. Commun.* **2001**, 1544–1545.
261. Vallin, K. S. A.; Emilsson, P.; Larhed, M.; Hallberg, A. *J. Org. Chem.* **2002**, *67*, 6243–6246.
262. Hagiwara, H.; Shimizu, Y.; Hoshi, T.; Suzuki, T.; Ando, M.; Ohkubo, K.; Yokoyama, C. *Tetrahedron Lett.* **2001**, *42*, 4349–4351.
263. Okubo, K.; Shirai, M.; Yokoyama, C. *Tetrahedron Lett.* **2002**, *43*, 7115–7118.
264. Perosa, A.; Tundo, P.; Selva, M.; Zinovyev, S.; Testa, A. *Org. Biomol. Chem.* **2004**, *2*, 2249–2252.
265. Xie, X.; Lu, J.; Chen, B.; Han, J.; She, X.; Pan, X. *Tetrahedron Lett.* **2004**, *45*, 809–811.
266. Bouquillon, S.; Ganchegui, B.; Estrine, B.; Héning, F.; Muzart, J. *J. Organomet. Chem.* **2001**, *634*, 153–156.
267. Park, S. B.; Alper, H. *Org. Lett.* **2003**, *5*, 3209–3212.
268. Zheng, R.; Yang, F.; Zou, G.; Tang, J.; He, M.-Y. *Chin. J. Chem.* **2003**, *21*, 1111–1113.
269. Zou, G.; Wang, Z.; Zhu, J.; Tang, J.; He, M.-Y. *J. Mol. Catal. A: Chem.* **2003**, *206*, 193–198.
270. Handy, S. T.; Okello, M.; Dickenson, G. *Org. Lett.* **2003**, *5*, 2513–2515.
271. Handy, S. T.; Okello, M. *Tetrahedron Lett.* **2003**, *44*, 8395–8397.
272. Calò, V.; Nacci, A.; Monopoli, A.; Fornaro, A.; Sabbatini, L.; Cioffi, N.; Ditaranto, N. *Organometallics* **2004**, *23*, 5154–5158.
273. Corma, A.; García, H.; Leyva, A. *Tetrahedron* **2004**, *60*, 8553–8560.
274. Xiao, J.-C.; Twamley, B.; Shreeve, J. M. *Org. Lett.* **2004**, *6*, 3845–3847.
275. Hamill, N. A.; Hardacre, C.; McMath, S. E. *J. Green Chem.* **2002**, *4*, 139–142.
276. Moineau, J.; Pozzi, G.; Quici, S.; Sinou, D. *Tetrahedron Lett.* **1999**, *40*, 7683–7686.
277. (a) Moreno-Mañas, M.; Pleixats, R.; Villarroya, S. *Organometallics* **2001**, *20*, 4524–4528. (b) See also: Moreno-Mañas, M.; Pleixats, R.; Villarroya, S. *Chem. Commun.* **2002**, 60–61.
278. (a) Rocaboy, C.; Gladysz, J. A. *Org. Lett.* **2002**, *4*, 1993–1996. (b) Rocaboy, C.; Gladysz, J. A. *New J. Chem.* **2003**, 39–49.
279. Vallin, K. S. A.; Zhang, Q.; Larhed, M.; Curran, D. P.; Hallberg, A. *J. Org. Chem.* **2003**, *68*, 6639–6645.
280. (a) Nakamura, Y.; Takeuchi, S.; Zhang, S.; Okumura, K.; Ohgo, Y. *Tetrahedron Lett.* **2002**, *43*, 3055–3056. (b) Nakamura, Y.; Takeuchi, S.; Ohgo, Y. *J. Fluorine Chem.* **2003**, *120*, 121–129.
281. Ozawa, F.; Kubo, A.; Hayashi, T. *J. Am. Chem. Soc.* **1991**, *113*, 1417–1419.
282. Bayardon, J.; Cavazzini, M.; Maillard, D.; Pozzi, G.; Quici, S.; Sinou, D. *Tetrahedron: Asymmetry* **2003**, *14*, 2215–2224.
283. Curran, D. P.; Fischer, K.; Moura-Letts, G. *Synlett* **2004**, 1379–1382.
284. Fukuyama, T.; Arai, M.; Matsubara, H.; Ryu, I. *J. Org. Chem.* **2004**, *69*, 8105–8107.
285. Yeung, L. K.; Crooks, R. M. *Nano Lett.* **2001**, *1*, 14–17.
286. Bumagin, N. A.; More, P. G.; Beletskaya, I. P. *J. Organomet. Chem.* **1989**, *371*, 397–401.
287. For examples of the Heck reaction conducted in superheated and sub-critical water, see: (a) Diminnie, J.; Metts, S.; Parsons, E. *J. Organometallics* **1995**, *14*, 4023–4025. (b) Gron, L. U. *Tetrahedron Lett.* **1999**, *40*, 227–230. (c) Gron, L. U.; LaCroix, J. E.; Higgins, C. J.; Steelman, K. L.; Tinsley, A. S. *Tetrahedron Lett.* **2001**, *42*, 8555–8557.
288. Xia, M.; Wang, Y. G. *Chin. Chem. Lett.* **2001**, *12*, 941–942.
289. Wang, J.-X.; Liu, Z.; Hu, Y.; Wei, B.; Bai, L. *Synth. Commun.* **2002**, *32*, 1607–1614.
290. Zhao, H.; Cai, M.-Z.; Peng, C.-Y. *Synth. Commun.* **2002**, *32*, 3419–3423.
291. Zhao, H.; Cai, M.-Z.; Peng, C.-Y.; Song, C.-S. *J. Chem. Res. (S)* **2002**, 28–29.
292. Solabannavar, S. B.; Desai, U. V.; Mane, R. B. *Green Chem.* **2002**, *4*, 347–348.
293. Hou, J.-J.; Yang, L.-R.; Cui, X.-L.; Wu, Y.-J. *Chin. J. Chem.* **2003**, *21*, 717–719.
294. Williams, D. B. G.; Lombard, H.; Holzapfel, C. W. *Synth. Commun.* **2001**, *31*, 2077–2081.
295. Nilsson, P.; Larhed, M.; Hallberg, A. *J. Am. Chem. Soc.* **2003**, *125*, 3430–3431.
296. Vallin, K. S. A.; Larhed, M.; Hallberg, A. *J. Org. Chem.* **2001**, *66*, 4340–4343.
297. Amengual, R.; Genin, E.; Michelet, V.; Savignac, M.; Genêt, J.-P. *Adv. Synth. Catal.* **2002**, *344*, 393–398.
298. Moore, L. R.; Shaughnessy, K. H. *Org. Lett.* **2004**, *6*, 225–228.
299. DeVasher, R. B.; Moore, L. R.; Shaughnessy, K. H. *J. Org. Chem.* **2004**, *69*, 7919–7927.
300. Nájera, C.; Gil-Moltó, J.; Karlström, S.; Falvello, L. R. *Org. Lett.* **2003**, *5*, 1451–1454.

301. Botella, L.; Nájera, C. *Tetrahedron Lett.* **2004**, *45*, 1833–1836.
302. Botella, L.; Nájera, C. *Tetrahedron* **2004**, *60*, 5563–5570.
303. Rabeyrin, C.; Sinou, D. *J. Mol. Catal. A: Chem.* **2004**, *215*, 89–93.
304. Mukhopadhyay, S.; Rothenberg, G.; Joshi, A.; Baidossi, M.; Sasson, Y. *Adv. Synth. Catal.* **2002**, *344*, 348–354.
305. For recent examples, see for instance: (a) Yokoyama, Y.; Hikawa, H.; Mitsunashi, M.; Uyama, A.; Hiroki, Y.; Murakami, Y. *Eur. J. Org. Chem.* **2004**, 1244–1253. (b) Tietze, L. F.; Wiegand, J. M.; Vock, C. A. *Eur. J. Org. Chem.* **2004**, 4107–4112.
306. Larhed, M.; Hallberg, A. *J. Org. Chem.* **1996**, *61*, 9582–9584.
307. Bergbreiter, D. E.; Furyk, S. *Green Chem.* **2004**, *6*, 280–285.
308. Svennebring, A.; Nilsson, P.; Larhed, M. *J. Org. Chem.* **2004**, *69*, 3345–3349.
309. Gracias, V.; Moore, J. D.; Djuric, S. W. *Tetrahedron Lett.* **2004**, *45*, 417–420.
310. For a recent comparative study of the Heck reaction under thermal and microwave conditions, see: Solabannavar, S. B.; Desai, U. V.; Mane, R. B. *Indian J. Chem., Sect. B* **2004**, *43B*, 2235–2237.
311. Stadler, A.; Yousefi, B. H.; Dallinger, D.; Walla, P.; Van der Eycken, E.; Kaval, N.; Kappe, C. O. *Org. Process Res. Dev.* **2003**, *7*, 707–716.
312. Bräse, S.; Enders, D.; Köbberling, J.; Avemaria, F. *Angew. Chem., Int. Ed.* **1998**, *37*, 3413–3415.
313. Dhas, N. A.; Gedanken, A. *J. Mater. Chem.* **1998**, *8*, 445–450.
314. Sugihara, T.; Takebayashi, M.; Kaneko, C. *Tetrahedron Lett.* **1995**, *36*, 5547–5550.
315. Hillers, S.; Reiser, O. *Tetrahedron Lett.* **1993**, *34*, 5265–5268.
316. Voigt, K.; Schick, U.; Meyer, F. E.; de Meijere, A. *Synlett* **1994**, 189–190.
317. (a) Hillers, S.; Reiser, O. *Chem. Commun.* **1996**, 2197–2198. (b) Hillers, S.; Sartori, S.; Reiser, O. *J. Am. Chem. Soc.* **1996**, *118*, 2087–2088.
318. (a) Tietze, L. F.; Burkhardt, O.; Henrich, M. *Liebigs Ann./Recueil* **1997**, 887–891. (b) Tietze, L. F.; Burkhardt, O.; Henrich, M. *Liebigs Ann./Recueil* **1997**, 1407–1413.
319. (a) Reiser, O. *Top. Catal.* **1998**, *5*, 105–112. (b) Reiser, O. In *High Pressure Chemistry. Synthetic, Mechanistic and Supercritical Applications*; van Eldik, R., Klärner, F. G., Eds.; Wiley-VCH: Weinheim, 2002; Chapter 7.
320. Buback, M.; Perković, T.; Redlich, S.; de Meijere, A. *Eur. J. Org. Chem.* **2003**, 2375–2382.
321. Klingelhöfer, S.; Heitz, W.; Greiner, A.; Oestreich, S.; Förster, S.; Antonietti, M. *J. Am. Chem. Soc.* **1997**, *119*, 10116–10120.
322. Sanji, T.; Ogawa, Y.; Nakatsuka, Y.; Tanaka, M.; Sakurai, H. *Chem. Lett.* **2003**, *32*, 980–981.
323. For a review, see: Duñach, E.; Franco, D.; Olivero, S. *Eur. J. Org. Chem.* **2003**, 1605–1622.
324. Reetz, M.; Lohmer, G. *Chem. Commun.* **1996**, 1921–1922.
325. Gomes, P.; Gosmini, C.; Nédélec, J.-Y.; Périchon, J. *Tetrahedron Lett.* **2002**, *43*, 5901–5903.
326. (a) Nair, D.; Scarpello, J. T.; White, L. S.; Freitas dos Santos, L. M.; Vankelecom, I. F. J.; Livingston, A. G. *Tetrahedron Lett.* **2001**, *42*, 8219–8222. (b) Nair, D.; Scarpello, J. T.; Freitas dos Santos, L. M.; White, L. S.; Kloetzing, R. J.; Welton, T.; Livingston, A. G. *Green Chem.* **2002**, *4*, 319–324. (c) Nair, D.; Luthra, S. S.; Scarpello, J. T.; White, L. S.; Freitas dos Santos, L. M.; Livingston, A. G. *Desalination* **2002**, *147*, 301–306.
327. Turlan, D.; Urriolabitia, E. P.; Navarro, R.; Royo, C.; Menéndez, M.; Santamaría, J. *Chem. Commun.* **2001**, 2608–2609.
328. Solodenko, W.; Wen, H.; Leue, S.; Stuhlmann, F.; Sourkouni-Argirusi, G.; Jas, G.; Schönfeld, H.; Kunz, U.; Kirschning, A. *Eur. J. Org. Chem.* **2004**, 3601–3610.
329. Tullberg, E.; Peters, D.; Frejd, T. *J. Organomet. Chem.* **2004**, *689*, 3778–3781.

Biographical sketch

Francisco Alonso was born in Villena (Alicante) in 1963. He received his BSc (1986), MSc (1988), and PhD (1991) degrees in Chemistry from the University of Alicante. After a postdoctoral stay (1992–1994) as a Fleming fellow at the University of Oxford, UK, with Professor S. G. Davies, he moved back to the University of Alicante and joined the research group of Professor M. Yus. He became Associate Professor in 1998, and his research interest has focused on the development of new synthetic methodologies involving active metals and the application of organometallic intermediates to the synthesis of naturally occurring molecular structures. He was awarded the PhD Extraordinary Prize in 1992.

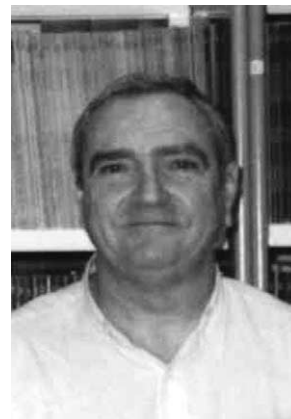

Miguel Yus was born in Zaragoza in 1947. He received the BSc (1969), MSc (1971), and PhD (1973) degrees from the University of Zaragoza. After spending 2 years as a postdoc at the Max Planck Institut für Kohlenforschung in Mülheim a.d. Ruhr, he returned to the University of Oviedo where he became Associate Professor in 1977, being promoted to full Professor in 1987 at the same university. In 1988 he moved to a chair in organic chemistry at the University of Alicante, where he has been the head of the Organic Chemistry Department until 2004, when he was appointed to Director of the newly created Institute of Organic Synthesis (ISO) at the same university. Professor Yus has been visiting professor at different institutions such as ETH-Zürich and the universities of Oxford, Harvard, Uppsala, Marseille, Tucson, Okayama, Paris VI and Strasbourg. He is member or fellow of the chemical societies of Argentina, England, Germany, Japan, Spain, Switzerland and United States. He is co-author of more than 350 papers and three patents, mainly in the field of the development of new methodologies involving organometallic intermediates in synthetic organic chemistry. Among others, he has recently received the Spanish–French Prize (1999), the Japan Society for the Promotion of Science Prize (2000) and the Stiefvater Memorial Lectureship Award (2001). Professor Yus belongs to the advisory board of the journals *Tetrahedron*, *Tetrahedron Letters*, *European Journal of Organic Chemistry*, *Chemistry Letters* and *Trends in Organic Chemistry*. Last year, he and other members of the ISO founded the new chemical company MEDALCHEMY, S. L. to commercialise fine chemicals.



Irina Beletskaya received her Diploma degree in 1955, her PhD Degree in 1958, and her Doctor of Chemistry degree in 1963 from Moscow State University. The subject for the latter was Electrophilic Substitution at Saturated Carbon. She became a Full Professor in 1970 and in 1974 a Corresponding Member of the Academy of Sciences (USSR), of which she became a full member (Academician) in 1992. She is currently Head of the Laboratory of Organoelement Compounds, Department of Chemistry, Moscow State University. Irina Beletskaya is Chief Editor of the *Russian Journal of Organic Chemistry*. She was President of the Organic Chemistry Division of IUPAC from 1989 to 1991. She was recipient of the Lomonosov Prize (1979), the Mendeleev Prize (1982), and the Nesmeyanov Prize (1991). She is the author of more than 500 articles and 4 monographs. Her current scientific interests are focused on (i) transition-metal catalysis in organic synthesis; (ii) organic derivatives of lanthanides; and (iii) carbanions and nucleophilic aromatic substitution.

Aza Diels–Alder reactions utilizing 4-iodo-2-trimethylsilyloxy-butadiene

Cody Timmons, Adishesu Kattuboina, Lauren McPherson, James Mills and Guigen Li*

Department of Chemistry and Biochemistry, Texas Tech University, Lubbock, TX 79409-1061, USA

Received 3 August 2005; revised 27 September 2005; accepted 10 October 2005

Available online 2 November 2005

Abstract—The aza Diels–Alder reaction is described for a novel diene. Imines bearing benzyl and aromatic protecting groups both work well. Moderate diastereoselectivities can be obtained using the simple α -methylbenzyl chiral auxiliary.
 © 2005 Elsevier Ltd. All rights reserved.

1. Introduction

The aza Diels–Alder reaction is among the most powerful methodologies for the construction of six-membered nitrogen heterocycles. Such compounds are of interest in the field of medicinal chemistry and have emerged as important building blocks in organic synthesis.¹

Recently, a few reports have surfaced regarding the reaction of Danishefsky's diene and imines to produce dihydropyridones.² Such products are potentially quite versatile intermediates for the synthesis of *N*-heterocyclic natural products, such as indolizidines and related alkaloids.³ Additionally, the enantioselective conjugate addition of nucleophiles to dihydropyridones has recently emerged as an important topic of interest in the field of asymmetric synthesis.⁴

As a whole, the majority of the Diels–Alder strategies for the preparation of dihydropyridones have utilized imines prepared from aniline or other similar aromatic amines. Such a strategy presents challenges with regard to the

limited number of methods available for the removal of *N*-aryl protecting groups. A practically attractive alternative would be the use of more easily cleaved protecting group, such as tosyl^{2f} or benzyl.

Recently, we have reported the preparation of a novel iodo diene from the reaction of 3-buten-2-one and trimethylsilyl iodide (Scheme 1).⁵ The diene has been characterized in situ by performing the reaction in deuterated solvent. This diene has been found to react with aldehydes in an aldol type fashion in either the absence or in the presence of an appropriate catalyst to produce the resulting halo-aldol type products in high yield and *E/Z* stereoselectivity. Such products contain several sites of functionalization and therefore are quite versatile synthetic intermediates. In an effort to extend the scope of this process, we sought to utilize imines as electrophilic acceptors to provide the analogous halo-Mannich type products. Such a reaction would complement our earlier methodology in which normal asymmetric halo-Mannich type products were obtained from the reaction between chiral cyclopropyl imides and imines in the presence of Et₂AlI and were cyclized to five-membered *N*-heterocycles.⁶

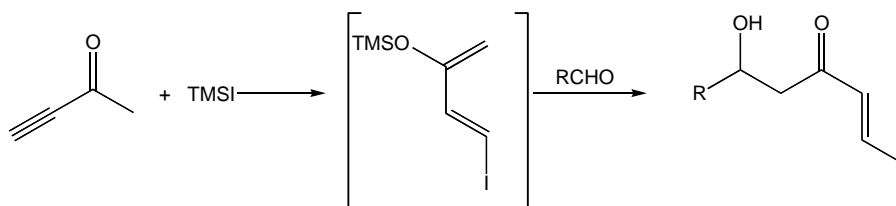

Scheme 1.

Keywords: Aza Diels–Alder; Dihydropyridones; Magnesium iodide.

* Corresponding author. Tel.: +1 806 742 3015; fax: +1 806 742 1289; e-mail: guigen.li@ttu.edu

2. Results and discussion

Initial attempts at this halo-Mannich reaction utilized the benzenesulfonyl-protected imine of 4-tolualdehyde. In the absence of catalyst, the desired product was formed in 20% yield after 24 h at 0 °C in CH₂Cl₂. The reaction was clean, with only starting materials and products observed in the crude reaction mixture. The structure of the product was confirmed by ¹H, ¹³C, DEPT and 2-D NMR techniques (COSY and HMQC). In particular, a doublet at 5.56 ppm in the ¹H NMR spectrum was easily assigned as an N–H proton. In an effort to improve the yield, various conditions were explored. Extended reaction times did not lead to an increased conversion percentage. The use of other solvents (THF, ether, acetonitrile, toluene) failed to facilitate any improvements. When a number of Lewis acid catalysts (TiCl₄, SnCl₄, MgI₂, Et₂AlI) were screened, only the first two produced any product at all, while the use of the others all resulted in no product formation. Unfortunately, even with high catalyst loading (up to 100%) the highest yield obtained was ~35–40%. The use of 4-tosyl and 2-nosyl protecting groups were found to provide similar results.

With these initial discouraging results in hand, we then turned our attention to utilizing other protecting groups. When the imine prepared from 4-tolualdehyde and benzyl amine was used as the electrophilic acceptor, we were pleased to find that a similar product was obtained. Interestingly, though, in the ¹H NMR spectrum the presence of an N–H proton was conspicuously lacking. Closer inspection showed a molecular weight of 277 amu by GC/MS analysis and a carbonyl stretching vibration of 1638 cm⁻¹ in the FTIR spectrum, which is consistent with an amide, or its vinylogous analog. Such results are indicative of the formation of a benzyl-protected aza Diels–Alder product (Scheme 2).

Encouraged by these results, attention was turned to optimizing this process. Again a variety of potential Lewis acid catalysts were screened and MgI₂ was found to be optimal. Unfortunately, it was found that substoichiometric loadings of MgI₂ failed to promote the reaction to

completion.⁷ However, with 100% Lewis acid loading the reaction proceeded to completion in 22 h at 0 °C in CH₂Cl₂ as monitored by ¹H NMR analysis of the crude reaction mixtures. Furthermore, a 2 to 1 ratio of diene to imine was found to be favorable for reasonable reaction rates and high yields. It should be noted that a 1:1 ratio of diene to imine did not result in the complete consumption of imine even after 48 h at 0 °C. With regard to solvents, both THF and toluene work, albeit with somewhat diminished yields. Acetonitrile was found to give unsatisfactory results.

In light of the above results, the optimized reaction conditions were found to be as follows: 2.0 equiv iodosilyloxy diene (prepared by stirring 3-butyn-2-one and TMSI in dry CH₂Cl₂ at 0 °C for 30 min under an inert atmosphere) were added to benzyl-protected imine (1.0 equiv) and MgI₂ (1.0 equiv) in CH₂Cl₂ under an inert atmosphere. The reaction was stirred at 0 °C for 22 h before being quenched with 1 N HCl and subjected to standard extractive workup. The results of this reaction process utilizing a variety of benzyl-protected imines⁸ are summarized in Table 1.

As can be seen from Table 1, imine substrates bearing nearly electroneutral or even strongly electron-withdrawing substituents all worked very well. On the other hand, attempts at using the imine prepared from 4-anisaldehyde, which bears the strongly electron-donating methoxy group, resulted in low conversion and the formation of only a trace amount of product. Additionally, the use of benzyl imine prepared from 2-tolualdehyde failed to result in any product at all, presumably due to unfavorable steric interactions.

After establishing this protocol for the synthesis of *N*-benzyl aza Diels–Alder products, we then turned our attention to other *N*-protecting groups in order to explore the generality of this process. We were pleased to find that a number of imines with *N*-aromatic groups all worked well for this reaction. Furthermore, these imines were found to be more reactive, giving typically higher yields in shorter reaction

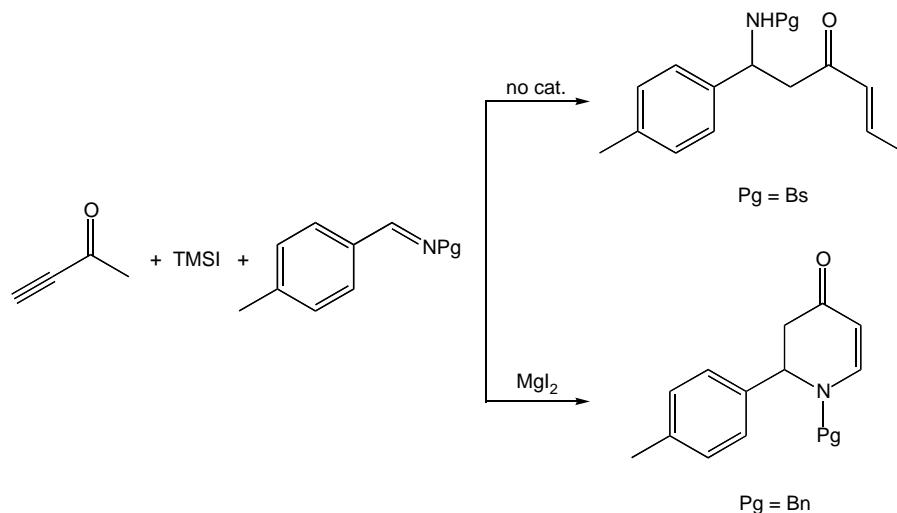

Scheme 2.

times (12 h rather than 22 h). The results are summarized in Table 2.

Table 1. Results of aza Diels–Alder reaction using Bn-protected imines

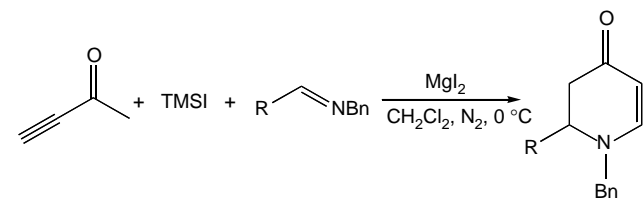

Entry	R	Product	Yield ^a
1	Ph–	1a	77
2	4-Me-C ₆ H ₄ –	2a	84
3	4-CF ₃ -C ₆ H ₄ –	3a	91
4	4-NO ₂ -C ₆ H ₄ –	4a	88
5	4-F-C ₆ H ₄ –	5a	86
6	4-Cl-C ₆ H ₄ –	6a	85
7	4-Br-C ₆ H ₄ –	7a	79

^a Yield of pure product after column chromatography.

Table 2. Results of aza Diels–Alder reaction using aromatic protecting groups

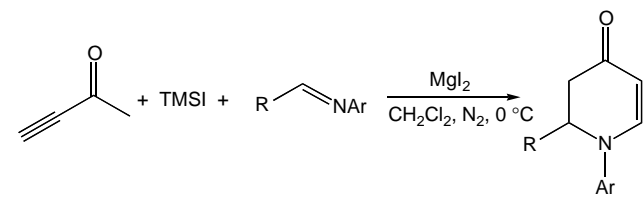

Entry	R	Ar	Product	Yield ^a
1	Ph–	Ph–	1b	87
2	4-Cl-C ₆ H ₄ –	Ph–	6b	90
3	4-Cl-C ₆ H ₄ –	4-Br-C ₆ H ₄ –	6c	94
4	4-Cl-C ₆ H ₄ –	4-MeO-C ₆ H ₄ –	6d	94

^a Yield of pure product after column chromatography.

Due to the large demand for chiral heterocyclic building blocks, efficient routes to asymmetric dihydropyridones are quite important in organic chemistry. Several chiral catalysts were screened with the hopes of developing an enantioselective aza Diels–Alder reaction. Binol–TiCl₂ complex alone failed to produce any desired Diels–Alder product. Interestingly, both isopropyl-Pybox/MgI₂ complex and isopropyl-Pybox/Cu(OTf)₂ complex failed to promote the aza Diels–Alder reaction with benzyl imines, but both did effectively promote the reaction with aromatic-protected imines. Unfortunately, the products from both reactions were racemic. Interestingly, the use of BinolBOPh^{2b} did result in the formation of the product in <40% yield, but no enantioselectivity was observed. With these results in hand, attention was then turned to focus on chiral auxiliary-controlled processes.

To date, the majority of diastereomerically controlled aza Diels–Alder reactions have been performed utilizing chiral imines derived from sugars,⁹ amino esters,¹⁰ or chiral amino alcohols.¹¹ Unfortunately, these products often suffer from the difficulty in removing the protecting group. With this in mind, we sought to extend the scope of this reaction to substrates bearing chiral auxiliaries that are easily removed.

Initial attempts at utilizing the chiral *p*-tolylsulfinyl protecting group repeatedly resulted in no reaction. In all instances starting materials were quantitatively recovered intact. We then turned our attention to the simpler chiral imines derived from (*S*)- α -methylbenzyl amine since this type of imine bears a strong resemblance to the benzyl protected imines. Fortunately, when the corresponding imine prepared from benzaldehyde was utilized, the two possible diastereomers were isolated in moderate yield. Furthermore, the two diastereomers, obtained in a 3:1 ratio, were readily separated and isolated in diastereomerically pure form by column chromatography.¹² In light of these results, several chiral imines were prepared and subjected to these conditions. The results are summarized in Table 3.

Table 3. Results of diastereoselective aza Diels–Alder reaction

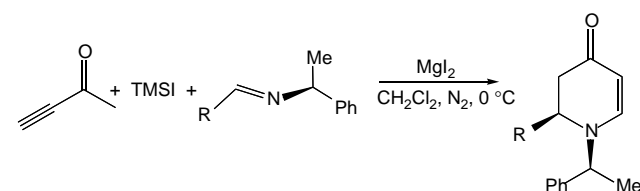

Entry	R	Product	Diastereo-selectivity ^a	Yield ^b
1	Ph–	1e	3:1	61
2	4-CF ₃ -C ₆ H ₄ –	3e	3:1	84
3	4-Cl-C ₆ H ₄ –	6e	3:1	72
4	<i>n</i> -Pr–	8e	4.5:1	62
5	3-NO ₂ -C ₆ H ₄ –	9e	4:1	82
6	2,4-(NO ₂) ₂ -C ₆ H ₃ –	10e	4:1	85

^a Determined by ¹H NMR analysis of the crude reaction mixture.

^b Combined yield of 2 isomers after purification by column chromatography.

As can be seen from Table 3, a number of electroneutral and electron-poor substrates are tolerated in this process. Moderate diastereoselectivities were observed, however, it is important to note that all products were readily separable with standard column chromatography techniques. Of particular interest in Table 3 are entries 4 and 5, in which aliphatic and *meta*-substituted aromatic imines were successfully utilized as substrates for the aza Diels–Alder reaction. Furthermore, a 2,4-disubstituted substrate (entry 6) was also found to work well if the groups were strongly electron withdrawing. Comparison of Tables 1 and 3 demonstrates that these α -methylbenzyl imines are slightly less reactive than the corresponding benzyl imines, presumably due to increased steric bulk.

With regard to mechanism, two possibilities seem plausible. A [4+2] cycloaddition followed by elimination of iodine would constitute the typical Diels–Alder pathway. Alternatively, it has been shown in similar reactions utilizing Danishefsky's diene that such reactions occur via a Mannich/cyclization pathway.^{2d,f} A mechanistic study is currently underway and relevant results will be disclosed in due course.

In summary, a new method for the synthesis of dihydropyridones has been reported. The reaction is tolerant of a variety of substrates, including *N*-benzyl- and

N-aryl-protected imines. Attempts at rendering the reaction asymmetric have been successful. Importantly, this work represents the first Diels–Alder type reaction with this new class of iodo-diene.

3. Experimental

3.1. General methods

All reactions were performed in oven-dried glassware. Dichloromethane was purified and dried via an Alumina column immediately prior to use. NMR spectra were recorded on a Varian Inova NMR spectrometer operating at 500 MHz (^1H) and 125 MHz (^{13}C) or on a Varian Mercury NMR spectrometer operating at 300 MHz (^1H) and 75 MHz (^{13}C). Shift values are reported in ppm and are referenced based on TMS or solvent for ^1H and ^{13}C , respectively. All spectra were recorded in CDCl_3 . ^{19}F NMR spectra, where applicable, were recorded in CDCl_3 and shifts are reported based on an external TFA reference. Imines were prepared according to standard methods. All other commercially available chemicals were used without further purification and stoichiometries were calculated by the purities reported by the manufacturers. Purification was performed by flash chromatography on silica gel (Merck 60, 230–400 mesh). IR spectra were recorded as CH_2Cl_2 deposits on a NaCl disk. Unless otherwise indicated, optical rotations were performed in CH_2Cl_2 with a concentration of 0.5.

3.2. Procedure for the aza Diels–Alder reaction

Into a dried, N_2 flushed vial was added CH_2Cl_2 (2.0 mL), 3-butyn-2-one (1.1 mmol), and iodotrimethylsilane (1.0 mmol) at 0°C . Concurrently, into another dried, N_2 flushed vial containing 0.5 mmol MgI_2 was added imine (0.5 mmol) and 2 mL CH_2Cl_2 . Both vials were stirred for 30 min at 0°C , at which time the contents of the first vial were transferred to the second via syringe. The reaction was stirred at 0°C under N_2 atmosphere until completion was observed by ^1H NMR analysis, at which time it was quenched with 5 mL 1 M HCl. The mixture was extracted with CH_2Cl_2 , washed with brine, and dried over anhydrous Na_2SO_4 . The crude extract was concentrated to dryness and directly subjected to column chromatography (EtOAc/hexane, 1:3 \rightarrow 3:1) to afford the pure product.

3.3. Spectroscopic data

3.3.1. *N*-Benzyl-2,3-dihydro-2-phenyl-4-pyridone (1a). This is a known compound. ^1H NMR spectral data are consistent with literature values.^{2b} ^1H NMR (300 MHz, CDCl_3): 7.40–7.10 (m, 11H), 5.08 (d, $J=7.8$ Hz, 1H), 4.50 (t, $J=7.5$ Hz, 1H), 4.35 (d, $J=15.3$ Hz, 1H), 4.13 (d, $J=15.0$ Hz, 1H), 2.85 (dd, $J=7.2$, 16.5 Hz, 1H), 2.68 (dd, $J=7.8$, 16.5 Hz, 1H).

3.3.2. *N*-Benzyl-2,3-dihydro-2-(4-methylphenyl)-4-pyridone (2a). Isolated as an oil. ^1H NMR (500 MHz, CDCl_3): 7.37–7.30 (m, 3H), 7.27 (d, $J=8.0$ Hz, 1H), 7.17–7.12 (m, 6H), 5.08 (d, $J=7.5$ Hz, 1H), 4.46 (t, $J=7.5$ Hz, 1H), 4.32 (d, $J=15$ Hz, 1H), 4.12 (d, $J=15.5$ Hz,

1H), 2.80 (dd, $J=7.0$, 16.5 Hz, 1H), 2.68 (dd, $J=8.5$, 16.5 Hz, 1H), 2.35 (s, 3H). ^{13}C NMR (125 MHz, CDCl_3): 190.6, 154.1, 138.1, 136.0, 135.6, 129.7, 128.9, 128.2, 127.7, 127.1, 98.7, 60.5, 57.1, 43.8, 21.1. FTIR: 1638.0 cm^{-1} . GC/MS: $m/z=277$ (M^+ , 91%), 249 (25%), 186 (26%), 118 (74%), 91 (100%). Calculated for $\text{C}_{19}\text{H}_{19}\text{NO}$: $\text{M}^+=277$.

3.3.3. *N*-Benzyl-2,3-dihydro-2-(4-trifluoromethylphenyl)-4-pyridone (3a). Isolated as an oil. ^1H NMR (500 MHz, CDCl_3): 7.63–7.60 (m, 2H), 7.39–7.32 (m, 6H), 7.15–7.13 (m, 2H), 5.11 (d, $J=7.5$ Hz, 1H), 4.56 (t, $J=7.5$ Hz, 1H), 4.40 (d, $J=15$ Hz, 1H), 4.12 (d, $J=15$ Hz, 1H), 2.90 (dd, $J=7.0$, 16.5 Hz, 1H), 2.62 (dd, $J=7.0$, 16.5 Hz, 1H). ^{19}F NMR (212.3 MHz, CDCl_3): -63.06 (s). ^{13}C NMR (125 MHz, CDCl_3): 189.5, 153.9, 142.6, 135.5, 130.6 (q, $J=32.1$ Hz), 129.1, 128.4, 127.7, 127.4, 126.0 (q, $J=1.9$ Hz), 123.8 (q, $J=270.5$ Hz), 99.1, 60.0, 43.3. FTIR: 1638.9 cm^{-1} . HRMS MH^+ : expected: 332.1257 found: 332.1266.

3.3.4. *N*-Benzyl-2,3-dihydro-2-(4-nitrophenyl)-4-pyridone (4a). Isolated as an oil. ^1H NMR (500 MHz, CDCl_3): 8.23–8.20 (m, 2H), 7.44–7.41 (m, 2H), 7.37–7.34 (m, 4H), 7.15–7.13 (m, 2H), 5.13 (d, $J=7.5$ Hz, 1H), 4.61 (t, $J=7.0$ Hz, 1H), 4.44 (d, $J=15$ Hz, 1H), 4.12 (d, $J=15$ Hz, 1H), 2.93 (dd, $J=7.0$, 16.5 Hz, 1H), 2.61 (dd, $J=7.0$, 16.5 Hz, 1H). ^{13}C NMR (125 MHz, CDCl_3): 189.0, 153.8, 147.8, 145.9, 135.2, 129.1, 128.6, 127.9, 127.6, 124.3, 99.4, 59.7, 57.9, 43.0. FTIR: 1637.5 cm^{-1} . HRMS MH^+ : expected: 309.1234 found: 309.1224.

3.3.5. *N*-Benzyl-2,3-dihydro-2-(4-fluorophenyl)-4-pyridone (5a). Isolated as an oil. ^1H NMR (500 MHz, CDCl_3): 7.38–7.31 (m, 3H), 7.29 (d, $J=7.5$ Hz, 1H), 7.23–7.20 (m, 2H), 7.13–7.10 (m, 2H), 7.06–7.01 (m, 2H), 5.09 (d, $J=7.5$ Hz, 1H), 4.48 (t, $J=7.5$ Hz, 1H), 4.35 (d, $J=15$ Hz, 1H), 4.01 (d, $J=15.5$ Hz, 1H), 2.83 (dd, $J=7.0$, 16.5 Hz, 1H), 2.64 (dd, $J=7.5$, 16.5 Hz, 1H). ^{19}F NMR (212.3 MHz, CDCl_3): -113.86 (m). ^{13}C NMR (125 MHz, CDCl_3): 190.1, 162.5 (d, $J=245.9$ Hz), 154.1, 135.7, 134.4 (d, $J=3.4$ Hz), 129.0, 128.8, 128.6 (d, $J=68.6$ Hz), 127.6, 115.9 (d, $J=21.6$ Hz), 98.8, 59.9, 57.3, 43.7. FTIR: 1637.9 cm^{-1} . HRMS MH^+ : expected: 282.1289 found: 282.1290.

3.3.6. *N*-Benzyl-2,3-dihydro-2-(4-chlorophenyl)-4-pyridone (6a). Isolated as an oil. ^1H NMR (500 MHz, CDCl_3): 7.38–7.31 (m, 5H), 7.29 (d, $J=7.5$ Hz, 1H), 7.20–7.17 (m, 2H), 7.14–7.11 (m, 2H), 5.09 (d, $J=7.5$ Hz, 1H), 4.47 (t, $J=7.5$ Hz, 1H), 4.36 (d, $J=15.5$ Hz, 1H), 4.10 (d, $J=15$ Hz, 1H), 2.83 (dd, $J=7.0$, 16.5 Hz, 1H), 2.62 (dd, $J=8.0$, 16.5 Hz, 1H). ^{13}C NMR (125 MHz, CDCl_3): 189.9, 154.0, 137.1, 135.6, 134.1, 129.2, 129.0, 128.5, 128.3, 127.7, 99.0, 59.9, 57.4, 43.5. FTIR: 1637.7 cm^{-1} . HRMS MH^+ : expected: 298.0993 found: 298.0988.

3.3.7. *N*-Benzyl-2,3-dihydro-2-(4-bromophenyl)-4-pyridone (7a). Isolated as an oil. ^1H NMR (500 MHz, CDCl_3): 7.50–7.47 (m, 2H), 7.38–7.33 (m, 3H), 7.29 (d, $J=7.5$ Hz, 1H), 7.14–7.11 (m, 4H), 5.09 (d, $J=8.0$ Hz, 1H), 4.46 (t, $J=7.5$ Hz, 1H), 4.36 (d, $J=15.5$ Hz, 1H), 4.10 (d, $J=15$ Hz, 1H), 2.83 (dd, $J=7.0$, 16.5 Hz, 1H), 2.62 (dd, $J=8.0$, 16.5 Hz, 1H). ^{13}C NMR (125 MHz, CDCl_3): 189.9,

154.0, 137.6, 135.6, 132.2, 129.0, 128.8, 128.3, 127.7, 122.2, 99.0, 60.0, 57.4, 43.5. FTIR: 1637.7 cm^{-1} . HRMS MH^+ : expected: 342.0488 found: 342.0477.

3.3.8. *N*-Phenyl-2,3-dihydro-2-phenyl-4-pyridone (1b).

This is a known compound. ^1H NMR spectral data are consistent with literature values.^{2g} ^1H NMR (500 MHz, CDCl_3): 7.68 (dd, $J=1.0, 7.5$ Hz, 1H), 7.34–7.26 (m, 7H), 7.12–7.09 (m, 1H), 7.03–7.01 (m, 2H), 5.30–5.27 (m, 2H), 3.31 (dd, $J=7.5, 16.5$ Hz, 1H), 2.79 (ddd, $J=1.0, 3.0, 16.5$ Hz, 1H).

3.3.9. *N*-Phenyl-2,3-dihydro-2-(4-chlorophenyl)-4-pyridone (6b).

This is a known compound. ^1H NMR spectral data are consistent with literature values.^{2g} ^1H NMR (500 MHz, CDCl_3): 7.65 (dd, $J=1.0, 7.5$ Hz, 1H), 7.33–7.29 (m, 4H), 7.22–7.19 (m, 2H), 7.14–7.11 (m, 1H), 7.05–6.99 (m, 2H), 5.29 (dd, $J=1.0, 8.0$ Hz, 1H), 5.26 (dd, $J=3.0, 7.0$ Hz, 1H), 3.29 (dd, $J=7.5, 16.5$ Hz, 1H), 2.74 (ddd, $J=1.0, 3.5, 16.5$ Hz, 1H).

3.3.10. *N*-(4-Bromophenyl)-2,3-dihydro-2-(4-chlorophenyl)-4-pyridone (6c).

Isolated as an oil. ^1H NMR (500 MHz, CDCl_3): 7.58 (dd, $J=1.0, 8.0$ Hz, 1H), 7.42–7.40 (m, 2H), 7.32–7.29 (m, 2H), 7.19–7.17 (m, 2H), 6.89–6.85 (m, 2H), 5.31 (dd, $J=0.5, 8.0$ Hz, 1H), 5.21 (dd, $J=3.0, 7.0$ Hz, 1H), 3.27 (dd, $J=7.0, 16.5$ Hz, 1H), 2.75 (ddd, $J=1.0, 3.0, 16.5$ Hz, 1H). ^{13}C NMR (125 MHz, CDCl_3): 189.7, 147.5, 143.5, 136.1, 134.0, 132.6, 129.4, 127.5, 120.1, 117.5, 103.8, 61.2, 43.3. FTIR: 1650.4 cm^{-1} . HRMS MH^+ : expected: 361.9942 found: 361.9933.

3.3.11. *N*-(4-Methoxyphenyl)-2,3-dihydro-2-(4-chlorophenyl)-4-pyridone (6d).

Isolated as an oil. ^1H NMR (500 MHz, CDCl_3): 7.52 (dd, $J=1.0, 7.5$ Hz, 1H), 7.29–7.26 (m, 2H), 7.21–7.19 (m, 2H), 6.95–6.92 (m, 2H), 6.83–6.80 (m, 2H), 5.23 (dd, $J=1.0, 7.5$ Hz, 1H), 5.16 (dd, $J=4.0, 7.0$ Hz, 1H), 3.77 (s, 3H), 3.24 (dd, $J=7.5, 16.5$ Hz, 1H), 2.72 (ddd, $J=1.0, 4.0, 16.5$ Hz). ^{13}C NMR (125 MHz, CDCl_3): 189.7, 157.0, 149.5, 138.1, 136.8, 133.7, 129.1, 127.8, 121.2, 114.7, 101.8, 61.9, 55.5, 43.3. FTIR: 1646.6 cm^{-1} . HRMS MH^+ : expected: 314.0942 found: 314.0936.

3.3.12. (2*R*)-2,3-Dihydro-*N*-(*S*)- α -methylbenzyl-2-phenyl-4-pyridone (1e).

This is a known compound. ^1H NMR spectral and optical rotation data are consistent with literature values.^{2b} ^1H NMR (300 MHz, CDCl_3): 7.26–7.45 (m, 10H), 7.04 (d, $J=7.8$ Hz, 1H), 5.04 (d, $J=7.8$ Hz, 1H), 4.70 (dd, $J=6.6, 9.0$ Hz, 1H), 4.43 (q, $J=6.9$ Hz, 1H), 2.82 (dd, $J=6.9, 16.5$ Hz, 1H), 2.71 (dd, $J=9.0, 16.5$ Hz, 1H), 1.47 (d, $J=6.9$ Hz, 3H). $[\alpha]_{\text{D}}^{24}$: lit: –181.7, Found: –177.8 (*c* 1.7, CHCl_3).

3.3.13. (2*R*)-2,3-Dihydro-*N*-(*S*)- α -methylbenzyl-2-(4-trifluoromethylphenyl)-4-pyridone (3e).

Isolated as an oil. ^1H NMR (500 MHz, CDCl_3): 7.62 (d, $J=8.0$ Hz, 2H), 7.49 (d, $J=8.0$ Hz, 2H), 7.41–7.38 (m, 2H), 7.36–7.32 (m, 1H), 7.29–7.27 (m, 2H), 7.16 (d, $J=7.5$ Hz, 1H), 5.06 (d, $J=7.5$ Hz, 1H), 4.73 (dd, $J=7.0, 7.0$ Hz, 1H), 4.47 (q, $J=7.0$ Hz, 1H), 2.89 (dd, $J=7.0, 16.5$ Hz, 1H), 2.59 (dd, $J=7.0, 16.5$ Hz, 1H), 1.49 (d, $J=7.0$ Hz, 3H). ^{19}F NMR (212.3 MHz, CDCl_3): –63.06 (s). ^{13}C NMR (125 MHz,

CDCl_3): 189.5, 151.8, 143.7, 139.5, 130.5 (q, $J=32.6$ Hz), 129.0, 128.4, 127.3, 127.2, 126.1 (q, $J=3.9$ Hz), 123.8 (q, $J=270.5$ Hz), 99.9, 60.5, 59.6, 43.6, 17.9. FTIR: 1637.9 cm^{-1} . $[\alpha]_{\text{D}}^{24}$: –90.4. HRMS MH^+ : expected: 346.1413 found: 346.1410.

3.3.14. (2*R*)-2,3-Dihydro-*N*-(*S*)- α -methylbenzyl-2-(4-chlorophenyl)-4-pyridone (6e).

Isolated as an oil. ^1H NMR (500 MHz, CDCl_3): 7.40–7.31 (m, 7H), 7.28–7.26 (m, 2H), 7.09 (d, $J=7.5$ Hz, 1H), 5.04 (d, $J=7.5$ Hz, 1H), 4.66 (dd, $J=7.0, 7.0$ Hz, 1H), 4.44 (q, $J=7.0$ Hz, 1H), 2.82 (dd, $J=7.0, 16.5$ Hz, 1H), 2.61 (dd, $J=8.0, 16.5$ Hz, 1H), 1.47 (d, $J=7.0$ Hz, 3H). ^{13}C NMR (125 MHz, CDCl_3): 189.9, 151.8, 139.6, 138.1, 134.1, 129.3, 128.9, 128.3, 1228.2, 127.3, 99.8, 59.83, 59.80, 43.9, 17.7. FTIR: 1637.6 cm^{-1} . $[\alpha]_{\text{D}}^{24}$: –175.5. HRMS MH^+ : expected: 312.115 found: 312.1144.

3.3.15. (2*R*)-2,3-Dihydro-*N*-(*S*)- α -methylbenzyl-2-*n*-propyl-4-pyridone (8e).

This is a known compound.^{2b} ^1H NMR spectral and optical rotation data are consistent with literature values. ^1H NMR (300 MHz, CDCl_3): 7.50–7.30 (m, 5H), 6.90 (d, $J=7.2$ Hz, 1H), 4.87 (d, $J=7.2$ Hz, 1H), 4.56 (q, $J=6.9$ Hz, 1H), 3.51–3.61 (m, 1H), 2.68 (dd, $J=6.6, 16.2$ Hz, 1H), 2.32 (dd, $J=2.7, 16.2$ Hz, 1H), 2.10–1.90 (m, 1H), 1.66 (d, $J=6.9$ Hz, 3H), 1.52–1.20 (m, 3H), 0.92 (t, $J=7.2$ Hz, 3H). $[\alpha]_{\text{D}}^{24}$: lit: +163.1, Found: +161.8 (*c* 1.0, CHCl_3).

3.3.16. (2*R*)-2,3-Dihydro-*N*-(*S*)- α -methylbenzyl-2-(3-nitrophenyl)-4-pyridone (9e).

Isolated as an oil. ^1H NMR (500 MHz, CDCl_3): 8.17–8.15 (m, 2H), 7.69–7.67 (m, 1H), 7.56–7.51 (m, 1H), 7.41–7.33 (m, 3H), 7.29–7.27 (m, 3H), 5.09 (d, 1H, $J=8.0$ Hz), 4.77 (dd, 1H, $J=5.5, 7.0$ Hz), 4.54 (q, 1H, $J=7.0$ Hz), 2.95 (dd, 1H, $J=7.5, 16.5$ Hz), 2.55 (dd, 1H, $J=5.5, 16.5$ Hz), 1.52 (d, 3H, $J=7.0$ Hz). ^{13}C NMR (125 MHz, CDCl_3): 188.8, 151.6, 148.5, 141.8, 139.3, 132.7, 130.2, 129.0, 128.5, 127.1, 123.1, 121.8, 99.9, 61.4, 58.8, 43.2, 18.3. FTIR: 1637.9 cm^{-1} . $[\alpha]_{\text{D}}^{24}$: –69.2. HRMS MCl^- : expected: 357.1011 found: 357.1017.

3.3.17. (2*R*)-2,3-Dihydro-*N*-(*S*)- α -methylbenzyl-2-(2,4-dinitrophenyl)-4-pyridone (10e).

Isolated as an oil. ^1H NMR (500 MHz, CDCl_3): 8.74 (d, 1H, $J=2.5$ Hz), 8.32 (dd, 1H, $J=2.5, 9.0$ Hz), 7.92 (d, 1H, $J=8.5$ Hz), 7.44 (dd, 1H, $J=1.0, 7.5$ Hz), 7.36–7.29 (m, 3H), 7.20–7.19 (m, 2H), 5.48 (dd, 1H, $J=2.5, 9.0$ Hz), 5.12 (dd, 1H, $J=1.0, 8.0$ Hz), 4.54 (q, 1H, $J=7.0$ Hz), 3.13 (dd, 1H, $J=9.0, 17.0$ Hz), 2.43 (dd, 1H, $J=2.5, 17.0$ Hz), 1.54 (d, 3H, $J=7.0$ Hz). ^{13}C NMR (125 MHz, CDCl_3): 180.1, 151.4, 147.4, 147.3, 141.9, 138.9, 130.5, 129.2, 128.8, 127.2, 126.8, 120.7, 99.4, 63.2, 53.9, 41.3, 18.9. FTIR: 1637.8 cm^{-1} . $[\alpha]_{\text{D}}^{24}$: –195.0. HRMS MH^+ : expected: 368.1241 found: 368.1232.

Acknowledgements

We gratefully acknowledge financial support from the National Institutes of Health (CA 99995-1) and the Robert A. Welch Foundation (D-1361).

References and notes

- (a) Rubiralta, M.; Giralt, E.; Diez, A. *Piperidine: Structure, Preparation and Synthetic Applications of Piperidine and its Derivatives*; Elsevier: Amsterdam, 1991. (b) Bailey, P. D.; Millwood, P. A.; Smith, P. D. *Chem. Commun.* **1998**, 633. (c) Kobayashi, S.; Komiyama, S.; Ishitani, H. *Chem. Rev.* **1999**, 99, 1069.
- (a) Kerwin, J. F.; Danishefsky, S. *Tetrahedron Lett.* **1982**, 23, 3739. (b) Hattori, K.; Yamamoto, H. *Tetrahedron* **1993**, 49, 1749. (c) Creswell, M. W.; Bolton, G. L.; Hodges, J. C.; Meppen, M. *Tetrahedron* **1998**, 54, 3983. (d) Yuan, Y.; Li, X.; Ding, K. *Org. Lett.* **2002**, 4, 3309. (e) Loncaric, C.; Manabe, K.; Kobayashi, S. *Chem. Commun.* **2003**, 574. (f) Mancheno, O. G.; Arrayas, R. G.; Carretero, J. C. *J. Am. Chem. Soc.* **2004**, 126, 456. (g) Shi, M.; Cui, S.-C.; Li, Q.-J. *Tetrahedron* **2004**, 60, 6163.
- (a) Huang, S.; Comins, D. L. *Chem. Commun.* **2000**, 569. (b) Kuethe, J. T.; Comins, D. L. *Org. Lett.* **2000**, 2, 855. (c) Comins, D. L.; Huang, S.; McArdle, C. L.; Ingalls, C. L. *Org. Lett.* **2001**, 3, 469.
- (a) Shintani, R.; Tokunaga, N.; Doi, H.; Hayashi, T. *J. Am. Chem. Soc.* **2004**, 126, 6240. (b) Sebesta, R.; Pizzuti, M. G.; Boersma, A. J.; Minnaard, A. J.; Feringa, B. L. *Chem. Commun.* **2005**, 1711. (c) Jagt, R. B. C.; de Vries, J. G.; Feringa, B. L.; Minnaard, A. J. *Org. Lett.* **2005**, 7, 2433.
- (a) Wei, H.-X.; Kim, S. H.; Li, G. *Org. Lett.* **2002**, 4, 3691. (b) Wei, H.-X.; Timmons, C.; Garag, M. A.; Pare, P. W.; Li, G. *Org. Biomol. Chem.* **2004**, 2, 2893.
- (a) Timmons, C.; Chen, D.; Cannon, J. F.; Headley, A. D.; Li, G. *Org. Lett.* **2004**, 6, 2075. (b) Timmons, C.; Guo, L.; Liu, J.; Cannon, J. F.; Li, G. *J. Org. Chem.*, **2005**, 70, 76–84.
- Reactions of this type are known to frequently require stoichiometric loadings of Lewis acid promoter. See Ref. 1c.
- Imines were prepared under standard conditions by mixing aldehyde, amine, and MgSO₄ in benzene. See Ref. 2b and references therein.
- (a) Kunz, H.; Pfrenge, W. *Angew. Chem., Int. Ed.* **1989**, 28, 1067. (b) Midland, M. M.; Koops, R. W. *J. Org. Chem.* **1992**, 57, 1158.
- (a) Larsen, S. D.; Greico, P. A. *J. Am. Chem. Soc.* **1985**, 107, 1768. (b) Waldmann, H. *Synlett* **1995**, 133.
- Devine, P. N.; Reilly, M.; Oh, T. *Tetrahedron Lett.* **1993**, 34, 5827.
- The absolute structure was determined by comparison with a known compound. See Ref. 2b.

New bioactive cyclic peroxides from the Caribbean marine sponge *Plakortis zyggompha*

Fabrice Berrué,^a Olivier P. Thomas,^a Corinne Funel-Le Bon,^a Fernando Reyes^b
and Philippe Amadé^{a,*}

^aLaboratoire de Chimie Bioorganique, UMR 6001 CNRS, Université de Nice - Sophia Antipolis, Faculté des Sciences, Parc Valrose, 06108 Nice Cedex 02, France

^bPharmaMar S.A., Medicinal Chemistry Department, Poligono Industrial La Mina, Avenida de los Reyes, 1, 28770 Colmenar Viejo, Madrid, Spain

Received 3 August 2005; accepted 20 September 2005

Available online 25 October 2005

Abstract—The new plakortide Q (**1**) has been isolated from the little studied marine sponge *Plakortis zyggompha*, together with the six new cyclic peroxide analogues **2–7** in their methyl ester forms **2a–7a**. Their structure was fully elucidated through NMR and MS analyses and the relative stereochemistry of the 1,2-dioxane ring was established after interpretation of the coupling constant values and the NOESY data. The carboxylic acid function of these compounds was proved to be very reactive and methylation was found to take place during the purification process. The non-esterified peroxides exhibited more cytotoxic activity against human tumor cell lines than their corresponding methyl esters.

© 2005 Elsevier Ltd. All rights reserved.

1. Introduction

Marine sponges of the genus *Plakortis* (Homosclerophorida: Plakinidae) were proven to be a prolific source of secondary metabolites with a large structural diversity.¹ Among them, compounds with a polyketide origin are the most frequently encountered. Cyclic peroxides, which are examples of bioactive polyketides found in various *Plakortis* sp.,^{2–4} are of great interest because they often exhibit a wide spectrum of biological activities including antiparasitic and antitumoral properties.^{5–7}

In recent years, our research has focused on the isolation of cytotoxic molecules from marine sources.^{8,9} In this context, we turned our attention to the rare species *Plakortis zyggompha* collected off the Martinique island, whose extracts showed significant cytotoxic activities.¹⁰ In a previous paper, we reported the isolation from this sponge of three new spiculoic acids, polyketides possessing a rare bicyclic spiculane skeleton.¹¹ Because these mildly cytotoxic metabolites could not be responsible for the high activity of the crude extract, deeper investigation was

carried out on the bioactive fractions. We describe here the isolation and the structure elucidation of seven new polyketide-derived cyclic peroxides: plakortide Q (**1**), 14-nor-plakortide Q (**2**), 11,12-didehydroplakortide Q (**3**), 11,12-didehydro-14-nor-plakortide Q (**4**), 11,12-didehydro-16-nor-plakortide Q (**5**), 14,16-dinor-plakortide Q (**6**), and 14,18-dinor-plakortide Q (**7**). The characterization of compounds **2–7** was accomplished on their methyl ester forms **2a–7a** for purification reasons. All seven compounds were assayed for antitumoral activity against three human tumor cell lines and they proved to be responsible for the bioactivity of the crude extract.

2. Results and discussion

The sponge *P. zyggompha* (de Laubenfels, 1934) was collected using scuba diving in a cave near the ‘Rocher du Diamant’ in the south of the Martinique island in 2002. The specimen with a characteristic intense blue colour was immediately frozen, then extracted with a MeOH/CH₂Cl₂ 1:1 mixture to give a brown gum after evaporation. The crude extract was partitioned between H₂O and CH₂Cl₂, and the CH₂Cl₂ layer was fractionated by a silica gel chromatography using a gradient from *n*-hexane to MeOH. Fifteen fractions were obtained and half of the

Keywords: Marine sponge; *Plakortis*; Peroxides; Antitumoral.

* Corresponding author. Tel.: +33 492076584; fax: +33 492076151; e-mail: amade@unice.fr

bioactive fraction 7 was chromatographed on a C₁₈ reversed-phase HPLC column to afford the pure compound **1**, a mixture of the compounds **2–3**, as well as a mixture of the compounds **4–7** (Fig. 1), roughly identified by ESIMS and NMR.

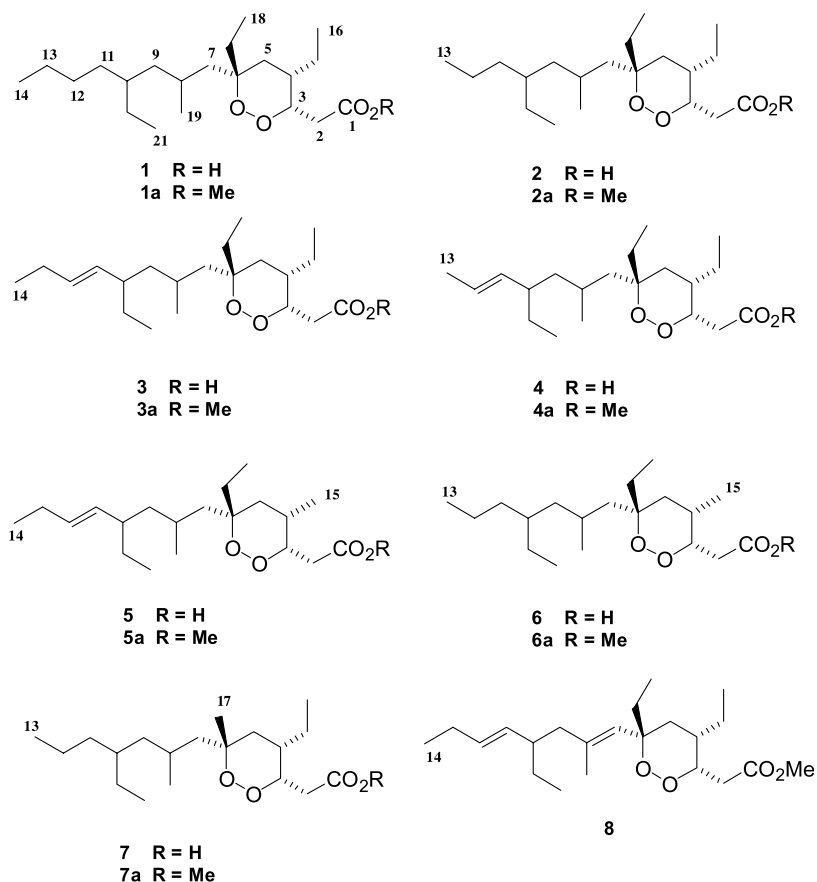

decreased the lipophilicity just enough to compensate the gain of a methylene unit compared to **2a**, **6a**, and **7a**, respectively. Taking into account this observation, distinct lipophilic interactions with the stationary phase were necessary to hope clean separations. We anticipated that a

Because of peak tailings in RP-HPLC attributed to the presence of carboxylic acid functions, the mixtures of compounds **2–3** and **4–7** were esterified separately with the safe reagent TMSCHN₂. After total methylation, the corresponding peaks sharpened significantly in our HPLC conditions but the separation of the compounds **2a–7a** was still not efficient for their purification. The peaks corresponding to the pairs of compounds **2a–3a** and **4a–7a** were not resolved enough and we concluded that the presence of an unsaturation in compounds **3a**, **4a**, and **5a**,

phenyl bonded phase would create some π – π interactions with the unsaturation of compounds **3a**, **4a**, and **5a**, inducing a higher retention time in HPLC. The purification of the mixtures on the corresponding semi preparative HPLC column was realized and the three pairs of compounds **2a/3a**, **4a/6a**, and **5a/7a**, were thus separated as expected (Fig. 2). Unfortunately, the chain isomers **4a/5a** and **6a/7a**, that do have the same degree of unsaturation, were not discriminated on the phenyl bonded HPLC column and both pairs were obtained as 5:1 mixtures. Nevertheless, the four

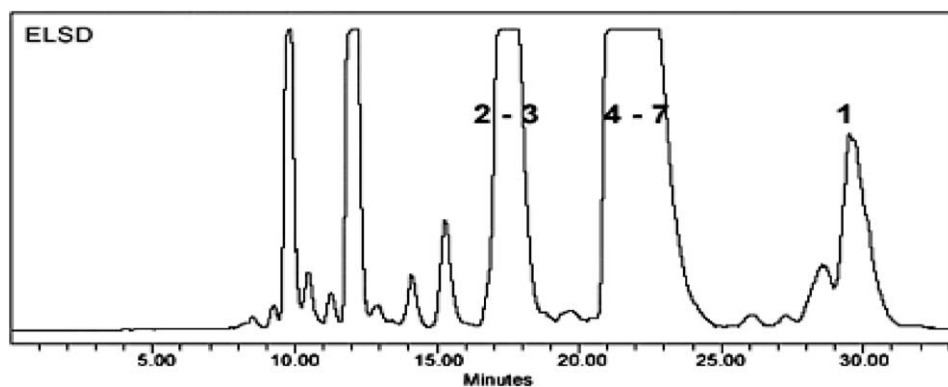

Figure 1. ELSD chromatogram of fraction 7. Column: symmetry C18, 5 μ m, 7.5 \times 300 mm; elution: isocratic CH₃CN/water 85:15, 2.5 mL/min.

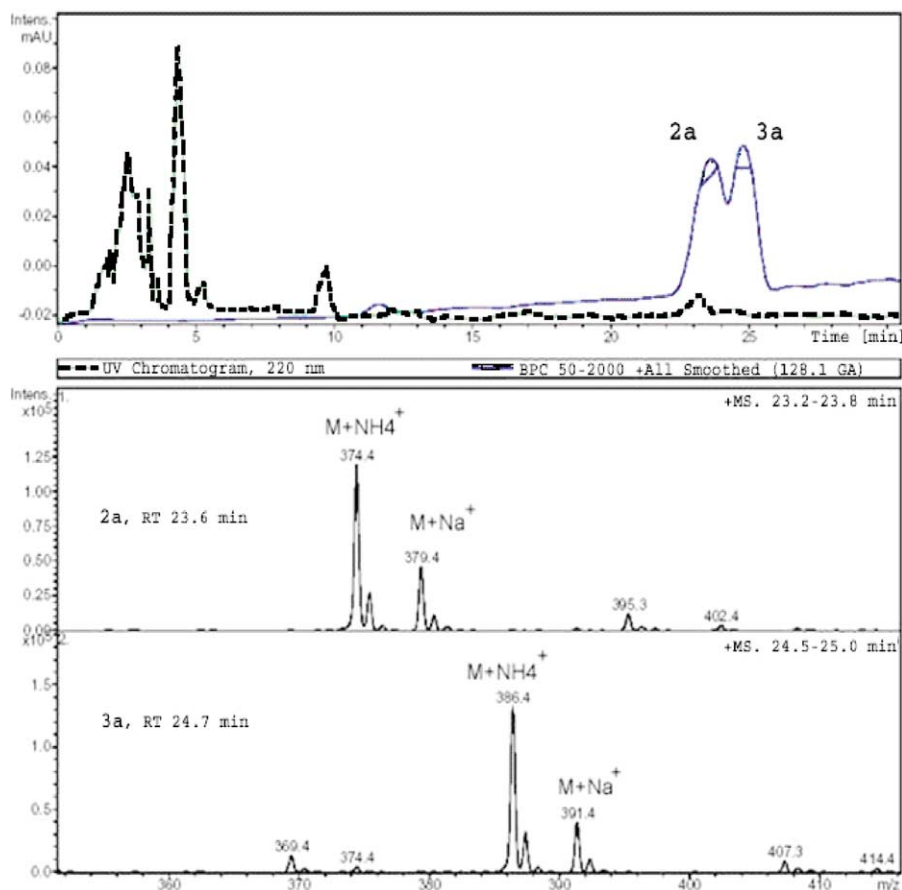

Figure 2. LC–MS traces of compounds 2a/3a. HPLC conditions: Luna phenylhexyl column, 3 μm , 4.6 \times 150 mm; isocratic $\text{CH}_3\text{CN}/\text{water}$ 70:30, 1 mL/min.

new compounds **4a–7a** were properly characterized by NMR studies.

Compound **1** was obtained as a colourless oil, $[\alpha]_{\text{D}}^{22} - 143$ (c 0.1, CHCl_3). Its molecular formula was determined as $\text{C}_{21}\text{H}_{40}\text{O}_4$ by HRESIMS (m/z 379.2808 $[\text{M}+\text{Na}]^+$, 379.2818 calcd for $\text{C}_{21}\text{H}_{40}\text{O}_4\text{Na}$) and required two degrees

of unsaturation. The first unsaturation was attributed to a carboxylic acid group because of the characteristic bands in the IR spectrum (3434 and 1714 cm^{-1}) and the resonance at δ_{C} 176.7 in the ^{13}C NMR spectrum (Table 1). The presence of two oxygen bearing carbons was evidenced by the signals at δ_{C} 78.4 (C-3) and 83.7 (C-6), and the downshielded proton at δ_{H} 4.46 (H-3). To fulfil the number of unsaturation

Table 1. ^1H and ^{13}C NMR data of plakortide Q (**1**) in CDCl_3

Position	^{13}C	^1H	COSY ^a	HMBC (C \rightarrow H) ^a	NOESY ^a
1	176.7	—		3; 2a,b	
2	31.6	3.05dd (15.7, 9.5); 2.43dd (15.7, 3.4)	2b; 3 2a; 3	3; 4	5b; 15a
3	78.4	4.46ddd (9.6, 4.5, 3.5)	2a,b; 4	2a,b; 4; 5a,b; 15a,b	4; 16
4	34.5	2.18m	3; 5a,b; 15a,b	3; 2a; 5a,b; 15a,b; 16	3; 17a; 5a; 16
5	33.1	1.53dd (13.4, 4.5); 1.37dd (13.4, 12.5)	5b; 4 5a; 4	3; 4; 15a; 17a,b; 7a,b	7a; 16; 4 15a
6	83.7	—		5a,b; 7a,b; 17a,b; 18; 8	
7	44.6	1.39dd (15.7, 2.4); 1.21m	7b; 8 7a; 8	3; 17a,b; 8; 9a,b; 19	5a; 8
8	25.7	1.64m	7a,b; 9a,b; 19	7a,b; 9a,b; 10; 19	7a
9	43.5	1.14m; 1.03m	9b; 8, 10 9a; 8; 10	8, 7a,b; 10; 20	7a 8; 19
10	36.4	1.25m	9a,b	9a,b; 20; 21	
11	32.7	1.22m		9a,b; 13	
12	28.7	1.25m		13; 14	
13	23.3	1.27m	14	12; 14	
14	14.3	0.89t (7.2)	13	12; 13	
15	25.3	1.22m; 1.13m	16; 4 16; 4	5a,b; 4; 16	2b
16	11.0	0.92t (7.3)	15a,b	4; 15a,b	3; 4; 5a
17	26.0	2.06dq (14.4, 7.2); 1.56dq (14.4, 7.2)	17b; 18 17a; 18	7a,b; 18	4
18	7.8	0.87t (7.5)	17a,b	17a,b; 5b	
19	22.3	0.91d (6.5)	8	7a,b; 8; 9a,b	9b
20	26.6	1.29m; 1.23m	21 21	9a,b; 21	
21	11.1	0.83t (7.0)	20a,b	20; 10	

^a Ha is the lower-field proton in a geminal pair and Hb is the higher-field proton.

the presence of a cyclic peroxide ring was assumed. Further inspection of the NMR spectra suggested that compound **1** was indeed closely related to the plakortide family and the assignments of the 1,2-dioxane ring, mostly based on the COSY data, showed very close similarities with plakortide **8**.¹²

The ethyl group at C-4 was unambiguously assigned by the key COSY correlations H-3/H-4, H-4/H₂-15, and H₂-15/H-16. A second ethyl group was placed at the quaternary carbon C-6 on the basis of the HMBC correlations C-6/H₂-17 (δ_{H} 2.06 and 1.56) and C-6/H₃-18 (δ_{H} 0.87). The structure of the saturated aliphatic side-chain starting from the quaternary carbon C-6 was determined from selected HMBC and COSY data. HMBC correlations from C-6 allowed the assignments of the signals at δ_{H} 1.39 (dd, H-7a), 1.21 (m, H-7b), and 1.64 (m, H-8). The key COSY correlation H-8/H₃-19 showed the presence of a methyl group at C-8, and the key HMBC correlations C-10/H₂-20 (δ_{H} 1.29 and 1.23) and C-10/H₃-21 (δ_{H} 0.83) indicated the presence of an ethyl group at the methine C-10 (δ_{C} 36.4). The length of the terminal chain was determined starting from the remaining methyl CH₃-14 (δ_{H} 0.89, δ_{C} 14.3) after interpretation of the HMBC correlations C-13/H₃-14, C-12/H₃-14, C-11/H₂-13, and C-11/H₂-9. Comparison of the NMR data of the aliphatic chain with those of other cyclic peroxides revealed a high level of similarities with one of the peroxides isolated from *P. angulospiculatus*,¹³ and fitted with the proposed structure **1**.

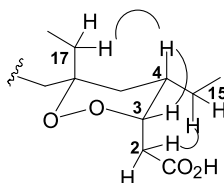

Figure 3. Key NOESY correlations of plakortide **Q** (**1**).

Table 2. ¹³C NMR data of compounds **2a–7a** in CDCl₃

Position	2a	3a	4a	5a	6a	7a
1	172.4	172.4	172.4	172.4	172.4	172.4
2	31.6	31.6	31.6	31.8	31.9	31.6
3	78.6	78.5	78.5	79.5	79.5	78.8
4	34.6	34.6	34.6	27.5	27.5	35.0
5	33.1	33.0	32.9	35.1	35.2	35.3
6	83.5	83.7	83.7	83.6	83.4	81.4
7	44.6	45.0	45.0	44.9	44.5	49.0
8	25.7	25.6	25.6	25.6	25.7	25.9
9	43.6	44.7	44.7	44.7	43.6	43.3
10	36.2	42.6	42.7	42.6	36.2	36.2
11	35.5	133.4	135.8	133.5	35.5	35.5
12	19.6	132.5	125.0	132.5	19.6	19.7
13	14.7	25.9	18.1	25.9	14.7	14.7
14	—	14.4	—	14.4	—	—
15	25.4	25.4	25.4	17.5	17.5	25.3
16	11.0	11.2	11.2	—	—	11.2
17	26.0	25.8	25.9	25.8	26.1	21.9
18	7.9	8.0	8.0	8.0	8.0	—
19	22.4	21.5	21.6	21.5	22.4	22.5
20	26.6	29.1	29.1	29.1	26.6	26.5
21	11.2	12.0	12.0	12.0	11.0	11.0
Me	52.0	52.0	52.0	52.0	52.0	52.0

The relative stereochemistry of the 1,2-dioxane ring was obtained on the basis of the coupling constant values and the NOESY data. The coupling constants corresponding to the signals at δ_{H} 1.53 (dd, $J = 13.4, 4.5$ Hz, H-5a) and 1.35 (dd, $J = 13.7, 13.4$ Hz, H-5b) were consistent with an axial position for H-4 (Fig. 3). Consequently, H-3 was placed in an equatorial position due to the value of the coupling constant $J_{\text{H3-3}} = 4.5$ Hz. The key NOE correlation H-2b/H-15a confirmed the cis relative stereochemistry at C-3 and C-4 while the NOE correlation H-4/H-17a induced a trans stereochemistry between the ethyl groups at C-6 and C-4. The stereochemistry was ascertained by comparison with the other plakortides¹⁴ and consequently compound **1** was named plakortide **Q**.

The methyl ester **2a**, $[\alpha]_{\text{D}}^{22} - 128$ (c 0.1, CHCl₃), was obtained as a colourless oil and the molecular formula C₂₁H₄₀O₄ was established from HRESIMS (m/z 379.2809 [M+Na]⁺, 379.2818 calcd for C₂₁H₄₀O₄Na) and NMR data. The NMR resonances at δ_{H} 3.71, δ_{C} 52.0, and δ_{C} 172.4 (quaternary carbon) evidenced the presence of a methyl ester function. Aside from this difference, the NMR spectra of plakortide **Q** (**1**) and of compound **2a** were very similar (Tables 2 and 3). Both compounds having the same molecular mass and compound **2a** being methyl esterified, one methylene unit lacked in molecule **2a**. Indeed, some modifications were noticeable in the aliphatic chain where C-12 appeared upshielded at δ_{C} 19.6 (δ_{C} 28.7 in **1**), and the key COSY correlation H₂-12/H₃-13 confirmed the loss of the methylene unit at the end of the chain.

The methyl ester **3a**, $[\alpha]_{\text{D}}^{22} - 123$ (c 0.1, CHCl₃), was obtained as a colourless oil and the molecular formula C₂₂H₄₀O₄ was established from HRESIMS (m/z 391.2825 [M+Na]⁺, 391.2818 calcd for C₂₂H₄₀O₄Na) and ¹³C NMR data. The additional unsaturation was easily located at C-11/C-12 on the basis of the key COSY correlations H-10/H-11, H-11/H-12, H-11/H₂-13, and H₂-13/H₃-14.

The chain isomers **4a** and **5a** were obtained as an inseparable mixture in the quantitative ratio 5:1, respectively. Their

Table 3. ¹H NMR data of compounds **2a–7a** in CDCl₃

Position	2a	3a	4a	5a	6a	7a
2	3.01dd (15.2, 9.1); 2.37dd (15.3, 3.5)	3.01dd (15.7, 9.3); 2.37dd (15.7, 3.6)	3.01dd (15.7, 9.4); 2.37dd (15.6, 3.7)	2.97dd (15.7, 8.9); 2.44dd (15.7, 4.4)	2.98dd (15.7, 8.9); 2.46dd (15.7, 4.3)	3.01dd (15.2, 9.0); 2.38dd (15.2, 3.7)
3	4.48ddd (9.1, 4.9, 3.7)	4.48ddd (9.3, 5.2, 3.7)	4.48ddd (9.3, 5.0, 3.8)	4.42ddd (9.0, 4.9, 4.0)	4.43ddd (9.2, 4.8, 4.0)	4.50ddd (9.0, 5.0, 3.7)
4	2.17m	2.15m	2.15m	2.38m	2.41m	2.19m
5	1.52dd (13.4, 4.3); 1.35dd (13.4, 13.0)	1.50dd (13.4, 4.3); 1.32dd (13.4, 13.0)	1.50dd (13.6, 4.4); 1.32m	1.45dd (13.4, 4.6); 1.36m	1.46m; 1.38m	1.48m; 1.38m
7	1.38t (14.6); 1.21m	1.34m; 1.24m	1.34dd (14.0, 2.4); 1.21dd (14.2, 6.9)	1.34m; 1.24m	1.38m; 1.21m	1.40m; 1.27m
8	1.64m	1.63m	1.62m	1.64m	1.64m	1.64m
9	1.14dt (13.6, 6.7); 1.04ddd (13.6, 7.9, 4.9)	1.23m; 1.09ddd (13.4, 9.8, 4.0)	1.25m; 1.08ddd (13.1, 9.7, 4.0)	1.23m; 1.08m	1.14dt (13.4, 6.6); 1.04ddd (13.5, 8.1, 5.0)	1.13m; 1.05m
10	1.26m	1.84m	1.84m	1.83m	1.27m	1.27m
11	1.19m	5.03ddt (15.3, 9.1, 1.3)	5.06ddd (15.4, 9.1, 1.4)	5.41dd (15.2, 9.0)	1.20m	1.20m
12	1.27m	5.41dt (15.2, 6.3)	5.37dq (15.3, 6.4)	5.03dd (15.0, 6.5)	1.28m	1.28m
13	0.88t (7.6)	2.01m	1.67dd (6.5, 1.2)	2.01m	0.87t (7.2)	0.89m
14		0.97t (7.5)		0.97t (7.3)		
15	1.20m; 1.15m	1.21m; 1.15m	1.20m; 1.15m	0.85d (6.9)	0.86d (7.0)	1.22m; 1.15m
16	0.92t (7.3)	0.92t (7.4)	0.92t (7.4)			0.93m
17	2.04dq (14.6, 7.3); 1.58dq (14.6, 7.3)	2.02m; 1.59dq (14. 3, 7.3)	2.00dq (14.6, 7.4); 1.60dq (14.4, 7.3)	2.02dq (14.3, 7.3); 1.59m	2.05dq (14.6, 7.2); 1.57dq (14.5, 7.3)	1.38 s
18	0.87t (7.9)	0.84t (7.5)	0.84t (7.2)	0.84t (7.5)	0.87t (7.6)	
19	0.91d (7.1)	0.87d (6.7)	0.87d (6.8)	0.87d (6.8)	0.91d (6.7)	0.91m
20	1.27m; 1.21m	1.31m; 1.18m	1.30m; 1.17m	1.26m	1.26m; 1.22m	1.28m; 1.23m
21	0.83t (6.8)	0.82t (7.4)	0.82t (7.3)	0.83t (7.0)	0.83t (7.1)	0.83m
Me	3.71s	3.70s	3.71s	3.71s	3.71s	3.71s

molecular formula C₂₁H₃₈O₄ was established from HRE-SIMS (*m/z* 377.2648 [M+Na]⁺, 377.2662 calcd for C₂₁H₃₈O₄Na) and ¹³C NMR data. Comparing the ¹H and ¹³C NMR spectra (Tables 2 and 3) the major isomer **4a** showed strong similarities with compound **3a**. Because the olefinic proton H-12 appeared as a doublet of quadruplet at δ_H 5.37 in the ¹H NMR spectrum of **4a**, the aliphatic side-chain lacked one methylene unit at its end. In the NMR spectra of the minor compound **5a**, clear differences appeared for the signals attributed to the 1,2-dioxane ring. The key COSY correlation between H-4 and a second methyl doublet at δ_H 0.85 (H₃-15) evidenced the replacement of the ethyl group at C-4 in **3a** and **4a**, by a methyl group in **5a**. The upshifting of the C-4 resonance from δ_C 34.6 in **2a**, **3a**, and **4a**, to δ_C 27.5 in **5a** corroborated this substitution. Further NMR data showed that the aliphatic side-chain of compound **5a** and **3a** were identical. Consequently, compound **5a** was the C-4 epimer of one of the cyclic peroxides isolated by Fontana et al.¹⁵

The chain isomers **6a** and **7a** were obtained as an inseparable mixture in the quantitative ratio 5:1, respectively. Their molecular formula C₂₀H₃₈O₄ was established from HRESIMS (*m/z* 365.2651 [M+Na]⁺, 365.2662 calcd for C₂₀H₃₈O₄Na) and ¹³C NMR data. The NMR data corresponding to the 1,2-dioxane ring of compounds **5a** and **6a** appeared closely related (Tables 2 and 3). In particular, the doublet at δ_H 0.86 (H₃-15) and the methine at δ_C 27.5 (C-4) were consistent with the presence of a methyl substituent at C-4. Strong similarities between the NMR spectra of the compounds **2a**, **6a**, and **7a**, implied that they have the same side-chain. Clear differences appeared for the signals of the 1,2-dioxane ring of compound **7a**. The resonance at δ_C 35.0 (C-4) was characteristic of an ethyl substituent at C-4 and the resonances corresponding to C-6

(δ_C 81.4) and C-17 (δ_C 21.9) were upshielded in comparison with all other compounds **2a–6a** (δ_{C-6} near 83.5 and δ_{C-17} near 26.0). The substitution of the ethyl group in **6a** (δ_H 2.05, dq, H-17a; 1.57, dq, H-17b; 0.87, t, H₃-18) by a methyl group in **7a** (δ_H 1.38, s, H₃-17) was evidenced in the ¹H NMR spectrum and confirmed by the strong C-6/H₃-17 HMBC correlation. These chemical shifts were very similar to those of plakortin, the first cyclic peroxide isolated from a *Plakortia* sp.¹⁶ This analogy supported the structure of compound **7a**.

The relative stereochemistry of all new compounds **2a–7a** was proven to be the same as plakortide Q (**1**) as evidenced by the key NOEs observed for **1** also found in the NOESY spectra of compounds **2a–7a**. Consequently, an empiric rule emerged from the ¹³C NMR examination of all similar 1,2-dioxane ring described in the literature. The acetic acid substituent at C-3 occupies an equatorial or an axial position when C-2 resonates above δ_C 36 or below 32 ppm, respectively. In the same way, the ethyl substituent at C-6 has an equatorial or an axial position when C-17 resonates above δ_C 30 or below 27 ppm, respectively. In all cases, the ethyl substituent at C-4 occupies an equatorial position with a methylene C-15 resonating near δ_C 25 ppm and no axial position for this substituent was found in the literature. A misinterpretation of the NMR data could explain the exception to this rule found for the substituent at C-3 in plakortide L.^{4,17}

Amazingly, the LC–MS study of the other half of the bioactive fraction 7, stored one year in MeOH, showed the presence of the methyl ester forms of the seven compounds **1–7** previously characterized. This demonstrated unambiguously that the methyl esters appeared during the storage and they were not natural secondary metabolites of the sponge.

Table 4. Cytotoxic activity of plakortide Q derivatives

Cell line (IC ₅₀ μM)	1	1a	2a	3a	2/3^a	4a/5a^b	6a/7a^b
MDA-MB-231	9.0	18.4	24.4	4.1	4.6	28.9	> 30
A549	3.6	7.8	14.0	6.8	4.0	23.6	> 30
HT29	3.9	13.0	12.3	12.8	1.9	27.2	> 30

^a Mixture 1:1.^b Mixture 5:1.

We could then wonder about the natural origin of the esterified plakortides F, K, M, and N.^{4,10}

After the first isolation of a plakortide acid from *P. zyggompha*,¹⁸ this is the second report of cyclic peroxides from this little studied species. The new plakortides show a similar pattern for their aliphatic side-chain as they all possess a methyl at C-8 and an ethyl at C-10. Interestingly, the cyclic peroxides **2**, **4**, **6**, and **7**, represent the first compounds of this series with an aliphatic chain ending at C-13, suggesting that their polyketide biogenetic pathway includes more propionate units than other species of this genus. It is worthwhile that the isolated compounds possess the same relative stereochemistry, indicating a unique biosynthetic pathway for all these compounds, which may have different precursors as substrate. We have also emphasized the great care that must be taken about the natural origin of the ester derived compounds of this family.

The acid carboxylic forms **1** and **2/3** appeared more cytotoxic (IC₅₀ 2 to 9 μM) than the corresponding methyl esters **1a** and **2a** (Table 4). However, the bioactivity of **3a** was comparable to that of **1**, and probably to **2** (supposed from **2a**). As the mixture **2/3** (1:1 ratio) was twice more active than **1**, we assumed that **3** would have an activity close to 1 μM. This family of plakortides was probably responsible for the bioactivity of the crude extract of *P. zyggompha*. The new plakortide Q (**1**) was interestingly cytotoxic against the two human tumor cell lines A549 and HT29 (IC₅₀ 3.6 and 3.9 μM, respectively).

3. Experimental

3.1. General experimental procedure

Optical rotations were measured in CHCl₃ on a Jasco P-1020 polarimeter. IR spectra were recorded on a Perkin-Elmer Paragon 1000 FT-IR spectrophotometer. NMR experiments were performed on a Bruker DRX 500, using standard Bruker program. Chemical shifts were reported in ppm using residual CDCl₃ (δ 7.26 for ¹H and 77.16 for ¹³C) as internal reference. EIMS were recorded on a VG AutoSpec spectrometer, ESIMS were performed on a Bruker Esquire 3000 Plus spectrometer, and HRESIMS on an API QSTAR Applied Biosystems. HPLC-MS analyses (Fig. 2) were realized by using an Alliance HPLC system Waters with a Luna phenylhexyl analytical column (3 μm, 4.6 × 150 mm, CH₃CN/H₂O 70:30, 1 mL/min) coupled to the MS Bruker Esquire 3000. HPLC purifications were carried out on a Waters equipment with a 600 E pump, an Autoinjector 417, and 996 photodiode array detector

coupled with a SEDEX 55 evaporative light scattering detector (ELSD).

3.2. Collection, extraction and isolation

The sponge *P. zyggompha* (de Laubenfels, 1936) was collected by hand by scuba diving in July 2002 in a cave at a depth of 20 m, near the ‘Rocher du Diamant’ (14°26′060 N, 61°02′040 W) in the south of the Martinique island. The specimen with a characteristic intense azul colour was immediately frozen. The material was identified by Dr. Iosune Uriz (Blanes, Spain) and a voucher specimen (ORMA008545) has been deposited at the company PharmaMar S.A. The frozen sample of *P. zyggompha* (170 g) was extracted with a mixture of MeOH/CH₂Cl₂ 1:1 to give after evaporation 10 g of a brown gum. The extract was partitioned between H₂O and CH₂Cl₂, and the CH₂Cl₂ layer (3 g residue) was subjected to silica gel chromatography using a gradient from hexane to MeOH to afford 15 fractions. Half of the fraction 7 (286 mg) was further purified by HPLC on a symmetryprep C₁₈ semi preparative column (7 μm, 7.5 × 300 mm, CH₃CN/H₂O 85:15) to yield plakortide Q (**1**, 7.2 mg, 4.2 × 10⁻³% wet wt), the pair of compounds **2/3** (45 mg), and the mixture of compounds **4–7** (5 mg). After esterification with TMSCHN₂ (see after), the pair of compounds **2a/3a** was separated by HPLC on a Luna phenylhexyl semi preparative column (5 μm, 10 × 250 mm, CH₃CN/H₂O 70:30) to yield **2a** (37.1 mg, 22 × 10⁻³% wet wt) and **3a** (3.3 mg, 1.9 × 10⁻³% wet wt). The mixture **4a–7a** was purified on the same HPLC column (CH₃CN/H₂O 65:35) to yield the pairs of compounds **4a/5a** (2.2 mg, 1.3 × 10⁻³% wet wt) and **6a/7a** (1.4 mg, 0.8 × 10⁻³% wet wt).

3.2.1. Plakortide Q (1). Colourless oil; [α]_D²² – 143 (c 0.1, CHCl₃), IR ν cm⁻¹: 3438, 2960, 2930, 2874, 1714, 1462, 1380, ¹H and ¹³C data recorded in CDCl₃: see Table 1; HRESIMS *m/z* 379.2808 [M+Na]⁺ (379.2818 calcd for C₂₁H₄₀O₄Na).

3.2.2. 14-Nor-plakortide Q methyl ester (2a). Colourless oil; [α]_D²² – 128 (c 0.1, CHCl₃), IR ν cm⁻¹: 2959, 2931, 2873, 1740, 1461, 1435, 1379, 1360, ¹H and ¹³C data recorded in CDCl₃: see Tables 2 and 3; HRESIMS *m/z* 379.2809 [M+Na]⁺ (379.2818 calcd for C₂₁H₄₀O₄Na).

3.2.3. 11,12-Didehydroplakortide Q methyl ester (3a). Colourless oil; [α]_D²² – 123 (c 0.1, CHCl₃), IR ν cm⁻¹: 2960, 2931, 2874, 1742, 1461, 1436, 1379, 1360, ¹H and ¹³C data recorded in CDCl₃: see Tables 2 and 3; HRESIMS *m/z* 391.2825 [M+Na]⁺ (391.2818 calcd for C₂₂H₄₀O₄Na).

3.2.4. 11,12-Didehydro-14-norplakortide Q methyl ester (4a). In a 5:1 mixture with 11,12-didehydro-16-norplakortide Q methyl ester (5a). Colourless oil; ^1H and ^{13}C data recorded in CDCl_3 ; see Tables 2 and 3; HRESIMS m/z 377.2648 $[\text{M} + \text{Na}]^+$ (377.2662 calcd for $\text{C}_{21}\text{H}_{38}\text{O}_4\text{Na}$).

3.2.5. 14,16-Dinorplakortide Q methyl ester (6a). In a 5:1 mixture with 14,18-dinorplakortide Q methyl ester (7a). Colourless oil; ^1H and ^{13}C data recorded in CDCl_3 ; see Tables 2 and 3; HRESIMS m/z 365.2651 $[\text{M} + \text{Na}]^+$ (365.2662 calcd for $\text{C}_{20}\text{H}_{38}\text{O}_4\text{Na}$).

3.3. Methylation of the mixture of compounds 2 and 3

A solution of compounds 2 and 3 (1:1 ratio, 16 mg) in toluene/MeOH 1:1 (1 mL) was carefully treated with an excess of trimethylsilyldiazomethane (TMSCHN_2 , 100 μL , 2.0 M in *n*-hexane) under a N_2 atmosphere. After stirring at room temperature (1 h) the reaction was quenched with acetic acid (200 μL). The subsequent evaporation of the reaction mixture under vacuum led to the pure compounds 2a and 3a (1:1 ratio, 18 mg) later separated by HPLC (see above).

3.4. Methylation of the mixture of compounds 4–7

Following the same procedure, compounds 4–7 (5 mg) were methyl-esterified to afford the mixture of compounds 4a–7a (6 mg) later partially separated by HPLC (see above).

3.5. Biological activity

A colorimetric assay using sulforhodamine B has been adapted for a quantitative measurement of cell growth and viability following the technique described in the literature.¹⁹ The in vitro activity of the compounds was evaluated against 3 human tumor cell lines, including lung carcinoma A549, colon carcinoma HT29 and breast MDA-MB-231.

Acknowledgements

We are grateful to PharmaMar Madrid for biological screenings and for financial support also provided by a grant (FB) of the R gion Provence-Alpes-C te d'Azur. We also thank I. Uriz for the sponge taxonomy determination and M. Gaysinski for assistance in recording the NMR experiments. We also wish to thank Mr. le Pr f t de la

Martinique et la DIREN for help in collecting the marine sponge.

References and notes

- Rahm, F.; Hayes, P. Y.; Kitching, W. *Heterocycles* **2004**, *64*, 523–575.
- Holzwarth, M.; Trendel, J.-M.; Albrecht, P.; Maier, A.; Michaelis, W. *J. Nat. Prod.* **2005**, *68*, 759–761.
- Jim nez, M. S.; Garz n, S. P.; Rodr guez, A. D. *J. Nat. Prod.* **2003**, *66*, 655–661.
- Hu, J.-F.; Gao, H.-F.; Kelly, M.; Hamann, M. T. *Tetrahedron* **2001**, *57*, 9379–9383.
- Compagnone, R. S.; Pina, I.; Rangel, H. R.; Dagger, F.; Suarez, A. I.; Rami Reddy, M. V.; Faulkner, D. J. *Tetrahedron* **1998**, *54*, 3057–3068.
- Casteel, D. A. *Nat. Prod. Rep.* **1999**, *16*, 55–73.
- Fattorusso, E.; Parapini, S.; Campagnuolo, C.; Basilico, N.; Tagliatalata-Scafati, O.; Taramelli, D. *J. Antimicrob. Chemother.* **2002**, *50*, 883–888.
- Carletti, I.; Long, C.; Funel, C.; Amade, P. *J. Nat. Prod.* **2003**, *66*, 25–29.
- Funel, C.; Berru , F.; Roussakis, C.; Fern ndez, R.; Amade, P. *J. Nat. Prod.* **2004**, *67*, 491–494.
- Faulkner, D. J.; Ravi, B. N. *Tetrahedron Lett.* **1981**, *21*, 23–26.
- Berru , F.; Thomas, O. P.; Fern ndez, R.; Amade, P. *J. Nat. Prod.* **2005**, *68*, 547–549.
- Patil, A. D.; Freyer, A. J.; Carte, B.; Jonson, R. K.; Lahouratate, P. *J. Nat. Prod.* **1996**, *59*, 219–223.
- Gunasekera, S. P.; Gunasekera, M.; Gunawardana, G. P.; McCarthy, P.; Burres, N. *J. Nat. Prod.* **1990**, *53*, 669–674.
- Jim nez, M. S.; Garz n, S. P.; Rodr guez, A. D. *J. Nat. Prod.* **2003**, *66*, 1404.
- Fontana, A.; Ishibashi, M.; Shigemori, H.; Kobayashi, J. *J. Nat. Prod.* **1998**, *61*, 1427–1429.
- Higgs, M. D.; Faulkner, D. J. *J. Org. Chem.* **1978**, *43*, 3454–3456.
- Hu, J.-F.; Gao, H.-F.; Kelly, M.; Hamann, M. T. *Tetrahedron* **2002**, *58*, 1233.
- Phillipson, D. W.; Rinehart, K. L. *J. Am. Chem. Soc.* **1983**, *105*, 7735–7736.
- Shehan, P.; Storeng, R.; Scudiero, D.; Monks, A.; McMahon, J.; Vistica, D.; Warren, J. T.; Bokesch, H.; Kenney, S.; Boyd, M. R. *J. Natl. Cancer Inst.* **1990**, *82*, 1107–1112.



Synthetic studies on nucleoside-type muraymycins antibiotics based on the use of sulfur ylides. Synthesis of bioactive 5'-epimuraymycin analogues

Francisco Sarabia* and Laura Martín-Ortiz

Department of Biochemistry, Molecular Biology and Organic Chemistry, Faculty of Sciences, University of Malaga, 29071 Malaga, Spain

Received 25 July 2005; revised 19 September 2005; accepted 20 September 2005

Available online 25 October 2005

Abstract—A new synthetic approach to the 5'-epimers of muraymycins, a family of complex nucleoside-type antibiotics, is reported based on the synthesis of epoxy amides obtained via the reaction of sulfur ylides with the uridyl aldehyde derivatives **16**, **29** and **30**, followed by a subsequent oxirane ring opening reaction with diamines. This new strategy offers an excellent opportunity for the preparation of muraymycin analogues of biological interest. In fact, biological studies have revealed these 5'-epimers to be as biologically potent as the natural antibiotics, aside of representing a convergent and flexible route towards the natural congeners.

© 2005 Elsevier Ltd. All rights reserved.

1. Introduction

The search and discovery of new antibiotics with novel mechanisms of action is of great importance in chemical, biological and clinical circles due to the growing appearance of drug resistant bacterial strains.¹ Among these new antibiotics, the group composed of the uridyl lipopeptide antibiotics,² that include mureidomycins,³ pacidamycins,⁴ napsamycins,⁵ liposidomycins,⁶ FR-900493⁷ and caprazamycins,⁸ are of special interest due to their intriguing mechanism of action, characterized by the inhibition of the phospho-*N*-acetyl-muramoyl-pentapeptide-transferase (MraY),⁹ also known as translocase I, an enzyme responsible for the biosynthesis of the cell-wall of bacteria. Recently, the muraymycins,¹⁰ another group of nucleoside-lipopeptide antibiotics, have been discovered, isolated and recognized as inhibitors of MraY, displaying *in vitro* and *in vivo* activities against Gram-positive bacteria comparable to liposidomycin C and mureidomycin A.¹¹ Coupled with their prominent biological properties, the muraymycins reveal an attractive molecular architecture, characterized by an unusual nucleotide disaccharide and an unprecedented peptidic chain. So far, 19 different members of the muraymycins have been isolated and identified, among which the selected compounds **1–5** are depicted in Figure 1.¹² The various muraymycin compounds differ in

the amino sugar (group R²) or in the lipidic side chain contained in one of the amino acid residues (group R¹).

Recent synthetic studies of the muraymycins have demonstrated that truncated derivatives, in which, the 5'-amino ribose sugar moiety and the lipophilic side chain were removed, and, in addition, the cyclic arginine amino acid residue was replaced by arginine, were as active as the natural congeners against Gram positive bacteria. Moreover, the authors demonstrated that the 5'-epimer derivatives **7–12** (Fig. 2) showed a biological activity comparable to the natural congeners.¹³ In this synthetic study, the construction of the muraymycin structural core was efficiently accomplished by an aldolic reaction between the lithium enolate of dibenzylglycine *tert*-butyl ester and the uridyl-5' aldehyde **16**.¹⁴ Other synthetic contributions to this family of antibiotics include semisynthesis of analogues¹⁵ and the preparation of the unusual cyclic guanidine amino acid residue,¹⁶ named capreomycin, which is present not only in the muraymycins, but also in other natural products such as the capreomycin-type antibiotics.¹⁷

Recently, we reported a stereoselective synthetic approach to liposidomycin antibiotics based on the use of sulfur ylides.¹⁸ According to this methodology, epoxy amide **13** was efficiently prepared and transformed into the diazepanone derivative **14** through an indole epoxy amide intermediate, obtained by oxidation of the indoline ring with DDQ,¹⁹ followed by treatment with diamines (strategy a). In contrast, the reaction of epoxy amide **13** with diamines would provide the corresponding amino alcohols **15** in

Keywords: Muraymycins; Complex nucleoside antibiotics; Epoxy amides; Sulfur ylides.

* Corresponding author. Tel.: +34 952 134258; fax: +34 952 131941; e-mail: frsarabia@uma.es

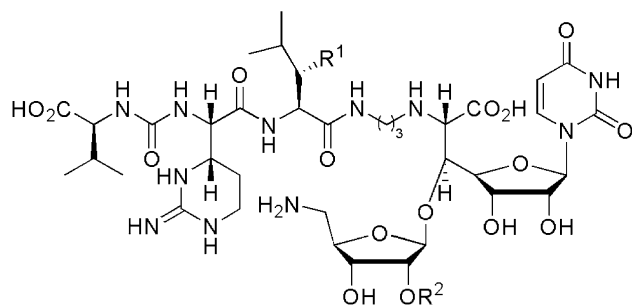

Muraymycins:

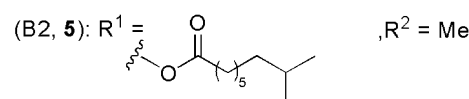
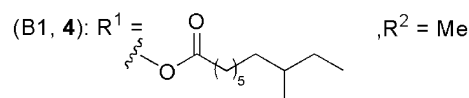
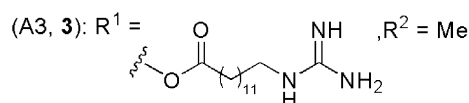
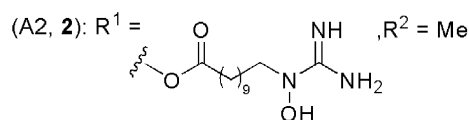
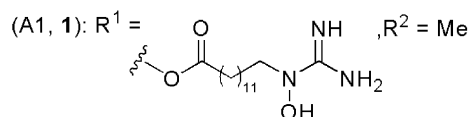
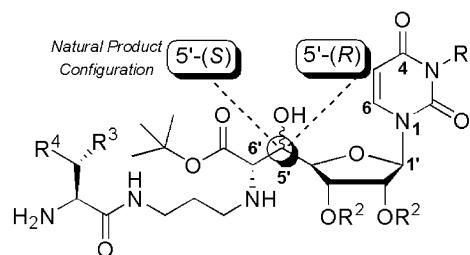

Figure 1. Molecular structures of muraymycins A1, A2, A3, B1 and B2.

a regioselective manner,²⁰ as a straightforward and convergent approach towards either the 5'-epimers of muraymycins or the natural members, requiring in this case, an epimerization process at this position (strategy b) (Scheme 1). Furthermore, this synthetic strategy has the potential of delivering further structural variations, allowing entry into a variety of muraymycin analogues via modifications of the amine nucleophile, which is introduced in the oxirane ring opening step.

2. Results and discussion

These synthetic studies were initiated with the reaction of epoxy amide **13** (Scheme 2), readily prepared by condensation of aldehyde **16** with the sulfur ylide, in situ generated from sulfonium salt **17**,¹⁸ with different nitrogen nucleophiles including sodium azide, allylamine, and various diamines such as *N*-Z-1,3-propanediamine,²¹ which furnished the corresponding oxirane ring opening products **15a–j** in good to excellent yields (62–96%) and complete regioselectivity, with the exception of reaction with *N*-methyl-1,3-propanodiamine, in which a 1:1 unseparable mixture of isomers **15f** and **15f'** was obtained in a combined



Muraymycin	R ¹	R ²	R ³	R ⁴	IC ₅₀ ^a	MIC ^b
5'-(S) Natural Product Configuration						
A1 (1)					---	1-16
(6)	PMB	TBS	OH	Me	10.7	8-128
5'-(R) 5'-Epimer						
(7)	PMB	TBS	OH	Me	32.0	4-8
(8)	PMB	TBS	OH	<i>i</i> -Pr	---	4-16
(9)	PMB	TBS	H	<i>i</i> -Pr	---	4-64
(10)	PMB	TBS	H	H	---	4-8
(11)	H	TBS	H	<i>i</i> -Pr	---	1-2
(12)	H	H	H	<i>i</i> -Pr	---	>128

^aIC₅₀ values (μg/mL) in the soluble peptidoglycan assay (SPG).

^bMIC (Minimal inhibitory concentration) (μg/mL): In vitro activity against various Gram-positive microorganisms.

Figure 2. Molecular structures of representative muraymycins analogues and antibiotics properties.

75% yield (see Table 1 for details). With the objective of designing a synthetic route capable of reaching so the natural muraymycins as the bioactive 5'-epimer derivatives, we proceeded with the construction of the peptidyl chain linkage. To this aim, we focused on the product **15h**, prepared directly by reaction of **13** with 1,3-propanediamine, or by the *Z*-cleavage²² of the opening product **15c**, which contained the requisite diamine present in the natural muraymycins. Thus, the coupling of **15h** with the amino acid derivative Cbz-Leu-OH²³ was accomplished by the action of the coupling reagent EDCI/HOBT²⁴ that afforded compound **18**. Having incorporated the *L*-leucine residue, the access to bioactive muraymycin analogues as depicted in Figure 2, required the transformation of the indoline amide to the corresponding ester, for which the oxidation to the indole derivative was attempted. Unfortunately, this oxidation did not yield the desired product, resulting in either decomposition products, when DDQ was used, or the recovery of starting material when milder oxidation conditions were used by the action of chloroanil²⁵ (Scheme 2). On the other hand, the cleavage of the Cbz group was efficiently accomplished, by the action of hydrogen, to obtain amine **19** in good yield (70%). In order to give access to unprotected derivatives, the PMB deprotection constituted a key step. Thus, treatment of amide **19** with CAN,²⁶ however, failed in the formation of the desired unprotected derivative. In contrast, the acetal cleavage mediated by the action of trifluoroacetic acid in

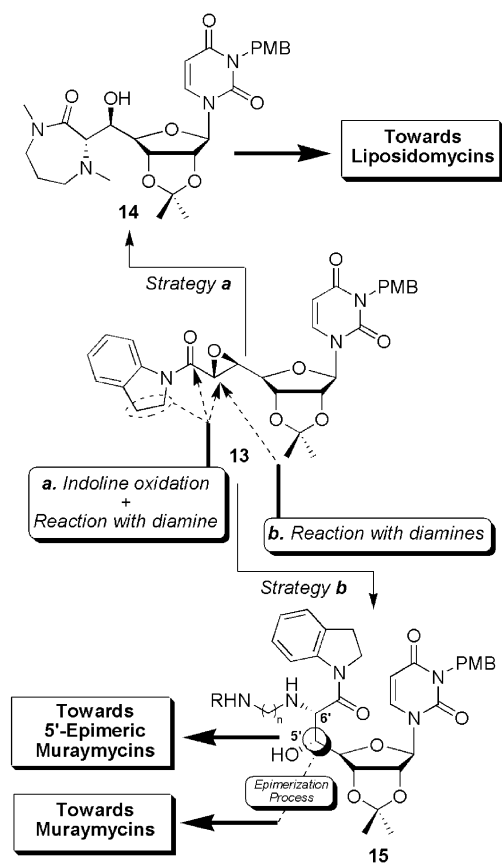

Scheme 1. Synthetic strategy towards the liposidomycin and the muraymycin antibiotics.

the presence of H₂O proved to be efficient to give triol derivative **20** in form of its ammonium salt.

With respect to the indoline amide oxidation, these fruitless, although not surprising,²⁷ results forced us to adopt a second strategy, initiated with the DDQ oxidation of the indoline epoxy amide **13** that provided indole epoxy amide **21** in a 76% yield (Scheme 3).¹⁸ Having secured the formation of the indole amide, we proceeded with the reaction of **21** with *N,N*-dimethyl amine providing the corresponding *N,N*-dimethyl amide **22** (66%) together with its *N,N*-dimethyl-amino oxirane ring opening product in a 19% yield. On the other hand, the preparation of bulky esters, such as the isopropyl ester **24**, was not possible in a straightforward manner from indole epoxy amide **21**, requiring an additional transesterification step, from its corresponding methyl ester **23** intermediate, by the catalytic action of di-*n*-butyltin oxide.²⁸ The oxirane ring opening process with *N-Z*-1,3-propanediamine of epoxy amide **22** afforded amino alcohol **25** albeit in a modest 33% yield after a long reaction time (8 days at reflux). Taking into account that steric hindrance of the *N-Z*-1,3-propanediamine could justify the required long reaction time for completion, which might promote secondary processes, we decided to carry out these reactions with 1,3-propanediamine. In fact, compounds **22** and **24** smoothly reacted with this diamine in 48 h, although with different results for each case. Thus, for epoxy amide **22**, the desired product **26** was cleanly obtained, according to its ¹H NMR spectra, not requiring further purification, in contrast to the reaction of epoxy ester **24** that yielded a complex

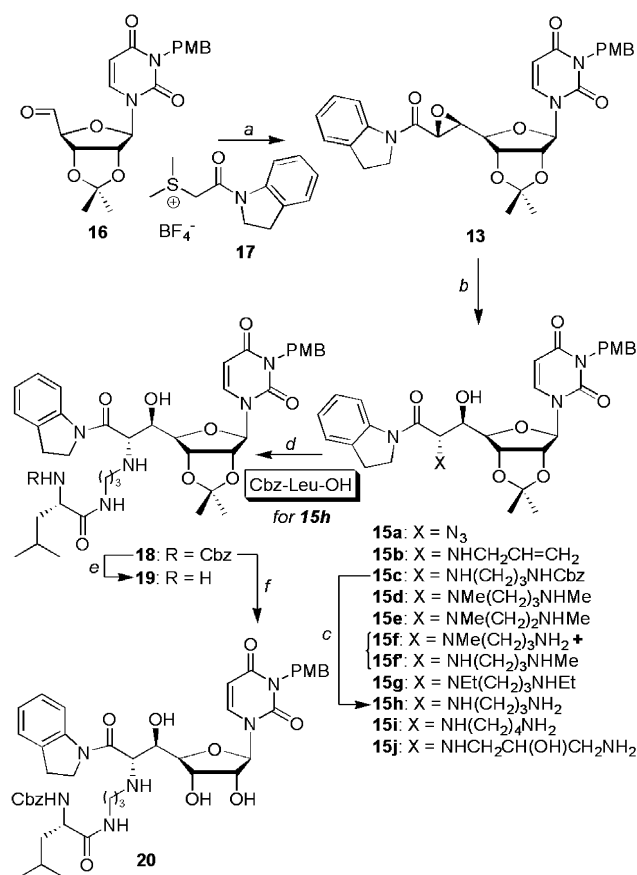

Scheme 2. Reagents and conditions: (a) 1.1 equiv **17**, 1.1 equiv 20% NaOH, CH₂Cl₂/H₂O, 0 °C, 2.5 h, 78%; (b) See Table 1 for conditions and yields; (c) 5.5 equiv NH₄⁺HCOO⁻, Pd-C, MeOH, reflux, 2 h, 65%; (d) 1.0 equiv **15h**, 1.2 equiv Cbz-Leu-OH, 1.2 equiv EDCI, 1.2 equiv HOBt, CH₂Cl₂, 25 °C, 2 h, 92%; (e) H₂, Pd-C, MeOH, 25 °C, 0.5 h, 70%; (f) TFA/H₂O, 0 °C, 1.5 h, 75%.

Table 1. Reaction of epoxy amide **13** with nitrogen nucleophiles

Entry	X	Conditions	Yield (%)
1	N ₃	AcOH/DMF, 65 °C, 12 h	15a (65%)
2	NHCH ₂ CH=CH ₂	MeOH, reflux, 12 h	15b (96%)
3	NH(CH ₂) ₃ NHCbz	MeOH, reflux, 4 days	15c (83%)
4	NMe(CH ₂) ₃ NHMe	MeOH, reflux, 24 h	15d (81%)
5	NMe(CH ₂) ₂ NHMe	MeOH, reflux, 24 h	15e (79%)
6	NMe(CH ₂) ₃ NH ₂ + NH(CH ₂) ₃ NHMe	MeOH, reflux, 24 h	15f + 15f' (75%)
7	NEt(CH ₂) ₃ NH ₂	MeOH, reflux, 8 days	15g (66%)
8	NH(CH ₂) ₃ NH ₂	MeOH, reflux, 30 h	15h (73%)
9	NH(CH ₂) ₄ NH ₂	MeOH, reflux, 24 h	15i (62%)
10	NHCH ₂ CH(OH)CH ₂ NH ₂	MeCN, reflux, 24 h	15j (69%)

mixture of products, isolating a 1:1 unseparable mixture of compounds **27a:27b** among them. In the light of these results, we opted to continue with *N,N*-dimethyl amide **26**, which was coupled with the L-leucine amino acid derivative, under similar conditions as described above for compound **18**, to obtain compound **28** in a modest yield (36% overall yield from **22**).

In pursuit of circumventing all the synthetic obstacles associated with the presence of the PMB protecting group and the indoline-type amide and their subsequent cleavages, as it has been described above, we chose aldehydes **29**²⁹

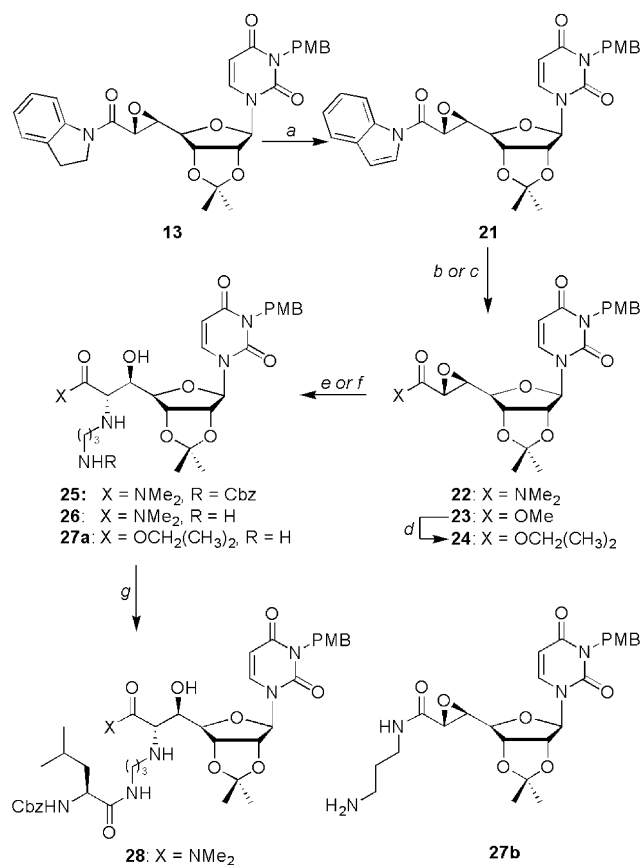

Scheme 3. Reagents and conditions: (a) 5.0 equiv DDQ, C₆H₆, reflux, 24 h, 76%; (b) 1.3 equiv Me₂NH, THF, 25 °C, 5 h, 66% of **22**, plus a 19% yield of the *N,N*-dimethylamino opening product; (c) 1.0 equiv Et₃N, MeOH, 25 °C, 0.5 h, 99% for **23**; (d) 0.1 equiv *n*Bu₂SnO, *i*PrOH, reflux, 12 h, 67%; (e) 1.0 equiv **22**; 1.4 equiv H₂N(CH₂)₃NHCbz, MeOH, reflux, 8 days, 33% for **25**; (f) 2.0 equiv H₂N(CH₂)₃NH₂, MeOH, reflux, 48 h, no purification required for **26**, complex mixture for reaction of **24**, containing **27a** and **27b**; (g) 1.0 equiv **26**; 1.2 equiv Cbz-Leu-OH, 1.2 equiv EDCI, 1.2 equiv HOBt, CH₂Cl₂, 25 °C, 4 h, 36% from **22**.

and **30**³⁰ as starting points and 1-azido-3-propanoamine³¹ as nucleophile in the subsequent oxirane ring opening reaction of the resulting epoxy amides (Scheme 4). Thus, aldehydes **29** and **30**, prepared from their corresponding alcohols by oxidation with DMP³² and IBX,³³ respectively, were reacted with the sulfur ylide derived from the sulfonium salt **31**, to obtain epoxy amides **32** and **33** according to the one- and two-phases methodologies³⁴ in modest 43 and 61% yields, respectively, and high stereoselectivities. The installation of the 1,3-propanediamine linker, required for the construction of the peptidic chain, was undertaken through the reaction of epoxy amides **32** and **33** with 1-azido-3-propanoamine to obtain azido alcohols **34** and **35** in 48 and 83% yields, respectively. In a similar way, the reaction of **33** with *N*-Z-1,3-propanediamine afforded opening product **36** in a 83% yield. Either from **35** as from **36**, the amine **37** was obtained in very good yields, by treatments with triphenylphosphine or ammonium formate in the presence of palladium. The coupling with the *L*-leucine derivative produced amide **38**, without further difficulties, and was converted into amino alcohol **39** by *Z*-cleavage mediated by hydrogen. This product represents an interesting analogue related to the highly bioactive compound **11** (see Fig. 2). Having failed to oxidize indoline

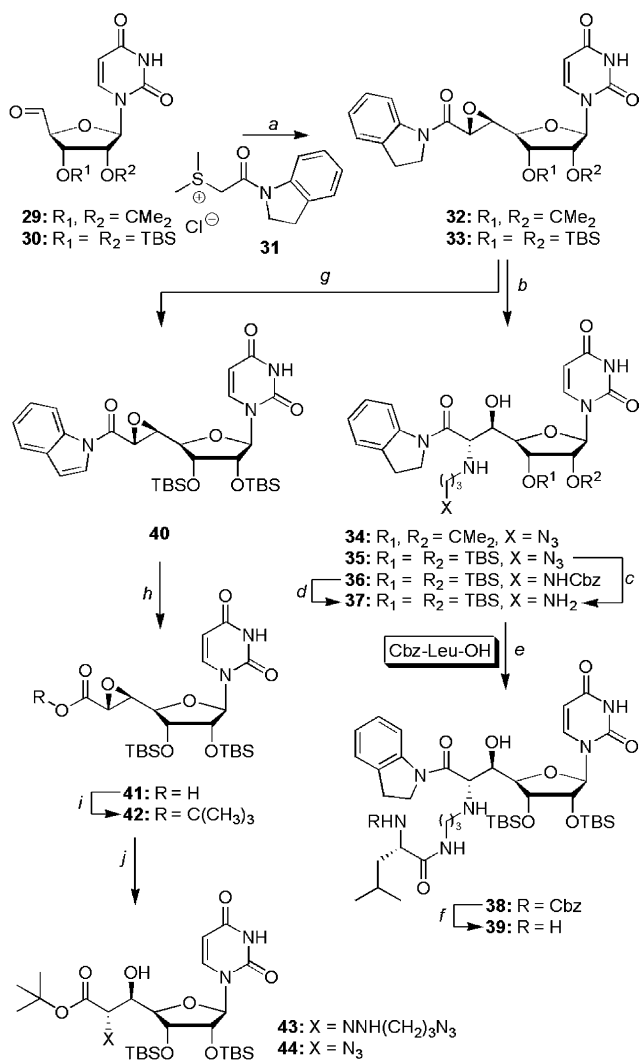

Scheme 4. Reagents and conditions: (a) (i) 1.03 equiv **31**, 3.2 equiv NaH, CH₃CN, 0 °C, 3 h, then addition over a solution of **29**, CH₂Cl₂, 0 °C, 2.5 h, 43% for **32**; (ii) 1.1 equiv **31**, 1.1 equiv 20% NaOH, 1.0 equiv **30**, CH₂Cl₂/H₂O, 0 °C, 1.5 h, 61% for **33**; (b) (i) 1.0 equiv **32** 1-azido-3-propanoamine, MeOH, 70 °C, 72 h, 48% for **34**; (ii) 1.0 equiv **33** 2.1 equiv 1-azido-3-propanoamine, MeOH, 70 °C, 48 h, 83% for **35**; (iii) 1.0 equiv **33** 2.0 equiv 1-*N*-Z-1,3-propanodiamine, MeOH, reflux, 48 h, 83% for **36**. (c) 4.0 equiv Ph₃P, THF, 25 °C, 1 h, then H₂O, 5 h, 75%; (d) Excess of NH₄⁺ HCOO⁻, Pd-C, EtOH, 25 °C, 0.5 h, 72%; (e) 1.0 equiv **37**, 1.3 equiv Cbz-Leu-OH, 1.3 equiv EDCI, 1.3 equiv HOBt, CH₂Cl₂, 25 °C, 6 h, 74%; (f) H₂, Pd-C, MeOH, 25 °C, 0.5 h, 86%; (g) 1.0 equiv **33** 5.0 equiv DDQ, C₆H₆, 80 °C, 24 h, 86%; (h) 2.0 equiv LiOH, THF/H₂O, 0 °C, 20 min, 83%; (i) 2.0 equiv Cl₃CC(=NH)OtBu, CH₂Cl₂, 25 °C, 24 h, 98%; (j) (i) 1.5 equiv 1-azido-3-propanoamine, MeOH, 70 °C, 96 h, 20% for **43**; (ii) 2.0 equiv NaN₃, DMF, 65 °C, 3 h, 83% for **44**.

amides, containing *N*-Z-peptidic residues, to the corresponding indole amides, according to precedent results from our laboratories,²⁷ we then proceeded to investigate the possibility of fulfilling this oxidation from compounds **34** and **35**. However, the DDQ treatments of these indoline amides failed again to produce the desired indole amides, leading instead to a complex mixture of decomposition products. These discouraging results forced us to the accomplishment of such oxidation in earlier steps. Thus, epoxy amide **33** was transformed into the epoxy indole amide **40** by the action of DDQ, followed by basic hydrolysis with LiOH to obtain acid **41**. The formation of

the *tert*-butyl ester **42** was carried out by reaction of **41** with the corresponding *tert*-butyl trichloroacetimidate³⁵ to obtain the *tert*-butyl ester **42** in almost quantitative yield. With this ester in hand, we proceeded with the introduction of the diamine linker by reaction with 1-azido-3-aminopropane, expecting no interferences with the ester function, as it was observed for the isopropyl ester, described above. Unfortunately, this opening reaction proceeded in a low 20% yield in the formation of **43**, in contrast to the reaction of **42** with simple nucleophiles, such as sodium azide, which resulted in the formation of the 2-azido opening product **44** in a 83% yield (Scheme 4).

Despite that the 5'-epimers of truncated muraymycin analogues were as active as the derivatives with the right configuration at this position, we were strongly interested in the preparation of the 5'-(*S*) analogues in case of an eventual total synthesis of the natural congeners. From the *anti* amino alcohol derivative **15c**, we attempted the isomerization at C-5' position by application of different methodologies described in the literature,³⁶ but, unfortunately, all these attempts failed. Finally, according to previous studies in our laboratories concerning with isomerization of *trans* epoxy amides,³⁷ we decided to undertake this epimerization from epoxy amide **33** by conversion to its corresponding *cis* isomer **48**, through bromohydrin intermediate. Thus, *anti* bromohydrin **45**, obtained by treatment of epoxy amide **33** with sodium bromide in the presence of amberlyst-15,³⁸ was subjected to the action of Dess–Martin periodinane to obtain ketone **46**, which was reduced with sodium borohydride to provide *syn* bromohydrin **47**. Finally, exposure of **47** to catalytic amounts of sodium methoxide in methanol afforded *cis* epoxy amide **48** in a 40% yield over four steps from **33**. With the requisite stereochemistry contained in the key precursor **48**, we devised the introduction of the peptidic chain in one step by reaction of epoxy amide **48** with amine **49**. Pleasingly, opening product **50** was obtained in excellent yield when **48** was treated with

amine **49** in refluxing MeOH, despite the long time reaction that was required for almost completion (71% conversion). In a similar way, *trans* epoxy amide **33** was treated with amine **49** to obtain **51** in a 99% yield (79% conversion) (Scheme 5).

3. Conclusions

In conclusion, we have described a new and convergent synthetic approach towards the 5'-epimuraymycins, based on the use of epoxy amides, which are readily prepared by the reaction of aldehydes with stabilized sulfur ylides. An inspection of the structural features present in the muraymycins reveals the intriguing possibility of applying an oxirane ring opening reaction to construct modified 5'-epimuraymycins of biological interest. These preliminary synthetic results are of notable importance for the design of new muraymycin-type antibiotics and for the establishment of an efficient strategy for the eventual total synthesis of these natural complex nucleosides, that required the epimerization at C-5' and the incorporation at this position of the 5'-aminoribose residue contained in these compounds by a glycosylation reaction. Whereas the epimerization at C-5 was successfully achieved via a *trans*-*cis* epoxy amide isomerization, the glycosylation reaction is divided as a much more difficult synthetic task,³⁹ in which we are currently devoting our synthetic efforts.

4. Experimental

4.1. General techniques

All reactions were carried out under an argon atmosphere with dry, freshly distilled solvents under anhydrous conditions, unless otherwise noted. Tetrahydrofuran (THF) and ethyl ether (ether) were distilled from sodium benzophenone, and methylene chloride (CH₂Cl₂), benzene (PhH), and toluene from calcium hydride. Yields refer to chromatographically and spectroscopically (¹H NMR) homogeneous materials, unless otherwise stated. All solutions used in workup procedures were saturated unless otherwise noted. All reagents were purchased at highest commercial quality and used without further purification unless otherwise stated.

All reactions were monitored by thin-layer chromatography carried out on 0.25 mm E. Merck silica gel plates (60F-254) using UV light as visualizing agent and 7% ethanolic phosphomolybdic acid or *p*-anisaldehyde solution and heat as developing agents. E. Merck silica gel (60, particle size 0.040–0.063 mm) was used for flash column chromatography. Preparative thin-layer chromatography (PTLC) separations were carried out on 0.25, 0.50 or 1 mm E. Merck silica gel plates (60F-254).

NMR spectra were recorded on a Bruker Avance-400 instrument and calibrated using residual undeuterated solvent as an internal reference. The following abbreviations were used to explain the multiplicities: s, singlet; d, doublet; t, triplet; q, quartet; m, multiplet; band, several overlapping signals; b, broad. Optical rotations were recorded on a Perkin-Elmer 241 polarimeter. High-resolution mass spectra

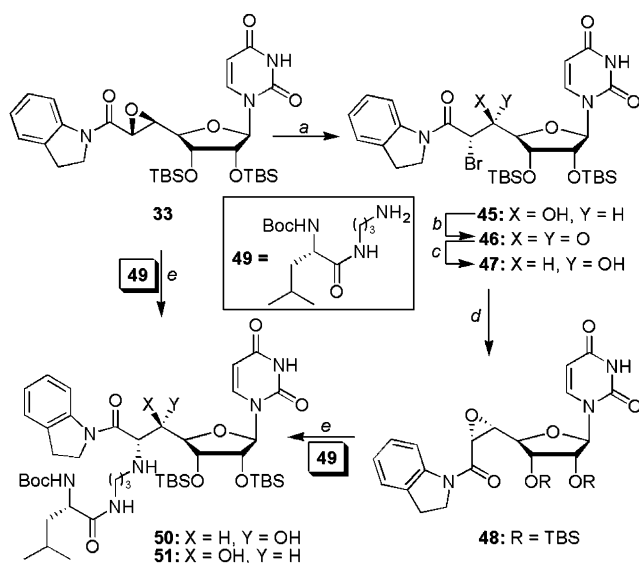

Scheme 5. Reagents and conditions: (a) 4.0 equiv NaBr, Amberlyst-15, acetone, -20°C , 12 h, 99%; (b) 2.0 equiv DMP, CH₂Cl₂, 0°C , 8 h; (c) 1.0 equiv NaBH₄, EtOH, 0°C , 1.25 h, 38% over two steps; (d) 3.0 equiv NaOMe, MeOH, 25°C , 24 h, 99%; (e) 2.0–4.0 equiv **49**, MeOH, 70°C , 4–14 days, 97% for **50** (71% conversion), 99% for **51** (79% conversion).

(HRMS) were recorded on a Kratos MS 80 RFA mass spectrometer under fast atom bombardment (FAB) conditions.

4.2. Opening reactions of epoxy amide **13** with nucleophiles

4.2.1. Azido alcohol 15a. A solution of epoxy amide **13** (0.2 g, 0.356 mmol, 1.0 equiv) in DMF (5 mL) was treated with sodium azide (93 mg, 1.42 mmol, 4.0 equiv) and acetic acid (20 μ L, 0.356 mmol, 1.0 equiv) and the mixture was heated at 65 °C. After stirring for 12 h, the solution was allowed to reach room temperature, diluted with Et₂O (5 mL) and washed with saturated aqueous NH₄Cl solution (5 mL). The aqueous solution was extracted with Et₂O (2 \times 2 mL) and the combined organic phase was washed with brine (4 mL), dried over MgSO₄ and concentrated under reduced pressure. The crude mixture was purified by flash column chromatography (silica gel, 60% EtOAc in hexanes) to provide azido alcohol **15a** (0.14 g, 65%) as a white solid: R_f =0.42 (silica gel, 50% EtOAc in hexanes); $[\alpha]_D^{22}$ -14.3 (c 0.7, CH₂Cl₂); ¹H NMR (400 MHz, CDCl₃) δ 8.14 (d, J =8.6 Hz, 1H, Ar indoline), 7.55 (d, J =8.1 Hz, 1H, H₆), 7.41 (d, J =8.6 Hz, 2H, Ar PMB), 7.12–7.09 (m, 2H, Ar indoline), 7.04 (dd, J =7.5, 7.5 Hz, 1H, Ar indoline), 6.79 (d, J =8.6 Hz, 2H, Ar PMB), 5.94 (d, J =3.8 Hz, 1H, H_{1'}), 5.76 (d, J =8.1 Hz, 1H, H₅), 5.02 (dd, J =5.9, 2.7 Hz, 1H, H_{3'}), 4.99 (d, J =4.3 Hz, 2H, CH₂Ar), 4.83 (dd, J =5.9, 3.8 Hz, 1H, H_{2'}), 4.60 (bs, 1H, OH), 4.53 (bs, 1H, H_{4'}), 4.35 (d, J =9.1 Hz, 1H, H_{5'}), 4.12–4.06 and 4.02–3.95 (2m, 2H, CH₂CH₂N indoline), 3.89 (d, J =9.1 Hz, 1H, H_{6'}), 3.72 (s, 3H, CH₃O), 3.19–3.00 (m, 2H, CH₂CH₂N indoline), 1.60 and 1.35 (2s, 6H, C(CH₃)₂); ¹³C NMR (100 MHz, CDCl₃) δ 166.3, 162.2, 159.1, 151.2, 141.9, 139.5, 131.7, 130.9, 128.6, 127.5, 125.0, 124.8, 117.6, 114.7, 113.6, 102.8, 94.4, 84.1, 83.2, 80.9, 71.4, 60.4, 55.2, 48.1, 43.7, 27.8, 27.3, 25.3; FAB HRMS (NBA): m/e 604.2297, M^+ calcd for C₃₀H₃₂N₆O₈ 604.2281.

4.2.2. *N*-Allylamino alcohol 15b. To a solution of epoxy amide **13** (0.2 g, 0.356 mmol, 1.0 equiv) in MeOH (5 mL) was added allylamine (82 μ L, 1.06 mmol, 3.0 equiv). After stirring for 12 h at 60°, the solution was allowed to warm to 25 °C, and the reaction mixture was diluted with toluene (1.5 mL) and concentrated under reduced pressure. Purification by flash column chromatography (silica gel, 70% EtOAc, 5% MeOH in hexanes) furnished amino alcohol **15b** (212 mg, 96%) as a white solid: R_f =0.66 (silica gel, 60% EtOAc, 5% MeOH in hexanes); $[\alpha]_D^{22}$ +1.8 (c 0.2, CH₂Cl₂); ¹H NMR (400 MHz, CDCl₃) δ 8.14 (d, J =7.5 Hz, 1H, Ar indoline), 7.53 (d, J =8.1 Hz, 1H, H₆), 7.41 (d, J =9.1 Hz, 2H, Ar PMB), 7.15–7.11 (m, 2H, Ar indoline), 7.01 (dd, J =7.0 Hz, 1H, Ar indoline), 6.79 (d, J =9.1 Hz, 2H, Ar PMB), 5.87 (d, J =3.8 Hz, 1H, H_{1'}), 5.82–5.75 (m, 1H, CH₂CH), 5.72 (d, J =8.1 Hz, 1H, H₅), 5.15–4.96 (m, 4H, CH₂Ar, CH₂CH), 4.92 (dd, J =6.4, 3.2 Hz, 1H, H_{3'}), 4.79 (dd, J =6.4, 3.8 Hz, 1H, H_{2'}), 4.60 (d, J =1.6 Hz, 1H, H_{4'}), 4.02–3.97 (m, 2H, CH₂CH₂N indoline), 3.90 (dd, J =8.1, 1.6 Hz, 1H, H_{5'}), 3.73 (s, 3H, CH₃O), 3.62 (d, J =8.1 Hz, 1H, H_{6'}), 3.25 (dd, J =14.0, 5.9 Hz, 1H, CH₂NH), 3.11 (dd, J =14.0, 6.4 Hz, 1H, CH₂NH), 3.07–2.90 (m, 2H, CH₂CH₂N indoline), 1.57 and 1.33 (2s, 6H, C(CH₃)₂); ¹³C NMR (100 MHz, CDCl₃) δ 172.8, 162.3, 159.1, 151.0, 142.2, 139.5, 136.6,

131.7, 130.9, 128.7, 127.3, 124.7, 124.4, 117.3, 116.5, 114.4, 113.7, 102.5, 93.8, 84.9, 83.2, 81.3, 73.2, 60.5, 55.2, 50.4, 48.0, 43.6, 27.7, 27.3, 25.3; FAB HRMS (NBA): m/e 641.2584, $M+Na^+$ calcd for C₃₃H₃₈N₄O₈ 641.2587.

4.2.3. Amino alcohol 15c. A solution of *N*-Z-1,3-diaminopropane hydrochloride (0.16 g, 0.64 mmol, 1.2 equiv) in MeOH (2 mL) was treated with triethylamine (0.15 mL, 1.07 mmol, 2.0 equiv) for 30 min at room temperature. After this time, this solution was added to a solution of epoxy amide **13** (0.3 g, 0.53 mmol, 1.0 equiv) in MeOH (3 mL) and the mixture was heated at reflux for 4 days. Then, the mixture was allowed to reach room temperature and toluene (1.5 mL) was added. The solution was concentrated under reduced pressure and the crude product was purified by flash column chromatography (silica gel, 60% EtOAc, 5% MeOH in hexanes) to provide amino alcohol **15c** (0.34 g, 83%) as a white solid: R_f =0.42 (silica gel, 65% EtOAc, 5% MeOH in hexanes); $[\alpha]_D^{22}$ +36.0 (c 0.1, CH₂Cl₂); ¹H NMR (400 MHz, CDCl₃) δ 8.16 (d, J =8.1 Hz, 1H, Ar indoline), 7.40 (d, J =8.6 Hz, 2H, Ar PMB), 7.34–7.27 (m, 6H, aromatics Cbz, H₆), 7.14–7.10 (m, 2H, Ar indoline), 7.01 (dd, J =7.5, 7.5 Hz, 1H, Ar indoline), 6.78 (d, J =8.6 Hz, 2H, Ar PMB), 5.78 (d, J =3.2 Hz, 1H, H_{1'}), 5.69 (d, J =8.1 Hz, 1H, H₅), 5.36 (m, 1H, NHCBz), 5.09–4.93 (m, 5H, H_{3'}, CH₂ArPMB, CH₂ArCbz), 4.83–4.80 (m, 1H, H_{2'}), 4.57 (bs, 1H, H_{4'}), 4.04–3.98 (m, 2H, CH₂CH₂N indoline), 3.88 (d, J =8.1 Hz, 1H, H_{5'}), 3.72 (s, 3H, CH₃O), 3.61 (d, J =8.1 Hz, 1H, H_{6'}), 3.32–3.18 (m, 2H, CH₂NHCO), 3.01–2.96 (m, 2H, CH₂CH₂N indoline), 2.72–2.66 and 2.47–2.41 (2m, 2H, CH₂NH), 1.60–1.58 (m, 2H, CH₂), 1.55 and 1.31 (2s, 6H, C(CH₃)₂); ¹³C NMR (100 MHz, CDCl₃) δ 172.4, 162.2, 159.0, 156.4, 151.0, 142.3, 139.8, 136.6, 131.9, 131.7, 130.8, 128.5, 128.4, 128.0, 127.3, 124.7, 124.4, 117.3, 114.3, 113.6, 102.4, 94.3, 85.1, 83.1, 81.1, 72.9, 66.4, 61.7, 55.1, 48.1, 45.3, 43.6, 39.1, 29.4, 27.7, 27.2, 25.3; FAB HRMS (NBA): m/e 792.3220, $M+Na^+$ calcd for C₄₁H₄₇N₅O₁₀ 792.3220.

4.2.4. Amino alcohols 15d–j. General procedure. A solution 0.04–0.07 M of epoxy amide **13** (1.0 equiv) in MeOH was treated with the corresponding diamine (1.7–3.0 equiv) with the exception of alcohol **15j**, in which the solvent used was CH₃CN. After stirring for 12–30 h at reflux, the reaction mixture was diluted with toluene and the solvent was concentrated under reduced pressure for obtaining **15d**, **15e**, **15h**, **15i**, **15j** and a mixture 1:1 of **15f** and **15f'**. Particularly complete formation of alcohol **15g** required 8 days.

4.2.4.1. Compound [15d]. Purification by flash column chromatography (silica gel, 60% EtOAc, 5% MeOH in hexanes) provided amino alcohol **15d** (81%) as a yellow oil: R_f =0.56 (silica gel, 70% EtOAc, 5% MeOH in hexanes); $[\alpha]_D^{22}$ +1.8 (c 0.1, CH₂Cl₂); ¹H NMR (400 MHz, CDCl₃) δ 8.12 (d, J =8.2 Hz, 1H, Ar indoline), 7.65 (d, J =8.2 Hz, 1H, H₆), 7.43 (d, J =8.8 Hz, 2H, Ar PMB), 7.16–6.99 (m, 3H, Ar indoline), 6.79 (d, J =8.8 Hz, 2H, Ar PMB), 6.04 (d, J =4.1 Hz, 1H, H_{1'}), 5.71 (d, J =8.2 Hz, 1H, H₅), 5.05–4.90 (m, 3H, H_{3'}, CH₂Ar), 4.69 (dd, J =5.3, 4.1 Hz, 1H, H_{2'}), 4.38 (bs, 1H, H_{4'}), 4.27 (m, 1H, NHCH₃), 4.14–4.06 (m, 1H, CH₂CH₂N indoline), 3.95–3.88 (m, 2H, H_{5'}, CH₂CH₂N indoline), 3.77–3.75 (m, 1H, CH₂), 3.74 (s, 3H, CH₃O), 3.52

(d, $J=8.2$ Hz, 1H, $H_{6'}$), 3.07–2.99 (m, 3H, CH_2CH_2N indoline, CH_2), 2.65–2.52 (m, 2H, CH_2), 2.40 (s, 3H, NCH_3), 2.35–2.30 (m, 1H, CH_2), 1.57 (s, 3H, $NHCH_3$), 1.59 and 1.34 (2s, 6H, $C(CH_3)_2$) 1.30–1.25 (m, 1H, CH_2); ^{13}C NMR (100 MHz, $CDCl_3$) δ 170.4, 162.4, 159.1, 151.2, 142.5, 139.1, 131.6, 131.0, 128.9, 127.4, 124.7, 124.4, 117.4, 114.2, 113.6, 102.6, 92.6, 84.9, 83.6, 81.5, 69.9, 66.3, 55.2, 51.5, 48.2, 43.7, 39.1, 33.9, 30.9, 29.7, 28.0, 27.5, 25.4; FAB HRMS (NBA): m/e 686.3175, $M+Na^+$ calcd for $C_{35}H_{45}N_5O_8$ 686.3166.

4.2.4.2. Compound [15e]. Purification by flash column chromatography (silica gel, 60% EtOAc, 5% MeOH in hexanes) provided alcohol **15e** (79%) as a white solid: $R_f=0.56$ (silica gel, 60% EtOAc, 5% MeOH in hexanes); $[\alpha]_D^{22} -7.6$ (c 0.2, CH_2Cl_2); 1H NMR (400 MHz, $CDCl_3$) δ 8.13 (d, $J=7.6$ Hz, 1H, Ar indoline), 7.63 (d, $J=8.2$ Hz, 1H, H_6), 7.43 (d, $J=8.8$ Hz, 2H, Ar PMB), 7.16–6.94 (m, 3H, Ar indoline), 6.77 (d, $J=8.8$ Hz, 2H, Ar PMB), 5.97 (d, $J=4.1$ Hz, 1H, $H_{1'}$), 5.73 (d, $J=8.2$ Hz, 1H, H_5), 5.03 and 4.93 (2d, $J=13.5$ Hz, 2H, CH_2Ar), 4.90 (dd, $J=5.9$, 2.3 Hz, 1H, $H_{3'}$), 4.68 (dd, $J=5.9$, 4.7 Hz, 1H, $H_{2'}$), 4.42 (bs, 1H, $H_{4'}$), 4.34 (m, 1H, $NHCH_3$), 4.24–4.17 and 3.92–3.85 (2m, 2H, CH_2CH_2N indoline), 3.76–3.70 (m, 3H, CH_2 , $H_{5'}$), 3.73 (s, 3H, CH_3O), 3.51 (d, $J=8.8$ Hz, 1H, $H_{6'}$), 2.97–2.82 (m, 3H, CH_2CH_2N indoline, CH_2), 2.70–2.65 (m, 1H, CH_2), 2.40 (s, 3H, NCH_3), 1.56 (s, 3H, $NHCH_3$), 1.55 and 1.33 (2s, 6H, $C(CH_3)_2$); ^{13}C NMR (100 MHz, $CDCl_3$) δ 170.2, 162.4, 159.1, 151.3, 142.5, 139.1, 131.5, 131.0, 128.9, 127.4, 124.7, 124.4, 117.2, 114.2, 113.6, 102.7, 92.6, 84.7, 83.6, 81.5, 69.6, 66.7, 55.2, 52.9, 47.9, 43.7, 38.6, 29.7, 27.7, 27.4, 27.3, 25.4; FAB HRMS (NBA): m/e 672.3005, $M+Na^+$ calcd for $C_{34}H_{43}N_5O_8$ 672.3009.

4.2.4.3. Compounds [15f] + [15f']. Purification by flash column chromatography (silica gel, 60% EtOAc, 5% MeOH in hexanes) provided an inseparable 1:1 mixture of alcohols **15f and **15f'** (75%) as a colourless oil: $R_f=0.36$ (silica gel, 60% EtOAc, 5% MeOH in hexanes); 1H NMR (400 MHz, $CDCl_3$) δ 8.15 and 8.14 (2d, $J=7.0$ Hz, 2H, Ar indoline), 7.68 (d, $J=8.2$ Hz, 2H, H_6), 7.42 and 7.39 (2d, $J=8.2$ Hz, 4H, Ar PMB), 7.19–7.12 (m, 4H, Ar indoline), 7.05–6.97 (m, 2H, Ar indoline), 6.77 (d, $J=8.2$ Hz, 4H, Ar PMB), 6.08 and 5.78 (2d, $J=4.1$ Hz, 2H, $H_{1'}$), 5.73 and 5.71 (2d, $J=8.2$ Hz, 2H, H_5), 5.06 and 4.87 (m, 6H, $H_{3'}$, CH_2Ar), 4.80 and 4.68 (2dd, $J=6.4$, 4.1 Hz, 2H, $H_{2'}$), 4.47 and 4.37 (2br s, 2H, $H_{4'}$), 4.34–3.84 (m, 6H, $H_{5'}$, CH_2CH_2N indoline), 3.74 and 3.73 (2s, 6H, CH_3O), 3.53 and 3.47 (2d, $J=8.2$ Hz, 2H, $H_{6'}$), 3.02–2.97 (m, 4H, CH_2CH_2N indoline), 3.10–3.04, 2.69–2.66, 2.60–2.54 and 2.35–2.26 (4m, 8H, CH_2), 2.42 (s, 3H, NCH_3), 1.75–1.60 (m, 4H, CH_2), 1.59, 1.54, 1.34, and 1.31 (4s, 2H, $C(CH_3)_2$), 1.23 (s, 3H, $NHCH_3$); FAB HRMS (NBA): m/e 672.3015, $M+Na^+$ calcd for $C_{34}H_{43}N_5O_8$ 672.3009.**

4.2.4.4. Compounds [15g]. Purification by flash column chromatography (silica gel, 80% EtOAc in hexanes) provided alcohol **15g (66%) as a white solid: $R_f=0.65$ (silica gel, 80% EtOAc in hexanes); $[\alpha]_D^{22} +11.6$ (c 0.2, CH_2Cl_2); 1H NMR (400 MHz, $CDCl_3$) δ 8.07 (d, $J=8.2$ Hz, 1H, Ar indoline), 7.76 (d, $J=8.2$ Hz, 1H, H_6), 7.42 (d, $J=8.8$ Hz, 2H, Ar PMB), 7.16–7.10 (m, 2H, Ar indoline), 7.00 (dd, $J=7.6$, 7.6 Hz, 1H, Ar indoline), 6.77 (d, $J=8.8$ Hz, 2H, Ar PMB), 6.11 (d, $J=4.1$ Hz, 1H, $H_{1'}$), 5.71 (d, $J=8.2$ Hz,**

1H, H_5), 5.04 and 4.93 (2d, $J=14.1$ Hz, 2H, CH_2Ar), 4.89 (dd, $J=5.9$, 1.8 Hz, 1H, $H_{3'}$), 4.66 (dd, $J=5.9$, 4.1 Hz, 1H, $H_{2'}$), 4.42 (bs, 1H, $H_{4'}$), 4.25 (d, $J=8.2$ Hz, 1H, $H_{5'}$), 4.12–4.02 and 3.94–3.88 (2m, 2H, CH_2CH_2N indoline), 3.73 (s, 3H, CH_3O), 3.76–3.71 (m, 1H, CH_2), 3.63 (d, $J=8.2$ Hz, 1H, $H_{6'}$), 3.46–3.37 (m, 1H, CH_2), 3.12–2.92 (m, 2H, CH_2CH_2N indoline), 2.79–2.61 (m, 4H, CH_2CH_3), 1.92–1.64 (m, 2H, CH_2), 1.59 and 1.34 (2s, 6H, $C(CH_3)_2$), 1.55–1.46 and 1.14–1.03 (2m, 2H, CH_2), 1.31–1.23 (m, 3H, CH_2CH_3), 0.96 (t, $J=7.0$ Hz, 3H, CH_2CH_3); ^{13}C NMR (100 MHz, $CDCl_3$) δ 171.0, 162.5, 159.1, 151.2, 142.6, 138.8, 131.7, 131.0, 128.9, 127.4, 124.7, 124.3, 114.7, 114.1, 113.6, 102.6, 91.9, 84.7, 84.0, 81.6, 70.1, 64.3, 55.2, 49.2, 48.8, 48.2, 46.8, 43.7, 33.9, 28.5, 28.0, 27.5, 25.6, 25.4, 24.9; FAB HRMS (NBA): m/e 714.3485, $M+Na^+$ calcd for $C_{37}H_{49}N_5O_8$ 714.3479.

4.2.4.5. Compound [15h]. Purification by flash column chromatography (silica gel, 15% MeOH in CH_2Cl_2) provided alcohol **15h (165 mg, 73%) as major product and epoxy amide opening product with NH_3 (45 mg, 22%) as minor product: **[15h]** white solid: $R_f=0.71$ (silica gel, 15% MeOH in CH_2Cl_2); $[\alpha]_D^{22} -9.4$ (c 0.1, CH_2Cl_2); 1H NMR (400 MHz, $CDCl_3$) δ 8.17 (d, $J=8.1$ Hz, 1H, Ar indoline), 7.74 (d, $J=8.1$ Hz, 1H, H_6), 7.42 (d, $J=8.6$ Hz, 2H, Ar PMB), 7.14–7.11 (m, 2H, Ar indoline), 6.99 (dd, $J=7.5$, 7.5 Hz, 1H, Ar indoline), 6.78 (d, $J=8.6$ Hz, 2H, Ar PMB), 5.98 (d, $J=3.8$ Hz, 1H, $H_{1'}$), 5.74 (d, $J=8.1$ Hz, 1H, H_5), 4.98 (2d, $J=13.4$ Hz, 2H, CH_2Ar), 4.89–4.86 (m, 1H, $H_{3'}$), 4.74–4.70 (m, 1H, $H_{2'}$), 4.58 (bs, 1H, $H_{4'}$), 4.12–4.01 (m, 2H, CH_2CH_2N indoline), 3.83 (d, $J=7.0$ Hz, 1H, $H_{5'}$), 3.73 (s, 3H, CH_3O), 3.65 (d, $J=7.0$ Hz, 1H, $H_{6'}$), 3.07–2.99 (m, 2H, CH_2CH_2N indoline), 2.74–2.42 (m, 4H, CH_2), 1.56 and 1.31 (2s, 6H, $C(CH_3)_2$), 1.54–1.49 (m, 2H, CH_2); ^{13}C NMR (100 MHz, $CDCl_3$) δ 172.5, 162.5, 159.1, 151.1, 142.3, 139.6, 131.7, 130.1, 128.7, 127.4, 124.8, 124.6, 117.3, 114.3, 113.6, 102.4, 93.4, 85.0, 83.3, 81.5, 72.6, 61.8, 55.2, 48.2, 45.9, 43.7, 40.2, 31.5, 27.8, 27.3, 25.3; FAB HRMS (NBA): m/e 658.2854, $M+Na^+$ calcd for $C_{33}H_{41}N_5O_8$ 658.2853.**

4.2.4.6. Compound [15i]. Purification by flash column chromatography (silica gel, 80% EtOAc, 10% MeOH in hexanes) provided alcohol **15i (62%) as a colourless oil: $R_f=0.64$ (silica gel, 80% EtOAc, 10% MeOH in hexanes); $[\alpha]_D^{22} +5.7$ (c 0.04, CH_2Cl_2); 1H NMR (400 MHz, $CDCl_3$) δ 8.16 (d, $J=8.2$ Hz, 1H, Ar indoline), 7.49 (d, $J=8.2$ Hz, 1H, H_6), 7.39 (d, $J=8.8$ Hz, 2H, Ar PMB), 7.15–7.12 (m, 2H, Ar indoline), 7.00 (dd, $J=7.0$, 7.0 Hz, 1H, Ar indoline), 6.78 (d, $J=8.2$ Hz, 2H, Ar PMB), 5.83 (d, $J=2.9$ Hz, 1H, $H_{1'}$), 5.74 (d, $J=8.2$ Hz, 1H, H_5), 4.92–4.50 (m, 3H, $H_{3'}$, CH_2Ar), 4.82–4.79 (m, 1H, $H_{2'}$), 4.54 (bs, 1H, H_4), 4.07–3.97 (m, 3H, $H_{5'}$, CH_2CH_2N indoline), 3.74–3.72 (m, 1H, $H_{6'}$), 3.73 (s, 3H, CH_3O), 3.07–3.03 (m, 2H, CH_2CH_2N indoline), 2.64–2.37 (m, 4H, CH_2), 1.59–1.46 (m, 4H, CH_2), 1.55 and 1.31 (2s, 6H, $C(CH_3)_2$); ^{13}C NMR (100 MHz, $CDCl_3$) δ 162.3, 159.1, 151.1, 142.3, 139.8, 131.6, 130.8, 128.6, 127.4, 124.7, 124.5, 117.4, 114.4, 113.7, 102.5, 94.4, 85.0, 82.9, 81.4, 72.7, 61.8, 55.2, 48.2, 47.5, 43.7, 33.9, 29.7, 27.9, 27.7, 27.3, 25.3; FAB HRMS (NBA): m/e 672.3015, $M+Na^+$ calcd for $C_{34}H_{43}N_5O_8$ 672.3009.**

4.2.4.7. Compound [15j]. Purification by flash column chromatography (silica gel, 10% MeOH in CH_2Cl_2)

provided alcohol **15j** (69%) as a colourless oil: $R_f=0.43$ (silica gel, 10% MeOH in CH_2Cl_2); $[\alpha]_D^{22} -6.7$ (c 0.1, CH_2Cl_2); $^1\text{H NMR}$ (400 MHz, CDCl_3) δ 8.17 (d, $J=8.2$ Hz, 1H, Ar indoline), 7.77 and 7.72 (2d, $J=8.2$ Hz, 1H, H_6), 7.41 (d, $J=7.0$ Hz, 2H, Ar PMB), 7.14–7.10 (m, 2H, Ar indoline), 7.01–6.96 (m, 1H, Ar indoline), 6.78 (d, $J=8.8$ Hz, 2H, Ar PMB), 5.97 and 6.00 (2d, $J=3.5$ Hz, 1H, $\text{H}_{1'}$), 5.71 (d, $J=8.2$ Hz, 1H, H_5), 5.03–4.82 (m, 3H, $\text{H}_{3'}$, CH_2Ar), 4.74–4.70 (m, 1H, $\text{H}_{2'}$), 4.60–4.58 (m, 1H, $\text{H}_{4'}$), 4.15–3.96 (m, 2H, $\text{CH}_2\text{CH}_2\text{N}$ indoline), 3.78–3.64 (m, 4H, $\text{H}_{5'}$, $\text{H}_{6'}$, CH_2), 3.71 (s, 3H, CH_3O), 3.09–2.99 (m, 2H, $\text{CH}_2\text{CH}_2\text{N}$ indoline), 2.65–2.46 (m, 3H, CH , CH_2), 1.56 and 1.30 (2s, 6H, $\text{C}(\text{CH}_3)_2$); $^{13}\text{C NMR}$ (100 MHz, CDCl_3) δ 173.0, 162.4, 159.0, 150.1, 142.2, 139.4, 131.8, 130.8, 128.5, 127.3, 124.8, 124.4, 117.1, 114.1, 113.6, 102.2, 92.7, 85.3, 83.7, 81.5, 72.8, 71.1, 62.3, 55.1, 51.2, 48.0, 45.1, 43.6, 33.8, 27.3, 25.3; FAB HRMS (NBA): m/e 674.2810, $M+\text{Na}^+$ calcd for $\text{C}_{33}\text{H}_{41}\text{N}_5\text{O}_9$ 674.2802.

4.3. Amino alcohol 15h Reduction of N-Z-amino alcohol 15c

A solution of amino alcohol **15c** (116 mg, 0.15 mmol, 1.0 equiv) in MeOH (2.0 mL) was treated with 10% Pd–C (11 mg) and ammonium formate (52 mg, 0.82 mmol, 5.5 equiv) under an Ar atmosphere. The reaction mixture was refluxed for 2 h and, then, allowed to reach ambient temperature. The resulting suspension was filtered through a Celite pad, washed with MeOH (2×5 mL), and the organic clear solution was concentrated under reduced pressure. Purification by flash column chromatography (silica gel, 15% MeOH in CH_2Cl_2) provided amino alcohol **15h** (62 mg, 65%).

4.4. Compound 18. Coupling between Cbz-Leu-OH and amino alcohol 15h

Cbz-Leu-OH (0.3 g, 1.13 mmol, 1.2 equiv) was dissolved in dry CH_2Cl_2 (4 mL) and treated with HOBt (0.16 g, 1.13 mmol, 1.2 equiv) at room temperature. After stirring for 5 min, EDCI (0.22 g, 1.13 mmol, 1.2 equiv) was added to the reaction mixture, which was stirred for 45 min, prior to the addition to a solution of **15h** (0.59 g, 0.94 mmol, 1.0 equiv) in CH_2Cl_2 (3 mL). The mixed system was stirred for an additional 1 h 15 min, after which, aqueous 15% NH_3 solution (0.2 mL) was added and the resulting mixture was diluted with Et_2O (5 mL) and washed with a saturated aqueous NH_4Cl solution (5 mL). The layers were separated and the aqueous phase was extracted with Et_2O (2×5 mL). The combined organic solution was dried (MgSO_4), filtered and concentrated. Purification by flash column chromatography (silica gel, 10% MeOH in CH_2Cl_2) afforded peptidic derivative **18** (764 mg, 92%) as a white solid: $R_f=0.41$ (silica gel, 10% MeOH in CH_2Cl_2); $[\alpha]_D^{22} -1.6$ (c 0.9, CH_2Cl_2); $^1\text{H NMR}$ (400 MHz, CDCl_3) δ 8.17 (d, $J=8.1$ Hz, 1H, Ar indoline), 7.50 (d, $J=8.1$ Hz, 1H, H_6), 7.39 (d, $J=8.6$ Hz, 2H, Ar PMB), 7.32–7.27 (m, 5H, aromatics Cbz), 7.14–7.10 (m, 2H, Ar indoline), 7.00 (dd, $J=7.5$, 7.5 Hz, 1H, Ar indoline), 6.78 (d, $J=8.6$ Hz, 2H, Ar PMB), 5.85 (d, $J=3.2$ Hz, 1H, $\text{H}_{1'}$), 5.71 (d, $J=8.1$ Hz, 1H, H_5), 5.46 (bs, 1H, NHCBz), 5.09–4.95 (m, 4H, CH_2ArPMB , CH_2ArCbz), 4.91 (dd, $J=6.4$, 2.7 Hz, 1H, $\text{H}_{3'}$), 4.82 (d, $J=6.4$, 3.2 Hz, 1H, $\text{H}_{2'}$), 4.56 (bs, 1H, $\text{H}_{4'}$), 4.10–4.00 (m, 3H, $\text{CH}_2\text{CH}_2\text{N}$

indoline, $\text{CHCH}_2\text{CH}(\text{CH}_3)_2$), 3.91 (d, $J=7.0$ Hz, 1H, $\text{H}_{5'}$), 3.73 (s, 3H, CH_3O), 3.59 (d, $J=7.0$ Hz, 1H, $\text{H}_{6'}$), 3.40–3.32 and 3.26–3.17 (2m, 2H, CH_2NHCO), 3.08–2.98 (m, 2H, $\text{CH}_2\text{CH}_2\text{N}$ indoline), 2.67–2.57 and 2.46–2.40 (2m, 2H, CH_2NH), 1.63–1.50 (m, 5H, CH_2 , $\text{CHCH}_2\text{CH}(\text{CH}_3)_2$, $\text{CHCH}_2\text{CH}(\text{CH}_3)_2$), 1.56 and 1.31 (2s, 6H, $\text{C}(\text{CH}_3)_2$), 0.87 and 0.85 (2s, 6H, $\text{CH}(\text{CH}_3)_2$); $^{13}\text{C NMR}$ (100 MHz, CDCl_3) δ 172.4, 162.3, 159.1, 156.3, 151.1, 142.2, 139.9, 136.2, 131.6, 130.8, 128.6, 128.5, 128.2, 128.0, 127.5, 126.9, 124.7, 124.6, 117.4, 114.4, 113.6, 102.3, 94.6, 84.7, 82.7, 81.4, 72.6, 66.9, 62.0, 55.2, 53.7, 48.2, 45.0, 43.7, 41.1, 37.0, 28.9, 27.9, 27.3, 25.3, 24.7, 22.8, 22.0; FAB HRMS (NBA): m/e 905.4064, $M+\text{Na}^+$ calcd for $\text{C}_{47}\text{H}_{58}\text{N}_6\text{O}_{11}$ 905.4061.

4.5. Amino alcohol 19. Hydrogenation of compound 18

To a solution of compound **18** (0.12 g, 0.136 mmol, 1.0 equiv) in MeOH (4 mL) was added 10% Pd–C (120 mg). The reaction was allowed to proceed under an atmosphere of H_2 at 25 °C for 30 min. After this time, the mixture was filtered and the filtrate was washed with MeOH (2×5 mL). The combined organic solvents were removed by concentration under reduced pressure and the resulting residue was subjected to purification by flash column chromatography (silica gel, 15% MeOH in CH_2Cl_2) to afford amino alcohol **19** (71 mg, 70%) as a colourless oil: $R_f=0.56$ (silica gel, 10% MeOH in CH_2Cl_2); $[\alpha]_D^{22} +4.0$ (c 0.1, CH_2Cl_2); $^1\text{H NMR}$ (400 MHz, CDCl_3) δ 8.15 (d, $J=7.6$ Hz, 1H, Ar indoline), 7.72 (d, $J=8.1$ Hz, 1H, H_6), 7.40 (d, $J=9.1$ Hz, 2H, Ar PMB), 7.14–7.10 (m, 2H, Ar indoline), 7.00 (dd, $J=7.5$, 7.5 Hz, 1H, Ar indoline), 6.78 (d, $J=9.1$ Hz, 2H, Ar PMB), 5.95 (d, $J=3.8$ Hz, 1H, $\text{H}_{1'}$), 5.72 (d, $J=8.1$ Hz, 1H, H_5), 5.01–4.92 (m, 3H, $\text{H}_{3'}$, $\text{H}_{3'}$, CH_2Ar), 4.75 (dd, $J=4.3$, 3.8 Hz, 1H, $\text{H}_{2'}$), 4.61 (bs, 1H, $\text{H}_{4'}$), 4.09–4.05 (m, 2H, $\text{CH}_2\text{CH}_2\text{N}$ indoline), 3.94 (d, $J=7.5$ Hz, 1H, $\text{H}_{5'}$), 3.73 (s, 3H, CH_3O), 3.74–3.71 (m, 1H, $\text{H}_{6'}$), 3.55–3.48 (m, 1H, $\text{CHCH}_2\text{CH}(\text{CH}_3)_2$), 3.39–3.34 and 3.24–3.16 (2m, 2H, CH_2NHCO), 3.11–3.02 (m, 2H, $\text{CH}_2\text{CH}_2\text{N}$ indoline), 2.72–2.67 and 2.55–2.49 (2m, 2H, CH_2NH), 1.67–1.60 (m, 5H, CH_2 , $\text{CHCH}_2\text{CH}(\text{CH}_3)_2$, $\text{CHCH}_2\text{CH}(\text{CH}_3)_2$), 1.54 and 1.29 (2s, 6H, $\text{C}(\text{CH}_3)_2$), 0.90–0.86 (m, 6H, $\text{CH}(\text{CH}_3)_2$); $^{13}\text{C NMR}$ (100 MHz, CDCl_3) δ 162.4, 159.1, 151.1, 142.2, 139.6, 131.8, 130.8, 128.7, 127.3, 124.8, 124.5, 117.3, 114.2, 113.6, 102.4, 93.2, 84.8, 83.2, 81.6, 72.4, 62.0, 55.2, 53.2, 48.2, 45.6, 43.7, 43.0, 37.1, 29.3, 27.8, 27.3, 25.3, 24.7, 23.1, 21.6; FAB HRMS (NBA): m/e 771.3680, $M+\text{Na}^+$ calcd for $\text{C}_{39}\text{H}_{52}\text{N}_6\text{O}_9$ 771.3693.

4.6. Triol 20

Compound **19** (50 mg, 0.057 mmol, 1.0 equiv) was treated with a solution of TFA/ H_2O 9:1 (1.7 mL) at 0 °C until the reaction was complete as judged by TLC (ca. 1.5 h). The crude mixture was then diluted with toluene and concentrated under reduced pressure. Purification by flash column chromatography (silica gel, 10% MeOH in CH_2Cl_2) provided triol **20** (36 mg, 75%) as a white solid: $R_f=0.40$ (silica gel, 10% MeOH in CH_2Cl_2); $[\alpha]_D^{22} +7.6$ (c 0.3, CH_2Cl_2); $^1\text{H NMR}$ (400 MHz, CDCl_3) δ 8.13 (d, $J=8.1$ Hz, 1H, H_6), 7.73 (d, $J=7.5$ Hz, 1H, Ar indoline), 7.37 (d, $J=8.6$ Hz, 2H, Ar PMB), 7.26–7.22 (m, 5H, aromatics Cbz), 7.13–7.06 (m, 2H, Ar indoline), 6.98 (dd, $J=7.5$, 7.5 Hz,

1H, Ar indoline), 6.75 (d, $J=8.6$ Hz, 2H, Ar PMB), 5.89 (bs, 1H, $H_{1'}$), 5.74 (bs, 1H, $NHCbz$), 5.70 (d, $J=8.1$ Hz, 1H, H_5), 5.05–4.90 (m, 4H, CH_2ArPMB , CH_2ArCbz), 4.41 (bs, 1H, $H_{4'}$), 4.29–3.94 (m, 6H, $H_{2'}$, $H_{3'}$, $H_{5'}$, CH_2CH_2N indoline, $CHCH_2CH(CH_3)_2$), 3.73–3.70 (m, 1H, $H_{6'}$), 3.72 (s, 3H, CH_3O), 3.35–3.28 and 3.19–3.13 (2m, 2H, CH_2-NHCO), 3.05–3.01 (m, 2H, CH_2CH_2N indoline), 2.66–2.58 and 2.47–2.41 (2m, 2H, CH_2NH), 1.62–1.45 (m, 5H, CH_2 , $CHCH_2CH(CH_3)_2$, $CHCH_2CH(CH_3)_2$), 0.89–0.82 (m, 6H, $CH(CH_3)_2$); ^{13}C NMR (100 MHz, $CDCl_3$) δ 172.9, 162.5, 159.0, 156.5, 151.3, 142.1, 138.8, 136.0, 132.0, 130.7, 128.8, 128.5, 128.2, 127.8, 127.4, 124.9, 124.7, 117.3, 113.6, 102.0, 91.2, 84.2, 74.7, 72.2, 70.7, 67.0, 62.0, 55.2, 53.7, 48.2, 44.9, 43.6, 41.0, 37.1, 30.0, 27.8, 24.6, 22.8, 21.9; FAB HRMS (NBA): m/e 865.3752, $M+Na^+$ calcd for $C_{44}H_{54}N_6O_{11}$ 865.3748.

4.7. *N,N*-Dimethyl epoxy amide **22**

A solution of epoxy-indole amide **21**¹⁸ (89 mg, 0.159 mmol, 1.0 equiv) in THF (2 mL) was treated with dimethylamine (26 μ L, 0.207 mmol, 1.3 equiv) and the mixture was stirred at room temperature for 5 h. After this time, the crude mixture was concentrated under reduced pressure. Purification by flash column chromatography (silica gel, 70% EtOAc, 5% MeOH in hexanes) provided epoxy amide **22** (51 mg, 66%) as major product together with the *N,N*-dimethyl amino alcohol opening product (16 mg, 19%) as minor product.

Compound [22]. White solid; $R_f=0.40$ (silica gel, 100% EtOAc); $[\alpha]_D^{22} + 18.9$ (c 1.0, CH_2Cl_2); 1H NMR (400 MHz, $CDCl_3$) δ 7.42 (d, $J=8.6$ Hz, 2H, Ar), 7.30 (d, $J=8.1$ Hz, 1H, H_6), 6.79 (d, $J=8.6$ Hz, 2H, Ar), 5.98 (d, $J=2.7$ Hz, 1H, $H_{1'}$), 5.76 (d, $J=8.1$ Hz, 1H, H_5), 5.04 and 4.95 (2d, $J=14.0$ Hz, 2H, CH_2Ar), 4.93 (dd, $J=5.9$, 3.8 Hz, 1H, $H_{3'}$), 4.75 (dd, $J=5.9$, 2.7 Hz, 1H, $H_{2'}$), 4.25 (dd, $J=3.8$, 3.8 Hz, 1H, $H_{4'}$), 3.75 (s, 3H, CH_3O), 3.67 (d, $J=2.1$ Hz, 1H, $H_{6'}$), 3.49 (dd, $J=3.8$, 2.1 Hz, 1H, $H_{5'}$), 3.09 and 2.96 (2s, 6H, $N(CH_3)_2$), 1.56 and 1.33 (2s, 6H, $C(CH_3)_2$); ^{13}C NMR (100 MHz, $CDCl_3$) δ 165.9, 162.2, 159.1, 150.8, 138.4, 130.9, 128.7, 114.8, 113.6, 103.0, 92.4, 83.9, 83.2, 81.4, 57.2, 55.2, 50.4, 43.7, 36.4, 35.7, 27.2, 25.3; FAB HRMS (NBA): m/e 487.1945, M^+ calcd for $C_{24}H_{29}N_3O_8$ 487.1955.

4.8. Methyl epoxy ester **23**

To a solution of epoxy-indole amide **21** (78 mg, 0.139 mmol, 1.0 equiv) in MeOH (2.5 mL) was added triethylamine (20 μ L, 0.139 mmol, 1.0 equiv), and the reaction mixture was stirred for 30 min at 25 °C. After this time, the solvent was removed by concentration under reduced pressure and the crude product was purified by flash column chromatography (silica gel, 40% EtOAc, 5% MeOH in hexanes) to obtain epoxy ester **23** (66 mg, 99%) as a white solid: $R_f=0.43$ (silica gel, 40% EtOAc, 5% MeOH in hexanes); $[\alpha]_D^{22} + 14.0$ (c 0.1, CH_2Cl_2); 1H NMR (400 MHz, $CDCl_3$) δ 7.40 (d, $J=8.6$ Hz, 2H, Ar), 7.20 (d, $J=8.1$ Hz, 1H, H_6), 6.80 (d, $J=8.6$ Hz, 2H, Ar), 5.82 (d, $J=2.7$ Hz, 1H, $H_{1'}$), 5.76 (d, $J=8.1$ Hz, 1H, H_5), 5.03 and 4.96 (2d, $J=14.0$ Hz, 2H, CH_2Ar), 4.95 (dd, $J=6.4$, 4.3 Hz, 1H, $H_{3'}$), 4.83 (dd, $J=6.4$, 2.7 Hz, 1H, $H_{2'}$), 4.12 (dd, $J=4.3$, 4.3 Hz, 1H, $H_{4'}$), 3.78 and 3.75 (2s, 6H, CH_3O), 3.55 (dd, $J=4.3$, 2.1 Hz, 1H, $H_{5'}$),

3.50 (d, $J=2.1$ Hz, 1H, $H_{6'}$), 1.54 and 1.33 (2s, 6H, $C(CH_3)_2$); ^{13}C NMR (100 MHz, $CDCl_3$) δ 168.4, 162.2, 159.1, 139.0, 130.7, 114.8, 113.7, 102.9, 94.0, 84.8, 84.3, 81.6, 57.4, 55.2, 52.7, 50.2, 43.6, 27.1, 25.3; FAB HRMS (NBA): m/e 497.1532, $M+Na^+$ calcd for $C_{23}H_{26}N_2O_9$ 497.1536.

4.9. Isopropyl epoxy ester **24**

To a stirred solution of methyl epoxy ester **23** (45 mg, 0.095 mmol, 1.0 equiv) in 2-methyl-2-propanol (2.5 mL) was added Bu_2SnO (2.4 mg, 9.5 μ mol, 0.1 equiv). The reaction mixture was then heated at reflux with complete depletion of starting material after 12 h, according to TLC analysis. The crude mixture was allowed to warm to 25 °C, diluted with EtOAc (5 mL) and washed with saturated aqueous $NaHCO_3$ solution (5 mL). The aqueous solution was extracted with EtOAc (2 \times 5 mL) and the combined organic layers were dried over $MgSO_4$, filtered through a pad of Celite and concentrated under reduced pressure. Purification by flash column chromatography (silica gel, 40% EtOAc, 5% MeOH in hexanes) furnished epoxy ester **24** (32 mg, 67%) as a white solid: $R_f=0.57$ (silica gel, 40% EtOAc, 5% MeOH in hexanes); $[\alpha]_D^{22} + 8.0$ (c 0.1, CH_2Cl_2); 1H NMR (400 MHz, $CDCl_3$) δ 7.40 (d, $J=8.6$ Hz, 2H, Ar), 7.23 (d, $J=8.1$ Hz, 1H, H_6), 6.80 (d, $J=8.6$ Hz, 2H, Ar), 5.88 (d, $J=2.7$ Hz, 1H, $H_{1'}$), 5.77 (d, $J=8.1$ Hz, 1H, H_5), 5.12–4.93 (m, 4H, $H_{3'}$, CH_2Ar , $CH(CH_3)_2$), 7.81 (dd, $J=6.4$, 2.7 Hz, 1H, $H_{2'}$), 4.19 (dd, $J=3.8$, 3.8 Hz, 1H, $H_{4'}$), 3.75 (s, 3H, CH_3O), 3.53 (dd, $J=3.8$, 1.6 Hz, 1H, $H_{5'}$), 3.45 (d, $J=1.6$ Hz, 1H, $H_{6'}$), 1.55 and 1.33 (2s, 6H, $C(CH_3)_2$), 1.27 and 1.26 (2s, 6H, $CH(CH_3)_2$); ^{13}C NMR (100 MHz, $CDCl_3$) δ 167.4, 162.2, 159.1, 150.8, 138.7, 130.7, 128.7, 114.8, 113.7, 102.9, 93.2, 84.2, 84.0, 81.5, 70.0, 57.3, 55.2, 50.5, 43.6, 27.1, 25.3, 21.7, 21.6; FAB HRMS (NBA): m/e = 525.1852, $M+Na^+$ calcd for $C_{25}H_{30}N_2O_9$ 525.1849.

4.10. Amino alcohol **25**

A solution of *N-Z*-1,3-diaminopropane hydrochloride (34.4 mg, 0.14 mmol, 1.4 equiv) in MeOH (2 mL) was treated with triethylamine (28 μ L, 0.2 mmol, 2.0 equiv) for 30 min at room temperature. After this time, this solution was added to a solution of epoxy amide **22** (49 mg, 0.1 mmol, 1.0 equiv) in MeOH (2 mL) and the resulting reaction mixture was heated under reflux for 8 days. Then, the mixture was allowed to reach room temperature and toluene (1.0 mL) was added. The resulting azeotropic solution was concentrated under reduced pressure and the crude product was purified by flash column chromatography (silica gel, 75% EtOAc, 5% MeOH in hexanes) to furnish amino alcohol **25** (41 mg, 33%) as a white solid: $R_f=0.26$ (silica gel, 75% EtOAc, 5% MeOH in hexanes); $[\alpha]_D^{22} + 22.9$ (c 0.7, CH_2Cl_2); 1H NMR (400 MHz, $CDCl_3$) δ 7.39 (d, $J=8.6$ Hz, 2H, Ar PMB), 7.32–7.27 (m, 6H, aromatics Cbz, H_6), 6.77 (d, $J=8.6$ Hz, 2H, Ar PMB), 5.74–5.69 (m, 2H, $H_{1'}$, H_5), 5.38 (bs, $NHCbz$), 5.10–4.98 (m, 4H, CH_2ArPMB , CH_2ArCbz) 4.91 (dd, $J=6.4$, 3.2 Hz, 1H, $H_{3'}$), 4.81–4.79 (m, 1H, $H_{2'}$), 4.47 (bs, 1H, $H_{4'}$), 3.80 (d, $J=8.1$ Hz, 1H, $H_{5'}$), 3.74 (bs, 4H, CH_3O , $H_{6'}$), 3.28–3.17 (m, 2H, CH_2NHCO), 2.91 (s, 6H, $N(CH_3)_2$), 2.64–2.58 and 2.42–2.36 (2m, 2H, CH_2NH), 1.60–1.55 (m, 2H, CH_2), 1.54 and 1.31 (2s, 6H, $C(CH_3)_2$); ^{13}C NMR (100 MHz, $CDCl_3$)

δ 173.3, 162.3, 159.0, 156.5, 151.1, 140.0, 130.8, 128.7, 128.5, 128.0, 114.4, 113.6, 102.4, 94.6, 85.1, 83.0, 81.1, 72.4, 66.4, 58.8, 55.2, 45.3, 43.6, 39.1, 37.2, 35.8, 29.3, 27.3, 25.3; FAB HRMS (NBA): m/e 718.3071, $M+Na^+$ calcd for $C_{35}H_{45}N_5O_{10}$ 718.3064.

4.11. Amino alcohol 26

A solution of epoxy amide **22** (61 mg, 0.125 mmol, 1.0 equiv) in MeOH (2 mL) was treated with 1,3-diaminopropane (21 μ L, 0.25 mmol, 2.0 equiv) for 48 h at 70 °C. After this time, the mixture was allowed to reach room temperature and toluene (1.0 mL) was added. Then, the solution was concentrated under reduced pressure and the crude product was used in the coupling step without purification.

4.12. Compound 28

Cbz-Leu-OH (40 mg, 0.15 mmol, 1.2 equiv) was dissolved in dry CH_2Cl_2 (2 mL) and treated with HOBt (21 mg, 0.15 mmol, 1.2 equiv) at room temperature. After stirring for 5 min, EDCI (29.4 mg, 0.15 mmol, 1.2 equiv) was added to the solution. The mixture was stirred for 45 min and then, the crude mixture was added to a solution of amino alcohol **26** (~0.125 mmol, 1.0 equiv) in CH_2Cl_2 (2 mL). The reaction mixture was then stirred for additional 3 h. After that time, a 15% aqueous NH_3 solution (0.5 mL) was added and the reaction mixture was diluted with Et_2O (10 mL) and washed with a saturated aqueous NH_4Cl solution (10 mL). The layers were separated and the aqueous phase was extracted with Et_2O (2 \times 5 mL). The combined organic phase was dried ($MgSO_4$), filtered and concentrated. Purification by flash column chromatography (silica gel, 10% MeOH in EtOAc) afforded peptidic derivative **28** (36 mg, 36% over two steps from **22**) as a white solid: R_f = 0.40 (silica gel, 10% MeOH in EtOAc); $[\alpha]_D^{22} + 10.6$ (c 0.8, CH_2Cl_2); 1H NMR (400 MHz, $CDCl_3$) δ 7.54 (d, J = 8.1 Hz, 1H, H_6), 7.40 (d, J = 8.6 Hz, 2H, Ar PMB), 7.32–7.29 (m, 5H, aromatics Cbz), 6.78 (d, J = 8.6 Hz, 2H, Ar PMB), 5.87 (bs, 1H, $H_{1'}$), 5.74 (d, J = 8.1 Hz, 1H, H_5), 5.63 (bs, 1H, $NHCbz$), 5.09–4.96 (m, 4H, CH_2ArPMB , CH_2ArCbz), 4.89 (dd, J = 6.4, 2.7 Hz, 1H, $H_{3'}$), 4.82–4.79 (m, 1H, $H_{2'}$), 4.44 (bs, 1H, $H_{4'}$), 4.10–4.04 (m, 1H, $CHCH_2CH(CH_3)_2$), 3.96–3.86 (m, 1H, $H_{5'}$), 3.78–3.73 (m, 1H, $H_{6'}$), 3.75 (s, 3H, CH_3O), 3.40–3.33 and 3.27–3.19 (2m, 2H, CH_2NHCO), 2.95–2.91 (m, 6H, $N(CH_3)_2$), 2.60–2.52 and 2.48–2.39 (2m, 2H, CH_2NH), 1.62–1.51 (m, 5H, CH_2 , $CHCH_2CH(CH_3)_2$, $CHCH_2CH(CH_3)_2$), 1.56 and 1.31 (2s, 6H, $C(CH_3)_2$), 0.92–0.85 (m, 6H, $CH(CH_3)_2$); ^{13}C NMR (100 MHz, $CDCl_3$) δ 172.7, 164.4, 159.1, 156.3, 151.1, 140.0, 136.3, 130.9, 130.7, 128.7, 128.5, 128.1, 128.0, 127.9, 114.5, 113.6, 102.6, 94.4, 84.8, 82.7, 81.3, 71.6, 66.9, 59.4, 55.2, 53.6, 44.9, 43.7, 43.6, 41.1, 37.3, 35.9, 29.6, 27.3, 25.3, 24.7, 22.7, 22.0; FAB HRMS (NBA): m/e 808.4001, $M+Na^+$ calcd for $C_{41}H_{56}N_6O_{11}$ 808.4007.

4.13. Epoxy amide 32

A solution of sulfonium salt **31** (93 mg, 0.361 mmol, 1.03 equiv) in CH_3CN (2.5 mL) was treated with NaH (45 mg, 1.13 mmol, 3.2 equiv). The reaction mixture was stirred at 25 °C for 3 h. After this time, *t*-butyl methyl ether

(3 mL) was added and the combined organic solution was filtered, washed with *t*-butyl methyl ether and hexanes, and concentrated under reduced pressure. Thus, the resulting sulfur ylide was dissolved in CH_2Cl_2 (3 mL) and treated with crude aldehyde **29** (~0.352 mmol, 1.0 equiv), obtained by oxidation of its corresponding alcohol (0.1 g, 0.370 mmol) with DMP, at 0 °C. After 2.5 h, the crude mixture was concentrated under reduced pressure. Purification by flash column chromatography (silica gel, 80% EtOAc in hexanes) afforded epoxy amide **32** (46 mg, 43% from precursor alcohol of aldehyde **29**) as a white solid: R_f = 0.51 (silica gel, 100% EtOAc); $[\alpha]_D^{22} + 24.0$ (c 0.1, CH_2Cl_2); 1H NMR (400 MHz, $CDCl_3$) δ 9.70 (bs, 1H, NH), 8.13 (d, J = 8.6 Hz, 1H, Ar), 7.34 (d, J = 8.1 Hz, H_6), 7.17–7.13 (m, 2H, Ar), 7.01 (dd, J = 7.0, 7.0 Hz, 1H, Ar), 5.89 (d, J = 2.1 Hz, 1H, $H_{1'}$), 5.71 (dd, J = 8.1, 1.6 Hz, 1H, H_5), 4.99 (dd, J = 6.4, 3.8 Hz, 1H, $H_{3'}$), 4.84 (dd, J = 6.4, 2.1 Hz, 1H, $H_{2'}$), 4.24–4.13 (m, 3H, $H_{4'}$, CH_2CH_2N indoline), 3.68 (d, J = 2.1 Hz, 1H, $H_{6'}$), 3.63–3.62 (m, 1H, $H_{5'}$), 3.23–3.16 (m, 2H, CH_2CH_2N indoline), 1.55 and 1.33 (2s, 6H, $C(CH_3)_2$); ^{13}C NMR (100 MHz, $CDCl_3$) δ 172.5, 163.1, 150.2, 142.3, 141.9, 131.7, 127.2, 124.9, 124.7, 117.4, 114.3, 102.5, 92.1, 84.7, 83.2, 81.9, 57.8, 50.5, 49.3, 48.7, 44.9, 30.0, 27.9, 27.5, 25.1; FAB HRMS (NBA): m/e 464.1429, $M+Na^+$ calcd for $C_{22}H_{23}N_3O_7$ 464.1434.

4.14. Epoxy amide 33

To a solution of crude aldehyde **30** (~0.9 g, 1.9 mmol, 1.0 equiv), prepared from its corresponding alcohol (0.93 g, 1.9 mmol) by oxidation with IBX, in CH_2Cl_2 (8 mL) was added at 0 °C, sulfonium salt **31** (0.56 g, 2.16 mmol, 1.1 equiv) and a 20% aqueous NaOH solution (0.43 mL, 2.16 mmol, 1.1 equiv). After stirring for 1.5 h, the crude mixture was diluted with H_2O (10 mL), the layers were separated and the aqueous phase was extracted with EtOAc (1 \times 10 mL). The combined organic extracts were dried ($MgSO_4$) and concentrated under reduced pressure. Purification by flash column chromatography (silica gel, 50% EtOAc in hexanes) gave epoxy amide **33** (0.76 g, 61% over two steps from its corresponding alcohol) as a white solid: R_f = 0.45 (silica gel, 50% EtOAc in hexanes); $[\alpha]_D^{22} + 51.3$ (c 1.4, CH_2Cl_2); 1H NMR (400 MHz, $CDCl_3$) δ 8.83 (bs, 1H, NH), 8.17 (d, J = 8.1 Hz, 1H, H_6), 7.75 (d, J = 8.1 Hz, 1H, Ar), 7.22–7.19 (m, 2H, Ar), 7.06 (dd, J = 7.0, 7.0 Hz, 1H, Ar), 5.98 (d, J = 4.8 Hz, 1H, $H_{1'}$), 5.76 (dd, J = 8.1, 2.1 Hz, 1H, H_5), 4.35 (d, J = 3.2 Hz, 1H, $H_{4'}$), 4.20–4.16 (m, 2H, CH_2CH_2N indoline), 4.11–4.09 (m, 2H, $H_{2'}$, $H_{3'}$), 3.78 (d, J = 2.1 Hz, 1H, $H_{6'}$), 3.51 (d, J = 2.1 Hz, 1H, $H_{5'}$), 3.28–3.24 (m, 2H, CH_2CH_2N indoline), 0.90 and 0.86 (2s, 18H, $C(CH_3)_3$), 0.12, 0.11, 0.05, and 0.03 (4s, 12H, $Si(CH_3)_2$); ^{13}C NMR (100 MHz, $CDCl_3$) δ 163.8, 162.8, 150.4, 142.2, 139.5, 130.9, 127.7, 124.7, 124.6, 117.3, 103.0, 87.8, 79.2, 74.8, 73.6, 57.2, 50.6, 47.3, 28.1, 25.7, 25.6, 18.1, 17.9, -4.9, -4.8, -4.6, -4.5; FAB HRMS (NBA): m/e 652.2846, $M+Na^+$ calcd for $C_{31}H_{47}N_3O_7Si_2$ 652.2850.

4.15. Azido alcohol 34

A solution of epoxy amide **32** (46 mg, 0.104 mmol, 1.0 equiv) in MeOH (2 mL) was treated with a 6.4 M 1-azido-3-propanoamine solution in Et_2O (16 μ L, 0.104 mmol, 1.0 equiv). After stirring at 70 °C for 72 h,

the crude mixture was diluted with toluene (0.5 mL) and concentrated in vacuo. Purification by flash column chromatography (silica gel, 100% EtOAc) provided compound **34** (27 mg, 48%) as a white solid: $R_f=0.44$ (silica gel, 100% EtOAc); $[\alpha]_D^{22} -7.2$ (c 0.5, CH_2Cl_2); ^1H NMR (400 MHz, CDCl_3) δ 8.20 (d, $J=7.5$ Hz, 1H, Ar), 7.64 (d, $J=8.1$ Hz, 1H, H_6), 7.17–7.13 (m, 2H, Ar), 7.01 (dd, $J=7.0$, 7.0 Hz, 1H, Ar), 5.90 (d, $J=3.4$ Hz, 1H, $\text{H}_{1'}$), 5.67 (d, $J=8.1$ Hz, 1H, H_5), 4.91 (dd, $J=5.9$, 2.7 Hz, 1H, $\text{H}_{3'}$), 4.80 (dd, $J=5.9$, 3.4 Hz, 1H, $\text{H}_{2'}$), 4.59 (bs, 1H, $\text{H}_{4'}$), 4.16–4.04 (m, 2H, $\text{CH}_2\text{CH}_2\text{N}$ indoline), 3.88 (d, $J=8.6$ Hz, 1H, $\text{H}_{5'}$), 3.68 (d, $J=8.6$ Hz, $\text{H}_{6'}$), 3.40–3.27 (m, 2H, CH_2N_3), 3.12–3.06 (m, 2H, $\text{CH}_2\text{CH}_2\text{N}$ indoline), 2.75–2.64 and 2.55–2.49 (2m, 2H, CH_2NH), 1.72–1.65 (m, 2H, CH_2), 1.57 and 1.33 (2s, 6H, $\text{C}(\text{CH}_3)_2$); ^{13}C NMR (100 MHz, CDCl_3) δ 172.7, 163.2, 150.4, 142.1, 141.8, 131.8, 127.5, 124.8, 124.6, 117.4, 114.4, 102.8, 92.8, 84.9, 83.1, 81.4, 73.0, 61.6, 49.2, 48.2, 44.8, 29.4, 27.8, 27.3, 25.3; FAB HRMS (NBA): m/e 564.2288, $M+\text{Na}^+$ calcd for $\text{C}_{25}\text{H}_{31}\text{N}_7\text{O}_7$ 564.2183.

4.16. Azido alcohol 35

A solution of epoxy amide **33** (0.2 g, 0.318 mmol, 1.0 equiv) in MeOH (7 mL) was treated with a 6.4 M of 1-azido-3-propanoamine solution in Et_2O (0.1 mL, 0.68 mmol, 2.1 equiv). After stirring at 70 °C for 48 h, the crude mixture was then diluted with toluene (1.0 mL) and concentrated in vacuo. Purification by flash column chromatography (silica gel, 50% EtOAc in hexanes) provided compound **35** (193 mg, 83%) as a white solid: $R_f=0.41$ (silica gel, 50% EtOAc in hexanes); $[\alpha]_D^{22} -7.2$ (c 0.5, CH_2Cl_2); ^1H NMR (400 MHz, CDCl_3) δ 9.03 (bs, 1H, NH), 8.22 (d, $J=8.1$ Hz, 1H, H_6), 7.68 (d, $J=8.1$ Hz, 1H, Ar), 7.19–7.17 (m, 2H, Ar), 7.03 (dd, $J=7.0$, 7.0 Hz, 1H, Ar), 5.68 (d, $J=8.1$ Hz, 1H, H_5), 5.62 (d, $J=6.4$ Hz, 1H, $\text{H}_{1'}$), 4.43 (dd, $J=6.4$, 4.8 Hz, 1H, $\text{H}_{2'}$), 4.39 (bs, 1H, $\text{H}_{4'}$), 4.20–4.09 (m, 3H, $\text{H}_{3'}$, $\text{CH}_2\text{CH}_2\text{N}$ indoline), 3.80–3.71 (m, 2H, $\text{H}_{5'}$, $\text{H}_{6'}$), 3.41–3.28 (m, 2H, CH_2N_3), 3.16–3.12 (m, 2H, $\text{CH}_2\text{CH}_2\text{N}$ indoline), 2.79–2.73 and 2.60–2.51 (2m, 2H, CH_2NH), 1.72–1.67 (m, 2H, CH_2), 0.88 and 0.82 (2s, 18H, $\text{C}(\text{CH}_3)_3$), 0.06, 0.003, and -0.05 (3s, 12H, $\text{Si}(\text{CH}_3)_2$); ^{13}C NMR (100 MHz, CDCl_3) δ 163.1, 150.4, 142.4, 142.2, 131.7, 127.5, 124.7, 124.6, 117.5, 102.3, 91.8, 85.6, 73.5, 73.0, 72.0, 61.8, 49.1, 48.2, 44.8, 27.9, 25.8, 25.7, 18.0, 17.9, 2.2, 1.9, 1.7; FAB HRMS (NBA): m/e 752.3584, $M+\text{Na}^+$ calcd for $\text{C}_{34}\text{H}_{55}\text{N}_7\text{O}_7\text{Si}_2$ 752.3599.

4.17. Amino alcohol 36

A solution of *N*-Z-1,3-diaminopropane hydrochloride (0.16 g, 0.63 mmol, 2.0 equiv) in MeOH (2 mL) was treated with triethylamine (0.13 mL, 0.906 mmol, 2.9 equiv) for 30 min at room temperature. After this time, the resulting mixture was added to a solution of epoxy amide **33** (0.2 g, 0.318 mmol, 1.0 equiv) in MeOH (4 mL) and the reaction mixture was stirred under reflux for 48 h. Then, the mixture was allowed to reach room temperature and toluene (1.0 mL) was added. The solution was concentrated under reduced pressure and the crude product was purified by flash column chromatography (silica gel, 80% EtOAc in hexanes) to provide amino alcohol **36** (0.22 g, 83%) as a white solid: $R_f=0.56$ (silica gel, 80% EtOAc in hexanes); $[\alpha]_D^{22} -4.0$

(c 0.4, CH_2Cl_2); ^1H NMR (400 MHz, CDCl_3) δ 8.78 (bs, 1H, NH), 8.20 (d, $J=8.1$ Hz, 1H, Ar indoline), 7.34–7.26 (m, 6H, aromatics Cbz, H_6), 7.18–7.14 (m, 2H, Ar indoline), 7.02 (dd, $J=7.5$, 7.5 Hz, 1H, Ar indoline), 5.61 (d, $J=8.1$ Hz, 1H, H_5), 5.51 (d, $J=5.4$ Hz, 1H, $\text{H}_{1'}$), 5.27 (bs, 1H, NHCbz), 5.04 (2d, $J=12.4$ Hz, 2H, CH_2Ar), 4.49–4.45 (m, 1H, $\text{H}_{2'}$), 4.33 (br s, 1H, $\text{H}_{4'}$), 4.17–4.10 (m, 3H, $\text{H}_{3'}$, $\text{CH}_2\text{CH}_2\text{N}$ indoline), 3.96–3.81 (br s, 2H, $\text{H}_{5'}$, $\text{H}_{6'}$), 3.32–3.23 (m, 2H, CH_2NHCO), 3.17–3.13 (m, 2H, $\text{CH}_2\text{CH}_2\text{N}$ indoline), 2.77 and 2.54 (2bs, 2H, CH_2NH), 1.66 (bs, 2H, CH_2), 0.86 and 0.81 (2s, 18H, $\text{C}(\text{CH}_3)_3$), 0.05, 0.04, -0.004 and -0.07 (4s, 12H, $\text{Si}(\text{CH}_3)_2$); ^{13}C NMR (100 MHz, CDCl_3) δ 162.8, 156.6, 150.4, 142.7, 142.2, 136.6, 131.6, 128.5, 128.1, 128.0, 127.5, 124.7, 117.5, 102.4, 92.3, 86.1, 73.1, 73.0, 66.7, 62.2, 58.1, 48.2, 45.2, 38.6, 28.0, 25.7, 18.0, 17.9, -4.5 , -4.6 , -4.7 , -5.0 ; FAB HRMS (NBA): m/e 860.4066, $M+\text{Na}^+$ calcd for $\text{C}_{42}\text{H}_{63}\text{N}_5\text{O}_9\text{Si}_2$ 860.4062.

4.18. Amino alcohol 37

Procedure A. A solution of azido alcohol **35** (19 mg, 0.028 mmol, 1.0 equiv) in THF (1.0 mL) was treated with Ph_3P (29 mg, 0.11 mmol, 4.0 equiv) at room temperature for 1 h. After this time, H_2O (1 mL) was added and the resulting mixture was vigorously stirred for additional 5 h. After this time, the crude mixture was diluted with Et_2O , the phases were separated and the aqueous phase was extracted with Et_2O (2×5 mL). The combined ethereal solution was washed with brine, dried (MgSO_4), filtered and concentrated to obtain a crude product, which was purified by flash column chromatography (silica gel, 10–15% MeOH in CH_2Cl_2) to provide amino alcohol **37** (15 mg, 75%) as a white solid. **Procedure B.** A solution of alcohol **36** (113 mg, 0.135 mmol, 1.0 equiv) in EtOH (10 mL) was treated with Pd–C 10% wt (0.15 g) and HCOONH_4 25% w/v (1.7 mL) under Ar atmosphere. After stirring for 30 min at room temperature, the mixture was filtered through a pad of Celite, and the filtrates were washed with MeOH (2×5 mL) and concentrated under reduced pressure. The crude mixture was purified by flash column chromatography (silica gel, 10–15% MeOH in CH_2Cl_2) to provide amino alcohol **37** (68 mg, 72%): $R_f=0.32$ (silica gel, 10% MeOH in CH_2Cl_2); $[\alpha]_D^{22} -5.1$ (c 0.4, CH_2Cl_2); ^1H NMR (400 MHz, CDCl_3) δ 8.20 (d, $J=8.6$ Hz, 1H, Ar), 8.02 (bs, 1H, H_6), 7.18–7.14 (m, 2H, Ar), 7.02 (dd, $J=7.5$ Hz, 1H, Ar), 6.03 (d, $J=7.0$ Hz, 1H, H_5), 5.65 (d, $J=4.3$ Hz, 1H, $\text{H}_{1'}$), 4.42–4.00 (m, 6H, $\text{H}_{2'}$, $\text{H}_{3'}$, $\text{H}_{5'}$, $\text{H}_{6'}$, $\text{CH}_2\text{CH}_2\text{N}$ indoline), 4.12 (bs, 1H, $\text{H}_{4'}$), 3.39–3.14 (m, 4H, $\text{CH}_2\text{CH}_2\text{N}$ indoline, CH_2NH), 3.10 and 2.66 (2bs, 2H, CH_2NH_2), 1.99 and 1.72 (2bs, 2H, CH_2), 0.80 and 0.70 (2s, 18H, $\text{C}(\text{CH}_3)_3$), -0.003 , -0.02 , -0.04 , -0.1 (4s, 12H, $\text{Si}(\text{CH}_3)_2$); ^{13}C NMR (100 MHz, CDCl_3) δ 169.6, 164.8, 153.8, 150.7, 142.5, 131.4, 127.4, 124.5, 124.3, 117.5, 102.7, 91.3, 85.5, 73.5, 68.4, 64.4, 48.2, 47.8, 41.2, 29.6, 28.3, 25.6, 24.3, 17.8, -4.5 , -4.7 , -4.9 ; FAB HRMS (NBA): m/e 726.3687, $M+\text{Na}^+$ calcd for $\text{C}_{34}\text{H}_{57}\text{N}_5\text{O}_7\text{Si}_2$ 726.3694.

4.19. Peptidic derivative 38

Z-Leu-OH (29.4 mg, 0.11 mmol, 1.3 equiv) was dissolved in dry CH_2Cl_2 (1 mL) and treated with HOBt (15.3 mg, 0.11 mmol, 1.3 equiv) at room temperature. After stirring

for 5 min, EDCI (21.7 mg, 0.11 mmol, 1.3 equiv) was added to the solution and the resulting mixture was stirred for 45 min and added to a solution of **37** (60 mg, 0.085 mmol, 1.0 equiv) in CH₂Cl₂ (1.5 mL). The reaction mixture was then stirred for additional 6 h. After that time, a 15% aqueous NH₃ solution (0.2 mL) was added and the crude mixture was diluted with Et₂O (4 mL) and washed with NH₄Cl (4 mL). The layers were separated and the aqueous phase was extracted with Et₂O (2×4 mL). The combined organic phase was dried over MgSO₄, filtered and concentrated. Purification by flash column chromatography (silica gel, 5% MeOH in CH₂Cl₂) afforded peptidic derivative **38** (60 mg, 74%) as a white solid: *R*_f=0.58 (silica gel, 10% MeOH in CH₂Cl₂); [α]_D²² −10.8 (*c* 1.5, CH₂Cl₂); ¹H NMR (400 MHz, CDCl₃) δ 8.21 (d, *J*=7.5 Hz, 1H, Ar indoline), 7.50 (bs, 1H, H₆), 7.34–7.25 (m, 4H, aromatics Cbz), 7.17–7.12 (m, 2H, Ar indoline), 7.01 (dd, *J*=7.5, 7.5 Hz, 1H, Ar indoline) 5.65 (d, *J*=7.5 Hz, 1H, H₅), 5.53 (bs, 1H, H₁'), 5.07 (2d, *J*=12.4 Hz, 2H, CH₂Ar), 4.57 (bs, 1H, H₂'), 4.30 (bs, 1H, H₄'), 4.27–4.07 (m, 4H, CH₂CH₂N indoline, H₃', CHCH₂CH(CH₃)₂), 3.83 (bs, 1H, H₅'), 3.70 (bs, 1H, H₆'), 3.36–3.24 (m, 2H, CH₂NHCO), 3.17–3.11 (m, 2H, CH₂CH₂N indoline), 2.78–2.70 and 2.57–2.51 (2m, 2H, CH₂NH), 1.67–1.41 (m, 5H, CH₂, CHCH₂CH(CH₃)₂, CHCH₂CH(CH₃)₂), 0.87–0.82 (m, 24H, CH(CH₃)₂, C(CH₃)₃), 0.03, 0.02, −0.01, −0.07 (4s, 12H, Si(CH₃)₂); ¹³C NMR (100 MHz, CDCl₃) δ 172.7, 169.3, 162.8, 156.3, 150.6, 143.3, 142.4, 142.3, 136.2, 131.4, 128.5, 128.1, 128.0, 127.5, 124.7, 124.5, 117.5, 102.4, 93.5, 86.8, 74.0, 73.5, 67.0, 66.9, 62.8, 53.4, 48.1, 41.5, 37.9, 28.0, 25.7, 24.6, 23.0, 22.8, 21.9, 18.0, 17.8, −4.5, −4.6, −4.7, −5.1; FAB HRMS (NBA): *m/e* 973.4905, *M*+Na⁺ calcd for C₄₈H₇₄N₆O₁₀Si₂ 973.4903.

4.20. Amine alcohol 39

Compound **38** (31 mg, 0.033 mmol, 1.0 equiv) was dissolved in MeOH (3 mL) and purged with Ar. Then, 10% Pd-C (30 mg) was added and the reaction mixture was exposed to a H₂ atmosphere for 30 min. After this time, the mixture was filtered and the filtrate was washed with MeOH (2×3 mL). The combined organic solution was concentrated under reduced pressure and the resulting crude product was purified by flash column chromatography (silica gel, 10% MeOH in CH₂Cl₂) to obtain amine **39** (23 mg, 86%) as a white solid: *R*_f=0.39 (silica gel, 10% MeOH in CH₂Cl₂); [α]_D²² −11.3 (*c* 0.2, CH₂Cl₂); ¹H NMR (400 MHz, CDCl₃) δ 8.20 (d, *J*=8.1 Hz, 1H, Ar), 7.64 (d, *J*=8.1 Hz, 1H, H₆), 7.50 (bs, 1H, NH), 7.17–7.12 (m, 2H, Ar), 7.01 (dd, *J*=7.5, 7.5 Hz, 1H, Ar) 5.67 (d, *J*=8.1 Hz, 1H, H₅), 5.61 (d, *J*=6.4 Hz, 1H, H₁'), 4.44 (dd, *J*=6.4, 5.4 Hz, 1H, H₂'), 4.31 (bs, 1H, H₄'), 4.14–4.08 (m, 3H, H₃', CH₂CH₂N indoline), 3.84 (d, *J*=6.4 Hz, 1H, H₅'), 3.72 (d, *J*=6.4 Hz, 1H, H₆'), 3.43–3.21 (m, 3H, CH₂NHCO, CHCH₂CH(CH₃)₂), 3.18–3.12 (m, 2H, CH₂CH₂N indoline), 2.72–2.68 and 2.53–2.43 (2m, 2H, CH₂NH), 1.63–1.61 (m, 4H, CH₂, CHCH₂CH(CH₃)₂, CHCH₂CH(CH₃)₂), 1.32–1.25 (m, 1H, CHCH₂CH(CH₃)₂), 0.89–0.81 (m, 24H, CH(CH₃)₂, C(CH₃)₃), 0.04, 0.02, −0.01, −0.06 (4s, 12H, Si(CH₃)₂); ¹³C NMR (100 MHz, CDCl₃) δ 175.2, 169.5, 163.1, 150.5, 142.8, 142.3, 131.5, 127.5, 124.7, 124.5, 117.5, 102.4, 91.2, 86.1, 73.4, 71.4, 62.4, 53.4, 48.1, 45.2, 43.8, 36.9, 30.9, 29.6, 28.0, 25.8, 25.7, 24.8, 23.2, 21.4, 18.0, 17.9, −4.5,

−4.6, −4.7, −5.0; FAB HRMS (NBA): *m/e* 817.4718, *M*+Na⁺ calcd for C₄₀H₆₈N₆O₈Si₂ 817.4715.

4.21. Epoxy indole amide 40

A solution of epoxy amide **33** (0.47 g, 0.75 mmol, 1.0 equiv) in C₆H₆ (8 mL) was treated with DDQ (0.89 g, 3.73 mmol, 5.0 equiv) for 24 h at 80 °C. After this time, the reaction mixture was allowed to reach room temperature and diluted with CHCl₃ (10 mL) and washed sequentially with a saturated aqueous NaHCO₃ solution (3×10 mL) and brine (5 mL). The combined organic solution was concentrated under reduced pressure and the crude product was purified by flash column chromatography (silica gel, 40% EtOAc in hexanes) to afford epoxy amide **40** (0.40 g, 86%) as a white solid: *R*_f=0.73 (silica gel, 50% EtOAc in hexanes); [α]_D²² +44.0 (*c* 0.3, CH₂Cl₂); ¹H NMR (400 MHz, CDCl₃) δ 9.33 (bs, 1H, NH), 8.39 (d, *J*=6.4 Hz, 1H, Ar), 7.73 (d, *J*=8.6 Hz, 1H, H₆), 7.58–7.56 and 7.39–7.29 (2m, 4H, CHCHN indoline, Ar), 6.73 (d, *J*=3.8 Hz, 1H, CHCHN indoline), 5.98 (d, *J*=4.8 Hz, 1H, H₁'), 5.79 (dd, *J*=8.6, 2.1 Hz, 1H, H₅), 4.43 (d, *J*=4.3 Hz, 1H, H₄'), 4.29 (d, *J*=1.6 Hz, 1H, H₅'), 4.30 (dd, *J*=4.3, 4.3 Hz, 1H, H₃'), 4.12 (dd, *J*=4.8, 4.3 Hz, 1H, H₂'), 3.61 (d, *J*=1.6 Hz, 1H, H₆'), 0.91 and 0.88 (2s, 18H, C(CH₃)₃), 0.13, 0.12, 0.07 and 0.05 (4s, 12H, Si(CH₃)₂); ¹³C NMR (100 MHz, CDCl₃) δ 164.6, 163.1, 150.4, 139.2, 135.5, 130.2, 125.7, 124.6, 123.3, 121.1, 116.4, 111.1, 103.0, 88.2, 78.7, 74.9, 73.3, 57.7, 51.0, 25.7, 25.6, 18.0, 17.9, −4.4, −4.7, −4.9; FAB HRMS (NBA): *m/e* 650.2692, *M*+Na⁺ calcd for C₃₁H₄₅N₃O₇Si₂ 650.2694.

4.22. Epoxy acid 41. Reaction of epoxy amide 40 with lithium hydroxide

To a solution of epoxy amide **40** (57 mg, 0.091 mmol, 1.0 equiv) in THF (3 mL) was added a 0.1 M aqueous LiOH solution (1.82 mL, 0.182 mmol, 2.0 equiv) dropwise during 15 min at 0 °C. After 5 min, the reaction mixture was diluted with EtOAc (3 mL) and both phases were separated. The aqueous layer was washed with EtOAc (2×3 mL) and acidified with Amberlyst-15 until pH 5. Then, the solution was extracted with EtOAc (3×3 mL) and the combined organic extracts were concentrated in vacuo to obtain crude epoxy acid **41** (40 mg, 83%), which did not require further purification and was used in the next step: *R*_f=0.1 (silica gel, 50% AcOEt in hexanes); [α]_D²² +74.9 (*c* 0.3, CH₂Cl₂); ¹H NMR (400 MHz, CDCl₃) δ 9.33 (bs, 1H, NH), 7.68 (d, *J*=8.1 Hz, 1H, H₆), 5.88 (d, *J*=4.8 Hz, 1H, H₁'), 5.78 (d, *J*=8.1 Hz, 1H, H₅), 4.33 (d, *J*=4.3 Hz, 1H, H₄'), 4.13–4.09 (m, 1H, H₂'), 4.05 (dd, *J*=4.3, 4.3 Hz, 1H, H₃'), 3.64 (d, *J*=1.6 Hz, 1H, H₆'), 3.46 (bs, 1H, H₅'), 0.91 and 0.86 (2s, 18H, C(CH₃)₃), 0.11, 0.10, 0.04, 0.03 (4s, 12H, Si(CH₃)₂); ¹³C NMR (100 MHz, CDCl₃) δ 176.4, 172.0, 163.7, 139.8, 102.7, 88.3, 78.8, 75.0, 73.3, 57.2, 50.0, 25.8, 25.7, 18.1, 17.9, −4.4, −4.7, −4.9; FAB HRMS (NBA): *m/e* 551.2223, *M*+Na⁺ calcd for C₂₃H₄₀N₂O₈Si₂ 551.2221.

4.23. *t*-Butyl epoxy ester 42

To a stirred solution of epoxy acid **41** (35 mg, 0.066 mmol, 1.0 equiv) in CH₂Cl₂ (3 mL) was added *t*-Butyl 2,2,2-trichloroacetimidate 1 M in cyclohexane (0.132 mL,

0.132 mmol, 2.0 equiv). After being stirred for 24 h at 25 °C, the reaction mixture was concentrated under reduced pressure. Purification by flash column chromatography (silica gel, 35% EtOAc in hexanes) afforded *t*-butyl epoxy ester **42** (38 mg, 98%) as a pale yellow solid impurified with 2,2,2-trichloroacetamide: $R_f=0.33$ (silica gel, 30% EtOAc in hexanes); $[\alpha]_D^{22} +16.1$ (*c* 0.6, CH₂Cl₂); ¹H NMR (400 MHz, CDCl₃) δ 9.39 (bs, 1H, NH), 7.66 (d, $J=8.1$ Hz, 1H, H₆), 5.85 (d, $J=4.3$ Hz, 1H, H_{1'}), 5.76 (dd, $J=8.1, 1.6$ Hz, 1H, H₅), 4.30 (dd, $J=4.3, 1.1$ Hz, 1H, H_{4'}) 4.11–4.08 (m, 1H, H_{3'}), 4.04 (dd, $J=8.6, 4.3$ Hz, 1H, H_{2'}), 3.48 (d, $J=2.1$ Hz, 1H, H_{6'}), 3.34 (dd, $J=2.1, 1.1$ Hz, 1H, H_{5'}), 1.47 (s, 9H, OC(CH₃)₃), 0.89 and 0.84 (2s, 18H, C(CH₃)₃), 0.1, 0.09, 0.03, 0.02 (4s, 12H, Si(CH₃)₂); ¹³C NMR (100 MHz, CDCl₃) δ 167.0, 150.1, 139.5, 139.4, 102.8, 88.0, 83.3, 78.9, 74.9, 73.5, 56.8, 50.1, 27.9, 25.8, 25.6, 18.1, 17.9, -4.4, -4.7, -4.8, -4.9; FAB HRMS (NBA): *m/e* 607.2845, $M+Na^+$ calcd for C₂₇H₄₈N₂O₈Si₂ 607.2847.

4.24. Azido alcohol 43

A solution of epoxy ester **42** (95 mg, 0.16 mmol, 1.0 equiv) in MeOH (3 mL) was treated with a 1.68 M of 1-azido-3-propanoamine solution in Et₂O (0.15 mL, 0.24 mmol, 1.5 equiv). After stirring at 70 °C for 4 days, the crude mixture was then diluted with toluene (1.0 mL) and concentrated in vacuo. Purification by flash column chromatography (silica gel, 40% EtOAc in hexanes) provided compound **43** (22 mg, 20%) as a white solid: $R_f=0.47$ (silica gel, 50% EtOAc in hexanes); $[\alpha]_D^{22} +26.2$ (*c* 0.4, CH₂Cl₂); ¹H NMR (400 MHz, CDCl₃) δ 7.89 (d, $J=8.1$ Hz, 1H, H₆), 5.71 (d, $J=8.1$ Hz, 1H, H₅), 5.56 (d, $J=4.3$ Hz, 1H, H_{1'}), 4.28 (dd, $J=4.3, 4.3$ Hz, 1H, H_{2'}), 4.15–4.02 (m, 4H, H_{3'}, H_{4'}, H_{5'}, H_{6'}), 3.87 (bs, 1H, OH), 3.37 (m, 2H, CH₂N₃), 2.91–2.81 and 2.64–2.58 (2m, 2H, CH₂NH), 1.77–1.71 (m, 2H, CH₂), 1.47 (s, 9H, OC(CH₃)₃), 0.89 and 0.84 (2s, 18H, C(CH₃)₃), 0.09, 0.06, 0.04 and 0.03 (4s, 12H, Si(CH₃)₂); ¹³C NMR (100 MHz, CDCl₃) δ 162.8, 150.0, 141.7, 141.6, 102.1, 92.1, 84.2, 74.0, 71.9, 68.7, 64.2, 57.2, 49.4, 45.9, 29.7, 28.0, 25.8, 25.7, 18.0, 17.9, -4.3, -4.7, -4.8, -4.9; FAB HRMS (NBA): *m/e* 707.3602, $M+Na^+$ calcd for C₃₀H₅₆N₆O₈Si₂ 707.3596.

4.25. Azido alcohol 44

A solution of epoxy ester **42** (53 mg, 0.091 mmol, 1.0 equiv) in DMF (2 mL) was treated with sodium azide (11.8 mg, 0.181 mmol, 2.0 equiv) and the mixture was heated until 65°. After stirring for 3 h, the solution was allowed to reach room temperature, diluted with Et₂O (5 mL) and washed with saturated aqueous NH₄Cl solution (5 mL). The aqueous solution was extracted with Et₂O (2 × 2 mL) and the combined organic phase was washed with brine (4 mL), dried over MgSO₄ and concentrated under reduced pressure. The crude mixture was purified by flash column chromatography (silica gel, 40% EtOAc in hexanes) to provide azido alcohol **44** (47 mg, 83%) as a white solid: $R_f=0.72$ (silica gel, 50% EtOAc in hexanes); $[\alpha]_D^{22} +10.1$ (*c* 0.8, CH₂Cl₂); ¹H NMR (400 MHz, CDCl₃) δ 9.07 (bs, 1H, NH), 7.64 (d, $J=8.1$ Hz, 1H, H₆), 5.74 (d, $J=8.1, 2.1$ Hz, 1H, H₅), 5.57 (d, $J=5.9$ Hz, 1H, H_{1'}), 4.45 (dd, $J=5.9, 4.8$ Hz, 1H, H_{2'}), 4.26 (d, $J=6.4$ Hz, 1H, OH), 4.20 (bs, 1H,

H_{4'}), 4.14 (dd, $J=4.8, 2.7$ Hz, 1H, H_{3'}), 3.88–3.78 (m, 2H, H_{5'}, H_{6'}), 1.52 (s, 9H, OC(CH₃)₃), 0.89 and 0.84 (2s, 18H, C(CH₃)₃), 0.07, 0.02, and -0.03 (3s, 12H, Si(CH₃)₂); ¹³C NMR (100 MHz, CDCl₃) δ 169.2, 162.9, 150.4, 142.7, 102.5, 92.6, 84.4, 84.3, 73.4, 72.6, 70.1, 62.3, 28.0, 25.8, 25.7, 18.0, 17.9, -4.5, -4.6, -4.7, -5.0; FAB HRMS (NBA): *m/e* 650.3019, $M+Na^+$ calcd for C₂₇H₄₉N₅O₈Si₂ 650.3017.

4.26. Bromohydrine 45

A solution of epoxy amide **33** (0.19 g, 0.302 mmol, 1.0 equiv) in dry and freshly distilled acetone was cooled to -20 °C and treated with NaBr (0.127 g, 1.2 mmol, 4.0 equiv) and Amberlyst 15 (99 mg, 0.45 mmol, 1.5 equiv). The mixture was kept at -20 °C and vigorously stirred for 12 h. After that time, the mixture was filtered through a pad of Celite and washed with acetone (2 × 5 mL). The filtrates were concentrated under reduced pressure and the crude product was purified by flash column chromatography (silica gel, 50% EtOAc in hexanes) to provide bromohydrine **45** (0.214 g, 99%) as a white solid: $R_f=0.40$ (silica gel, 40% EtOAc in hexanes); $[\alpha]_D^{22} -76.0$ (*c* 0.5, CH₂Cl₂); ¹H NMR (400 MHz, CDCl₃) δ 9.25 (bs, 1H, NH), 8.22 (d, $J=8.1$ Hz, 1H, Ar), 7.86 (d, $J=8.1$ Hz, 1H, H₆), 7.22–7.18 (m, 2H, Ar), 7.07 (dd, $J=7.0, 7.0$ Hz, 1H, Ar), 5.85 (dd, $J=5.4$ Hz, 1H, H_{1'}), 5.70 (d, $J=8.1$ Hz, 1H, H₅), 4.55 (d, $J=3.2$ Hz, 1H, H_{4'}), 4.48 (d, $J=9.7$ Hz, 1H, H_{5'}), 4.39 (d, $J=9.7$ Hz, 1H, H_{6'}), 4.34–4.27 (m, 2H, H_{2'}, CH₂CH₂N indoline), 4.18 (dd, $J=3.8, 3.8$ Hz, 1H, H_{3'}), 4.09–4.01 (m, 1H, CH₂CH₂N indoline), 3.22–3.16 (m, 2H, CH₂CH₂N indoline), 0.91 and 0.85 (2s, 18H, C(CH₃)₃), 0.11, 0.09, 0.03 and -0.004 (4s, 12H, Si(CH₃)₂); ¹³C NMR (100 MHz, CDCl₃) δ 166.0, 163.3, 150.4, 142.2, 141.3, 131.7, 127.6, 125.1, 124.8, 117.7, 102.4, 89.7, 83.6, 74.7, 72.7, 71.2, 48.0, 43.3, 27.9, 25.8, 25.7, 18.0, 17.9, -4.9, -4.7, -4.6, -4.9; FAB HRMS (NBA): *m/e* 732.2117, $M+Na^+$ calcd for C₃₁H₄₈BrN₃O₇Si₂ 732.2112.

4.27. Bromohydrine 47. Oxidation of bromohydrine 45 with DMP and reduction of ketone 46 with NaBH₄

To a stirred solution of bromohydrine **45** (0.184 g, 0.259 mmol, 1.0 equiv) in CH₂Cl₂ (3 mL) was added DMP (0.226 g, 0.518 mmol, 2.0 equiv) at 0 °C. The reaction mixture was then stirred for 8 h with complete depletion of starting material according to TLC chromatography. The crude mixture was diluted with CH₂Cl₂ (10 mL) and washed with saturated aqueous NaHCO₃ solution (10 mL). The aqueous solution was extracted with CH₂Cl₂ (2 × 10 mL) and the combined organic phase was washed with brine (10 mL), dried over MgSO₄ and concentrated under reduced pressure to obtain ketone **46**, which was used in the next step without purification.

To a solution of the obtained ketone **46** (0.151 g, 0.213 mmol, 1.0 equiv) in EtOH (3 mL) was slowly added NaBH₄ (8.39 mg, 0.213 mmol, 1.0 equiv) at 0 °C. After stirring for 1 h 15 min, the reaction mixture was diluted with EtOAc (5 mL) and washed with H₂O (5 mL) and brine (5 mL). The combined organic phases were dried over MgSO₄ and concentrated in vacuo. Purification by flash column chromatography (silica gel, 30 → 50% EtOAc in

hexanes) provided pure *syn* bromohydrine **47** (56.7 mg 38%), *anti* bromohydrine **45** (7.8 mg, 5%), and a more polar fraction of unknown products (58.5 mg).

Compound [47]: White solid: $R_f=0.51$ (silica gel, 40% EtOAc in hexanes); $[\alpha]_D^{22} -75.5$ (c 1.2, CH_2Cl_2); $^1\text{H NMR}$ (400 MHz, CDCl_3) δ 8.71 (bs, 1H, NH), 8.17 (d, $J=8.1$ Hz, 1H, Ar), 7.22–7.18 (m, 2H, Ar), 7.15 (d, $J=8.1$ Hz, 1H, H_6), 7.07 (dd, $J=7.0, 7.0$ Hz, 1H, Ar), 5.66 (dd, $J=8.1, 2.2$ Hz, 1H, H_5), 5.27 (d, $J=8.1$ Hz, 1H, $\text{H}_{1'}$), 5.08 (bs, 1H, OH), 4.83 (dd, $J=8.1, 4.3$ Hz, 1H, $\text{H}_{2'}$), 4.78 (bs, 1H, $\text{H}_{4'}$), 4.35 (d, $J=4.3$ Hz, 1H, $\text{H}_{3'}$), 4.29–4.23 (m, 1H, $\text{CH}_2\text{CH}_2\text{N}$ indoline), 4.12–4.01 (m, 2H, $\text{H}_{5'}$, $\text{CH}_2\text{CH}_2\text{N}$ indoline), 3.93 (d, $J=9.1$ Hz, 1H, H_6'), 3.23–3.19 (m, 2H, $\text{CH}_2\text{CH}_2\text{N}$ indoline), 0.92 and 0.81 (2s, 18H, $\text{C}(\text{CH}_3)_3$), 0.16, 0.12, 0.01 and -0.10 (4s, 12H, $\text{Si}(\text{CH}_3)_2$); $^{13}\text{C NMR}$ (100 MHz, CDCl_3) δ 168.3, 163.1, 149.7, 144.9, 141.9, 131.9, 127.6, 124.7, 125.0, 117.8, 102.0, 96.0, 86.2, 73.3, 70.7, 70.2, 48.0, 46.2, 27.9, 25.8, 25.7, 18.0, 17.9, -4.5 , -4.6 , -4.8 , -5.3 ; FAB HRMS (NBA): m/e 732.2117, $M+\text{Na}^+$ calcd for $\text{C}_{31}\text{H}_{48}\text{BrN}_3\text{O}_7\text{Si}_2$ 732.2112.

4.28. Epoxy amide 48

Syn bromohydrine **47** (43 mg, 0.06 mmol, 1.0 equiv) was treated with a 0.1 M NaOMe solution in MeOH (1.8 mL, 0.18 mmol, 3.0 equiv) at room temperature and the mixture was stirred for 24 h. After that, the solvent was concentrated under reduced pressure and the crude product was purified by flash column chromatography (silica gel, 50% EtOAc in hexanes) to obtain *cis* epoxy amide **48** (38 mg, 99%) as a white solid: $R_f=0.30$ (silica gel, 40% EtOAc in hexanes); $[\alpha]_D^{22} +8.9$ (c 0.1, CH_2Cl_2); $^1\text{H NMR}$ (400 MHz, CDCl_3) δ 8.79 (bs, 1H, NH), 8.16 (d, $J=8.1$ Hz, 1H, Ar), 7.13 (d, $J=8.1$ Hz, 1H, H_6), 7.20–7.16 (m, 2H, Ar), 7.03 (dd, $J=7.0, 7.0$ Hz, 1H, Ar), 5.65 (dd, $J=8.1, 2.2$ Hz, 1H, H_5), 5.30 (d, $J=7.5$ Hz, 1H, $\text{H}_{1'}$), 4.95 (dd, $J=7.5, 4.3$ Hz, 1H, $\text{H}_{2'}$), 4.28 (d, $J=4.3$ Hz, 1H, $\text{H}_{3'}$), 4.17–4.07 (m, 2H, $\text{CH}_2\text{CH}_2\text{N}$ indoline), 3.86 (d, $J=8.1$ Hz, 1H, H_4'), 3.79 (d, $J=4.3$ Hz, 1H, H_6'), 3.62 (dd, $J=8.1, 4.3$ Hz, 1H, $\text{H}_{5'}$), 3.17–3.13 (m, 2H, $\text{CH}_2\text{CH}_2\text{N}$ indoline), 0.86 and 0.82 (2s, 18H, $\text{C}(\text{CH}_3)_3$), 0.1, 0.08, 0.03 and -0.05 (4s, 12H, $\text{Si}(\text{CH}_3)_2$); $^{13}\text{C NMR}$ (100 MHz, CDCl_3) δ 162.9, 149.7, 144.0, 142.3, 130.9, 127.5, 124.5, 124.3, 117.1, 102.2, 95.1, 83.1, 74.2, 71.3, 55.4, 54.4, 46.5, 28.2, 25.6, 25.5, 17.9, 17.8, -4.6 , -4.8 , -4.9 , -5.2 ; FAB HRMS (NBA): m/e 652.2847, $M+\text{Na}^+$ calcd for $\text{C}_{31}\text{H}_{47}\text{N}_3\text{O}_7\text{Si}_2$ 652.2850.

4.29. Amine 49

To a solution of Boc-Leu-OH (0.11 g, 0.48 mmol, 1.2 equiv) in CH_2Cl_2 (3 mL) was added HOBt (66 mg, 0.48 mmol, 1.2 equiv) and the mixture was stirred for 5 min. After that time, EDCI (94 mg, 0.48 mmol, 1.2 equiv) was added and the reaction mixture was stirred for 45 min at room temperature. The resulting mixture was added to a solution of *N-Z*-1,3-diaminopropane hydrochloride (0.1 g, 0.4 mmol, 1.0 equiv) in MeOH (2 mL), which was previously treated with triethylamine (0.22 mL, 1.6 mmol, 4.0 equiv) for 30 min at room temperature. The reaction mixture was stirred at room temperature for 1 h 10 min, and then, a 15% aqueous NH_3 solution (0.5 mL) was added. The mixture was diluted with ether (10 mL) and washed with a

saturated aqueous NH_4Cl solution (2×10 mL). The combined organic phases were dried over MgSO_4 and concentrated in vacuo. Purification by flash column chromatography (silica gel, 60% EtOAc in hexanes) afforded the corresponding coupling product (0.157 g, 91%) as a white solid: $R_f=0.45$ (silica gel, 60% EtOAc in hexanes); $[\alpha]_D^{22} -20.6$ (c 0.5, CH_2Cl_2); $^1\text{H NMR}$ (400 MHz, CDCl_3) δ 7.32–7.29 (m, 5H, aromatics Cbz), 6.78 (bs, 1H, NH), 5.50 (br s, 1H, NHCBz), 5.06 (bs, 2H, CH_2Ar), 5.00 (bs, 1H, NHBoc), -4.06 (bs, 1H, $\text{CHCH}_2\text{CH}(\text{CH}_3)_2$), 3.27–3.25 and 3.19–3.16 (2m, 4H, $\text{CH}_2\text{NHC}(\text{O})\text{O}$, CH_2NHCO), 1.63–1.57 (m, 5H, CH_2 , $\text{CHCH}_2\text{CH}(\text{CH}_3)_2$, $\text{CHCH}_2\text{CH}(\text{CH}_3)_2$), 1.40 (s, 9H, $\text{C}(\text{CH}_3)_3$), 0.91–0.88 (m, 6H, $\text{CH}(\text{CH}_3)_2$); $^{13}\text{C NMR}$ (100 MHz, CDCl_3) δ 173.4, 156.8, 155.8, 136.5, 128.4, 127.9, 80.1, 66.5, 53.2, 41.3, 37.3, 35.8, 29.8, 28.2, 24.7, 22.8, 21.9.

A solution of coupling product (0.113 g, 0.268 mmol, 1.0 equiv) in MeOH (3 mL) was purged with Ar. Then, a 10% Pd-C (113 mg) was added, and the mixture was allowed to be exposed to a H_2 atmosphere and stirred for 40 min. After this time, the mixture was filtered and the filtrate was washed with MeOH (2×5 mL). The combined organic solution was dried (MgSO_4), and concentrated under reduced pressure to obtain the corresponding free amine **49** (69 mg, 90%), which was used in the next step without purification.

4.30. Amino alcohol 50

Epoxy amide **48** (34 mg, 0.054 mmol, 1.0 equiv) was dissolved in MeOH (1.5 mL) and amine **49** (62 mg, 0.216 mmol, 4.0 equiv) was added. After stirring at 70°C for 14 days, the solvent was concentrated under reduced pressure and the crude product was purified by flash column chromatography (silica gel, 75% EtOAc in hexanes) to give amino alcohol **50** (34 mg, 97%) and 10 mg of starting material **[50]**: white solid: $R_f=0.29$ (silica gel, 70% EtOAc in hexanes); $[\alpha]_D^{22} +4.5$ (c 0.2, CH_2Cl_2); $^1\text{H NMR}$ (400 MHz, CDCl_3) δ 8.16 (d, $J=8.1$ Hz, 1H, Ar), 7.38 (d, $J=7.5$ Hz, 1H, H_6), 7.16–7.12 (m, 2H, Ar), 7.01 (dd, $J=7.5, 7.5$ Hz, 1H, Ar), 6.85 (bs, 1H, NHCO), 5.73 (d, $J=6.4$ Hz, 1H, $\text{H}_{1'}$), 5.52 (d, $J=7.5$ Hz, 1H, H_5), 5.00 (bs, 1H, NHBoc), 4.37–4.27 (m, 3H, $\text{H}_{3'}$, $\text{H}_{4'}$, $\text{CH}_2\text{CH}_2\text{N}$ indoline), 4.23 (br s, 1H, $\text{H}_{2'}$), 4.06–3.95 (m, 3H, $\text{H}_{5'}$, $\text{CH}_2\text{CH}_2\text{N}$ indoline, $\text{CHCH}_2\text{CH}(\text{CH}_3)_2$), 3.87 (bs, 1H, H_6'), 3.54 (bs, 1H, NH), 3.40 and 3.25 (2bs, 2H, CH_2NHCO), 3.13 (bs, 2H, $\text{CH}_2\text{CH}_2\text{N}$ indoline), 2.79 and 2.50 (2bs, 2H, CH_2NH), 1.71–1.53 (m, 4H, CH_2 , $\text{CHCH}_2\text{CH}(\text{CH}_3)_2$, $\text{CHCH}_2\text{CH}(\text{CH}_3)_2$), 1.44–1.41 (m, 1H, $\text{CHCH}_2\text{CH}(\text{CH}_3)_2$), 1.41 (s, 9H, $\text{OC}(\text{CH}_3)_3$), 0.90 and 0.77 (2s, 18H, $\text{C}(\text{CH}_3)_3$), 0.89–0.83 (m, 6H, $\text{CH}(\text{CH}_3)_2$), 0.12, -0.08 , -0.002 and -0.07 (4s, 12H, $\text{Si}(\text{CH}_3)_2$); $^{13}\text{C NMR}$ (100 MHz, CDCl_3) δ 172.5, 172.0, 162.8, 155.9, 150.2, 142.0, 141.6, 131.7, 127.4, 124.7, 124.6, 117.7, 102.3, 89.3, 86.2, 80.1, 73.4, 72.5, 71.3, 62.3, 53.0, 48.2, 45.3, 40.8, 37.3, 29.7, 28.3, 25.8, 25.6, 24.6, 22.8, 18.1, 17.8, -4.5 , -4.7 , -4.8 ; FAB HRMS (NBA): m/e 939.5065, $M+\text{Na}^+$ calcd for $\text{C}_{45}\text{H}_{76}\text{N}_6\text{O}_{10}\text{Si}_2$ 939.5059.

4.31. Amino alcohol 51

Epoxy amide **33** (52 mg, 0.083 mmol, 1.0 equiv) was dissolved in MeOH (2 mL) and amine **49** (53 mg, 0.183 mmol, 2.2 equiv) was added. The mixture was heated

until 70 °C and stirred for 4 days. After this time, the solvent was concentrated under reduced pressure and the crude product was purified by flash column chromatography (silica gel, 50% EtOAc in hexanes → 10% MeOH in CH₂Cl₂) to give amino alcohol **51** (59.1 mg, 99%) together with unreacted starting material (11 mg [**51**]): pale yellow: $R_f=0.48$ (silica gel, 10% MeOH in CH₂Cl₂); $[\alpha]_D^{25} -17.3$ (c 0.4 CH₂Cl₂); ¹H NMR (400 MHz, CDCl₃) δ 9.40 (br s, 1H, NH), 8.21 (d, $J=8.6$ Hz, 1H, Ar), 7.56 (d, $J=8.1$ Hz, 1H, H₆), 7.17–7.14 (m, 2H, Ar), 7.01 (dd, $J=7.0, 7.0$ Hz, 1H, Ar), 6.69 (bs, 1H, NHC=O), 5.66 (d, $J=8.1$ Hz, 1H, H₅), 5.53 (d, $J=5.9$ Hz, 1H, H_{1'}), 4.99 (bs, 1H, NHBoc), 4.54 (bs, 1H, H_{2'}), 4.30 (bs, 1H, H_{4'}), 4.15–4.06 (m, 4H, H_{3'}, CH₂CH₂N indoline, CHCH₂CH(CH₃)₂), 3.82 (d, $J=6.4$ Hz, 1H, H_{5'}), 3.73–3.69 (m, 1H, H_{6'}), 3.38–3.23 (m, 2H, CH₂NHCO), 3.19–3.13 (m, 2H, CH₂CH₂N indoline), 2.80–2.71 and 2.43–2.33 (2m, 2H, CH₂NH), 1.67–1.51 (m, 4H, CH₂, CHCH₂CH(CH₃)₂, CHCH₂CH(CH₃)₂), 1.42–1.38 (m, 1H, CHCH₂CH(CH₃)₂), 1.40 (s, 9H, OC(CH₃)₃), 0.91–0.81 (m, 24H, CH(CH₃)₂, C(CH₃)₃), 0.03, –0.005, –0.013 and –0.08 (4s, 12H, Si(CH₃)₂); ¹³C NMR (100 MHz, CDCl₃) δ 172.9, 171.9, 162.7, 155.9, 150.6, 143.4, 142.3, 131.4, 127.5, 124.7, 124.5, 117.5, 102.4, 93.8, 86.9, 80.1, 77.2, 73.6, 72.4, 63.0, 52.8, 48.1, 45.7, 41.4, 37.9, 29.7, 28.3, 28.0, 25.7, 25.6, 24.7, 22.9, 21.9, 18.0, 17.9, –4.6, –4.7, –5.1; FAB HRMS (NBA): m/e 939.5072, $M+Na^+$ calcd for C₄₅H₇₆N₆O₁₀Si₂ 939.5059.

Acknowledgements

This work was financially supported by Fundación Ramón Areces and the Dirección General de Investigación y Científica Técnica (Ref. BQU2001-1576). L. M. O. thanks the Dirección General de Universidades e Investigación, Consejería de Educación y Ciencia, Junta de Andalucía for a scholarship. We thank Dr. J. I. Trujillo for assistance in the preparation of this manuscript. We thank Unidad de Espectroscopía de Masas de la Universidad de Granada for exact mass spectroscopic assistance.

References and notes

- (a) Chu, D. T. W.; Plattner, J. J.; Katz, L. *J. Med. Chem.* **1996**, *39*, 3853–3874. (b) Süßmuth, R. D. *ChemBioChem* **2002**, *3*, 295–298. (c) Gao, Y. *Nat. Prod. Rep.* **2002**, *19*, 100–107. (d) Nicolaou, K. C.; Boddy, C. N. C.; Bräse, S.; Winssinger, N. *Angew. Chem., Int. Ed.* **1999**, *38*, 2096–2152.
- Kimura, K.-I.; Bugg, T. D. H. *Nat. Prod. Rep.* **2003**, *20*, 252–273.
- Bozzoli, A.; Kazmierski, W.; Kennedy, G.; Pasquarello, A.; Pecunioso, A. *Bioorg. Med. Chem. Lett.* **2000**, *10*, 2759–2763.
- Fronko, R. M.; Lee, J. C.; Galazzo, J. G.; Chamberland, S.; Malouin, F.; Lee, M. D. *J. Antibiot.* **2000**, *53*, 1405–1410.
- Chatterjee, S.; Nadkarni, S. R.; Vijayakumar, E. K. S.; Patel, M. V.; Ganguli, B. N.; Fehlhäber, H. W.; Vertesy, L. *J. Antibiot.* **1994**, *47*, 595–598.
- (a) Isono, K.; Uramoto, M.; Kusakabe, H.; Kimura, K.-I.; Izaki, K.; Nelson, C. C.; McCloskey, J. A. *J. Antibiot.* **1985**, *38*, 1617–1621. (b) Kimura, K.-I.; Kagami, S.; Ikeda, Y.; Takahashi, H.; Yoshihama, M.; Kusakabe, H.; Osada, H.; Isono, K. *J. Antibiot.* **1998**, *51*, 640–646. (c) Kimura, K.-I.; Ikeda, Y.; Kagami, S.; Yoshihama, M.; Ubukata, M.; Esumi, Y.; Osada, H.; Isono, K. *J. Antibiot.* **1998**, *51*, 647–654.
- Ochi, K.; Ezaki, M.; Iwani, M.; Komori, T.; Kohsaka, M. Ep Patent 333177, 1989.
- Igarashi, M.; Nakagawa, N.; Doi, S.; Hattori, N.; Naganawa, H.; Hamada, M. *J. Antibiot.* **2003**, *56*, 580–583.
- Struve, W. G.; Sinha, R. K.; Neuhaus, F. C.; Prime, M. S. *Biochemistry* **1966**, *5*, 82–93.
- McDonald, L. A.; Barbieri, L. R.; Carter, G. T.; Lenoy, E.; Lotvin, J.; Petersen, P. J.; Siegel, M. M.; Singh, G. Abstract of Papers, 41st Interscience Conference on Antimicrobial Agents and Chemotherapy, Chicago, IL; American Society for Microbiology: Washington, DC, 2001; Abstract 1159.
- (a) Kimura, K.-I.; Miyata, N.; Kawanishi, G.; Kamio, Y.; Izaki, K.; Isono, K. *Agric. Biol. Chem.* **1989**, *53*, 1811–1815. (b) Muroi, M.; Kimura, K.-I.; Osada, H.; Inukai, M.; Takatsuki, A. *J. Antibiot.* **1997**, *50*, 103–104. (c) Kimura, K.-I.; Ikeda, Y.; Kagami, S.; Yoshihama, M.; Suzuki, K.; Osada, H.; Isono, K. *J. Antibiot.* **1998**, *51*, 1099–1104.
- McDonald, L. A.; Barbieri, L. R.; Carter, G. T.; Lenoy, E.; Lotvin, J.; Petersen, P. J.; Siegel, M. M.; Singh, G.; Williamson, R. T. *J. Am. Chem. Soc.* **2002**, *124*, 10260–10261.
- (a) Yamashita, A.; Norton, E.; Petersen, P. J.; Rasmussen, B. A.; Singh, G.; Yang, Y.; Mansour, T. S.; Ho, D. M. *Bioorg. Med. Chem. Lett.* **2003**, *13*, 3345–3350. (b) Yamashita, A.; Norton, E. B.; Williamson, R. T.; Ho, D. M.; Sinishtaj, S.; Mansour, T. S. *Org. Lett.* **2003**, *5*, 3305–3308.
- Danishefsky, S. J.; DeNinno, S. L.; Chen, S.-H.; Boisvert, L.; Barbachyn, M. *J. Am. Chem. Soc.* **1989**, *111*, 5810–5818.
- Lin, Y.-I.; Li, Z.; Francisco, G. D.; McDonald, L. A.; Davis, R. A.; Singh, G.; Yang, Y.; Mansour, T. S.; Ho, D. M. *Bioorg. Med. Chem. Lett.* **2002**, *12*, 2341–2344.
- DeMong, D. E.; Williams, R. M. *J. Am. Chem. Soc.* **2003**, *125*, 8561–8565.
- Herr, E. B., Jr.; Redstone, M. O. *Ann. N.Y. Acad. Sci.* **1966**, *135*, 940–946.
- Sarabia, F.; Martín-Ortiz, L.; López-Herrera, F. J. *Org. Lett.* **2003**, *5*, 3927–3930.
- de Oliveira Baptista, M. J. V.; Barrett, A. G. M.; Barton, D. H. R.; Girijavallabhan, M.; Jennings, R. C.; Kelly, J.; Papadimitriou, V. J.; Turner, J. V.; Usher, N. A. *J. Chem. Soc., Perkin Trans. I* **1977**, 1477–1500.
- (a) Valpuesta-Fernández, M.; Durante Lanes, P.; López Herrera, F. J. *Tetrahedron Lett.* **1995**, *36*, 4681–4684. (b) Azzena, F.; Crotti, P.; Favero, L.; Pineschi, M. *Tetrahedron* **1995**, *51*, 13409–13422. (c) Izquierdo, I.; Plaza, M. T.; Robles, R.; Mota, A. J. *Tetrahedron: Asymmetry* **2000**, *11*, 4509–4519.
- N-Z-1,3-propanediamine* was purchased from Fluka.
- Boger, D. L.; Ledebor, M. W.; Kume, M.; Searcey, M.; Jin, Q. *J. Am. Chem. Soc.* **1999**, *121*, 11375–11383.
- Cbz-Leu-OH was purchased from NovaBiochem.
- Jones, J. *Amino acid and peptide synthesis*; Oxford University Press: New York, 1992; Oxford Chemistry Primers Series, 7.
- Nicolaou, K. C.; Zhong, Y.-L.; Baran, P. S.; Jung, J.; Choi, H.-S.; Yoon, W. H. *J. Am. Chem. Soc.* **2002**, *124*, 2202–2211.
- Johansson, R.; Samuelsson, B. *J. Chem. Soc., Perkin Trans. I* **1984**, 2371–2374.
- Sarabia, F.; Sánchez-Ruiz, A.; Chammaa, S. *Bioorg. Med. Chem.* **2005**, *13*, 1691–1705.
- Baumhof, P.; Mazitschek, R.; Giannis, A. *Angew. Chem., Int. Ed.* **2001**, *40*, 3672–3674.

29. Eppacher, S.; Solladié, N.; Bernet, B.; Vasella, A. *Helv. Chim. Acta* **2000**, *83*, 1311–1330.
30. Nomura, M.; Shuto, S.; Tanaka, M.; Sasaki, T.; Mori, S.; Shigeta, S.; Matsuda, A. *J. Med. Chem.* **1999**, *42*, 2901–2908.
31. Carboni, B.; Benalil, A.; Vaultier, M. *J. Org. Chem.* **1993**, *58*, 3736–3741.
32. Dess, D. B.; Martin, J. C. *J. Org. Chem.* **1988**, *53*, 4155–4156.
33. More, J.; Finney, N. *Org. Lett.* **2002**, *4*, 3001–3003.
34. López-Herrera, F. J.; Pino-González, M. S.; Sarabia-García, F.; Heras-López, A.; Ortega-Alcántara, J. J.; Pedraza-Cebrián, M. G. *Tetrahedron: Asymmetry* **1996**, *7*, 2065–2071.
35. (a) Armstrong, A.; Brackenridge, I.; Jackson, R.; Kirk, J. *Tetrahedron Lett.* **1988**, *29*, 2483–2486. (b) Sanière, L.; Leman, L.; Bourguignon, J. J.; Dauban, P.; Dodd, R. *Tetrahedron* **2004**, *60*, 5889–5897.
36. (a) Benedetti, F.; Norbedo, S. *Tetrahedron Lett.* **2000**, *41*, 10071–10074. (b) Dinsmore, C. J.; Mercer, S. P. *Org. Lett.* **2004**, *6*, 2885–2888.
37. Martín-Ortiz, L.; Chammaa, S.; Pino-González, M. S.; Sánchez-Ruiz, A.; García-Castro, M.; Assiego, C.; Sarabia, F. *Tetrahedron Lett.* **2004**, *45*, 9069–9072.
38. Righi, G.; Pescatore, G.; Bonadies, F.; Bonini, C. *Tetrahedron* **2001**, *57*, 5649–5656.
39. Recent synthetic studies by Matsuda et al. revealed the difficulty of the glycosylation reaction, culminating with the first total synthesis of caprazol: Hirano, S.; Ichikawa, S.; Matsuda, A. *Angew. Chem., Int. Ed.* **2005**, *44*, 1854–1856.

Reaction of (2-amino-5,10,15,20-tetraphenylporphyrinato)-nickel(II) with quinones

Cristina M. A. Alonso, Maria G. P. M. S. Neves, Augusto C. Tomé, Artur M. S. Silva and José A. S. Cavaleiro*

Department of Chemistry, University of Aveiro, 3810-193 Aveiro, Portugal

Received 21 June 2005; revised 19 September 2005; accepted 19 September 2005

Available online 6 October 2005

Abstract—(2-Amino-5,10,15,20-tetraphenylporphyrinato)nickel(II) reacts with 1,4-benzoquinone, 1,4-naphthoquinone and 2-hydroxy-1,4-naphthoquinone, in the presence of a catalytic amount of sulfuric acid, to afford new porphyrin–quinone dyads and π -extended heterocyclic-fused porphyrin derivatives.

© 2005 Elsevier Ltd. All rights reserved.

1. Introduction

Porphyrins and quinonoid compounds play important roles in Nature, mainly in respiratory and photosynthetic processes. Quinones also have a large number of industrial applications such as in the dye and photography industries, and in the new growing fields of molecular electronics and organic semiconductors.^{1–4} Porphyrins, and particularly porphyrin–quinone compounds, are important model systems for photosynthetic electron-transfer studies,^{5–9} or as anticancer agents,¹⁰ and others can be used as fluorescent chemosensors,^{11,12} or as catalysts in oxidation reactions of organic molecules.¹³

In previous publications^{14,15} we have reported the reaction of (2-amino-5,10,15,20-tetraphenylporphyrinato)nickel(II) (**1**) with α,β -unsaturated carbonyl compounds to afford pyrido[2,3-*b*]porphyrins. Now, we report the reaction of aminoporphyrin **1** with 1,4-quinones, namely 1,4-benzoquinone, 1,4-naphthoquinone and 2-hydroxy-1,4-naphthoquinone. From these reactions a range of new porphyrin–quinone dyads and π -extended heterocyclic-fused porphyrin derivatives have been obtained. In contrast to the porphyrin–quinone dyads described in the literature, which have the quinone moiety linked to the porphyrin macrocycle at a *meso*-position, in our compounds the quinone moiety is linked to a β -pyrrolic position.

Keywords: Porphyrins; Quinones; Amines; Enamines; Nenitzescu reaction.

* Corresponding author. Tel.: +351 234 370 717; fax: +351 234 370 084; e-mail: jcavaleiro@dq.ua.pt

2. Results and discussion

2.1. Reaction with 1,4-benzoquinone

It is well known that 1,4-benzoquinones react with primary enamines to afford 5-hydroxyindoles (the Nenitzescu indole synthesis).¹⁶ This type of reaction also occurs with substituted anilines,¹⁷ and with heteroaromatic amines.¹⁸ In that way, we were anticipating the formation of the indole-fused porphyrin **2** from the reaction of **1** with 1,4-benzoquinone (Scheme 1). The reaction was carried out in refluxing tetrahydrofuran in the presence of a catalytic amount of concentrated sulfuric acid. TLC analysis of the reaction mixture revealed the formation of a main product and vestigial amounts of other compounds. The main product was obtained in 65% yield after purification by preparative TLC and crystallization from dichloromethane/petroleum ether. Its spectroscopic data is consistent with the structure of the expected indole-fused porphyrin **2**. The mass spectrum (FAB⁺) shows the $[M+H]^+$ ion (m/z 776) and the ¹H NMR spectrum reveals the resonances of only six β -pyrrolic protons. The study of the HSQC spectrum showed no correlation between the signals at δ 4.15 and 7.41 ppm and any carbon atom; these signals were assigned to the resonances of the NH and OH protons, respectively. From the analysis of its ¹H NMR spectrum it was also possible to assign the resonances of the other protons of the indole moiety: H-2' appears as a doublet at δ 7.22 ($J=8.6$ Hz), H-3' appears as a double doublet at δ 6.85 ($J=2.4, 8.6$ Hz) and H-5' appears as another doublet at δ 4.81 ppm ($J=2.4$ Hz). The HMBC and ¹³C NMR spectra also validate the proposed structure. The first one shows, for instance, ²J correlation between resonances of H-2' and NH with C-1a'

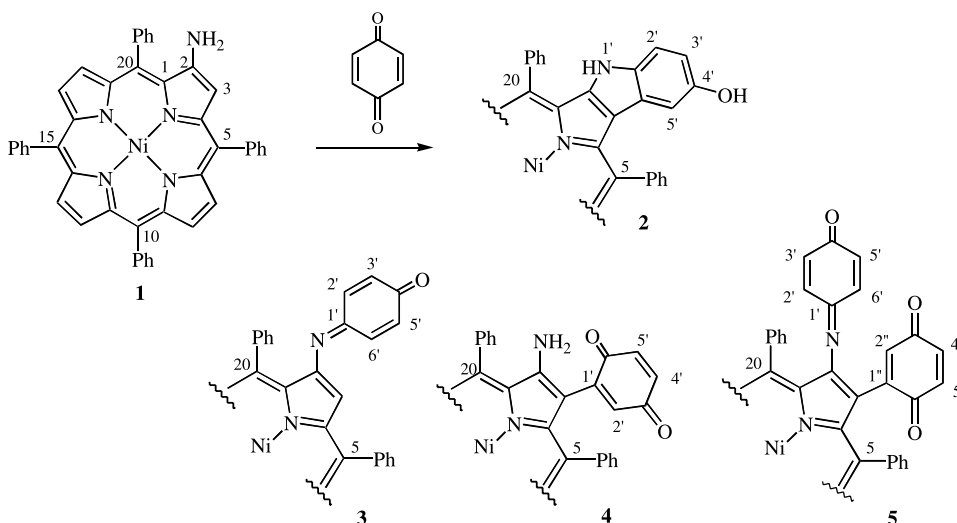

Scheme 1.

and 3J correlation of H-5' with the same carbon. The ^{13}C NMR spectrum does not show any carbonyl signal, as expected for structure 2.

In order to elucidate the structure of the minor products of the reaction between 1 and 1,4-benzoquinone, the reaction was repeated at room temperature. After 20 min, the TLC of the reaction mixture shows a complete conversion of 1 into four products (2–5, Scheme 1). These were separated by preparative TLC (silica gel): the one with higher R_f value was identified as 3 (11% yield), the next fraction was identified as 4 (4% yield), then compound 2 (54% yield) and finally compound 5 (28% yield).

The mass spectrum of the product with higher R_f value shows a peak at m/z 777 $[\text{M}+2\text{H}]^+$,¹⁹ consistent with a structure resulting from the 'addition' of a 1,4-benzoquinone unit and elimination of water. The ^1H NMR shows signals corresponding to seven β -pyrrolic protons, including a singlet at δ 7.93 ppm due to H-3. The proposed structure of the quinonimine 3 is also supported by the ^{13}C NMR spectrum: it shows the resonances of the carbon atoms from the imino and carbonyl groups at δ 155.3 and 187.9 ppm, respectively. The NOESY spectrum allowed to establish the resonances of H-2', H-3', H-5', H-6' since it shows correlations between the resonances of H-2'/H-3' and H-5'/H-6'. Quinonimines of type 3, or the corresponding *N*-(4-hydroxyphenyl)anilines,¹⁷ have already been obtained in reactions of amines with 1,4-benzoquinones.²⁰

The mass spectrum of compound 4 shows a peak at m/z 793 $[\text{M}+2\text{H}]^+$ which is consistent with the 'addition' of a 1,4-benzoquinone unit to porphyrin 1. The ^1H NMR spectrum shows a broad singlet at δ 4.37 ppm, corresponding to the NH_2 protons, and signals corresponding to six β -pyrrolic protons. This indicates that the addition occurred at a β -pyrrolic position, specifically at position 3 (the signal corresponding to H-3 is lacking in the spectrum). The ^{13}C NMR spectrum shows signals corresponding to two carbonyl groups at δ 186.6 and 187.1 ppm. A careful analysis of the COSY, HSQC and HMBC spectra allowed us to establish the resonances of protons H-2', H-4' and H-5' (δ

6.39, 6.51 and 6.59 ppm, respectively) and also the resonances of other protons and carbons of the molecule. Compound 4 is a probable intermediate in the formation of the indole-fused porphyrin 2.

The ESI mass spectrum of compound 5 shows a $[\text{M}+\text{H}]^+$ ion (m/z 882) corresponding to the 'addition' of two 1,4-benzoquinone units and elimination of water. Its ^1H NMR spectrum shows the presence of only six β -pyrrolic protons and reveals some broad shape signals, indicating steric hindrance at some parts of the molecule. The NMR spectra of compound 5 clearly indicate that it is not an indole-type compound. The ^{13}C NMR spectrum shows signals typical of carbon atoms from imino (δ 158.5 ppm) and carbonyl groups (δ 186.7, 187.2 and 187.3 ppm). Based on all these data, and by a comparative analysis with the NMR spectra of compounds 3 and 4, the structure of compound 5 is tentatively assigned as indicated in Scheme 1.

2.2. Reaction with 1,4-naphthoquinone

The reaction of 1 with 1,4-naphthoquinone also occurs at room temperature. A TLC of the reaction mixture carried out after 20 min of reaction revealed the presence of three new compounds: 6 (lower R_f), 7 and 8 (higher R_f) (Scheme 2).

The major product of this reaction (6) is analogous to compound 4 obtained in the reaction with 1,4-benzoquinone. The presence of the NH_2 protons was confirmed by HETCOR spectrum due to the lack of correlation between their resonances (δ 4.42 ppm) and any carbon. We also observed the proton exchange when the ^1H NMR spectrum was carried in the presence of D_2O . The resonance of H-2' was assigned to the singlet at δ 6.53 ppm, and the resonances of the two carbonyl groups appear in the ^{13}C NMR spectrum at δ 184.5 (C-8') and δ 184.6 ppm (C-3'). The mass spectrum showed the expected parent ion for this compound at m/z 842 $[\text{M}+\text{H}]^+$.

Initially, it was thought that compound 7 could have a similar structure as 2 (i.e., 12, Scheme 5), but this hypothesis was soon discarded on the basis of the ^{13}C

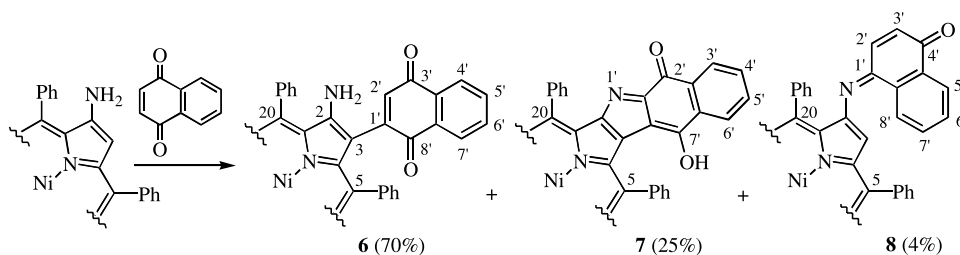

Scheme 2.

NMR and mass spectra. The signal at δ 182.8 ppm (a carbonyl group) and a peak at m/z 840 $[M+H]^+$ indicates that the cyclization reaction did not afford **12** (Scheme 5). The HSQC spectrum of compound **7** showed no correlation between the singlet at δ 7.82 ppm and any carbon; this resonance was assigned to the OH proton. The NOESY spectrum shows correlation between OH and H-6' resonances accounting to the proposed structure.

The ^1H and ^{13}C NMR spectra of compound **8** is quite similar to the ones of compound **3**. The resonance of proton H-3 appears as a singlet at δ 7.97 ppm and the protons H-2' and H-3' appear as doublets at δ 7.50 and 6.61 ppm ($J=10.4$ Hz), respectively. In the ^{13}C NMR spectrum the imine and the carbonyl carbon resonances appear at δ 153.4 and 185.8 ppm, respectively.

2.3. Reaction with 2-hydroxy-1,4-naphthoquinone

The reaction between porphyrin **1** and 2-hydroxy-1,4-naphthoquinone is much slower than the previous ones: it took 3 days at room temperature (or 10 h in refluxing tetrahydrofuran) to a complete conversion of **1** into compounds **9** (lower R_f) and **10** (higher R_f) (Scheme 3). The mass spectra of both products show a peak at m/z 842,

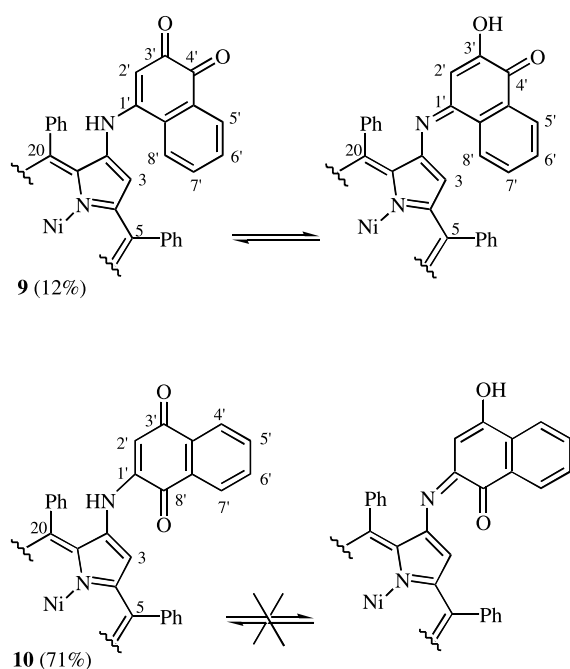

Scheme 3.

which corresponds to the 'addition' of 2-hydroxy-1,4-naphthoquinone to **1** and the loss of a water molecule. The ^1H NMR spectrum of compound **9** is relatively complex and shows that **9** exists as two tautomeric forms (ca. 3:1), the imine being the major one. On the contrary, the ^1H and ^{13}C NMR spectra of compound **10** is simpler; it indicates that this compound is not a tautomeric mixture. In the HSQC spectrum, no correlation was observed between the singlet at δ 7.87 ppm and any carbon. In the ^{13}C NMR spectrum, signals corresponding to two carbonyl groups are observed: one at δ 180.9 (C-8') and the other at δ 184.1 ppm (C-3'). These results allowed to assign the singlet at δ 7.87 ppm to the resonance of the NH proton and to exclude the imine tautomer.

2.4. Some mechanistic considerations

The products of the reactions described above show a dual behaviour of the aminoporphyrin **1**. While compound **3**, **8**, **9** and **10** are the consequence of its aromatic amine behaviour, the other products are explained by its enamine character.

The mechanism of the Nenitzescu reaction is well studied.^{21,22} Its adaptation to the reaction of aminoporphyrin **1** with 1,4-benzoquinone is shown in Scheme 4. The first step involves the conjugate addition of the amine to the quinone to give the hydroquinone-adduct **A**. This compound is then oxidized to the quinone derivative **4** by the quinone used in excess or by the intermediate **B**. Cyclization of **4**, followed by elimination of H_2O and reduction, affords the indole-fused porphyrin **2**. This final reduction step is promoted either by the hydroquinone resulting from the oxidation of intermediate **A** to **4** or by the intermediate **A** itself. It is worth to mention that the intermediates **A** and **B** were never isolated as reaction products.

The formation of compound **6** should follow an identical mechanism to the one described for the formation of **4**. However, the product resulting from the cyclization of **6** is compound **7** and not the expected compounds **11** or **12** (Scheme 5). While compound **2** results from an intramolecular 1,2-addition reaction, compound **7** results from an intramolecular 1,4-addition. Treatment of **6** with a catalytic amount of concentrated sulfuric acid gives **7**, thus confirming that **6** is an intermediate in the formation of **7**.

Both compounds **9** and **10** resulted from 1,2-additions of the amine **1** to 2-hydroxy-1,4-naphthoquinone. This is not surprising, since 2-hydroxy-1,4-naphthoquinone exists in solution in a keto-enolic equilibrium (Scheme 6). Thus, the amine nucleophilic attack can occur at the two less hindered

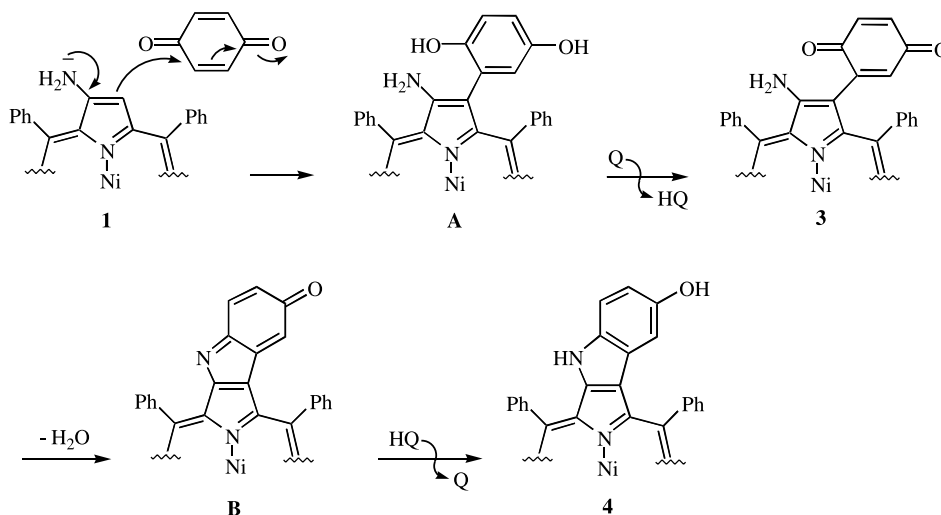

Scheme 4.

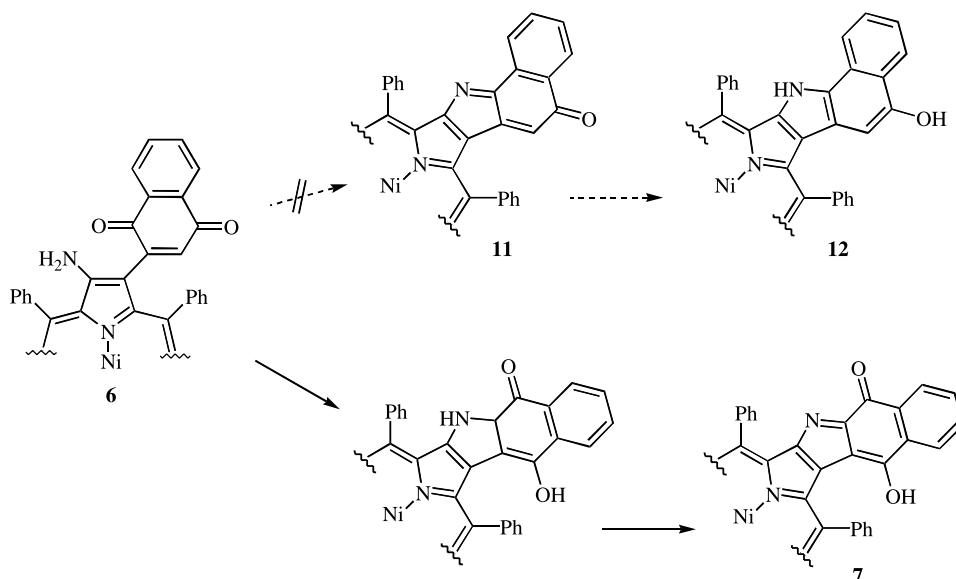

Scheme 5.

carbonyl groups C-4 and C-2 to give compounds **9** and **10**. As it is mentioned above, the analysis of the NMR spectra of both compounds revealed that only **9** exists in solution in two tautomeric forms, the imino being the major one.

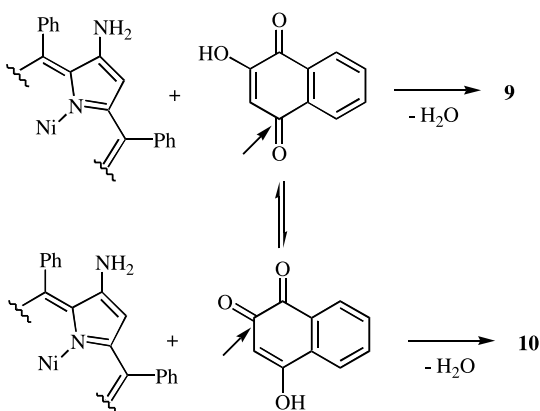

Scheme 6.

3. Conclusions

The present results show that aminoporphyrin **1** can behave as an aromatic amine or as an enamine in the reaction with quinones. The products of these reactions are porphyrin–quinone dyads and π -extended heterocyclic-fused porphyrin derivatives. Some of them are isolated in good yields. The new compounds are promising candidates for biological and electron-transfer studies.

4. Experimental

4.1. General

^1H and ^{13}C NMR spectra were recorded on Bruker AMX 300 and DRX 300 spectrometers at 300.13 and 75.47 MHz, respectively. CDCl_3 was used as solvent and TMS as internal reference; the chemical shifts are expressed in δ (ppm) and the coupling constants (J) in Hertz [Hz].

Unequivocal ^1H assignments were made using 2D COSY and NOESY experiments (mixing time of 800 ms), while ^{13}C assignments were made on the basis of 2D HETCOR (or HSQC) and HMBC experiments (delay for long-range J C/H couplings were optimized for 7 Hz). Mass spectra and HRMS were recorded on VG AutoSpec Q and M mass spectrometers using CHCl_3 as solvent and 3-nitrobenzyl alcohol (NBA) as matrix. Positive ion ESI mass spectrum was acquired using a Q-TOF 2 instrument (Micromass, Manchester, UK). The solvent system used was chloroform/methanol solution (1:1, v/v) containing 0.5% (v/v) of acetic acid. The UV-vis spectra were recorded on a UVikon spectrophotometer using CHCl_3 as solvent. Melting points were measured on a Reichert Thermovar apparatus fitted with a microscope and are uncorrected. Preparative thin-layer chromatography was carried out on 20×20 cm glass plates coated with Merck 60 silica gel (0.5 mm thick). Analytical TLC was carried out on precoated sheets with silica gel (Merck 60, 0.2 mm thick).

4.1.1. Synthesis of (2-amino-5,10,15,20-tetraphenylporphyrinato)nickel(II), 1. This compound was prepared by reduction of (2-nitro-5,10,15,20-tetraphenylporphyrinato)nickel(II) with tin powder and HCl.²³ The nitro derivative was obtained by nitration of 5,10,15,20-tetraphenylporphyrin using copper nitrate, acetic acid and acetic anhydride.²³

Reaction of (2-amino-5,10,15,20-tetraphenylporphyrinato)nickel(II) (1) with quinones. General procedure. Concentrated sulfuric acid (0.1 mL) was added to a stirred solution of **1** (23.4 mg, 0.034 mmol) and the quinone derivative (10 equiv) in THF (8 mL). The reaction mixture was allowed to stir at room temperature until all starting porphyrin was consumed (20 min for 1,4-benzoquinone and 1,4-naphthoquinone and 3 days for 2-hydroxy-1,4-naphthoquinone). Then the solution was neutralized with saturated aqueous solution of NaHCO_3 and extracted with dichloromethane. The organic layer was washed with water (3×25 mL), dried over Na_2SO_4 and evaporated under reduced pressure. The residue was dissolved in dichloromethane and the products were separated by preparative TLC using dichloromethane/petroleum ether mixtures as eluent (9:1 in the case of the reaction carried out with 1,4-benzoquinone, 2:1 in reaction with 1,4-naphthoquinone and 1:1 in the case of 2-hydroxy-1,4-naphthoquinone). The compounds were crystallized from dichloromethane/petroleum ether.

4.1.2. (4-Hydroxy-6,11,16,21-tetraphenyl-1H-indolo[2,3-b]porphyrinato)nickel(II), 2. Yield: 14.3 mg (54%) (65% yield when the reaction is carried out at reflux); mp 203–205 °C. ^1H NMR (300 MHz, CDCl_3): δ = 4.15 (s, 1H, NH), 4.81 (d, J = 2.4 Hz, 1H, H-5'), 6.85 (dd, J = 2.4, 8.6 Hz, 1H, H-3'), 7.22 (d, J = 8.6 Hz, 1H, H-2'), 7.41 (br s, 1H, OH), 7.66–7.68, 7.79–7.81 and 7.84–7.89 (3m, 12H, H-Ph-*m,p*), 7.99–8.01 and 8.04–8.08 (2m, 8H, H-Ph-*o*), 8.63 (d, J = 5.0 Hz, 1H, H- β), 8.69 (d, J = 5.0 Hz, 1H, H- β), 8.71 (d, J = 5.0 Hz, 2H, H- β), 8.76 (s, 2H, H-12,13) ppm. ^{13}C NMR (75 MHz, CDCl_3): δ = 107.2 (C-5'), 111.9 (C-2'), 112.4 (C-3'), 114.3, 115.5, 119.4, 119.7, 122.9, 125.1, 126.8, 127.7, 127.89, 127.91, 128.2, 128.5, 128.8, 129.8 (C- β), 131.4 (C- β), 131.5 (C- β), 131.7 (C- β), 132.6, 132.7 (C- β), 133.56

(C-Ph-*o*), 133.61 (C-Ph-*o*), 134.1 (C-Ph-*o*), 136.4, 136.7, 140.3, 140.7, 140.8, 141.0, 141.4, 141.9, 142.4, 142.6, 144.2, 147.6, 149.5 (C-1a') ppm. UV-vis (CHCl_3): λ_{max} ($\log \epsilon$) = 426 (5.30), 541 (4.27), 582 (4.00) nm. HRMS (FAB): m/z calcd for $\text{C}_{50}\text{H}_{32}\text{N}_5\text{ONi}$ [$\text{M} + \text{H}$]⁺ 776.1960; found 776.1924.

4.1.3. [2-(4-Oxocyclohexa-2,5-dien-1-ylidene)amino-5,10,15,20-tetraphenylporphyrinato]nickel(II), 3. Yield: 2.7 mg (11%); mp 182–184 °C. ^1H NMR (300 MHz, CDCl_3): δ = 6.49 (dd, J = 2.1, 10.2 Hz, 1H, H-5'), 6.53 (dd, J = 2.1, 10.0 Hz, 1H, H-3'), 6.76 (dd, J = 2.6, 10.0 Hz, 1H, H-2'), 7.37 (dd, J = 2.6, 10.2 Hz, 1H, H-6'), 7.48 (br t, J = 7.4 Hz, 2H, H-Ph-*o*), 7.54 (br t, J = 7.4 Hz, 1H, H-Ph-*m,p*), 7.63–7.71 (m, 11H, H-Ph-*m,p*), 7.92 (s, 1H, H-3), 7.97–8.00 (m, 6H, H-Ph-*o*), 8.67–8.73 (m, 4H, H- β), 8.71 (s, 2H, H-12,13) ppm. ^{13}C NMR (75 MHz, CDCl_3): δ = 118.2 (C-3), 118.5, 118.6, 119.1, 119.7, 126.88, 126.94, 127.0, 127.8, 127.9, 128.0, 128.2 (C-6'), 131.7 (C-3'), 132.0, 132.1, 132.3, 132.6, 132.7, 133.0, 133.5 (C-5'), 133.59, 133.61, 133.64, 135.6, 140.39, 140.47, 140.55, 140.64, 141.6 (C-2'), 142.7, 143.0, 143.1, 143.5, 152.5 (C-2), 155.3 (C-1'), 187.9 (C-4') ppm. UV-vis (CHCl_3): λ_{max} ($\log \epsilon$) = 412 (5.28), 530 (4.29), 617 (3.96) nm. HRMS (FAB): m/z calcd for $\text{C}_{50}\text{H}_{33}\text{N}_5\text{ONi}$ [$\text{M} + 2\text{H}$]⁺ 777.2038; found 777.2074.

4.1.4. [2-Amino-3-(3,6-dioxocyclohexa-1,4-dien-1-yl)-5,10,15,20-tetraphenylporphyrinato]nickel(II), 4. Yield: 1.1 mg (4%); mp 151–153 °C. ^1H NMR (300 MHz, CDCl_3): δ = 4.37 (br s, 2H, NH_2), 6.39 (d, J = 2.5 Hz, 1H, H-2'), 6.51 (dd, J = 2.5, 10.1 Hz, 1H, H-4'), 6.59 (d, J = 10.1 Hz, 1H, H-5'), 7.39–7.42 and 7.61–7.73 (2m, 12H, H-Ph-*m,p*), 7.95–8.00 (m, 8H, H-Ph-*o*), 8.32 (d, J = 4.9 Hz, 1H, H- β), 8.56 (d, J = 4.9 Hz, 1H, H- β), 8.60–8.62 (m, 3H, H- β), 8.68 (d, J = 4.9 Hz, 1H, H- β) ppm. ^{13}C NMR (75 MHz, CDCl_3): δ = 113.5 (C-3), 114.4, 116.1, 118.8, 120.3, 126.9, 127.3, 127.7, 127.8, 128.0, 128.2, 128.4, 128.5, 128.8, 130.9, 131.0, 131.3, 131.6, 131.9, 132.4, 132.6, 133.5, 133.7, 135.0 (C-2'), 135.5 (C-4'), 136.9 (C-5'), 139.1, 140.4, 140.9, 141.1, 141.5, 141.9, 142.8, 143.0, 143.6 (C-1'), 144.4, 151.4, 186.6 (C-6'), 187.1 (C-3') ppm. UV-vis (CHCl_3): λ_{max} ($\log \epsilon$) = 415 (5.30), 539 (4.18) nm. HRMS (FAB): m/z calcd for $\text{C}_{50}\text{H}_{33}\text{N}_5\text{O}_2\text{Ni}$ [$\text{M} + 2\text{H}$]⁺ 793.1988; found 793.2018.

4.1.5. {2-(3,6-Dioxocyclohexa-1,4-dien-1-yl)-3-[(4-oxocyclohexa-2,5-dien-1-ylidene)amino]-5,10,15,20-tetraphenylporphyrinato}nickel(II), 5. Yield: 8.3 mg (28%); mp 129–131 °C. ^1H NMR (300 MHz, CDCl_3): δ = 6.10–6.21 (br m, 1H, H-3'/H-5'), 6.40 (dd, J = 2.2, 10.0 Hz, 1H, H-3'/H-5'), 6.44–6.51 (br m, 3H, H-2'', H-4'', H-5''), 6.52–6.62 (br m, 1H, H-2'/H-6'), 6.71 (dd, J = 2.4, 10.1 Hz, 1H, H-2'/H-6'), 7.37–7.45 (m, 4H, H-Ph), 7.50 (br t, J = 7.1 Hz, 2H, H-Ph), 7.64–7.73 (m, 9H, H-Ph-*m,p*), 7.97–8.06 (m, 5H, H-Ph-*o*), 8.49–8.50 (m, 1H, H- β), 8.57 (d, J = 5.0 Hz, 1H, H- β), 8.65 (d, J = 5.0 Hz, 2H, H- β), 8.71 and 8.72 (AB, J = 5.0 Hz, 2H, H-12,13) ppm. ^{13}C NMR (75 MHz, CDCl_3): δ = 116.9, 118.0, 119.3, 119.9, 127.0, 127.3, 127.9, 128.4, 128.5, 129.3 (C-2'/C-6'), 132.3 and 132.4 (C-3' and C-5'), 132.5, 132.5, 132.8, 133.5, 133.6, 134.7, 135.5 (C-2''/C-4'' or C-5''), 136.2 (C-2''/C-4'' or C-5''), 136.6 (C-2''/C-4'' or C-5''), 138.9, 139.7, 140.1, 140.5 (C-2'/C-6'), 142.7, 142.9, 143.2,

143.4, 143.5, 152.8 (C-2), 158.5 (C-1'), 186.7 (C=O), 187.2 (C=O), 187.3 (C=O) ppm. UV-vis (CHCl₃): λ_{\max} (log ϵ) = 416 (5.29), 536 (4.18) nm. C₅₆H₃₃N₅O₃Ni · 1/3H₂O: calcd C 75.69, H 3.82, N 7.88; found C 75.59, H 3.53, N 7.77. MS (ESI): m/z 882 [M+H]⁺.

4.1.6. [2-Amino-3-(1,4-dioxo-1,4-dihydronaphthalen-2-yl)-5,10,15,20-tetraphenylporphyrinato]nickel(II), 6. Yield: 20.0 mg (70%); mp 278–280 °C. ¹H NMR (300 MHz, CDCl₃): δ = 4.42 (s, 2H, NH₂), 6.53 (s, 1H, H-2'), 6.91–6.97 (m, 1H, H-6'), 7.63–7.76 (m, 15H, H-Ph-*m,p* and H-4', 5', 7'), 7.97–8.02 (m, 8H, H-Ph-*o*), 8.41 (d, J = 5.0 Hz, 1H, H- β), 8.56 (d, J = 5.0 Hz, 1H, H- β), 8.60 (d, J = 5.0 Hz, 1H, H- β), 8.61 (d, J = 5.0 Hz, 1H, H- β), 8.62 (d, J = 5.0 Hz, 1H, H- β), 8.68 (d, J = 5.0 Hz, 1H, H- β) ppm. ¹³C NMR (75 MHz, CDCl₃): δ = 114.4 (C-3), 114.6, 116.1, 118.8, 125.6, 126.6, 126.9, 127.1, 127.4 (C-7'), 127.7, 127.8, 128.4, 128.8, 131.0, 131.2, 131.3, 131.6, 131.8 (C-3a'), 132.0, 132.6, 133.3, 133.5, 133.6, 133.7, 137.7 (C-2'), 138.6, 139.2, 140.5, 141.1, 141.5, 141.9, 142.2, 142.9, 143.0, 144.4, 145.5, 151.5, 184.5 (C-8'), 184.6 (C-3') ppm. UV-vis (CHCl₃): λ_{\max} (log ϵ) = 414 (5.22), 540 (4.09) nm. HRMS (FAB): m/z calcd for C₅₄H₃₄N₅O₂Ni [M+H]⁺ 842.2066; found 842.2069.

4.1.7. (7-Hydroxy-2-oxo-8,13,18,23-tetraphenyl-benzo-[f]indolo[2,3-b]porphyrinato)nickel(II), 7. Yield: 7.1 mg (25%); mp 235–237 °C. ¹H NMR (300 MHz, CDCl₃): δ = 6.96 (br d, J = 7.6 Hz, 1H, H-6'), 7.38 (dt, J = 0.6, 7.6 Hz, 1H, H-4'), 7.61 (dt, J = 1.3, 7.6 Hz, 1H, H-5'), 7.64–7.71 (m, 9H, H-Ph-*m,p*), 7.82 (br s, 1H, OH), 7.93–8.08 (m, 10H, H-Ph-*o,m,p* and H-3'), 8.14–8.17 (m, 2H, H-Ph-*o*), 8.40 (d, J = 4.9 Hz, 1H, H- β), 8.62 (d, J = 4.9 Hz, 1H, H- β), 8.68 (d, J = 4.9 Hz, 1H, H- β), 8.72 (d, J = 4.9 Hz, 1H, H- β), 8.73 (d, J = 4.9 Hz, 1H, H- β), 8.84 (d, J = 4.9 Hz, 1H, H- β) ppm. ¹³C NMR (75 MHz, CDCl₃): δ = 112.9, 117.1, 119.6, 119.8, 120.2, 120.5 (C-6'), 127.0, 127.0, 127.7, 127.8, 128.0, 128.7, 128.9, 129.2 (C-4'), 130.1, 130.2, 130.4, 130.5, 130.9, 131.7 (C- β), 132.1 (C- β), 132.4 (C- β), 132.9 (C- β), 133.0 (C- β), 133.2, 133.6, 133.7, 133.8, 134.1, 134.9 (C-5'), 140.3, 140.4, 141.0, 141.7, 141.8, 141.9, 141.9, 142.3, 142.7, 143.6, 145.7, 173.9 (C-7'), 182.8 (C-2') ppm. UV-vis (CHCl₃): λ_{\max} (log ϵ) = 421 (5.33), 545 (4.34) nm. HRMS (FAB): m/z calcd for C₅₄H₃₁N₅O₂Ni [M+H]⁺ 840.1910; found 840.1895.

4.1.8. [2-(4-Oxonaphthalen-1-ylidene)amino-5,10,15,20-tetraphenylporphyrinato]nickel(II), 8. Yield: 1.1 mg (4%); mp 222–224 °C. ¹H NMR (300 MHz, CDCl₃): δ = 6.61 (d, J = 10.4 Hz, 1H, H-3'), 7.08 (t, J = 7.5 Hz, 1H, H-Ph-*p*), 7.30 (t, J = 7.7 Hz, 2H, H-Ph-*m*), 7.50 (d, J = 10.4 Hz, 1H, H-2'), 7.60–7.75 (m, 13H, H-Ph-*o,m,p*, H-6' and H-7'), 7.92–7.95 (m, 1H, H-8'), 7.97 (s, 1H, H-3), 7.98–8.02 (m, 6H, H-Ph-*o*), 8.09–8.12 (m, 1H, H-5'), 8.61 (d, J = 5.0 Hz, 1H, H- β), 8.67 (d, J = 5.0 Hz, 1H, H- β), 8.69 (d, J = 5.0 Hz, 1H, H- β), 8.72–8.74 (m, 3H, H- β) ppm. ¹³C NMR (75 MHz, CDCl₃): δ = 118.0, 118.3 (C-3), 118.5, 119.0, 119.7, 125.6 (C-5'), 126.3 (C-8'), 126.9, 127.0 (C-Ph-*m*), 127.4 (C-Ph-*o*), 127.8, 130.6 (C-2'), 130.9, 131.0, 131.9, 132.0, 132.1, 132.2, 132.3, 132.7 (C-Ph-*o*), 133.6, 133.7, 133.8 (C-3'), 134.4, 135.2, 140.0, 140.6, 140.9, 142.3, 142.4, 142.7, 142.9, 143.6, 153.1 (C-2), 153.4 (C-1'), 185.8 (C-4') ppm. UV-vis (CHCl₃): λ_{\max} (log ϵ) = 414 (5.13), 532

(4.14) nm. HRMS (FAB): m/z calcd for C₅₄H₃₅N₅ONi [M+2H]⁺ 827.2195; found 827.2172.

4.1.9. [2-(3-Hydroxy-4-oxonaphthalen-1-ylidene)amino-5,10,15,20-tetraphenylporphyrinato]nickel(II), 9. Yield: 3.4 mg (12%); mp 90–93 °C. ¹H NMR (300 MHz, CDCl₃): δ = imine: 6.84 (s, 1H, H-2'), 7.03 (br t, J = 7.5 Hz, 1H, H-Ph-*p*), 7.97 (s, 1H, H-3), 8.22–8.15 (m, 1H, H-5'), 8.58 (d, J = 4.9 Hz, 1H, H- β), enamine: 6.59 (s, 1H, H-2'), 6.73 (br d, J = 7.6 Hz, 1H, H-8'), 8.21 (dd, J = 1.5, 7.5 Hz, 1H, H-5'), 8.50 (d, J = 5.0 Hz, 1H, H- β), remaining signals: 7.46–7.76 (m, 29H, H-Ph-*o,m,p*, H-6', H-7'), 7.97–8.03 (m, 15H, H-Ph-*o*, H-3), 8.65–8.74 (m, 10H, H- β) ppm. UV-vis (CHCl₃): λ_{\max} (log ϵ) = 415 (5.49), 533 (4.53), 589 (4.22) nm. HRMS (FAB): m/z calcd for C₅₄H₃₄N₅O₂Ni [M+H]⁺ 842.2066; found 842.2042.

4.1.10. {2-[(1,4-Dioxo-1,4-dihydronaphthalen-2-yl)amino]-5,10,15,20-tetraphenylporphyrinato}nickel(II), 10. Yield: 20.3 mg (71%); mp: 272–274 °C. ¹H NMR (300 MHz, CDCl₃): δ = 6.60 (s, 1H, H-2'), 7.64–7.70 (m, 13H, H-Ph-*m,p* and H-6'), 7.75 (dt, J = 1.1, 7.6 Hz, 1H, H-5'), 7.87 (br s, 1H, NH), 7.90–7.92 and 7.96–7.99 (2m, 8H, H-Ph-*o*), 8.03 (dd, J = 1.1, 7.6 Hz, 1H, H-7'), 8.09 (dd, J = 1.1, 7.6 Hz, 1H, H-4'), 8.54 (d, J = 5.0 Hz, 1H, H- β), 8.57 (s, 1H, H-3), 8.65 (d, J = 5.0 Hz, 1H, H- β), 8.66 (d, J = 5.0 Hz, 1H, H- β), 8.70–8.72 (m, 3H, H- β) ppm. ¹³C NMR (75 MHz, CDCl₃): δ = 104.3 (C-2'), 116.6, 118.4, 119.1, 119.8, 122.2 (C-3), 126.1 (C-4'), 126.4 (C-7'), 126.9, 127.2, 127.8, 128.1, 128.2, 129.0, 130.2 (C-7a'), 132.0, 132.1, 132.2, 132.3 (C-3a'), 132.4, 132.6, 132.9, 133.3, 133.5, 133.6, 133.7, 134.6 (C-5'), 139.0, 139.4, 140.3, 140.4, 140.5, 142.4, 142.6, 142.7, 142.9, 143.0, 143.4, 143.9 (C-1'), 180.9 (C-8'), 184.1 (C-3') ppm. UV-vis (CHCl₃): λ_{\max} (log ϵ) = 415 (5.21), 535 (4.30), 590 (4.15) nm. HRMS (FAB): m/z calcd for C₅₄H₃₂N₅O₂Ni [M+H]⁺ 842.2066; found 842.2056.

Acknowledgements

Thanks are due to the University of Aveiro, to Fundação para a Ciência e a Tecnologia and FEDER for funding the Organic Chemistry Research Unit and Project POCTI/QUI/32851/1999. C. M. A. Alonso thanks FCT for a postdoctoral grant.

References and notes

- Laird, T. In Barton, D., Ollis, W. D., Eds.; Comprehensive Organic Chemistry; Pergamon: Oxford, 1979; Vol. 1, pp 1213–1227.
- Bittner, S.; Meenakshi, C.; Temtsin, G. *Tetrahedron* **2001**, *57*, 7423–7429.
- Jozefiak, T. H.; Miller, L. L. *J. Am. Chem. Soc.* **1987**, *109*, 6560–6561.
- Almlöf, J. E.; Feyereisen, M. W.; Jozefiak, T. H.; Miller, L. L. *J. Am. Chem. Soc.* **1990**, *112*, 1206–1214.
- Gust, D.; Moore, T. In Kadish, K. M., Smith, K. M., Guillard,

- R., Eds.; *The Porphyrin Handbook*; Academic: San Diego, 2000; Vol. 8, pp 153–190.
- (a) Wasielewski, M. R. *Chem. Rev.* **1992**, *92*, 435–461. (b) Kurreck, H.; Huber, M. *Angew. Chem., Int. Ed. Engl.* **1995**, *34*, 849–866. (c) Huber, M. *Eur. J. Org. Chem.* **2001**, 4379–4389.
 - (a) Shi, X.; Amin, R.; Liebeskind, L. S. *J. Org. Chem.* **2000**, *65*, 1650–1664. (b) Shi, X.; Liebeskind, L. S. *J. Org. Chem.* **2000**, *65*, 1665–1671.
 - (a) Speck, M.; Kurreck, H.; Senge, M. O. *Eur. J. Org. Chem.* **2000**, 2303–2314. (b) Wiehe, A.; Senge, M. O.; Schäfer, A.; Speck, M.; Tannert, S.; Kurreck, H.; Röder, B. *Tetrahedron* **2001**, *57*, 10089–10110.
 - (a) Springer, J.; Kodis, G.; Garza, L.; Moore, A. L.; Moore, T. A.; Gust, D. *J. Phys. Chem. A* **2003**, *107*, 3567–3575. (b) Kang, Y. K.; Rubtsov, I. V.; Iovine, P. M.; Chen, J.; Therien, M. J. *J. Am. Chem. Soc.* **2002**, *124*, 8275–8279.
 - Mehta, G.; Muthusamy, S.; Maiya, B. G.; Arounagui, S. *Tetrahedron Lett.* **1997**, *38*, 7125–7128.
 - Okamoto, K.; Fukuzumi, S. *J. Am. Chem. Soc.* **2004**, *126*, 13922–13923.
 - (a) D'Souza, F.; Deviprasad, G. R. *J. Org. Chem.* **2001**, *66*, 4601–4609. (b) D'Souza, F.; Deviprasad, G. R.; Hsieh, Y.-Y. *Chem. Commun.* **1997**, 533–534.
 - Grennberg, H.; Faizon, S.; Bäckvall, J. E. *Angew. Chem., Int. Ed. Engl.* **1993**, *32*, 263–264.
 - Alonso, C. M. A.; Neves, M. G. P. M. S.; Silva, A. M. S.; Cavaleiro, J. A. S.; Hombrecher, H. K. *Tetrahedron Lett.* **1997**, *38*, 2753–2756.
 - Lüdtke, K.; Alonso, C. M. A.; Neves, M. G. P. M. S.; Silva, A. M. S.; Cavaleiro, J. A. S.; Hombrecher, H. K. *Heterocycl. Commun.* **1997**, *3*, 503–506.
 - (a) Nenitzescu, C. D. *Bull. Soc. Chim. Romania* **1929**, *11*, 37. *Chem. Abstr.*, **1930**, *24*, 110. (b) Allen, G. R., Jr.; Pidacks, C.; Weiss, M. J. *J. Am. Chem. Soc.* **1966**, *88*, 2536–2544. (c) Littell, R.; Morton, G. O.; Allen, G. R., Jr. *J. Am. Chem. Soc.* **1970**, *92*, 3740–3746. (d) Ketcha, D. M.; Wilson, L. J.; Portlock, D. E. *Tetrahedron Lett.* **2000**, *41*, 6253–6257.
 - Bernier, J. L.; Hénichart, J. P.; Vaccher, C.; Houssin, R. *J. Org. Chem.* **1980**, *45*, 1493–1496.
 - (a) Bernier, J. L.; Hénichart, J. P. *J. Org. Chem.* **1981**, *46*, 4197–4198. (b) Dotzauer, B.; Troschütz, R. *Synlett* **2004**, 1039–1043.
 - The formation of $[M+2H]^+$ ions in the mass spectra of porphyrins has already been discussed: (a) Domingues, M. R. M.; Santana-Marques, M. G. O.; Domingues, P.; Faustino, M. A.; Neves, M. G. P. M. S.; Cavaleiro, J. A. S.; Ferrer-Correia, A. J. *Rapid Commun. Mass Spectrom.* **2000**, *14*, 2025–2029. (b) Musselman, B. D.; Watson, J. T.; Chang, C. K. *Org. Mass Spectrom.* **1986**, *21*, 215–219.
 - Figueras, J.; Scullard, P. W.; Mack, A. R. *J. Org. Chem.* **1971**, *36*, 3497–3501.
 - Kuckländer, U. *Tetrahedron* **1972**, *28*, 5251–5259.
 - Patrick, J. B.; Saunders, E. K. *Tetrahedron Lett.* **1979**, 4009–4012.
 - Hombrecher, H. K.; Gherdan, V. M.; Ohm, S.; Cavaleiro, J. A. S.; Neves, M. G. P. M. S.; Condesso, M. F. *Tetrahedron* **1993**, *49*, 8569–8578.

Synthesis and solvent dependence of the photophysical properties of [60]fullerene–sugar conjugates

Roger F. Enes,^a Augusto C. Tomé,^{a,*} José A. S. Cavaleiro,^a Ali El-Agamey^{b,†}
and David J. McGarvey^{b,*}

^aDepartment of Chemistry, University of Aveiro, 3810-193 Aveiro, Portugal

^bLennard-Jones Laboratories, School of Chemistry and Physics, Keele University, Keele, Staffordshire, ST5 5BG, UK

Received 6 May 2005; revised 18 July 2005; accepted 19 September 2005

Available online 18 October 2005

Abstract—A method for the synthesis of optically pure C₆₀ derivatives containing one or two D-galactose or D-glucose units is described. It involves the synthesis of sugar–malonate derivatives followed by a cyclopropanation reaction with C₆₀. The solvent dependence of the photophysical properties of the methano[60]fullerene–sugar derivatives was studied using nanosecond laser flash photolysis coupled with kinetic UV–vis absorption spectroscopy and time-resolved singlet oxygen luminescence measurements. The triplet properties of these fullerenes, including transient absorption spectra, molar absorption coefficients and quantum yield for the photosensitised production of ¹O₂ were determined in toluene, benzonitrile and acetonitrile solutions. The transient absorption spectral profiles are solvent independent although small differences are observed in the transient absorption maximum: 720 ± 5 nm for toluene, 710 ± 5 nm for benzonitrile and 700 ± 5 nm for acetonitrile. Triplet state molar absorption coefficients (ε_T) of C₆₀ derivatives vary from 9456 ± 2090 M⁻¹ cm⁻¹, for compound **10** in toluene, and 15,272 ± 4462 M⁻¹ cm⁻¹, for compound **6** in acetonitrile. Triplet state lifetimes (τ_T) for methano[60]fullerene–sugar derivatives, under our experimental conditions, are similar in toluene or benzonitrile solutions (47.5 ± 1.1 μs ≤ τ_T ≤ 51.4 ± 2.0 μs) but are lower in acetonitrile solutions (31.8 ± 0.6 μs ≤ τ_T ≤ 43.0 ± 1.1 μs). Toluene and benzonitrile solutions of C₆₀ derivatives have Φ_Δ close to unity.

© 2005 Elsevier Ltd. All rights reserved.

1. Introduction

Since their discovery, fullerenes and their organic derivatives have attracted great attention, mainly due to their potential utility in medicinal chemistry and materials science.^{1–7} A very important property of fullerenes is their high capacity to generate singlet oxygen upon photoirradiation, even in aqueous media.⁸ Several photodynamic studies with fullerenes indicated their potential importance in medicine.^{9,10} The synthesis of fullerene derivatives soluble in aqueous systems has been a prerequisite condition for attaining their efficiency in biological systems. To overcome the problem of the low solubility of C₆₀, chemists have functionalised C₆₀ with hydrophilic groups.^{11–14} However, this functionalisation can lead to fullerene aggregation. Photophysical studies can provide useful

information in relation to dimerisation or aggregation of molecules.¹⁵ In particular, the decrease of singlet oxygen and/or triplet quantum yields has been linked to aggregation in the case of aromatic hydrocarbons,¹⁶ porphyrins^{17,18} and fullerenes.^{17–19} Attachment of a sugar moiety to C₆₀ may improve its water solubility and, since the carbohydrates play an important role in cellular recognition, cellular transport and adhesion phenomena,^{20,21} compounds with higher selectivity and activity may be obtained in that way. Several C₆₀-sugar conjugates have been prepared by different approaches, namely by reacting C₆₀ with glycosylidene carbenes,²² glycosyl azides^{23–25} or glycosyl azomethine ylides²⁶ or by alkylation of a C₆₀-pentathiolate with 2-bromoethyl glycosides.²⁷ Studies on the sugar-dependent phototoxicity of C₆₀-sugar derivatives were reported recently.²⁵

Following our studies on the synthesis of potential biologically active C₆₀ derivatives,^{28,29} we report here a simple method for the synthesis of C₆₀ glycoconjugates. The new compounds, containing one or two units of a monosaccharide, were prepared from commercially available D-galactose and D-glucose derivatives via

Keywords: Fullerenes; Sugars; Malonates; Cyclopropanation; Singlet oxygen; Laser flash photolysis.

* Corresponding authors. Tel.: +351 234 370 712; fax: +351 234 370 084 (A.C.T.); e-mail addresses: actome@dq.ua.pt; d.j.mcgarvey@chem.keele.ac.uk

† Permanent address: Chemistry Department, Faculty of Science, New Damietta, Damietta, Egypt.

cyclopropanation reactions of C_{60} . Unlike some of the routes to fullerene–sugar derivatives already published, our method gives isomerically pure compounds.

We also present and compare the photophysical properties of both singlet and triplet states of the C_{60} glycoconjugates in solvents of varying polarity (toluene, benzonitrile and acetonitrile). In addition, we have also determined values for the singlet oxygen quantum yields (Φ_{Δ}) of the new fullerenes in toluene and benzonitrile.

2. Results and discussion

2.1. Synthesis of the C_{60} derivatives

Galactosyl malonates **2** and **5** were obtained from the reaction of 1,2:3,4-di-*O*-isopropylidene-D-galactopyranose

1 with methyl 3-chloro-3-oxopropanoate and malonyl dichloride, respectively. These malonates were covalently linked to C_{60} via a cyclopropanation reaction induced by I_2 in the presence of DBU, at room temperature, to yield the conjugates **3** and **6**, respectively (Scheme 1). These compounds were purified by flash chromatography (silica gel) using toluene (for **3**) or toluene/ethyl acetate 95:5 (for **6**) as the eluent and then were crystallized from chloroform/methanol yielding black solids. Deprotection of the hydroxyl groups in dyad **3** with trifluoroacetic acid afforded a quantitative yield of dyad **4** (a mixture of the α and β anomers). Under similar reaction conditions, deprotection of the hydroxyl groups in compound **6** led to a solid insoluble both in water and in organic solvents. The lack of solubility of that product prevented its structural characterization.

The C_{60} -glucosyl derivatives **10** and **12** were prepared as described in Scheme 2. The first step involved the synthesis

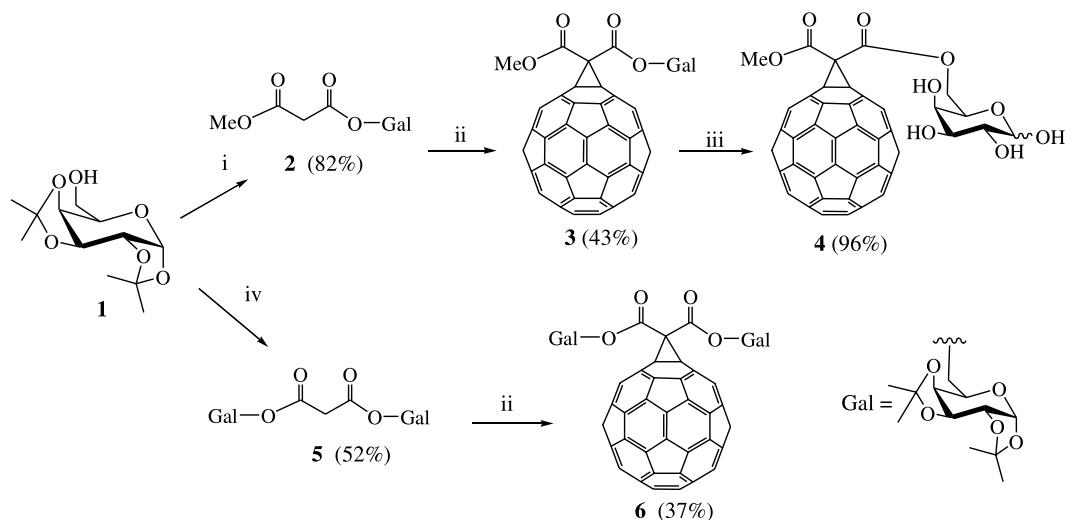

Scheme 1. Reagents and conditions: (i) $ClCOCH_2COOMe$, NEt_3 , CH_2Cl_2 , $0^\circ C$ to rt, 5 h; (ii) C_{60} , I_2 , DBU, toluene, rt, 8 h; (iii) $CHCl_3/CF_3CO_2H/H_2O$, rt, 14 h; (iv) $ClCOCH_2COCl$, NEt_3 , rt.

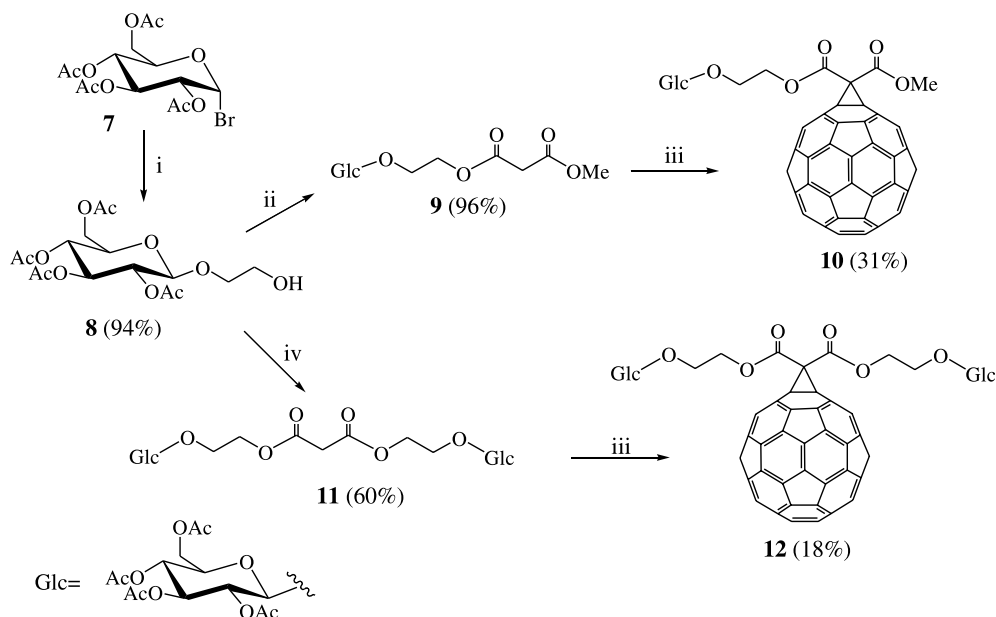

Scheme 2. Reagents and conditions: (i) $HOCH_2CH_2OH$, CH_2Cl_2 , Ag_2CO_3 , NEt_3 , rt; (ii) $ClCOCH_2CO_2Me$, NEt_3 , rt; (iii) C_{60} , I_2 , DBU, rt; (iv) $ClCOCH_2COCl$, NEt_3 , rt.

of glycoside **8**, obtained from the reaction of 2,3,4,6-tetra-*O*-acetyl- α -D-glucopyranosyl bromide **7** with 1,2-ethanediol in the presence of silver carbonate and triethylamine.³⁰ The 2-hydroxyethyl spacer introduced into compound **8** allowed the synthesis of malonates **9** and **11**, as described above. These malonates were then linked to C₆₀ by cyclopropanation reactions, as described above, to afford the glycoconjugates **10** and **12**.

The C₆₀ glycoconjugates were characterized by ¹H and ¹³C NMR, MS and UV–vis. The proton and carbon resonances of the sugar moieties are concordant with the data reported in the literature.^{31–34} The chemical shifts and coupling constants corresponding to the protons of the sugar moiety of compounds **2** and **3** are provided in Table 1. The values are in agreement with the coupling constants calculated for the minimum energy conformation of 1,2:3,4-di-*O*-isopropylidene- α -D-galactopyranosyl **1**.³⁵ There is a great similarity between the chemical shifts (and coupling constants) of the resonances corresponding to the protons of the galactosyl moiety in compounds **2** and **3**. The bigger differences are observed for protons H-5, H-6 and H-6' (Table 1), which are deshielded in compound **3** due to close proximity to the fullerene moiety.

Table 1. ¹H chemical shifts and coupling constants, in CDCl₃, of the galactose protons in compounds **2** and **3**

Proton	2		3	
	δ (ppm)	J (Hz)	δ (ppm)	J (Hz)
H-1	5.53	$J_{1,2}$ 5.0	5.60	$J_{1,2}$ 5.0
H-2	4.33	$J_{2,3}$ 2.5	4.38	$J_{2,3}$ 2.5
H-3	4.63	$J_{3,4}$ 7.9	4.67	$J_{3,4}$ 7.8
H-4	4.24	$J_{4,5}$ 2.1	4.32	$J_{4,5}$ 1.9
H-5	4.04	$J_{5,6}$ 7.3	4.26	$J_{5,6}$ 6.2
H-6	4.26	$J_{5,6'}$ 4.8	^a	$J_{5,6'}$ 6.2
H-6'	4.36	$J_{6,6'}$ 11.5	^a	^b

^a Multiplet at 4.64–4.69 ppm.

^b Unresolved.

In the ¹H NMR spectrum of dyad **4**, the doublet corresponding to H-1 in the α anomer appears at δ 5.28 ppm with a coupling constant equal to 3.4 Hz, characteristic of an axial–equatorial coupling, while for the β anomer it appears at δ 4.50 ppm with a coupling constant equal to 7.3 Hz, typical of an axial–axial coupling.

The FAB⁺ mass spectra of all C₆₀-sugar derivatives show the corresponding [M+H]⁺ ion. Their UV–vis spectra, in toluene, show a strong band at 330 nm, a sharp band at 428 nm, a broad band at 493 nm and a weak band at 690 nm. These bands are typical of methano[60]fullerene derivatives.^{36–38}

2.2. Photophysical studies

2.2.1. T–T absorption spectra and triplet molar absorption coefficients at λ_{\max} . Laser (355 nm) excitation of solutions of the fullerene derivatives give rise to transient absorption features in the visible and near infra-red regions. The transient absorption spectra of derivative **10** in the three

different solvents used are shown in Figure 1. It is clear that the spectral profile does not change with the solvent but there are small shifts in the transient absorption maximum: 720 ± 5 nm for toluene, 710 ± 5 nm for benzonitrile and 700 ± 5 nm for acetonitrile. The transient absorption maximum is blue-shifted with respect to the 750 nm maximum of the C₆₀ triplet.³⁹ This blue shift is typical of monoadduct methano[60]fullerene derivatives.³⁶

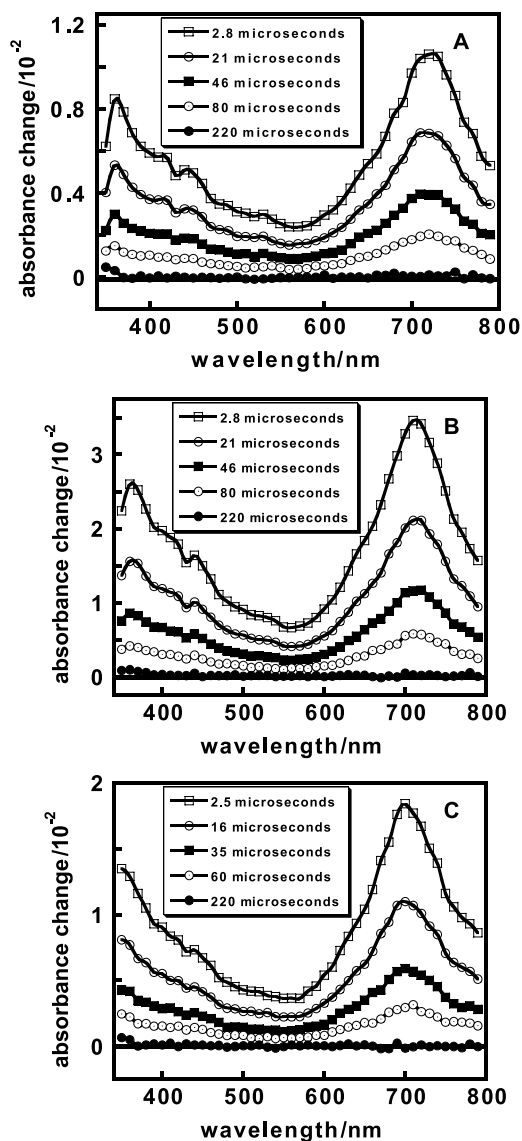

Figure 1. Transient absorption spectra recorded at different time intervals following laser excitation at 355 nm for compound **10** in toluene (A), benzonitrile (B) and acetonitrile (C). All solutions were bubbled with argon for about 45 min.

The transient absorption spectra for compound **10** (Fig. 1) are similar to the ones of the other compounds for the same solvent.

The true lifetimes of long-lived triplet states in solutions are difficult to measure accurately,⁴⁰ due to bimolecular quenching such as impurity quenching, ground state quenching and triplet–triplet annihilation. Previous studies have shown that the triplet state lifetimes are dependent on both the concentration of the fullerenes and also the laser

Table 2. Photophysical parameters for C₆₀ derivatives using 355 nm laser excitation

Compound	Toluene ^a		Benzonitrile ^a		Acetonitrile ^a	
	$\varepsilon_T \pm \Delta\varepsilon_T$ (M ⁻¹ cm ⁻¹) ^b	$\tau_T \pm \Delta\tau_T$ (μs) ^c	$\varepsilon_T \pm \Delta\varepsilon_T$ (M ⁻¹ cm ⁻¹) ^d	$\tau_T \pm \Delta\tau_T$ (μs) ^e	$\varepsilon_T \pm \Delta\varepsilon_T$ (M ⁻¹ cm ⁻¹) ^f	$\tau_T \pm \Delta\tau_T$ (μs) ^g
3	13512 ± 2949 ^h	14099 ± 3288 ⁱ	12860 ± 3337	51.1 ± 0.6		
4			12925 ± 3462	50.1 ± 0.6		
6	12565 ± 2732 ^h	13117 ± 3189 ⁱ	12198 ± 3145	49.0 ± 1.4	15272 ± 4462	43.0 ± 1.1
10	12494 ± 2683 ^h	13032 ± 3124 ⁱ	12522 ± 3282	47.5 ± 1.1	10218 ± 2513	37.0 ± 0.7
12	10936 ± 2369 ^h	11387 ± 2727 ⁱ	13310 ± 3444	48.1 ± 0.5	10935 ± 2703	31.8 ± 0.6

^a Argon saturated solutions.^b At 715 nm.^c At 715 nm; we doubled the standard error to give us a confidence limit of 95%.^d At 710 nm, assuming $\Phi_T = \Phi_\Delta$.^e At 710 nm; we doubled the standard error to give us a confidence limit of 95%.^f At 700 nm, assuming $\Phi_T = \Phi_\Delta$.^g At 700 nm; we doubled the standard error to give us a confidence limit of 95%.^h Assuming $\Phi_T = \Phi_\Delta$ and Φ_Δ values of compounds (see Table 4) were determined using C₆₀ in toluene as standard ($\Phi_\Delta = 1.01 \pm 0.03$, see Table 3).ⁱ Assuming $\Phi_T = \Phi_\Delta$ and Φ_Δ values of compounds (see Table 4) were determined using C₆₀ in toluene as standard ($\Phi_\Delta = 0.97 \pm 0.10$, see Table 3).

intensity.^{41,42} The best conditions for the determination of the triplet state lifetimes were the same as used in the determination of the triplet molar absorption coefficients at λ_{\max} (see Section 4.4). The triplet state lifetimes (τ_T) for the C₆₀ derivatives in the solvents used (toluene, benzonitrile and acetonitrile) are given in Table 2. Analysing the values of triplet state lifetimes (τ_T) for compounds **3**, **4**, **6**, **10** and **12** we can conclude that they do not change significantly from toluene to benzonitrile but are smaller in acetonitrile solutions (~22% smaller for compound **10** and ~35% smaller for compound **12**).

The molar absorption coefficients ε_T of C₆₀ derivatives triplet states in argon-saturated toluene, benzonitrile and acetonitrile solutions were estimated using a comparative method^{43,44} and assuming $\Phi_T = \Phi_\Delta$. They were determined by plotting the transient absorption intensity ($t=0$) as a function of the laser energy at the transient absorption maximum. The slopes α_T^{Ful} of the linear plots obtained for fullerene solutions ($A_{355} \sim 0.3$) were compared with the slopes α_T^{St} of an equivalent plot observed at 750 nm for an optically matched solution of C₆₀ in benzene ($A_{355} \sim 0.3$) as standard. The ε_T of the fullerene derivatives were obtained using Eq. 1:

$$\varepsilon_T^{\text{Ful}} - \varepsilon_G^{\text{Ful}} = (\varepsilon_T^{\text{St}} - \varepsilon_G^{\text{St}}) \left(\frac{\Phi_T^{\text{St}}}{\Phi_T^{\text{Ful}}} \right) \left(\frac{\alpha_T^{\text{Ful}}}{\alpha_T^{\text{St}}} \right) \left(\frac{1 - 10^{-A_{355}^{\text{St}}}}{1 - 10^{-A_{355}^{\text{Ful}}}} \right) \quad (1)$$

The ε_T value of C₆₀ in benzene is $20,200 \pm 2000$ M⁻¹ cm⁻¹ and the triplet quantum yield is 0.88 ± 0.15 .^{45,46} The singlet oxygen quantum yields of C₆₀ derivatives that we used to calculate triplet quantum yield ($\Phi_T = \Phi_\Delta$) are presented in Table 4. The ground state absorption coefficient of fullerene derivatives ($\varepsilon_G^{\text{Ful}}$) and ground state absorption coefficient of C₆₀ ($\varepsilon_G^{\text{St}}$) are negligible relative to the respective triplet state absorption coefficients ($\varepsilon_T^{\text{Ful}}$ and $\varepsilon_T^{\text{St}}$, respectively) at the absorption maximum. The values of molar absorption coefficients of the triplet state of the C₆₀ derivatives are given in Table 2. The ε_T values are consistent with results previously reported for other monoadduct methano[60]fullerenes.^{17,19} The high error associated with ε_T (22–29%) is in part due to the uncertainty in the Φ_T value of the reference used (0.88 ± 0.15), which has an uncertainty of $\pm 17\%$.

2.2.2. Singlet oxygen quantum yield measurements (Φ_Δ).

The quantum yields of singlet oxygen (Φ_Δ) for all derivatives in air-equilibrated solutions were determined from comparative time-resolved ¹O₂ (¹Δ_g) phosphorescence measurements. Extrapolated 1270 nm signal amplitudes at $t=0$ (I_0) were obtained from exponential fitting of luminescence decay traces for optically matched solutions of the fullerene derivative and reference standard over a range of laser intensities. As reference we used C₆₀ in toluene and benzonitrile solutions and perinaphthenone in acetonitrile solutions (Table 3). The value of Φ_Δ obtained for C₆₀ in toluene, using perinaphthenone as standard, is in agreement with the published one.⁴⁷ We used perinaphthenone as standard to estimate Φ_Δ of C₆₀ in benzonitrile. This choice was due to the fact that perinaphthenone (phenalene) can be used in several organic solvents and water without a great variation in Φ_Δ (0.92 ± 0.10 in cyclohexane $\leq \Phi_\Delta \leq 1.08 \pm 0.10$ in toluene).⁴⁸ The Φ_Δ value for perinaphthenone in benzonitrile (0.96 ± 0.12) was taken as an average of the Φ_Δ for perinaphthenone in benzene (0.93 ± 0.10) and acetonitrile (0.98 ± 0.07).

Table 3. Values of Φ_Δ for the standards used in different solvents

Standard Solvent	C ₆₀ Toluene	C ₆₀ Benzonitrile	Perinaphthenone Acetonitrile
$\Phi_\Delta \pm \Delta\Phi_\Delta$	1.01 ± 0.03^a , 0.97 ± 0.10^b	0.93 ± 0.13^c	0.98 ± 0.07^d

^a Taken from Ref. 47.^b Determined using a published Φ_Δ value of 1.08 ± 0.10 for perinaphthenone as standard.⁴⁸^c Determined assuming Φ_Δ of perinaphthenone in benzonitrile is the average of Φ_Δ in benzene (0.93 ± 0.10) and acetonitrile (0.98 ± 0.07).⁴⁸^d Taken from Ref. 48.

Singlet oxygen quantum yields were determined from the ratio of the slopes of the I_0 versus laser intensity plots for the fullerene derivatives relative to that for standard ($\alpha_\Delta^{\text{Ful}}/\alpha_\Delta^{\text{St}}$) according to Eq. 2. Appropriate corrections of small differences in the absorbances of the samples at 355 nm laser excitation were made. The values of the singlet oxygen quantum yields of standard compounds used (Φ_Δ^{St}) are given

in Table 3.

$$\Phi_{\Delta}^{\text{Ful}} = \Phi_{\Delta}^{\text{St}} \left(\frac{\alpha_{\Delta}^{\text{Ful}}}{\alpha_{\Delta}^{\text{St}}} \right) \left(\frac{1 - 10^{-A_{355}^{\text{St}}}}{1 - 10^{-A_{355}^{\text{Ful}}}} \right) \quad (2)$$

The Φ_{Δ} values obtained for C₆₀ derivatives in toluene solutions are close to unity (Table 4). In benzonitrile the Φ_{Δ} values are slightly lower than in toluene but are similar within the range of error. Compounds **10** and **12** have almost the same Φ_{Δ} values in benzonitrile and in acetonitrile. The smallest Φ_{Δ} value (0.60 ± 0.09) was obtained for compound **6** in acetonitrile (a saturated solution). This result can be attributed to absorption and scattering by aggregates at 355 nm, although the presence of aggregates is not apparent from the absorption spectrum of the solution used.

Table 4. Singlet oxygen quantum yields (Φ_{Δ}) for fullerene derivatives in air-equilibrated solutions using 355 nm laser excitation

Compound	$\Phi_{\Delta}^{\text{Ful}} \pm \Delta \Phi_{\Delta}^{\text{Ful}}$			
	Toluene		Benzonitrile	Acetonitrile
	a	b	c	d
3	0.96 ± 0.05	0.92 ± 0.11	0.87 ± 0.13	e
4	e	e	0.88 ± 0.14	e
6	0.95 ± 0.05	0.91 ± 0.11	0.87 ± 0.13	0.60 ± 0.09
10	0.97 ± 0.05	0.93 ± 0.11	0.88 ± 0.14	0.89 ± 0.12
12	1.01 ± 0.05	0.97 ± 0.11	0.83 ± 0.13	0.80 ± 0.11

^a $\Phi_{\Delta} = 1.01 \pm 0.03$ for C₆₀ in toluene as standard.⁴⁷

^b $\Phi_{\Delta} = 0.97 \pm 0.10$ for C₆₀ in toluene as standard.

^c $\Phi_{\Delta} = 0.93 \pm 0.13$ for C₆₀ in benzonitrile as standard.

^d $\Phi_{\Delta} = 0.98 \pm 0.07$ for perinaphthenone in acetonitrile as standard.⁴⁸

^e The compound is insoluble in this solvent.

3. Conclusions

In conclusion, C₆₀ derivatives containing one or two units of D-galactose or D-glucose derivatives were obtained in low to moderate yields by cyclopropanation reactions of C₆₀ with sugar-malonates prepared from commercially available materials. The synthetic procedure is simple, requires mild conditions, affords diastereoisomeric pure compounds and is of general application.

The results obtained from UV–vis spectrophotometry, time-resolved luminescence and nanosecond laser flash photolysis reveal that functionalization of C₆₀ with sugar moieties allows the formation of C₆₀ derivatives soluble in toluene, benzonitrile and acetonitrile. We have shown that the Φ_{Δ} values of our methano[60]fullerenes **3**, **4**, **6**, **10** and **12** in toluene and benzonitrile are close to unity, irrespectively, of the sugar moiety (galactose or glucose units with protected or free hydroxyl groups). Also, compounds with a good singlet oxygen quantum yield in acetonitrile can be obtained by functionalization of C₆₀ with one or two glucose units protected with acetyl groups.

It is known that sugar moieties have important biological functions in sugar-derived biomolecules, namely in cellular recognition, cellular transport and adhesion phenomena. So, it is expected that the sugar moieties allow a selective adhesion of these fullerene derivatives to invading cells

(virus or bacteria, for instance) or to cancer tissues facilitating their selective destruction by photo-irradiation.

4. Experimental

C₆₀ (>99%) used in the photophysical studies was obtained from Stefan Kaesdorf (Munich, Germany). Perinaphthenone, from Aldrich, was recrystallised from cyclohexane. Toluene (BDH-AnalaR, 99.5%), benzonitrile (Aldrich, HPLC grade, 99.9%) and acetonitrile (HPLC grade, 99.93%) were used as supplied.

¹H and ¹³C NMR spectra were recorded on a Bruker Avance 300 spectrometer at 300 and 75 MHz, respectively. Deuterated chloroform and CDCl₃/CD₃OD were used as solvents and TMS as internal reference. Chemical shifts (δ) are quoted in ppm relative to TMS and the coupling constants (J) are expressed in Hertz (Hz). Peak multiplicity is designed as s (singlet), d (doublet), dd (double doublet), ddd (double double doublet), t (triplet), dt (double triplet), m (multiplet), AB (AB spin system) and br s (broad signal). Mass spectra and HRMS were recorded on VG AutoSpec Q and M mass spectrometer. The *m*-nitrobenzylalcohol was used as a matrix of FAB⁺-MS. The IR spectra were recorded on a Mattson 7020 Galaxy FTIR spectrometer using KBr disks. The intensities of the bands were expressed subjectively as strong (s), medium (m), weak (w) and sharp (sh). The UV–vis spectra were recorded on a Perkin-Elmer Lambda 2 UV–vis spectrophotometer. Melting points were determined with a Reichert Thermovar electric instrument and are uncorrected. Flash chromatography was carried out with silica gel 0.032–0.063 mm. The reactions were monitored by TLC. TLC of the reaction mixtures involving sugar derivatives were revealed by spraying it with a solution of ammonium molybdate(VI) (5 g), cerium(III) sulfate (0.1 g) and sulfuric acid 10% (10 mL) in water (100 mL) and heating.

The time-resolved singlet oxygen phosphorescence signal peaking at 1270 nm was detected using a liquid-nitrogen cooled germanium photodiode and an amplifier supplied by Applied Detector Corporation (USA). In the flash photolysis experiments, solutions were excited at 355 nm with a Spectron Q-switched Nd:YAG laser.⁴⁹

4.1. Synthesis of C₆₀ derivatives with D-galactose units

4.1.1. (1,2:3,4-Di-*O*-isopropylidene- α -D-galactopyranosyl) methyl malonate (2). 1,2:3,4-Di-*O*-isopropylidene-D-galactopyranose **1** (707 mg, 2.72 mmol) and anhydrous NEt₃ (3.8 mL, 10 equiv) were dissolved in CH₂Cl₂ (20 mL) and the solution was cooled in a ice bath. Methyl 3-chloro-3-oxopropanoate (3.1 mL, 5 equiv) diluted in CH₂Cl₂ (5 mL) was added dropwise to the reaction mixture. The ice bath was then removed and the reaction mixture was stirred at room temperature for 5 h. The reaction mixture was washed with an aqueous solution of HCl 0.5% (2 × 30 mL) and then with a saturated aqueous solution of NaHCO₃ (2 × 30 mL). The organic phase was dried (Na₂SO₄) and the solvent was evaporated under vacuum. The malonate **2** was purified by column chromatography (silica gel) using CH₂Cl₂/AcOEt 8:2 as eluent. Compound **2**

was isolated as a colourless oil (803 mg, 82% yield). ^1H NMR (300 MHz, CDCl_3): δ 1.33 (s, 3H, $\text{C}(\text{CH}_3)_2$), 1.34 (s, 3H, $\text{C}(\text{CH}_3)_2$), 1.45 (s, 3H, $\text{C}(\text{CH}_3)_2$), 1.52 (s, 3H, $\text{C}(\text{CH}_3)_2$), 3.43 (s, 2H, OCCH_2CO), 3.75 (s, 3H, OCH_3), 4.04 (ddd, 1H, H-5, $J_{5,6}=7.3$ Hz, $J_{5,6'}=4.8$ Hz, $J_{4,5}=2.1$ Hz), 4.24 (dd, 1H, H-4, $J_{3,4}=7.9$ Hz, $J_{4,5}=2.1$ Hz), 4.26 (dd, 1H, H-6, $J_{6,6'}=11.5$ Hz, $J_{5,6}=7.3$ Hz), 4.33 (dd, 1H, H-2, $J_{1,2}=5.0$ Hz, $J_{2,3}=2.5$ Hz), 4.36 (dd, 1H, H-6', $J_{6,6'}=11.5$ Hz, $J_{5,6'}=4.8$ Hz), 4.63 (dd, 1H, H-3, $J_{3,4}=7.9$ Hz, $J_{2,3}=2.5$ Hz), 5.53 (d, 1H, H-1, $J_{1,2}=5.0$ Hz). ^{13}C NMR (75 MHz, CDCl_3): δ 24.2, 24.74, 25.71, 25.75 ($4\text{C}(\text{CH}_3)_2$), 41.0 (OCCH_2CO), 52.3 (OCH_3), 64.1 (C-6), 65.6 (C-5), 70.2, 70.4, 70.7 (C-2, C-3, C-4), 96.0 (C-1), 108.6, 109.4 ($2\text{C}(\text{CH}_3)_2$), 166.2, 166.6 ($2\text{C}=\text{O}$). MS (EI^+) m/z (rel int): 345 ($\text{M}-\text{CH}_3$) $^+$, 100, 287 (13), 271 (11), 227 (13), 184 (11), 169 (24), 127 (32), 112 (53), 80 (100). MS (FAB^+) m/z (rel int): 361 ($[\text{M}+\text{H}]^+$, 49), 345 (100).

4.1.2. Dyad 3. To a solution of malonate **2** (38 mg, 0.10 mmol) and C_{60} (75 mg, 1 equiv) in anhydrous toluene (50 mL) were added iodine (26 mg, 1.5 equiv) and DBU (47 μL , 3 equiv). The reaction mixture was stirred for 8 h at room temperature, under a nitrogen atmosphere, and then it was washed with an aqueous solution of 5% $\text{Na}_2\text{S}_2\text{O}_3$ (2×50 mL). The organic phase was concentrated and purified by flash chromatography (silica gel) using toluene as eluent. Compound **3** was crystallized from $\text{CHCl}_3/\text{MeOH}$ giving black crystals (46 mg, 43% yield) with mp 213–215 $^\circ\text{C}$. ^1H NMR (300 MHz, CDCl_3): δ 1.35 (s, 3H, $\text{C}(\text{CH}_3)_2$), 1.36 (s, 3H, $\text{C}(\text{CH}_3)_2$), 1.50 (s, 3H, $\text{C}(\text{CH}_3)_2$), 1.57 (s, 3H, $\text{C}(\text{CH}_3)_2$), 4.12 (s, 3H, OCH_3), 4.26 (dt, 1H, H-5, $J_{5,6}=J_{5,6'}=6.2$ Hz, $J_{4,5}=1.9$ Hz), 4.32 (dd, 1H, H-4, $J_{3,4}=7.8$ Hz, $J_{4,5}=1.9$ Hz), 4.38 (dd, 1H, H-2, $J_{1,2}=5.0$ Hz, $J_{2,3}=2.5$ Hz), 4.64–4.69 (m, 3H, H-3, H-6, H-6'), 5.60 (d, 1H, H-1, $J_{1,2}=5.0$ Hz). ^{13}C NMR (75 MHz, CDCl_3): δ 24.5, 25.0, 26.0, 26.2 ($4\text{C}(\text{CH}_3)_2$), 51.9 (methano bridge), 54.1 (s, 3H, OCH_3), 65.8, 65.9 (C-5, C-6), 70.4, 70.7, 70.9 (C-2, C-3, C-4), 71.3 ($\text{C}_{60}\text{-sp}^3$), 71.4 ($\text{C}_{60}\text{-sp}^3$), 96.3 (C-1), 108.9, 109.8 ($2\text{C}(\text{CH}_3)_2$), 139.00, 139.04, 139.18, 139.21, 140.89, 140.92, 140.94, 141.89, 141.94, 141.96, 142.2, 142.98, 143.03, 143.9, 144.60, 144.66, 144.9, 145.05, 145.11, 145.16, 145.23, 163.4 and 164.0 ($2\text{C}=\text{O}$). MS (FAB^+) m/z : 1079 ($\text{M}+\text{H}$) $^+$, 720 (C_{60}^+). HRMS (FAB^+) m/z calcd for $\text{C}_{76}\text{H}_{23}\text{O}_9$ 1079.1342, found 1079.1381. IR (KBr) ν_{max} : 2984m, 2926m, 1746s, 1430s, 1381s, 1235s, 1070s, 1004s, 755s, 580m, 552m, 527s cm^{-1} . UV–vis (toluene): λ_{max} 690 ($\epsilon=209 \text{ M}^{-1} \text{ cm}^{-1}$), 493 (1.57×10^3), 428 (2.75×10^3), 330 (4.46×10^4) nm.

4.1.3. Dyad 4. To a solution of compound **3** (15 mg, 0.014 mmol) in CHCl_3 (3 mL) was added a 9:1 mixture of $\text{CF}_3\text{CO}_2\text{H}/\text{H}_2\text{O}$ (5 mL). The reaction mixture was stirred for 14 h at room temperature, it was neutralized with a saturated aqueous solution of Na_2CO_3 and then dyad **4** was extracted with a 7:3 mixture of $\text{CHCl}_3/\text{MeOH}$ (3×30 mL). The organic layer was dried (Na_2SO_4) and concentrated. Dyad **4** was precipitated by the addition of hexane affording a black solid (13 mg, 96% yield) corresponding to a mixture of the α and β anomers. Mp > 320 $^\circ\text{C}$. ^1H NMR (300 MHz, $\text{CDCl}_3/\text{CD}_3\text{OD}$): δ 4.11 (s, 6H, OCH_3 of α and β anomers), 3.79–4.08 (m, 1H of α -Gal and 3H of β -Gal), 4.18–4.40 (m, 3H of β -Gal), 4.42–4.46 (m, 1H of α -Gal), 4.50 (d, 1H, H-1 of β -Gal, $J=7.3$ Hz), 4.53–4.77 (m, 4H of α -Gal), 5.28 (d, 1H,

H-1 of α -Gal, $J=3.4$ Hz). MS (FAB^+) m/z : 999 ($\text{M}+\text{H}$) $^+$, 720 (C_{60}^+). HRMS (FAB^+) m/z calcd for $\text{C}_{70}\text{H}_{15}\text{O}_9$ 999.0716, found 999.0704. IR (KBr) ν_{max} : 3423s, 2922s, 2852s, 1742s, 1631s, 1430s, 1235s, 1062s, 729s, 669s, 1742s, 575m, 552m, 526s cm^{-1} .

4.1.4. Bis-(1,2:3,4-di-*O*-isopropylidene- α -*D*-galactopyranosyl) malonate (5). Malonyl dichloride (0.8 mL, 2.5 equiv) diluted in CH_2Cl_2 was added dropwise to an ice cooled solution of galactopyranose **1** (853 mg, 3.28 mmol) and anhydrous NEt_3 (4.5 mL, 10 equiv) in CH_2Cl_2 (25 mL). The ice bath was removed and the reaction mixture was stirred at room temperature for 7 h. The reaction mixture was washed with an aqueous solution of HCl 0.5% (2×30 mL) and then with a saturated aqueous solution of NaHCO_3 (2×30 mL). The organic phase was dried (Na_2SO_4), the solvent was evaporated under vacuum. The malonate **5** was purified by column chromatography (silica gel) using $\text{CH}_2\text{Cl}_2/\text{AcOEt}$ 8:2 as eluent. Compound **5** was isolated as a colourless oil (1.0 g, 52% yield). ^1H NMR (300 MHz, CDCl_3): δ 1.33 (s, 6H, $\text{C}(\text{CH}_3)_2$), 1.34 (s, 6H, $\text{C}(\text{CH}_3)_2$), 1.44 (s, 6H, $\text{C}(\text{CH}_3)_2$), 1.52 (s, 6H, $\text{C}(\text{CH}_3)_2$), 3.47 (s, 2H, COCH_2CO), 4.04 (ddd, 2H, $2 \times \text{H}-5$, $J_{5,6}=7.1$ Hz, $J_{5,6'}=5.3$ Hz, $J_{4,5}=1.8$ Hz), 4.21–4.36 (m, 8H, $2 \times \text{H}-2$, $2 \times \text{H}-4$, $2 \times \text{H}-6$, $2 \times \text{H}-6'$), 4.62 (dd, 2H, $2 \times \text{H}-3$, $J_{3,4}=7.8$ Hz, $J_{2,3}=2.5$ Hz), 5.53 (d, 2H, $2 \times \text{H}-1$, $J_{1,2}=5.0$ Hz). ^{13}C NMR (75 MHz, CDCl_3): δ 24.1, 24.6, 25.6, 25.7 ($8\text{C}(\text{CH}_3)_2$), 40.8 (COCH_2CO), 63.9 (C-6), 65.4 (C-5), 70.0, 70.3, 70.5 (C-2, C-3, C-4), 95.9 (C-1), 108.4, 109.2 ($4\text{C}(\text{CH}_3)_2$), 166.0 ($2\text{C}=\text{O}$). MS (EI^+) m/z (rel int): 588 (M^+ , 0.3), 573 (98), 515 (10), 457 (7), 329 (15), 287 (8), 271 (15), 184 (14), 169 (27), 127 (31), 81 (100). MS (FAB^+) m/z : 589 [$\text{M}+\text{H}$] $^+$.

4.1.5. Dyad 6. Dyad **6** was prepared in a similar way as dyad **3**, using malonate **5** (47 mg, 0.081 mmol), C_{60} (58 mg, 1 equiv), iodine (31 mg, 1.5 equiv) and DBU (36 μL , 3 equiv) in anhydrous toluene (50 mL). It was purified by flash chromatography (silica gel) using toluene/ AcOEt 95:5 as eluent. Compound **6** was crystallized from $\text{CHCl}_3/\text{MeOH}$ giving a black solid (39 mg, 37% yield) with mp 90–92 $^\circ\text{C}$. ^1H NMR (300 MHz, CDCl_3): δ 1.33 (s, 6H, $\text{C}(\text{CH}_3)_2$), 1.34 (s, 6H, $\text{C}(\text{CH}_3)_2$), 1.49 (s, 6H, $\text{C}(\text{CH}_3)_2$), 1.54 (s, 6H, $\text{C}(\text{CH}_3)_2$), 4.20–4.25 (m, 2H, $2 \times \text{H}-5$), 4.30–4.36 (m, 4H, $2 \times \text{H}-2$, $2 \times \text{H}-4$), 4.60–4.71 (m, 6H, $2 \times \text{H}-3$, $2 \times \text{H}-6$, $2 \times \text{H}-6'$), 5.56 (d, 2H, $2 \times \text{H}-1$, $J_{1,2}=4.9$ Hz). ^{13}C NMR (75 MHz, CDCl_3): δ 24.5, 24.9, 26.0, 26.2 ($4\text{C}(\text{CH}_3)_2$), 52.0 (methano bridge), 65.56, 65.62 (C-5, C-6), 70.4, 70.7, 70.8 (C-2, C-3, C-4), 71.4 ($\text{C}_{60}\text{-sp}^3$), 96.2 (C-1), 108.8, 109.6 ($\text{C}(\text{CH}_3)_2$), 139.19, 139.21, 140.9, 141.95, 141.99, 142.2, 142.96, 143.01, 1433.84, 143.86, 144.5, 144.7, 144.9, 145.12, 145.14, 145.19, 163.3 ($2\text{C}=\text{O}$). MS (FAB^+) m/z : 1307 ($\text{M}+\text{H}$) $^+$, 720 (C_{60}^+). HRMS (FAB^+) m/z calcd for $\text{C}_{87}\text{H}_{39}\text{O}_{14}$ 1307.2340, found 1307.2368. IR (KBr) ν_{max} : 2974m, 2906m, 1740s, 1384s, 1213s, 1067s, 1005s, 749s, 575m, 552m, 526s cm^{-1} . UV–vis (toluene): λ_{max} 690 ($\epsilon=194 \text{ M}^{-1} \text{ cm}^{-1}$), 493 (1.50×10^3), 428 (2.63×10^3), 330 (4.14×10^4) nm.

4.2. Synthesis of C_{60} derivatives with *D*-glucose units

4.2.1. 2-Hydroxyethyl 2,3,4,6-tetra-*O*-acetyl- β -*D*-glucopyranoside (8). To a solution of the glucopyranosyl bromide **7** (600 mg, 1.46 mmol) in anhydrous CH_2Cl_2

(60 mL) was added anhydrous Na_2SO_4 and 1,2-ethanediol (0.81 mL, 10 equiv). After stirring at room temperature for 15 min, under a nitrogen atmosphere, Ag_2CO_3 (840 mg, 21 equiv) was added to the reaction mixture and stirring was continued for 24 h. The reaction mixture was filtered, washed with water (3×40 mL), dried (Na_2SO_4) and the solvent was evaporated. Compound **8** was obtained as an oil, which then solidified into a white solid (538 mg, 94% yield). ^1H NMR (300 MHz, CDCl_3): δ 2.01 (s, 3H, AcO), 2.04 (s, 3H, AcO), 2.06 (s, 3H, AcO), 2.09 (s, 3H, AcO), 2.81 (t, 1H, OH, $J = 6.3$ Hz), 3.69–3.87 (m, 5H, H-5 and $\text{OCH}_2\text{CH}_2\text{OH}$), 4.17 (dd, 1H, H-6', $J_{6,6'} = 12.4$ Hz, $J_{5,6'} = 2.9$ Hz), 4.23 (dd, 1H, H-6, $J_{6,6'} = 12.4$ Hz, $J_{5,6} = 5.2$ Hz), 4.59 (d, 1H, H-1, $J_{1,2} = 8.0$ Hz), 5.01 (dd, 1H, H-2, $J_{1,2} = 8.0$ Hz, $J_{2,3} = 9.5$ Hz), 5.07 (t, 1H, H-4, $J_{3,4} = J_{4,5} = 9.5$ Hz), 5.23 (t, 1H, H-3, $J_{2,3} = J_{3,4} = 9.5$ Hz). ^{13}C NMR (75 MHz, CDCl_3): δ 20.4, 20.5 ($4\text{CH}_3\text{C}=\text{O}$), 61.6 (Glc-O- CH_2), 61.8 (C-6), 68.2 (C-4), 71.1 (C-5), 71.6 (C-2), 72.4 ($\text{OCH}_2\text{CH}_2\text{OH}$), 72.6 (C-3), 101.1 (C-1), 169.2, 169.3, 170.0, 170.4 ($4\text{C}=\text{O}$). MS (FAB⁺) m/z : 393 [M+H]⁺.

4.2.2. 2-(2,3,4,6-Tetra-O-acetyl- β -D-glucopyranosyl)-ethyl methyl malonate (9). A solution of methyl 3-chloro-3-oxopropanoate (0.11 mL, 5 equiv) in anhydrous CH_2Cl_2 (3 mL) was added dropwise to an ice cooled solution of glycoside **8** (83 mg, 0.21 mmol) and anhydrous NEt_3 (0.23 mL, 8 equiv) in anhydrous CH_2Cl_2 (10 mL). The ice bath was removed and the reaction mixture was stirred at room temperature for 5 h. It was then washed with an aqueous solution of HCl 0.5% (2×15 mL) and with a saturated aqueous solution of NaHCO_3 (2×15 mL). The organic phase was separated, dried (Na_2SO_4) and the solvent was evaporated under vacuum. Malonate **9** was purified by column chromatography (silica gel) using a 7:3 mixture of $\text{CH}_2\text{Cl}_2/\text{AcOEt}$ as eluent. It was obtained as a colourless oil (99 mg, 96% yield). ^1H NMR (300 MHz, CDCl_3): δ 1.93 (s, 3H, AcO), 1.96 (s, 3H, AcO), 1.98 (s, 3H, AcO), 2.02 (s, 3H, AcO), 3.35 (s, 2H, COCH_2CO), 3.64 (m, 2H, H-5 and $\text{OCH}_2\text{CH}_2\text{O}$), 3.69 (OCH_3), 3.91–3.97 (m, 1H, $\text{OCH}_2\text{CH}_2\text{O}$), 4.06 (dd, 1H, H-6', $J_{6,6'} = 12.3$ Hz, $J_{5,6'} = 2.4$ Hz), 4.17–4.25 (m, 3H, H-6 and $\text{OCH}_2\text{CH}_2\text{O}$), 4.53 (d, 1H, H-1, $J_{1,2} = 7.9$ Hz), 4.91 (dd, 1H, H-2, $J_{1,2} = 7.9$ Hz, $J_{2,3} = 9.5$ Hz), 5.01 (t, 1H, H-4, $J_{3,4} = J_{4,5} = 9.5$ Hz), 5.14 (t, 1H, H-3, $J_{2,3} = J_{3,4} = 9.5$ Hz). ^{13}C NMR (75 MHz, CDCl_3): δ 20.4, 20.5 ($4\text{CH}_3\text{C}=\text{O}$), 40.9 (COCH_2CO), 52.4 (OCH_3), 61.7 (C-6), 64.1 (Glc-O- CH_2), 67.0 (Glc-O- $\text{H}_2\text{CH}_2\text{O}$), 68.1 (C-4), 70.9 (C-5), 71.6 (C-2), 72.5 (C-3), 100.5 (C-1), 166.1, 166.6 (malonate C=O), 169.1, 169.2, 170.0, 170.5 (4 acetyl C=O). MS (FAB⁺) m/z : 493 [M+H]⁺.

4.2.3. Dyad 10. To a solution of malonate **9** (61 mg, 0.12 mmol) and C_{60} (90 mg, 1 equiv) in anhydrous toluene (75 mL) were added iodine (48 mg, 1.5 equiv) and DBU (56 μL , 3 equiv).

The reaction mixture was stirred for 8 h at room temperature, under a nitrogen atmosphere, and then it was washed with an aqueous solution of 5% $\text{Na}_2\text{S}_2\text{O}_3$ (2×50 mL). The organic phase was concentrated and purified by flash chromatography (silica gel) using toluene (to recover the unreacted C_{60}) and then a 8:2 mixture of toluene/ AcOEt as eluent. Dyad **10** was crystallized from $\text{CHCl}_3/\text{MeOH}$ to afford black crystals (47 mg, 31% yield). Mp > 320 °C. ^1H

NMR (300 MHz, CDCl_3): δ 2.01 (s, 3H, AcO), 2.03 (s, 3H, AcO), 2.11 (s, 3H, AcO), 2.13 (s, 3H, AcO), 3.75 (ddd, 1H, H-5, $J_{4,5} = 9.5$ Hz, $J_{5,6} = 4.7$ Hz, $J_{5,6'} = 2.4$ Hz), 3.94–4.00 (m, 1H, $\text{OCH}_2\text{CH}_2\text{O}$), 4.12 (s, 3H, OCH_3), 4.17 (dd, 1H, H-6', $J_{6,6'} = 12.3$ Hz, $J_{5,6'} = 2.4$ Hz), 4.17–4.24 (m, 1H, $\text{OCH}_2\text{CH}_2\text{O}$), 4.30 (dd, 1H, H-6, $J_{6,6'} = 12.3$ Hz, $J_{5,6} = 4.7$ Hz), 4.64 (d, 1H, H-1, $J_{1,2} = 7.9$ Hz), 4.57–4.75 (m, 2H, $\text{OCH}_2\text{CH}_2\text{O}$), 5.05 (dd, 1H, H-2, $J_{1,2} = 7.9$ Hz, $J_{2,3} = 9.5$ Hz), 5.11 (t, 1H, H-4, $J_{3,4} = J_{4,5} = 9.5$ Hz), 5.23 (t, 1H, H-3, $J_{2,3} = J_{3,4} = 9.5$ Hz). ^{13}C NMR (75 MHz, CDCl_3): δ 20.6, 20.8 ($4\text{CH}_3\text{C}=\text{O}$), 51.8 (methano bridge), 54.2 (OCH_3), 61.9 (C-6), 65.8 (Glc-O- CH_2), 67.0 (Glc-O- $\text{H}_2\text{CH}_2\text{O}$), 68.3 (C-4), 71.1 (C-5), 71.3 ($\text{C}_{60}\text{-sp}^3$), 72.0 (C-2), 72.7 (C-3), 100.8 (C-1), 139.0, 139.1, 141.0, 141.87, 141.89, 141.95, 142.2, 143.03, 143.06, 143.12, 143.90, 143.92, 144.60, 144.63, 144.68, 144.72, 144.9, 145.03, 145.05, 145.09, 145.2, 145.3, 163.4, 163.9 (malonate C=O), 169.4, 170.3, 170.7 (4 acetyl C=O). MS (FAB⁺) m/z : 1211 (M+H)⁺, 720 (C_{60}^+). HRMS (FAB⁺) m/z calcd for $\text{C}_{80}\text{H}_{27}\text{O}_{14}$ 1211.1401, found 1211.1349. IR (KBr) ν_{max} : 2951m, 1754s, 1428s, 1370s, 1231s, 1039s, 755s, 580m, 527s cm^{-1} . UV-vis (toluene): λ_{max} 690 ($\epsilon = 185 \text{ M}^{-1} \text{ cm}^{-1}$), 493 (1.44×10^3), 428 (2.44×10^3), 330 (4.01×10^4) nm.

4.2.4. Bis-2-(2,3,4,6-tetra-O-acetyl- β -D-glucopyranosyl)-ethyl malonate (11). Malonyl dichloride (58 μL , 2.5 equiv) diluted in anhydrous CH_2Cl_2 (3 mL) was added dropwise to an ice cooled solution of glycoside **8** (96 mg, 0.24 mmol) and anhydrous NEt_3 (0.27 mL, 8 equiv) in anhydrous CH_2Cl_2 (15 mL). The ice bath was removed and the reaction mixture was stirred at room temperature for 7 h. It was then washed with an aqueous solution of HCl 0.5% (2×30 mL) and with a saturated aqueous solution of NaHCO_3 (2×30 mL). The organic phase was separated, dried (Na_2SO_4) and the solvent was evaporated under vacuum. Malonate **11** was purified by column chromatography (silica gel) with a gradient of $\text{CH}_2\text{Cl}_2/\text{AcOEt}$. Compound **11** was obtained as a colourless oil (123 mg, 60% yield). ^1H NMR (300 MHz, CDCl_3): δ 2.01 (s, 3H, AcO), 2.03 (s, 3H, AcO), 2.11 (s, 3H, AcO), 2.13 (s, 3H, AcO), 3.43 (s, 2H, COCH_2CO), 3.73 (ddd, 1H, H-5, $J_{4,5} = 9.5$ Hz, $J_{5,6} = 4.8$ Hz, $J_{5,6'} = 2.3$ Hz), 3.78–3.84 (m, 1H, $\text{OCH}_2\text{CH}_2\text{O}$), 3.96–4.08 (m, 1H, $\text{OCH}_2\text{CH}_2\text{O}$), 4.14 (dd, 1H, H-6', $J_{6,6'} = 12.3$ Hz, $J_{5,6'} = 2.4$ Hz), 4.20–4.37 (m, 2H, $\text{OCH}_2\text{CH}_2\text{O}$), 4.28 (dd, 1H, H-6, $J_{6,6'} = 12.3$ Hz, $J_{5,6} = 2.4$ Hz), 4.59 (d, 1H, H-1, $J_{1,2} = 7.9$ Hz), 4.98 (dd, 1H, H-2, $J_{1,2} = 7.9$ Hz, $J_{2,3} = 9.5$ Hz), 5.09 (t, 1H, H-4, $J_{3,4} = J_{4,5} = 9.5$ Hz), 5.22 (t, 1H, H-3, $J_{2,3} = J_{3,4} = 9.5$ Hz). ^{13}C NMR (75 MHz, CDCl_3): δ 20.6, 20.7 ($4\text{CH}_3\text{C}=\text{O}$), 41.1 (COCH_2CO), 61.8 (C-6), 64.2 (Glc-O- CH_2), 67.1 (Glc-O- $\text{H}_2\text{CH}_2\text{O}$), 68.2 (C-4), 71.0 (C-5), 71.8 (C-2), 72.6 (C-3), 100.7 (C-1), 166.7 (malonate C=O), 169.3, 169.4, 170.2, 170.7 (4 acetyl C=O). MS (FAB⁺) m/z : 853 [M+H]⁺.

4.2.5. Dyad 12. Dyad **12** was prepared in a similar way of dyad **10**, using malonate **11** (107 mg, 0.12 mmol), C_{60} (90 mg, 1 equiv), iodine (48 mg, 1.5 equiv) and DBU (56 μL , 3 equiv) in anhydrous toluene (75 mL). It was purified by flash chromatography (silica gel) using toluene/ AcOEt 7:3 as eluent. Dyad **12** was crystallized from $\text{CHCl}_3/\text{MeOH}$ affording black crystals (35 mg, 18% yield). Mp 188–190 °C. ^1H NMR (300 MHz, CDCl_3): δ 2.01 (s, 3H,

AcO), 2.03 (s, 3H, AcO), 2.11 (s, 3H, AcO), 2.12 (s, 3H, AcO), 3.75 (ddd, 1H, H-5, $J_{4,5}=9.5$ Hz, $J_{5,6}=4.5$ Hz, $J_{5,6'}=2.3$ Hz), 3.94–4.01 (m, 1H, OCH₂CH₂O), 4.16 (dd, 1H, H-6', $J_{6,6'}=12.4$ Hz, $J_{5,6'}=2.3$ Hz), 4.15–4.24 (m, 1H, OCH₂CH₂O), 4.31 (dd, 1H, H-6, $J_{6,6'}=12.4$ Hz, $J_{5,6}=4.5$ Hz), 4.65 (d, 1H, H-1, $J_{1,2}=7.9$ Hz), 4.56–4.75 (m, 2H, OCH₂CH₂O), 5.03 (dd, 1H, H-2, $J_{1,2}=7.9$ Hz, $J_{2,3}=9.5$ Hz), 5.10 (t, 1H, H-4, $J_{3,4}=J_{4,5}=9.5$ Hz), 5.23 (t, 1H, H-3, $J_{2,3}=J_{3,4}=9.5$ Hz). ¹³C NMR (75 MHz, CDCl₃): δ 20.6, 20.77, 20.79 (4CH₃C=O), 51.7 (methano bridge), 61.9 (C-6), 65.8 (Glc-O-CH₂), 66.9 (Glc-O-H₂CH₂O), 68.3 (C-4), 71.1 (C-5), 71.2 (C₆₀-sp³), 71.9 (C-2), 72.7 (C-3), 100.7 (C-1), 139.1, 141.00, 141.04, 141.85, 141.88, 142.2, 143.02, 143.04, 143.12, 144.56, 144.67, 144.70, 144.86, 144.88, 144.92, 145.01, 145.04, 145.21, 145.28, 145.31, 163.2 (malonate C=O), 169.4, 170.2, 170.6 (4 acetyl C=O). MS (FAB⁺) m/z : 1571 (M+H)⁺, 720 (C₆₀⁺). HRMS (FAB⁺) m/z calcd for C₉₅H₄₇O₂₄ 1571.2457, found 1571.2410. IR (KBr) ν_{\max} : 2960m, 2933m, 1754s, 1428m, 1366m, 1231s, 1040s, 527s cm⁻¹. UV-vis (toluene): λ_{\max} 690 ($\epsilon=199$ M⁻¹ cm⁻¹), 493 (1.55×10^3), 428 (2.62×10^3), 330 (4.19×10^4) nm.

4.3. Singlet oxygen quantum yield measurements (Φ_{Δ})

Air equilibrated toluene and benzonitrile solutions of all derivatives were optically matched at $A \sim 0.3$ (at 355 nm) while air equilibrated acetonitrile solutions were optically matched at $A \sim 0.1$. The solutions, in a 1×1 cm² quartz cell, were excited using laser energies between 0.2 and 1 mJ/pulse. The dependence of the intensity of singlet oxygen phosphorescence on laser energy is linear in this range. The singlet oxygen phosphorescence trace recorded at 1270 nm was the average of an accumulation of 16 laser shots.

4.4. T–T absorption spectra and triplet molar absorption coefficients at λ_{\max}

The T–T absorption spectra were recorded in the range 350–790 nm. Samples absorbances at 355 nm in toluene and benzonitrile solutions were ~ 0.4 (~ 0.3 for benzonitrile solutions of compound **4**); for acetonitrile solutions were ~ 0.07 for compound **6**, ~ 0.4 for compound **10** and ~ 0.5 for compound **12**. All solutions were analysed in 1×1 cm² quartz cells and oxygen was removed by purging with argon for approximately 45 min. Laser energies in the range of 2–4 mJ/pulse were used. It was necessary to use higher laser energies (21 mJ/pulse) for compound **6** in acetonitrile.

The triplet molar absorption coefficients at λ_{\max} (the wavelength of the principal T–T absorption band) were determined via a comparative method.⁴³ Seven different laser energies in the range of 0.4–1.2 mJ/pulse were used for each sample with absorbances of ~ 0.3 at 355 nm. For compound **6** in acetonitrile with absorbance ~ 0.07 (saturated solution), five different laser energies in the range of 0.9–1.6 mJ/pulse were used.

Acknowledgements

Thanks are due to the Fundação para a Ciência e a Tecnologia (FCT, Portugal) and FEDER for funding the

Organic Chemistry Research Unit and the project POCTI/QUI/46529/2002. R. F. Enes also thanks FCT for a post-doctoral grant.

Supplementary data

Supplementary data associated with this article can be found, in the online version, at doi:10.1016/j.tet.2005.09.078.

References and notes

- Fullerenes—Chemistry and Reactions; Hirsch, A., Brettreich, M., Eds.; Wiley-VCH: Weinheim, 2004.
- Sofou, P.; Elemes, Y.; Panou-Pomonis, E.; Stavrakoudis, A.; Tsikaris, V.; Sakarellos, C.; Sakarellos-Daitsiotis, M.; Maggini, M.; Formaggio, F.; Toniolo, C. *Tetrahedron* **2004**, *60*, 2823–2828.
- Bosi, S.; Da Ros, T.; Spalluto, G.; Prato, M. *Eur. J. Med. Chem.* **2003**, *38*, 913–923.
- Nakamura, E.; Isobe, H. *Acc. Chem. Res.* **2003**, *36*, 807–815.
- Tagmatarchis, N.; Shinohara, H. *Mini-Rev. Med. Chem.* **2001**, *1*, 339–348.
- Da Ros, T.; Prato, M. *Chem. Commun.* **1999**, 663–669.
- Jensen, W.; Wilson, S. R.; Schuster, D. I. *Bioorg. Med. Chem.* **1996**, *4*, 767–779.
- Vileno, B.; Sienkiewicz, A.; Lekka, M. J.; Kulik, A.; Forró, L. *Carbon* **2004**, *42*, 1195–1198.
- Tabata, y.; Ikada, Y. *Pure Appl. Chem.* **1999**, *71*, 2047–2053.
- Käsermann, F.; Kempf, C. *Rev. Med. Virol.* **1998**, *8*, 143–151.
- Bosi, S.; Feruglio, L.; Milic, D.; Prato, M. *Eur. J. Org. Chem.* **2003**, 4741–4747.
- Richardson, C. F.; Schuster, D. I.; Wilson, S. R. *Org. Lett.* **2000**, *2*, 1011–1014.
- Chi, Y.; Bhonsle, J. B.; Canteenwala, T.; Huang, J.-P.; Shiea, J.; Chen, B.-J.; Chiang, L. Y. *Chem. Lett.* **1998**, 465–466.
- Brettreich, M.; Hirsch, A. *Tetrahedron Lett.* **1998**, *39*, 2731–2734.
- Bensasson, R. V.; Bienvenüe, E.; Dellinger, M.; Leach, S.; Seta, P. *J. Phys. Chem.* **1994**, *98*, 3492–3500.
- Medinger, T.; Wilkinson, F. *Trans. Faraday Soc.* **1966**, *62*, 1785–1792.
- Quaranta, A.; McGarvey, D. J.; Land, E. J.; Brettreich, M.; Burghardt, S.; Schönberger, H.; Hirsch, A.; Gharbi, N.; Moussa, F.; Leach, S.; Göttinger, H.; Bensasson, R. V. *Phys. Chem. Chem. Phys.* **2003**, *5*, 843–848.
- Janot, J.-M.; Bienvenüe, E.; Seta, P.; Bensasson, R. V.; Tomé, A. C.; Enes, R. F.; Cavaleiro, J. A. S.; Leach, S.; Camps, X.; Hirsch, A. *J. Chem. Soc., Perkin Trans. 2* **2000**, 301–306.
- Bensasson, R. V.; Berberan-Santos, M. N.; Brettreich, M.; McGarvey, D. J.; Schönberger, H.; Schröder, C. *Phys. Chem. Chem. Phys.* **2001**, *3*, 4679–4683.
- Sharon, N.; Lis, H. *Science* **1989**, *246*, 227–234.
- Dwek, R. A. *Chem. Rev.* **1996**, *96*, 683–720.

22. Vasella, A.; Uhlmann, P.; Waldraff, C. A. A.; Diederich, F.; Thilgen, C. *Angew. Chem., Int. Ed. Engl.* **1992**, *31*, 1388–1390.
23. Yashiro, A.; Nishida, Y.; Ohno, M.; Eguchi, S.; Kobayashi, K. *Tetrahedron Lett.* **1998**, *39*, 9031–9034.
24. Kato, H.; Yashiro, A.; Mizuno, A.; Nishida, Y.; Kobayashi, K.; Shinohara, H. *Bioorg. Med. Chem. Lett.* **2001**, *11*, 2935–2939.
25. Mikata, Y.; Takagi, S.; Tanahashi, M.; Ishii, S.; Obata, M.; Miyamoto, Y.; Wakita, K.; Nishisaka, T.; Hirano, T.; Ito, T.; Hoshino, M.; Ohtsuki, C.; Tanihara, M.; Yano, S. *Bioorg. Med. Chem. Lett.* **2003**, *13*, 3289–3292.
26. Dondoni, A.; Marra, A. *Tetrahedron Lett.* **2002**, *43*, 1649–1652.
27. Isobe, H.; Mashima, H.; Yorimitsu, H.; Nakamura, E. *Org. Lett.* **2003**, *5*, 4461–4463.
28. De la Torre, M. D. L.; Rodrigues, A. G. P.; Tomé, A. C.; Silva, A. M. S.; Cavaleiro, J. A. S. *Tetrahedron* **2004**, *60*, 3581–3592.
29. Enes, R. F.; Tomé, A. C.; Cavaleiro, J. A. S. *Tetrahedron* **2005**, *61*, 1423–1431.
30. This is a variation of the method described by Petrig, J.; Schibli, R.; Dumas, C.; Alberto, R.; Schubiger, P. A. *Chem. Eur. J.* **2001**, *7*, 1868–1873.
31. Hombrecher, H. K.; Ohm, S.; Koll, D. *Tetrahedron* **1996**, *52*, 5441–5448.
32. Cudic, M.; Kojic-Prodic, B.; Milinkovic, V.; Horvat, J.; Horvat, S.; Elofsson, M.; Kihlberg, J. *Carbohydr. Res.* **1996**, *287*, 1–19.
33. Gouéth, P.; Ramiz, A.; Ronco, G.; Mackenzie, G.; Villa, P. *Carbohydr. Res.* **1995**, *266*, 171–189.
34. Cahs, I.; Yürüker, A.; Rügger, H.; Wright, A. D.; Sticher, O. *Helv. Chim. Acta* **1993**, *76*, 2563–2569.
35. Midland, M. M.; John, C. C.; Miller, J. A.; Morell, L. A. *J. Org. Chem.* **1994**, *59*, 4438–4442.
36. Bensasson, R. V.; Bienvenüe, E.; Fabre, C.; Janot, J.-M.; Land, E. J.; Leach, S.; Leboulaire, V.; Rassat, A.; Roux, S.; Seta, P. *Chem. Eur. J.* **1998**, *4*, 270–278.
37. Isaacs, L.; Wehrsig, A.; Diederich, F. *Helv. Chim. Acta* **1993**, *76*, 1231–1250.
38. Smith, A. B., III; Strongin, R. M.; Brard, L.; Frust, G. T.; Romanow, W. J. *J. Am. Chem. Soc.* **1993**, *115*, 5829–5830.
39. Anderson, L. J.; An, Y.-Z.; Rubin, Y.; Foote, C. S. *J. Am. Chem. Soc.* **1994**, *116*, 9763–9764.
40. Linschitz, H.; Steel, C.; Bell, J. A. *J. Phys. Chem.* **1962**, *66*, 2574–2576.
41. Etheridge, H. T.; Weisman, R. B. *J. Phys. Chem.* **1995**, *99*, 2782–2787.
42. Fraelich, M. R.; Weisman, R. B. *J. Phys. Chem.* **1993**, *97*, 11145–11147.
43. Bensasson, R. V.; Land, E. J.; Truscott, T. G. *Excited States and Free Radicals in Biology and Medicine—Contributions from Flash Photolysis and Pulse Radiolysis*; Oxford University Press: Oxford, 1993.
44. Bensasson, R. V.; Land, E. J. *J. Chem. Soc., Faraday Trans.* **1971**, *67*, 1904–1915.
45. Bensasson, R. V.; Hill, T.; Lambert, C.; Land, E. J.; Leach, S.; Truscott, T. G. *Chem. Phys. Lett.* **1993**, *20*, 326–335.
46. Texier, I.; Berberan-Santos, M. N.; Federov, A.; Brettreich, M.; Schönberger, H.; Hirsh, A.; Leach, S.; Bensasson, R. V. *J. Phys. Chem. A* **2001**, *105*, 10278–10285.
47. Hung, R. R.; Grabowski, J. J. *J. Phys. Chem.* **1991**, *95*, 6073–6075.
48. Schmidt, R.; Tanielian, C.; Dunsbach, R.; Wolff, C. *J. Photochem. Photobiol., A: Chem.* **1994**, *79*, 11–17.
49. Tinkler, J. H.; Tavender, S. M.; Parker, A. W.; McGarvey, D. J.; Mulroy, L.; Truscott, T. G. *J. Am. Chem. Soc.* **1996**, *118*, 1756–1761.

Efficient construction of novel α -keto spiro ketal and the total synthesis of (\pm)-terreinol

Wan-Guo Wei, Yong-Xia Zhang and Zhu-Jun Yao*

State Key Laboratory of Bioorganic and Natural Products Chemistry, Shanghai Institute of Organic Chemistry, Chinese Academy of Sciences, 354 Fenglin Road, Shanghai 200032, China

Received 8 August 2005; revised 16 September 2005; accepted 16 September 2005

Available online 25 October 2005

Abstract—The first total synthesis of (\pm)-terreinol is described. An intramolecular Pd(II)-catalyzed cycloisomerization of a 2-(1'-alkynyl)benzyl alcohol via an apparent 6-*endo* diagonal pathway led to the 1*H*-isochromene ring system, which was further converted to the desired spiro ketal via an iodine-mediated intramolecular spiro-cyclization.

© 2005 Elsevier Ltd. All rights reserved.

1. Introduction

Fungi have been one of the main resources of a wide variety of complex natural products possessing attractive biological activities.¹ For example, lovastatin (mevinolin) derived from fungus *Aspergillus terreus* is now used as a cholesterol lowering agent.² Terreinol was isolated more recently as a novel metabolite by Marsaioli and co-workers in an effort to screen enzymatic activity in malt extracts from cultures of Brazilian strains of *A. terreus*.^{3a} Its absolute configuration was determined thereafter by ¹H and ¹³C NMR experiments, allowing assignment of the *R* configuration for terreinol.^{3b} This apparently simple molecule is structurally distinguished by a highly oxygenated isochromene core bearing a novel dioxo-spiro ketal. Attracted by its unique structure and the interesting bioactivities of similar spiro-cyclic compounds, we sought to establish an efficient route for the synthesis of terreinol by using readily available materials. Herein, we report our recent achievement of the first total synthesis of (\pm)-terreinol, in which an intramolecular Pd(II)-catalyzed cycloisomerization and an intramolecular iodoetherification were employed as key steps.

2. Results and discussion

Our strategy for the synthesis of terreinol was based on two major considerations as shown in Figure 1. First, the spiro

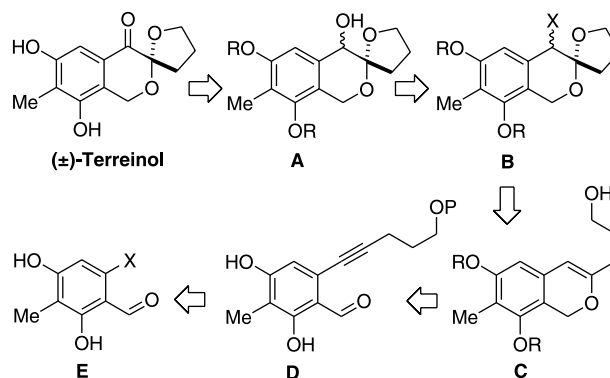

Figure 1. Retrosynthetic analysis of (\pm)-terreinol.

ketal core of **B** was to be derived from an intramolecular haloetherification reaction, while, the 1*H*-isochromene ring system of **C** was to be elaborated by an intramolecular Pd(II)-catalyzed cycloisomerization of precursor **D**. It was anticipated that the six-member ring would be formed preferentially over the five-member ring. Facile removal of the phenolic hydroxyl protections must be carefully considered in the last step. Finally, the fully functionalized precursor benzylalcohol derivative **D** could be easily prepared from readily available starting materials, such as aryl bromide **E** and terminal alkyne, by Sonogashira coupling reaction.

As outlined in Scheme 1, commencing with the commercially available 2-methylresorcinol, 2-bromobenzaldehyde **8** was prepared using a modification of the recently reported protocol by Porco et al.⁴ Accordingly,

Keywords: *Aspergillus terreus*; Catalyst; Iodoetherification.

* Corresponding author. Tel.: +86 21 54925133; fax: +86 21 64166128; e-mail: yaoz@pub.sioc.ac.cn

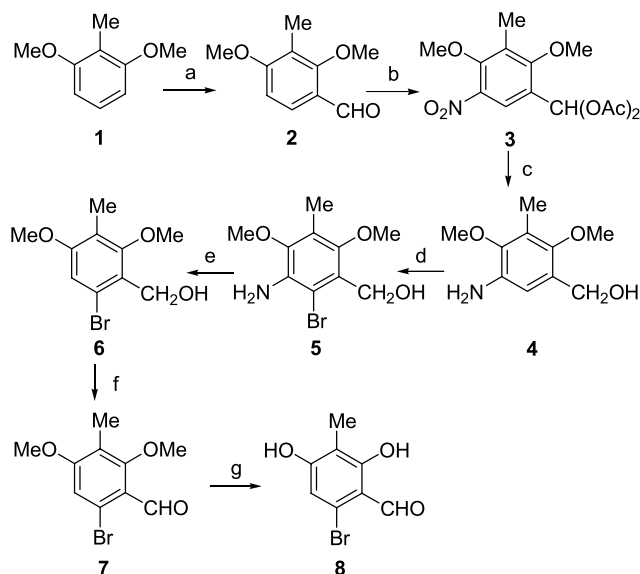

Scheme 1. Reagents and conditions: (a) POCl_3 , DMF, 60°C , 90%; (b) $\text{Cu}(\text{NO}_3)_2 \cdot 3\text{H}_2\text{O}$, Ac_2O , 94%; (c) Raney Nickel (50% in H_2O), H_2 , THF, 98%; (d) NBS (1.1 equiv), CHCl_3 , rt, 92%; (e) Conc'd HCl, THF/ H_2O , NaNO_2 then urea, 50% H_3PO_2 , 89%; (f) PCC, 4 Å sieves, CH_2Cl_2 , 0°C to rt, 87%; (g) BBr_3 , CH_2Cl_2 , -78°C to rt, 94%.

2,6-dimethoxytoluene **1** was derived from 2-methylresorcinol and acylated to give aldehyde **2**. Nitration of benzaldehyde **2** was carried out with $\text{Cu}(\text{NO}_3)_2$ in acetic anhydride to give the expected geminal diacetate **3**. Raney nickel-catalyzed reduction of the nitro group and simultaneously removal of the geminal diacetate were performed in facile fashion in THF under a H_2 atmosphere. Selective bromination of the resulting 3-aminobenzyl alcohol **4** was achieved using NBS in CHCl_3 to give *o*-bromoaniline **5** in excellent yield. Reductive removal of the amino group of **5** was carried out by diazotization followed by H_3PO_2 -based seditization in situ. Oxidation of the resultant 6-bromo-2,4-dimethoxy-3-methylbenzyl alcohol **6** occurred smoothly by using PCC and 4 Å molecular sieves in anhydrous dichloromethane to afford the corresponding benzaldehyde **7**. Finally, treatment of **7** with BBr_3 afforded

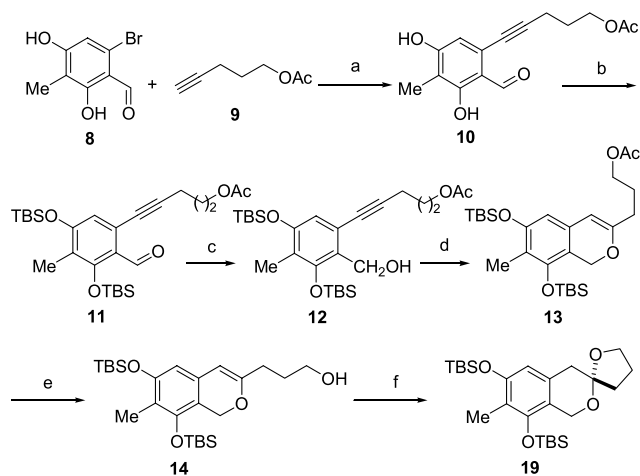

Scheme 2. Reagents and conditions: (a) 5 mol% $\text{Pd}(\text{PPh}_3)_4$, CuI, 4-pentynyl acetate **9**, Et_3N , DMF, 70°C , 92%; (b) TBSCl, imid, DMF, 87%; (c) NaBH_4 , EtOH, 0°C , 5 min, 75%; (d) 10 mol% $\text{PdCl}_2(\text{PPh}_3)_2$, 1,4-dioxane, 85°C , 72%; (e) K_2CO_3 , MeOH, rt, 97%; (f) H^+ , CDCl_3 , rt, 24 h, quantitative.

2-bromobenzaldehyde **8** in high yield. All these improvements have the advantages of more stable intermediates, high yield for each step, and ease of operation and reduplication.

The functionalized cycloisomerization precursor **10** was next prepared by a Sonogashira coupling,⁵ which linked aryl bromide **8** and terminal acetylene **9** (Scheme 2). The phenolic hydroxyls were then protected as TBS ethers **11**. Treatment of benzylaldehyde **11** with NaBH_4 in ethanol at 0°C gave the corresponding benzyl alcohol **12**. With this precursor in hand, construction of the 1*H*-isochromene structure by intramolecular ring-closure reaction of **12** was investigated. Earlier studies on this type of cycloisomerization revealed that both the substituent pattern of the substrates and the reaction conditions could influence the reaction leading either toward the 5-*exo-dig* cyclization or the 6-*endo-dig* cyclization products.⁷ A short list of Pd(II) catalysts (Table 1) were screened on **12** for their ability to promote the desired 6-*endo* cyclization. To our delight, 10 mol% of $\text{PdCl}_2(\text{PPh}_3)_2$ in 1,4-dioxane at 85°C worked very well and 1*H*-isochromene **13** was obtained as a single isomer in satisfactory yield. It is noteworthy that the unprotected phenolic benzylalcohol didn't produce any desired cycloisomerized product under such conditions. Other Pd(II) species and conditions also gave **13**, however, in lower yields or under longer reaction times (see Table 1). Theoretically, the five-member-ring product might be also produced under these conditions. However, no evidence of five-member-ring product was detected during our investigations. Treatment of acetate **13** with K_2CO_3 in methanol at rt afforded the corresponding alcohol **14** in high yield. It is noteworthy that this compound was quantitatively converted to spiro ketal **19**⁸ in CDCl_3 (weakly acidic) when left in NMR tube over 24 h.

Table 1. Synthesis of 1*H*-isochromene **13** by Pd(II)-catalyzed cycloisomerization of **12**

Entry ^a	Catalyst (mol%)	<i>T</i> ($^\circ\text{C}$)	Time (h)	Product (%)
1	10% PdCl_2	85	1.0	64
2	10% $\text{Pd}(\text{OAc})_2$	85	5.0	14
3	10% $\text{PdCl}_2(\text{PPh}_3)_2$	85	1.5	72
4	5% $\text{PdCl}_2(\text{PPh}_3)_2$	85	6.0	68
5	5% PdI_2	85	4.0	64
6	10% $\text{Pd}(\text{PhCN})_2\text{Cl}_2$	85	1.5	60

^a The reactions were all carried out in 1,4-dioxane as the solvent.

The final key transformation to achieve our ultimate synthetic object was to establish the spiro ketal functionality. It was anticipated that an intramolecular iodoetherification reaction could be utilized for this key transformation. It is well known that iodoetherification is a powerful method for the construction of THF rings from the corresponding γ -hydroxyalkenes. This is also an efficient method to functionalize olefinic double bonds.⁹ Treatment of compound **14** with 2 equiv of iodine in a mixture of CH_3CN and aq NaHCO_3 (10:1, v:v) at ambient temperature gave the desired spiro ketal **15**. The iodide **15** was immediately substituted by hydroxide in situ to furnish **16** as a mixture of isomers (ca. 35:1) at rt in 86% overall yield (from **14**). Dess–Martin oxidation¹⁰ of the resulting

mixture afforded **17** quantitatively as a single product. Finally, global deprotection¹¹ was achieved using TBAF in THF, to give racemic terreinol in excellent yield (Scheme 3). Data for terreinol obtained by this route were identical with those reported for natural material.³

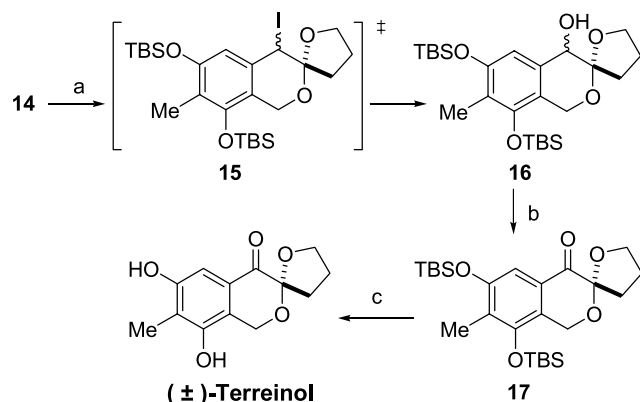

Scheme 3. Reagents and conditions: (a) I_2 , CH_3CN , aq $NaHCO_3$, rt, 86%; (b) Dess–Martin periodinane, CH_2Cl_2 , 97%; (c) TBAF, THF, rt, 98%.

3. Conclusions

In conclusion, we have disclosed the first total synthesis of the fungal metabolite terreinol. The palladium(II)-catalyzed cycloisomerization of 2-(1'-alkynyl)benzyl alcohol **12** efficiently furnished the key precursor 1*H*-isochromene **13**. The spiro ketal was subsequently elaborated by iodoetherification of alcohol **14**. Further investigations including the enantioselective synthesis of the corresponding spiro cycles and bioactivity studies of this novel metabolite are currently underway.

4. Experimental

4.1. General methods

¹H NMR spectra were recorded at 300 or 400 MHz at ambient temperature with $CDCl_3$ as the solvent unless otherwise stated. ¹³C NMR spectra were recorded at 100 MHz at ambient temperature with $CDCl_3$ as the solvent unless otherwise stated. All melting points were uncorrected. Infrared (IR) spectra were obtained using a Fourier transform infrared spectrometer (FTIR). Flash column chromatography was performed on silica gel (10–40 μ m) using a mixture of petroleum ether and ethyl acetate as the eluent.

4.1.1. (5-Amino-2,4-dimethoxy-3-methylphenyl)methanol (4). A solution of **3** (8.5 g, 26.0 mmol) in 150 mL THF was treated with Raney Nickel (50% in H_2O , 10.0 g). The resulting mixture was hydrogenated under H_2 at rt and the reaction process was monitored by TLC. After completion of the reaction, the mixture was filtered through Celite and washed with ethyl acetate. The filtrate was concentrated under reduced pressure to give **4** (5.0 g, 98%) as a pale yellow solid, which was employed in the next step without further purification. Recrystallization of the product from hexane and ethyl acetate afforded colorless crystal for

characterization. Mp 75–77 °C. ¹H NMR (300 MHz, $CDCl_3$): δ 6.58 (1H, s), 4.59 (2H, s), 3.72 (3H, s), 3.71 (3H, s), 3.60–2.80 (2H, br s), 2.21 (3H, s) ppm. IR (KBr): ν_{max} 3394, 3251, 3145, 1598, 1485, 1419, 1212, 1101, 1008, 834 cm^{-1} . ESI-MS (m/z): 198 ($M+H^+$). Anal. Calcd for $C_{10}H_{15}NO_3$: C, 60.90; H, 7.67; N, 7.10. Found: C, 61.06; H, 7.31; N, 7.09.

4.1.2. (3-Amino-2-bromo-4,6-dimethoxy-5-methylphenyl)methanol (5). To a solution of **4** (1.0 g, 5.1 mmol) in $CHCl_3$ (20 mL) was added NBS (990 mg, 5.6 mmol). The mixture was stirred at rt for 5 min, and then aq $Na_2S_2O_3$ solution was added to quench the reaction. The mixture was extracted with ethyl acetate for three times and combined organic layers were washed extensively with H_2O and finally brine. The organic extracts were dried over Na_2SO_4 , filtered, concentrated and the residue was purified by silica gel column (hexane/ethyl acetate = 4:1) to afford **5** (1.3 g, 92%) as a pale yellowish oil. ¹H NMR (300 MHz, $CDCl_3$): δ 4.76 (2H, s), 4.10 (2H, br s), 3.72 (3H, s), 3.71 (3H, s), 2.50 (1H, br s), 2.17 (3H, s) ppm. IR (film): ν_{max} 3455, 3361, 2941, 1608, 1575, 1459, 1415, 1247, 1195, 1126, 1107, 1006, 981 cm^{-1} . HRMS (ESI, m/z) calcd for $C_{10}H_{15}BrNO_3$ ($M+H^+$): 276.0235; found: 276.0231.

4.1.3. Acetic acid 5-(2-formyl-3,5-dihydroxy-4-methylphenyl)pent-4-ynyl ester (10). To a mixture of 2-bromobenzaldehyde **8** (20 g, 86.6 mmol), alkyne **9** (13 g, 103.9 mmol), $Pd(PPh_3)_4$ (5.0 g, 4.3 mmol), CuI (840 mg, 4.4 mmol) in degassed DMF (70 mL) was added Et_3N (36 mL) under inert atmosphere. The resulting mixture was heated and then stirred at 70 °C for about 6 h. The solvent was removed under reduced pressure and the residue was purified directly on silica gel column (hexane/ethyl acetate = 5:1). The obtained crude product was then crystallized from hexane and ethyl acetate, affording **10** (22 g, 92%) as a white solid. Mp 97–99 °C. ¹H NMR (300 MHz, $CDCl_3$): δ 12.27 (1H, s), 10.16 (1H, s), 7.50 (1H, br s), 6.51 (1H, s), 4.25 (2H, t, $J=6.3$ Hz), 2.56 (2H, t, $J=6.9$ Hz), 2.11 (3H, s), 2.10 (3H, s), 2.01–1.92 (2H, m) ppm. ¹³C NMR (100 MHz, $CDCl_3$): δ 195.0, 172.1, 163.1, 161.40, 161.36, 126.8, 114.2, 112.6, 112.2, 95.2, 63.5, 27.6, 21.0, 16.4, 7.2. IR (KBr): ν_{max} 3379, 1711, 1635, 1609, 1588, 1422, 1367, 1303, 1251, 1139, 1107, 1049, 834, 769, 586 cm^{-1} . ESI-MS (m/z): 274 ($M+H^+$). Anal. Calcd for $C_{15}H_{16}O_5$: C, 65.21; H, 5.84. Found: C, 65.18; H, 5.81.

4.1.4. Acetic acid 5-[3,5-bis(*tert*-butyldimethylsilyloxy)-2-formyl-4-methylphenyl]pent-4-ynyl ester (11). A mixture of phenol **10** (2.0 g, 5.9 mmol), imidazole (2.4 g, 35.5 mmol) and TBSCl (4.5 g, 29.6 mmol) in anhydrous DMF (6.0 mL) was stirred at rt for about 4 h under N_2 atmosphere. The mixture was then diluted with ethyl acetate (100 mL) and water (30 mL). The organic layer was separated and washed with H_2O (4 \times 30 mL), brine, dried over Na_2SO_4 , filtered, and concentrated. The crude product was purified by silica gel column (hexane/ethyl acetate = 50:1) to give **11** (2.6 g, 87%) as a colorless oil. ¹H NMR (300 MHz, $CDCl_3$): δ 10.31 (1H, s), 6.61 (1H, s), 4.28 (2H, t, $J=6.3$ Hz), 2.59 (2H, t, $J=6.9$ Hz), 2.09 (3H, s), 2.08 (3H, s), 2.07–1.98 (2H, m), 1.06 (9H, s), 1.04 (9H, s), 0.28 (6H, s), 0.15 (6H, s) ppm. ¹³C NMR (100 MHz, $CDCl_3$): δ 189.4, 171.0, 159.2, 157.5, 123.8, 123.1, 122.2, 118.2, 93.9,

79.2, 63.2, 27.7, 25.9 ($\times 3$), 25.7 ($\times 3$), 20.9, 18.6, 18.3, 16.6, 10.9, -3.6 (-2), -4.1 ($\times 2$) ppm. IR (film): ν_{\max} 2957, 2932, 1745, 1696, 1576, 1548, 1473, 1237, 1153, 840, 827 cm^{-1} . HRMS (ESI, m/z) calcd for $\text{C}_{27}\text{H}_{45}\text{O}_5\text{Si}_2$ ($\text{M} + \text{H}^+$): 505.2806; found: 505.2804.

4.1.5. Acetic acid 5-[3,5-bis(*tert*-butyldimethylsilyloxy)-2-hydroxymethyl-4-methylphenyl]pent-4-ynyl ester (12). To a pre-cooled solution of aldehyde **11** (1.5 g, 3.0 mmol) in ethanol (40 mL) was added NaBH_4 (170 mg, 4.5 mmol) at 0°C . 5 min later, aq NH_4Cl was added slowly to quench the reaction. The mixture was then diluted with ethyl acetate (200 mL). The organic layer was separated and washed with H_2O and brine, dried over Na_2SO_4 , filtered, concentrated. The residue was purified by silica gel column chromatography (hexane/ethyl acetate=4:1) to give **12** (1.1 g, 75%) as a colorless oil. ^1H NMR (300 MHz, CDCl_3): δ 6.56 (1H, s), 4.71 (2H, d, $J=6.3$ Hz), 4.24 (2H, t, $J=6.3$ Hz), 2.55 (2H, t, $J=7.2$ Hz), 2.45 (1H, t, $J=6.3$ Hz), 2.07 (s, 3H), 2.06 (s, 3H), 2.00–1.91 (m, 2H), 1.04 (s, 9H), 1.00 (s, 9H), 0.21 (s, 6H), 0.18 (s, 6H) ppm. ^{13}C NMR (100 MHz, CDCl_3): δ 171.1, 154.1, 152.6, 127.1, 121.8, 121.0, 116.5, 91.9, 79.6, 63.1, 58.9, 27.9, 26.1 ($\times 3$), 25.8 ($\times 3$), 20.9, 18.7, 18.3, 16.4, 11.9, -3.6 ($\times 2$), -4.2 ($\times 2$) ppm. IR (film): ν_{\max} 3600, 2958, 2860, 1744, 1593, 1556, 1472, 1254, 1145, 1114, 898, 828, 782 cm^{-1} . HRMS (ESI, m/z) calcd for $\text{C}_{27}\text{H}_{46}\text{O}_5\text{Si}_2\text{Na}$ ($\text{M} + \text{Na}^+$): 529.2781; found 529.2774.

4.1.6. Acetic acid 3-[6,8-bis(*tert*-butyldimethylsilyloxy)-7-methyl-1*H*-2-benzopyran-3-yl]propyl ester (13). To a mixture of **12** (120 mg, 0.24 mmol) in 1,4-dioxane (60 mL) was added $\text{PdCl}_2(\text{PPh}_3)_2$ (17 mg, 0.024 mmol) under N_2 . The mixture was warmed to 85°C and stirred at same temperature for 4 h. The solvent was removed under reduced pressure, and the residue was purified directly on silica gel column (hexane/ethyl acetate=20:1) to afford **13** (86 mg, 72%) as a colorless oil. ^1H NMR (300 MHz, CDCl_3): δ 6.12 (1H, s), 5.56 (1H, s), 4.98 (2H, s), 4.13 (2H, t, $J=6.6$ Hz), 2.26 (2H, t, $J=7.5$ Hz), 2.06 (3H, s), 2.03 (3H, s), 1.95–1.86 (2H, m), 1.03 (9H, s), 1.01 (9H, s), 0.20 (6H, s), 0.15 (6H, s) ppm. ^{13}C NMR (100 MHz, CDCl_3): δ 171.1, 156.7, 154.3, 149.3, 130.2, 118.3, 111.2, 107.5, 101.7, 65.0, 63.9, 30.1, 26.2, 26.0 ($\times 3$), 25.8 ($\times 3$), 20.9, 18.6, 18.3, 11.4, -3.5 ($\times 2$), -4.2 ($\times 2$) ppm. IR (film): ν_{\max} 2931, 2860, 1650, 1604, 1566, 1474, 1423, 1257, 1127, 840, 780 cm^{-1} . MALDI-FTMS (DHB, m/z) calcd for $\text{C}_{27}\text{H}_{46}\text{O}_5\text{Si}_2\text{Na}$ ($\text{M} + \text{Na}^+$): 529.2781; found 529.2761.

4.1.7. 3-[6,8-Bis(*tert*-butyldimethylsilyloxy)-7-methyl-1*H*-2-benzopyran-3-yl]propan-1-ol (14). To a solution of **13** (80 mg, 0.16 mmol) in methanol (10 mL) was added K_2CO_3 (87 mg, 0.63 mmol). The whole mixture was stirred at rt for 2 h. The mixture was then diluted with CH_2Cl_2 (100 mL) and saturated NH_4Cl solution (20 mL). The organic layer was separated and then washed with H_2O and brine, dried over Na_2SO_4 , filtered, concentrated. The residue was purified by silica gel chromatography (hexane/ethyl acetate=4:1) to afford alcohol **14** (71 mg, 97%) as a colorless oil. ^1H NMR (300 MHz, CDCl_3): δ 6.13 (1H, s), 5.58 (1H, s), 4.99 (2H, s), 3.72 (2H, t, $J=5.7$ Hz), 2.29 (2H, t, $J=7.2$ Hz), 2.03 (3H, s), 1.88–1.79 (2H, m), 1.04 (9H, s), 1.01 (9H, s), 0.20 (6H, s), 0.15 (6H, s) ppm. ^{13}C NMR

(100 MHz, CDCl_3): δ 157.2, 154.3, 149.2, 130.2, 118.4, 111.1, 107.5, 101.7, 64.9, 62.3, 30.2, 30.0, 25.9 ($\times 3$), 25.8 ($\times 3$), 18.5, 18.3, 11.4, -3.6 ($\times 2$), -4.2 ($\times 2$) ppm. IR (film): ν_{\max} 3464, 2932, 2860, 1744, 1652, 1604, 1567, 1474, 1423, 1256, 1128, 1049, 973, 840, 781 cm^{-1} . MALDI-FTMS (DHB, m/z) calcd for $\text{C}_{25}\text{H}_{44}\text{O}_4\text{Si}_2\text{Na}$ ($\text{M} + \text{Na}^+$): 487.2676; found 487.2683.

4.1.8. Compound 16. To a solution of alcohol **14** (80 mg, 0.17 mmol) in CH_3CN (50 mL) and aq NaHCO_3 (5 mL) was added iodine (87 mg, 0.34 mmol). The mixture was stirred at rt overnight, and then quenched by aq $\text{Na}_2\text{S}_2\text{O}_3$, extracted with ethyl acetate (3×50 mL). The combined organic phases were washed with H_2O and brine, dried over anhydrous Na_2SO_4 , filtered and concentrated. The residue was purified on silica gel column (hexane/ethyl acetate=5:1) to give **16** (72 mg, 86%) as mixture of two isomers. Data of the major isomer (70 mg): ^1H NMR (300 MHz, CDCl_3): δ 6.55 (1H, s), 4.69 (2H, s), 4.16 (1H, d, $J=10.2$ Hz), 4.05–4.00 (2H, m), 2.18–2.14 (2H, m), 2.05 (3H, s), 2.00–1.96 (2H, m), 1.01 (18H, s), 0.22 (12H, s) ppm. ^{13}C NMR (100 MHz, CDCl_3): δ 153.8, 149.9, 132.7, 120.3, 117.7, 113.1, 107.2, 69.6, 69.4, 60.4, 34.5, 26.1 ($\times 3$), 25.8 ($\times 3$), 23.8, 18.8, 18.3, 11.4, -2.8 , -3.0 , -4.1 , -4.2 ppm. IR (film): ν_{\max} 3423, 2931, 2860, 1608, 1585, 1474, 1256, 1126, 1041, 904, 833, 780 cm^{-1} . HR-MS (ESI, m/z) calcd for $\text{C}_{25}\text{H}_{44}\text{O}_5\text{Si}_2\text{Na}$ ($\text{M} + \text{Na}^+$) 503.2625; found 503.2621.

4.1.9. Compound 17. To a solution of alcohol **16** (58 mg, 0.12 mmol) in dichloromethane (10 mL) was added Dess–Martin periodinane¹⁰ (76 mg, 0.18 mmol) at rt. The reaction was stirred for 3 h and quenched by adding aq $\text{Na}_2\text{S}_2\text{O}_3$ and aq NaHCO_3 . Stirring was continued until the mixture turned clear. The mixture was extracted with ethyl acetate (3×50 mL). The combined organic layers were washed with water and brine, dried over Na_2SO_4 , filtered, concentrated. Purification on silica gel column (hexane/ethyl acetate=10:1) gave **17** (56 mg, 97%) as a colorless oil. ^1H NMR (400 MHz, CDCl_3): δ 7.17 (1H, s), 5.01 (1H, d, $J=15.4$ Hz), 4.74 (1H, d, $J=15.4$ Hz), 4.14–4.06 (1H, m), 4.04 (1H, dd, $J=14.6$, 7.7 Hz), 2.73 (1H, dt, $J=12.9$, 8.8 Hz), 2.16–2.08 (2H, m), 2.12 (3H, s), 1.88 (1H, ddd, $J=12.7$, 8.1, 4.4 Hz), 1.03 (9H, s), 1.01 (9H, s), 0.234 (3H, s), 0.230 (3H, s), 0.20 (3H, s), 0.19 (3H, s) ppm. ^{13}C NMR (100 MHz, CDCl_3): δ 188.9, 154.2, 149.7, 127.7, 127.0, 126.4, 109.8, 105.4, 70.2, 59.1, 33.1, 26.0 ($\times 3$), 25.8 ($\times 3$), 24.9, 18.7, 18.3, 12.1, -2.9 , -3.3 , -4.3 ($\times 2$) ppm. IR (film): ν_{\max} 2958, 2932, 1702, 1597, 1467, 1321, 1261, 1133, 1050, 886, 829, 782 cm^{-1} . HR-MS (ESI, m/z) calcd for $\text{C}_{25}\text{H}_{42}\text{O}_5\text{Si}_2\text{Na}$ ($\text{M} + \text{Na}^+$) 501.2468; found 501.2463.

4.1.10. (\pm)-Terreinol. A solution of compound **17** (42 mg, 0.088 mmol) in THF (10 mL) was treated with TBAF (1.0 M in THF, 170 μL , 0.17 mmol) at rt for 10 min. The solvent was removed under reduced pressure. The residue was purified directly on silica gel column (hexane/ethyl acetate=5:1) to afford racemic terreinol (22 mg, 98%) as a white wax. ^1H NMR (400 MHz, CD_3OD): δ 6.97 (1H, s), 4.94 (1H, d, $J=15.7$ Hz), 4.74 (1H, d, $J=15.7$ Hz), 4.08–4.03 (1H, m), 3.97 (1H, dd, $J=15.1$, 7.6 Hz), 2.63 (1H, dt, $J=12.8$, 8.8 Hz), 2.13 (3H, s), 2.13–2.09 (1H, m), 2.04–2.00 (1H, m), 1.89 (1H, ddd, $J=12.7$, 8.1,

4.5 Hz) ppm. ^{13}C NMR (100 MHz, CD_3OD): δ 191.2, 157.1, 152.8, 128.3, 123.5, 121.2, 107.1, 105.2, 71.5, 60.1, 34.2, 26.3, 9.8 ppm. IR (KBr): ν_{max} 3405, 2509, 2075, 1690, 1438, 1353, 1119, 974 cm^{-1} . HR-MS (ESI, m/z) calcd for $\text{C}_{13}\text{H}_{14}\text{O}_5\text{Na}$ ($\text{M} + \text{Na}^+$) 273.0739; found 273.0736.

Acknowledgements

This work was financially supported by the Major State Basic Research and Development Program (G2000077500), NSFC (20432020, 20425205 and 20321202), the Chinese Academy of Sciences (KGCX2-SW-209) and Shanghai Municipal Commission of Science and Technology (04DZ14901). The authors thank Dr. Terrence R. Burke, Jr. for helpful comments.

References and notes

1. Simpson, T. J. *Top. Curr. Chem.* **1998**, *195*, 1.
2. Alberts, A. W.; Chen, J.; Kuron, G.; Hunt, V.; Huff, J.; Hoffman, C.; Rothrock, J.; Lopez, M.; Joshua, H.; Harris, E.; Patchett, A.; Monaghan, R.; Currie, S.; Stapley, E.; Albers-Schonberg, G.; Hensens, O.; Hirshfield, J.; Hoogsteen, K.; Liesch, J.; Springer, J. *Proc. Natl. Acad. Sci. U.S.A.* **1980**, *77*, 3957.
3. (a) Macedo, F. C., Jr.; Porto, A. L. M.; Marsaioli, A. J. *Tetrahedron Lett.* **2004**, *45*, 53–55. (b) DeMacedo, F. C., Jr.; Marsaioli, A. J. *Magn. Reson. Chem.* **2005**, *43*, 251–255.
4. Zhu, J.-L.; Germain, A. R.; Porco, J. A., Jr. *Angew. Chem., Int. Ed.* **2004**, *43*, 1239–1243.
5. Fkyerat, A.; Dubin, G.-M.; Tabacchi, R. *Helv. Chim. Acta* **1999**, *82*, 1418–1422.
6. White, J. D.; Kim, T.-S.; Nambu, M. *J. Am. Chem. Soc.* **1997**, *119*, 103–111.
7. (a) Weingarten, M. D.; Padwa, A. *Tetrahedron Lett.* **1995**, *36*, 4717–4720. (b) Hiroya, K.; Jouka, R.; Kameda, M.; Yasuhara, A.; Sakamoto, T. *Tetrahedron* **2001**, *57*, 9697–9710. (c) Gabriele, B.; Salerno, G.; Fazio, A.; Pittelli, R. *Tetrahedron* **2003**, *59*, 6251–6259.
8. Data for compound (**19**): ^1H NMR (300 MHz, CDCl_3) δ 6.23 (1H, s), 4.65 (2H, s), 3.97 (2H, t, $J=6.9$ Hz), 3.09 (1H, d, $J=16.5$ Hz), 2.68 (1H, d, $J=16.5$ Hz), 2.15–1.82 (4H, m), 2.00 (3H, s), 0.98 (9H, s), 0.97 (9H, s), 0.17 (6H, s), 0.15 (6H, s) ppm.
9. (a) Rousseau, G.; Robin, S. *Tetrahedron* **1998**, *54*, 13681. (b) Harding, K. E.; Tinger, T. H. In Trost, B. M., Fleming, I., Eds.; *Comprehensive Organic Synthesis*; Pergamon: Oxford, 1991; Vol. 4, p 463. (c) Mulzer, J. In *Organic Synthesis Highlights*; Mulzer, J., Altenbach, H. J., Braun, M., Krohn, K., Reissig, H. U., Eds.; VCH: Weinheim, 1991; p 157.
10. (a) Dess, B. D.; Martin, J. C. *J. Org. Chem.* **1983**, *48*, 4155–4156. (b) Ireland, R. E.; Liu, L. *J. Org. Chem.* **1993**, *58*, 2899. (c) Frigerio, M.; Santagostino, M.; Sputore, S. *J. Org. Chem.* **1999**, *64*, 4537–4538.
11. The *O,O'*-dimethyl derivative of (\pm)-terreinol was also synthesized by a similar way. However, the final deprotections were unsuccessful by using a variety of conditions.

Organocatalysts of tertiary-phosphines and amines catalyzed reactions of α -keto esters with cyclopent-2-enone

Min Shi* and Wen Zhang

State Key Laboratory of Organometallic Chemistry, Shanghai Institute of Organic Chemistry, Chinese Academy of Science, 354 Fenglin Road, Shanghai 200032, China

Received 25 July 2005; revised 12 September 2005; accepted 16 September 2005

Available online 7 October 2005

Abstract—The reaction of α -keto esters with cyclopent-2-enone catalyzed by tertiary-phosphines provides the corresponding Baylis–Hillman adducts. Among the catalysts, diphenylmethylphosphine was found to be the most effective promoter allowing the reaction to proceed smoothly at room temperature and to give the corresponding adducts in higher yields in the presence of *p*-nitrophenol. Whereas, the similar reaction of α -keto esters with cyclopent-2-enone catalyzed by tertiary-amine of DBU furnishes the corresponding aldol adducts with *syn*-configuration exclusively.

© 2005 Elsevier Ltd. All rights reserved.

1. Introduction

Baylis–Hillman reaction is a superior carbon–carbon bond-forming reaction¹ that furnishes products of high functional-group density from relatively simple starting materials.² In a broad sense, the Baylis–Hillman reaction can be regarded as a one-pot combination of Michael and aldol reactions. Highly basic amines,³ phosphines,⁴ Lewis-acid catalysts⁵ have been employed for performing the Baylis–Hillman reaction of aldehydes with α,β -unsaturated ketones such as methyl vinyl ketone (MVK) or esters such as methyl acrylate. In addition, Basavaiah and co-workers reported a new Baylis–Hillman reaction between α -keto esters and acrylonitrile or methyl acrylate catalyzed by DABCO to give the corresponding adducts in moderate to good yields.⁶ In the mean time, they also found that the titanium tetrachloride (TiCl₄) mediated reaction of α -keto esters with 5,5-dimethylcyclohex-2-enone produces the corresponding Baylis–Hillman adducts exclusively, whereas a similar reac-

tion of α -keto esters with cyclohex-2-enone furnishes the corresponding aldol adducts, which clearly demonstrated the role of the steric factors in directing the reaction pathway.^{5f}

More recently, organocatalysts, metal-free organic compounds, which exhibit catalytic abilities in organic reactions, have received much attention because of their advantages from an environmental as well as a resource standpoint.⁷ During our ongoing investigation on the Baylis–Hillman reaction, we reported that either ‘normal’ or ‘abnormal’ Baylis–Hillman adducts could be formed depending on the employed organocatalysts (Lewis base promoters) under otherwise identical conditions.⁸ In this article, we describe an interesting organocatalyst mediated reaction of α -keto esters with cyclopent-2-enone to provide two kinds of functionalized tertiary alcohols in the presence of organocatalysts of diphenylmethylphosphine (PPh₂Me) and 1,8-diazabicyclo[5.4.0]undec-7-ene (DBU), respectively, (Scheme 1).

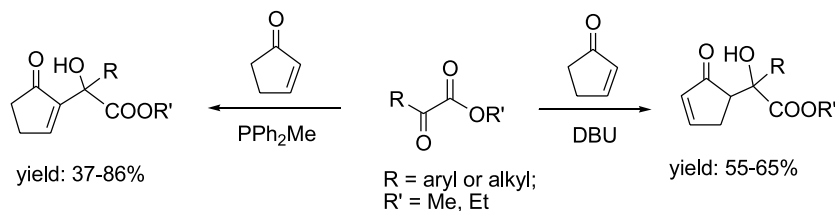

Scheme 1. Baylis-Hillman/aldol reaction of α -keto esters with cyclopent-2-enone.

Keywords: Phosphines; α -Keto esters; Cyclopent-2-enone; Baylis–Hillman reaction; Aldol reaction; DBU.

* Corresponding author. Fax: +86 21 64166128; e-mail: mshi@pub.sioc.ac.cn

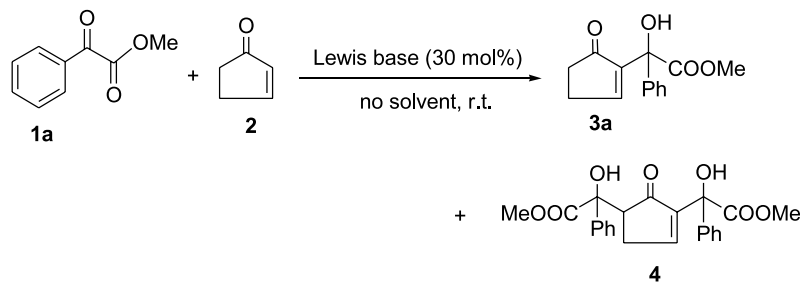
Table 1. Baylis–Hillman reaction between methyl phenylglyoxylate (**1a**) with cyclopent-2-enone in the presence of various Lewis bases^a

Entry	Lewis base	Time (h)	3a (%) ^b	4 (%) ^b
1	PBu ₃	72	65	34
2 ^c	PBu ₃	72	17	0.7
3 ^d	PBu ₃	72	29	11
4	PPhMe ₂	72	43	15
5	PPh ₂ Me	72	68	13
6 ^e	PMe ₃	120	—	—
7 ^e	PPh ₃	120	—	—
8 ^e	DBU	120	—	—
9 ^e	DABCO	120	—	—
10	DMAP	72	46	5

^a Compounds **1a** (0.3 mmol), cyclopent-2-enone **2** (0.6 mmol), and Lewis base (0.1 mmol) were used at room temperature.

^b Isolated yields.

^c Compounds **1a** (0.6 mmol) and **2** (0.3 mmol) were used in the reaction.

^d Compounds **1a** (0.3 mmol) and **2** (0.3 mmol) were used in the reaction.

^e No reaction took place.

2. Results and discussion

2.1. Baylis–Hillman reaction of α -keto esters with cyclopent-2-enone catalyzed by tertiary-phosphines

Our efforts to seek out the optimized reaction conditions were first focused on the reaction mechanism of the Baylis–Hillman reaction. Since the first step in the Baylis–Hillman reaction involves a Michael addition of the organocatalyst on the olefinic moiety of the employed activated olefins, nucleophilic and steric characters of the organocatalyst should be of great importance in the efficiency of the process. As a model, we used methyl phenylglyoxylate **1a** and cyclopent-2-enone **2** as reactants to examine the suitable reaction conditions in the presence of various nitrogen or phosphine containing organocatalysts (Lewis bases). These reactions were conducted by using 30 mol% of various organocatalysts under solvent free conditions at room temperature. Representative results are highlighted in Table 1. We found that tributylphosphine (PBu₃), phenyldimethylphosphine (PPhMe₂), and diphenylmethylphosphine (PPh₂Me) were much more effective than other tested organocatalysts such as triphenylphosphine (PPh₃) to give the corresponding Baylis–Hillman adduct **3a** in good yields along with the formation of a byproduct **4a** in low yields under identical conditions, suggesting that nucleophilicity of the organocatalyst prevails in the catalytic activity (Table 1, entries 1–7). The excess amount of cyclopent-2-enone **2** (molar ratio of **1a**:**2** = 1:2) is required to give **3a** in higher yield (Table 1, entries 1–3). DBU and DABCO showed no catalytic abilities in this reaction although in the presence of DMAP, **3a** was obtained in 46% yield along with 5% of **4a** (Table 1, entries 8–10). Diphenylmethylphosphine is the best organocatalyst

(Lewis base promoter) in this reaction. It should be noted that no reaction occurred using methyl vinyl ketone (MVK), cyclohexane-2-enone or cycloheptanone-2-enone as Michael acceptor in this reaction. In addition, in the presence of organic solvents such as THF, toluene and dichloromethane, no reaction occurred either.

To demonstrate the usefulness of this tertiary phosphine-catalyzed Baylis–Hillman reaction, a variety of α -keto esters were tested (Table 2). Various substituted aryl α -keto esters are suitable for this PPh₂Me-catalyzed reaction to give the corresponding Baylis–Hillman products **3** along with trace of byproducts **4**. However, in some cases the corresponding Baylis–Hillman products **3** were obtained in low yields (Table 2, entries 1–8). Therefore, we attempted to improve the yields of **3** under the similar conditions. On the basis of the recent investigation on the Baylis–Hillman reaction, several reports showed that using phenol as an additive, the Baylis–Hillman reaction rate can be accelerated, although the exact role of the additive is not yet clear.⁹ We believe that phenol can act as an intermolecular H-bonding donor (a phenolic Brønsted acid as a Lewis acid catalyst) to accelerate the reaction. In fact, we found that in all of these cases with the addition of 30 mol% of *p*-nitrophenol, the corresponding Baylis–Hillman reaction proceeded smoothly to give the corresponding adduct in higher yield in comparison with the corresponding phenol-free Baylis–Hillman reactions (Table 2, entries 1–8). It seems to us that phenolic compound having stronger acidity such as *p*-nitrophenol ($pK_a=7.15$) gives better results than others (Table 2, entry 4).¹⁰ This PPh₂Me/*p*-nitrophenol mediated reaction was then successfully applied to a variety of alkyl α -keto esters to give the corresponding Baylis–Hillman adducts in good yields (Table 2, entries 9 and 10).

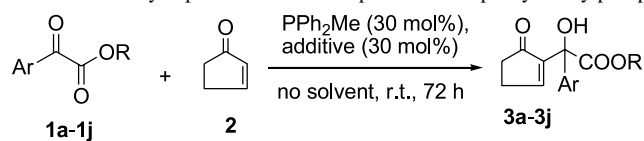
Table 2. Baylis–Hillman reaction of α -keto esters with cyclopent-2-enone in the presence of diphenylmethylphosphine^a

Entry	1	Additive (pK _a) ^b	Yield (%) ^c
1	 1a	— ^d	68
2	 1b	— ^d <i>p</i> -NO ₂ C ₆ H ₄ OH (7.15)	65 72
3	 1c	— ^d <i>p</i> -NO ₂ C ₆ H ₄ OH	38 60
4	 1d	— ^d <i>p</i> -NO ₂ C ₆ H ₄ OH C ₆ H ₅ OH (9.99) <i>p</i> -CH ₃ OC ₆ H ₄ OH (10.21)	32 71 54 47
5	 1e	<i>p</i> -NO ₂ C ₆ H ₄ OH	63
6	 1f	<i>p</i> -NO ₂ C ₆ H ₄ OH	63
7	 1g	<i>p</i> -NO ₂ C ₆ H ₄ OH	37
8	 1h	<i>p</i> -NO ₂ C ₆ H ₄ OH	46
9	 1i	<i>p</i> -NO ₂ C ₆ H ₄ OH	73
10	 1j	<i>p</i> -NO ₂ C ₆ H ₄ OH	86

^a Compounds **1** (0.3 mmol), **2** (0.6 mmol) and PPh₂Me (0.1 mmol) were used at room temperature and the reaction was carried out for 72 h.

^b Refers to the pK_a of the various phenols in H₂O at 25 °C.¹⁰

^c Isolated yields.

^d No additive was used.

2.2. Aldol reaction of α -keto esters with cyclopent-2-enone catalyzed by amines

Interestingly, we found that using 1,8-diazabicyclo[5.4.0]-undec-7-ene (DBU) as a organocatalyst in the reaction of α -keto ester with cyclopent-2-enone produced the corresponding aldol reaction product. Although our main aim was not directed toward aldol reaction, we were fascinated by the formation of the aldol reaction product **5a** because this aldol reaction product was formed exclusively as *syn*-configuration using DBU as a catalyst. A carefully literature survey reveals that although aldehydes have been very extensively used as electrophiles in various stereoefficient aldol carbon–carbon bond-forming reactions,¹¹ the direct applications of α -keto esters¹² in aldol reactions have been relatively less studied and the aldol reaction of α -keto esters with cyclopent-2-enone catalyzed by amine has not been reported so far. Therefore, we attempted to screen the optimal reaction conditions of this aldol reaction. The results are summarized in Table 3. We can see from the Table 3 that the solvent significantly effects the reaction (Table 3, entries 1–12). In neat condition, no aldol reaction product was formed with 8–25 mol% of DBU (Table 3, entries 2–4, also see Table 1, entry 8). With 50 mol% of DBU as a catalyst, **5a** was obtained in 10% yield after 30 h (Table 3, entry 1). In organic solvents, **5a** was produced in 8–64% yield with 12.5–25 mol% of DBU. DMF and toluene are the solvent of choice to give **5a** in good yields, although a prolonged reaction time is required in toluene (Table 3, entries 8 and 11). In other solvents, **5a** was produced in lower yields, for example, in methanol only 8% yield of the product was obtained. Various amounts of DBU in this

Table 3. Optimization of the aldol reaction of methyl phenylglyoxylate **1a** with cyclopent-2-enone in the presence of DBU^a

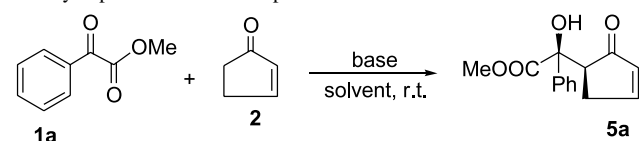

Entry	Base (mol%)	Solvent	Time (h)	Yield (%) ^b
1 ^c	DBU (50)	—	30	10
2 ^c	DBU (25)	—	48	—
3 ^c	DBU (12.5)	—	48	—
4 ^c	DBU (8)	—	72	—
5	DBU (25)	THF	72	Trace
6	DBU (25)	CH ₂ Cl ₂	72	42
7	DBU (25)	MeCN	72	32
8	DBU (25)	DMF	12	64
9	DBU (25)	DMSO	12	40
10	DBU (25)	MeOH	12	8
11	DBU (25)	PhCH ₃	48	64
12	DBU (12.5)	DMF	48	50
13	DBU (37.5)	DMF	8	47
14	DBU (50)	DMF	12	60
15	DBU (50)	PhCH ₃	15	41
16	DBU (70)	PhCH ₃	15	59
17	DBU (100)	PhCH ₃	15	33
18 ^d	DBU (100)	PhCH ₃ (0.5 M)	15	37
19 ^e	DBU (100)	PhCH ₃ (0.3 M)	72	26

^a Compounds **1a** (0.3 mmol), cyclopent-2-enone **2** (0.6 mmol), and solvent (0.3 mL) were used at room temperature.

^b Isolated yields.

^c No solvent was used.

^d Toluene (0.6 mL) was used.

^e Toluene (1.0 mL) was used.

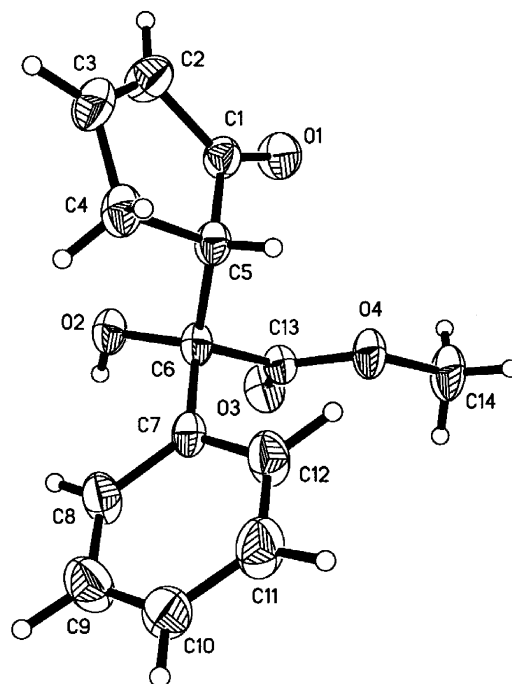
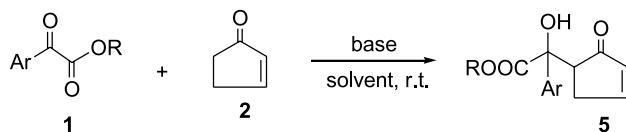

Figure 1. The ORTEP drawing of *syn*-**5a**.

reaction have been tested and the best result is using 25 mol% of DBU in this reaction. *syn*-Hydroxy-(2-oxocyclopent-3-enyl)-phenyl-acetic acid methyl ester **5a** was obtained as a sole product in up to 64% isolated yield under the optimal conditions (Table 3, entry 8). The *syn*-stereochemistry of this molecule was determined by X-ray diffraction (Fig. 1).¹³ Using cyclohexanone-2-enone or cycloheptanone-2-enone as a Michael acceptor and DBU as a catalyst in DMF, only trace of the corresponding product was formed. Moreover, in the presence of PBu₃, PPh₂Me and PPhMe₂, no reaction occurred under identical conditions. This is might be due to that in aldol reaction, the key step is the formation of the corresponding enolate and DBU is the strongest base among all of the employed catalysts in this reaction. Therefore, it is the best catalyst for the aldol reaction. The function of solvent might dilute the reactants and suppress the by-reaction pathway in aldol reaction.

Next, we extended this methodology to the reaction of a variety of α -keto esters with cyclopent-2-enone. As shown in Table 4, a variety of aryl α -keto esters such as **1b–1e** can react with cyclopent-2-enone to give the corresponding products in moderate yields either in DMF or in toluene in the presence of DBU (25–70 mol%) (Table 4, entries 1–11). Under above optimized reaction conditions, α -keto esters **1b–1e** gave the corresponding aldol reaction products in low yields with 25 mol% of DBU. Increasing the amount of DBU to 50 or 70 mol% of DBU can shorten the reaction time and give the corresponding products in higher yields (Table 4, entries 3–11). However, using alkyl α -keto esters such as **1i** and **1j** as substrates under the same conditions, no reaction occurred (Table 4, entries 12 and 13).

A plausible reaction mechanism of α -keto ester with cyclopent-2-enone has been proposed on the basis of generally accepted mechanism of aldol reaction

Table 4. Aldol reaction of α -keto esters with cyclopent-2-enone^a

Entry	Ar	R	Base (mol%)	Solvent	Time (h)	Yield (%) ^b
1	1a : C ₆ H ₅	Me	DBU (25)	DMF	12	64
2	1a		DBU (25)	PhCH ₃	48	64
3	1b : <i>p</i> -CH ₃ C ₆ H ₄	Me	DBU (50)	DMF	17	26
4	1b		DBU (50)	PhCH ₃	48	41
5	1b		DBU (70)	PhCH ₃	24	65
6	1c : C ₆ H ₅	Et	DBU (25)	DMF	24	54
7	1c		DBU (50)	DMF	6	62
8	1d : <i>p</i> -CH ₃ C ₆ H ₄	Et	DBU (50)	DMF	72	20
9 ^c	1d		DBU (70)	PhCH ₃	24	60
10	1e : <i>p</i> -ClC ₆ H ₄	Et	DBU (50)	DMF	72	55
11	1e		DBU (70)	PhCH ₃	24	20
12	1i : Ph(CH ₂) ₃	Et	DBU (50)	DMF	72	NR ^d
13	1j : Cy	Et	DBU (50)	DMF	72	NR ^d

^a α -Keto ester **1** (0.3 mmol), cyclopent-2-enone **2** (0.6 mmol), and solvent (0.3 mL) were used at room temperature.

^b Isolated yields.

^c Molecular sieves of 4 Å was used.

^d No reaction took place.

(Scheme 2).¹⁴ DBU abstracts a proton from cyclopent-2-enone to give an enolate intermediate **A**, which produces the aldol reaction intermediate **B** by the reaction with α -keto ester. For the aldol reaction intermediate **B-2** with *anti*-configuration, it suffers from more steric repulsion than intermediate **B-1** with *syn*-configuration on the basis of Cram rule. Therefore, the corresponding aldol reaction products are produced exclusively with *syn*-configuration as a sole product (Scheme 2).

3. Conclusion

In summary, we have found that the basicity and nucleophilicity of organocatalysts play important roles in the reaction of α -keto esters with cyclopent-2-enone. We have successfully demonstrated that the reaction of α -keto esters with cyclopent-2-enone in the presence of diphenylmethylphosphine, a nucleophilic organocatalyst (a Lewis base promoter), produces the corresponding Baylis–Hillman reaction products in moderate to good yields in

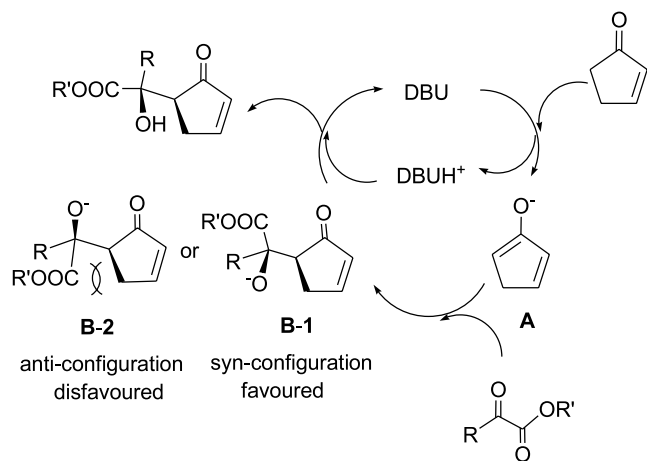
**Scheme 2.** A Plausible mechanism of aldol reaction.

neat condition. The introduction of phenol as an additive in this process can afford the product in higher yield, presumably due to a synergistic bifunctional cooperation between the Brønsted-basic diphenylmethylphosphine and Brønsted-acidic *p*-nitrophenol resulting in clean reaction and high yield. With basic amine such as DBU as an organocatalyst in this reaction, the aldol reactions take place to give the adducts exclusively as *syn*-configuration in moderate yields either in DMF or in toluene. Efforts are in progress to elucidate the mechanistic details of this reaction and to disclose its scope and limitations in further transformation.

4. Experimental

4.1. General remarks

MP was obtained with a micro melting point apparatus and is uncorrected. Infrared spectra were measured on a spectrometer. ¹H and ¹³C NMR spectra were recorded for a solution in CDCl₃ with tetramethylsilane (TMS) as internal standard. *J*-values are in Hz. Mass spectra were recorded with a HP-5989 instrument and HRMS was measured by a Finnigan MA+ mass spectrometer. Organic solvents used were dried by standard methods when necessary. All solid compounds reported in this paper gave satisfactory CHN microanalyses and HRMS values. Elemental analyses were measured at the service Italian Carlo-Erba 110. Commercially obtained reagents were used without further purification. All reactions were monitored by TLC with Huanghai GF254 silica gel coated plates. Flash column chromatography was carried out using silica gel at increased pressure. Baylis–Hillman reaction experiments were performed under argon atmosphere using standard Schlenk techniques. The starting materials **1b–1j** were synthesis according to the previous literature.¹⁵

4.2. Typical reaction procedure for the preparation of 3 and 4

To a mixture of α -keto ester compound (0.3 mmol), cyclopent-2-enone (51 μ L, 0.6 mmol) and *p*-nitrophenol (14 mg, 0.1 mmol), was added tertiary-phosphine (0.1 mmol) under argon at room temperature. The resulting mixtures were stirred under the conditions indicated in the Tables. After the reaction solution was concentrated under reduced pressure, the residue was purified by flash chromatography on silica gel (Eluent: EtOAc/petroleum = 1:4) to afford pure products 3 and 4.

4.2.1. Hydroxy-(5-oxo-cyclopent-1-enyl)-phenyl-acetic acid methyl ester (3a). A white solid: 50 mg, 68% yield. Mp: 86–87 °C; IR (CH₂Cl₂): ν 2926, 1736, 1703 cm⁻¹; ¹H NMR (CDCl₃, 300 MHz, TMS): δ 2.50–2.65 (m, 4H, CH₂), 3.81 (s, 3H, CH₃), 4.53 (s, 1H, OH), 7.22 (t, 1H, *J* = 2.7 Hz, CH), 7.34–7.42 (m, 3H, Ar), 7.58–7.61 (m, 2H, Ar); ¹³C NMR (CDCl₃, 75 MHz, TMS): δ 26.4, 34.9, 53.3, 75.2, 125.9, 128.1, 138.4, 147.1, 161.9, 173.1, 208.0; MS (EI) *m/z* 247 (M⁺ + 1, 2.08), 187 (97.90), 109 (100), 77 (27.96). Anal. Calcd for C₁₄H₁₄O₄: C, 68.28%; H, 5.73%. Found; C, 68.26%; H, 5.82%.

4.2.2. Hydroxy-[4-(hydroxy-methoxycarbonyl-phenyl-methyl)-5-oxo-cyclopent-1-enyl]-phenyl-acetic acid methyl ester (4). A white solid: 16 mg, 13% yield. Mp: 117–118 °C; IR (CH₂Cl₂): ν 2955, 1737, 1705, 1172, 1132 cm⁻¹; ¹H NMR (CDCl₃, 300 MHz, TMS): δ 2.39–2.50 (m, 2H, CH₂), 3.71 (dd, 1H, *J* = 3.0, 6.9 Hz, CH), 3.81 (s, 3H, CH₃), 3.90 (s, 3H, CH₃), 3.96 (s, 1H, OH), 4.42 (s, 1H, OH), 7.18 (t, 1H, *J* = 2.4 Hz, CH), 7.31–7.39 (m, 6H, Ar), 7.55–7.62 (m, 4H, Ar); ¹³C NMR (CDCl₃, 75 MHz, TMS): δ 22.6, 31.5, 53.4, 53.7, 75.9, 77.5, 125.7, 126.0, 128.1, 128.2, 128.4, 138.3, 139.8, 146.7, 161.7, 172.9, 174.4, 206.4; MS (EI) *m/z* 411 (M⁺ + 1, 5.53), 187 (85.74), 105 (100), 77 (30.90); HRMS (MALDI) for C₂₃H₂₂O₇Na (M + Na)⁺: 433.1263. Found; 433.1258.

4.2.3. Hydroxy-(5-oxo-cyclopent-1-enyl)-*p*-tolyl-acetic acid methyl ester (3b). A white solid: 56 mg, 72% yield. Mp: 90–91 °C; IR (CH₂Cl₂): ν 2954, 2925, 1739, 1705 cm⁻¹; ¹H NMR (CDCl₃, 300 MHz, TMS): δ 2.36 (s, 3H, CH₃), 2.49–2.64 (m, 4H, CH₂), 3.80 (s, 3H, CH₃), 4.50 (s, 1H, OH), 7.19 (d, 2H, *J* = 8.1 Hz, Ar), 7.24–7.27 (m, 1H, CH), 7.47 (d, 2H, *J* = 8.4 Hz, Ar); ¹³C NMR (CDCl₃, 75 MHz, TMS): δ 21.0, 26.5, 35.0, 53.4, 75.3, 125.9, 128.9, 135.6, 138.0, 147.3, 161.9, 173.3, 208.1; MS (EI) *m/z* 260 (M⁺, 0.18), 243 (24.60), 201 (47.58), 109 (100). Anal. Calcd for C₁₅H₁₆O₄: C, 69.22%; H, 6.20%. Found; C, 68.97%; H, 6.22%.

4.2.4. Hydroxy-(5-oxo-cyclopent-1-enyl)-phenyl-acetic acid ethyl ester (3c). A white solid: 47 mg, 60% yield. Mp: 82–83 °C; IR (CH₂Cl₂): ν 2981, 2927, 1736, 1706 cm⁻¹; ¹H NMR (CDCl₃, 300 MHz, TMS): δ 1.27 (t, 3H, *J* = 6.9 Hz, CH₃), 2.50–2.65 (m, 4H, CH₂), 4.28 (q, 2H, *J* = 7.5 Hz, CH₂), 4.49 (s, 1H, OH), 7.20 (t, 1H, *J* = 2.4 Hz, CH), 7.34–7.41 (m, 3H, Ar), 7.60–7.63 (m, 2H, Ar); ¹³C NMR (CDCl₃, 75 MHz, TMS): δ 13.9, 26.5, 35.0, 62.7, 75.2, 126.0, 128.1, 138.6, 147.4, 161.9, 172.7, 207.8; MS (EI) *m/z* 261 (M⁺ + 1, 12.12), 187 (57.17), 109 (100), 53 (26.64);

HRMS (MALDI) for C₁₅H₁₆O₄Na (M + Na)⁺: 283.0946. Found; 283.0941.

4.2.5. Hydroxy-(5-oxo-cyclopent-1-enyl)-*p*-tolyl-acetic acid ethyl ester (3d). A white solid: 58 mg, 71% yield. Mp: 111–112 °C; IR (CH₂Cl₂): ν 2980, 2925, 1735, 1707, 1095 cm⁻¹; ¹H NMR (CDCl₃, 300 MHz, TMS): δ 1.26 (t, 3H, *J* = 6.9 Hz, CH₃), 2.36 (s, 3H, CH₃), 2.49–2.65 (m, 4H, CH₂), 4.26 (q, 2H, *J* = 7.5 Hz, CH₂), 4.45 (s, 1H, OH), 7.17–7.27 (m, 3H, Ar and CH), 7.48 (d, 2H, *J* = 8.1 Hz, Ar); ¹³C NMR (CDCl₃, 75 MHz, TMS): δ 13.9, 21.0, 26.4, 35.0, 62.5, 75.0, 125.9, 128.8, 135.7, 137.8, 147.5, 161.8, 172.8, 207.8; MS (EI) *m/z* 274 (M⁺, 0.20), 201 (36.42), 109 (100). Anal. Calcd for C₁₆H₁₈O₄: C, 70.06%; H, 6.61%. Found; C, 70.04%; H, 6.68%.

4.2.6. (4-Chlorophenyl)-hydroxy-(5-oxo-cyclopent-1-enyl)-acetic acid ethyl ester (3e). A white solid: 55 mg, 63% yield. Mp: 92–94 °C; IR (CH₂Cl₂): ν 3432, 1744, 1697, 1489, 1129, 1095 cm⁻¹; ¹H NMR (CDCl₃, 300 MHz, TMS): δ 1.27 (t, 3H, *J* = 7.2 Hz, CH₃), 2.50–2.73 (m, 4H, CH₂), 4.28 (q, 2H, *J* = 7.2 Hz, CH₂), 4.49 (s, 1H, OH), 7.20 (t, 1H, *J* = 2.7 Hz, CH), 7.37 (d, 2H, *J* = 9.0 Hz, Ar), 7.57 (d, 2H, *J* = 9.0 Hz, Ar); ¹³C NMR (CDCl₃, 75 MHz, TMS): δ 13.9, 26.5, 34.9, 62.8, 74.8, 127.6, 128.3, 134.1, 137.2, 147.1, 161.7, 172.3, 207.6; MS (EI) *m/z* 294 (M⁺, 0.42), 221 (48.49), 109 (100), 53 (21.26). Anal. Calcd for C₁₅H₁₅ClO₄: C, 61.13%; H, 5.13%. Found; C, 60.84% H, 5.16%.

4.2.7. Hydroxy-(5-oxo-cyclopent-1-enyl)-pyridin-3-yl-acetic acid ethyl ester (3f). A yellow oil: 49 mg, 63% yield; IR (CH₂Cl₂): ν 2985, 1741, 1705, 1436 cm⁻¹; ¹H NMR (CDCl₃, 300 MHz, TMS): δ 1.25 (t, 3H, *J* = 7.2 Hz, CH₃), 2.49–2.52 (m, 2H, CH₂), 2.63–2.66 (m, 2H, CH₂), 4.27 (q, 2H, *J* = 6.9 Hz, CH₂), 5.90 (s, 1H, OH), 7.27–7.32 (m, 1H, Ar), 7.47 (t, 1H, *J* = 2.7 Hz, CH), 7.75–7.77 (m, 2H, Ar), 8.57 (d, 2H, *J* = 4.8 Hz, Ar); ¹³C NMR (CDCl₃, 75 MHz, TMS): δ 13.9, 26.6, 35.0, 62.4, 76.2, 121.7, 123.3, 137.1, 146.3, 147.6, 157.0, 161.6, 171.3, 207.6; MS (EI) *m/z* 261 (M⁺, 0.35), 188 (100), 106 (37.50), 78 (70.79); HRMS (MALDI) for C₁₄H₁₆NO₄⁺: 262.1079. Found; 262.1074.

4.2.8. Hydroxy-(4-methoxyphenyl)-(5-oxo-cyclopent-1-enyl)-acetic acid methyl ester (3g). A white solid: 31 mg, 37% yield. Mp: 108–109 °C; IR (CH₂Cl₂): ν 2953, 1743, 1704, 1511, 1181 cm⁻¹; ¹H NMR (CDCl₃, 300 MHz, TMS): δ 2.50–2.65 (m, 4H, CH₂), 3.80 (s, 3H, CH₃), 3.82 (s, 3H, CH₃), 4.48 (s, 1H, OH), 6.91 (d, 2H, *J* = 9.0 Hz, Ar), 7.26 (t, 1H, *J* = 2.7 Hz, CH), 7.50 (d, 2H, *J* = 8.7 Hz, Ar); ¹³C NMR (CDCl₃, 75 MHz, TMS): δ 26.5, 35.1, 53.4, 55.3, 75.1, 113.6, 127.3, 130.5, 147.5, 159.5, 162.0, 172.4, 208.2; MS (EI) *m/z* 276 (M⁺, 0.15), 217 (38.84), 109 (100), 53 (15.75); HRMS (MALDI) for C₁₅H₁₆O₅Na (M + Na)⁺: 299.0895. Found; 299.0890.

4.2.9. Hydroxy-(4-methoxyphenyl)-(5-oxo-cyclopent-1-enyl)-acetic acid ethyl ester (3h). A white solid: 40 mg, 46% yield. Mp: 112–113 °C; IR (CH₂Cl₂): ν 2930, 1736, 1706, 1510, 1176 cm⁻¹; ¹H NMR (CDCl₃, 300 MHz, TMS): δ 1.27 (t, 3H, *J* = 7.2 Hz, CH₃), 2.49–2.64 (m, 4H, CH₂), 3.82 (s, 3H, CH₃), 4.27 (q, 2H, *J* = 6.6 Hz, CH₂), 4.45 (s, 1H, OH), 6.90 (d, 2H, *J* = 8.7 Hz, Ar), 7.22–7.27 (m, 1H,

CH), 7.52 (d, 2H, $J=8.7$ Hz, Ar); ^{13}C NMR (CDCl_3 , 75 MHz, TMS): δ 14.0, 26.5, 35.1, 55.2, 62.6, 74.9, 113.5, 127.3, 130.7, 147.7, 159.4, 161.9, 172.9, 208.0; MS (EI) m/z 290 (M^+ , 0.29), 217 (56.32), 109 (100), 53 (22.32); HRMS (MALDI) for $\text{C}_{16}\text{H}_{18}\text{O}_5\text{Na}$ ($\text{M}+\text{Na}$) $^+$: 313.1052. Found; 313.1047.

4.2.10. 2-Hydroxy-2-(5-oxo-cyclopent-1-enyl)-5-phenyl-pentanoic acid ethyl ester (3i). A yellow oil: 66 mg, 73% yield; IR (CH_2Cl_2): ν 2926, 1739, 1703, 1174, 1101 cm^{-1} ; ^1H NMR (CDCl_3 , 300 MHz, TMS): δ 1.24 (t, 3H, $J=7.5$ Hz, CH_3), 1.50–1.55 (m, 1H, CH_2), 1.80–1.90 (m, 1H, CH_2), 2.00–2.06 (m, 2H, CH_2), 2.43–2.45 (m, 2H, CH_2), 2.61–2.67 (m, 4H, CH_2), 4.20 (q, 2H, $J=5.4$ Hz, CH_2), 4.31 (s, 1H, OH), 7.15–7.20 (m, 3H, Ar), 7.25–7.30 (m, 2H, Ar), 7.57 (t, 1H, $J=2.7$ Hz, CH); ^{13}C NMR (CDCl_3 , 75 MHz, TMS): δ 14.0, 24.7, 26.3, 35.0, 35.5, 36.1, 62.0, 74.5, 125.7, 128.2, 128.3, 141.7, 145.6, 159.9, 173.5, 208.3; MS (EI) m/z 303 ($\text{M}^+ + 1$, 21.77), 229 (100), 211 (74.46), 91 (65.86); HRMS (MALDI) for $\text{C}_{18}\text{H}_{22}\text{O}_4\text{Na}$ ($\text{M}+\text{Na}$) $^+$: 325.1416. Found; 325.1410.

4.2.11. Cyclohexyl-hydroxy-(5-oxo-cyclopent-1-enyl)-acetic acid ethyl ester (3j). A yellow oil: 69 mg, 86% yield; IR (CH_2Cl_2): ν 2927, 2854, 1707, 1152, 1121 cm^{-1} ; ^1H NMR (CDCl_3 , 300 MHz, TMS): δ 1.18–1.35 (m, 6H, CH_2), 1.27 (t, 3H, $J=7.2$ Hz, CH_3), 1.52–1.78 (m, 4H, CH_2), 2.27–2.32 (m, 1H, CH), 2.47–2.50 (m, 2H, CH_2), 2.61–2.64 (m, 2H, CH_2), 4.22 (q, 2H, $J=6.9$ Hz, CH_2), 4.66 (s, 1H, OH), 7.45 (t, 1H, $J=2.7$ Hz, CH); ^{13}C NMR (CDCl_3 , 75 MHz, TMS): δ 14.0, 26.0, 26.1, 26.1, 26.1, 35.5, 43.2, 61.9, 79.0, 143.9, 161.7, 173.8, 208.4; MS (EI) m/z 267 ($\text{M}^+ + 1$, 21.31), 193 (100), 175 (81.58), 109 (76.74), 84 (85.99), 55 (79.74); HRMS (EI) for $\text{C}_{15}\text{H}_{22}\text{O}_4$: 266.1518. Found; 266.1536.

4.3. Typical procedure for the preparation of 5

To a mixture of α -keto ester compound (0.3 mmol) and cyclopent-2-enone (51 μL , 0.6 mmol) in the appropriate solvent (0.3 mL), was added dropwise DBU at room temperature. After stirring at room temperature under the conditions indicated in the Tables, the reaction mixtures were washed with water (5 mL) and extracted with dichloromethane (3×5 mL). The combined organic layers were dried over anhydrous sodium sulfate. Solvent was evaporated under reduced pressure and the residue was purified by flash chromatography on silica gel (Eluent: EtOAc/petroleum ether = 1:10) to afford pure product **5**.

4.3.1. Hydroxy-(2-oxo-cyclopent-3-enyl)-phenyl-acetic acid methyl ester (5a). A white solid: 47 mg, 64% yield. Mp: 102–103 $^\circ\text{C}$; IR (CH_2Cl_2): ν 3497, 3058, 2954, 1732, 1701, 1170, 1129 cm^{-1} ; ^1H NMR (CDCl_3 , 300 MHz, TMS): δ 2.42–2.63 (m, 2H, CH_2), 3.55 (dd, 1H, $J=3.3$, 6.6 Hz, CH), 3.88 (s, 3H, CH_3), 3.98 (s, 1H, OH), 6.21 (dt, 1H, $J=2.1$, 5.7 Hz, CH), 7.31–7.41 (m, 3H, Ar), 7.61–7.64 (m, 2H, Ar), 7.69 (dt, 1H, $J=2.7$, 5.7 Hz, CH); ^{13}C NMR (CDCl_3 , 75 MHz, TMS): δ 31.6, 51.9, 53.2, 77.1, 125.6, 127.7, 128.1, 133.7, 140.0, 164.5, 174.5, 207.8; MS (EI) m/z 246 (M^+ , 0.30), 187 (27.69), 105 (100), 77 (26.49). Anal. Calcd for $\text{C}_{14}\text{H}_{14}\text{O}_4$: C, 68.28%; H, 5.73%. Found; C, 68.47%; H, 5.75%.

4.3.2. Hydroxy-(2-oxo-cyclopent-3-enyl)-*p*-tolyl-acetic acid methyl ester (5b). A white solid: 51 mg, 65% yield. Mp: 96–98 $^\circ\text{C}$; IR (CH_2Cl_2): ν 3506, 2955, 2925, 1735, 1704, 1170, 1132 cm^{-1} ; ^1H NMR (CDCl_3 , 300 MHz, TMS): δ 2.35 (s, 3H, CH_3), 2.48–2.57 (m, 2H, CH_2), 3.53 (dd, 1H, $J=3.3$, 6.6 Hz, CH), 3.87 (s, 3H, CH_3), 3.95 (s, 1H, OH), 6.19 (dt, 1H, $J=1.8$, 6.0 Hz, CH), 7.17 (d, 2H, $J=8.1$ Hz, Ar), 7.49 (d, 2H, $J=8.1$ Hz, Ar), 7.68 (dt, 1H, $J=2.4$, 6.0 Hz, CH); ^{13}C NMR (CDCl_3 , 75 MHz, TMS): δ 20.9, 31.8, 52.1, 53.5, 77.2, 125.7, 129.0, 134.0, 137.1, 137.7, 164.6, 174.9, 208.1; MS (EI) m/z 260 (M^+ , 0.15), 201 (28.63), 119 (100), 91 (23.81). Anal. Calcd for $\text{C}_{15}\text{H}_{16}\text{O}_4$: C, 69.22%; H, 6.20%. Found; C, 69.30%; H, 6.21%.

4.3.3. Hydroxy-(2-oxo-cyclopent-3-enyl)-phenyl-acetic acid ethyl ester (5c). This is a known compound.^{5f} A white solid: 48 mg, 62% yield. ^1H NMR (CDCl_3 , 300 MHz, TMS): δ 1.32 (t, 3H, $J=7.2$ Hz, CH_3), 2.34–2.72 (m, 2H, CH_2), 3.55 (dd, 1H, $J=3.6$, 6.9 Hz, CH), 4.01 (s, 1H, OH), 4.28–4.43 (m, 2H, CH_2), 6.19 (dt, 1H, $J=2.4$, 5.7 Hz, CH), 7.30–7.39 (m, 3H), 7.62–7.68 (m, 2H).

4.3.4. Hydroxy-(2-oxo-cyclopent-3-enyl)-*p*-tolyl-acetic acid ethyl ester (5d). A white solid: 50 mg, 60% yield. Mp: 86–87 $^\circ\text{C}$; IR (CH_2Cl_2): ν 3436, 2988, 2926, 1741, 1691, 1165 cm^{-1} ; ^1H NMR (CDCl_3 , 300 MHz, TMS): δ 1.32 (t, 3H, $J=7.2$ Hz, CH_3), 2.35 (s, 3H, CH_3), 2.47–2.55 (m, 2H, CH_2), 3.54 (dd, 1H, $J=3.3$, 6.9 Hz, CH), 3.97 (s, 1H, OH), 4.24–4.43 (m, 2H, CH_2), 6.19 (dt, 1H, $J=2.1$, 5.7 Hz, CH), 7.17 (d, 2H, $J=8.4$ Hz, Ar), 7.51 (d, 2H, $J=8.4$ Hz, Ar), 7.67 (dt, 1H, $J=2.4$, 6.0 Hz, CH); ^{13}C NMR (CDCl_3 , 75 MHz, TMS): δ 13.9, 21.0, 31.9, 52.2, 62.8, 77.2, 125.7, 129.0, 134.1, 137.4, 137.6, 164.5, 174.4, 208.1; MS (EI) m/z 274 (M^+ , 0.54), 201 (30.97), 119 (100), 91 (23.96). Anal. Calcd for $\text{C}_{16}\text{H}_{18}\text{O}_4$: C, 70.06%; H, 6.61%. Found; C, 70.00%; H, 6.64%.

4.3.5. (4-Chlorophenyl)-hydroxy-(2-oxo-cyclopent-3-enyl)-acetic acid ethyl ester (5e). A white solid: 46 mg, 55% yield. Mp: 134–135 $^\circ\text{C}$; IR (CH_2Cl_2): ν 3436, 2986, 2928, 1743, 1695, 1165 cm^{-1} ; ^1H NMR (CDCl_3 , 300 MHz, TMS): δ 1.32 (t, 3H, $J=6.9$ Hz, CH_3), 2.47–2.56 (m, 2H, CH_2), 3.54 (dd, 1H, $J=3.6$, 6.9 Hz, CH), 3.98 (s, 1H, OH), 4.24–4.43 (m, 2H, CH_2), 6.19 (dt, 1H, $J=2.1$, 5.7 Hz, CH), 7.17 (d, 2H, $J=7.8$ Hz, Ar), 7.51 (d, 2H, $J=8.4$ Hz, Ar), 7.67 (dt, 1H, $J=2.7$, 5.7 Hz, CH); ^{13}C NMR (CDCl_3 , 75 MHz, TMS): δ 14.0, 31.7, 52.2, 63.1, 77.0, 127.3, 128.5, 134.1, 138.9, 142.3, 164.4, 173.9, 207.6; MS (EI) m/z 294 (M^+ , 0.56), 221 (39.35), 139 (100), 111 (18.52). Anal. Calcd for $\text{C}_{15}\text{H}_{15}\text{ClO}_4$: C, 61.13%; H, 5.13%. Found; C, 60.95%; H, 5.06%.

Acknowledgements

We thank the State Key Project of Basic Research (Project 973) (No. G2000048007), Shanghai Municipal Committee of Science and Technology, Chinese Academy of Sciences (KGCX2-210-01), and the National Natural Science Foundation of China (20472096, 20390050, and 20272069) for financial support.

References and notes

- (a) Morita, K.; Suzuki, Z.; Hirose, H. *Bull. Chem. Soc. Jpn.* **1968**, *41*, 2815. (b) Baylis, A. S.; Hillman, M. E. D. German Patent 2,155,113, 1972; *Chem Abstr.* **1972**, *77*, 34174q.
- For recent reviews, see: (a) Ciganek, E. In Paquette, L. A., Ed.; Organic reactions; Wiley: New York, 1977; Vol. 51. (b) Basavaiah, D.; Rao, A.; Satyanaryana, T. *Chem. Rev.* **2003**, *103*, 811–891. (c) Langer, P. *Angew. Chem., Int. Ed.* **2000**, *9*, 3049–3052. (d) Basavaiah, D.; Dharma Rao, P.; Suguna Hyma, R. *Tetrahedron* **1996**, *52*, 8001–8062. (e) Drewes, S. E.; Roos, G. H. P. *Tetrahedron* **1988**, *44*, 4653–4670.
- (a) Ameer, F.; Drewes, S. E.; Freese, S. D.; Kaye, P. T. *Synth. Commun.* **1988**, *18*, 495–500. (b) Drewes, S. E.; Freese, S. D.; Emslie, N. D.; Roos, G. H. P. *Synth. Commun.* **1988**, *18*, 1565–1572. (c) Marko, I. E.; Ollis, W. D.; Rasmussen, P. R. *Tetrahedron Lett.* **1990**, *31*, 4509–4512. (d) Marko, I. E.; Giles, P. R.; Hindley, N. J. *Tetrahedron* **1997**, *53*, 1015–1024. (e) Rezgui, F.; El Gaied, M. M. *Tetrahedron Lett.* **1998**, *39*, 5965–5966. (f) Aggarwal, V. K.; Mereu, A. *Chem. Commun.* **1999**, 2311–2312. (g) Leadbeater, N. E.; van der Pol, C. *J. Chem. Soc., Perkin Trans. 1* **2001**, 2831–2835. (h) Octavio, R.; de Souza, M. A.; Vasconcellos, M. L. A. A. *Synth. Commun.* **2003**, *33*, 1383–1389. (i) Aggarwal, V. K.; Emme, I.; Fulford, S. Y. *J. Org. Chem.* **2003**, *68*, 692–700. (j) Luo, S.; Wang, P. G.; Cheng, J.-P. *J. Org. Chem.* **2004**, *69*, 555–558. (k) Luo, S.; Mi, X.; Xu, H.; Wang, P. G.; Cheng, J.-P. *J. Org. Chem.* **2004**, *69*, 8413–8422. (l) Mi, X.; Luo, S.; Cheng, J.-P. *J. Org. Chem.* **2005**, *70*, 2338–2341.
- (a) Roth, F.; Gygax, P.; Frater, G. *Tetrahedron Lett.* **1992**, *33*, 1045–1048. (b) Li, W.; Zhang, Z.; Xiao, D.; Zhang, X. *J. Org. Chem.* **2000**, *65*, 3489–3496. (c) Wang, L.; Luis, A. L.; Agapiou, K.; Jang, H.; krische, M. J. *J. Am. Chem. Soc.* **2002**, *124*, 2402–2403. (d) Frank, S. A.; Mergott, D. J.; Roush, W. R. *J. Am. Chem. Soc.* **2002**, *124*, 2404–2405.
- (a) Aggarwal, V. K.; Tarver, G. J.; McCague, R. *Chem. Commun.* **1996**, 2713–2714. (b) Aggarwal, V. K.; Mereu, A.; Tarver, G. J.; McCague, R. *J. Org. Chem.* **1998**, *63*, 7183–7189. (c) Li, G.; Wei, H.; Gao, J. J.; Caputo, T. D. *Tetrahedron Lett.* **2000**, *41*, 1–5. (d) Shi, M.; Jiang, J.; Cui, S. *Molecules* **2001**, *6*, 852–868. (e) Basavaiah, D.; Sreenivasulu, B.; Reddy, R. M.; Muthukumar, K. *Synth. Commun.* **2001**, *31*, 2987–2995. (f) Basavaiah, D.; Sreenivasulu, B.; Rao, A. J. *J. Org. Chem.* **2003**, *68*, 5983–5991.
- Basavaiah, D.; Bharathi, T. K.; Gowriswari, V. V. L. *Tetrahedron Lett.* **1987**, *28*, 4351–4352.
- (a) Dalko, P. I.; Moisan, L. *Angew. Chem., Int. Ed.* **2001**, *40*, 3726–3748. (b) Jarvo, E. R.; Miller, S. J. *Tetrahedron* **2002**, *58*, 2481–2495.
- (a) Shi, M.; Xu, Y. *Chem. Commun.* **2001**, 1876–1877. (b) Shi, M.; Xu, Y. *Eur. J. Org. Chem.* **2002**, 696–701. (c) Shi, M.; Xu, Y.; Zhao, G.; Wu, X. *Eur. J. Org. Chem.* **2002**, 3666–3679. (d) Shi, M.; Xu, Y. *J. Org. Chem.* **2003**, *68*, 4784–4790.
- (a) Yamada, A.; Ikegami, S. *Tetrahedron Lett.* **2000**, *41*, 2165–2169. (b) McDougal, N. T.; Schaus, S. E. *J. Am. Chem. Soc.* **2003**, *125*, 12094–12095. (c) Price, K. E.; Broadwater, S. J.; Jung, H. M.; McQuade, D. T. *Org. Lett.* **2005**, *7*, 147–150. (d) Aggarwal, V. K.; Fulford, S. Y.; Lloyd-Jones, G. C. *Angew. Chem., Int. Ed.* **2005**, *44*, 1706–1708. (e) Price, K. E.; Broadwater, S. J.; Walker, B. J.; McQuade, D. T. *J. Org. Chem.* **2005**, *70*, 3980–3987. (f) Shi, M.; Chen, L. *Chem. Commun.* **2003**, 1310–1311. (g) Shi, M.; Chen, L. *J. Am. Chem. Soc.* **2005**, *127*, 3790–3800.
- Dean, J. A. *Lange's handbook of chemistry* **1973**, 513–519. Version 11.
- (a) Mahrwald, R. *Chem. Rev.* **1999**, *99*, 1095–1120. (b) List, B.; Lerner, R. A.; Barbas, C. F., III *J. Am. Chem. Soc.* **2000**, *122*, 2395–2396. (c) Denmark, S. E.; Stavenger, R. A. *Acc. Chem. Res.* **2000**, *33*, 432–440. (d) Yoshikawa, N.; Kumagai, N.; Matsunaga, S.; Moll, G.; Ohshima, T.; Suzuki, T.; Shibasaki, M. *J. Am. Chem. Soc.* **2001**, *123*, 2466–2467. (e) Trost, B. M.; Ito, H.; Silcoff, E. R. *J. Am. Chem. Soc.* **2001**, *123*, 3367–3368.
- (a) Ito, Y.; Sawamura, M.; Hamashima, H.; Emura, T.; Hayashi, T. *Tetrahedron Lett.* **1989**, *30*, 4681–4684. (b) Evans, D. A.; Kozlowski, M. C.; Burgey, C. S.; MacMillan, D. W. C. *J. Am. Chem. Soc.* **1997**, *119*, 7893–7894. (c) Jorgensen, K. A.; Johannsen, M.; Yao, S.; Audrain, H.; Thorhauge, J. *Acc. Chem. Res.* **1999**, *32*, 605–613.
- The crystal data of **5a** have been deposited in CCDC with number 277305. Empirical formula: C₁₄H₁₄O₄, Formula weight: 246.25; Crystal color; Habit: colorless, prismatic; Crystal dimensions: 0.516×0.425×0.085 mm; Crystal system: monoclinic; Lattice type: primitive; Lattice parameters: $a=11.754(2)$ Å, $b=13.036(3)$ Å, $c=8.5406(18)$ Å, $\alpha=90^\circ$, $\beta=109.143(5)^\circ$, $\gamma=90^\circ$, $V=1236.3(4)$ Å³; Space group: $P2(1)/c$; $Z=4$; $D_{\text{calcd}}=1.323$ g/cm³; $F_{000}=520$; Diffractometer: Rigaku AFC7R; Residuals: R; $R_w=0.0706$, 0.1414.
- (a) Nielsen, A. T.; Houlihan, W. J. *Org. React.* **1968**, *16*, 1–438. (b) Reeves, R. L. *Chemistry of the carbonyl group*; Wiley-Interscience: New York, 1966; pp 580–593. (c) House, H. O. *Modern synthetic reactions*, 2nd ed.; Benjamin: California, **1972**; pp 629–682.
- (a) Itoh, O.; Nagata, T.; Nomura, I.; Takanaga, T.; Sugita, T.; Ichikawa, K. *Bull. Chem. Soc. Jpn.* **1984**, *57*, 810–814. (b) Levy, A.; Rukowitz, A.; Mills, N. S. *J. Org. Chem.* **2003**, *68*, 3990–3998. (c) Boivin, S.; Outurquin, F.; Paulmier, C. *Tetrahedron* **1997**, *53*, 16767–16782. (d) Weinstock, L. M.; Currie, R. B.; Lavell, A. V. *Synth. Commun.* **1981**, *11*, 943–946.

Novel DNA bis-intercalators of isoquinolino[4,5-*bc*]acridines: design, synthesis and evaluation of cytotoxic activity

Peng Yang,^a Qing Yang^b and Xuhong Qian^{a,c,*}

^aState Key Laboratory of Fine Chemicals, Dalian University of Technology, PO Box 158, Dalian 116012, China

^bDepartment of Bioscience and Biotechnology, Dalian University of Technology, Dalian 116012, China

^cShanghai Key Laboratory of Chemical Biology, East China University of Science and Technology, Shanghai 200237, China

Received 27 June 2005; revised 12 September 2005; accepted 16 September 2005

Available online 19 October 2005

Abstract—Mono- and dinuclear isoquinolino[4,5-*bc*]acridine derivatives were designed and facilely synthesized, their DNA-binding affinities and cytotoxic activities were evaluated. **A4** induced unwinding of supercoiled plasmid pBR 322 DNA by $(36 \pm 2)^\circ$ while **A6** induced that by $(41 \pm 1)^\circ$, both of which were higher than the mono-analogue **A1** $((19 \pm 2)^\circ)$. **A6** exhibited the highest in vitro antitumor activity against human lung cancer cell (A549) and **A4** was the most active one against murine leukemia cell (P388). DNA binding constant and molecular model indicated that both the length of linker chain and the distance of interchromophore were key impact factors for DNA binding affinity and biological activity.

© 2005 Elsevier Ltd. All rights reserved.

1. Introduction

DNA intercalators have received much attention due to their therapeutic potential in anticancer treatment.¹ The recent molecular design of novel antitumor agents is focused on bisintercalating compounds, which present higher DNA binding affinities and slower dissociation rates than the corresponding monomers.² Over the past two decades, a great number of dimeric forms of DNA intercalators, such as bis-acridinecarboxamides, bis-naphthalimides, and bis-imidazoacridones (see Fig. 1), have been developed as potential anticancer drugs.³

DNA intercalators usually exhibit a planar structure with at least two annelated aromatic rings, also termed as chromophores, and have one or two flexible basic side chains such as polyamides. Many of these compounds were reported to function as DNA-targeted topoisomerase I and/or II inhibitors.⁴ Both naphthalimide and acridine derivatives have proved valuable chromophores in antitumor activity and various modifications have been attempted to promote their bioactivities.⁴

The heterocyclic-fused larger ring system, in particular in dimeric forms, was found to account for the high DNA affinity and antitumor activity. As we know well, bis-

heterocycle modified bis-naphthalimide and bis-acridine derivatives have been extensively studied for their cytotoxicity, antitumor, and antiparasitic activities.^{5,6} However, the reports that could take full advantage of the structural characteristics of both naphthalimide and acridine chromophores seldom appeared. In our continuous attempt⁷ to develop high DNA binding affinity and highly active antitumor agents, we designed and synthesized novel mono- and bis-isoquinolino[4,5-*bc*]acridine derivatives **A1–A6** (Figure 2). In this study, naphthalimide active group was

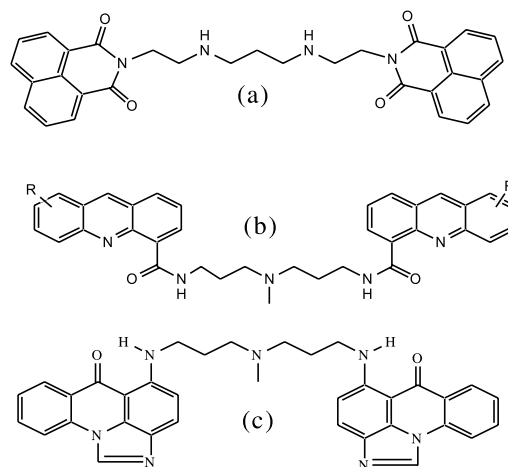

Figure 1. Structure of bis-naphthalimides (a), bis-acridinecarboxamides (b), and bis-imidazoacridones (c).

Keywords: Acridine; DNA-intercalation; Cytotoxicity.

* Corresponding author. Tel.: +86 411 83673466; fax: +86 411 83673488; e-mail addresses: xhqian@dlut.edu.cn; xhqian@ecust.edu.cn

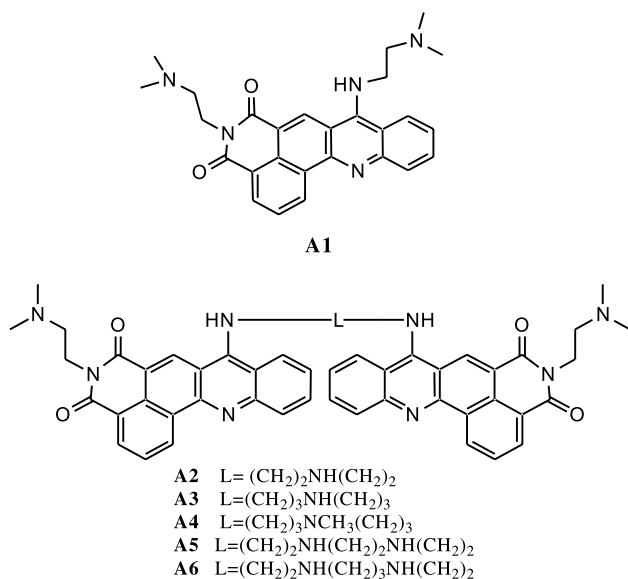

Figure 2. The structures of mono- and dinuclear isoquinolino[4,5-*bc*]acridine derivatives **A1**–**A6**.

remained and the acridine unit was effectively fused with electron-deficiency group. Also, several polyamine chains ranging from 7.3–12.3 Å were used as linkers to bridge two heterocyclic-fused acridine chromophores at the 8-site of these compounds.⁸ This resulted structure therefore distinguished our work from the common bisintercalating mode of naphthalimide derivatives and was expected to show higher DNA intercalative property and better antitumor activity due to the presence of two intercalator groups, naphthalimide and acridine.

2. Results and discussion

2.1. Synthesis and spectra

The facile syntheses of these compounds were outlined in **Scheme 1**. To avoid the imidation of naphthalic anhydride by 2-aminobenzoic acid, 4-bromo-1, 8-naphthalic anhydride, the starting material, was reacted with *N,N*-dimethylethylenediamine in ethanol for 2 h as the initial reaction step. Then, the naphthalimide derivative **1** was coupled with 2-aminobenzoic acid in DMF, catalyzed by CuI and Cu.⁹ The obtained intermediate **2** was not purified

and directly carried out the ring closure reaction in phosphorus oxychloride.¹⁰ The ring closure was proceeded through the formation of a mixed anhydride followed by intramolecular acylation and elimination of hydrochloric acid.¹⁰ And then, it was poured into the ice-cold aqueous solution of NH₄OH, filtered, dried, and separated on silica gel chromatography (CHCl₃/MeOH=9:1, v/v), to give yellow product **3**. Mention should be made here that this ring closure reaction could reach satisfactory yields (88%) of the desired product. Since the compound **3** was of the characteristics of the strong electron-deficiency, the substituent chloride would be a good leaving group, which made the compounds **A2**–**A6** easily obtained by the reaction with different polyamines and the yields were acceptable (from 90 to 33%). However, polyamines were highly hygroscopic and could adopt a different salt, which made elementary analysis an inadequate method of measuring the purity of these compounds.¹¹ Thus, structures of the obtained novel mono- and bisintercalators were confirmed by IR, ¹H NMR and H RMS after purification by silica gel chromatography (CHCl₃, MeOH, and NH₄OH). And the UV–vis and fluorescent spectra for these compounds were measured and the data were shown in **Table 1**.

The linkers of **A2**–**A6** were designed to enable the bis-acridine chromophores to extend over a distance of 7.3–12.3 Å and thus could form the bisintercalated DNA complex.⁸

2.2. DNA unwinding property

To illustrate the intercalating mode by the bis-acridine derivatives, we investigated their unwinding ability of supercoiled closed circular DNA pBR322 by electrophoretic mobility measurements on 2% agarose gels. **Figure 3** showed the difference of electrophoretic mobility between the intact supercoiling pBR322 and the treated pBR322 DNA by **A1**, **A4**, and **A6** in the range of 0.005–0.090 molar ratios of intercalator per nucleotide (*r*). The DNA unwinding angle was calculated from the Eq. (1):¹²

$$\phi = 18 \sigma / r(c) \quad (1)$$

where σ is the superhelical density, $r(c)$ is the molar ratio of intercalator per nucleotide at the coalescence point.

In **Figure 3**, the DNA unwinding angles for compounds **A1**, **A4**, and **A6** were (19 ± 2)°, (36 ± 2)°, (41 ± 1)°, respectively.

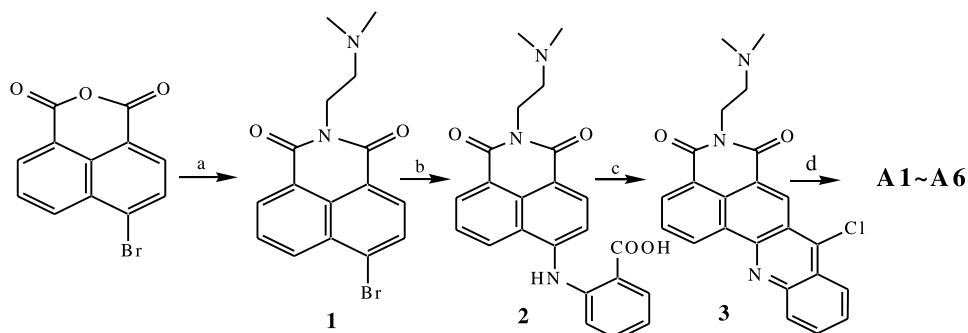

Scheme 1. Synthesis of mono- and bis-isoquinolino[4,5-*bc*]acridines derivatives (a) *N,N*-dimethylethylenediamine, ethanol, reflux, 2 h, 85% yield; (b) 2-aminobenzoic acid, Cu/CuI, DMF, 100 °C, 24 h, 86% yield; (c) phosphorus oxychloride, 110 °C, 12 h, 88% yield; (d) corresponding polyamine, acetonitrile, reflux, 10 h, 90–33% yield.

Table 1. Spectra data^{a,b}, properties of the linkers and cytotoxicity (A-549,^c P388^d) of compounds

Compounds	UV λ_{\max} (nm) (log ϵ)	FL λ_{\max} (nm) (Φ)	Interchromophore		Cytotoxicity [IC ₅₀ (μ M)]	
			Linker	Distance (\AA)	A549	P388
A1	462(4.04)	544(0.056)	NA ^c	NA	3.71	0.275
A2	472(3.94)	558(0.024)	(CH ₂) ₂ NH(CH ₂) ₂	7.3	56.2	122
A3	473(4.19)	550(0.015)	(CH ₂) ₃ NH(CH ₂) ₃	9.8	0.150	0.472
A4	473(4.20)	567(0.010)	(CH ₂) ₃ NCH ₃ (CH ₂) ₃	9.8	0.333	0.246
A5	474(4.27)	557(0.024)	(CH ₂) ₂ NH(CH ₂) ₂ NH(CH ₂) ₂	11.0	0.547	1.03
A6	470(3.88)	562(0.012)	(CH ₂) ₂ NH(CH ₂) ₃ NH(CH ₂) ₂	12.3	0.025	0.281

^a In absolute ethanol.

^b With rhodamine B in ethanol as quantum yield standard ($\phi=0.97$).

^c Cytotoxicity (CTX) against human lung cancer cell (A549) was measured by sulforhodamine B dye-staining method.

^d CTX against murine leukemia cells (P388) was measured by microculture tetrazolium–formazan method.

^e NA, not applicable.

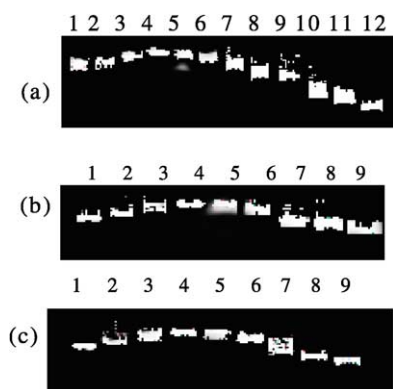

Figure 3. Effects of **A1**, **A4**, and **A6** on the supercoiled pBR 322 DNA. Panel (a) Drug to DNA ratios (r) in lanes 1–12 for **A1** are 0.090, 0.085, 0.079, 0.075, 0.072, 0.065, 0.055, 0.04, 0.025, 0.01, 0.005, 0; Panel (b) Drug to DNA ratios (r) in lanes 1–9 for **A4**; 0.060, 0.050, 0.043, 0.040, 0.037, 0.03, 0.02, 0.01, 0; Panel (c) Drug to DNA ratios (r) in lanes 1–9 for **A6**: 0.050, 0.045, 0.039, 0.035, 0.033, 0.025, 0.02, 0.01, 0.

For **A4** and **A6**, the unwinding angles were 1.9–2.2-fold greater than that of the monomer, 8-(dimethylamino)ethyl-amino-5-(2-(dimethylamino)ethyl)-5*H*-isoquinolino[4,5-*bc*]acridine-4,6-dione, indicating that **A4** and **A6** may have bis-intercalated with pBR 322 DNA. In addition, the calculated helix-unwinding angles also revealed that linkers played a key role on unwinding supercoiling of DNA.

2.3. Structure–activity relationships for cellular growth inhibition

SRB (Sulforhodamine B) assay against A549 (human lung cancer cell) and MTT (3-(4,5-dimethylthiazol-2-yl)-2,5-diphenyltetrazolium bromide) assay against P388 (murine leukemia cell) were used to evaluate the antitumor activities of these compounds. IC₅₀ represents the drug concentration

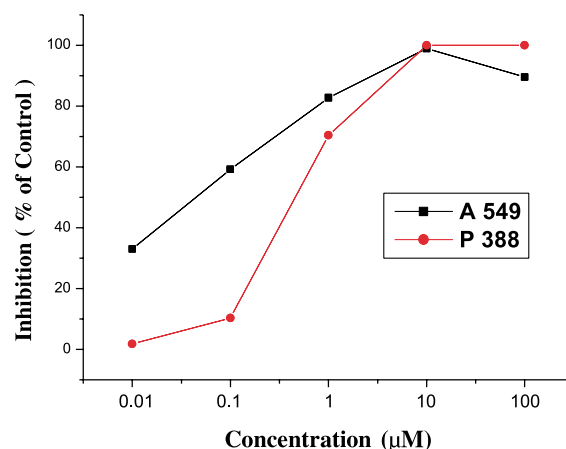

Figure 4. The dose–response curve of the compound **A6** for both A549 and P388.

(micromolar) required to inhibit cell growth by 50%. The IC₅₀ values were calculated based on the parameters in Table 2. Figure 4 presented the dose–response curve of the representative compound **A6** for both A549 and P388. The structure parameters of these compounds and their cytotoxicities (as IC₅₀ values) were listed in Table 1. It was showed that these polyamine systems except **A2** were active in the described panels, although their activities were in every case different. The dinuclear NH substituted compound **A6** was found to be the most effective antitumor agent against A549 (IC₅₀, 0.025 μ M) and **A4** was more cytotoxic against P388 (IC₅₀, 0.246 μ M). However, **A1**, the mononuclear analogue exhibited higher activity towards P388 (IC₅₀, 0.275 μ M) than against A549 (IC₅₀, 3.71 μ M).

For A549, the dimeric forms of isoquinolino[4,5-*bc*]acridine exhibited 10–20 fold more active cytotoxicity than its

Table 2. Cytotoxic activities of **A1**–**A6** against A549 and P388 at different concentrations (mol/L)

Compounds (M)	Inhibition of tumor growth (%) A549					Inhibition of tumor growth (%) P388				
	10 ^{−4}	10 ^{−5}	10 ^{−6}	10 ^{−7}	10 ^{−8}	10 ^{−4}	10 ^{−5}	10 ^{−6}	10 ^{−7}	10 ^{−8}
A1	98.4	97.2	38.4	0	0	100.0	100.0	39.7	10.7	4.2
A2	50.7	13.8	4.2	3.4	0	30.8	8.9	5.1	2.1	0
A3	84.3	97.8	80.2	39.9	13.8	100.0	100.0	39.5	9.0	0.4
A4	99.6	99.0	43.9	11.2	8.5	100.0	100.0	91.6	10.5	1.2
A5	94.3	82.2	73.8	15.2	12.2	100.0	80.9	6.1	5.4	5.2
A6	89.5	98.9	82.7	59.2	33.0	100.0	100.0	70.4	10.3	1.8

mono-derivative. Compound **A4**, the *N*-methylation of the potent cytotoxic agent **A3**, resulted in approximately a 2-fold less activity. **A5**, with shorter CH₂ spacer between two N atoms, led to nearly 22-fold loss of cytotoxic potency than that of **A6**. Evaluation of the polyamine bridge indicated that **A2–A5** did not exhibit good cytotoxic activity as **A6** (12.3 Å) did, which may be caused by their relatively shorter linker (from 7.3 to 11.0 Å) not allowing both intercalator moieties intercalating DNA at the same time. The aminoalkyl linker chain [(CH₂)₂–NH–(CH₂)₃–NH–(CH₂)₂] of **A6**, exhibited decent antitumor activity against both A549 and P388.

There was one interesting trend listed in Table 1 that deserved further discussion. We could see that for both A549 and P388, the alkyl chain between the aminimidic nitrogens was propylene (**A6**) rather than ethylene (**A5**) exerted greater activity (22-fold and 5-fold, respectively). In order to analyze the difference between **A5** and **A6**, their Scatchard binding constants to calf thymus DNA (in 20 mM Tris–HCl buffer, pH 7.0) were determined based on the method of fluorescence quenching technique.¹³ Figure 5 presented the Scatchard plots of spectrophotometric titrations of CT-DNA to the representative compound **A6**. The calculated Scatchard binding constants for **A5** and **A6** were $3.56 \times 10^4 \text{ M}^{-1}$ and $2.37 \times 10^5 \text{ M}^{-1}$, respectively, indicating that **A6** could form a more stable DNA complex. The order of Scatchard constants and the binding site size were similar to those in the reference.^{14a–c}

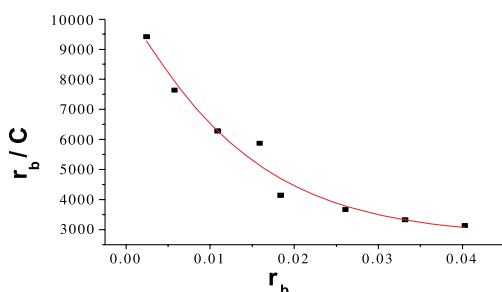

Figure 5. Scatchard plots of spectrophotometric titration of CT-DNA to **A6** in Tris–HCl buffer. A plot of r_b/c versus r_b gives the association constant (slope, $2.37 \times 10^5 \text{ M}^{-1}$) and the apparent number of binding sites per nucleotide (x -intercept, 0.04) for the agent.

To further illustrate the difference between **A5** and **A6** DNA complexes, hyperchem 7.0 package was used to build a simple molecular model. The properly modified AMBER method was selected in this study. The intercalation energies (ΔE) were calculated using $\Delta E = E_{\text{complex}} - [E_{\text{compd}} + E_{\text{DNA}}]$, where E_{complex} , E_{compd} , and E_{DNA} were the computed potential energies for the minimized average **A5/A6**-DNA complex, free **A5/A6** and free DNA.¹⁵

The images of **A5** and **A6** DNA complexes obtained by molecular modeling were presented in Figure 6. The calculated intercalation energies (ΔE) for **A5** and **A6** were -2.91 and -23.78 kcal/mol, respectively. According to the stable geometries of the bisintercalation complexes and the calculated intercalation energies (ΔE), we concluded that **A6** could exhibit higher DNA affinity than **A5**, which

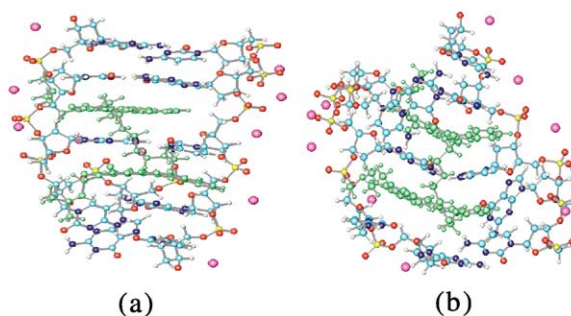

Figure 6. Images of **A5** and **A6** intercalated into d(CGCGC). Carbon atoms are colored in green, nitrogens in blue, oxygens in red and hydrogens in white, phosphorus in yellow and sodium counterions in pink. All the atoms of **A5** and **A6** are colored in green.

could be caused by the sufficient long interchromophore distance (12.3 Å).¹⁶

3. Conclusion

The design, facile synthesis, DNA-binding affinity and the cytotoxic activity of novel mono- and dinuclear isoquinolino[4,5-*bc*]acridine derivatives **A1–A6** were demonstrated. **A6** exhibited the highest in vitro antitumoral activity against human lung cancer cell (A549) and **A4** was the most active against murine leukemia cell (P388). DNA binding study and molecular modeling of the **A5/A6** DNA complexes indicated that **A6** with the long enough linker could exhibit the higher DNA affinity than **A5**, which contributed to its higher antitumor activity.

4. Experimental

4.1. Materials

All the solvents were of analytic grade. ¹H NMR was measured on a Bruker AV-400 spectrometer with chemical shifts reported as parts per million (in DMSO-*d*₆/CDCl₃, TMS as an internal standard). Mass spectra were measured on a HP 1100 LC-MS spectrometer. Melting points were determined by an X-6 micro-melting point apparatus and uncorrected. Absorption spectra were determined on PGENERAL TU-1901 UV–vis spectrophotometer.

4.2. Synthesis

4.2.1. 8-(Dimethylamino)ethylamino-5-(2-(dimethylamino)ethyl)-5H-isoquinolino[4,5-*bc*]acridine-4,6-dione (A1**):** 4-Bromo-1, 8-naphthalic anhydride (2.77 g, 10 mmol) and *N,N*-dimethylethylenediamine (1.0 g, 11.4 mmol) were added to 10 mL ethanol, the reaction mixture was stirred at reflux temperature for 2 h, then cooled, filtered, and dried, the crude product was obtained as yellow solid **1** (2.95 g, 8.5 mmol). APCI-MS (positive) m/z : 348.2 ($[M+H]^+$). (b) The obtained 4-bromo-1,8-naphthalimide derivative (2 g, 5.76 mmol) and 2-aminobenzoic acid (0.8 g, 6 mmol), copper bronze (0.038 g, 0.6 mmol), CuI (0.101 g, 0.53 mmol), were added to 10 mL DMF. The reaction mixture was stirred at 100 °C for 24 h, filtered while it was hot, and the filtrate was cooled and poured into the ice water, filtered,

and dried to get the red product **2**. (2.0 g, 4.95 mmol, 86% yield) APCI-MS (positive) *m/z*: 404.3 ($[M+H]^+$). This product was not purified and used directly in the next step. (c) 1 g of **2** was stirred in phosphorus oxychloride at 110 °C for 12 h, then cooled and poured into the ice water, $N(Et)_3$ was added when stirred vigorously, filtered, and dried to give yellow solid **3** (0.88 g, 88% yield).

Purified by silica gel chromatography ($CHCl_3/MeOH=9:1$, v/v) to get pure product **3**, Mp: 204.8–205.2 °C. 1H NMR ($CDCl_3$) δ (ppm): 2.99 (s, 6H, NCH_3), 3.51 (s, 2H, NCH_2), 4.69–4.72 (t, $J_1=6.0$ Hz, $J_2=6.0$ Hz, 2H, $CONCH_2$), 7.77–7.81 (t, $J_1=7.6$ Hz, $J_2=7.6$ Hz, 1H), 7.97–8.04 (m, 2H), 8.39–8.42 (d, $J_1=8.8$ Hz, 1H), 8.52–8.54 (d, $J=8.4$ Hz, 1H), 8.72–8.74 (d, $J=7.6$ Hz, 1H), 9.52 (s, 1H), 9.77–9.79 (d, $J=8.0$ Hz, 1H), ESI-HRMS: calcd for $C_{23}H_{19}ClN_3O_2$ ($M+H^+$): 404.1166, Found: 404.1166, Found: 404.1158. IR (KBr): 2923, 2853, 1702, 1660, 1347 cm^{-1} .

The above obtained compound (1 g, 2.48 mmol) and *N,N*-dimethylethylenediamine (0.26 g, 2.97 mmol) were added to 10 mL acetonitrile. The solution was refluxed for 5 h, cooled and filtered. Separated by silica gel chromatography ($CHCl_3/MeOH=5:1$, v/v) to get pure **A1** (1.01 g, 90% yield), Mp: 148.9–150.4 °C. 1H NMR ($CDCl_3$) δ (ppm): 2.47 (s, 6H, $N(CH_3)_2$), 2.52 (s, 6H, $N(CH_3)_2$), 2.75–2.78 (t, $J_1=6.0$ Hz, $J_2=5.2$ Hz, 2H, CH_2), 2.87 (s, 2H, CH_2), 4.06–4.09 (t, $J_1=5.6$ Hz, $J_2=6.0$ Hz, 2H, CH_2), 4.42–4.46 (t, $J_1=6.8$ Hz, $J_2=7.2$ Hz, 2H, CH_2), 7.52–7.55 (t, $J_1=6.8$ Hz, $J_2=7.6$ Hz, 1H), 7.79–7.88 (m, 2H), 8.13–8.15 (d, $J=8.4$ Hz, 1H), 8.20–8.22 (d, $J=8.4$ Hz, 1H), 8.61–8.63 (d, $J=7.6$ Hz, 1H), 9.35 (s, 1H), 9.63–9.65 (d, $J=8.8$ Hz, 1H), ESI-HRMS: calcd for $C_{13.5}H_{15.5}N_{2.5}O$ ($M+2H^+/2$): 228.6239, Found: 228.6231. IR (KBr): 3397, 2924, 2854, 1692, 1653, 1347 cm^{-1} .

4.3. Synthesis of dinuclear isoquinolino[4,5-*bc*]acridine derivatives **A2–A6**

The preparation and purification procedure of **A2–A6** was similar to that of **A1**: several polyamine chains were selected instead of *N,N*-dimethylethylenediamine.

4.3.1. Compound A2. Purified by silica gel chromatography ($CHCl_3/MeOH/NH_4OH=1:2:0.03$, v/v/v), 69% yield, Mp: 191.3–191.5 °C. 1H NMR (d_6 -DMSO) δ (ppm): 2.28 (s, 4H, $2CH_2$), 2.45 (s, 12H, $2N(CH_3)_2$), 3.19 (s, 4H, $2CH_2$), 3.71 (s, 4H, $2CH_2$), 4.02 (s, 4H, $2CH_2$), 7.33 (s, 2H), 7.67–7.71 (m, 4H), 7.78–7.80 (d, $J=8.4$ Hz, 2H), 8.23–8.25 (d, $J=8.0$ Hz, 2H), 8.28–8.30 (d, $J=8.4$ Hz, 2H), 8.96 (s, 2H), 9.08–9.10 (d, $J=8.4$ Hz, 2H), ESI-HRMS: calcd for $C_{25}H_{24.5}N_{4.5}O_2$ ($M+2H^+/2$): 419.6954, Found: 419.6948. IR (KBr): 3427, 2922, 2853, 1696, 1653, 1346 cm^{-1} .

4.3.2. Compound A3. Purified by silica gel chromatography ($CHCl_3/MeOH/NH_4OH=1:2:0.03$, v/v/v), 61% yield, Mp: 195.9–196.1 °C. 1H NMR ($CDCl_3$) δ (ppm): 2.18 (s, 4H, $2CH_2$), 2.32 (s, 12H, $2N(CH_3)_2$), 2.47 (s, 4H, $2CH_2$), 3.18 (s, 4H, $2CH_2$), 3.85 (s, 4H, $2CH_2$), 4.18 (s, 4H, $2CH_2$), 7.32–7.36 (t, $J_1=7.2$ Hz, $J_2=8.0$ Hz, 2H), 7.62–7.66 (m, 4H), 7.77–7.79 (d, $J=8.4$ Hz, 2H), 8.02 (s, br, 2H), 8.32–8.34 (d, $J=8.0$ Hz, 2H), 8.86 (s, 2H), 8.97–8.99 (d, $J=8.0$ Hz, 2H), ESI-HRMS: calcd for $C_{17.3}H_{18}N_3O_{1.3}$ ($M+$

$3H^+/3$): 289.4766, Found: 289.4767. IR (KBr): 3399, 2924, 2853, 1689, 1650, 1376 cm^{-1} .

4.3.3. Compound A4. Purified by silica gel chromatography ($CHCl_3/MeOH/NH_4OH=1:2:0.03$, v/v/v), 85% yield, Mp: 213.6–213.8 °C. 1H NMR (d_6 -DMSO) δ (ppm): 2.15 (s, 4H, $2CH_2$), 2.30 (s, 4H, $2CH_2$), 2.32 (s, 3H, NCH_3), 2.42 (s, 12H, $2NCH_3$), 2.74 (s, 4H, $2CH_2$), 3.66 (s, 4H, $2CH_2$), 4.01 (s, 4H, $2CH_2$), 7.33–7.37 (t, $J_1=7.6$ Hz, $J_2=7.6$ Hz, 2H), 7.33–7.37 (t, $J_1=7.6$ Hz, $J_2=7.6$ Hz, 2H), 7.56–7.69 (m, 6H), 8.12–8.14 (d, $J=7.2$ Hz, 2H), 8.28–8.30 (d, $J=8.0$ Hz, 2H), 8.71 (s, 2H), 8.85–8.87 (d, $J=7.2$ Hz, 2H), ESI-HRMS: calcd for $C_{17.7}H_{18.7}N_3O_{1.3}$ ($M+3H^+/3$): 294.1485, Found: 294.1483. IR (KBr): 3431, 2922, 2854, 1691, 1652, 1395 cm^{-1} .

4.3.4. Compound A5. Purified by silica gel chromatography ($CHCl_3/MeOH/NH_4OH=1:2:0.06$, v/v/v), 52% yield, Mp: 159.9–160.1 °C. 1H NMR (d_6 -DMSO) δ (ppm): 2.35–2.39 (t, $J_1=6.8$ Hz, $J_2=6.8$ Hz, 4H, $2CH_2$), 2.40 (s, 6H, $2NCH_3$), 2.97 (s, 4H, $2CH_2$), 3.13 (s, 4H, $2CH_2$), 3.79 (s, 4H, $2CH_2$), 3.97 (s, 4H, $2CH_2$), 7.33 (s, 2H), 7.57–7.64 (m, 6H), 8.12–8.14 (d, $J=6.8$ Hz, 2H), 8.29–8.31 (d, $J=8.0$ Hz, 2H), 8.85 (s, 2H), 8.92–8.94 (d, $J=8.4$ Hz, 2H), ESI-HRMS: calcd for $C_{26}H_{27}N_5O_2$ ($M+2H^+/2$): 441.2165, Found: 441.2179. IR (KBr): 3419, 2926, 2852, 1693, 1650, 1392 cm^{-1} .

4.3.5. Compound A6. Purified by silica gel chromatography ($CHCl_3/MeOH/NH_4OH=1:2:0.06$, v/v/v), 33% yield, Mp: 102.2–102.5 °C. 1H NMR (d_6 -DMSO) δ (ppm): 2.11–2.14 (m, 2H, CH_2), 2.37 (s, 4H, $2CH_2$), 2.54 (s, 12H, $2N(CH_3)_2$), 2.89 (s, 4H, $2CH_2$), 3.03 (s, 4H, $2CH_2$), 3.82 (s, 4H, $2CH_2$), 3.90 (s, 4H, $2CH_2$), 7.40 (s, 2H), 7.60–7.69 (m, 6H), 8.17–8.19 (d, $J=7.6$ Hz, 2H), 8.26–8.28 (d, $J=8.0$ Hz, 2H), 8.85 (s, 2H), 8.97–8.99 (d, $J=8.0$ Hz, 2H), ESI-HRMS: calcd for $C_{26.5}H_{28}N_5O_2$ ($M+2H^+/2$): 448.2243, Found: 448.2260. IR (KBr): 3334, 2924, 2853, 1695, 1654, 1391 cm^{-1} .

4.4. CT-DNA binding studies

The solution of compounds **A5** and **A6** in DMSO (10^{-3} – 10^{-4} M) was diluted with 20 mM Tris–HCl (pH 7.0) to the samples at the concentration of 1, 2.5, 5, 7.5, 10, 15, 20, 25 μ M, respectively. Then, it was separated to two parts: one contained Calf-thymus DNA 30 μ M, the other contained no DNA but the same concentration of chemical as control. All the above solutions were shaken for 3 days at 25 °C in the dark. Fluorescence wavelength and intensity area of samples were measured.

4.5. DNA unwinding angle measurement

Covalently closed circular plasmid DNA, pBR 322, was purchased from TaKaRa Co., Ltd as a 0.5 mg per mL. Prior to application to the agarose gel, pBR322 DNA aliquots were incubated with the compounds at 37 °C in TE buffer (Tris–HCl 10 mM, pH 7.4, EDTA 0.1 mM) for 24 h at several molar ratios of drug to nucleotide. The density of supercoiling was $\delta -0.08$ under our experimental conditions.¹⁷

The fraction of unreacted drug was separated from the mixture by precipitation of the DNA with 2.5 V of ethanol and 0.3 M sodium acetate, pH 4.8. Two percentage of agarose gel electrophoresis was carried out at 25 V in 40 mM TAE buffer (40 mM tris(hydroxymethyl)amino-methane, 30 mM glacial acetic acid, 1 mM EDTA, pH 7.5). After electrophoresis, the gel was stained with ethidium bromide.

4.6. Molecular modeling methods

The d (CGCGC) was selected as the intercalation site sequence, a preferential feature for cytostatic active principles^{17b,18a,b} and the similar intercalative mode by **A5** and **A6** was supposed. According to the parameters of reference,^{18c-e} AMBER method was properly modified. In all cases, $\xi = 4r$ was used to simulate the solvent effects Na^+ counterions were included, placed at 6 Å distance from each phosphate–oxygen bisector.

4.7. Cytotoxic activity in vitro

The prepared compounds have been submitted to Shanghai Institute of Materia Medica for testing their cytotoxicities in vitro.

A549 (human lung cancer cell) and P388 (murine leukemia cell) were seeded into 96 well cell culture plates before experimental manipulation, and then treated with a test compound each at different concentrations for 72 h. At the end of treatments, A549 and P388 cell numbers were determined by SRB and MTT assay, respectively.^{19,20}

For the MTT assay, briefly, a 20 μL of MTT [3-(4,5-dimethylthiazol-2-yl)-2,5-diphenyltetrazolium bromide] solution (5 mg/mL) was added directly to all the appropriate wells. The cultures were then incubated for 4 h. Then 100 μL of 'triplex solution' (10% SDS/ 5% isobutanol/ 12 mM HCl) was added. After the plates were incubated at 37 °C overnight, they were measured by the absorbance at 570 nm using a multiwell spectrophotometer.

For the SRB assay, in brief, the cells were fixed with 10% trichloroacetic acid for an hour at 4 °C. After they were extensively washed, fixed cells were stained for 30 min with 0.4% sulforhodamine B (SRB) in 1% acetic acid. Unbound SRB was washed away with 1% acetic acid. Then, the cultures were air-dried. Bound dye was solubilized with 10 mM Tris (pH 10.5) prior to reading plates. The OD value was read on a plate reader at a wavelength of 515 nm. The ratio of the OD (optical density) value of a compound-treated culture to the OD value of a mock-treated culture, expressed in percentage, was used to quantify the cytotoxicity of a compound. Results were expressed as IC_{50} (the drug concentration that reduces by 50% the absorbance in treated cells with respect to untreated cells).

The cytotoxic activities of **A1–A6** against the selected tumor cell lines A549 and P388 at different concentrations were listed in Table 2. The numbers 10^{-4} – 10^{-8} were the concentrations of the test compounds while the numbers in the matrix were the ratio of the OD of the treated sample

relative to that of the control sample. IC_{50} in Table 1 was calculated based on these parameters.

Acknowledgements

Financial support by National Basic Research Program of China(2003CB114400) and under the auspices of 863 plan for High-Tech (2003AA2Z3520), is greatly appreciated. This work is also supported by Dalian Excellent Young Scientist Research Fund.

References and notes

1. Kochevar, E. D. D. In *Dunn in Bioorganic Photochemistry*; Morrison, H., Ed.; Wiley: New York, 1990; pp 273–283.
2. (a) Wakelin, L. P. G. *Med. Res. Rev.* **1986**, *6*, 275–340. (b) Hsiang, Y. H.; Jiang, J. B.; Liu, L. F. *Mol. Pharmacol.* **1989**, *36*, 371–376. (c) Cholody, W. M.; Hernandez, L.; Hassner, L.; Scudiero, D. A.; Djurickovic, D. B.; Michejda, C. J. *J. Med. Chem.* **1995**, *38*, 3043–3052. (d) Spicer, J. A.; Gamage, S. A.; Atwell, G. J.; Finlay, G. J.; Baguley, B. C.; Denny, W. A. *Anti-Cancer Drug Des.* **1999**, *14*, 281–289.
3. Bousquet, P. F.; Brana, M. F.; Conlon, D.; Fitzgerald, K.; Perron, M. D.; Cocchiario, C.; Miller, R.; Moran, M.; George, J.; Qian, X. D.; Keilhauer, G.; Romerdahl, C. A. *Cancer Res.* **1995**, *55*, 1176–1189.
4. (a) Laursen, J. B.; Nielsen, J. *Chem. Rev.* **2004**, *104*, 1663–1686. (b) Blanchard, S.; Rodriguez, I.; Tardy, C.; Baldeyrou, B.; Bailly, C.; Colson, P.; Houssier, C.; Leonce, S.; Kraus, B. L.; Pfeiffer, B.; Renard, P.; Pierre, A.; Caubere, P.; Guillaumet, G. *J. Med. Chem.* **2004**, *47*, 978–987. (c) Hay, M. P.; Pruijn, F. B.; Gamage, S. A.; Lyanage, H. D. S.; Kovacs, M. S.; Patterson, A. V.; Wilson, W. R.; Brown, J. M.; Denny, W. A. *J. Med. Chem.* **2004**, *47*, 475–488. (d) Antonini, I.; Polucci, P.; Magnano, A.; Gatto, B.; Palumbo, M.; Menta, E.; Pescalli, N.; Martelli, S. *J. Med. Chem.* **2003**, *46*, 3109–3115. (e) Rastogi, K.; Chang, J.-Y.; Pan, W.-Y.; Chen, C.-H.; Chou, T.-C.; Chen, L.-T.; Su, T.-L. *J. Med. Chem.* **2002**, *45*, 4485–4493. (f) Gamage, S. A.; Spicer, J. A.; Rewcastle, G. W.; Milton, J.; Sohal, S.; Dangerfield, W.; Mistry, P.; Vicker, N.; Charlton, P. A.; Denny, W. A. *J. Med. Chem.* **2002**, *45*, 740–743. (g) Wang, S.; Miller, W.; Milton, J.; Nigel, V.; Alistair, S.; Peter, C.; Prakash, M.; David, H.; William, A. D. *Bioorg. Med. Chem. Lett.* **2002**, *12*, 415–418. (h) Brana, M. F.; Ramos, A. *Curr. Med. Chem.: Anti-Cancer Agents* **2001**, *1*, 237–255. (i) Rogers, J. E.; Weiss, S. J.; Kelly, L. A. *J. Am. Chem. Soc.* **2000**, *122*, 427–436. (j) Qian, X.; Huang, T. B.; Wei, D.-Z.; Zhu, D. H.; Fan, M. C.; Yao, W. *J. Chem. Soc., Perkin Trans. 2* **2000**, 715–718. (k) Rogers, J. E.; Kelly, L. A. *J. Am. Chem. Soc.* **1999**, *121*, 3854–3861. (l) Brana, M. F.; Castellano, J. M.; Perron, D.; Maher, C.; Conlon, D.; Bousquet, P. F.; George, J.; Qian, X.-D.; Robinson, S. P. *J. Med. Chem.* **1997**, *40*, 449–454.
5. Brana, M. F.; Cacho, M.; Garcia, M. A.; Pascual, T. B.; Ramos, A.; Dominguez, M. T.; Pozuelo, J. M.; Abradelo, C.; Rey, S. M. F.; Yuste, M.; Banez, C. M.; Lacal, J. C. *J. Med. Chem.* **2004**, *47*, 1391–1399.

6. Girault, S.; Grellier, P.; Berecibar, A.; Maes, L.; Mouray, E.; Lemiere, P.; Debreu, M. A.; Davioud, C. E.; Sergheraert, C. *J. Med. Chem.* **2000**, *43*, 2646–2654.
7. (a) Yang, Q.; Qian, X. H.; Xu, J. Q.; Sun, Y. S.; Li, Y. G. *Bioorg. Med. Chem.* **2005**, *13*, 1615–1622. (b) Qian, X. H.; Li, Y. G.; Xu, Y. F.; Liu, D.; Qu, B. Y. *Bioorg. Med. Chem.* **2004**, *14*, 2665–2668. (c) Xu, Y. F.; Qian, X. H.; Yao, W.; Mao, P.; Cui, J. *Bioorg. Med. Chem.* **2003**, *11*, 5427–5433. (d) Qian, X. H.; Yao, W.; Chen, G.; Huang, X. Y.; Mao, P. *Tetrahedron Lett.* **2001**, *42*, 6175–6178.
8. Wakelin, L. P.; Romanos, M.; Chen, T. K.; Glaubiger, D.; Canellakis, E. S.; Waring, M. J. *Biochemistry* **1978**, *17*, 5057–5063.
9. Baudoin, O.; Teulade, F. P. M.; Vigneron, J. P.; Lehn, J. M. *J. Org. Chem.* **1997**, *62*, 5458–5470.
10. Acheson, R. M.; Acridines, the chemistry of heterocyclic compounds; Wiley: London, 1973; 9; pp 563–574.
11. Byk, G.; Dubertret, C.; Escriou, V.; Frederic, M.; Jaslin, G.; Rangara, R.; Pitard, B.; Crouzet, J.; Wils, P.; Schwartz, B.; Scherman, D. *J. Med. Chem.* **1998**, *41*, 224–235.
12. Keck, M. V.; Lippard, S. J. *J. Am. Chem. Soc.* **1992**, *114*, 3386–3390.
13. Gupta, M.; Ali, R. *J. Biochem.* **1984**, *95*, 1253–1257.
14. (a) Wirth, M.; Buchardt, O.; Koch, T.; Nielsen, P. E.; Norden, B. *J. Am. Chem. Soc.* **1988**, *110*, 932–939. (b) Boger, D. L.; Ichikawa, S.; Tse, W. C.; Hedrick, M. P.; Jin, Q. *J. Am. Chem. Soc.* **2001**, *123*, 561–568. (c) Antonini, I.; Polucci, P.; Magnano, A.; Sparapani, S.; Martelli, S. *J. Med. Chem.* **2004**, *47*, 5244–5250.
15. Cairns, D.; Michalitsi, E.; Jenkins, T. C.; Mackay, S. P. *Bioorg. Med. Chem.* **2002**, *10*, 803–807.
16. Bailly, C.; Carrasco, C.; Joubert, A.; Bal, C.; Wattez, N.; Hildebrand, M. P.; Lansiaux, A.; Colson, P.; Houssier, C.; Cacho, M.; Ramos, A.; Brana, M. F. *Biochemistry* **2003**, *42*, 4136–4150.
17. (a) Wakelin, L. P. G.; Bu, X.; Eleftheriou, A.; Parmar, A.; Hayek, C.; Stewart, B. W. *J. Med. Chem.* **2003**, *46*, 5790–5802. (b) Brana, M. F.; Casarrubios, L.; Dominguez, G.; Fernandez, C.; Perez, J. M.; Quiroga, A. G.; Navarro-Ranninger, C.; de Pascual-Teresa, B. *Eur. J. Med. Chem.* **2002**, *37*, 301–313.
18. (a) Ornstein, R. L.; Rein, R. *Biopolymers* **1979**, *18*, 2821–2847. (b) Chaires, J. B. *Biophys. Chem.* **1990**, *35*, 191–202. (c) Marinela, R. C.; Sanz, A. M.; Yunta, M. J. R.; Fernando, G. C.; Navarro, P.; Fernandez, I.; Pardo, M.; Canoa, C. *Bioorg. Med. Chem.* **2003**, *11*, 2143–2148. (d) Fox, T.; Scanlan, T. S.; Kollman, P. A. *J. Am. Chem. Soc.* **1997**, *119*, 11571–11577. (e) Grootenhuis, P. D.; Kollman, P. A. *J. Am. Chem. Soc.* **1989**, *111*, 2152–2158.
19. Skehan, P.; Storeng, R.; Scudiero, D.; Monks, A.; McMahon, J.; Vistica, D.; Warren, J. T.; Bokesch, H.; Kenney, S.; Boyd, M. R. *J. Natl. Cancer Inst.* **1990**, *82*, 1107–1112.
20. Alley, M. C.; Scudiero, D. A.; Monks, A.; Hursey, M. L.; Czerwinski, M. J.; Fine, D. L.; Abbott, B. J.; Mayo, J. G.; Shoemaker, R. H.; Boyd, M. R. *Cancer Res.* **1988**, *48*, 589–601.

Enantiopure arenesulfenic acids as intermediates in stereoselective synthesis

Maria C. Aversa,^a Paola Bonaccorsi,^{a,*} Cristina Faggi,^b Giuseppe Lamanna^c
and Stefano Menichetti^{c,*}

^aDipartimento di Chimica organica e biologica, Università degli Studi di Messina, Salita Sperone 31 (vill. S. Agata), 98166 Messina, Italy

^bCentro interdipartimentale di Cristallografia, Università degli Studi di Firenze, via della Lastruccia 13, 50019 Sesto Fiorentino, Firenze, Italy

^cDipartimento di Chimica organica 'Ugo Schiff', Università degli Studi di Firenze, via della Lastruccia 13, 50019 Sesto Fiorentino, Firenze, Italy

Received 15 July 2005; revised 7 September 2005; accepted 15 September 2005

Available online 4 October 2005

Abstract—New transient arenesulfenic acids were involved in the synthesis of enantiopure 2-arylsulfinyl-1,3-dienes, showing central or axial chirality of the substituted arene residue, apart from the chirality related to the stereogenic sulfur atom. Some of the obtained dienes, that is, (*S_aS_S*)- and (*S_aR_S*)-2-(2'-hydroxy-1,1'-binaphthalen-2-sulfinyl)-3-methyl-1,3-butadienes, were subjected to diastereoselective Diels–Alder cycloadditions with *N*-methylmaleimide. Removal of the arylsulfoxide auxiliary, in the major adduct, was accomplished by reductive cleavage with Raney nickel.

© 2005 Elsevier Ltd. All rights reserved.

1. Introduction

It has been widely demonstrated that chemo and regio-selective *syn*-addition of a sulfenic acid to conjugated enynes represents a convenient synthetic strategy for the preparation of diene sulfoxides, significant partners in Diels–Alder (DA) cycloadditions, with the sulfinyl group acting as chiral auxiliary.¹ The *syn*-addition is a thermal six-electron process whose intrinsic nature does not imply any acid or basic conditions, so ensuring formation of the sulfoxide moiety even in the presence of pH sensitive functional groups. Good to high yields are generally observed. Sulfenic acids, that are generated in situ from opportune precursors, can be obtained in enantiomerically pure form, providing access to enantiopure sulfinyl dienes.

Camphorsulfonic and mandelic acids, readily available members of the chiral pool, were chosen as starting compounds in the preparation of precursors of enantiopure sulfenic acids **1–3** for the contiguity of a hydroxy function to the sulfur atom (Fig. 1). This contiguity guarantees an intramolecular hydrogen bond, between the hydroxy group

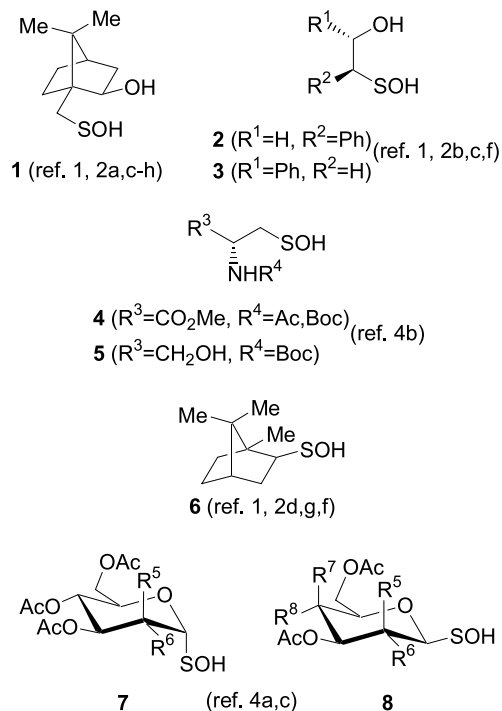

Figure 1. Transient enantiopure sulfenic acids.

Keywords: Arenesulfenic acids; Diastereofacial selectivity; Diels–Alder cycloadditions; *N*-methylmaleimide; Sulfinyl dienes.

* Corresponding authors. Tel.: +39 090 6765187; fax: +39 090 393895 (P.B.); tel.: +39 055 4573535; fax: +39 055 4573531 (S.M.); e-mail addresses: paolab@isengard.unime.it; stefano.menichetti@unifi.it

and the oxygen atom of the sulfoxide moiety, that facilitates the chromatographic separation of diastereoisomers and in some cases enhances stereoselection in concerted processes.² The high steric demands of the camphor skeleton are maintained in the commercially available [(1*S*)-*endo*]-(-)-borneol that was easily transformed into a precursor of the enantiopure sulfenic acid **6**, showing no possibilities of intramolecular hydrogen bonding.^{2d-g} Indeed, an intramolecular hydrogen bonding, also useful in preventing self-condensation of sulfenic acids, can present some disadvantages due to unexpected and undesired reactions of the hydroxy function in the subsequent synthetic transformations of the sulfoxides obtained from sulfenic acids such as **1–3**.^{2f,3} L-cysteine and α - and β -D-1-thioglycopyranose are stimulating starting products for the generation of transient sulfenic acids **4**, **5**, **7**, **8** that allowed the synthesis of enantiopure sulfinyl dienes showing the L-cysteine or 1-thio-D-glycopyranose S-oxide frameworks as chiral auxiliaries where the stereo-differentiating moiety is also a biologically active residue.⁴

Almost all the sulfinyl dienes, including the chiral above-mentioned S-alkyl residues, have been involved in DA reactions that afforded the expected cycloadducts, easily obtainable in enantiomerically pure forms and good yields. However, removal from these adducts of the sulfoxide function, directly linked to an alkyl group on one side, and to an unsaturated carbon on the other, represented a big challenge. Desulfurization by nickel reagents or sodium amalgam failed on several occasions and indirect methodologies were exploited for reaching this goal.^{2d,5}

In this paper we describe the synthesis of new sulfinyl dienes in which an enantiopure aryl group is directly linked to the sulfur atom. These S-arylsulfinyl dienes have been obtained via the corresponding sulfenic acids, possessing central or axial chirality, and their addition to opportune enynes. Some of the obtained dienes have been subjected to DA cycloaddition with *N*-methylmaleimide (NMM), followed by removal of the arylsulfoxide auxiliary that was accomplished by Raney nickel desulfurization, making straightforward and efficient the overall synthetic process towards functionalized enantiopure cyclic molecules.

2. Results and discussion

Two main reasons gave rise to the selection of resorcinol (**9**) as starting material for the preparation of enantiopure dienes **15** via sulfenic acid **14** showing central chirality (Scheme 1): (i) an electron-rich aromatic ring was necessary for the chosen synthetic sequence [sulfenylation with phtalimide-sulfonyl chloride (PhtNSCl)⁶ of **10** followed by LAH reduction] that allowed the introduction of a thiol function onto the benzene nucleus; (ii) only one of the two hydroxy functions in **9** could be easily derivatized, with a commercial enantiopure reagent, for the generation of the enantiopure arenesulfenic acid **14**, where the remaining free hydroxy substituent, opportunely placed onto the aromatic ring, would provide an intramolecular hydrogen bonding with the oxygen atom in the sulfenic function, so mitigating the heavy disposition of sulfenic acids to self-condensation.

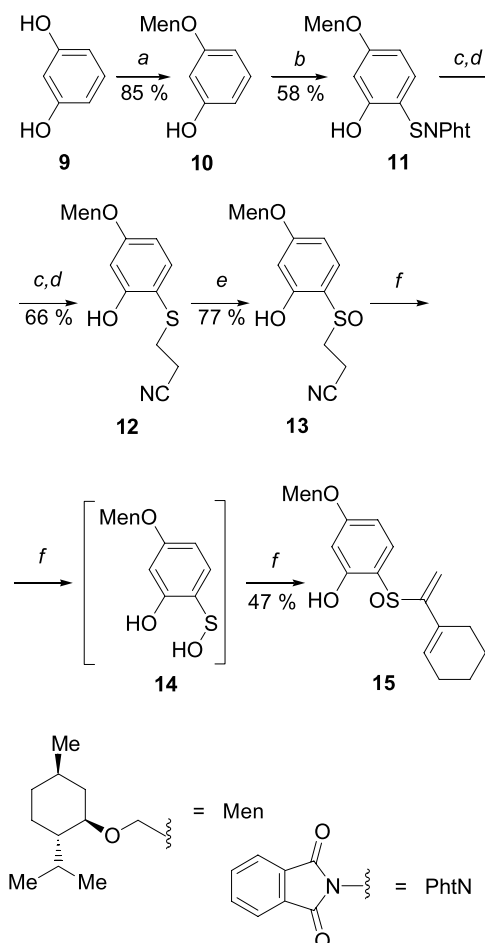

Scheme 1. Reagents and conditions: (a) MenCl, K₂CO₃, 50 °C, 46 h; (b) PhtNSCl, CHCl₃, 0 °C, 20 min; (c) LAH, THF, rt, 1 h; (d) CH₂=CHCN, Et₃N, THF, rt, 20 h; (e) *m*-CPBA, CH₂Cl₂, 0 °C, 20 min (1:1 S-epimers); (f) 1-ethynylcyclohexene, 130 °C, 1 h (1:1 S-epimers).

The commercially available (-)-chloromethyl menthyl ether (MenCl) was used to link a chiral auxiliary to one hydroxy function in **9**, since the Men residue has the advantage of possessing no reactive groups that could interfere during the whole synthetic pathway. The reaction between resorcinol (**9**) and MenCl was performed in the presence of potassium carbonate, in a molar ratio of 5:1:3, respectively (Scheme 1).

Enantiopure phenol **10** was then subjected to completely regioselective sulfenylation with PhtNSCl, at 0 °C to avoid ether cleavage, and compound **11** was obtained as the unique product. LAH reduction, conjugate addition onto acrylonitrile, and *m*-CPBA oxidation led to epimeric sulfoxides **13**, that are precursors of the enantiopure arenesulfenic acid **14**. Thermolysis of nitrile mixture **13** was performed in neat 1-ethynylcyclohexene, at 130 °C for 1 h. The completely chemo- and regioselective addition of sulfenic acid **14** to the triple bond of ethynylcyclohexene gave the epimeric mixture of sulfinyl dienes **15** in 1:1 ratio. These two epimeric sulfoxides appeared as a single spot by TLC, although several different solvent systems were evaluated. Column chromatography of the mixture **15** allowed the isolation of only small quantities of each of the two enantiopure epimers **15** that were fully

characterized. However, this difficulty in isolation prompted us to drop the project of involving enantiopure dienes **15** in DA cycloadditions. The very difficult separation of sulfinyl dienes **15** appears as a consequence of their similar chromatographic features, due to the distance between the stereodifferentiating menthyl substituent and the sulfinyl group.

Our attention then turned to *S*-arylsulfinyl dienes whose aryl substituent could possess an intrinsic chirality. Enantiopure dienes **20** and **21** in Scheme 2 show not only the central chirality due to the stereogenic sulfur atom but also the axial chirality coming from the atropoisomeric binaphthyl moiety linked to the sulfoxide group. The synthesis of **20** and **21** was performed starting from enantiopure (*S_a*)-2'-mercapto-1,1'-binaphthalen-2-ol (**16**), easily prepared from commercial (*S_a*)-(-)-1,1'-bi-2-naphthol.⁷ Thiol **16** can be warmed up to 250 °C without racemization, thus allowing the safe generation of sulfenic acid **19** in enantiomerically pure form by the well-assessed thermal strategy that implies

the use of temperatures between 40 and 140 °C, in dependence of the structure of the sulfoxide precursor.⁸

Nucleophilic addition of thiol **16** onto acrylonitrile in the presence of triethylamine, followed by *m*-CPBA oxidation, led to sulfoxides **18** (1:1 *S*-epimers). Thermolysis of **18** to **19** was performed in the presence of commercially available 2-methyl-1-buten-3-yne, at 110 °C for 1.5 h, and gave sulfinyl dienes **20** and **21** in 1:1 ratio and 75% total yield. The epimeric mixture of the two sulfinyl dienes **20** and **21** was subjected to column chromatography, and they were easily separated and fully characterized. The configuration at sulfur atom of sulfoxides **20** and **21**, shown in Scheme 2, was inferred from X-ray crystallographic analysis of cycloadduct **25** (Fig. 2). The obtained results confirmed expectations based on the intramolecular hydrogen bonding, between the hydroxy function of the binaphthyl residue and the sulfoxide oxygen, and its relationship with the difference in chromatographic mobility^{2c} observed between the two epimeric sulfinyl dienes **20** and **21**.

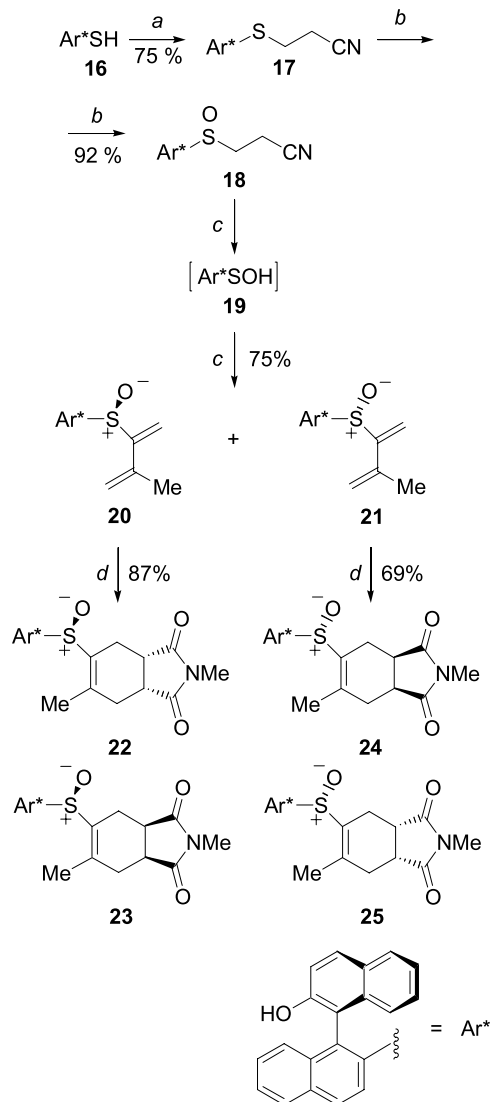

Scheme 2. Reagents and conditions: (a) $\text{CH}_2=\text{CHCN}$, Et_3N , THF, rt, 72 h; (b) *m*-CPBA, CH_2Cl_2 , -50°C , 1 h (1:1 *S*-epimers); (c) 2-methyl-1-buten-3-yne, 110°C , 1.5 h (**20/21** 1:1); (d) *N*-methylmaleimide, CH_2Cl_2 , 40°C (**22/23** 2:1, **24/25** 3:2).

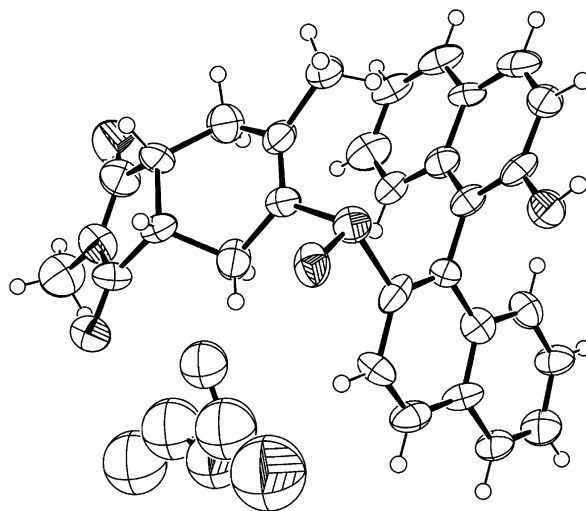

Figure 2. Perspective view of the structure of **25** crystallized with a molecule of ethyl acetate in the asymmetric unit.

Actually (*S_a*,*R_S*)-2-(2'-hydroxy-1,1'-binaphthalen-2-sulfinyl)-3-methyl-1,3-butadiene (**21**) was reacted with NMM in dichloromethane to give the two diastereoisomeric cycloadducts **24** and **25** in 3:2 ratio and 69% total yield (Scheme 2). Column chromatography furnished the major adduct **24** as first eluted product, followed by minor adduct **25**. The two cycloadducts **24** and **25** were separately subjected to several recrystallizations, but only minor cycloadduct **25** afforded crystals suitable for X-ray analysis from ethyl acetate (Fig. 2). Results of crystallographic analysis allowed assignment of configurations at the newly formed stereocentres C-3a and C-7a of cycloadducts **24** (*S_a*,*R_S*,3*aR*,7*aS*) and **25** (*S_a*,*R_S*,3*aS*,7*aR*). The stereochemical outcome of the cycloaddition between enantiopure diene **21** and NMM can be rationalized as follows. Low diastereofacial selectivity was observed, in favour of cycloadduct **24**, which came from NMM approaching the (*Si*) face of diene **21** preferentially adopting the A conformation in the DA transition state (Fig. 3).⁹ The appreciable formation of the minor adduct **25** by NMM approach to the (*Re*) face of diene

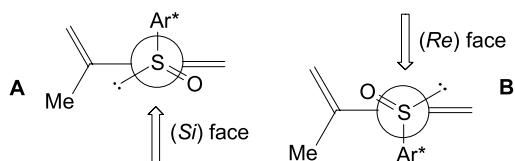
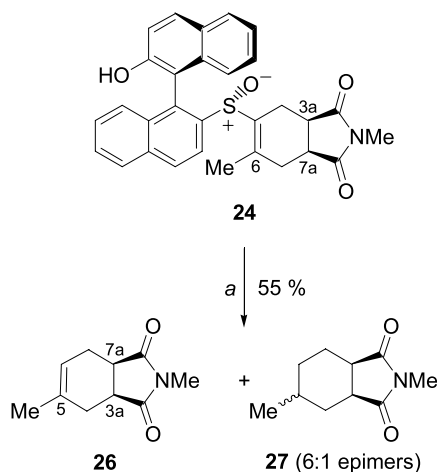

Figure 3. Conformational preferences in Diels–Alder transition states of diene **21**.

21 in its **B** conformation, where sulfur oxygen is maintained transoid to C-1/C-2 double bond, is a consequence of the steric features of both the binaphthyl group linked to the sulfoxide sulfur and the 3-methyl substituent on the 2-sulfinyl-1,3-diene skeleton. These two factors, together with the steric requirement of the dienophile, reduce the topological differentiation between the diene faces, induced by the sulfinyl group.¹⁰

DA cycloaddition of (S_a, S_S)-2-(2'-hydroxy-1,1'-binaphthalen-2-sulfinyl)-3-methyl-1,3-butadiene (**20**) with NMM led to cycloadducts **22** (chromatographically more mobile) and **23** in 2:1 ratio, respectively, and 87% overall yield (Scheme 2). This diastereoselection amount is in line with the one measured in the DA cycloaddition of diene **21** (see above). The configuration at C-3a and C-7a shown in Scheme 2 for adducts **22** and **23** is determined by the sulfur configuration in **20**, so that the diene **20** (S_S)/NMM approaches are opposite to the ones observed in the DA reaction of diene **21** (R_S).

Desulfurization of the major adduct **24** was realized in 5 h by commercial W-2 Raney nickel (Scheme 3). (3a*S*,7a*R*)-3a,4,7,7a-tetrahydro-2,5-dimethyl-1*H*-isoindole-1,3(2*H*)-dione (**26**) and (3a*S*,7a*R*)-hexahydro-2,5-dimethyl-1*H*-isoindole-1,3(2*H*)-diones **27** (6:1 epimeric mixture) were obtained in 55% overall yield, separated by column chromatography, and identified by comparison with literature data.¹¹ Despite the formation of **27**, together with the enantiopure compound **26**, was unsatisfactory but predictable in the reductive cleavage of aryl(ethenyl)sulfoxide **24**, the use of a *S*-aryl substituted chiral auxiliary ensured an easy desulfurization process.



Scheme 3. Reagents and conditions: (a) Raney nickel, THF, rt, 5 h (**26/27** 2:1).

3. Conclusions

In this paper, we have reported an useful development of the well-assessed methodology to build up diene skeletons, bearing a chiral sulfinyl substituent.^{1–5} New transient arenensulfenic acids were involved in the synthesis of enantiopure 2-arylsulfinyl-1,3-dienes, showing central or axial chirality of the substituted arene residue, apart from the chirality related to the stereogenic sulfur atom. Some of the obtained dienes show a binaphthyl moiety linked to the sulfoxide group and were easily prepared from (S_a)-2'-mercapto-1,1'-binaphthalen-2-ol (**16**). Both enantiopure (S_a)-2-(2'-hydroxy-1,1'-binaphthalen-2-sulfinyl)-3-methyl-1,3-butadienes **20** and **21** were subjected to DA reaction with NMM, and the diastereomeric mixtures of cycloadducts were easily separated by column chromatography. The binaphthyl residue conferred crystallinity to all the obtained cycloadducts. Although low diastereofacial selectivity was recorded in DA reactions of dienes **20** and **21**, the preferred face of dienophile approach is the one, which was expected on the basis of previously reported considerations concerning the stereochemical outcome of sulfinyl diene cycloadditions.⁹ The actual work gives new support to our previous statement that the sulfur configuration is not the only controller of the diastereofacial selectivity, but further structural features of diene, dienophile, and non-diene group linked to the sulfoxide sulfur contribute significantly to the process of facial discrimination. Finally, removal of the arylsulfoxide auxiliary from adduct **24** was easily accomplished by Raney nickel desulfurization method.

4. Experimental

4.1. General

All reactions were monitored by TLC on commercially available precoated plates (silica gel 60 F 254) and the products were visualized with iodine or acid vanillin solution. Silica gel 60, 230–400 mesh, was used for column chromatography. Petrol refers to light petroleum, bp 30–40 °C. Melting points were measured on a microscopic apparatus and are uncorrected. Optical rotations were measured in CHCl_3 solutions unless otherwise stated. ^1H and ^{13}C NMR spectra were recorded at 300 and 75 MHz, respectively, in CDCl_3 solutions (unless otherwise stated) with TMS as internal standard. IR spectra were recorded in nujol. Mass spectrum was measured by FAB (*m*-nitrobenzyl alcohol as matrix).

X-ray crystallography. The analysis was carried out with a Goniometer Oxford Diffraction KM4 Xcalibur2 at room temperature. Graphite-monochromated Mo $K\alpha$ radiation (40 mA/–40 KV) and a KM4 CCD/SAPPHIRE detector were used for cell parameter determination and data collection. The integrated intensities, measured using the ω scan mode, were corrected for Lorentz and polarization effects.¹² The substantial redundancy in data allows empirical absorption corrections (SADABS¹³) to be applied using multiple measurements of symmetry-equivalent reflections. Structure was solved by direct methods of

SIR97¹⁴ and refined using the full-matrix least squares on F^2 provided by SHELXL97.¹⁵

Crystallographic data (excluding structure factors) for the structure in this paper have been deposited with the Cambridge Crystallographic Data Center as supplementary publication number CCDC 278055. Copies of the data can be obtained, free of charge, on application to CCDC, 12 Union Road, Cambridge CB2 1EZ, UK [fax: +44 1223 336033 or e-mail: deposit@ccdc.cam.ac.uk].

4.1.1. 3-[(1R,2S,5R)-menthoxy-methoxy]-phenol (10). To a mixture of resorcinol (**9**) (2.42 g, 21.98 mmol) and anhydrous K_2CO_3 (1.82 g, 13.17 mmol) in anhydrous DMF (30 mL) MenCl (0.92 mL, 4.41 mmol) was added under Ar. After being stirred at 50 °C for 46 h, the reaction mixture was allowed to reach spontaneously the room temperature and quenched with saturated NH_4Cl solution (60 mL). The aqueous layer was extracted with CH_2Cl_2 (4 × 60 mL), the organic phases were recollected, washed with H_2O (6 × 250 mL) and dried over Na_2SO_4 . Evaporation of the solvent gave a crude mixture that was purified by column chromatography ($CH_2Cl_2/MeOH$ 50:1) to obtain phenol **10** as an orange solid (1.05 g, 3.77 mmol, 85% from MenCl), mp 62–64 °C; $[\alpha]_D^{24} -154.6$ (c 0.1); 1H NMR δ 7.10 (t, $J=8.1$ Hz, 1H), 6.58 (ddd, $J=8.1, 2.1, 0.9$ Hz, 1H), 6.54 (t, $J=2.1$ Hz, 1H), 6.47 (ddd, $J=8.1, 2.1, 0.9$ Hz, 1H), 6.32 (br s, 1H), 5.30 (d, $J=7.2$ Hz, 1H), 5.22 (d, $J=7.2$ Hz, 1H), 3.49 (dt, $J=10.8, 4.2$ Hz, 1H), 2.1–2.0 (m, 2H), 1.7–1.6 (m, 2H), 1.4–1.3 (m, 1H), 1.3–1.2 (m, 1H), 1.1–0.8 (m, 3H), 0.90 (d, $J=6.6$ Hz, 3H), 0.84 (d, $J=6.9$ Hz, 3H), 0.63 (d, $J=6.9$ Hz, 3H); ^{13}C NMR δ 158.7, 156.9, 129.9, 108.6, 107.9, 103.4, 91.1, 78.1, 48.1, 41.1, 34.3, 31.5, 25.2, 22.9, 22.2, 21.0, 15.5. Anal. Calcd for $C_{17}H_{26}O_3$: C, 73.34; H, 9.41. Found: C, 73.26; H, 9.32.

4.1.2. 2-{2-Hydroxy-4-[(1R,2S,5R)-menthoxy-methoxy]-phenylsulfanyl}-1H-indole-1,3(2H)-dione (11). To a solution of phenol **10** (1.90 g, 6.82 mmol) in anhydrous $CHCl_3$ (70 mL) kept at 0 °C under Ar, a PhtNSCl solution⁶ (1.46 g, 6.82 mmol) in anhydrous $CHCl_3$ (70 mL) was added dropwise. The reaction mixture was stirred at 0 °C for 20 min, then quenched with saturated $NaHCO_3$ solution (100 mL). The organic phase was extracted with CH_2Cl_2 (100 mL), washed with H_2O (2 × 150 mL), and dried over Na_2SO_4 . The solvent was removed at reduced pressure. Column chromatography (CH_2Cl_2) afforded compound **11** as a white solid (1.79 g, 3.93 mmol, 58%), mp 128–130 °C; $[\alpha]_D^{24} -70.5$ (c 0.3); 1H NMR δ 8.33 (s, 1H), 7.9–7.7 (m, 4H), 7.74 (d, $J=8.7$ Hz, 1H), 6.66 (d, $J=2.4$ Hz, 1H), 6.52 (dd, $J=8.7, 2.4$ Hz, 1H), 5.28 (d, $J=7.2$ Hz, 1H), 5.17 (d, $J=7.2$ Hz, 1H), 3.42 (dt, $J=10.8, 4.2$ Hz, 1H), 2.1–2.0 (m, 2H), 1.6 (m, 2H), 1.4–1.3 (m, 1H), 1.2–1.1 (m, 1H), 1.0–0.7 (m, 3H), 0.87 (d, $J=6.6$ Hz, 3H), 0.81 (d, $J=6.9$ Hz, 3H), 0.59 (d, $J=6.9$ Hz, 3H); ^{13}C NMR δ 168.5, 162.9, 160.4, 139.4, 134.7, 131.8, 124.1, 110.8, 108.9, 103.5, 91.3, 78.7, 48.0, 41.1, 34.2, 31.4, 25.1, 22.8, 22.2, 20.9, 15.5. Anal. Calcd for $C_{25}H_{29}NO_5S$: C, 65.91; H, 6.42; N, 3.07. Found: C, 65.68; H, 6.21; N, 3.11.

4.1.3. 3-{2-Hydroxy-4-[(1R,2S,5R)-menthoxy-methoxy]-phenylsulfanyl}-propanenitrile (12). A solution of thio-derivative **11** (1.79 g, 3.93 mmol) in anhydrous THF

(40 mL) was added, at 0 °C under Ar, to a suspension of LAH (0.90 g, 23.72 mmol) in anhydrous THF (25 mL). After 1 h of stirring at room temperature, the mixture was quenched with HCl 1 N (50 mL) and ice. The resulting suspension was extracted with Et_2O (3 × 100 mL) and the organic phase dried over Na_2SO_4 . Evaporation of the solvent under reduced pressure gave the crude 5-[(1R,2S,5R)-menthoxy-methoxy]-2-mercapto-phenol (1.49 g) that was used in the next step without purification; 1H NMR δ 7.35 (d, $J=8.7$ Hz, 1H), 6.67 (d, $J=2.7$ Hz, 1H), 6.54 (dd, $J=8.7, 2.7$ Hz, 1H), 6.39 (s, 1H), 5.29 (d, $J=7.2$ Hz, 1H), 5.19 (d, $J=7.2$ Hz, 1H), 3.46 (dt, $J=10.5, 4.2$ Hz, 1H), 2.82 (s, 1H), 2.1–2.0 (m, 1H), 1.7–1.6 (m, 2H), 1.4–1.2 (m, 2H), 1.0–0.7 (m, 4H), 0.90 (d, $J=6.6$ Hz, 3H), 0.84 (d, $J=7.2$ Hz, 3H), 0.62 (d, $J=7.2$ Hz, 3H). The solution of the crude 5-[(1R,2S,5R)-menthoxy-methoxy]-2-mercapto-phenol (1.49 g, 4.8 mmol about) in anhydrous THF (40 mL), was added under Ar to a solution of acrylonitrile (3.16 mL, 48.00 mmol) and Et_3N (0.64 mL, 4.59 mmol) in anhydrous THF (15 mL). The mixture was stirred at room temperature for 20 h, then quenched with saturated NH_4Cl solution (40 mL) and extracted with Et_2O (2 × 40 mL). The organic phase was washed with H_2O (2 × 100 mL) and dried over Na_2SO_4 . After removal of the solvent under reduced pressure, the crude product was purified by column chromatography (petrol/ $EtOAc$ 3:1) to nitrile **12** as an orange solid (0.95 g, 2.61 mmol, 66% from **11**), mp 64–66 °C; $[\alpha]_D^{25} -95.4$ (c 0.3); 1H NMR δ 7.36 (d, $J=8.7$ Hz, 1H), 6.71 (d, $J=2.7$ Hz, 1H), 6.55 (s, 1H), 6.59 (dd, $J=8.4, 2.7$ Hz, 1H), 5.31 (d, $J=7.2$ Hz, 1H), 5.22 (d, $J=7.2$ Hz, 1H), 3.46 (dt, $J=10.5, 4.2$ Hz, 1H), 2.85 (t, $J=7.2$ Hz, 2H), 2.51 (t, $J=7.2$ Hz, 2H), 2.1–2.0 (m, 2H), 1.7–1.6 (m, 2H), 1.4–1.3 (m, 1H), 1.3–1.2 (m, 1H), 1.0–0.8 (m, 3H), 0.90 (d, $J=6.6$ Hz, 3H), 0.83 (d, $J=7.2$ Hz, 3H), 0.60 (d, $J=6.6$ Hz, 3H); ^{13}C NMR δ 160.9, 158.3, 137.1, 117.8, 109.5, 107.7, 102.9, 91.1, 78.4, 48.1, 41.0, 34.3, 31.8, 31.5, 25.2, 22.9, 22.2, 21.0, 17.9, 15.6; IR ν_{max} 2360 (CN) cm^{-1} . Anal. Calcd for $C_{20}H_{29}NO_3S$: C, 66.08; H, 8.04; N, 3.85. Found: C, 65.86; H, 7.96; N, 3.77.

4.1.4. 3-{2-Hydroxy-4-[(1R,2S,5R)-menthoxy-methoxy]-phenylsulfanyl}-propanenitriles **13 (two S-epimers).** To a solution of sulfide **12** (0.95 g, 2.61 mmol) in anhydrous CH_2Cl_2 (130 mL) at 0 °C *m*-CPBA (0.64 g 70%, 2.60 mmol) was added. The solution was stirred at 0 °C for 20 min, diluted with CH_2Cl_2 (100 mL) and washed with saturated $NaHCO_3$ solution (2 × 150 mL). The organic phase was dried over Na_2SO_4 and concentrated. The crude product was purified by column chromatography (petrol/ $EtOAc$ 1:1), to give an inseparable 1:1 mixture of sulfur epimers **13** as a white solid (0.76 g, 2.00 mmol, 77%), mp 128–131 °C; 1H NMR δ 9.81 (s, 1H), 7.00 (d, $J=8.7$ Hz, 1H), 6.7–6.6 (m, 2H), 5.32 (d, $J=7.5$ Hz, 1H), 5.23 (d, $J=7.5$ Hz, 1H), 3.46 (dt, $J=10.5, 4.2$ Hz, 1H), 3.4–3.2 (m, 2H), 3.0–2.9 (m, 1H), 2.7–2.6 (m, 1H), 2.1–2.0 (m, 2H), 1.7–1.6 (m, 2H), 1.4–1.3 (m, 1H), 1.3–1.2 (m, 1H), 1.0–0.8 (m, 3H), 0.92 (d, $J=6.3$ Hz, 3H), 0.84 (d, $J=6.9$ Hz, 3H), 0.61 (d, $J=6.9$ Hz, 3H); ^{13}C NMR δ 162.2, 160.0, 126.6, 116.8, 112.6, 108.9, 106.1, 91.2, 78.7, 49.0, 48.1, 41.1, 34.3, 31.5, 25.3, 23.0, 22.2, 20.9, 15.6, 10.7. Anal. Calcd for $C_{20}H_{29}NO_4S$: C, 63.30; H, 7.70; N, 3.69. Found: C, 63.01; H, 7.55; N, 3.51.

4.1.5. 1-(1-Cyclohexen-1-yl)-1-{2-hydroxy-4-[(1R,2S,5R)-menthoxy-methoxy]-phenylsulfanyl}-ethene **15 (two S-epimers).** A mixture of sulfoxides **13** (0.20 g, 0.53 mmol) and 1-ethynylcyclohexene (0.50 mL, 4.25 mmol) was heated at 130 °C under Ar. After 1 h of stirring, the mixture was allowed to reach spontaneously the room temperature and then was diluted with CH₂Cl₂ (10 mL). Evaporation of the solvent under reduced pressure gave a crude product that was purified by column chromatography (petrol/EtOAc 7:1). An oily 1:1 mixture of epimers **15** was isolated (0.11 g, 0.25 mmol, 47%). Anal. Calcd for C₂₅H₃₆O₄S: C, 69.41; H, 8.39. Found: C, 69.78; H, 8.15. Further attempts of chromatographic separation of the two epimers allowed the isolation of very small amounts of enantiopure sulfoxides. *More mobile sulfur epimer 15* was obtained as an oil; [α]_D²⁵ –119.0 (c 0.1); ¹H NMR δ 9.92 (s, 1H), 6.96 (dd, *J*=8.4, 0.6 Hz, 1H), 6.6–6.5 (m, 2H), 5.93 (br s, 2H), 5.65 (br s, 1H), 5.28 (d, *J*=7.2 Hz, 1H), 5.20 (d, *J*=7.2 Hz, 1H), 3.44 (dt, *J*=10.5, 4.2 Hz, 1H), 2.2–2.0 (m, 5H), 1.7–1.2 (m, 10H), 1.0–0.8 (m, 2H), 0.89 (d, *J*=6.6 Hz, 3H), 0.82 (d, *J*=7.2 Hz, 3H), 0.58 (d, *J*=7.2 Hz, 3H); ¹³C NMR δ 161.5, 161.4, 152.6, 131.6, 129.9, 128.1, 113.2, 112.9, 107.5, 106.0, 90.9, 78.4, 48.2, 41.1, 34.4, 31.5, 28.6, 25.4, 25.3, 23.1, 22.4, 22.2, 21.6, 21.0, 15.6. *Less mobile sulfur epimer 15* was obtained as an oil; [α]_D²⁵ –58.2 (c 0.02); ¹H NMR δ 9.95 (s, 1H), 6.96 (d, *J*=9.0 Hz, 1H), 6.50 (m, 2H), 5.93 (br s, 2H), 5.65 (br s, 1H), 5.28 (d, *J*=7.5 Hz, 1H), 5.20 (d, *J*=7.2 Hz, 1H), 3.45 (dt, *J*=10.5, 4.2 Hz, 1H), 2.2–2.0 (m, 5H), 1.7–1.2 (m, 10H), 1.0–0.8 (m, 2H), 0.89 (d, *J*=6.6 Hz, 3H), 0.82 (d, *J*=6.9 Hz, 3H), 0.58 (d, *J*=7.2 Hz, 3H); ¹³C NMR δ 161.5, 161.5, 152.6, 131.6, 129.9, 128.1, 113.3, 112.9, 107.2, 106.3, 91.0, 78.4, 48.2, 41.1, 34.4, 31.5, 28.6, 25.4, 25.3, 23.1, 22.4, 22.2, 21.6, 21.0, 15.5.

4.1.6. (S_a)-3-(2'-hydroxy-1,1'-binaphthalen-2-sulfanyl)-propanenitrile (17**).** To a solution of (S_a)-2'-mercapto-1,1'-binaphthalen-2-ol^{7,16} (**16**) (2.00 g, 6.61 mmol) in anhydrous THF (60 mL), acrylonitrile (4.38 mL, 66.53 mmol) and Et₃N (0.92 mL, 6.61 mmol) were added under N₂. The reaction mixture was stirred at room temperature for 72 h. The resulting yellow-orange solution was diluted with CH₂Cl₂ (200 mL) and washed with saturated NH₄Cl solution (3×200 mL) and H₂O (2×200 mL). The organic layer was dried over Na₂SO₄, and the solvent removed under reduced pressure. Column chromatography (eluant: from petrol/CH₂Cl₂ 1:1 to pure CH₂Cl₂) gave nitrile **17** as a white solid (1.77 g, 4.98 mmol, 75%), mp 93–95 °C; [α]_D²⁴ –67.8 (c 1.0, THF); ¹H NMR (CD₃CN) δ 8.05 (d, *J*=8.7 Hz, 1H), 7.97 (d, *J*=8.7 Hz, 1H), 7.94 (d, *J*=9.3 Hz, 1H), 7.89 (d, *J*=8.1 Hz, 1H), 7.73 (d, *J*=8.7 Hz, 1H), 7.47 (dt, *J*=7.4, 1.1 Hz, 1H), 7.29 (m, 3H), 7.21 (dt, *J*=7.7, 1.2 Hz, 1H), 7.04 (d, *J*=8.7 Hz, 1H), 6.83 (d, *J*=8.7 Hz, 1H), 3.12 (t-like, *J*=7.1 Hz, 2H), 2.57 (t-like, *J*=7.1 Hz, 2H); ¹³C NMR [(CD₃)₂CO] δ 153.3, 135.5, 134.8, 134.5, 134.4, 133.4, 130.6, 129.65, 129.59, 128.9, 127.6, 127.5, 127.2, 126.7, 126.5, 124.9, 123.7, 119.1, 118.1, 29.4, 18.6. Anal. Calcd for C₂₃H₁₇NOS: C, 77.72; H, 4.82; N, 3.94. Found: C, 77.35; H, 4.80; N, 4.00. The same chromatography allowed the isolation of small amounts (4%) of bis[(S_a)-2'-hydroxy-1,1'-binaphthyl-2-yl] disulfide; [α]_D²⁷ –87.3 (c 1.0).⁷

4.1.7. (S_a)-3-(2'-hydroxy-1,1'-binaphthalen-2-sulfinyl)-propanenitriles **18 (two S-epimers).** To a solution of sulfide **17** (1.11 g, 3.12 mmol) in CH₂Cl₂ (50 mL), at –50 °C, a solution of *m*-CPBA (0.73 g 70%, 2.96 mmol) in CH₂Cl₂ (80 mL) was added dropwise. After 1 h of stirring, the mixture was diluted with CH₂Cl₂ (50 mL) and treated with 10% Na₂S₂O₃ solution (150 mL). The organic phase was washed with saturated NaHCO₃ solution (2×150 mL) and H₂O (2×150 mL), dried over Na₂SO₄, and evaporated under reduced pressure to give sulfoxides **18** as a 1:1 mixture (1.07 g, 2.88 mmol, 92%) of two S-epimers. The epimers were separated by column chromatography (CH₂Cl₂/EtOAc, 20:1). *More mobile sulfur epimer 18* was obtained as a white solid, mp 78–80 °C; [α]_D²⁶ –193.0 (c 0.3, THF); ¹H NMR δ 8.18 (d, *J*=8.7 Hz, 1H), 8.07 (d, *J*=8.7 Hz, 1H), 7.97 (d, *J*=8.1 Hz, 1H), 7.91 (d, *J*=8.7 Hz, 1H), 7.86 (d, *J*=8.1 Hz, 1H), 7.6–7.5 (m, 1H), 7.4–7.2 (m, 5H), 6.95 (d, *J*=8.4 Hz, 1H), 6.57 (s, 1H), 3.0–2.8 (m, 2H), 2.7–2.6 (m, 1H), 2.5–2.4 (m, 1H); ¹³C NMR δ 152.0, 138.1, 135.1, 133.0, 132.5, 132.2, 131.6, 130.2, 128.8, 128.7, 128.3, 128.2, 127.9, 127.7, 125.8, 124.1, 123.9, 119.7, 117.7, 117.5, 113.4, 47.9, 9.5. Anal. Calcd for C₂₃H₁₇NO₂S: C, 74.37; H, 4.61; N, 3.77. Found: C, 74.58; H, 4.60; N, 3.57. *Then less mobile sulfur epimer 18* was eluted as a white solid, mp 98–100 °C; [α]_D²⁶ +377.4 (c 0.8, THF); ¹H NMR (CD₃CN) δ 8.27 (d, *J*=8.4 Hz, 1H), 8.14 (d, *J*=8.7 Hz, 1H), 8.04 (d, *J*=8.1 Hz, 1H), 7.98 (d, *J*=9.0 Hz, 1H), 7.92 (d, *J*=7.8 Hz, 1H), 7.7–7.6 (m, 1H), 7.4–7.2 (m, 5H), 6.79 (d, *J*=8.4 Hz, 1H), 5.93 (br s, 1H), 2.6–2.5 (m, 2H), 2.5–2.3 (m, 2H); ¹³C NMR [(CD₃)₂SO] δ 152.6, 139.3, 134.5, 133.7, 132.7, 132.0, 130.9, 129.3, 128.6 (2C), 127.8, 127.7, 127.4, 127.2, 125.7, 123.3, 123.0, 120.0, 118.5, 118.3, 112.5, 47.0, 8.8. Anal. Calcd for C₂₃H₁₇NO₂S: C, 74.37; H, 4.61; N, 3.77. Found: C, 74.27; H, 4.72; N, 3.80.[†]

4.1.8. (S_a)-2-(2'-hydroxy-1,1'-binaphthalen-2-sulfinyl)-3-methyl-1,3-butadienes **20 and **21** (two S-epimers).** To a suspension of sulfoxides **18** (0.18 g, 0.48 mmol) in toluene (12 mL) 2-methyl-1-buten-3-yne (0.70 mL, 7.36 mmol) was added and the reaction mixture refluxed and stirred for 1.5 h. The resulting yellow solution was cooled to room temperature and the 1:1 mixture of dienes **20** and **21** was obtained as a white precipitate (0.14 g, 0.36 mmol, 75% total yield). The epimers were separated by column chromatography (initial elution with CH₂Cl₂, then CH₂Cl₂/EtOAc 9:1). First eluted was (S_a,S_s)-2-(2'-hydroxy-1,1'-binaphthalen-2-sulfinyl)-3-methyl-1,3-butadiene (**20**) as a white solid, mp 173 °C dec; [α]_D²⁴ –206.7 (c 1.0, THF); ¹H NMR δ 8.14 (d, *J*=9.0 Hz, 1H), 7.98 (d, *J*=7.2 Hz, 1H), 7.96 (d, *J*=8.1 Hz, 1H), 7.87 (d, *J*=8.1 Hz, 1H), 7.60 (m, 1H), 7.4–7.2 (m, 6H), 7.11 (d, *J*=8.1 Hz, 1H), 5.92 (s, 1H), 5.68 (s, 1H), 4.88 (s, 1H), 4.81 (s, 1H), 1.65 (s, 3H); ¹³C NMR [D₂O] δ 154.8, 154.4, 141.6, 137.5, 137.3, 135.5, 135.0, 133.2, 131.2, 130.3, 129.0, 128.9,

[†] When sulfide **17** was oxidized with an equimolar amount of *m*-CPBA at –15 °C, the 1:1 mixture of epimeric sulfoxides **18** was obtained in 73% total yield, together with (S_a)-3-(2'-hydroxy-1,1'-binaphthalen-2-sulfonyl)-propanenitrile (14%), mp 204–206 °C, more mobile than sulfoxides **18** (column chromatography with CH₂Cl₂/EtOAc 19:1); ¹H NMR δ 8.34 (d, *J*=8.8 Hz, 1H), 8.22 (d, *J*=8.8 Hz, 1H), 8.04 (d, *J*=8.3 Hz, 1H), 8.03 (d, *J*=9.0 Hz, 1H), 7.93 (split d, *J*=7.8 Hz, 1H), 7.68 (ddd, *J*=8.3, 6.9, 1.3 Hz, 1H), 7.4–7.3 (m, 4H), 7.22 (split d, *J*=8.5 Hz, 1H), 6.74 (split d, *J*=8.4 Hz, 1H), 3.0–2.5 (m, 4H).

128.7, 128.6, 127.8, 127.4, 127.3, 124.9, 123.6, 121.7, 118.8, 117.0 (2C), 115.5, 22.1; IR ν_{\max} 3280 (OH), 1007 (SO) cm^{-1} . Anal. Calcd for $\text{C}_{25}\text{H}_{20}\text{O}_2\text{S}$: C, 78.09; H, 5.24. Found: C, 77.88; H, 5.25. Then (S_a, R_S)-2-(2'-hydroxy-1,1'-binaphthalen-2-sulfinyl)-3-methyl-1,3-butadiene (**21**) was eluted as a white solid, mp 124–126 °C; $[\alpha]_D^{25} + 378.4$ (c 1.0, THF); $^1\text{H NMR}$ δ 8.04 (d, $J=8.7$ Hz, 1H), 7.91 (d, $J=8.4$ Hz, 1H), 7.82 (m, 2H), 7.53 (t, $J=7.0$ Hz, 1H), 7.47 (d, $J=9.0$ Hz, 1H), 7.4–7.1 (m, 5H), 6.76 (d, $J=8.4$ Hz, 1H), 6.23 (s, 1H), 5.87 (s, 1H), 4.34 (s, 1H), 4.26 (s, 1H), 1.59 (s, 3H); $^{13}\text{C NMR}$ $[\text{D}(\text{CON}(\text{CD}_3)_2)] \delta$ 155.7, 154.0, 142.2, 137.4, 136.1, 135.4, 135.1, 133.2, 131.2, 130.0, 129.1, 128.9, 128.8, 128.4, 127.7, 127.4, 126.8, 125.7, 123.4, 121.7, 119.1, 116.5, 116.4, 115.4, 22.0; IR ν_{\max} 3250 (OH), 1015 (SO) cm^{-1} . Anal. Calcd for $\text{C}_{25}\text{H}_{20}\text{O}_2\text{S}$: C, 78.09; H, 5.24. Found: C, 78.20; H, 5.12.

4.1.9. (S_a, S_S)-3a,4,7,7a-tetrahydro-5-(2'-hydroxy-1,1'-binaphthalen-2-sulfinyl)-2,6-dimethyl-1H-isoindole-1,3(2H)-diones **22 and **23** (two diastereomers).** To a suspension of (S_a, S_S)-2-(2'-hydroxy-1,1'-binaphthalen-2-sulfinyl)-3-methyl-1,3-butadiene (**20**) (0.21 g, 0.55 mmol) in CH_2Cl_2 (40 mL) NMM (1.19 g, 10.71 mmol) was added, and the mixture was refluxed and stirred for 72 h. After removal of the solvent, the crude product was purified by column chromatography (eluant: from $\text{CH}_2\text{Cl}_2/\text{EtOAc}$ 1.5:1 to pure EtOAc) to give the two diastereomeric cycloadducts **22** and **23**, in 2:1 ratio (0.24 g, 0.48 mmol, 87% overall yield). First eluted was the major adduct (3a*S*,7a*R*, S_a, S_S)-3a,4,7,7a-tetrahydro-5-(2'-hydroxy-1,1'-binaphthalen-2-sulfinyl)-2,6-dimethyl-1H-isoindole-1,3(2H)-dione (**22**), white solid, mp 183 °C dec; $[\alpha]_D^{25} - 226.5$ (c 0.8); $^1\text{H NMR}$ δ 8.3–8.1 (m, 2H), 7.9–7.7 (m, 3H), 7.5–7.4 (m, 1H), 7.3–7.1 (m, 5H), 6.99 (d, $J=8.4$ Hz, 1H), 2.8–2.5 (m, 4H), 2.71 (s, 3H), 2.3–2.2 (m, 2H), 1.02 (s, 3H). Anal. Calcd for $\text{C}_{30}\text{H}_{25}\text{NO}_4\text{S}$: C, 72.71; H, 5.08; N, 2.83. Found: C, 73.06; H, 5.10; N, 2.87. Less mobile was the minor adduct (3a*R*,7a*S*, S_a, S_S)-3a,4,7,7a-tetrahydro-5-(2'-hydroxy-1,1'-binaphthalen-2-sulfinyl)-2,6-dimethyl-1H-isoindole-1,3(2H)-dione (**23**), white solid, mp 164–166 °C; $[\alpha]_D^{25} - 151.8$ (c 0.6); $^1\text{H NMR}$ $[(\text{CD}_3)_2\text{SO}] \delta$ 9.53 (s, 1H), 8.31 (d, $J=8.8$ Hz, 1H), 8.16 (d, $J=8.8$ Hz, 1H), 8.09 (d, $J=8.4$ Hz, 1H), 7.93 (d, $J=8.8$ Hz, 1H), 7.88 (d, $J=8.1$ Hz, 1H), 7.58 (t, $J=7.0$ Hz, 1H), 7.36 (t, $J=8.2$ Hz, 1H), 7.3–7.2 (m, 3H), 7.10 (d, $J=8.7$ Hz, 1H), 6.87 (d, $J=8.1$ Hz, 1H), 3.0–2.9 (m, 1H), 2.8–2.6 (m, 2H), 2.66 (s, 3H), 2.35 (dd, $J=15.3, 7.8$ Hz, 1H), 2.04 (dd, $J=15.0, 10.4$ Hz, 1H), 1.63 (t-like, $J=12.3$ Hz, 1H), 1.05 (s, 3H); MS m/z (%) 496 (29, M+1), 268 (15), 239 (8), 95 (49), 81 (51), 69 (82), 55 (100), 43 (76); IR ν_{\max} 3200 (OH), 1770 and 1701 (CO), 1005 (SO) cm^{-1} . Anal. Calcd for $\text{C}_{30}\text{H}_{25}\text{NO}_4\text{S}$: C, 72.71; H, 5.08; N, 2.83. Found: C, 73.00; H, 5.18; N, 2.90.

4.1.10. (S_a, R_S)-3a,4,7,7a-tetrahydro-5-(2'-hydroxy-1,1'-binaphthalen-2-sulfinyl)-2,6-dimethyl-1H-isoindole-1,3(2H)-diones **24 and **25** (two diastereomers).** To a solution of (S_a, R_S)-2-(2'-hydroxy-1,1'-binaphthalen-2-sulfinyl)-3-methyl-1,3-butadiene (**21**) (0.20 g, 0.52 mmol) in CH_2Cl_2 (25 mL) NMM (1.18 g, 10.62 mmol) was added and the mixture refluxed for 72 h. After removal of the solvent, the crude product was purified by column chromatography (eluant: from $\text{CH}_2\text{Cl}_2/\text{EtOAc}$ 2.3:1 to pure EtOAc) to give the two diastereomeric cycloadducts **24** and **25** in 3:2 ratio

(0.18 g, 0.36 mmol, 69% overall yield). First eluted was the major adduct (3a*R*,7a*S*, S_a, R_S)-3a,4,7,7a-tetrahydro-5-(2'-hydroxy-1,1'-binaphthalen-2-sulfinyl)-2,6-dimethyl-1H-isoindole-1,3(2H)-dione (**24**), white solid, mp 175–177 °C; $[\alpha]_D^{27} + 179.7$ (c 0.5); $^1\text{H NMR}$ $[(\text{CD}_3)_2\text{SO}] \delta$ 10.00 (s, 1H), 8.32 (d, $J=8.7$ Hz, 1H), 8.10 (d, $J=8.7$ Hz, 2H), 7.94 (d, $J=9.0$ Hz, 1H), 7.88 (d, $J=8.1$ Hz, 1H), 7.58 (t, $J=7.4$ Hz, 1H), 7.39 (d, $J=9.0$ Hz, 1H), 7.33 (t, $J=7.6$ Hz, 1H), 7.27 (t, $J=7.2$ Hz, 1H), 7.15 (t, $J=7.2$ Hz, 1H), 6.96 (d, $J=8.4$ Hz, 1H), 6.41 (d, $J=8.4$ Hz, 1H), 2.9–2.7 (m, 2H), 2.67 (s, 3H), 1.8–1.7 (m, 2H), 1.3–1.2 (m, 2H), 0.51 (s, 3H); $^{13}\text{C NMR}$ $[(\text{CD}_3)_2\text{SO}] \delta$ 178.9, 178.4, 152.6, 144.2, 139.4, 134.2, 133.8, 133.2, 132.2, 132.1, 130.4, 128.5, 128.1, 128.0, 127.3, 127.1, 126.5, 125.4, 123.5, 122.8, 120.4, 118.7, 113.3, 38.7, 38.5, 30.7, 30.0, 24.5, 19.9, 18.1; IR ν_{\max} 3100 (OH), 1780 and 1698 (CO), 985 (SO) cm^{-1} . Anal. Calcd for $\text{C}_{30}\text{H}_{25}\text{NO}_4\text{S}$: C, 72.71; H, 5.08; N, 2.83. Found: C, 72.92; H, 5.05; N, 2.83. Less mobile was the minor adduct (3a*S*,7a*R*, S_a, R_S)-3a,4,7,7a-tetrahydro-5-(2'-hydroxy-1,1'-binaphthalen-2-sulfinyl)-2,6-dimethyl-1H-isoindole-1,3(2H)-dione (**25**), white solid, mp 154–156 °C; $[\alpha]_D^{27} + 168.0$ (c 0.5); $^1\text{H NMR}$ $[(\text{CD}_3)_2\text{SO}] \delta$ 9.99 (br s, 1H), 8.30 (d, $J=8.4$ Hz, 1H), 8.15 (d, $J=8.7$ Hz, 1H), 8.09 (d, $J=8.1$ Hz, 1H), 7.94 (d, $J=9.0$ Hz, 1H), 7.86 (d, $J=8.1$ Hz, 1H), 7.57 (t, $J=7.4$ Hz, 1H), 7.38 (d, $J=9.0$ Hz, 1H), 7.32 (t, $J=7.7$ Hz, 1H), 7.23 (t, $J=7.4$ Hz, 1H), 7.00 (t, $J=7.5$ Hz, 1H), 6.95 (d, $J=8.4$ Hz, 1H), 6.32 (d, $J=8.1$ Hz, 1H), 2.68 (s, 3H), 1.81 (dd, $J=15.4, 7.9$ Hz, 2H), 1.5–1.4 (m, 2H), 1.01 (dd, $J=15.2, 8.6$ Hz, 2H), 0.55 (s, 3H); $^{13}\text{C NMR}$ $[(\text{CD}_3)_2\text{SO}] \delta$ 178.6, 178.5, 152.5, 144.5, 139.6, 134.2, 133.8, 133.0, 132.1, 130.4, 128.6, 128.4, 128.1, 128.0, 127.2, 127.0, 126.5, 125.5, 123.4, 122.7, 120.3, 118.6, 113.5, 37.8, 30.0, 24.2, 19.4, 17.6. Anal. Calcd for $\text{C}_{30}\text{H}_{25}\text{NO}_4\text{S}$: C, 72.71; H, 5.08; N, 2.83. Found: C, 72.51; H, 5.10; N, 3.22.

X-ray structural analysis of **25**, CCDC no. 278055: formula $\text{C}_{34}\text{H}_{33}\text{NO}_6\text{S}$ ($\text{C}_{30}\text{H}_{25}\text{NO}_4\text{S} + \text{C}_4\text{H}_8\text{O}_2$), $M = 583.67$, orthorhombic, space group $P 2_1 2_1 2_1$, $a = 10.517(2)$ Å, $b = 12.410(2)$ Å, $c = 22.803(7)$ Å, $V = 2976(1)$ Å³, $Z = 4$, $D_c = 1.303$, $\mu = 0.156$ mm^{-1} , $F(000) = 1232$. Reflections (4700) were collected with a $2.63 < \theta < 21.36$ range with a completeness to θ 95.3%; 3107 were independent, the parameters were 385, and the final R index was 0.0839 for reflections having $I > 2\sigma(I)$, and 0.1559 for all data. Compound **25** crystallizes with a molecule of EtOAc in the asymmetric unit. The positions of EtOAc carbon and oxygen atoms in are not well defined so that their coordinates have been splitted, they were refined as isotropic, and the relative hydrogen atoms were not assigned. The non-hydrogen atoms of compound **25** were refined anisotropically whereas its hydrogen atoms were refined as isotropic and assigned in calculated positions.

4.2. Desulfurization of (3a*R*,7a*S*, S_a, R_S)-3a,4,7,7a-tetrahydro-5-(2'-hydroxy-1,1'-binaphthalen-2-sulfinyl)-2,6-dimethyl-1H-isoindole-1,3(2H)-dione (**24**)

To a solution of cycloadduct **24** (0.10 g, 0.20 mmol) in anhydrous THF (20 mL) a suspension of commercial W-2 Raney nickel (nickel sponge, suspension in water, 1.80 mL) in anhydrous THF (10 mL) was added. The reaction mixture was stirred at room temperature for 5 h and then filtered

through a Celite pad. The Celite cake was washed with EtOAc and the resulting clear solution was concentrated under reduced pressure. The crude mixture was purified by two consecutive column chromatographies (petrol/EtOAc 2.3:1) to give, in order of increasing retention times (2:1 molar ratio, 55% overall yield), (3a*S*,7a*R*)-hexahydro-2,5-dimethyl-1*H*-isoindole-1,3(2*H*)-diones **27** (6:1 epimeric mixture, 6.7 mg, 0.04 mmol), followed by (3a*S*,7a*R*)-3a,4,7,7a-tetrahydro-2,5-dimethyl-1*H*-isoindole-1,3(2*H*)-dione (**26**) (13.3 mg, 0.07 mmol). The analytical and spectroscopic data, measured for **26** and **27**, were fully consistent with the ones reported in the literature.¹¹

Acknowledgements

Work carried out in the framework of the National Project ‘Stereoselezione in Sintesi Organica. Metodologie ed Applicazioni’, supported by MIUR (Ministero Istruzione Università e Ricerca) and Universities of Firenze and Messina.

References and notes

- Reviews on the topic: Aversa, M. C.; Barattucci, A.; Bonaccorsi, P.; Giannetto, P. *Tetrahedron: Asymmetry* **1997**, *8*, 1339–1367. *Recent Res. Dev. Org. Chem.* **2002**, *6*, 87–101. *Arkivoc* **2002**, 79–98.
- (a) Aversa, M. C.; Bonaccorsi, P.; Giannetto, P.; Jafari, S. M. A.; Jones, D. N. *Tetrahedron: Asymmetry* **1992**, *3*, 701–704. (b) Aversa, M. C.; Bonaccorsi, P.; Giannetto, P.; Jones, D. N. *Tetrahedron: Asymmetry* **1994**, *5*, 805–808. (c) Aversa, M. C.; Barattucci, A.; Bonaccorsi, P.; Giannetto, P.; Jones, D. N. *J. Org. Chem.* **1997**, *62*, 4376–4384. (d) Aversa, M. C.; Barattucci, A.; Bonaccorsi, P.; Giannetto, P.; Nicolò, F. *J. Org. Chem.* **1999**, *64*, 2114–2118. (e) Aversa, M. C.; Barattucci, A.; Bonaccorsi, P.; Giannetto, P.; Nicolò, F.; Rizzo, S. *Tetrahedron: Asymmetry* **1999**, *10*, 3907–3917. (f) Aversa, M. C.; Barattucci, A.; Bonaccorsi, P.; Giannetto, P.; Policicchio, M. *J. Org. Chem.* **2001**, *66*, 4845–4851. (g) Aversa, M. C.; Barattucci, A.; Bonaccorsi, P.; Bruno, G.; Caruso, F.; Giannetto, P. *Tetrahedron: Asymmetry* **2001**, *12*, 2901–2908. (h) Aversa, M. C.; Barattucci, A.; Bilardo, M. C.; Bonaccorsi, P.; Giannetto, P. *Synthesis* **2003**, 2241–2248.
- Aversa, M. C.; Barattucci, A.; Bonaccorsi, P.; Bruno, G.; Giannetto, P.; Nicolò, F. *J. Chem. Soc., Perkin Trans. 2* **1997**, 273–277.
- (a) Aucagne, V.; Aversa, M. C.; Barattucci, A.; Bonaccorsi, P.; Giannetto, P.; Rollin, P.; Tatibouët, A. *J. Org. Chem.* **2002**, *67*, 6925–6930. (b) Aversa, M. C.; Barattucci, A.; Bonaccorsi, P.; Giannetto, P. *J. Org. Chem.* **2005**, *70*, 1986–1992. (c) Aversa, M. C.; Barattucci, A.; Biliardo, M. C.; Bonaccorsi, P.; Giannetto, P.; Rollin, P.; Tatibouët, A. *J. Org. Chem.* **2005**, *70*, 7389–7396.
- (a) Aversa, M. C.; Barattucci, A.; Bonaccorsi, P.; Bruno, G.; Giannetto, P.; Policicchio, M. *Tetrahedron Lett.* **2000**, *41*, 4441–4445. (b) Aversa, M. C.; Barattucci, A.; Bonaccorsi, P.; Giannetto, P. *Tetrahedron* **2002**, *58*, 10145–10150.
- (a) Capozzi, G.; Falciani, C.; Menichetti, S.; Nativi, C. *J. Org. Chem.* **1997**, *62*, 2611–2615. (b) Capozzi, G.; Delogu, G.; Fabbri, D.; Marini, M.; Menichetti, S.; Nativi, C. *J. Org. Chem.* **2002**, *67*, 2019–2026.
- Azad, S. M.; Bennett, S. M. W.; Brown, S. M.; Green, J.; Sinn, E.; Topping, C. M.; Woodward, S. *J. Chem. Soc., Perkin Trans. 1* **1997**, 687–694.
- Adams, H.; Anderson, J. C.; Bell, R.; Jones, D. N.; Peel, M. R.; Tomkinson, N. C. O. *J. Chem. Soc., Perkin Trans. 1* **1998**, 3967–3974.
- Aversa, M. C.; Barattucci, A.; Bonaccorsi, P.; Faggi, C.; Gacs-Baitz, E.; Marrocchi, A.; Minuti, L.; Taticchi, A. *Tetrahedron* **2005**, *61*, 7719–7726.
- Aversa, M. C.; Barattucci, A.; Bonaccorsi, P.; Bonini, B. F.; Giannetto, P.; Nicolò, F. *Tetrahedron: Asymmetry* **1999**, *10*, 3919–3929.
- Vijn, R. J.; Hiemstra, H.; Kok, J. J.; Knotter, M.; Speckamp, W. N. *Tetrahedron* **1987**, *43*, 5019–5030.
- Walker, N.; Stuart, D. *Acta Crystallogr. Sect. A: Found. Crystallogr.* **1983**, *39*, 158–166.
- Sheldrick, G. M. *SADABS: Program for Empirical Absorption Correction*, version 2.03; Universität Göttingen: Göttingen, Germany, 1997–2001.
- Altomare, A.; Burla, M. C.; Camalli, M.; Cascarano, G. L.; Giacovazzo, C.; Guagliardi, A.; Moliterni, A. G. G.; Polidori, G.; Spagna, R. *J. Appl. Crystallogr.* **1999**, *32*, 115–119.
- Sheldrick, G. M. *SHELXL97: Program for Crystal Structure Refinement*; Institut für Anorganische Chemie der Universität Göttingen: Göttingen, Germany, 1987.
- (a) Bandarage, U. K.; Simpson, J.; Smith, R. A. J.; Weavers, R. T. *Tetrahedron* **1994**, *50*, 3463–3472. (b) Fabbri, D.; Delogu, G.; De Lucchi, O. *J. Org. Chem.* **1995**, *60*, 6599–6601. (c) Green, J.; Woodward, S. *Synlett* **1995**, 155–156. (d) Fabbri, D.; Pulacchini, S.; Gladiali, S. *Synlett* **1996**, 1054–1056. (e) Bennet, S. M. W.; Brown, S. M.; Conole, G.; Dennis, M. R.; Fraser, P. K.; Radojevic, S.; McPartlin, M.; Topping, C. M.; Woodward, S. *J. Chem. Soc., Perkin Trans. 1* **1999**, 3127–3132.

Palladium mediated spiroketal synthesis: application to pheromone synthesis

Jeremy C. Conway,^a Peter Quayle,^{a,*} Andrew C. Regan^a and Christopher J. Urch^{b,†}

^aSchool of Chemistry, University of Manchester, Manchester M13 9PL, UK

^bSyngenta, Jealott's Hill International Research Station, Bracknell, Berkshire RG42 6EY, UK

Received 7 July 2005; revised 1 September 2005; accepted 15 September 2005

Available online 6 October 2005

Dedicated to Professor S. V. Ley on the occasion of his 60th birthday

Abstract—Stereospecific Stille coupling reactions of 2-metallo-dihydropyrans with *Z*-vinyl iodo alcohols and subsequent cyclisation provides rapid access to 1,7-dioxaspiro[5.5]undecane family of spiroketals.

© 2005 Elsevier Ltd. All rights reserved.

1. Introduction

We¹ and others² have previously reported on the Stille coupling of tri-butylstannyldihydrofuran and -pyran derivatives. This methodology provides rapid access to a variety of C-glycosides,² heterosubstituted dienes¹ and has been employed in the synthesis of benzofused spiroketal-containing systems.³ Herein we report an extension of this chemistry leading to the rapid synthesis of simple spirocyclic systems which are ubiquitous as pheromones^{4a} and is a structural motif present in an ever expanding number of biologically active molecules.^{4b} Our basic strategy centred upon the use of Stork's Wittig methodology⁵ for the synthesis of *Z*-vinyl iodides **1** followed by a Stille coupling⁶ (retention of alkene geometry) with an appropriately metallated enol ether **2** to afford a diene **3** which would undergo cyclisation to afford the desired spiroketal **4**, Scheme 1.

2. Results and discussion

Oxidation of the readily available mono-protected diol **5**^{7a} using Swern's procedure afforded the aldehyde **6**^{7b} in excellent yield (92%). Olefination⁵ (Ph₃P=CHI, 1.2 equiv; THF; −78 °C) generated **7** which on deprotection (CSA, cat.; MeOH; 25 °C; 78%) led to the isolation of the vinyl iodide **8**_{*Z,E*}, as a mixture of geometrical isomers⁸ (*Z*:*E*=6.4:1). With the key intermediate **8**_{*Z,E*} in hand, its palladium-mediated coupling with dihydropyran-derived organometallics was next investigated. Reaction of the iodide **8**_{*Z,E*} (1.1 equiv) with the stannane **9** (1 equiv) in the presence of Pd(OAc)₂ (5 mol%) and tri-*o*-tolyl phosphine (10 mol%) dissolved in acetonitrile containing triethylamine (Et₃N/CH₃CN; 2.5% v/v) at 80 °C for 1.5 h afforded the labile diene alcohols **10**_{*Z,E*} in moderate yield (33%). As anticipated the coupling reaction proceeds with retention of olefin geometry, generating the dienes **10**_{*Z,E*} as a 6:1 mixture of geometrical isomers.

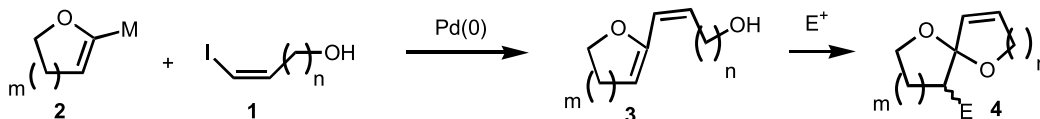

Scheme 1.

Keywords: Spiroketal; Palladium; Stille; Vinyl iodide; Stork; Selenium.

* Corresponding author. Tel.: +44 161 275 4619; fax: +44 161 275 4598; e-mail: peter.quayle@manchester.ac.uk

† Present address: Glycoform Limited, Unit 44C, Milton Park, Abingdon, Oxon OX14 4RU, UK.

Substantially higher yields (71 and 72%, respectively) of the dienes **10** were obtained under milder reaction conditions (0–10 °C; THF; 1 h) from the coupling reaction of the zinc reagent **9** with the iodide **8**_{Z,E} using either 'Pd(PPh₃)₂'¹⁰ or Pd(PPh₃)₄ as catalyst. Exposure of the diene-alcohol **10**_{Z,E} to a catalytic quantity of CSA in CH₂Cl₂ at ambient temperature resulted in the isolation of the unsaturated spiroketal **12**¹¹ in 82% yield. A common feature of these spiroketalisation reactions is that, although enriched *Z/E*-mixtures of the precursor alcohols were usually employed in the cyclisation reaction, none of the acyclic *E*-double bond isomers could be detected by ¹H NMR spectroscopy at the end of reaction.¹² Presumably acid catalysed isomerisation of the unreactive *E*-isomer to the *Z*-isomer and subsequent cyclisation is responsible for this observation. Catalytic hydrogenation (H₂, 1 atm; 5% Pd/C; EtOAc; 25 °C) of **12** afforded the racemic spiroketal **13**, the pheromone¹³ of *Dacus oleae*, *D. cacumintus*, in 93% yield. Alternatively, cyclisation^{3b,14} of the alcohol **10**_{Z,E} with PhSeCl (1.1 equiv; pyridine, 3 equiv; CH₂Cl₂; –78–20 °C) afforded the diastereoisomerically pure selenide **14** (H₁₁ δ 3.21 ppm; dd, *J*=12.5, 4.5 Hz) in good isolated yield (73%). Finally oxidation of **14** followed by in situ thermolysis^{3b} (2-benzenesulfonyl-3-phenyloxaziridine, 'Davis oxaziridine',¹⁵ 1.1 equiv; pyridine; CHCl₃; 80 °C) afforded the doubly unsaturated spiroketal **15**¹⁶ in 62% yield, Scheme 2.

This basic synthetic strategy was next applied to the protected dihydropyran **16**. Lithiation of **16** using Boeckman's conditions¹⁷ (*t*BuLi, 2.2 equiv; THF; –78 to 0 °C), transmetalation (ZnCl₂, 1.1 equiv; THF; 2 h) to the organozinc **18** and coupling with the vinyl iodides **8**_{Z,E} ['Pd(PPh₃)₂', 5 mol%; THF; 5–20 °C, 1 h] afforded the diene-alcohols **19**_{Z,E} in 72% isolated yield. Again, the coupling reaction proceeded with retention of configuration of double bond geometry as **19**_{Z,E} was isolated as a 8:1

mixture of diastereoisomers. Exposure of the alcohols **19**_{Z,E} to camphorsulfonic acid (0.1 equiv) in CH₂Cl₂ at ambient temperature brought about immediate cyclisation to the spiroketal **20**, which was isolated in 58% yield after chromatography. Catalytic hydrogenation of **20** afforded the spiroketal **21**, which upon fluoride-induced deprotection afforded the functionalised spiroketal **22**¹⁸ in 82% overall yield. Stereochemical assignments in this cyclisation sequence are based on stereoelectronic arguments (vide infra) and are supported by spectroscopic data, most cogently illustrated by the excellent correlation of the ¹³C NMR of **22** with the published data for this compound.^{18b} Alternatively, reaction of the dienes **19**_{Z,E} with PhSeCl-pyridine, as above, afforded a diastereoisomeric mixture of the selenides **23** and **24** (57% yield; **23**:**24**=2:1), in which the major diastereoisomer **23** possesses an equatorial phenylseleno-substituent at C₅ (H₅: δ 3.24 ppm; dd, *J*=12.5, 4.5 Hz). Removal of the phenylseleno-group was readily accomplished in our standard, two step procedure, affording the unsaturated spiroketal **25**, as a single diastereoisomer, in 73% yield, Scheme 3.

The preparation of branched-chain vinyl iodides and their utilisation in this coupling-cyclisation procedure is also possible, Scheme 4. Reduction of the protected ester **26** to the aldehyde **27**¹⁹ (Dibal-H, 1.6 equiv; toluene; –78 °C; 1 h; 88%) followed by Stork olefination afforded the vinyl iodides²⁰ **29**_{Z,E} in 73% overall yield (*Z*:*E*=8.2:1). In our hands the alternate route to aldehyde **27**, via alcohol **28**, was not as amenable to scale-up when compared to the direct reduction of ester **26**, with the caveat that due care was exercised in quenching the Dibal-H reduction (10% aqueous citric acid). Deprotection of the ethers **29**_{Z,E} to the partially separable alcohols²¹ **30**_{Z,E} proceeded smoothly (CSA, 0.1 equiv; MeOH; 25 °C, 85%), albeit with a slight erosion of stereochemical integrity about the olefinic centre (*Z*:*E*=6.4:1). Palladium-mediated cross coupling of the

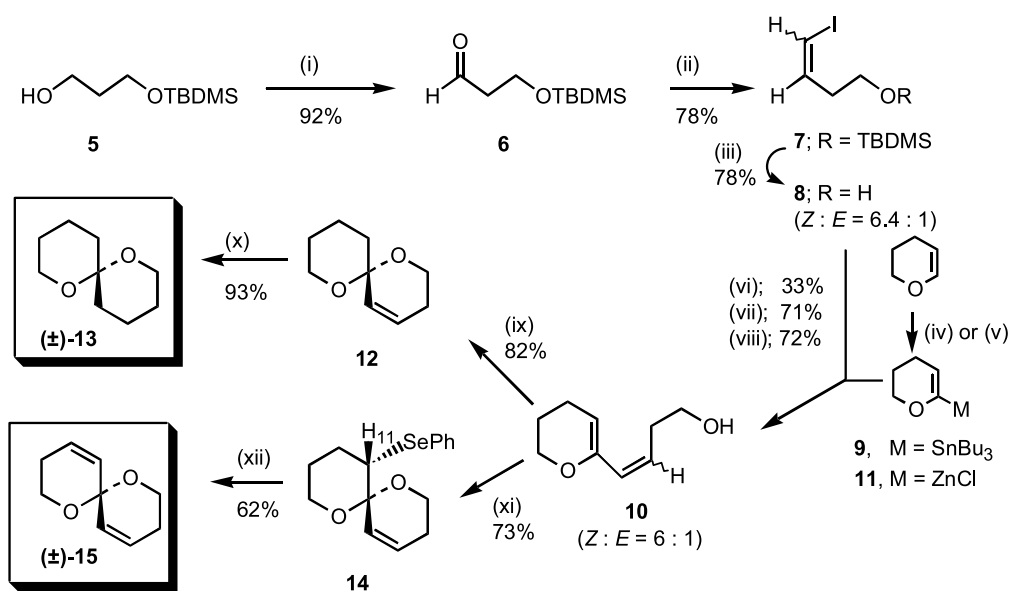

Scheme 2. Reagents and conditions: (i) (COCl)₂ (1.1 equiv), DMSO (2.2 equiv), CH₂Cl₂, –78 °C; (ii) Ph₃P=CHI (1.2 equiv), THF, –78 °C; (iii) CSA (0.1 equiv), MeOH, 20 °C, 15 h; (iv) a. *t*BuLi (1 equiv), THF, –78 °C to 0 °C, b. Bu₃SnCl (0.75 equiv), –78 °C; (v) a. *t*BuLi (1 equiv), THF, –78 to 0 °C, b. ZnCl₂ (1.2 equiv), 0–20 °C, 2 h; (vi) **9** (1 equiv), (*o*-Tol)₃P (10 mol%), Pd(OAc)₂ (5 mol%), Et₃N, CH₃CN, 80 °C, 1.5 h; (vii) **11** (2 equiv), (Ph₃P)₂Pd (5 mol%), THF, 0 °C, 1 h; (viii) **11** (2 equiv), Pd(PPh₃)₄ (5 mol%), THF, 0 °C, 1 h; (ix) CSA (0.1 equiv), CH₂Cl₂, 20 °C; (x) 5% Pd/C, H₂, EtOAc, 1 atm., 6 h; (xi) pyridine (3 equiv), PhSeCl (1.1 equiv), CH₂Cl₂, –78 to 20 °C, 1 h; (xii) Davis oxaziridine (1.1 equiv), pyridine (5 equiv), CHCl₃, 80 °C, 15 h.

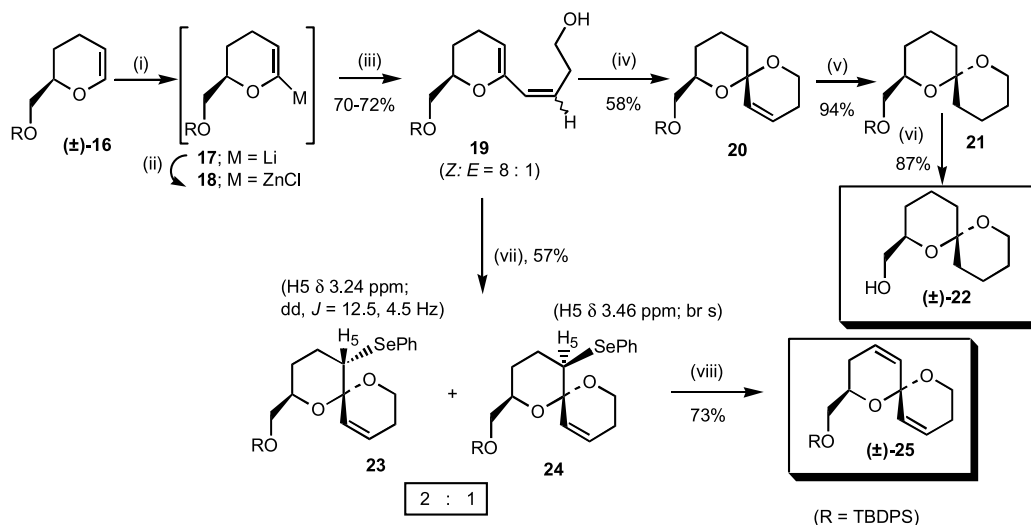

Scheme 3. Reagents and conditions: (i) a. ^tBuLi (2.2 equiv), THF, $-78-0^{\circ}\text{C}$; b. THF (excess); (ii) ZnCl₂ (1.1 equiv); THF, 0°C , 2 h; (iii) **8**, Pd(PPh₃)₄ (5 mol%) or 'Pd(PPh₃)₂' (5 mol%); see text for conditions; (iv) CSA (0.1 equiv), CH₂Cl₂; (v) 5% Pd/C, H₂, EtOAc, 1 atm.; (vi) TBAF (1 equiv), THF, 20°C , 12 h; (vii) pyridine (3 equiv), PhSeCl (1.1 equiv), CH₂Cl₂, $-78-20^{\circ}\text{C}$, 1 h; (viii) Davis oxaziridine (1.1 equiv), pyridine (5 equiv), CHCl₃, 80°C , 15 h.

geometrically pure *Z*-isomer **30_Z** with the zinc reagent **11** proved uneventful, affording the diene-alcohol **31_Z** in 76% yield. Acid promoted cyclisation of the alcohol **31_Z** generated the spiroketal **32²²** as a single diastereoisomer (66% yield), which on catalytic hydrogenation afforded the racemic pheromone of *epeolus cruciger* **33²³** in 74% yield. Cyclisation of the alcohol **31_Z** using PhSeCl-pyridine again afforded only two of the possible four diastereoisomeric selenides **34** and **35** (anomeric carbons in ¹³C NMR {75 MHz CDCl₃} at δ 95.02, 95.39 ppm) in a ratio of 7:1. Inspection of the ¹H NMR spectra of these compounds

indicated that the major product **35** possessed an equatorially disposed selenide group (H₁₁: δ 3.16 ppm, dd, $J=13, 4.5$ Hz) whereas that of **34** was axially disposed (H₁₁: δ 3.40 ppm, tr, $J=4.5$ Hz). Furthermore dissolution of an enriched mixture of **34** and **35** (34:35=1:2) in CDCl₃ at ambient temperature effected complete isomerisation of this mixture to **35** over a period of 3 days. Notably cyclisation of both **19** (to give **23** and **24**) and **31** (to give **34** and **35**) afforded only two of the possible four diastereoisomeric selenides. Molecular mechanics calculations²⁴ suggest that in each case the thermodynamically more stable

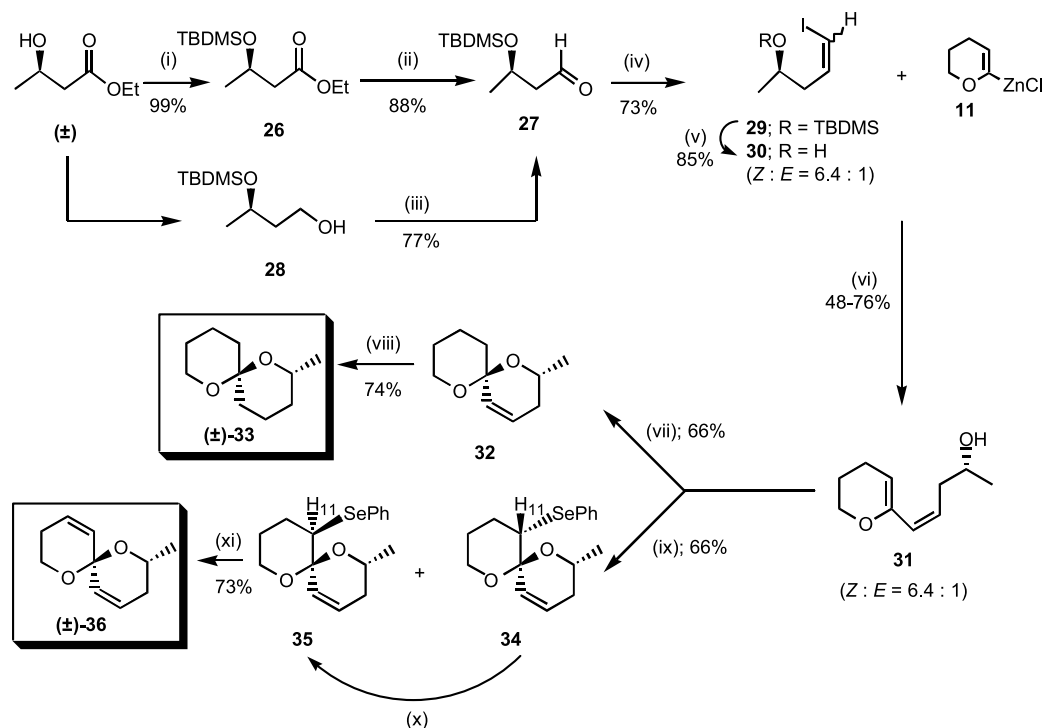

Scheme 4. Reagents and conditions: (i) TBDMSCl (1.1 equiv), DBU (1 equiv), CH₂Cl₂, 20°C ; (ii) a. Dibal-H (1.6 equiv), toluene, -78°C , b. citric acid, -78°C ; (iii) a. Dibal-H (3.0 equiv), toluene, $-78-20^{\circ}\text{C}$; b. (COCl)₂ (1.1 equiv), DMSO (2.2 equiv), -78°C ; (iv) Ph₃P=CHI (1.2 equiv); (v) CSA (0.1 equiv), MeOH, 20°C ; (vi) **11**, (2 equiv), Pd(PPh₃)₄ (5 mol%), THF, 5°C , 1 h; (vii) CSA (cat.), CH₂Cl₂, 20°C ; (viii) 5% Pd/C, H₂, EtOAc, 1 atm., 6 h; (ix) pyridine (3 equiv), PhSeCl (1 equiv), CH₂Cl₂, $-78-20^{\circ}\text{C}$, 1 h; (x) 'CDCl₃', 20°C ; (xi) Davis oxaziridine (1.1 equiv), pyridine (5 equiv), CHCl₃, 80°C .

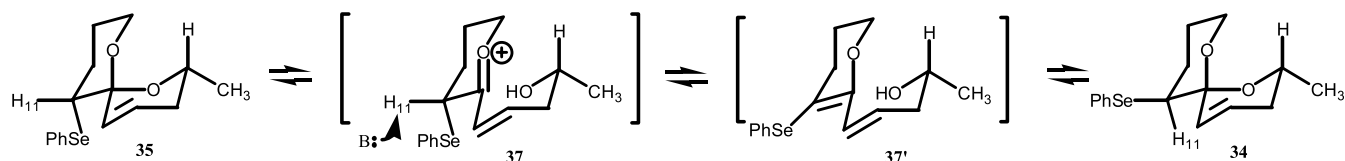

Scheme 5.

diastereoisomers are isolated: the equatorial selenide **23** being more stable than the axial selenide **24** by ca. 12.5 kJ mol⁻¹ whilst **35** is more stable than **34** by ca. 11.2 kJ mol⁻¹.

The equilibration of **34** and **35** can be explained by invoking a reversible²⁵ ring opening of the selenides **34** and **35** via the oxonium cations **37**. Cation **37** is presumably in equilibrium with the enol ether **37'** thereby providing a pathway for the epimerisation²⁶ at C₁₁. Ring closure under conditions of thermodynamic control (i.e., maximum anomeric effect in which both exocyclic oxygen substituents are axial with respect to each of the pyranose rings²⁷) would account for the interconversion of **34** into the more stable diastereoisomer **35**, Scheme 5. The fact that epimerisation at C₁₁ had occurred in this particular reaction is further substantiated by the observation that oxidation of the diastereomeric mixture of selenides **34** and **35** (**34:35**=7:11) followed by mild thermolysis afforded the doubly-unsaturated spiroketal **36** as a single diastereoisomer in 73% isolated yield.

Finally, the synthesis of spiroketal **44**, which serves as a model for more complex systems present in a number of natural products,²⁸ has also been achieved using this basic strategy. Protection (DBU, TBDMSCl, dichloromethane; 87% yield) of the hydroxyl group of ethyl (3*R**,2*R**)-3-hydroxy-2-methylbutanoate²⁹ **38** (95% d.e.) and reduction of the ester group with Dibal-H afforded the known aldehyde **40**.³⁰ The unstable aldehyde **40** was used immediately in Stork's Wittig olefination sequence affording, without any detectable epimerisation, the light-sensitive vinyl iodide **41**

as a mixture of geometric isomers (*Z:E*=6:1) in 41% overall yield from the ester **38**.

Deprotection of **41**_{*E,Z*} to **42**_{*Z*} (77% yield) was best accomplished using aqueous hydrogen fluoride in acetonitrile³¹ and was then treated with an excess of the organozinc reagent **11** (ca. 4 equiv) in the presence of Pd(PPh₃)₄ to afford the diene **43**, as a single geometrical isomer, in 72% yield. The diene **43** was very sensitive to traces of acid and occasionally underwent spirocyclisation in CDCl₃ when trying to obtain its ¹H NMR spectrum. Cyclisation of **43** on a preparative scale was best accomplished using camphorsulfonic acid as promoter (0.1 equiv) in dichloromethane enabling isolation of the volatile spiroketal **44**³² in 42% yield.

Presumably cyclisation under these conditions is again subject to thermodynamic control: diastereoisomer **44** benefits from a maximum *exo* anomeric effect (each oxygen is axial to the adjacent pyranose ring) which is augmented by the diequatorial disposition of the methyl groups at C₂ and C₃, Scheme 6. As an excess (ca. 4 equiv) of the organozinc reagent **11** was used in this coupling sequence (1 equiv just serves to deprotonate the free hydroxyl group of **42**), which is obviously wasteful if more elaborate organometallics were to be employed, in situ protection of the hydroxyl group was briefly investigated. Germane to this discussion is Negishi's³³ observation that alkoxyzincs, generated in situ from (*Z*)-iodo-2-buten-1-ol by reaction with EtZnCl, undergo efficient cross-coupling reactions with organometallic reagents, providing a highly

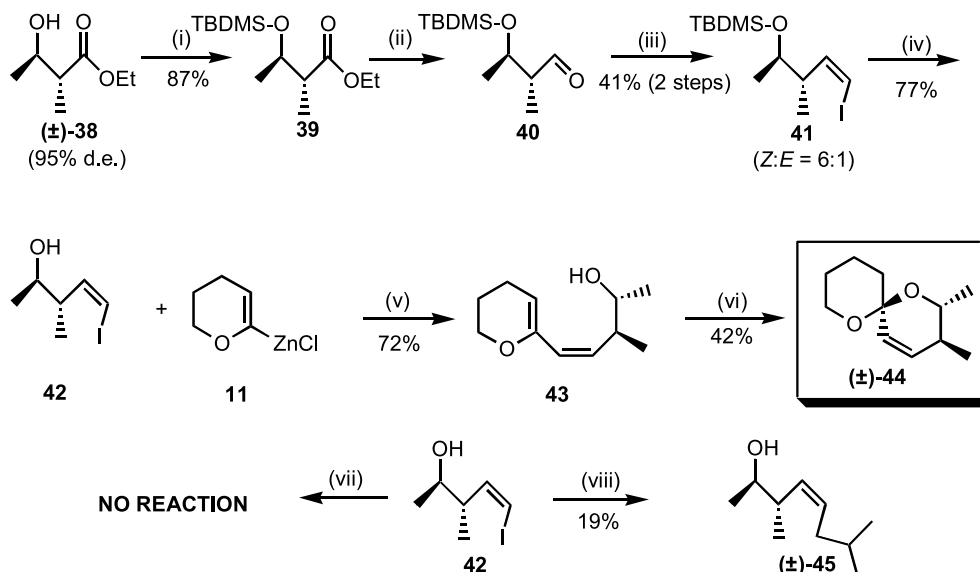

Scheme 6. Reagents and conditions: (i) TBDMSCl (1.1 equiv), DBU (1 equiv), CH₂Cl₂, 0 °C, 3 h; (ii) Dibal-H (1.6 equiv), toluene, -80 °C, 1 h; (iii) Ph₃P=CHI (1.2 equiv); (iv) 60% HF_{aq} in CH₃CN; (v) **11**, (4 equiv), Pd(PPh₃)₄ (5 mol%), THF, 5 °C, 1 h; (vi) CSA (0.1 equiv), CH₂Cl₂, 20 °C; (vii) a. EtZnCl (1 equiv), -78–20 °C; b. **11**, Pd(PPh₃)₄ (5 mol%), THF, 5 °C, 1 h; (viii) a. Dibal-H (1 equiv), -78–20 °C; b. **11**, Pd(PPh₃)₄ (5 mol%), THF, 5 °C, 1 h.

stereoselective procedure for the synthesis of (*Z*)-3-methyl-2-alken-1-ols. Unfortunately, this modification was not successful in our hands. We did observe however that prior treatment of **42** with Dibal-H (1 equiv), followed by reaction with the vinylzinc reagent **11**, as previously described, afforded the coupled product **45** (19% yield) in which transfer of an *iso*-butyl group from aluminium³⁴ rather than cross coupling with the zinc reagent **11** had taken place, Scheme 6.

3. Conclusion

In conclusion, this study illustrates that the 1,7-dioxaspiro[5.5]undec-4-ene system is readily accessible using a Wittig–Stille route, and that application of this strategy to the synthesis of more elaborate spiroketals of biological interest²⁸ should be possible. Further studies in this area are in progress the results of which will be reported at a future date.

4. Experimental

4.1. General

All non-aqueous reactions were performed under an atmosphere of dry nitrogen at temperatures which were those of the external bath. Proton and carbon nuclear magnetic resonance (¹H and ¹³C NMR) spectra were recorded on Bruker AC 300, Varian XL 300, Varian Gemini 200 spectrometers, with residual non-deuterated solvent as internal standard. All chemical shifts are quoted in parts per million downfield from tetramethylsilane. *J* values are given in Hz. Splitting patterns were abbreviated as follows: singlet (s), doublet (d), triplet (t), quartet (q), multiplet (m), broad (br). Infrared spectra were recorded on a Perkin–Elmer 1710 FT spectrometer as evaporated films unless otherwise stated. Absorption maxima (ν_{\max}) were reported in wavenumber (cm⁻¹). Mass spectra were recorded on Kratos MS20 and MS25 spectrometers. The modes of ionisation used were electron impact (EI) and chemical ionisation (CI). Microanalysis was performed at the University of Manchester. Melting points were recorded on a Kofler heated stage microscope, and are uncorrected. Petrol refers to that fraction of light petroleum ether which distils between 40 and 60 °C, and was redistilled prior to use. Tetrahydrofuran (THF) was dried over sodium/benzophenone ketyl and distilled under an atmosphere of dry nitrogen. Dichloromethane was dried over phosphorus pentoxide and distilled. Methanol was dried over magnesium methoxide and distilled. Triethylamine was dried over potassium hydroxide pellets and distilled. Pyridine was dried over potassium hydroxide pellets and redistilled under nitrogen. Dimethyl sulfoxide was dried over calcium hydride and redistilled at atmospheric pressure. Toluene was dried over sodium and redistilled under nitrogen. Where ether is mentioned it refers to diethyl ether. *n*-Butyllithium was supplied as solution in hexanes and *t*-butyllithium as a solution in pentane. Chromatography refers to flash column chromatography and was carried out using Merck silica gel 60H (40–63 μ m, 230–400 mesh) as stationary phase. Thin layer chromatography was carried

out on plates pre-coated with Kieselgel 60 F₂₅₄ silica. Visualisation was achieved by ultraviolet absorption or treatment with an ethanolic solution of dodecamolybdophosphoric acid followed by heating.

4.1.1. 3-(*t*-Butyldimethylsilyloxy)propan-1-ol, **5**.^{7a}

Sodium hydride (80% suspension in oil) (1.5 g, 49.8 mmol) was suspended in THF (100 mL) after being washed with hexane. 1,3-Propanediol (3 mL, 3.16 g, 41.5 mmol) was added to the mixture at room temperature and stirred for 45 min, after which time an opaque white precipitate had formed. *t*-Butyldimethylsilyl chloride (6.26 g, 41.5 mmol) was then added, and vigorous stirring was continued for 45 min. The mixture was poured into ether (100 mL), washed with 10% potassium carbonate (30 mL) and brine (30 mL), dried (MgSO₄) and concentrated in vacuo. The resulting oil was purified by flash column chromatography using ethyl acetate/petrol (1:4) as eluent to afford the title compound **5** (6.3 g, 80%) as a colourless oil; ν_{\max} (film) 3353, 2930, 2858, 1472, 1389, 1362, 1256, 1097, 1008, 963, 837, 777, 720 and 663 cm⁻¹; δ_{H} (300 MHz, CDCl₃): 0.09 (6H, s, MeSi), 0.9 (9H, s, ^{*t*}BuSi), 1.77 (2H, quintet, *J* = 5.5 Hz, 2-H), 2.60 (1H, br s, OH), 3.80 (2H, t, *J* = 5.5 Hz, 1-H), 3.82 (2H, t, *J* = 5.5 Hz, 3-H); δ_{C} (75 MHz, CDCl₃): -5.50 (MeSi), 18.17 (CMe₃), 25.67 (CMe₃), 34.29 (C-2), 62.27 (C-1), 62.77 (C-3); *m/z* (CI) 191 {[M+H]⁺, 100%}. Found: *m/z* 191.1465. C₉H₂₃O₂Si {[M+H]⁺} requires *m/z* 191.1467.

4.1.2. 3-(*t*-Butyldimethylsilyloxy)propanal, **6**.^{7b}

The title compound was prepared from the alcohol **5** (10.43 g, 54.9 mmol) using method A as above. Purification by flash chromatography afforded **6** as a colourless oil (9.46 g, 92%); ν_{\max} (film) 2956, 2930, 2858, 1728, 1473, 1390, 1390, 1362, 1257, 1100, 1007, 972, 837 and 778 cm⁻¹; δ_{H} (300 MHz, CDCl₃) 0.09 (6H, s, MeSi), 0.90 (9H, s, ^{*t*}BuSi), 2.59 (2H, dt, *J* = 6, 2 Hz, 2-H), 3.98 (2H, t, *J* = 6.5 Hz, 3-H), 9.80 (1H, t, *J* = 2 Hz, 1-H); δ_{C} (75 MHz) -5.46 (MeSi), 18.20 (CMe₃), 25.80 (CMe₃), 46.57 (C-2), 57.41 (C-3), 201.68 (C-1); *m/z* (CI) 189 {[M+H]⁺, 100%}. Found *m/z* 189.1310. C₉H₂₁O₂Si {[M+H]⁺} requires *m/z* 189.1311.

4.1.3. Iodomethyltriphenylphosphonium iodide.³⁶

To a suspension of triphenylphosphine (60 g, 0.23 mol) in toluene (60 mL) was added methylene iodide (24 mL, 0.3 mol). The mixture was kept at 45–50 °C for 15 h after which time the crystals were collected, washed with toluene (3 × 100 mL), and dried in vacuo (0.1 mmHg) for 4 h affording the title compound (111.2 g, 91.2%) as a white solid, mp 230 °C (dec) [Lit.³⁵ 228–230 °C (dec)]; ν_{\max} (KBr disc) 2919, 2849, 1639, 1618, 1586, 1499, 1482, 1438, 1318, 1111, 1084, 997, 785, 727, 689, 566, 508 and 484 cm⁻¹. δ_{H} (300 MHz, *d*₆-DMSO): 5.15 (2H, d, ^{*J*}*J*_{{P-H}} = 9 Hz), 7.95 (15H, s, Ar). Found: C, 43.4; H, 3.35; I, 47.4; P, 5.7. C₁₉H₁₇I₂P requires: C, 43.0; H, 3.25; I, 47.9; P, 5.85%.}

4.1.4. 2-Tri-*n*-butylstannyl-5,6-dihydro-2H-pyran, **9**.³⁵

A solution of *t*-butyl lithium (17.5 mL, 1.7 M solution in pentane) was added dropwise to a stirred solution of 2,3-dihydro-2H-pyran (2.5 g, 2.7 mL, 29.7 mmol) in THF (10 mL) at -78 °C. The mixture was allowed to warm up to 0 °C and was stirred at this temperature for 30 min, then

recooled to -78°C . Tri-*n*-butyltin chloride (6 mL, 22.3 mmol) was added dropwise and the resulting mixture was allowed to warm up to room temperature and to stir for 2 h. After quenching with aq. ammonium chloride, the product was extracted into ether (3×30 mL), the ethereal extracts dried (MgSO_4) and evaporated and the residue purified by column chromatography (triethylamine/petrol 1:19) to afford the title compound **9** (7.23 g, 87%) as a colourless oil; ν_{max} (film) 2955, 2926, 2854, 1606, 1464, 1377, 1221, 1070, 1054, 898, 839, 780 and 666 cm^{-1} ; δ_{H} (300 MHz, CDCl_3): 0.91 (15H, m, SnCH_2- and $-\text{CH}_3$), 1.33 (6H, m, $-\text{CH}_2-$, $J=7.5$ Hz), 1.50 (6H, m, $-\text{CH}_2-$, $J=7.5$ Hz), 1.85 (2H, m, 4-H, $J=5$ Hz), 2.01 (2H, m, $J=4$ Hz, 3-H), 3.90 (2H, t, $J=5$ Hz, 5-H), 4.72 (1H, t, $J=3.5$ Hz, 2-H, $^3J_{\text{H-Sn}}=30$ Hz); m/z (EI) 317 $[[\text{M} + \text{Bu}]^+]$, ^{120}Sn 100%, 315 $[[\text{M} + \text{Bu}]^+]$, ^{118}Sn 73%. (CI) 375 $[[\text{M} + \text{H}]^+]$, ^{120}Sn 100%, 373 $[[\text{M} + \text{H}]^+]$, ^{118}Sn 76%.

4.1.5. (\pm)-2-(*t*-Butyldiphenylsilyloxymethyl)-3,4-dihydro-2H-pyran, 16. Sodium hydride (80% suspension in mineral oil) (2.12 g, 70.6 mmol) was suspended in THF (100 mL) after being washed with hexane. 2-(Hydroxymethyl)-3,4-dihydro-2H-pyran (6.71 g, 58.8 mmol) was added to the mixture at room temperature and left to stir at this temperature for 45 min during which time a light brown precipitate had formed. *t*-Butyldiphenylsilyl chloride (11.76 g, 42.8 mmol) was then added, and vigorous stirring was continued for 40 h. The mixture was poured into ether (100 mL), washed with ammonium chloride, dried (MgSO_4) and concentrated in vacuo. The resulting oil was purified by flash column chromatography using ethyl acetate/petrol (1:99) as eluent to afford the title compound **16** (12.53 g, 83%) as a colourless, viscous oil; ν_{max} (film) 3070, 2930, 2857, 1650, 1472, 1428, 1391, 1362, 1242, 1188, 1136, 1112, 1071, 1005, 939, 909, 824, 798, 740 and 702 cm^{-1} ; δ_{H} (300 MHz, CDCl_3) 1.15 (3H, s, $^t\text{BuSi}$), 1.70–1.85 (1H, m, 3-H), 1.95–2.20 (3H, m, 4-H, 3'-H), 3.76 (1H, dd, $J=10$, 5.5 Hz, CH_2OSi), 3.88 (1H, dd, $J=10$, 5 Hz, CH_2OSi), 3.90–4.00 (1H, m, 2-H), 4.70 (1H, br s, 5-H), 6.43 (1H, d, $J=6.5$ Hz, 6-H), 7.40–7.80 (10H, m, Ar); δ_{C} (75 MHz, CDCl_3) 19.27 (C-4), 19.36 (CMe_3), 24.49 (CMe_3), 66.11, 75.38 (C-1), 100.35 (C-5), 127.69, 129.68, 133.69, 135.69 (Ar), 143.64 (C-6); m/z (CI) 275 $[[\text{M}^+ - \text{Ph}]^+]$, 100%; m/z (EI) 295 $[[\text{M}^+ - ^t\text{Bu}]^+]$, 65.1%. Found: m/z (CI); 353.1935 $[[\text{M} + \text{H}]^+]$. $\text{C}_{22}\text{H}_{29}\text{O}_2^{\text{Si}}$ $[[\text{M} + \text{H}]^+]$ requires m/z 353.1937.

4.1.6. Ethyl (\pm)-3-(*t*-butyldimethylsilyloxy)butanoate, 26.¹⁹ To a solution of racemic ethyl-3-hydroxybutanoate (7.12 g, 53.9 mmol) in dichloromethane (10 mL) was added 1,8-diazobicyclo[5.4.0]undec-7-ene (8.9 mL, 59.25 mmol) at 0°C followed by a solution of *t*-butyldimethylsilyl chloride (8.53 g, 56.56 mmol) in dichloromethane (10 mL). After 3 h at room temperature, the mixture was poured into water (100 mL) and extracted into ether (100 mL). The organic extracts were washed with water (50 mL), hydrochloric acid (0.1 M, 50 mL), water (50 mL), saturated sodium bicarbonate (50 mL) and water (50 mL). The organic layer was dried (MgSO_4), concentrated in vacuo, and the residue chromatographed (1:19 ethyl acetate petrol) to afford the title compound, **26** (13.12 g, 99%) as a colourless oil; ν_{max} (film) 2958, 2931, 2858, 1740, 1474, 1377, 1301, 1256, 1184, 1140, 1084, 1035, 1003, 940, 837, 811 and 777 cm^{-1} ; δ_{H} (300 MHz, CDCl_3): 0.03 (3H, s,

MeSi), 0.07 (3H, s, MeSi), 0.85 (9H, s, $^t\text{BuSi}$), 1.19 (3H, d, $J=6$ Hz, 4-H), 1.25 (3H, t, $J=7$ Hz, OCH_2CH_3), 2.35 (1H, dd, $J=14$, 5.5 Hz, 2-H), 2.46 (1H, dd, $J=14$, 7.5 Hz, 2-H), 4.11 (2H, m, OCH_2), 4.27 (1H, m, 3-H); δ_{C} (75 MHz, CDCl_3) -5.03 , -4.51 (Me_2Si), 14.21 (OCH_2CH_3), 17.96 (Me_3C), 23.93 (C-4), 25.73 (Me_3C), 44.96 (C-2), 60.25 (C-3), 65.67 (OCH_2), 171.67 (C-1); m/z (EI) 161 $[[\text{M}^+ - \text{TBDMS}]^+]$, 100%. (CI) 45 $[[\text{M}^+ - ^t\text{Bu}]^+]$, 82.1%. Found: m/z , 189.0950. $\text{C}_8\text{H}_{17}\text{SiO}_3$ $[[\text{M}^+ - ^t\text{Bu}]^+]$ requires 189.0947. Found: C, 58.7; H, 10.4; Si, 11.7. $\text{C}_{12}\text{H}_{26}\text{O}_3\text{Si}$ requires: C, 58.5; H, 10.6; Si, 11.4%.

4.1.7. (\pm)-3-(*t*-Butyldimethylsilyloxy)butanal, 27.¹⁹ Method A. A solution of oxalyl chloride (0.9 mL, 10 mmol) in dichloromethane (100 mL) was cooled to -78°C to which was added dropwise freshly dried dimethyl sulfoxide (1.5 mL, 20.8 mmol). After 15 min. at -78°C a solution of (\pm)-3-(*t*-butyldimethylsilyloxy)butanol **28**³⁶ (1.75 g, 8.58 mmol) in dichloromethane (20 mL) was added dropwise and the reaction mixture stirred at -78°C for 25 min. The reaction was quenched by the addition of triethylamine (6 mL) and allowed to warm to room temperature. After 1 h the reaction was poured into saturated aqueous sodium bicarbonate solution (50 mL). The layers were separated and the aqueous layer extracted with dichloromethane. The combined organic layers were washed with brine (50 mL), dried (MgSO_4) and concentrated in vacuo. The residue was diluted with hexane (30 mL), washed with water (20 mL), dried (MgSO_4) and concentrated in vacuo. Flash column chromatography of the residue using 1:19 ethyl acetate:petrol as eluent, gave the title compound **27** as a colourless oil (1.34 g, 77%).

Method B. Dibal-H in toluene (1 M, 47.3 mL) was added dropwise to a cooled (-80°C) solution of ethyl (\pm)-3-(*t*-butyldimethylsilyloxy)butanoate **26** (7.27 g, 29.55 mmol) in anhydrous toluene (210 mL). After 1 h at -78°C the reaction was quenched by the dropwise addition of methanol (30 mL) whilst keeping the temperature below -78°C . Citric acid (10% aqueous solution, 300 mL) was then added, the mixture was allowed to warm to room temperature, the organic phase was decanted and the aqueous layer was extracted with dichloromethane (3×100 mL). The combined organic phases were dried (MgSO_4), the solvent was removed under reduced pressure and the residue purified by flash chromatography (ethyl acetate/petrol 1:19) to afford the title compound **27** (5.26 g, 88%); ν_{max} (film) 2957, 2931, 2896, 2858, 2721, 1730, 1473, 1464, 1377, 1363, 1257, 1219, 1186, 1138, 1100, 1030, 940, 904, 837, 811 and 777 cm^{-1} ; δ_{H} (300 MHz, CDCl_3): 0.06 (3H, s, MeSi), 0.08 (3H, s, MeSi), 0.85 (9H, s, $^t\text{BuSi}$), 1.24 (3H, d, $J=6$ Hz, 4-H), 2.45 (1H, ddd, $J=15$, 5, 2 Hz, 2-H), 2.55 (1H, ddd, $J=15$, 7, 3 Hz, 2-H), 4.35 (1H, sextet, $J=5.5$ Hz, 2-H), 9.80 (1H, t, $J=2.5$ Hz, 1-H); δ_{C} (75 MHz, CDCl_3): -4.48 , -3.90 (Me_2Si), 18.43 (Me_3C), 24.66 (C-4), 26.2 (Me_3C), 53.45 (C-2), 65.02 (C-3), 202.74 (C-1); m/z (EI) 145 $[[\text{M}^+ - ^t\text{Bu}]^+]$, 100%. (CI) 203 $[[\text{M} + \text{H}]^+]$, 100%. Found: m/z (CI) 220.1742. $\text{C}_{10}\text{H}_{26}\text{NSiO}_2$ $[[\text{M} + \text{NH}_4]^+]$ requires m/z 220.1733. Found: C, 59.1; H, 11.1. $\text{C}_{10}\text{H}_{22}\text{O}_2\text{Si}$ requires: C, 59.4; H, 10.8%.

4.1.8. (\pm)-3-(*t*-Butyldimethylsilyloxy)butan-1-ol, 28.³⁷ To a solution of ethyl (\pm)-3-(*t*-butyldimethylsilyloxy)butanoate

25 (3.02 g, 12.3 mmol) in THF (10 mL) was added Dibal-H (1 M solution in toluene, 27.0 mmol) at -78°C . The mixture was allowed to warm up to room temperature and stirred for 2–3 h. The reaction was quenched with water (1 mL), poured into diethyl ether (100 mL), sodium hydroxide (3 M, 1 mL) was added and the mixture was stirred until the aluminium salts had precipitated. The supernatant was filtered through celite[®] and the celite[®] pad washed with ether (3×30 mL). The combined organic extracts were dried (MgSO_4), concentrated and the residue purified by column chromatography (ethyl acetate/petrol 1:4) to afford the title compound (**28**) (1.95 g, 78%) as a colourless oil. ν_{max} (film) 3356, 2957, 2930, 2858, 1473, 1376, 1256, 1141, 1100, 1060, 1030, 943, 904, 837, 776, 718 and 664 cm^{-1} ; δ_{H} (300 MHz, CDCl_3): 0.05 (6H, s, Me_2Si), 0.88 (9H, s, $^t\text{BuSi}$), 1.22 (3H, d, $J=6$ Hz, 4-H), 1.62 (1H, m, 2-H), 1.75 (1H, m, 2-H), 2.70 (1H, s, OH), 3.70 (1H, m, 1-H), 3.80 (1H, m, 1-H), 4.1 (1H, m, 3-H); δ_{C} (75 MHz): -4.96 , -4.36 (Me_2Si), 17.94 (Me_3C), 23.44 (C-4), 25.80 (Me_3C), 40.57 (C-2), 60.41 (C-1), 68.25 (C-3); m/z (EI) 75 $\{[(\text{CH}_3)_2\text{HSi-O}]^+, 100\%$, (CI) 205 $\{[\text{M}+\text{H}]^+, 100\%$ }. Found: m/z (CI) 205.1625. $\text{C}_{10}\text{H}_{25}\text{O}_2\text{Si}$ $\{[\text{M}+\text{H}]^+\}$ requires m/z 205.1624. Found: C, 58.7; H, 12.2; Si, 14.2. $\text{C}_{10}\text{H}_{24}\text{O}_2\text{Si}$ requires C, 58.8; H, 11.8; Si, 13.7%.

4.1.9. (\pm)-(Z,E)-4-(*t*-Butyldimethylsilyloxy)-1-iodopent-1-ene, **29.** To a suspension of iodomethyltriphenylphosphonium iodide (16.35 g, 30.85 mmol) in THF (16 mL) at room temperature was slowly added sodium hexamethyldisilazide (1 M solution in THF, 32.4 mL). After stirring for 10 min, the dark red-coloured solution of the yield was cooled to -78°C and (\pm)-3-(*t*-butyldimethylsilyloxy)butanal **28** (4.99 g, 24.7 mmol) was added slowly. The mixture was allowed to warm up to room temperature and, after 30 min, the solvent was removed in vacuo. The residue was triturated with petrol (3×50 mL) and the combined extracts filtered through celite[®] to remove triphenylphosphine oxide. The combined organic extracts were concentrated in vacuo and the residue purified by column chromatography (dichloromethane/hexane 1:19) to afford the title compound **29** (6.7 g, 83%) as a light-sensitive colourless³⁸ oil, ($Z:E=8.2:1$); ν_{max} (film) 2956, 2929, 2894, 2857, 1611, 1472, 1377, 1361, 1308, 1256, 1131, 1089, 1022, 836, 808 and 776 cm^{-1} ; δ_{H} (300 MHz, CDCl_3): *Z*-isomer; 0.07 (6H, s, Me_2Si), 0.90 (9H, s, $^t\text{BuSi}$), 1.19 (1H, d, $J=6$ Hz, 5-H), 2.31 (2H, distorted triplet, 3-H), 3.98 (1H, sextet, $J=6$ Hz, 4-H), 6.28 (2H, m, 2-H). *E*-isomer 0.07 (6H, s, Me_2Si), 0.90 (9H, s, $^t\text{BuSi}$), 1.15 (1H, d, $J=6$ Hz, 5-H), 2.18 (2H, distorted triplet, 3-H), 3.86 (1H, sextet, $J=6$ Hz, 4-H), 6.03 (1H, d, $J=14.5$ Hz, 1-H), 6.55 (1H, dt, $J=14.5$, 7.5 Hz, 2-H). δ_{C} (75 MHz, CDCl_3): *Z*-isomer -4.69 , -4.46 (Me_2Si), 18.11 (Me_3C), 23.59 (C-5), 25.88 (Me_3C), 44.55 (C-3), 67.30 (C-4), 83.69 (C-1), 138.33 (C-2). m/z (EI) 269 $[\text{M}+^t\text{Bu}, 100\%]$ (CI) m/e 327 $\{[\text{M}+\text{H}]^+, 48\%$. Found: m/z (CI) 327.0643. $\text{C}_{11}\text{H}_{24}\text{IOSiO}$ requires m/z 327.0655.

4.1.10. (Z,E)-4-(*t*-Butyldimethylsilyloxy)-1-iodobut-1-ene, **7.** The title compound was prepared from the aldehyde **6** (5.21 g, 27.7 mmol) using the method described above. Isolated as a light-sensitive, colourless, oil³⁸ (6.71 g, 78%; $Z:E=7.6:1$); ν_{max} (film) 2954, 2929, 2857, 1610, 1472, 1385, 1287, 1257, 1103, 939, 836 and 777 cm^{-1} ; δ_{H} (300 MHz, CDCl_3): *Z*-isomer 0.09 (6H, s, MeSi), 0.90 (9H,

s, $^t\text{BuSi}$), 2.36 (2H, m, 4-H), 3.70 (2H, t, $J=6.5$ Hz, 3-H), 6.29 (2H, m, 1-H, 2-H); *E*-isomer 0.08 (6H, s, MeSi), 0.90 (9H, s, $^t\text{BuSi}$), 2.26 (2H, m, 4-H), 3.65 (2H, t, $J=6.5$ Hz, 3-H), 6.02 (1H, d, $J=14.5$ Hz, 1-H), 6.54 (1H, dt, $J=14.5$, 7.5 Hz, 2-H); δ_{C} (75 MHz, CDCl_3) *Z*-isomer -5.27 (MeSi), 18.33 (CMe_3), 25.93 (CMe_3), 38.37 (C-3), 61.2 (C-4), 83.62 (C-1), 138.31 (C-2); *E*-isomer -5.27 , 18.33, 25.93, 39.39, 61.68, 83.63, 143.33; m/z (EI) 255 $[\text{M}+^t\text{Bu}, 100\%]$ (CI) 313 $\{[\text{M}+\text{H}]^+, 100\%$. Found: m/z (CI) 313.0485. $\text{C}_{10}\text{H}_{22}\text{IOSi}$ requires m/z 313.0486.

4.1.11. (Z,E)-4-Hydroxy-1-iodobutene, **8.** The title compounds were prepared from the vinyl iodide **7** (2.48 g, 7.95 mmol) using the method above. Flash chromatography afforded the iodide as a colourless, light-sensitive oil³⁸ (1.23 g, 78%), ($Z:E=6.4:1$); ν_{max} (film) 3338, 3066, 3948, 2880 1610, 1423, 1336, 1307, 1284, 1254, 1165, 1040, 946, 883, 852 and 691 cm^{-1} ; δ_{H} (300 MHz, CDCl_3) *Z*-isomer 1.75 (1H, s, OH), 2.44 (2H, dq, $J=6.5$, 1 Hz, 3-H), 3.75 (2H, t $J=6.5$ Hz, 4-H), 6.28 (1H, q, $J=7$ Hz, 2-H), 6.37 (1H, td, $J=7$, 1 Hz, 1-H); *E*-isomer 1.75 (1H, s, OH), 2.32 (2H, dq, $J=6.5$, 1 Hz, 3-H), 3.68 (2H, t, $J=6.5$ Hz, 1-H), 6.16 (1H, td, $J=14.5$, 1 Hz, 1-H), 6.55 (1H, dt, $J=14.5$, 7 Hz, 2-H); δ_{C} (75 MHz, CDCl_3): *Z*-isomer 38.11 (C-3), 60.96 (C-4), 84.74 (C-1), 137.68 (C-2); *E*-isomer 39.16 (C-3), 61.01 (C-4), 84.74 (C-1), 142.68 (C-2); m/z (EI) 198 $[\text{M}^+, 32.7\%]$. Found: m/z 197.9544. $\text{C}_4\text{H}_7\text{IO}$ $[\text{M}^+]$ requires 197.9543.

4.1.12. (\pm)-(Z,E)-4-Hydroxy-1-iodopentene, **30.** To a solution of (\pm)-(Z,E)-4-(*t*-butyldimethylsilyloxy)-1-iodopentene **29** (1.68 g, 5.15 mmol) in methanol (10 mL) was added camphorsulfonic acid (30 mg) and mixture stirred for 15 h at ambient temperature after which time anhydrous potassium carbonate (0.15 g) was added and stirring was continued for 15 min. The mixture was filtered and concentrated in vacuo. The residue was dissolved in dichloromethane (50 mL), washed with saturated aqueous sodium hydrogencarbonate solution, dried (MgSO_4), concentrated in vacuo and the residue chromatographed (1:4 ethyl acetate petrol) to afford the title compound **30** (0.93 g, 85%) as a colourless, light-sensitive oil³⁸ ($Z:E=6.4:1$); ν_{max} (film) 3340, 2967, 2925, 1609, 1456, 1376, 1307, 1262, 1121, 1081, 973, 943 and 844 cm^{-1} ; δ_{H} (300 MHz, CDCl_3): *Z*-isomer 1.25 (3H, d $J=6.5$ Hz, 5-H), 2.34 (2H, t, $J=6.5$ Hz, 3-H), 3.98 (1H, sextet, $J=6.5$ Hz, 4-H), 6.29 (1H, q, $J=7$ Hz, 2-H), 6.36 (1H, distorted d, $J=8$ Hz, 1-H); *E*-isomer 1.20 (3H, d, $J=6.5$ Hz), 2.10 (2H, t, $J=6.5$ Hz), 3.87 (1H, sextet, $J=6.5$ Hz), 6.13 (1H, d, $J=15$ Hz, 1-H), 6.55 (1H, dt, $J=15$, 7.5 Hz, 2-H); δ_{C} (75 MHz, CDCl_3): *Z*-isomer 23.20 (C-5), 44.10 (C-3), 66.89 (C-4), 84.80 (C-1), 137.56 (C-2); *E*-isomer 22.87, 45.50, 66.58, 84.90, 142.60; m/z (EI) 212 $[\text{M}^+, 11.6\%]$ (CI) 230 $\{[\text{M}+\text{NH}_4]^+, 100\%$. Found: m/z (CI) 211.9704. $\text{C}_5\text{H}_9\text{IO}$ $[\text{M}^+]$ requires m/z 211.9700.

4.1.13. (\pm)-(4Z,E)-5-(3,4-Dihydro-2H-6-pyran-1-yl)-4-penten-2-ol, **31.** Method A. To a stirred mixture of palladium(II) acetate (41 mg, 5 mol%), tri-(*o*-tolyl)phosphine (77 mg, 10 mol%) and triethylamine (0.25 mL) in acetonitrile (10 mL) was added 2-tri-*n*-butylstannyl-5,6-dihydro-2H-pyran **9** (1.22 g, 3.22 mmol) followed by (\pm)-(Z,E)-4-hydroxy-1-iodopentene **30** (0.73 g, 3.44 mmol). The

reaction mixture was brought to reflux for 1.5 h, cooled to ambient temperature and saturated aqueous potassium fluoride in 10% ammonium hydroxide was added. The resulting mixture was filtered and extracted with ether (3 × 30 mL). The combined organic extracts were dried (MgSO₄), concentrated in vacuo, and the residue chromatographed (3:1:16 ethyl acetate/triethylamine/petrol) to afford the title compound **31** (261 mg, 48%, colourless oil) as an inseparable mixture of isomers (*Z:E* = 6:1).

Method B. A solution of *t*-butyl lithium (7.4 mL, 1.7 M solution in pentane) was added dropwise to a stirred solution of 2,3-dihydro-2*H*-pyran (1.15 mL, 12.6 mmol) in THF (8 mL) at −78 °C. The mixture was allowed to warm to 0 °C and was stirred at this temperature for 30 min, then recooled to −78 °C. Zinc chloride (1 M solution in ether, 13.8 mL) was added dropwise and the resulting mixture was allowed to warm up to room temperature and to stir for 2 h. Catalyst generation: in a separate flask, Dibal-H (1 M solution in toluene, 0.33 mL) was added dropwise to PdCl₂(PPh₃)₂ (116 mg, 0.16 mmol, 5 mol%) in THF (5 mL) at 0 °C and the resulting mixture was stirred for 30 min. The solution containing the catalyst was then transferred by canula under nitrogen to the solution of the vinyl zinc intermediate **11** at 5–10 °C, followed by a solution of (*Z,E*)-4-hydroxy-1-iodopentene **30** (0.72 g, 3.4 mmol) in THF (2 mL) and resulting mixture was stirred for 1 h at ambient temperature. After quenching with sodium hydroxide (10 mL), the product was extracted into ether (3 × 30 mL), the ethereal extracts dried (MgSO₄), concentrated in vacuo, and column chromatography (3:1:16 ethyl acetate/triethylamine/petrol) of the residue afforded the title compound **30** (400 mg, 74%; *Z:E* = 6:1) as a mobile oil.

Method C. The title compound **31** was prepared in exactly the same way as in method B except that freshly prepared Pd(PPh₃)₄ (192 mg, 5 mol%) was used as the catalyst. (±)-(*Z,E*)-4-hydroxy-1-iodopentene **30** (0.72 g, 3.4 mmol) afforded **31** (413 mg, 76%; *Z:E* = 6:1); ν_{\max} (film) 3379, 2967, 2929, 1656, 1612, 1414, 1374, 1352, 1310, 1234, 1165, 1122, 1085, 1060, 1002, 922, 886, 846, 814 and 781 cm^{−1}; δ_{H} (300 MHz, C₆D₆) *Z*-isomer 1.23 (3H, d, *J* = 6 Hz, 1'-H), 1.45 (2H, quintet, *J* = 5.5 Hz, 3-H), 1.85 (2H, m, 4-H), 2.05–2.15 (1H, br s, OH), 2.73 (1H, dt, *J* = 15, 7 Hz, 3'-H), 2.82 (1H, dt, *J* = 15, 7 Hz, 3'-H), 3.76 (1H, t, *J* = 6.5 Hz, 2'-H), 3.85 (2H, t, *J* = 6.5 Hz, 2-H), 4.72 (1H, t, *J* = 4 Hz, 5-H), 5.48 (1H, dt, *J* = 12, 6 Hz, 4'-H), 5.82 (1H, d, *J* = 12 Hz, 5'-H); *E*-isomer 1.12 (3H, d, *J* = 6 Hz, 1'-H), 1.32 (2H, quintet, *J* = 5.5 Hz, 3-H), 1.91 (2H, m, 4-H), 2.15–2.30 (3H, m, 3'-H, OH), 3.70 (1H, t, *J* = 6.5 Hz, 2'-H), 3.89 (2H, t, *J* = 6.5 Hz, 2-H), 4.69 (1H, t, *J* = 4 Hz, 5-H), 5.90 (1H, d, *J* = 15.5 Hz, 5'-H), 6.27 (1H, dt, *J* = 15.5, 7.5 Hz, 4'-H); δ_{C} (75 MHz, C₆D₆) *Z*-isomer 20.98 (Me), 22.23 (C-4), 23.39 (C-3), 39.01 (C-3'), 65.61 (C-2'), 67.91 (C-2), 103.11 (C-5), 127.02 (C-4'), 127.15 (C-5'), 153.03 (C-6); *E*-isomer 21.03 (Me), 22.23 (C-4), 22.66 (C-3), 42.65 (C-3'), 65.87 (C-2'), 67.35 (C-2), 100.96 (C-5), 125.06 (C-4'), 129.09 (C-5'), 153.03 (C-6); *m/z* (EI) 168 [M+, 42.3%] (CI) 169 {[M+H]⁺, 8.4%}. Found *m/z* (CI) 168.1146. C₁₀H₁₆O₂ [M⁺] requires *m/z* 168.1150.

4.1.14. (*Z,E*)-4-(3,4-Dihydro-2*H*-6-pyranyl)-3-buten-1-ol, **10.** The following coupling procedures were attempted:

method A (using 0.5 g, 2.52 mmol vinyl iodide **8**) afforded **10** (127 mg, 33%); method B (using 0.75 g, 3.79 mmol of the iodide **8**) gave **10** (395 mg, 71%) whilst method C (same scale as in method B) afforded the diene **10** in 72% yield (*Z:E* = 6:1); ν_{\max} (film) 3357, 3020, 2930, 2875, 1656, 1612, 1466, 1435, 1414, 1352, 1310, 1234, 1163, 1087, 1060, 966, 934, 890, 865 and 784 cm^{−1}; δ_{H} (300 MHz, C₆D₆) *Z*-isomer 1.44 (2H, quintet, *J* = 5.5 Hz, 3-H), 1.83 (2H, dt, *J* = 6, 4 Hz, 4-H), 2.81 (2H, q, *J* = 6.5 Hz, 2'-H), 3.6 (2H, t, *J* = 6.5 Hz, 1'-H), 3.75 (2H, t, *J* = 5 Hz, 2-H), 4.71 (1H, t, *J* = 4 Hz, 5-H), 5.40 (1H, dt, *J* = 12, 7 Hz, 3'-H), 5.82 (1H, d, *J* = 12 Hz, 4'-H); *E*-isomer 1.52 (2H, quintet, *J* = 5.5 Hz, 3-H), 1.90 (2H, dt, *J* = 6, 4 Hz, 4-H), 2.21 (2H, q, *J* = 6.5 Hz, 2'-H), 3.45 (2H, t, *J* = 6.5 Hz, 1'-H), 3.85 (2H, t, *J* = 5 Hz, 2-H), 4.68 (1H, t, *J* = 4 Hz, 5-H), 5.87 (1H, d, *J* = 15.5 Hz, 4'-H), 6.22 (1H, dt, *J* = 15.5, 7.5 Hz, 3'-H); δ_{C} (75 MHz; C₆D₆) *Z*-isomer 20.96 (C-3), 22.22 (C-4), 32.98 (C-2'), 62.58 (C-1'), 65.61 (C-2), 103.08 (C-5), 127.11, 127.19 (C-3', C-4'), 153.00 (C-6); *E*-isomer 21.01 (C-3), 22.66 (C-4), 36.31 (C-2'), 62.08 (C-1'), 65.86 (C-2), 100.88 (C-5), 124.97 (C-3'), 128.82 (C-4'), 153.0 (C-6); *m/z* (CI) 155 {[M+H]⁺, 100%}. Found: *m/z* (CI) 154.0990. C₉H₁₄O₂ [M⁺] requires *m/z* 154.0994.

4.1.15. (2*R,6*S**)-2-Methyl-1,7-dioxaspiro[5.5]undec-4-ene, **32**²²** To a solution of (*Z,E*)-4-(3,4-dihydro-2*H*-6-pyranyl)-3-buten-1-ol, **31** (261 mg, 1.55 mmol) in dichloromethane (5 mL) was added camphorsulfonic acid (30 mg) and the mixture stirred at room temperature for 1 h. After quenching with saturated sodium bicarbonate, the product was extracted into ether (2 × 20 mL), the ethereal extracts dried (MgSO₄), and evaporated and the residue purified by column chromatography (ethyl acetate/petrol 1:19) to afford the title compound **32** (172 mg, 66%) as a colourless oil; ν_{\max} (film) 2940, 1658, 1397, 1270, 1201, 1186, 1101, 1072, 1046, 1002, 953, 899 and 808 cm^{−1}; δ_{H} (300 MHz, CDCl₃): 1.27 (3H, d, *J* = 6.5 Hz, Me), 1.50–1.65 (5H, m, 9-H, 10-H, 11-H), 1.90–2.00 (3H, m, 3-H, 11'-H), 3.60 (1H, br d, *J* = 10 Hz, 8eq-H), 3.85 (1H, dt, *J* = 11.5, 2.5 Hz, 8ax-H), 4.01 (1H, ddq, *J* = 10, 6, 4.5 Hz, CHMe), 5.61 (1H, ddd, *J* = 10, 2.5, 1 Hz, 5-H), 5.89 (1H, ddd, *J* = 10, 5, 2.5 Hz, 4-H); δ_{C} (50 MHz, CDCl₃) 19.01 (C-10), 21.60 (C-Me), 25.59 (C-11), 32.79 (C-9), 35.39 (C-3), 61.18 (C-8), 63.54 (C-2), 94.49 (C-6), 128.31 (C-5), 130.79 (C-4); *m/z* (EI) 168 [M+, 79.2%]; (CI) 169 {[M+H]⁺, 87.9%}. Found: *m/z* (CI) 168.1146. C₁₀H₁₆O₂ [M⁺] requires *m/z* 168.1150.

4.1.16. (±)-1,7-Dioxaspiro[5.5]undec-4-ene, **12¹¹** The title compound was prepared using the method above from the diene **10** (359 mg, 2.33 mmol) as a colourless oil (293 mg, 82%); ν_{\max} (film) 3040, 2940, 2874, 1656, 1428, 1398, 1379, 1353, 1335, 1273, 1201, 1184, 1160, 1138, 1096, 1069, 1053, 1039, 953, 897, 868, 812, 769, 722 and 689 cm^{−1}; δ_{H} (300 MHz, CDCl₃) 1.4–1.65 (5H, m, 10-H, 11-H, 9ax-H), 1.70–1.90 (2H, m, 9eq-H, 3eq-H), 2.23 (1H, ddd, *J* = 18, 10, 5.5, 2.5 Hz, 3ax-H), 3.53–3.60 (1H, m, 8eq-H), 3.70 (1H, dd, *J* = 11.5, 6.5 Hz, 2eq-H), 3.80 (1H, dt, *J* = 12, 3 Hz, 8ax-H), 3.87 (1H, dt, *J* = 12, 3.5 Hz, 2ax-H), 5.64 (1H, ddd, *J* = 10, 3, 1.5 Hz, 5-H), 5.87 (1H, dd, *J* = 10, 5 Hz, 4-H); δ_{C} (75 MHz, CDCl₃) 18.53 (C-10), 24.71 (C-3), 24.98 (C-8), 34.79 (C-11), 57.56 (C-2), 60.78 (C-8), 92.78 (C-6), 127.58 (C-5), 130.66 (C-4); *m/z* (CI) 155 {[M+H]⁺,

100%}; (EI) 154 [M^+ , 75.1%]. Found: (CI) m/z 154.1001. $C_9H_{14}O_2$ [M^+] requires m/z 154.0993.

4.1.17. (2*R,6*S**)-2-Methyl-1,7-dioxaspiro[5.5]undecane, 33.**²³ To a solution of (2*R**,6*S**)-2-methyl-1,7-dioxaspiro[5.5]undec-4-ene, **32** (228 mg, 1.34 mmol) in ethyl acetate (20 mL) was added 5% palladium on carbon (30 mg) and the mixture was hydrogenated at 1 atm for 6 h at room temperature. The catalyst was removed by filtration through celite[®], the celite[®] pad washed with ethyl acetate (25 mL) and the combined organic extracts were concentrated in vacuo. The residue was purified by column chromatography (ethyl acetate/petrol 3:97) to afford the title compound **33** (171 mg, 74%) as a colourless oil; ν_{\max} (film) 2939, 2870, 1449, 1384, 1349, 1282, 1257, 1231, 1214, 1182, 1138, 1095, 1065, 1048, 999, 965, 948, 926, 897, 845 and 804 cm^{-1} ; δ_H (300 MHz, $CDCl_3$) 1.15 (3H, d, $J=6$ Hz), 1.20–2.00 (12H, m), 3.50–3.80 (3H, m, 2-H, 8-H); δ_C (75 MHz, $CDCl_3$) 18.57, 18.89 (C-10, C-4), 21.79 (Me), 25.42 (C-9), 32.69 (C-3), 35.08, 35.83 (C-5, C-7), 60.23 (C-8), 65.10 (C-1), 95.54 (C-6); m/z (EI) 169 {[$M-H$]⁺, 86.2%}. Found: m/z (CI) 169.1225. $C_{10}H_{17}O_2$ {[$M-H$]⁺} requires m/z 169.1228.

4.1.18. (±)-1,7-Dioxaspiro[5.5]undecane, 13¹³ The title compound was prepared using the method above from the spiroketal **12** (226 mg, 1.46 mmol) as a colourless oil (213 mg, 93%); ν_{\max} (film) 2948, 2870, 1452, 1384, 1280, 1256, 1230, 1208, 1179, 1096, 1068, 991, 935, 913, 876 and 796 cm^{-1} ; δ_H (300 MHz, $CDCl_3$) 1.40–2.00 (12H, m), 3.60–3.80 (4H, m, 2-H, 8-H); δ_C (75 MHz) 18.54 (C-4, C-10), 25.33 (C-5, C-11), 35.76 (C-3, C-9), 60.37 (C-2, C-8), 95.01 (C-6); m/z (EI) 155 {[$M-H$]⁺, 32.1%}. Found: m/z (CI) 155.1068. $C_9H_{15}O_2$ {[$M-H$]⁺} requires m/z 155.1072.

4.1.19. (2*R,6*R**,11*S**)-2-Methyl-11-phenylselenenyl-1,7-dioxaspiro[5.5]undec-4-ene, 34 and (2*R**,6*R**,11*R**)-2-methyl-11-phenylselenenyl-1,7-dioxaspiro[5.5]undec-4-ene, 35.** To a solution of (4*Z*,*E*)-5-(3,4-dihydro-2*H*-6-pyran-4-yl)-4-penten-1-ol, **31** (0.36 g, 2.14 mmol) in dichloromethane (5 mL) was added pyridine (0.2 mL, 6.4 mmol). The mixture was cooled to -78 °C, phenylselenenyl chloride (0.45 g, 2.35 mmol) was added and the reaction was allowed to warm to room temperature and stir for 1 h. After quenching with ice cold aqueous sodium hydrogencarbonate, the product was extracted into dichloromethane (3 × 30 mL), the combined extracts dried ($MgSO_4$), and evaporated and residue purified by column chromatography (ethyl acetate/petrol 3:97) to afford the title compounds **34** and **35** (458 mg, 66%) as an inseparable mixture (**34**:**35** = 7:11). The diastereoisomers equilibrated in $CDCl_3$ after 3 days at 20 °C to **35** as a single diastereoisomer. Mixture: ν_{\max} (film) 3053, 2931, 2874, 1658, 1579, 1478, 1437, 1396, 1342, 1282, 1231, 1188, 1133, 1101, 1064, 1023, 991, 949, 932, 893, 845, 742 and 709 cm^{-1} ; δ_H (300 MHz, $CDCl_3$): Initially 1.30 (33/18H, d, $J=6.5$ Hz, Me), 1.32 (21/18H, d, $J=6.5$ Hz, Me), 1.50–1.80 (3H, m, 9-H, 3ax-H), 1.90–2.10 (2H, m, 10eq-H, 3eq-H), 2.28 (11/18H, qd, $J=13$, 4.5 Hz, 10ax-H), 2.50–2.65 (7/18H, m, 10ax-H), 3.16 (11/18H, dd, $J=13$, 4.5 Hz, 11-H), 3.40 (7/18H, t, $J=4.5$ Hz, 11-H), 3.62–3.76 (1H, m, 8eq-H), 3.87–4.00 (1H, m, 8ax-H), 4.06 (1H, sextet, $J=6.5$ Hz, 2-H), 5.71 (11/18H, dt,

$J=10$, 2 Hz, 5-H), 5.98–6.12 (1H, m, 4-H), 6.36 (7/18H, dt, $J=10$, 2 Hz, 5-H), 7.25–7.62 (5H, m, Ar); Equilibrated (essentially **35**) δ_H 1.30 (3H, d, $J=6.5$ Hz, Me), 1.50–1.80 (3H, m, 9-H, 3ax-H), 1.95–2.10 (2H, 10eq-H, 3eq-H), 2.28 (1H, qd, $J=13$, 4.5 Hz, 10ax-H), 3.16 (1H, dd, $J=13$, 4.5 Hz, 11-H), 3.62–3.76 (1H, m, 8eq-H), 3.87–3.90 (1H, dt, $J=11$, 3 Hz, 8ax-H), 4.04 (1H, sextet, $J=6.5$ Hz, 2-H), 5.71 (1H, dt, $J=10$, 2 Hz, 5-H), 6.05 (1H, dt, $J=9.5$, 4 Hz, 4-H), 7.20–7.65 (5H, m, Ar); δ_C (75 MHz; $CDCl_3$): Initially 21.01, 22.48, 26.63, 27.40, 28.34, 32.09, 31.14, 49.63, 50.21, 60.16, 61.03, 63.84, 64.31, 95.90, 96.09, 126.85, 126.98, 127.17, 128.07, 128.89, 128.96, 129.13, 129.13, 129.32, 130.23, 130.93, 133.38, 134.30; Equilibrated 21.01 (Me), 27.40 (C-9), 28.34 (C-3), 32.09 (C-7), 49.63 (C-11), 60.16 (C-8), 63.84 (C-2), 96.10 (C-6), 127.17, 127.74, 128.88, 129.19 (Ar), 129.13, 129.32 (C-4, C-5), 131.57, 134.30, 134.37 (Ar); m/z (EI) 324 [M^+ , ⁸⁰Se 47.5%]; (CI) 325 {[$M+H$]⁺, ⁸⁰Se 38.3%}. Found: m/z 324.0616. $C_{16}H_{20}O_2^{80}Se$ [M^+] requires m/z 324.0628.

4.1.20. (6*S,11*S**)-11-Phenylselenenyl-1,7-dioxaspiro[5.5]undec-4-ene, 14.** The title compound was prepared from the diene **10** (382 mg, 2.48 mmol) using the method above and isolated, after flash chromatography, as essentially a single diastereoisomer (559 mg, 73%); ν_{\max} (film) 3042, 2935, 2876, 1658, 1599, 1477, 1437, 1395, 1377, 1344, 1316, 1283, 1229, 1209, 1177, 1145, 1070, 1036, 993, 949, 929, 888, 853, 772, 743, 713, 693 and 671 cm^{-1} ; δ_H (300 MHz, $CDCl_3$) 1.55–1.80 (2H, m, 9-H), 1.90–2.10 (2H, m, 3eq-H, 10eq-H), 2.23 (1H, dq, $J=13$, 4.5 Hz, 10ax-H), 2.41 (1H, dddt, $J=18$, 9, 5.5, 2.5 Hz, 3ax-H), 3.21 (1H, dd, $J=12.5$, 4.5 Hz, 11-H), 3.67 (1H, br dd, $J=11$, 5 Hz, 8eq-H), 3.80–4.03 (3H, m, 2-H, 8ax-H), 5.74 (1H, ddd, $J=10$, 3, 1 Hz, 5-H), 6.12 (1H, dd, $J=10$, 5.5 Hz, 4-H), 7.24–7.62 (10H, m, Ar); δ_C (75 MHz, $CDCl_3$) 24.52 (C-3), 27.29 (C-9), 28.83 (C-10), 49.45 (C-11), 58.12 (C-4), 60.32 (C-8), 94.92 (C-6), 127.28, 128.93 (Ar), 129.12 (C-5), 129.60 (C-6), 129.95, 133.45, 134.33, 134.40 (Ar); m/z (CI) 311 {[M^+H], 100%}. Found: m/z 310.0473. $C_{15}H_{18}O_2^{80}Se$ [M^+] requires m/z 310.0472.

4.1.21. (2*R,6*S**)-2-Methyl-1,7-dioxaspiro[5.5]undec-4,10-diene, 36.** The diastereomeric mixture of the selenides **34** and **35** (0.39 g, 1.22 mmol) was dissolved in chloroform (5 mL) to which was added pyridine (0.5 mL, 6.02 mmol) and 2-benzenesulfonyl-3-phenyloxaziridine¹⁵ (413 mg, 1.58 mmol) and the reaction mixture brought to a gentle reflux 15 h. The solvent was removed in vacuo and the residue chromatographed (2:3 dichloromethane/petrol) to afford the title compound **35** (147 mg, 73%) as a yellow oil; ν_{\max} (film) 3041, 2974, 2931, 2895, 2828, 1656, 1462, 1446, 1425, 1398, 1386, 1367, 1339, 1270, 1214, 1201, 1183, 1135, 1100, 1076, 1048, 1021, 980, 928, 903, 874, 851, 819, 769, 730 and 701 cm^{-1} ; δ_H (300 MHz, $CDCl_3$) 1.25 (3H, d, $J=6.5$ Hz, Me), 1.80–2.00 (3H, m, 3-H, 9eq-H), 2.29 (1H, dddt, $J=18$, 9, 6, 3 Hz, 9ax-H), 3.76 (1H, dd, $J=12$, 6 Hz, 8eq-H), 4.02 (1H, dt, $J=12$, 3.5 Hz, 8ax-H), 4.00–4.15 (1H, m, 2-H), 5.59 (2H, br d, $J=10$ Hz, 5-H, 11-H), 5.99 (2H, m, 4-H, 10-H); δ_C (75 MHz, $CDCl_3$) 21.29 (Me), 24.53 (C-9), 31.95 (C-3), 58.25 (C-2), 64.01 (C-8), 92.07 (C-6), 128.27, 128.35, 128.54, 129.11 (C-4, C-5, C-10, C-11); m/z (CI) 167 {[$M+H$]⁺, 72.2%}. Found: m/z 166.0993. $C_{10}H_{14}O_2$ [M^+] requires m/z 166.0994.

4.1.22. (\pm)-1,7-Dioxaspiro[5.5]undec-4,10-diene, 15.¹⁶

The title compound was prepared from the selenide **14** (532 mg, 1.71 mmol) using the method described above. Flash chromatography (1:1 dichloromethane/petrol) afforded the title compound as a yellow oil (161 mg, 62%); ν_{\max} (film) 3041, 2965, 2933, 2878, 2830, 1654, 1463, 1426, 1395, 1368, 1335, 1271, 1201, 1185, 1157, 1119, 1075, 1023, 901, 862, 778, 735 and 705 cm^{-1} ; δ_{H} (300 MHz, C_6D_6) 1.50 (2H, ddd, $J=18, 5, 3$ Hz, 9eq-H, 3eq-H), 2.10 (2H, dddt, $J=18, 12, 6, 2$ Hz, 3ax-H, 9ax-H), 3.67 (2H, dd, $J=10, 6$ Hz, 2eq-H, 8eq-H), 4.07 (2H, dt, $J=11, 3.5$ Hz, 2ax-H, 8ax-H), 5.75 (2H, dd, $J=10, 3$ Hz, 5-H, 11-H), 5.82 (2H, dd, $J=10, 5$ Hz, 4-H, 10-H); δ_{C} (75 MHz, C_6D_6) 24.81 (C-3, C-9), 58.33 (C-2, C-8), 91.36 (C-6), 127.82 (C-4, C-10), 130.08 (C-5, C-11); m/z (EI) 152 [M^+ , 35.5%]. Found: m/z 152.0834. $\text{C}_9\text{H}_{12}\text{O}_2$ [M^+] requires m/z 152.0837.

4.1.23. (Z,E)-4-[(2R*)-2-(*t*-Butyldiphenylsilyloxymethyl)-3,4-dihydro-2H-6-pyranil]-3-buten-1-ol, 19.

Method A. A solution of *t*-butyllithium (20.6 mL, 1.7 M solution in pentane) was added dropwise to a stirred solution of 2-(*t*-butyldiphenylsilyloxymethyl)-3,4-dihydro-2H-pyran **16** (5.61 g, 15.94 mmol) in THF (8 mL) at -78°C . The mixture was allowed to warm up to 0°C and was stirred at this temperature for 2 h, then recooled to -78°C (excess *t*-butyllithium was destroyed by adding more THF [30 mL]). Zinc chloride (1 M solution in ether, 16.9 mL) was added dropwise and the resulting mixture was allowed to warm up to room temperature and to stir for 2 h. In a separate flask, Dibal-H (1 M solution in toluene, 0.4 mL) was added dropwise to $\text{PdCl}_2(\text{PPh}_3)_2$ (133 mg, 0.19 mmol, 5 mol%) in THF (5 mL) at 0°C and the resulting mixture was stirred for 30 min. The solution containing the Pd(0) catalyst was then added to the vinyl zinc at 5 – 10°C , followed by a solution of (Z,E)-4-hydroxy-1-iodobut-1-ene **8** (0.69 g, 3.48 mmol) in THF (2 mL) and resulting mixture was stirred for 1 h at 0°C . After quenching with sodium hydroxide (10 mL), the product was extracted into ether (3×30 mL), the ethereal extracts dried (MgSO_4), concentrated in vacuo. The residue was chromatographed (3:1:16 ethyl acetate/triethylamine/petrol) to afford the title compound **19** (1.08 g, 72%; mobile oil) as an inseparable mixture of geometrical isomers (Z:E=8:1)

Method B. The title compound **19** was prepared from (Z,E)-4-hydroxy-1-iodobut-1-ene **8** (0.75 g, 3.79 mmol) in exactly the same way as method A except that freshly prepared $\text{Pd}(\text{PPh}_3)_4$ (213 mg, 5 mol%) was used as the catalyst. Work-up and chromatography (3:1:16 ethyl acetate/triethylamine/petrol) afforded the title compound (1.06 g, 70%, colourless oil), as a mixture of geometrical isomers (Z:E=8:1); ν_{\max} (film) 3385, 2930, 2857, 1655, 1613, 1590, 1472, 1428, 1112, 1068, 1006, 824, 789, 741 and 703 cm^{-1} ; δ_{H} (300 MHz, C_6D_6) Z-isomer: 1.25 (9H, s, ^tBuSi), 1.49–1.58 (2H, m, 3-H), 1.85–1.95 (2H, m, 4-H), 2.90 (2H, q, $J=7$ Hz, 3'-H), 3.66 (2H, t, $J=6$ Hz, 1'-H), 3.77 (1H, dd, $J=10, 4.5$ Hz, CH_2OSi), 3.80–3.90 (1H, m, CH_2OSi), 3.88–4.00 (1H, m, 2-H), 4.72 (1H, t, $J=4$ Hz, 5-H), 5.50 (1H, dt, $J=12, 8$ Hz, 2'-H), 5.85 (1H, d, $J=12$ Hz, 1'-H), 7.30–8.00 (10H, m, Ar); E-isomer: 1.27 (9H, s, ^tBuSi), 1.40–1.6 (2H, m, 3-H), 1.61–1.81 (2H, m, 4-H), 2.30 (2H, q, $J=7$ Hz, 2'-H), 3.50–3.58 (2H, m, 1'-H), 3.77 (1H, dd, $J=10, 4.5$ Hz,

CH_2OSi), 3.80–3.90 (1H, m, CH_2OSi), 3.90–4.00 (1H, m, 2-H), 4.68 (1H, t, $J=4$ Hz, 5-H), 5.91 (1H, d, $J=15.5$ Hz, 4'-H), 6.25 (1H, dt, $J=15.5, 7.5$ Hz, 3'-H), 7.30–8.00 (10H, m, Ar); δ_{C} (75 MHz, C_6D_6) Z-isomer: 19.45 or 19.51 (CMe_3), 20.75 (C-4), 23.84 (C-3), 26.95 or 27.03 (CMe_3), 33.13 (C-2'), 62.54 (C-1'), 66.69 (CH_2OSi), 76.12 (C-2), 102.64 (C-5), 126.76 (C-3'), 127.80 (C-4'), 128.06, 128.09, 130.01, 133.83, 135.97, 136.01 (Ar), 152.63 (C-6); E-isomer: 19.45 or 19.51 (CMe_3), 20.75 (C-4), 24.34 (C-3), 26.95 or 27.03 (CMe_3), 36.44 (C-2'), 62.05 (C-1'), 66.69 (CH_2OSi), 75.97, (C-6), 100.97 (C-5), 125.18 (C-3'), 126.76 (C-4'), 128.06, 128.09, 130.01, 133.83, 135.97, 136.01 (Ar), 151.14 (C-6); m/z (CI) 345 {[M^+ –Ph], 100%}. Found: m/z (CI) 423.2358. $\text{C}_{26}\text{H}_{35}\text{O}_3^{28}\text{Si}$ {[M^+ –H]⁺} requires m/z 423.2355.

4.1.24. (2R*,6S*)-2-(*t*-Butyldiphenylsilyloxymethyl)-1,7-dioxaspiro[5.5]undec-10-ene, 20.

The title compound was prepared from the diene **19** (0.908 g, 2.15 mmol) using the method described above for **32**. Isolated as a colourless, viscous oil after flash chromatography (1:99 ethyl acetate/petrol); yield 0.53 g, (58%); ν_{\max} (film) 3071, 3046, 2933, 2858, 1657, 1590, 1473, 1428, 1361, 1273, 1206, 113, 1079, 1029, 998, 958, 919, 904, 889, 862, 824, 805, 739 and 704 cm^{-1} ; δ_{H} (300 MHz, CDCl_3) 1.13 (9H, s, ^tBuSi), 1.28 (1H, dq, $J=12, 3.5$ Hz, 3ax-H), 1.58 (1H, dt, $J=13, 5$ Hz, 5eq-H), 1.65–2.05 (4H, m, 4-H, 9eq-H, 3eq-H, 5ax-H), 2.35 (1H, dddt, $J=18, 9, 5.5, 2.5$ Hz, 9ax-H), 3.62 (1H, dd, $J=10, 6$ Hz, CH_2OSi), 3.70–3.85 (2H, m, CH_2OSi , 8eq-H), 3.90–4.05 (2H, m, 8ax-H, 2ax-H), 5.67 (1H, br d, $J=10$ Hz, 11-H), 5.99 (1H, br dt, $J=10, 5$ Hz, 10-H), 7.30–7.80 (10H, m, Ar); δ_{C} (75 MHz, CDCl_3) 18.54 (C-4), 19.33 (CMe_3), 24.80 (C-9), 26.82 (CMe_3), 27.13 (C-3), 34.67 (C-5), 57.58 (C-8), 67.72 (CH_2OSi), 70.57 (C-2), 93.43 (C-6), 127.58 (Ar), 129.54 (C-10), 130.89 (Ar), 133.93 (C-11), 135.67, 135.75 (Ar); m/z (CI) 423 {[M^+ –H]⁺, 67%} (EI) 365 {[M^+ –^tBu]⁺, 58.6%}. Found: (CI) m/z 423.2339 {[M^+ –H]⁺}. $\text{C}_{26}\text{H}_{35}\text{O}_3\text{Si}$ requires m/z 423.2355.

4.1.25. (2R*,6R*)-2-(*t*-Butyldiphenylsilyloxymethyl)-1,7-dioxaspiro[5.5]undecane, 21.

The title compound **21** was prepared from the spiroketal **20** (369 mg, 0.87 mmol) using the method above. Isolated after flash chromatography (1:99 ethyl acetate/petrol) as a colourless, viscous oil (345 mg, 94%); ν_{\max} (film) 2937, 2858, 1428, 1386, 1280, 1229, 1211, 1112, 1086, 994, 951, 932, 875, 824, 800, 739 and 702 cm^{-1} ; δ_{H} (300 MHz, CDCl_3) 1.13 (9H, s, ^tBuSi), 1.20–1.70 (10H, m, 3-H, 4-H, 5-H, 9-H, 10-H, 11-H), 1.83–2.10 (2H, m, 9-H, 10-H), 3.64 (1H, dd, $J=10, 5$ Hz, CH_2OSi), 3.58–3.67 (1H, m, 8-H), 3.75 (1H, dd, $J=10, 6$ Hz, CH_2OSi), 3.80–3.90 (2H, m, 2-H, 8-H) 7.4–7.85 (10H, m, Ar); δ_{C} (75 MHz, CDCl_3) 18.55 (C-4, C-10), 19.27 (CMe_3), 25.39 (C-3), 26.61 (CMe_3), 27.18 (C-9), 35.45, 35.78, (C-5, C-11), 60.25 (CH_2OSi), 67.55 (C-8), 70.15 (C-2), 95.50 (C-6), 127.60, 129.52, 129.55, 133.96, 135.69, 135.73, (Ar); m/z (CI) 442 {[M^+ – NH_4]⁺, 100%}. Found: m/z 425.2516. $\text{C}_{26}\text{H}_{37}\text{O}_3^{28}\text{Si}$ {[M^+ –H]⁺} requires m/z 425.2512.

4.1.26. (2R*,6R*)-2-(Hydroxymethyl)-1,7-dioxaspiro[5.5]-undecane, 22.¹⁸ To a solution of the TBDPS-protected alcohol **21** (275 mg, 0.65 mmol) under nitrogen in THF (10 mL) at ambient temperature was added TBAF (1 M in THF, 1.3 mL) and the resulting pale green solution

was stirred at this temperature for 16 h. Ether (30 mL) was added and the organic solution was washed with saturated aqueous ammonium chloride (2 × 15 mL) and brine (1 × 15 mL), then dried (MgSO₄), and concentrated in vacuo. Flash chromatography (2:3 ethyl acetate/petrol) of the residue afforded the title compound **22** (105 mg, 87%) as a colourless, viscous oil; ν_{\max} (film) 3425, 2941, 2871, 1440, 1384, 1281, 1228, 1210, 1182, 1094, 1077, 1049, 1022, 992, 951, 928, 894, 875 and 808 cm⁻¹; δ_{H} (300 MHz, CDCl₃) 1.20–1.70 (10H, m, 3-H, 4-H, 5-H, 9-H, 10-H, 11-H), 1.78–2.00 (2H, m, 9-H, 10-H), 2.10 (1H, br s, OH), 3.54 (1H, dd, $J=11$, 7 Hz, CH₂OH), 3.65 (1H, dt, $J=11$, 3 Hz, 8ax-H), 3.60–3.70 (2H, m, CH₂OH and 8eq-H), 3.73–3.83 (1H, m, 2-H); δ_{C} (75 MHz, CDCl₃) 18.18, 18.61 (C-4, C-10), 25.21 (C-3), 26.46 (C-9), 35.42, 35.59 (C-5, C-11), 60.43 (CH₂OH), 66.31 (C-8), 69.67 (C-2), 95.51 (C-6); m/z (CI) 187 [[M+H]⁺, 100%]. Found: m/z 186.1252. C₁₀H₁₈O₃ [M⁺] requires m/z 186.1256.

4.1.27. (2R*,5S*,6R*)-2-(*t*-Butyldiphenylsilyloxy-methyl)-5-phenylselenyl-1,7-dioxaspiro[5.5]undec-10-ene, **23 and (2R*,5R*,6R*)-2-(*t*-butyldiphenylsilyloxy-methyl)-5-phenylselenyl-1,7-dioxaspiro[5.5]undec-10-ene, **24**.** The title compounds were prepared from the diene **19** (0.94 g, 2.23 mmol) using the standard cyclisation procedure. Isolated as a 2:1 (**23:24**) mixture of diastereoisomers (0.74 g, 57%) after flash chromatography (1:99 ethyl acetate/petrol); ν_{\max} (film) 3071, 3049, 2997, 2931, 2857, 1657, 1579, 1475, 1428, 1392, 1361, 1339, 1300, 1271, 1235, 1210, 1189, 1113, 1079, 999, 909, 824, 739 and 705 cm⁻¹; δ_{H} (300 MHz, CDCl₃): 1.18 (6H, s, ^tBuSi, eq. isomer, **23**), 1.21 (3H, s, ^tBuSi, ax. isomer, **24**), 1.70–1.80 (2/3H, m), 1.80–2.04 (2H, m), 2.04–2.22 (1H, m), 2.22–2.60 (2H, m), 2.62–2.78 (1/3H, m), 3.24 (2/3H, dd, $J=12.5$, 4.5 Hz, 5-H), 3.46 (1/3H, br s, 5-H), 3.60–4.20 (5H, m, 2-H, 8-H, CH₂OSi), 5.80 (2/3H, d, $J=10$ Hz, 11-H), 6.02–6.10 (1/3H, m, 10-H), 6.12–6.20 (2/3H, m, 10-H), 6.49 (1/3H, d, $J=10$ Hz, 11-H), 7.25–7.85 (15H, m, Ar); δ_{C} (75 MHz, CDCl₃) Equatorial isomer, **23**: 19.37 (CMe₃), 24.62 (C-3), 26.97 (CMe₃), 28.37 (C-9), 29.65 (C-10), 49.37 (C-11), 58.09 (C-2), 67.33 (CH₂OSi), 70.27 (C-8), 95.39 (C-6), 127.80 (Ar), 128.92 (C-4), 129.01, 129.11, 129.66 (Ar), 129.84 (C-6), 133.17, 134.51, 135.81 (Ar); Axial isomer, **24**: 19.41 (CMe₃), 23.73 (C-9), 26.16 (C-9), 26.89 (C-4), 26.97 (CMe₃), 50.16 (C-5), 58.44 (C-8), 67.48 (CH₂OSi), 70.53 (C-2), 95.02 (C-6), 127.80 (Ar), 128.59 (C-10), 129.01, 129.11, 129.66 (Ar), 129.92 (C-11), 133.92, 133.17, 134.51, 135.81 (Ar); m/z FAB 579 [[M+H]⁺, 4.2%]. Found: m/z 579.1856. C₃₂H₃₉O₃Se²⁸Si [[M+H]⁺] requires 579.1834.

4.1.28. (2R*,6R*)-2-(*t*-Butyldiphenylsilyloxymethyl)-1,7-dioxaspiro[5.5]undec-4,10-diene, **25.** The title compound was prepared from the diastereomeric mixture of selenides **23** and **24** (503 mg, 0.87 mmol). Isolated as a single isomer, a pale yellow oil, (265 mg, 73%) after flash chromatography (1:99 ethyl acetate/petrol); ν_{\max} (film) 3044, 2930, 2857, 1657, 1473, 1428, 1389, 1201, 1113, 1077, 1020, 908, 824, 796, 740 and 702 cm⁻¹; δ_{H} (300 MHz, CDCl₃): 1.10 (9H, s, ^tBuSi), 1.90 (1H, dt, $J=18$, 4.5 Hz, 9eq-H), 2.00–2.10 (2H, m, 3-H), 2.35 (1H, dddt, $J=18$, 9, 5.5, 3 Hz, 9ax-H), 3.70 (1H, dd, $J=10$, 5.5 Hz, CH₂OSi), 3.80 (1H, dd, $J=11$, 6 Hz, 8eq-H), 3.87 (1H, dd, $J=10$, 5 Hz, CH₂OSi), 4.10

(1H, dt, $J=12$, 3.5 Hz, 8ax-H), 4.20 (1H, dq, $J=10$, 5 Hz, 2-H), 5.60–5.70 (2H, m, 5-H, 11-H), 6.12–6.22 (2H, m, 4-H, 10-H), 7.30–7.80 (10H, m, Ar); δ_{C} (75 MHz, CDCl₃) 19.03 (CMe₃), 24.53 (C-9), 26.64 (CMe₃), 27.08 (C-3), 58.32 (C-8), 66.90 (CH₂OSi), 68.66 (C-2), 91.89 (C-6), 127.61, 127.72, 127.80 (Ar), 127.88, 128.15 (C-4, C-10), 128.24, 128.71 (C-5, C-11), 129.57, 129.60, 133.72, 135.50, 135.62, 135.69, 135.76; m/z (EI) 362 [M+^tBu, 61%] (CI) 421 [[M+H]⁺, 100%]. Found: (CI) m/z 421.2185. C₂₆H₃₃O₃Si²⁸Si [[M+H]⁺] requires m/z 421.2200.

4.1.29. Ethyl (2R*,3R*)-3-(*t*-butyldimethylsilyloxy)-2-methylbutanoate, **39.**³⁰ To a solution of ethyl (2R*,3R*)-3-hydroxy-2-methylbutanoate **38** (9.95 g, 68.1 mmol) in dichloromethane (10 mL) was added 1,8-diazobicyclo[5.4.0]undec-7-ene (10.2 mL, 65.6 mmol) at 0 °C followed by *t*-butyldimethylsilyl chloride (9.89 g, 65.6 mmol) in dichloromethane (10 mL). After 3 h at room temperature the mixture was poured into water (100 mL), extracted into ether (100 mL) and washed with water (50 mL), hydrochloric acid (0.1 M, 50 mL), water (50 mL), saturated sodium bicarbonate (50 mL) and water (50 mL). The organic layer was dried (MgSO₄), concentrated in vacuo, and the residue was purified by flash column chromatography (1:19 ethyl acetate petrol) to afford the title compound **39** (14.02 g, 87%) as a colourless oil; ν_{\max} (film) 2958, 2931, 2858, 1737, 1474, 1376, 1320, 1256, 1185, 1113, 1068, 1039, 982, 953, 839, 811 and 776 cm⁻¹; δ_{H} (300 MHz, CDCl₃): 0.06 (3H, s, CH₃Si), 0.09 (3H, s, CH₃Si), 0.90 (9H, s, CH₃CSi), 1.11 (3H, d, $J=7$ Hz, C2-Me), 1.16 (3H, d, $J=6$ Hz, H-4), 1.25 (3H, t, $J=7$ Hz, OCH₂CH₃), 2.51 (1H, quintet $J=7$ Hz, H-2), 3.95–4.15 (1H, m, H-3), 4.13 (2H, q, $J=7$ Hz, OCH₂); δ_{C} (75 MHz) –5.12, –4.32, 12.68, 14.19, 17.92, 20.24, 25.72, 48.15, 60.12, 70.15, 175.15; m/z (CI) 261 [M+H]⁺, 100%, 203 [M⁺ – ^tBu, 20%]. Found: (CI) m/z 261.1884. C₁₃H₂₉O₃Si²⁸Si [[M+H]⁺] requires m/z 261.1886.

4.1.30. (1ZE,3S*,4R*)-4-(*t*-Butyldimethylsilyloxy)-1-iodo-3-methylpentene, **41.** Dibal-H (1 M in toluene, 15.7 mL, 15.7 mmol) was added dropwise to a cooled (–78 °C) and stirred solution of ethyl (2R*,3R*)-3-(*t*-butyldimethylsilyloxy)-2-methylbutanoate **39** (2.42 g, 9.83 mmol) in anhydrous toluene (100 mL). After being stirred at –80 °C for 1 h the reaction was quenched by dropwise addition of methanol (10 mL) keeping the temperature below –78 °C. Citric acid (10% aqueous solution, 80 mL) was then added, the mixture was allowed to warm to room temperature, the organic phase was decanted and the aqueous layer was extracted with dichloromethane (3 × 100 mL). The combined organic phases were dried (MgSO₄), the solvent was removed under vacuum. The crude aldehyde **40**³⁰ { δ_{H} (300 MHz, CDCl₃): 0.04 (3H, s, CH₃Si), 0.05 (3H, s, CH₃Si), 0.90 (9H, s, CH₃CSi); 1.10 (3H, d, $J=7.5$ Hz, C2-Me), 1.25 (3H, d, $J=6$ Hz, 4-H), 2.30–2.40 (1H, m, H-2); 4.05 (1H, quintet, $J=6$ Hz, H-3), 9.85 (1H, d, $J=2.5$ Hz, H-1)} was used immediately in the next reaction.

To a suspension of iodomethyltriphenylphosphonium iodide (6.51 g, 12.3 mmol) in THF (27 mL) at room temperature was slowly added sodium hexamethyldisilazide (1 M solution in THF, 11.3 mL). After stirring for 10 min, the

dark-coloured solution of the yield was cooled to $-78\text{ }^{\circ}\text{C}$ and crude ($2R^*,3R^*$)-3-(*t*-butyldimethylsilyloxy)-2-methylbutanal **40** in THF (10 mL) was added slowly. The mixture was allowed to warm to room temperature and after 30 min, the solvent was removed in vacuo. The residue was washed with $3\times(50\text{ mL } 50:1\text{ petrol/diethyl ether})$ and the supernatant filtered through celite[®] to remove triphenylphosphine oxide. The combined eluents were concentrated in vacuo and the residue purified by flash column chromatography (dichloromethane/hexane 1:19) to afford the title compound **41** as a light sensitive, colourless, oil³⁸ (1.38 g, 41% overall yield from **39**; *E:Z*=6:1). *Z*-isomer; ν_{max} (film) 2957, 2927, 2885, 2857, 1608, 1472, 1462, 1375, 1259, 1152, 1086, 1064, 1027, 1007, 956, 850, 837, 802, 775, 745, 699 and 665 cm^{-1} ; δ_{H} (300 MHz, CDCl_3): 0.10 (3H, s, CH_3Si), 0.11 (3H, s, CH_3Si), 0.93 (9H, s, CH_3CSi), 1.05 (3H, d, $J=7\text{ Hz}$, C3–Me), 1.12 (3H, d, $J=6.5\text{ Hz}$, 5-H), 2.50–2.56 (1H, m, 3-H), 3.80–3.88 (1H, m, 4-H), 6.15 (1H, dd, $J=9, 7.5\text{ Hz}$, 2-H), 6.25 (1H, d, $J=7\text{ Hz}$, 1-H); δ_{C} (75 MHz; CDCl_3): $-4.75, -4.23, 15.76, 18.07, 21.45, 25.87, 49.65, 70.87, 81.90, 143.41$; m/z (CI) 341 $[[\text{M}+\text{H}]^+, 34\%]$. Found: m/z (CI) 341.0804. $\text{C}_{12}\text{H}_{25}\text{IO}^{28}\text{Si}$ $[[\text{M}+\text{H}]^+]$ requires m/z 341.0798. *E*-isomer ν_{max} (film) 2957, 2929, 2885, 2857, 1603, 1552, 1472, 1462, 1374, 1361, 1253, 1188, 1157, 1128, 1102, 1064, 1029, 1007, 988, 956, 837, 806, 775 and 663 cm^{-1} ; δ_{H} (300 MHz, CDCl_3): 0.10 (6H, s, CH_3Si), 0.95 (9H, s, CH_3CSi), 1.02 (3H, d, $J=6.5\text{ Hz}$, C3–Me), 1.11 (3H, d, $J=6\text{ Hz}$, 5-H), 2.15–2.25 (1H, m, 3-H), 3.65–3.72 (1H, m, 4-H), 6.02 (1H, dd, $J=14.5, 0.5\text{ Hz}$, H-1), 6.52 (1H, dd, $J=14.5, 8.5\text{ Hz}$, H-2); δ_{C} (75 MHz, CDCl_3): $-4.78, -4.35, 15.69, 18.07, 21.24, 25.86, 48.37, 71.23, 74.73, 149.04$; m/z (CI) 341 $[[\text{M}+\text{H}]^+, 36\%]$. Found: m/z (CI) 341.0807. $\text{C}_{12}\text{H}_{25}\text{IO}^{28}\text{Si}$ $[[\text{M}+\text{H}]^+]$ requires m/z 341.0798.

4.1.31. ($2R^*,3S^*,4Z$)-5-Iodo-3-methyl-4-penten-2-ol, 42. To a solution of (*1ZE,3S^*,4R^**)-4-(*t*-butyldimethylsilyloxy)-3-methyl-1-iodopentene **41** (1.29 g, 3.79 mmol) in acetonitrile (67 mL) was added 60% aqueous hydrogen fluoride (2.25 mL). The mixture was stirred for 10 min at ambient temperature after which time the reaction mixture was diluted with water (50 mL) and extracted with chloroform ($2\times 50\text{ mL}$). The combined organic extracts were dried (MgSO_4), concentrated in vacuo and the residue purified by flash column chromatography (1:4 ethyl acetate/petrol) to afford the title compound **42** (0.66 g, 77%) as a light sensitive, colourless, oil³⁸; ν_{max} (film) 3376, 3064, 2969, 2929, 1609, 1452, 1376, 1352, 1262, 1200, 1152, 1112, 1085, 1045, 1015, 995, 929, 886, 797 and 702 cm^{-1} ; δ_{H} (300 MHz, CDCl_3): 1.08 (3H, d, $J=7\text{ Hz}$, 3'-H), 1.24 (3H, d, $J=6.5\text{ Hz}$, 1-H), 2.42–2.56 (1H, m, 3-H), 3.81 (1H, quintet, $J=6\text{ Hz}$, 2-H), 6.15 (1H, dd, $J=9, 7\text{ Hz}$, 4-H), 6.36 (1H, d, $J=7.5\text{ Hz}$, 5-H); δ_{C} (75 MHz, CDCl_3): 15.65, 20.85, 46.70, 70.90, 83.35, 142.86. m/z (CI) 244 $[[\text{M}+\text{NH}_4]^+, 100\%]$. Found: m/z (CI) 244.0204. $\text{C}_6\text{H}_{15}\text{INO}$ $[[\text{M}+\text{NH}_4]^+]$ requires m/z 244.0198.

4.1.32. ($2R^*,3S^*,4Z$)-5'-(3',4'-Dihydro-2H-6-pyranyl)-3-methyl-4-penten-2-ol, 43. A solution of *t*-butyllithium (5.8 mL, 1.7 M solution in pentane) was added dropwise to a stirred solution of 2,3-dihydro-2H-pyran (0.8 mL, 9.36 mmol) in THF (5 mL) at $-78\text{ }^{\circ}\text{C}$. The mixture was allowed to warm up to $0\text{ }^{\circ}\text{C}$ and was stirred at this

temperature for 30 min, then re-cooled to $-78\text{ }^{\circ}\text{C}$. Zinc chloride (1 M solution in ether, 9.8 mL) was added dropwise and the resulting mixture was allowed to warm up to room temperature and to stir for 2 h, generating a stock solution of the zinc reagent **11**. A solution of ($2R^*,3S^*,4Z$)-5-iodo-3-methyl-4-penten-2-ol **42** (500 mg, 1.17 mmol) and $\text{Pd}(\text{PPh}_3)_4$ (127 mg, 5 mol%) in THF (5 mL) was added to the vinylzinc **11** at $5\text{--}10\text{ }^{\circ}\text{C}$, and resulting mixture was stirred for 1 h. After quenching with sodium hydroxide (10 mL), the product was extracted with ether ($3\times 30\text{ mL}$), the ethereal extracts dried (MgSO_4), concentrated in vacuo, and the residue was purified by flash column chromatography (3:1:16 ethyl acetate/triethylamine/petrol) to afford the title compound **43** as a colourless oil (290 mg, 72%); ν_{max} (film) 3412, 2969, 2930, 2874, 1723, 1656, 1610, 1450, 1394, 1375, 1353, 1311, 1274, 1234, 1153, 1086, 1060, 999, 972, 936, 893, 862 and 787 cm^{-1} ; δ_{H} (200 MHz, C_6D_6) 1.03 (3H, d, $J=6\text{ Hz}$, C-3' Me), 1.18 (3H, d, $J=6\text{ Hz}$, H-1'), 1.35 (2H, apparent quintet, $J=6\text{ Hz}$, 3-H), 1.76–1.90 (2H, m, 4-H), 3.30–3.50 (1H, m, 3'-H), 3.45–3.55 (1H, m, 2'-H), 3.68 (2H, t, $J=6\text{ Hz}$, 2-H), 4.66 (1H, t, $J=4\text{ Hz}$, 5-H), 5.15–5.30 (1H, m, 4'-H), 5.75 (1H, d, $J=12\text{ Hz}$, 5'-H); m/z (CI) 183 $[[\text{M}+\text{H}]^+, 100\%]$. Found m/z (CI) 182.1301. $\text{C}_{11}\text{H}_{18}\text{O}_2$ $[[\text{M}^+]$ requires m/z 182.1307.

4.1.33. ($2R^*,3S^*,6S^*$)-2,3-Dimethyl-1,7-dioxaspiro[5.5]undec-4-ene, 44. To a solution of ($2R^*,3S^*,4Z$)-5-(3,4-dihydro-2H-6-pyranyl)-3-methyl-4-penten-2-ol **43** (247 mg, 1.35 mmol) in dichloromethane (5 mL) was added camphorsulfonic acid (30 mg) and the mixture stirred at room temperature for 1 h. After quenching with saturated sodium bicarbonate (15 mL), the reaction mixture was extracted with ether ($2\times 20\text{ mL}$), the ethereal extracts dried (MgSO_4), and evaporated and the residue purified by flash column chromatography (ethyl acetate/petrol 1:19) to afford the title compound **44** (105 mg, 42%) as a colourless oil; ν_{max} (film) 3034, 2939, 2872, 1657, 1450, 1398, 1378, 1269, 1225, 1204, 1186, 1169, 1106, 1091, 1074, 1055, 1002, 954, 923, 896, 813 and 723 cm^{-1} ; δ_{H} (300 MHz, CDCl_3): 0.92 (3H, d, $J=6\text{ Hz}$, Me) 1.23 (3H, d, $J=6.5\text{ Hz}$, Me), 1.45–1.65 (5H, m, 10-H, 11-H, 9ax-H), 1.80–2.00 (2H, m, 3-H, 9eq-H), 3.50–3.61 (2H, m, 8eq-H, 2-H), 3.80 (1H, dt, $J=11, 3\text{ Hz}$, 8ax-H), 5.54 (1H, dd, $J=10, 2\text{ Hz}$, 5-H) 5.64 (1H, dd, $J=10, 1.5\text{ Hz}$, 4-H); δ_{C} (75 MHz, CDCl_3) 16.73, 18.52, 19.14, 25.13, 34.88, 36.22, 60.75, 69.46, 93.59, 129.39, 134.42; m/z (CI) 182 $[[\text{M}^+, 100\%]$. Found: m/z (CI) 183.1386. $\text{C}_{11}\text{H}_{19}\text{O}_2$ $[[\text{M}+\text{H}]^+]$ requires m/z 183.1386.

4.1.34. ($2R^*,3S^*,4Z$)-3,7-Dimethyl-4-octen-2-ol, 45. Dibal-H (2.5 mL of a 1 M solution in toluene) was added to the vinyl iodide **42** (570 mg, 2.5 mmol) at $-78\text{ }^{\circ}\text{C}$ and then allowed to warm up to room temperature. This solution was then added, via cannula, to a mixture of the zinc reagent **11** (2.5 mmol) and $\text{Pd}(\text{PPh}_3)_4$ (5 mol%) in THF. After 1 h at $5\text{ }^{\circ}\text{C}$ work-up and chromatography as above afforded the title compound **45** as a colourless oil (75 mg, 19%); ν_{max} (film) 3363, 2958, 2871, 1465, 1368, 1164, 1091, 1044, 1014, 924, 877, 831 and 792 cm^{-1} ; δ_{H} (300 MHz, CDCl_3): 0.95–1.10 (9H, m, $3\times\text{Me}$), 1.22 (3H, d, $J=7\text{ Hz}$, Me), 1.65 (1H, apparent septet, $J=6.5\text{ Hz}$, 7-H), 1.82 (1H, br d s, OH), 2.00–2.20 (2H, m, 6-H), 2.45–2.60 (1H, m, 3-H), 3.52 (1H, quintet, $J=6.5\text{ Hz}$, 2-H), 5.28–5.40 (1H, m, 4-H), 5.59 (1H, dt, $J=11, 7\text{ Hz}$, 5-H); δ_{C} (50 MHz, CDCl_3) 16.9, 20.0, 22.1,

22.5, 28.6, 36.8, 39.9, 71.6, 131.3, 132.4; m/z (CI) 156 [M^+ , 38%], 174 [$[M+NH_4]^+$, 100%]. Found: m/z (CI) 174.1855. $C_{10}H_{24}NO$ [$[M+NH_4]^+$] requires m/z 174.1858.

Acknowledgements

We thank Syngenta and the EPSRC for support of this work.

References and notes

- MacLeod, D.; Moorcroft, D.; Quayle, P.; Dorrity, M. R. J.; Malone, J. F.; Davies, G. M. *Tetrahedron Lett.* **1990**, *31*, 6077–6080. Abas, A.; Beddoes, R. L.; Conway, J. C.; Quayle, P.; Urch, C. J. *Synlett* **1995**, 1264–1266.
- e.g. Dubois, E.; Beau, J.-M. *Carb. Res.* **1992**, *228*, 103–120. Friesen, R. W.; Loo, R. W.; Sturino, C. F. *Can. J. Chem.* **1994**, *72*, 1262–1272. Parker, K. A.; Coburn, C. A. *J. Am. Chem. Soc.* **1991**, *113*, 8516–8518. Zhang, H. C.; Brakta, M.; Daves, G. D. *Tetrahedron Lett.* **1993**, *34*, 1571–1574. Mahmoud, S. H.; Somsak, L.; Farkas, I. *Carb. Res.* **1994**, *254*, 91–104. Jeanneret, V.; Meerpoel, L.; Vogel, P. *Tetrahedron Lett.* **1997**, *38*, 543–546. Kang, S. K.; Namkoong, E. Y.; Yamaguchi, T. *Synth. Commun.* **1997**, *27*, 641–656. Nicolaou, K. C.; Shi, G.-Q.; Gunzner, J. L.; Gärtner, P.; Yang, Z. *J. Am. Chem. Soc.* **1997**, *119*, 5467–5468. Brimble, M. A.; Chan, S. H. *Aust. J. Chem.* **1998**, *51*, 235–242. Steunenberg, P.; Jeanneret, V.; Zu, Y.-H.; Vogel, P. *Tetrahedron: Asymmetry* **2005**, *16*, 337. Nicolaou, K. C.; Koftis, T. V.; Vyskocil, S.; Petrovic, G.; Ling, T.; Yamada, Y. M. A.; Tang, W.; Frederick, M. O. *Angew. Chem., Int. Ed.* **2004**, *43*, 4318. von Zezschitz, P.; Petry, F.; de Meijere, A. *Chem. Eur. J.* **2001**, *7*, 4035–4046. For an appraisal of methodological limitations see: Gunn, A.; Jarowicki, K.; Kocienski, P.; Lockhart, S. *Synthesis* **2001**, 331–338. For the related coupling reactions of 1-iodoglucals see: Steunenberg, J. V.; Jeanneret, V.; Zu, Y.-H.; Vogel, P. *Tetrahedron: Asymmetry* **2005**, *16*, 337–346. Potuzak, J. S.; Tan, D. S. *Tetrahedron Lett.* **2004**, *45*, 1797–1801. Friesen, R. W.; Loo, R. W. *J. Org. Chem.* **1991**, *56*, 4821–4823 and. Tius, M. A.; Gomez-Galeno, J.; Xue, Q.; Zaidi, J. H. *J. Am. Chem. Soc.* **1991**, *113*, 5775–5783.
- (a) Dubois, E.; Beau, J.-M. *Tetrahedron Lett.* **1990**, *31*, 5165–5168. Friesen, R. W.; Sturino, C. F. *J. Org. Chem.* **1990**, *55*, 5808–5810. Dubois, E.; Beau, J. M. *Carbohydr. Res.* **1992**, *223*, 157–167. (b) Elsley, D. A.; MacLeod, D.; Miller, J. A.; Quayle, P.; Davies, G. M. *Tetrahedron Lett.* **1992**, *33*, 409–412.
- (a) Mead, K. T.; Brewer, B. N. *Curr. Org. Chem.* **2003**, *7*, 227–256. Francke, W.; Kitching, W. *Curr. Org. Chem.* **2001**, *5*, 233–251. Fletcher, M. T.; Kitching, W. *Chem. Rev.* **1995**, *95*, 789–828. (b) For representative examples see: Panek, J. S.; Jain, N. F. *J. Org. Chem.* **2001**, *66*, 2747–2756. Cuzzupe, A. N.; Hutton, C. A.; Lilly, M. J.; Mann, R. K.; McRae, K. J.; Zammit, S. C.; Rizzacasa, M. A. *J. Org. Chem.* **2001**, *66*, 2382–2391. Jia, Y. X.; Wu, B.; Li, X.; Ren, S. K.; Tu, Y. Q.; Chan, A. S.; Kitching, W. *Org. Lett.* **2001**, *3*, 847–849.
- Stork, G.; Zhao, K. *Tetrahedron Lett.* **1989**, *30*, 2173–2174. For a contemporaneous report see: Bestmann, H. J.; Rippel, H. C.; Dostalek, R. *Tetrahedron Lett.* **1989**, *30*, 5261–5262. For a recent applications see: Dias, L. C.; de Oliveira, L. G.; Vilcachagu, J. D.; Nigsch, F. *J. Org. Chem.* **2005**, *70*, 2225–2234.
- For reviews see: Schöter, S.; Stock, C.; Bach, T. *Tetrahedron* **2005**, *61*, 2245–2267. Mitchell, T. N. In *Metal-catalyzed Cross-coupling Reactions*; De Meijere, A., Diederich, F., Eds. 2nd ed.; Wiley-VCH: Weinheim, 2004; pp 125–161. Jutand, A. *Appl. Organomet. Chem.* **2004**, *18*, 574–582. Espinet, P.; Echavarren, A. M. *Angew. Chem., Int. Ed.* **2004**, *43*, 4704–4734. Stille, J. K. *Angew. Chem., Int. Ed. Engl.* **1986**, *25*, 508. Mitchell, T. N. *Synthesis* **1992**, 803–825. Farina, V.; Krishnamurthy, V.; Scott, W. J. *Org. React. (N. Y.)* **1997**, *50*, 1. Duncton, M. A. J.; Pattenden, G. *J. Chem. Soc., Perkin Trans. 1* **1999**, 1235. Franzen, R. *Can. J. Chem.* **2000**, *78*, 957. For recent mechanistic investigations see: Casado, A. L.; Espinet, P.; Gallego, A. M.; Martinez-Ilarduya, J. M. *Chem. Commun.* **2001**, 339–340. For recent applications of this methodology to diene synthesis see: Mulzer, J.; Berger, M. *J. Org. Chem.* **2004**, *69*, 891–898. Munoz, D. M.; Passey, S. C.; Simpson, T. J.; Willis, C. L.; Campbell, J. B.; Rosser, R. *Aust. J. Chem.* **2004**, *57*, 645–649.
- (a) McDougal, P. G.; Rico, J. G.; Oh, Y. I.; Condon, B. D. *J. Org. Chem.* **1986**, *51*, 3388–3390. (b) For an alternate method of preparation see: Boeckman, R. K.; Charette, A. B.; Asberom, T.; Johnston, B. H. *J. Am. Chem. Soc.* **1987**, *109*, 7553–7555.
- The preparation of 8_E has been described: Germain, J.; Deslongchamps, P. *Tetrahedron Lett.* **1999**, *40*, 4051–4054.
- The efficacy of organozincs in such transformations was first reported by Kumada: Hayashi, T.; Konishi, M.; Kumada, M. *Tetrahedron Lett.* **1979**, *20*, 1871–1874. For overviews see: Negishi, E. *J. Organomet. Chem.* **2002**, *653*, 34–40. Negishi, E.-I. *Acc. Chem. Res.* **1982**, *15*, 340. Erdick, E. *Tetrahedron* **1992**, *48*, 9577. *Metal Catalyzed Cross-coupling Reactions*; Diederich, F., Stang, P. J., Eds.; Wiley-VCH: Weinheim, 1998. For examples pertinent to the current investigation see: Casson, S.; Kocienski, P. *J. Chem. Soc., Perkin Trans. 1* **1994**, 1187–1191. Holzapfel, C. W.; Portwig, C. M. *Heterocycles* **1997**, *45*, 1433–1439.
- Kobayashi, M.; Negishi, E.-I. *J. Org. Chem.*, **1980**, *45*, 5223–5225.
- Brimble, M. A.; Edmonds, M. K.; Williams, G. M. *Tetrahedron* **1992**, *48*, 6455–6466.
- For similar isomerisation–cyclisation reactions see: Whitby, R.; Kocienski, P. *J. Chem. Soc., Chem. Commun.* **1987**, 906–907. (b) Gomez, A. M.; Valverde, S.; Fraser-Reid, B. *J. Chem. Soc., Chem. Commun.* **1991**, 1207–1208.
- Baker, R.; Herbert, R. H. *J. Chem. Soc., Perkin Trans. 1* **1987**, 1123–1127.
- (a) For an overview of the early work in this area see: Nicolaou, K. C. *Tetrahedron* **1981**, *37*, 4097–4109. For application to spiroketal synthesis see: Ley, S. V.; Armstrong, A.; Díez-Martín, D.; Ford, M. J.; Grice, P.; Knight, J. G.; Kolb, H. C.; Madin, A.; Marby, C. A.; Mukherjee, S.; Shaw, A. N.; Slawin, A. M. Z.; Vile, S.; White, A. D.; Williams, D. J.; Woods, M. J. *J. Chem. Soc., Perkin Trans. 1* **1991**, 667–692. (b) Uchiyama, M.; Oka, M.; Harai, S.; Ohta, A. *Tetrahedron Lett.* **2001**, *42*, 1931–1934.
- Davis, F. A.; Sheppard, A. C. *Tetrahedron* **1989**, *45*, 5703–5742. For application of selenoxide eliminations in carbohydrate chemistry see Chambers, D. J.; Evans, G. R.; Fairbanks, A. J. *Tetrahedron* **2004**, *60*, 8411–8419. Deleuze, A.; Sollogoub, M.; Blériot, Y.; Marrot, J.; Sinaÿ, P. *Eur.*

- J. Org. Chem.* **2003**, 2678–2683. Bravo, F.; Kassou, M.; Diaz, Y.; Castellón, S. *Carb. Res.* **2001**, 336, 83–97.
16. Lawson, E. N.; Kitching, W.; Kennard, C. H. L.; Byriel, K. A. *J. Org. Chem.* **1993**, 58, 2501–2508.
 17. Boeckman, R. K.; Bruza, K. J. *Tetrahedron* **1981**, 37, 3997–4006.
 18. (a) Ley, S. V.; Lygo, B.; Organ, H.; Wonnacott, A. *Tetrahedron* **1985**, 41, 3825–3836. (b) Ishii, K.; Kotera, M.; Nakano, T.; Zenko, T.; Sakamoto, M.; Iida, I.; Nishio, T. *Liebigs Ann.* **1995**, 19–27.
 19. Carey, J. S.; Thomas, E. J. *Tetrahedron Lett.* **1993**, 34, 3935–3938.
 20. The preparation of **29_E** has been reported: Tatsuta, K.; Itoh, M.; Hirama, R.; Araki, N.; Kitagawa, M. *Tetrahedron Lett.* **1997**, 38, 583–586.
 21. The preparation of **30_E** has been reported: Ziegler, F. E.; Chakraborty, U. R.; Weisenfeld, R. B. *Tetrahedron* **1981**, 37, 4035–4040.
 22. Brimble, M. A.; Nairn, M. R. *J. Org. Chem.* **1996**, 61, 4801–4805.
 23. Liu, H.; Cohen, T. *J. Org. Chem.* **1995**, 60, 2022–2025.
 24. Monte Carlo-type conformational search using the MM2 forcefield for minimisation in MacroModel[®] (version 3.1x) program.
 25. (a) Uchiyama has recently reported a similar finding, see Ref. 14b.(b) For related epimerisations during Se-mediated cyclisations see: Gruttadauria, M.; Aprile, C.; Riela, S.; Noto, R. *Tetrahedron Lett.* **2001**, 42, 2213–2215. Aprile, C.; Riela, S.; Noto, R. *Tetrahedron Lett.* **2001**, 42, 2213–2215. Aprile, C.; Gruttadauria, M.; Amato, M. E.; D'Anna, F.; Meo, P. L.; Riela, S.; Noto, R. *Tetrahedron* **2003**, 59, 2241–2251. Noto, R. *Tetrahedron* **2003**, 59, 2241–2251. Toshimitsu, A.; Nakano, K.; Mukai, T.; Tamao, K. *J. Am. Chem. Soc.* **1996**, 118, 2756–2757. Mihelich, E. D. *J. Am. Chem. Soc.* **1990**, 112, 8995–8997.
 26. For related reactions involving spiroketal ring opening see: Oikawa, H.; Oikawa, M.; Ichihara, A.; Kobayashi, K.; Uramoto, M. *Tetrahedron Lett.* **1993**, 34, 5303–5306. A similar process has also been promulgated in the case of the bromination of spiroketals, see Ref. 16.
 27. Deslongchamps, P. *Stereoelectronic Effects in Organic Chemistry*; Pergamon: Oxford, 1983; pp 4–21.
 28. Uckun, F. M.; Mao, C.; Jan, S.; Huang, H.; Vassilev, A. O.; Sudbeck, El. A.; Navara, C. S.; Narla, R. K. *Curr. Opin. Invest. Drugs* **2000**, 1, 252–256. Brimble, M. A. *J. Heterocycl. Chem.* **1999**, 36, 1373–1389. Jacobs, M. F.; Kitching, W. *Curr. Org. Chem.* **1998**, 2, 395–436.
 29. Fráter, G. *Helv. Chim. Acta* **1979**, 62, 2825–2828. Fráter, G.; Müller, U.; Günther, W. *Tetrahedron* **1984**, 40, 1269–1277.
 30. Keck, G. E.; Kachensky, D. F.; Enholm, E. J. *J. Org. Chem.* **1985**, 50, 4317–4325.
 31. Newton, R. F.; Reynolds, D. P.; Finch, M. A. W.; Kelly, D. R.; Roberts, S. M. *Tetrahedron Lett.* **1979**, 20, 3981–3982. The alcohol **42_E** derived from the minor isomer **41_E** was lost during this purification process.
 32. The **2R*,3R*,6S*** diastereoisomer of **44** is known and exhibits minor, but significant, differences in its high field ¹H and ¹³C NMR spectra compared to **44**. See Kocienski, P.; Whitby, R. *Synthesis* **1991**, 1029.
 33. Negishi, E.-I.; Ay, M.; Gulevich, Y. V.; Noda, Y. *Tetrahedron Lett.* **1993**, 34, 1437–1440. For a recent application see: Abarbri, M.; Parrain, J.-L.; Kitamura, M.; Noyori, R.; Duchêne, A. *J. Org. Chem.* **2000**, 65, 7475–7478.
 34. For palladium catalysed coupling reactions of organoaluminium reagents see: Negishi, E.-I.; Takahashi, T.; Baba, S.; Van Horn, D. E.; Okukado, N. *J. Am. Chem. Soc.* **1987**, 109, 2393–2401. Schumann, H.; Kaufmann, T.; Schmalz, H. G.; Böttcher, A.; Gotov, B. *Synlett* **2003**, 1783–1788. Blüm, J.; Berlin, O.; Milstein, D.; Ben-David, Y.; Wassermann, B. C.; Schutte, S.; Schumann, H. *Synthesis* **2000**, 571–575.
 35. Ghosal, S.; Luke, G. P.; Kyler, K. S. *J. Org. Chem.* **1987**, 52, 4296–4298.
 36. Seyferth, D.; Heeren, J. K.; Singh, G.; Grun, S. O.; Hughes, W. B. *J. Organomet. Chem.* **1966**, 5, 267–274.
 37. Prepared in a modified procedure to that reported by Mori: c.f. Maemoto, S.; Mori, K. *Chem. Lett.* **1987**, 109–112. Mori, K.; Maemoto, S. *Liebigs Ann. Chem.* **1987**, 863–869.
 38. These iodoalkenes tend to undergo photoinduced decomposition generating iodine. Once purified they can be stored indefinitely under an atmosphere of nitrogen or argon at –20 °C.

Apteniols A–F, oxyneolignans from the leaves of *Aptenia cordifolia*

Marina DellaGreca,* Cinzia Di Marino, Lucio Previtiera, Raffaella Purcaro and Armando Zarrelli

Dipartimento di Chimica Organica e Biochimica, Università Federico II, Complesso Universitario Monte Sant'Angelo, Via Cinthia 4, I-80126 Napoli, Italy

Received 5 July 2005; revised 5 September 2005; accepted 15 September 2005

Available online 6 October 2005

Abstract—Investigation of the organic extract of *Aptenia cordifolia* leaves revealed six new oxyneolignans named apteniols A–F. The structures were determined by means of spectroscopic methods. The C₆C₃ units are linked by an oxygen atom at C4–C4' or C4–C2' and they are dihydrophenylpropanoid acid units. Their effects on germination and growth of *Lactuca sativa* L. have been studied in the range concentration 10⁻⁴–10⁻⁷ M.

© 2005 Elsevier Ltd. All rights reserved.

1. Introduction

Aptenia cordifolia, belonging to the Aizoaceae family, is a perennial herb native to South Africa and has now largely spread throughout Europe. The most commonly grown plant, usually grown under the cultivar name of 'Red Apple', is considered by some botanists to be actually a hybrid between *Aptenia cordifolia* and the closely related *Platythya Aptenia haeckeliana*.¹ Previous chemical studies of the aerial part of *A. cordifolia* evidenced the presence of flavonoids.² As part of our research on bioactive natural products isolated from spontaneous plants present in Italy and their use as natural herbicide models, we recently reported that some metabolites isolated from *Brassica fruticulosa* and *Chenopodium album* inhibited the germination and growth of some mono and dicotyledons.^{3,4}

Continuing the phytochemical study of common weeds widely distributed in the Mediterranean area, we have investigated *A. cordifolia*. The present paper reports the isolation and structure elucidation of six new oxyneolignans from the hydroalcoholic infusion of fresh leaves of *A. cordifolia*. The C₆C₃ units are linked by an oxygen atom at C4–C4' or C4–C2' and they are dihydrophenylpropanoid acid units. The phytotoxic activity of the compounds have been evaluated on the dicotyledon *Lactuca sativa*.

2. Results and discussion

Repeated column chromatographies and preparative HPLC of the methanol/water extract of leaves of the plants, after acetone precipitation, afforded compounds 1–6. The

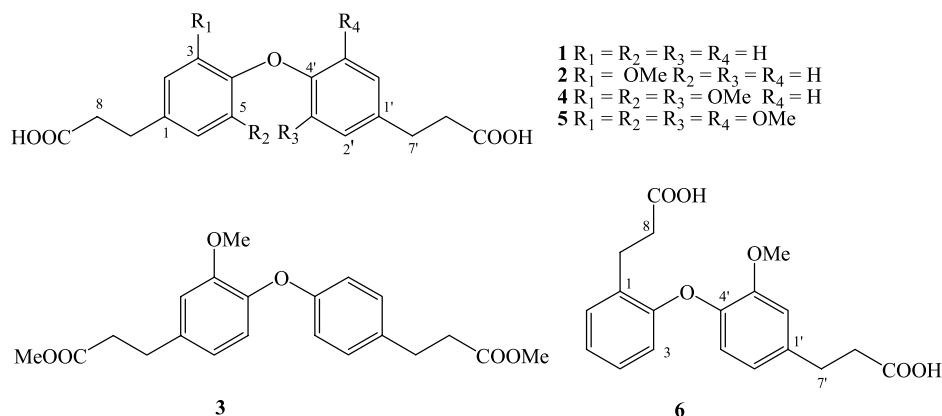

Keywords: *Aptenia cordifolia*; Apteniols A–F; Oxyneolignans; Spectroscopic analysis; *Lactuca sativa*.

* Corresponding author. Tel.: +39 081 674162; fax: +39 081 674393; e-mail: dellagre@unina.it

Table 1. ¹H NMR Data of **1–6** (CD₃OD) at 500 MHz^a

Position	1	2	3^b	4^b	5^b	6
2	6.92d (8.5)	6.72d (1.5)	6.70d (1.5)	6.44s	6.42s	
3	6.63d (8.5)					7.21 ^c
4						7.23 ^c
5	6.63d (8.5)	6.82d (8.2)	6.83d (8.0)			7.12m
6	6.92d (8.5)	6.70dd (8.2, 1.5)	6.68dd (8.0, 1.5)	6.44s	6.42s	7.21 ^c
7	2.84t (8.1)	2.89t (8.0)	2.88t (7.5)	2.90t (7.5)	2.88t (8.0)	2.89t (7.6)
8	2.66t (8.1)	2.66t (8.0)	2.59t (7.5)	2.67t (7.5)	2.61t (8.0)	2.44t (7.6)
2'	6.92d (8.5)	7.05d (8.5)	7.05d (9.0)	6.72s	6.42s	6.82d (2.0)
3'	6.63d (8.5)	6.74d (8.5)	6.75d (9.0)			
5'	6.63d (8.5)	6.74d (8.5)	6.75d (9.0)	6.82d (8.5)		6.67d (8.0)
6'	6.92d (8.5)	7.05d (8.5)	7.05d (9.0)	6.70d (8.5)	6.42s	6.63dd (8.0, 2.0)
7'	2.84t (8.1)	2.89t (8.0)	2.88t (7.5)	2.90t (7.5)	2.88t (8.0)	2.82t (7.8)
8'	2.66t (8.1)	2.66t (8.0)	2.61t (7.5)	2.67t (7.5)	2.61t (8.0)	2.41t (7.8)
3-OMe		3.86s	3.87s	3.87s	3.88s	
5-OMe				3.87s	3.88s	
3'-OMe				3.87s	3.88s	3.87s
5'-OMe					3.88s	
9-OMe			3.67s			
9'-OMe			3.67s			

^a *J* values (in Hz) in parentheses.^b Recorded in CDCl₃ 500 MHz.^c Multiplicity was not determined due to overlapping.

structure of these compounds was elucidated by their spectral data.

Apteniol A (**1**) showed a molecular peak at *m/z* 337 [M+Na]⁺ in the MALDI-MS spectrum suggesting, along with the elemental analysis, a molecular formula C₁₈H₁₈O₅. The UV spectrum revealed band at 278 nm. The ¹H NMR and the ¹³C NMR spectra indicated a highly symmetric molecule. In the ¹H NMR spectrum (Table 1) eight aromatic protons were present as two *ortho*-coupled protons and eight methylene protons as two triplets in aliphatic region. The ¹³C NMR spectrum (Table 2) showed only seven carbon signals. The ¹H and ¹³C resonances of **1** were assigned by combination of COSY, DEPT, HMQC and HMBC experiments. The DEPT spectrum showed two methylenes,

and two methines. According to the structure in the HMBC spectrum both the H-7/H-7' and H-8/H-8' protons were correlated to the C-9/C-9' at δ 180.6 and C-1/C-1' at δ 129.6; furthermore the H-3/H-3' protons were correlated to C-1/C-1', and C-4/C-4' carbons at δ 157.4.

The molecular ion at *m/z* 390 [M+2Na]⁺ in the MALDI-MS spectrum along with the elemental analysis, defined the molecular formula C₁₉H₂₀O₆ of apteniol B (**2**). Its ¹H NMR spectra (Table 1) indicated the presence of four *ortho*-coupled protons, two doublet protons, and one doublet proton in the aromatic region; a methyl singlet of a methoxyl group, and two triplets in the aliphatic region. In the ¹³C NMR spectrum (Table 2) fourteen carbons were evident. The DEPT spectrum indicated the presence of a

Table 2. ¹³C NMR Data of **1–6** (CD₃OD) at 125 MHz

Position	1	2	3^a	4^a	5^a	6
1	129.6	132.1	132.7	133.1	132.0	135.7
2	130.7	111.0	110.2	104.8	104.9	113.5
3	116.6	146.4	146.7	146.9	147.0	148.6
4	157.4	144.0	144.2	131.9	145.2	145.8
5	116.6	114.4	114.6	146.9	147.0	116.4
6	130.7	120.8	121.0	104.8	104.9	122.0
7	35.7	30.3	30.9	30.7	31.2	34.0
8	42.9	35.9	36.3	35.7	36.1	41.9
9	180.6	178.9	173.8	177.8	178.4	182.2
1'	129.6	132.1	130.0	131.2	132.0	127.1
2'	130.7	129.4	129.6	110.8	104.9	144.2
3'	116.6	115.4	115.5	146.9	147.0	129.2
4'	157.4	154.1	154.4	144.0	145.2	129.2
5'	116.6	115.4	115.5	114.3	147.0	126.6
6'	130.7	129.4	129.6	120.7	104.9	129.2
7'	35.7	30.3	30.9	30.2	31.2	34.4
8'	42.9	35.8	36.3	35.7	36.1	41.6
9'	180.6	178.9	173.8	177.8	178.4	182.2
3-OMe		55.8	56.1	56.1	56.3	56.5
5-OMe				56.1	56.3	
3'-OMe				55.7	56.3	
5'-OMe					56.3	
9-OMe			51.9			
9'-OMe			51.9			

^a Recorded in CDCl₃.

methyl, three methylenes, and five methines. The HMQC experiment allowed the assignment of the protons to the corresponding carbons. The HMBC spectrum showed cross-peaks of both the H-2 and H-5 protons with the C-3 and C-4 carbons and the H-6 with the C-1 and C-7. Furthermore the H-2'/H-6' protons gave cross peaks with the C-4' and C-7' carbons, the H-7' and the H-8' protons gave cross peaks with the C-1' and C-9' carbons. These data led to the structure **2** as depicted. The assignment of the methoxyl at C-3 was confirmed by NOE between the methoxyl and the H-2 proton.

Apteniol C (**3**) had the molecular formula $C_{21}H_{24}O_6$ as deduced from the molecular peak at m/z 372 in the MALDI-MS spectrum. The general features of its IR and NMR spectra (Tables 1 and 2) closely resembled those of **2**, except for the presence of two methoxyl signals in the NMR

spectra. The structure of compound **3** was also deduced from the NOE observed between the methoxyls at δ 3.67 and the H-8/H-8' protons in the NOESY experiment. Compound **3** was also obtained by treatment of Apteniol B with ethereal CH_2N_2 .

Apteniol D (**4**) had the molecular formula $C_{21}H_{24}O_8$, as established by the ion at m/z 427 $[M+Na]^+$ in the MALDI-MS spectrum and elemental analysis. The 1H NMR spectrum (Table 1) showed the presence of one aromatic ring with three coupled protons in a ABX system, an aromatic ring with two protons *meta* coupled, two methylenes as triplets and a methyl singlet of three methoxyls. In the ^{13}C NMR spectrum (Table 2) fifteen carbon signals were present, and the DEPT experiment evidenced two methyls, two methylenes, and four methines. The 1H and ^{13}C resonances of apteniol C were assigned by

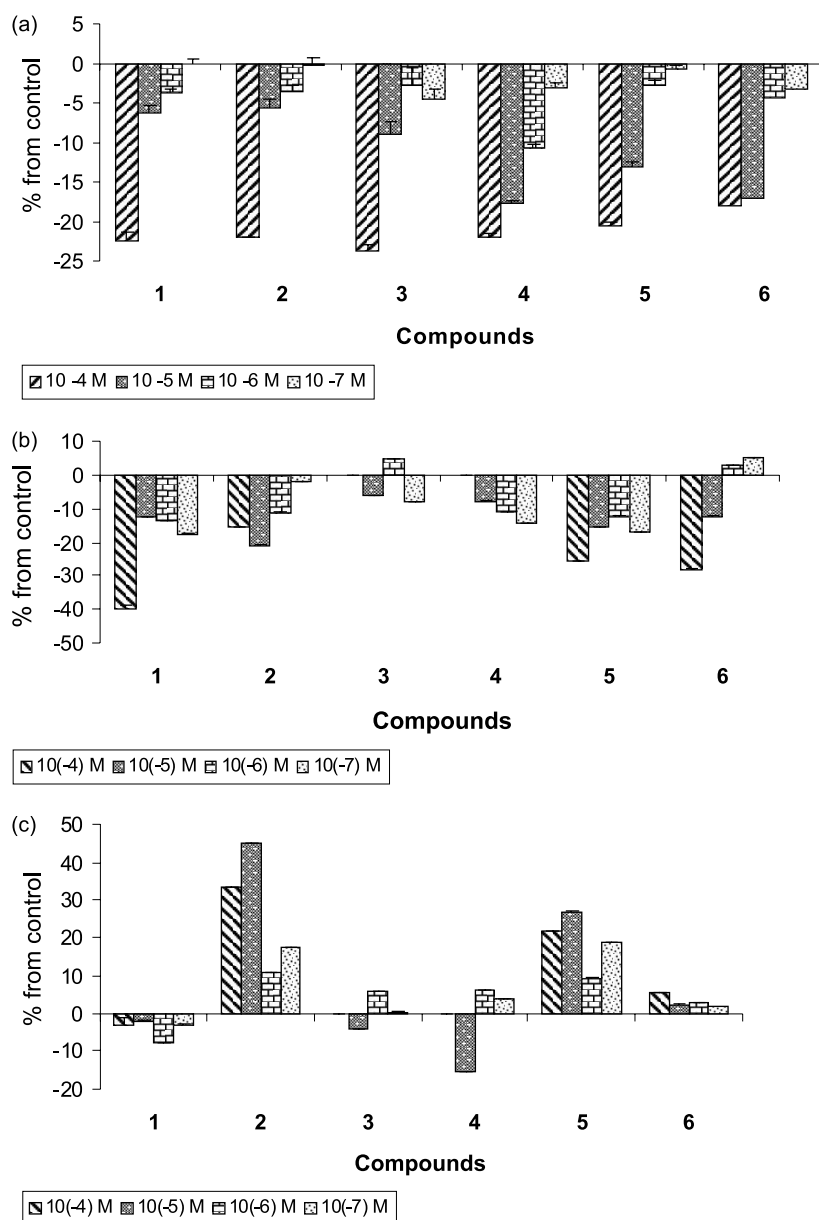

Figure 1. (A) Effect of compounds 1–6 on germination of *Lactuca sativa* L. Value presented as percentage differences from control. (B) Effect of compounds 1–6 on root length of *Lactuca sativa* L. Value presented as percentage differences from control. (C) Effect of compounds 1–6 on shoot length of *Lactuca sativa* L. Value presented as percentage differences from control.

combination of COSY, DEPT, HMQC and HMBC experiments. The HMBC spectrum of compound **4** showed cross-peaks of both the H-2 and H-6 with C-4 and C-7, and both the H-2' and the H-5' protons with the C-1' and C-4' carbons. NOEs between the signal at δ 3.87 and the H-2, H-6 and H-2' protons allowed to assign the methoxyls at C-3, C-5, and C-5' positions.

Apteniol E (**5**) showed a molecular peak at m/z 480 $[M+2Na]^+$ in the MALDI-MS spectrum suggesting, along with the elemental analysis, a molecular formula $C_{22}H_{26}O_9$. The UV spectrum revealed bands at 322, 279 and 244 nm. The 1H NMR spectrum (Table 1) showed only one singlet aromatic signal, two triplets in aliphatic region, and a methyl signals. In the ^{13}C NMR spectrum (Table 2) only eight carbon signals were present indicating a highly symmetric molecule. The 1H and ^{13}C resonances of **5** were assigned by combination of COSY, DEPT, HMQC and HMBC experiments. The DEPT spectrum showed one methyl, two methylenes, and one methine. According to the structure in the HMBC spectrum both the H-7/H-7' and the H-8/H-8' protons were correlated to the C-9/C-9' at δ 178.4 and the C-1/C-1' at δ 132.0; furthermore the H-2, H-6/H-2', H-6' protons were correlated to the C-1/C-1' and C-4/C-4' carbons. The NOE of the signal at δ 3.88 with H-2/H-6 and H-2'/H-6' allowed assignment of the methoxyls at the C-3, C-3', C-5, and C-5' positions.

Apteniol F (**6**) had the same molecular formula as **2** as deduced from a molecular peak at m/z 343 $[M-H]^+$ in the MALDI-MS spectrum, and the elemental analysis. The 1H NMR spectrum (Table 1) showed the presence of one aromatic ring with three coupled protons in a ABX system, an aromatic ring with four adjacent protons, two methylenes as triplets and a methyl singlet of a methoxyl group. In the ^{13}C NMR spectrum (Table 2) sixteen carbon signals were present, and the DEPT experiment showed one methyl, four methylenes, and five methines. The 1H and ^{13}C resonances of apteniol F were assigned by a combination of COSY, DEPT, HMQC and HMBC experiments. The HMBC spectrum of compound **6** showed cross-peaks of H-7 with C-2, C-6 and C-9, H-8 with C-1, and both the H-2' and the H-5' protons with the C-1' and C-4' carbons. NOEs between the signal at δ 3.87 and H-2' allowed assignment of the methoxyl at the C-3' position.

All of the compounds isolated from *A. cordifolia* were tested for their phytotoxicity on the seeds of *Lactuca sativa*.⁵ This species was selected as representative of main dicotyledon commercial crops.⁵ It has been used extensively as a test organism because of its fast germination and high sensitivity, and allows comparison of bioassay results for many different compounds.^{6,7} Aqueous solution of oxyneolignans **1–6**, ranging between 10^{-4} and 10^{-7} M, were tested on germination, root length and shoot length of treated lettuce seeds (Fig. 1). All the tested compounds reduced the germination by 25% at 10^{-4} M, and dose dependence effects were observed. They reduced the root elongation by 20% at 10^{-4} M, but compound **1** was the most active (40%) when compared to the control and compound **3** was almost completely inactive. Amongst compounds **1–6**, only oxyneolignan **4** reduced shoot elongation by 15% at the highest concentration and no

important effects were observed for compounds **1**, **3**, and **6**, while compounds **2** and **5** showed stimulatory effects within 20–50%.

Lignans, found widely throughout the plant kingdom, exhibit interesting antimicrobial, antiviral, herbicidal, or antifeedant activities that are thought to participate in plant defence mechanisms against biotic stresses.^{8–11} Cancer protective effects of dietary lignans have been also demonstrated.^{12,13} In contrast, neolignans are distributed in the limited plant families, as Pinaceae and Cupressaceae.^{14,15} The presence of dihydrocinnamic acid residues, in oxyneolignans isolated from *A. cordifolia* is peculiar because, to the best of our knowledge, the more common compounds isolated contain a reduced carboxylic group as alcohol or alkane.

3. Experimental

3.1. General procedures

NMR spectra were recorded at 25 °C on a Varian UNITY INOVA-500 spectrometer, operating at 500 and 125 MHz for 1H and ^{13}C , respectively. Matrix assisted laser desorption ionization (MALDI) mass spectra were recorded using a Voyager-DE MALDI-TOF mass spectrometer. UV–vis spectra were recorded in methanol on a Perkin-Elmer Lambda 7 spectrophotometer. Liquid chromatography over silica gel (230–400 mesh) was performed at medium pressure. Preparative HPLC was run on a Agilent 1100 equipped with an UV detector and using SiO_2 (LiChrospher Silica 10 μm , 250 \times 10 mm i.d., Merck), RP-18 (LiChrospher 10 μm , 250 \times 10 mm i.d., Merck) columns. Analytical TLC was performed on precoated Merck aluminum sheet (DC-Alufolien Kielselgel 60 F₂₅₄, 0.2 mm) or RP-18 F₂₅₄ plates with 0.2 mm film thickness. The spots were visualized by UV light or by spraying with H_2SO_4 –AcOH– H_2O (1:20:4). The plates were then heated for 5 min at 110 °C. Prep. TLC was performed on Merck Kiesegel 60 F₂₅₄ plates, with 0.5 or 1 mm film thickness.

3.2. Plant material

Leaves of *Aptenia cordifolia* were collected in Italy (Campania) during the summer (August) and identified by Professor Pollio of the Dipartimento di Biologia Vegetale of University Federico II of Napoli. A voucher specimen (HERBNAPY680) has been deposited in the herbarium at the University Federico II.

3.3. Extraction and isolation of metabolites

Fresh leaves (12 kg) of the plants were powdered and extracted with H_2O – CH_3OH (9/1) at room temperature (25 °C) for 7 days. To an aqueous suspension (800 ml) of the H_2O/CH_3OH extract (450 g), cold $(CH_3)_2CO$ (1.0 l) was added, and the mixture was placed on a stirring plate overnight at -18 °C. The $(CH_3)_2CO$ addition led to heavy precipitation consisting mostly of proteinaceous material, which was removed by centrifugation. The $(CH_3)_2CO$ was removed and the aqueous solution was chromatographed on Amberlite XAD-2 with H_2O , CH_3OH and $(CH_3)_2CO$ to give

3 fractions. The fraction eluted with CH₃OH (45.0 g) was rechromatographed on silica gel column to give 13 fractions. Fraction 5 (5.5 g) eluted with CH₂Cl₂–CH₃OH (4/1) was rechromatographed on SiO₂ flash column eluting with CH₂Cl₂–AcOEt–(CH₃)₂CO gradient to afford 9 subfractions. Subfraction 1 (91 mg) eluted with CH₂Cl₂–(CH₃)₂CO (4/1) was purified by preparative TLC [petrol ether–(CH₃)₂CO (3/1)], to give **3** (8 mg).

Fraction eluted with (CH₃)₂CO (50.0 g) was rechromatographed on silica gel column to give 11 fractions. Fraction 6 (5.0 g) eluted with CH₂Cl₂–CH₃OH (1/1) was rechromatographed on SiO₂ flash column eluting with CH₂Cl₂–(CH₃)₂CO–CH₃OH gradient to afford 15 subfractions. Subfraction 10 (498 mg) eluted with CH₂Cl₂–CH₃OH (4/1) was rechromatographed on SiO₂ flash column eluting with AcOEt–(CH₃)₂CO–CH₃OH gradient to afford the fractions A–M. Fraction B (52 mg) eluted with AcOEt–(CH₃)₂CO (9/1) was purified by reversed-phase HPLC column (LiChrosphere RP-18 10 μm, 250×10 mm i.d., Merck) [H₂O–CH₃OH (1/1)], to give **6** (4 mg). Subfraction 13 (2.3 g) eluted with (CH₃)₂CO–CH₃OH (1/1) was rechromatographed on SiO₂ flash column, eluting with CH₂Cl₂–(CH₃)₂CO–CH₃OH gradient to afford the fractions A–I. Fraction C (46 mg) eluted with CH₂Cl₂–(CH₃)₂CO (4/1) was purified by preparative TLC [Petrol ether 40–60–(CH₃)₂CO (3/1)], to give **5** (4 mg). Fraction D (30 mg) eluted with CH₂Cl₂–(CH₃)₂CO (3/1) was purified by reversed-phase HPLC column [H₂O–CH₃OH (1/1)], to give **4** (9 mg) and **2** (11 mg). Fraction 8 (16.0 g) eluted with CH₃OH was rechromatographed on SiO₂ flash column eluting with (CH₃)₂CO–CH₃OH gradient to afford 7 subfractions. Subfraction 6 (292 mg) eluted with (CH₃)₂CO–CH₃OH (1/1) was rechromatographed on SiO₂ flash column eluting with (CH₃)₂CO–CH₃OH (7/3) to afford the fractions A–G. Fraction B (76 mg) was purified by preparative TLC [(CH₃)₂CO–CH₃OH–H₂O (35/14/1)], to give **1** (8 mg).

3.3.1. 4,4'-Oxyneolign-9,9'-dioic acid (1). UV λ_{max} (CH₃OH) nm: 278 (log ε 3.2). MALDI-MS *m/z* (%): 337 (70), 277 (10), 255 (100). Anal. Calcd for C₁₈H₁₈O₅: C, 68.78, H, 5.77. Found: C, 69.00, H, 5.79. ¹H and ¹³C NMR data are listed in Tables 1 and 2.

3.3.2. 3-Methoxy-4,4'-oxyneolign-9,9'-dioic acid (2). UV λ_{max} (CH₃OH) nm: 280 (log ε 2.2). MALDI-MS *m/z* (%): 390 (15), 344 (10), 329 (20), 300 (30), 179 (100). Anal. Calcd for C₁₉H₂₀O₆: C, 66.27, H 5.85. Found: C, 66.45, H, 5.95. ¹H and ¹³C NMR data are listed in Tables 1 and 2.

3.3.3. Dimethyl 3-methoxy-4,4'-oxyneolign-9,9'-dioate (3). UV λ_{max} (CH₃OH) nm: 280 (log ε 3.1). MALDI-MS *m/z* (%): 372 (18), 254 (30), 209 (100), 163 (40). Anal. Calcd for C₂₁H₂₄O₆: C, 67.73, H, 6.50. Found: C, 67.91, H, 6.48. ¹H and ¹³C NMR data are listed in Tables 1 and 2.

3.3.4. 3,3',5-Trimethoxy-4,4'-oxyneolign-9,9'-dioic acid (4). UV λ_{max} (CH₃OH) nm: 321 (log ε 0.9), 280 (2.6), 242 (2.5). MALDI-MS *m/z* (%): 427 (10), 409 (20), 331 (10), 226 (20), 273 (100). Anal. Calcd for C₂₁H₂₄O₈: C, 76.18, H, 4.79. Found: C, 76.10, H, 4.50. ¹H and ¹³C NMR data are listed in Tables 1 and 2.

3.3.5. 3,3',5,5'-Tetramethoxy-4,4'-oxyneolign-9,9'-dioic acid (5). UV λ_{max} (CH₃OH) nm: 322 (log ε 1.5), 279 (3.0), 244 (2.8). MALDI-MS *m/z* (%): 507 (20), 344 (20), 240 (100). Anal. Calcd for C₂₂H₂₆O₉: C, 60.82, H, 6.03. Found: C, 61.00, H, 6.05. ¹H and ¹³C NMR data are listed in Tables 1 and 2.

3.3.6. 3'-Methoxy-2,4'-oxyneolign-9,9'-dioic acid (6). UV λ_{max} (CH₃OH) nm: 280 (log ε 1.4). MALDI-MS *m/z* (%): 343 (20), 272 (30), 179 (100), 196 (35). Anal. Calcd for C₁₉H₂₀O₆: C, 66.27, H, 5.85. Found: C, 66.91, H, 5.90. ¹H and ¹³C NMR data are listed in Tables 1 and 2.

3.4. Bioassays

Seeds of *Lactuca sativa* L. (cv. Cavolo di Napoli, collected during 2003, were obtained from Ingegnoli Spa (Milan, Italy). All undersized or damaged seeds were discarded and the assay seeds were selected for uniformity. For the bioassays we used Petri dishes of 50 mm diameter with one sheet of Whatman No. 1 filter paper as support. In four replicate experiments, germination and growth were conducted in aqueous solutions at controlled pH. Test solutions (10⁻⁴ M) were prepared using MES (2-[*N*-morpholino]ethanesulfonic acid, 10 mM, pH 6) and the rest (10⁻⁵–10⁻⁷ M) were obtained by dilution. Parallel controls were performed. After adding 25 seeds and 2.5 ml test solutions, Petri dishes were sealed with Parafilm[®] to ensure closed-system models. Seeds were placed in a growth chamber KBW Binder 240 at 25 °C in the dark. Germination percentage was determined daily for 5 days (no more germination occurred after this time). After growth, plants were frozen at –20 °C to avoid subsequent growth until the measurement process. Data are reported as percentage differences from control in the graphics and tables. Thus, zero represents the control, positive values represent stimulation of the parameter studied and negative values represent inhibition.

Acknowledgements

NMR experiments have been performed at Centro Interdipartimentale di Metodologie Chimico-Fisiche of University Federico II of Naples on a 500 MHz spectrometer of Consortium INCA.

References and notes

- Von Willert, D. J.; Thomas, D. A.; Lobin, W.; Curdts, E. *Oecologia* **1977**, *29*, 67–76.
- Elgindi, M. R.; Elgindi, O. D.; Mabry, T. J.; Fiorentino, L. *Asian J. Chem.* **1999**, *11*, 1525–1527.
- Cuttillo, F.; D'Abrosca, B.; DellaGreca, M.; Fiorentino, A.; Zarrelli, A. *J. Agric. Food. Chem.* **2003**, *51*, 6165–6172.
- DellaGreca, M.; Di Marino, C.; Zarrelli, A.; D'Abrosca, B. *J. Nat. Prod.* **2004**, *67*, 1492–1495.
- Macias, F. A.; Castellano, D.; Molinillo, J. M. G. *J. Agric. Food. Chem.* **2000**, *48*, 2512–2521.
- Leather, G. R. *J. Chem. Ecol.* **1983**, *9*, 983–989.

7. Yu, J. Q.; Matsui, Y. *J. Chem. Ecol.* **1994**, *20*, 21–31.
8. Bedows, E.; Hatfield, G. M. *J. Nat. Prod.* **1982**, *45*, 725–728.
9. Rimando, A. M.; Dayan, F. E.; Mikell, J. R.; Moraes, R. M. *Nat. Toxins* **1999**, *7*, 39–43.
10. Russel, G. B.; Singh, P.; Fenemore, P. G. *Aust. J. Biol. Sci.* **1976**, *29*, 99–103.
11. Oliva, A.; Moraes, R. M.; Watson, S. B.; Duke, S. O.; Dayan, F. E. *Pestic. Biochem. Physiol.* **2002**, *72*, 45–54.
12. Thompson, L. U.; Seidl, M. M.; Rickard, S. E.; Orcheson, L. J.; Fong, H. H. *Nutr. Cancer* **1996**, *26*, 159–165.
13. Thompson, L. U.; Rickard, S. E.; Orcheson, L. J.; Seidl, M. M. *Carcinogenesis* **1996**, *17*, 1373–1376.
14. Gottlieb, O. R.; Yoshida, M. In *Natural products of woody plants*; Rowe, J. W., Ed.; Springer: Berlin, 1989; pp 441–511.
15. Castro, M. A.; Gordaliza, M.; Del Corral, M. J.; San Feliciano, A. *Phytochemistry* **1996**, *41*, 995–1011.

Enantiomerically pure 4-amino-1,2,3-trihydroxybutylphosphonic acids

Andrzej E. Wróblewski* and Iwona E. Głowacka

Bioorganic Chemistry Laboratory, Faculty of Pharmacy, Medical University of Łódź, 90-151 Łódź, Muszyńskiego 1, Poland

Received 30 June 2005; revised 1 September 2005; accepted 15 September 2005

Available online 3 October 2005

This paper is respectfully dedicated to Professor Jan Michalski on the occasion of his 85th birthday

Abstract—(1*S*,2*R*,3*S*)-, (1*R*,2*R*,3*S*)- and (1*S*,2*R*,3*R*)-4-amino-1,2,3-trihydroxybutylphosphonic acids were synthesised. The synthetic strategy involved preparation of the respective 4-azido-2,3-*O*-isopropylidene-*L*-threose or -*D*-erythrose, addition of dialkyl phosphites, separation of C-1 epimeric *O*,*O*-dibenzyl phosphonates, the reduction of azides and the removal of the protecting groups. The (2*R*,3*S*) and (2*R*,3*R*) configurations in the final products were secured by employing diethyl *L*-tartrate and *D*-isoascorbic acid as starting materials. The stereochemical course of the addition to the carbonyl groups in 4-azido-2,3-*O*-isopropylidene-*L*-threose or -*D*-erythrose followed that established earlier for 2,3-*O*-isopropylidene-*D*-glyceraldehyde and similar (3:1–4:1) diastereoselectivities were achieved.

© 2005 Elsevier Ltd. All rights reserved.

1. Introduction

In comparison to α -aminophosphonates, which are surrogates of aminoacids, δ -aminophosphonates are less known class of compounds.¹ Several important examples of phosphonates bearing an amino group at C-4 are shown on Figure 1. (2*S*,3*Z*)-2-amino-5-phosphono-3-pentenoic acid **1** is a constituent of rhizoctin A, an antifungal peptide antibiotic.² 4-Aminobutylphosphonic acid **2** has often been used in studies on characterisation of GABA_B receptors.³ (*R*)-2-amino-5-phosphonovaleric acid (*R*)-**3** is a selective NMDA antagonist⁴ and was used as a lead structure in development of other competitive NMDA antagonists.⁵ On the other hand, (*S*)-**3** showed antagonist activity at mGluR2 receptor,⁶ while (*R*)-**3** was almost not active in this case. The β -ketophosphonate **4** as well as its 5-fluoro- and 5,5-difluoro analogues mimic β -aspartyl phosphate and were shown to be inhibitors of aspartate-semialdehyde dehydrogenase.⁷ Further studies from this group led to synthesis of conformationally rigid analogues having a cyclopropane framework.⁸ In attempts to pharmacologically characterise glutamate receptor subtypes the following δ -aminophosphonates: **5**,⁹ **6**,¹⁰ **7**,¹¹ **8**,¹² **9**,¹³ **10** (a racemic mixture¹⁴ and both enantiomers¹⁵) and **11**^{14,16} have been used. Several phosphonates containing a terminal

triazole moiety, including compounds **12** and **13** showed inhibition of glycerol phosphate dehydratase.¹⁷ The phosphonate **14** was found to be a competitive inhibitor of human glycylamide ribonucleoside transformylase.¹⁸ One of the most active bisphosphonates,¹⁹ **15** is marketed as Alendronate for treatment of osteoporosis and related diseases.

Recently, we have elaborated an efficient synthesis of enantiomerically pure dimethyl (1*R*,2*S*)- and (1*S*,2*S*)-3-azido-2-benzyloxy-1-hydroxypropylphosphonates from (*S*)-3-azido-2-benzyloxypropanal and showed their clean transformation into the respective 3-acetamido-1,2-dihydroxypropylphosphonates.²⁰ Herein, we describe an extension of this approach to the synthesis of (1*R*,2*R*,3*S*)-, (1*S*,2*R*,3*S*)- and (1*S*,2*R*,3*R*)-

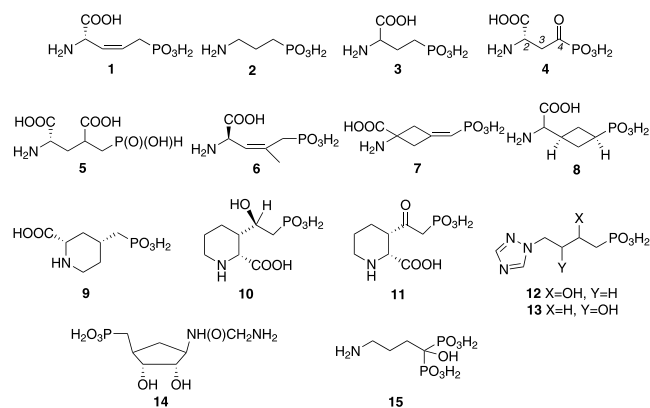
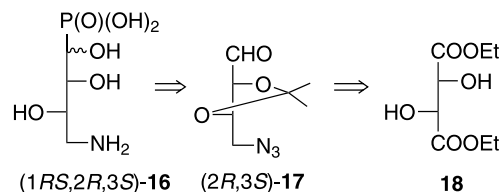

Figure 1.

Keywords: Amino acids and derivatives; Aldehydes; Configuration; Conformation; Phosphonic acids and derivatives.

* Corresponding author. Tel.: +48 42 677 92 33; fax: +48 42 678 83 98; e-mail: aewplld@ich.pharm.am.lodz.pl

4-amino-1,2,3-trihydroxybutylphosphonates **16** through the intermediacy of two new (2*R*,3*S*)- and (2*R*,3*R*)-4-azido-2,3-*O*-isopropylidene-2,3-dihydroxybutanal **17** (Schemes 1 and 2), which were obtained from diethyl *L*-tartrate **18** and *D*-isoascorbic acid **20**, respectively, as starting materials.



Scheme 1. Retrosynthesis of (1*R*,2*R*,3*S*)-4-amino-1,2,3-trihydroxybutylphosphonates.

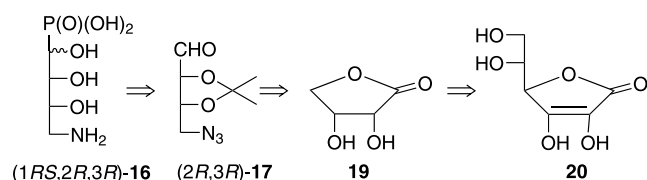

Scheme 2. Retrosynthesis of (1*R*,2*R*,3*R*)-4-amino-1,2,3-trihydroxybutylphosphonates.

2. Results and discussion

To synthesise the aldehyde (2*R*,3*S*)-**17** (Scheme 3), diethyl *L*-tartrate **18** was protected as the isopropylidene derivative,²¹ which was later reduced with a sodium borohydride–lithium chloride mixture²² leading to the known²³ diol **21** in 86% yield. Tosylation of **21** with 1.1 equiv of tosyl chloride²⁴ produced the monotosylate **22** without traces of a disubstituted compound. The monotosylate **22** could not be purified on a silica gel column and a crude material was subjected to standard azidation to give the known azide (2*S*,3*S*)-**23**.²⁵ Oxidation under Swern conditions²⁶ gave unstable 4-azidoaldehyde (2*R*,3*S*)-**17**, which was immediately used in the next step as a crude product.

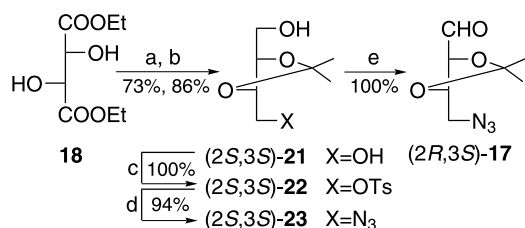

Scheme 3. Synthesis of 4-azido-4-deoxy-2,3-*O*-isopropylidene-*L*-threose, (2*R*,3*S*)-**17**. Reagents and conditions: (a) H(OEt)_3 , acetone, 3.7 M HCl–AcOEt, 4 days; (b) NaBH_4 –LiCl, THF–EtOH (1/2), 0 °C to rt, 16 h; (c) TsCl, KI, Ag_2O , CH_2Cl_2 , rt, 2 h; (d) NaN_3 , DMF, 70 °C, 24 h; (e) DMSO, $(\text{COCl})_2$, –78 °C, 2 h, TEA or DIPEA, –78 °C, 0.5 h.

In order to synthesise (2*R*,3*R*)-**17** (Scheme 4), *D*-isoascorbic acid was converted into *D*-erythrulose, which was subjected to isopropylideneation to give the protected lactone **24** in 75% yield.²⁸ To open the lactone ring in **24** with sodium azide the literature procedure was followed.²⁹ Transformation of the crude sodium salt **25** into the respective methyl ester **26** was accomplished in one step

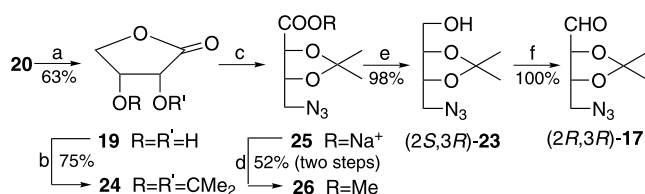

Scheme 4. Synthesis of 4-azido-4-deoxy-2,3-*O*-isopropylidene-*D*-erythrose, (2*R*,3*R*)-**17**. Reagents and conditions: (a) Refs. 27 and 28; (b) $\text{Me}_2\text{C}(\text{OMe})_2$, acetone, TsOH, rt, 16 h; (c) NaN_3 , DMF, 110 °C, 48 h; (d) MeI, DMF, rt, 2 days; (e) NaBH_4 –LiCl, THF–EtOH (1/2), 0 °C to rt, 16 h; (f) DMSO, $(\text{COCl})_2$, –78 °C, 2 h, DIPEA, –78–0 °C, 0.5 h.

using methyl iodide in DMF.³⁰ Reduction of **26** was achieved in a similar way as described above²² to furnish the stable alcohol (2*S*,3*R*)-**23**, which was obtained in 98% yield after purification on a silica gel column. Again, the Swern protocol²⁶ was applied to prepare the unstable 4-azidoaldehyde (2*R*,3*R*)-**17**, which was immediately subjected to phosphonylations as a crude product.

Detailed analyses of the ¹H NMR spectra of crude aldehydes (2*R*,3*S*)-**17** and (2*R*,3*R*)-**17** clearly showed, that some epimerisation at C-2 occurred during oxidation. Thus, a 93:7 mixture of (2*R*,3*S*)-**17** and (2*S*,3*S*)-**17** was obtained from the azidoalcohol (2*S*,3*S*)-**23**, while from (2*S*,3*R*)-**23**, a 7:93 mixture of (2*S*,3*R*)-**17** and (2*R*,3*R*)-**17** was produced independent of the amine (triethyl- vs diisopropylethylamine) used in the last step of the Swern reaction. Oxidation of structurally related azidoalcohols also led to partial epimerisation.³¹ Attempts at employing the Dess–Martin periodinane³² led to the formation of the aldehydes in low yield.

When the crude azidoaldehyde (2*R*,3*S*)-**17** was subjected to the base-catalysed phosphonylation with dialkyl phosphites (Scheme 5), 3:1 mixtures of C-1 diastereoisomeric phosphonates (1*S*,2*R*,3*S*)-**27a–30a** and (1*R*,2*R*,3*S*)-**27b–30b** were produced, respectively. They were contaminated with the phosphonates (1*R*,2*S*,3*S*)-**31a–34a** and (1*S*,2*S*,3*S*)-**31b–34b**, which were formed in 4:1 ratios. The ³¹P NMR spectra also allowed to calculate the ratio of the phosphonates (1*S*,2*R*,3*S*)-**27–30** to (1*S*,2*S*,3*S*)-**31–34** as ca. 85:15. This observation results from further epimerisation of the 4-azidoaldehyde (2*R*,3*S*)-**17** in the presence of a basic catalyst used in the Abramov reaction. Previously, we noticed similar process for the phosphonylation of Garner aldehyde.³³ Chromatographic purification on silica gel gave pure phosphonates (1*S*,2*R*,3*S*)-**27a** and (1*S*,2*R*,3*S*)-**28a** as colourless oils in 12 and 13% yields, respectively. From the

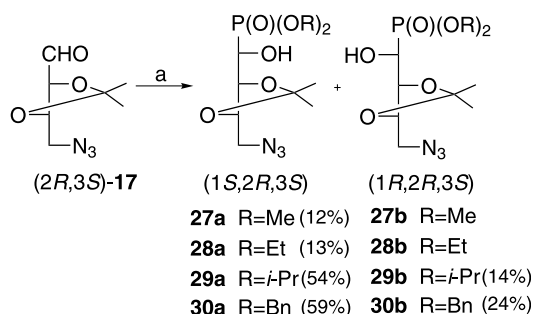

Scheme 5. Phosphonylation of (2*R*,3*S*)-**17**. Reagents and conditions: (a) $(\text{RO})_2\text{P(O)H}$, NEt_3 , rt, overnight.

crude mixtures of diastereoisomeric diisopropyl phosphonates, (1*S*,2*R*,3*S*)-**29a** and (1*R*,2*R*,3*S*)-**29b** were isolated in 54 and 14% yields, respectively. We were also successful in separating the dibenzyl phosphonates (1*S*,2*R*,3*S*)-**30a** (59%) and (1*R*,2*R*,3*S*)-**30b** (24%).

Base-catalysed phosphonylation of the 4-azidoaldehyde (2*R*,3*R*)-**17** with dialkyl phosphites (Scheme 6) gave 4:1 mixtures of diastereoisomeric phosphonates (1*S*,2*R*,3*R*)-**31a–34a** and (1*R*,2*R*,3*R*)-**31b–34b**. All mixtures of esters were contaminated with ca. 15% of the phosphonates (1*R*,2*S*,3*R*)-**31a–34a** and (1*S*,2*S*,3*R*)-**31b–34b**, which were formed in a 3:1 ratio. We were unable to purify the mixtures of dimethyl, diethyl and diisopropyl esters, mostly because of the presence of the phosphonates obtained from partially epimerised aldehydes. However, dibenzyl esters (1*S*,2*R*,3*R*)-**34a** and (1*R*,2*R*,3*R*)-**34b** were cleanly separated on a silica gel column in 59 and 15% yield, respectively.

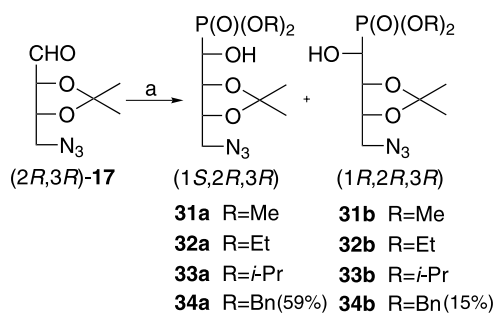

Scheme 6. Phosphonylation of (2*R*,3*R*)-**17**. Reagents and conditions: (a) (RO)₂P(O)H, NEt₃, rt, overnight.

Configurational assignments at C-1 in the diastereoisomeric pairs of phosphonates from the **a** and **b** series are based on the well-established stereochemistry of the addition of dialkyl phosphites to 2,3-*O*-isopropylidene(cyclohexylidene)-D-glyceraldehyde.^{34–36} From the protected (2*R*)-aldehydes, (1*S*,2*R*)-dihydroxyphosphonates were formed as the major diastereoisomers in approximately 3:1 ratios. To gather additional support, the isopropylidene acetal (1*S*,2*R*,3*S*)-**30a** was hydrolysed to the azidotriol (1*S*,2*R*,3*S*)-**35a**, which was acetylated to give the triacetate (1*S*,2*R*,3*S*)-**36a** (Scheme 7).

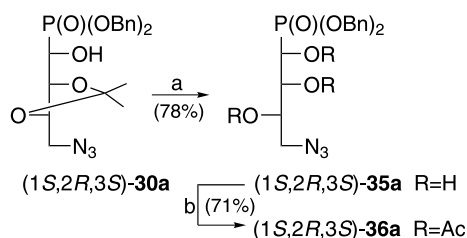

Scheme 7. Reagents and conditions: (a) MeOH, water, Dowex-50W×8 (H⁺), 75 °C, 4 h; (b) Ac₂O, NEt₃, DMAP, rt, overnight.

Detailed analyses of the ¹H and ¹H{³¹P} NMR spectra of the azidotriol [³J(H1–H2)=9.3 Hz; ³J(H2–H3)=1.5 Hz; ³J(H2–P)=9.0 Hz; ³J(C3–P)=11.3 Hz] and the respective triacetate [³J(H1–H2)=9.3 Hz; ³J(H2–H3)=2.4 Hz; ³J(H2–P)=11.4 Hz] led to the conclusion that they both exist in a preferred conformation^{37,38} depicted in Figure 2

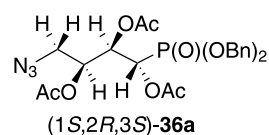
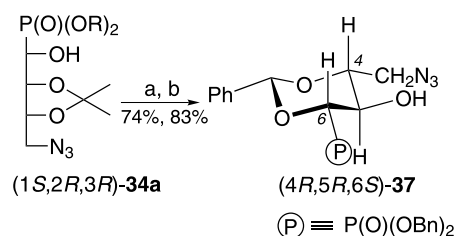

Figure 2. A preferred conformation of (1*S*,2*R*,3*S*)-**36a**.

and thus, the major phosphonates (1*S*,2*R*,3*S*)-**27a–30a** (Scheme 5) have 1*S* configuration at C-1.

The same approach to the assignment of the absolute configuration at C-1 in the phosphonate (1*S*,2*R*,3*R*)-**34a** failed, because the ¹H NMR spectrum of the respective azidotriacetate at 300 MHz was not amenable to the first-order analysis. However, when the trihydroxyphosphonate (1*S*,2*R*,3*R*)-**34a** was treated with an excess of benzaldehyde dimethyl acetal in the presence of *p*-toluenesulfonic acid, a clean transformation to a single product was observed by ³¹P NMR spectroscopy after 36 h at room temperature. Purification on a silica gel column followed by crystallisation gave fluffy needles, which were identified by ¹H and ¹³C NMR as (4*R*,5*R*,6*S*)-4-azidomethyl-6-(*O*,*O*-dibenzylphosphoryl)-5-hydroxy-2-phenyl-1,3-dioxane **37** (Scheme 8).



Scheme 8. Reagents and conditions: (a) MeOH, water, Dowex-50W×8 (H⁺), 75 °C, 4 h; (b) PhCH(OMe)₂, TsOH, CDCl₃, 48 h.

A list of structurally important data extracted from ¹H and ¹³C NMR spectra of (4*R*,5*R*,6*S*)-**37** includes: ³J(H5–H6)=9.8 Hz, δ(C2)=102.0 ppm, ³J(P–C2)=14.6 Hz, ³J(P–C4)=14.0 Hz and ⁴J(P–CH₂N₃)=2.9 Hz.^{40–45} On these basis we learned about diaxial disposition of H5 and H6 protons and, in consequence, the equatorial position of the *O*,*O*-dibenzylphosphoryl group, which was further supported by observation of large vicinal P–C couplings to C2 and C4. Furthermore, the appearance of a four-bond *P*-CH₂N₃ coupling (W-coupling) clearly shows that the formation of conformationally rigid 1,3-dioxane ring forced the acyclic azidotriol (1*S*,2*R*,3*R*)-**35** to adapt fully extended zig-zag conformation.

Transformation of pure dibenzyl esters (1*S*,2*R*,3*S*)-**30a**, (1*R*,2*R*,3*S*)-**30b** and (1*S*,2*R*,3*R*)-**34a** into the respective 4-amino-1,2,3-trihydroxybutylphosphonic acids (1*S*,2*R*,3*S*)-**16**, (1*R*,2*R*,3*S*)-**16** and (1*S*,2*R*,3*R*)-**16** was accomplished in two steps involving acetal hydrolysis and catalytic hydrogenation of azides with simultaneous hydrogenolysis of the benzyl esters (Scheme 9). The intermediate dibenzyl 4-azido-1,2,3-trihydroxybutylphosphonates **35** were isolated in 74–86% yields as white amorphous solids. The final acids **16** appeared as creamy powders, which decomposed before melting. They were insoluble in all solvents including DMSO and only sparingly soluble in water to afford concentrations suitable for taking ¹H and ³¹P

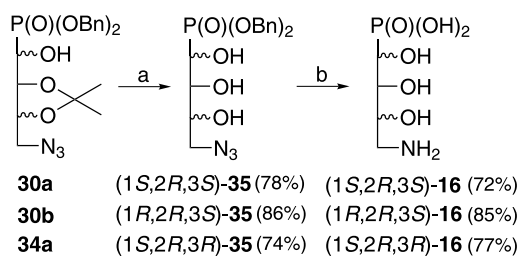

Scheme 9. Reagents and conditions: (a) MeOH–water, Dowex-50W \times 8 (H⁺), 75 °C, 4 h; (b) H₂, Pd/C, MeOH–water, 24–48 h.

NMR spectra only, but preventing ¹³C NMR and optical activity measurements. However, optical activity of the acids **16** was measured for solutions in 5% ammonia.

3. Conclusions

Two new four-carbon chiral diols, 4-azido-4-deoxy-2,3-*O*-isopropylidene-*L*-threose, (2*R*,3*S*)-**17** and 4-azido-4-deoxy-2,3-*O*-isopropylidene-*D*-erythrose, (2*R*,3*R*)-**17**, were synthesised from *L*-tartrate and *D*-isoscovric acid, respectively. They were partially (up to 7%) epimerised during oxidation under Swern conditions. Diastereoselectivities of the additions of dimethyl, diethyl, diisopropyl and dibenzyl phosphites to (2*R*,3*S*)-**17** were 3:1, while to (2*R*,3*R*)-**17** – 4:1. Only mixtures of dibenzyl (1*S*,2*R*,3*S*)-, (1*R*,2*R*,3*S*)-, (1*S*,2*R*,3*R*)- and (1*R*,2*R*,3*R*)-4-azido-2,3-*O*-isopropylidene-1-hydroxybutylphosphonates **30** and **34** were easily separable into pure C-1 epimeric 1-hydroxyphosphonates. The absolute configurations at C-1 were unequivocally established by detailed analysis of NMR spectra of dibenzyl (1*S*,2*R*,3*S*)-4-azido-1,2,3-triacetoxybutylphosphonate and (4*R*,5*R*,6*S*)-4-azidomethyl-6-(*O*,*O*-dibenzylphosphoryl)-5-hydroxy-2-phenyl-1,3-dioxane. The dibenzyl esters were transformed in two steps into the respective (1*S*,2*R*,3*S*)-, (1*R*,2*R*,3*S*)- and (1*S*,2*R*,3*R*)-4-amino-1,2,3-trihydroxybutylphosphonic acids by hydrolysis of the isopropylidene acetals followed by the reduction of the azide and hydrolysis of the benzyl residues.

4. Experimental

4.1. General

General procedures and instrumentation have been described earlier.³⁹

4.1.1. (2*S*,3*S*)-2,3-*O*-Isopropylidene-1,2,3,4-butanetriol, (2*S*,3*S*)-21**.** To a solution of diethyl *L*-tartrate (4.71 g, 22.8 mmol) and ethyl orthoformate (5.0 mL, 30 mmol) in anhydrous acetone (6.0 mL), 3.5 M HCl in ethyl acetate (0.25 mL) was added and the reaction mixture was kept at room temperature for 4 days. After neutralisation with triethylamine, the mixture was concentrated, diluted with ether (60 mL), the solution was washed with water (3 \times 20 mL) and finally dried over MgSO₄. Evaporation of all volatiles in vacuo gave crude diethyl 2,3-*O*-isopropylidene-*L*-tartrate **18** (3.67 g, 84%) as a yellowish oil, which was pure enough to be used in the next step.

To a solution of **18** (3.67 g, 14.9 mmol) in a THF–ethanol mixture (1/2, v/v, 105 mL) containing lithium chloride (3.80 g, 89.6 mmol), sodium borohydride (3.39 g, 89.6 mmol) was added portionwise below 5 °C. After stirring for 20 h at room temperature, acetone (24 mL) was added to quench an excess of borohydride and all precipitates were removed by filtration through a layer of Celite. The solution was concentrated in vacuo and the crude product was chromatographed on a silica gel column with methylene chloride–methanol (50/1, v/v) to give (2*S*,3*S*)-**21**²³ (2.08 g, 86%) as a colourless oil. ¹H NMR (CDCl₃): δ = 4.03–4.00 (m, 2H, H–C-2, H–C-3), 3.85–3.66 (m, 4H, CH₂OH), 2.5–2.3 (br s), 1.44 (s, 6H, CH₃).

4.1.2. (2*S*,3*S*)-4-Azido-2,3-*O*-isopropylidene-1,2,3-butane-triol, (2*S*,3*S*)-23**.** A suspension of the diol (2*S*,3*S*)-**21** (1.13 g, 6.97 mmol), silver(I) oxide (2.42 g, 10.5 mmol), tosyl chloride (1.46 g, 7.67 mmol) and potassium iodide (0.231 g, 1.39 mmol) in methylene chloride (40 mL) was stirred at room temperature for 2 h. Solids were filtered off on a short layer of silica gel using ethyl acetate. Evaporation of solvents in vacuo afforded a crude monotosylate (2*S*,3*S*)-**22** (2.20 g, 100%) as a colourless oil. ¹H NMR (CDCl₃): δ = 7.82–7.78 (m, 2H), 7.37–7.34 (m, 2H), 4.16–4.07 (m, 3H), 3.98 (ddd, J = 7.5, 4.2, 3.6 Hz, 1H), 3.81 (ddd, J_{AB} = 11.9 Hz, J = 5.0, 3.6 Hz, 1H), 3.63 (ddd, J_{AB} = 11.9 Hz, J = 7.7, 4.2 Hz, 1H), 2.48 (s, 3H), 1.96 (br s, 1H), 1.92 (s, 3H), 1.35 (s, 3H).

A solution of the crude monotosylate (2*S*,3*S*)-**22** (2.20 g, 6.97 mmol) in DMF (15 mL) was stirred with sodium azide (0.680 g, 10.5 mmol) at 80 °C for 24 h. The reaction mixture was washed with water (20 mL) and aqueous phase was extracted with methylene chloride (4 \times 30 mL). The combined organic phases were dried over MgSO₄, solvents were removed in vacuo, and the crude azide was purified on a silica gel column with ethyl acetate–hexanes to furnish (2*S*,3*S*)-**23**²⁵ (1.26 g, 94%) as a colourless oil. ¹H NMR (CDCl₃): δ = 4.15–3.96 (m, 2H), 3.83 (dd, J = 11.9, 3.6 Hz, 1H, CH_aH_bO), 3.65 (dd, J = 11.9, 3.8 Hz, 1H, CH_aH_bO), 3.57 (dd, J = 13.1, 3.8 Hz, 1H, CH_aH_bN), 3.34 (dd, J = 13.1, 4.8 Hz, 1H, CH_aH_bN), 2.17 (br s, 1H), 1.47 (s, 3H), 1.44 (s, 3H).

4.1.3. Methyl (2*R*,3*R*)-4-azido-1,2-dihydroxy-2,3-*O*-isopropylidenebutanoate, (2*R*,3*R*)-26**.** A mixture of 2,3-*O*-isopropylidene-*D*-erythronolactone^{27,28} (1.08 g, 6.81 mmol) and sodium azide (1.77 g, 27.2 mmol) in DMF (7.5 mL) was stirred at 110 °C for 24 h. After cooling to room temperature, the solids were filtered off. The solution was treated with methyl iodide (40 mL) and kept at room temperature for 2 days. Ether (100 mL) was added and the solution was washed with water (3 \times 60 mL). The organic phase was dried over MgSO₄, concentrated in vacuo and the crude product was purified on a silica gel column with chloroform–methanol (100/1, v/v) to afford (2*R*,3*R*)-**26** (0.764 g, 52%). IR (film): ν = 2995, 2962, 2101, 1731, 1438, 1212 cm⁻¹. [α]_D²⁰ +78.9 (*c* 1.42, CHCl₃). ¹H NMR (CDCl₃): δ = 4.67 (d, J = 7.2 Hz, 1H, H–C-2), 4.52 (ddd, J = 7.2 Hz, 6.0, 3.9 Hz, 1H, H–C-3), 3.49 (dd, J_{AB} = 13.2 Hz, J = 3.9 Hz, 1H, H_aH_bC-4), 3.32 (dd, J_{AB} = 13.2 Hz, J = 6.0 Hz, 1H, H_aH_bC-4), 1.40 (s, 3H), 1.63 (s, 3H). ¹³C NMR (CDCl₃): δ = 169.7, 111.3, 76.6, 75.4, 52.5,

50.5, 27.0, 25.5. Anal. Calcd for $C_8H_{13}N_3O_4 \times \frac{1}{4}H_2O$: C, 43.73; H, 5.96; N, 19.12. Found: C, 43.50; H, 5.72; N, 19.09%.

4.1.4. (2S,3R)-4-Azido-2,3-O-isopropylidene-1,2,3-butane-triol, (2S,3R)-23. To a solution of (2R,3R)-26 (0.565 g, 2.63 mmol) in a THF–ethanol mixture (1/2, v/v, 30 mL) containing lithium chloride (0.334 g, 7.88 mmol), sodium borohydride (0.298 g, 7.88 mmol) was added portionwise below 5 °C. After stirring for 24 h at room temperature, acetone (10 mL) was added to quench an excess of borohydride and all precipitates were removed by filtration through a layer of Celite. The solution was concentrated in vacuo and the crude product was chromatographed on a silica gel column with methylene chloride–methanol (100/1, v/v) to give (2S,3R)-23 (0.483 g, 98%) as a colourless oil. IR (film): $\nu = 3315, 2991, 2972, 2110, 1425, 1217 \text{ cm}^{-1}$. $[\alpha]_D^{20} + 16.8$ (c 0.92, $CHCl_3$). 1H NMR ($CDCl_3$): $\delta = 4.30\text{--}4.18$ (m, 2H), 3.69 (dd, $J_{AB} = 11.7 \text{ Hz}$, $J = 4.8 \text{ Hz}$, 1H, CH_aH_bO), 3.66 (dd, $J_{AB} = 11.7 \text{ Hz}$, $J = 5.1 \text{ Hz}$, 1H, CH_aH_bO), 3.46 (dd, $J = 12.6, 6.6 \text{ Hz}$, 1H, CH_aH_bN), 3.36 (dd, $J = 12.6, 4.8 \text{ Hz}$, 1H, CH_aH_bN), 1.45 (s, 3H), 1.33 (s, 3H). ^{13}C NMR ($CDCl_3$): $\delta = 109.1, 77.0, 75.8, 60.8, 50.9, 27.0, 25.3$. Anal. Calcd for $C_7H_{13}N_3O_3$: C, 44.91; H, 7.00; N, 22.45. Found: C, 44.62; H, 6.93; N, 22.57%.

4.1.5. (2R,3S)-4-Azido-2,3-O-isopropylidene-2,3-dihydroxybutanal (4-azido-4-deoxy-2,3-O-isopropylidene-L-threose), (2R,3S)-17. To a solution of oxalyl chloride (0.473 mL, 5.42 mmol) in methylene chloride (10 mL) cooled to -70°C a solution of DMSO (0.807 mL, 11.4 mmol) in methylene chloride (4.0 mL) was added dropwise followed, after 15 min, by a solution of (2S,3S)-23 (0.819 g, 4.37 mmol) in methylene chloride (4.0 mL). After stirring for 2 h at -70°C , triethylamine (1.8 mL, 13.1 mmol) was injected at this temperature and the reaction mixture was allowed to reach 0 °C, when it was treated with a saturated solution of NH_4Cl (10 mL). The reaction mixture was extracted with methylene chloride ($3 \times 20 \text{ mL}$), organic phases were combined, dried over $MgSO_4$ and concentrated in vacuo to give a crude aldehyde (2R,3S)-17 as a yellowish oil (1.12 g), which was immediately used in the next step. 1H NMR ($CDCl_3$): $\delta = 9.81$ (d, $J = 0.6 \text{ Hz}$, 1H, CHO), 4.26–4.24 (m, 2H), 3.69–3.64 (m, 1H), 3.36–3.30 (m, 1H), 1.55 (s, 3H), 1.43 (s, 3H).

4.1.6. (2R,3R)-4-Azido-2,3-O-isopropylidene-2,3-dihydroxybutanal(4-azido-4-deoxy-2,3-O-isopropylidene-D-erythrose), (2R,3R)-17. In a similar way as described for (2R,3S)-17 (Section 4.1.5), from (2S,3R)-23 (0.955 g, 5.10 mmol), the crude aldehyde (2R,3R)-17 (1.10 g) was obtained as a yellowish oil. 1H NMR ($CDCl_3$): $\delta = 9.76$ (d, $J = 2.1 \text{ Hz}$, 1H, CHO), 4.59 (ddd, $J = 8.1, 4.2, 3.3 \text{ Hz}$, 1H, H–C-3), 4.42 (dd, $J = 8.1, 2.1 \text{ Hz}$, 1H, H–C-2), 3.59 (dd, $J = 13.5, 3.3 \text{ Hz}$, 1H, H_aH_bC-4), 3.22 (dd, $J = 13.5, 4.2 \text{ Hz}$, 1H, H_aH_bC-4), 1.64 (s, 3H), 1.42 (s, 3H).

4.2. Phosphonylation of the aldehydes 17 (general procedure)

To the crude aldehyde 17 (1.0 mmol), dialkyl phosphite was added followed by triethylamine (0.1 mmol) and the reaction mixture was left at room temperature for 24 h.

All volatiles were removed in vacuo, the crude 1-hydroxyphosphonates were analysed by 1H and ^{31}P NMR spectroscopy and later subjected to column chromatography on silica gel.

4.2.1. Dimethyl (1S,2R,3S)-4-azido-1,2,3-trihydroxy-2,3-O-isopropylidenebutylphosphonate, (1S,2R,3S)-27a.

According to the general procedure, from the aldehyde (2R,3S)-17 (1.09 g, 5.89 mmol) and dimethyl phosphite (0.45 mL, 5.9 mmol), a 3:1 mixture of the phosphonates (1S,2R,3S)-27a and (1R,2R,3S)-27b (1.14 g) was obtained. After chromatography with ethyl acetate–hexanes (1/1, v/v), (1S,2R,3S)-27a was separated (0.204 g, 12%) as a yellowish oil. IR (film): $\nu = 3304, 2103, 1224, 1051 \text{ cm}^{-1}$. $[\alpha]_D^{20} - 67.7$ (c 1.21, $CHCl_3$). 1H NMR ($CDCl_3$): $\delta = 4.35$ (ddd, $J = 7.3, 5.2, 2.8 \text{ Hz}$, 1H, H–C-3), 4.17 (ddd, $J = 7.3, 6.0, 6.0 \text{ Hz}$, 1H, H–C-2), 4.10 (dd, $J = 7.9, 6.0 \text{ Hz}$, 1H, H–C-1), 3.84 (d, $J = 10.5 \text{ Hz}$, 6H), 3.70 (dd, $J = 13.2, 2.8 \text{ Hz}$, 1H, H_aH_bC-4), 3.42 (dd, $J = 13.2, 5.2 \text{ Hz}$, 1H, H_aH_bC-4), 1.48 (s, 3H), 1.44 (s, 3H). ^{13}C NMR ($CDCl_3$): $\delta = 110.3, 78.2$ (d, $J = 9.4 \text{ Hz}$), 76.4 (d, $J = 5.4 \text{ Hz}$), 68.6 (d, $J = 160.9 \text{ Hz}$, C-1), 54.0 and 53.7 (2d, $J = 7.0 \text{ Hz}$, COP), 52.7 (s, C-4), 27.3, 27.2. ^{31}P NMR ($CDCl_3$): $\delta = 24.65$. Anal. Calcd for $C_6H_{18}N_3O_6P$: C, 36.62; H, 6.14; N, 14.23. Found: C, 36.82; H, 6.12; N, 14.45%.

4.2.2. Diethyl (1S,2R,3S)-4-azido-1,2,3-trihydroxy-2,3-O-isopropylidenebutylphosphonate, (1S,2R,3S)-28a.

From the aldehyde (2R,3S)-17 (1.02 g, 5.55 mmol) and diethyl phosphite (0.71 mL, 5.55 mmol), a 3:1 mixture of the phosphonates (1S,2R,3S)-28a and (1R,2R,3S)-28b (1.59 g) was obtained. After chromatography with ethyl acetate–hexanes (1/1, v/v), (1S,2R,3S)-28a was separated (0.228 g, 13%) as colourless plates. Mp $58\text{--}59^\circ\text{C}$. IR (film): $\nu = 3229, 2991, 2935, 2117, 1223, 1031 \text{ cm}^{-1}$. $[\alpha]_D^{20} - 59.4$ (c 1.37, $CHCl_3$). 1H NMR ($CDCl_3$): $\delta = 4.36$ (ddd, $J = 7.5, 5.2, 2.6 \text{ Hz}$, 1H, H–C-3), 4.25–4.15 (m, 5H, CH_2OP , H–C-2), 4.08 (dd, $J = 8.5, 5.6 \text{ Hz}$, 1H, H–C-1), 3.71 (dd, $J = 13.3, 2.7 \text{ Hz}$, 1H, H_aH_bC-4), 3.44 (dd, $J = 13.3, 5.3 \text{ Hz}$, 1H, H_aH_bC-4), 1.48 (s, 3H), 1.44 (s, 3H), 1.36 (t, $J = 7.0 \text{ Hz}$, 6H, CH_3CH_2). ^{13}C NMR ($CDCl_3$): $\delta = 110.1, 77.7$ (d, $J = 6.8 \text{ Hz}$), 76.7 (d, $J = 6.0 \text{ Hz}$), 68.5 (d, $J = 161.5 \text{ Hz}$, C-1), 63.6 and 63.3 (2d, $J = 7.0 \text{ Hz}$, COP), 52.7 (s, C-4), 27.3, 27.2, 16.8 and 16.7 (2d, $J = 2.3 \text{ Hz}$, CCOP). ^{31}P NMR ($CDCl_3$): $\delta = 21.30$. Anal. Calcd for $C_{11}H_{22}N_3O_6P$: C, 40.86; H, 6.86; N, 13.00. Found: C, 41.03; H, 7.05; N, 13.13%.

4.2.3. Diisopropyl (1S,2R,3S)- and (1R,2R,3S)-4-azido-1,2,3-trihydroxy-2,3-O-isopropylidenebutylphosphonates, (1S,2R,3S)-29a and (1R,2R,3S)-29b.

These compounds were obtained according to the general procedure using the aldehyde (2R,3S)-17 (0.96 g, 5.2 mmol) and diisopropyl phosphite (0.77 g, 4.7 mmol). A 3:1 mixture of the phosphonates (1S,2R,3S)-29a and (1R,2R,3S)-29b was subjected to chromatography on a silica gel column with chloroform–methanol (150/1, v/v) to give (1S,2R,3S)-29a (0.987 g, 54%) and (1R,2R,3S)-29b (0.266 g, 14%), both as colourless needles.

The phosphonate (1S,2R,3S)-29a. Mp $91\text{--}92^\circ\text{C}$, from hexanes. IR (KBr): $\nu = 3180, 2982, 2933, 2101, 1216, 1016 \text{ cm}^{-1}$. $[\alpha]_D^{20} - 57.6$ (c 1.21, $CHCl_3$). 1H NMR

(CDCl₃): δ =4.86–4.69 (m, 2H), 4.38 (ddd, J =7.5, 5.1, 2.7 Hz, 1H, H–C-3), 4.18 (ddd, J =7.5, 5.1, 3.6 Hz, 1H, H–C-2), 4.04 (dd, J =9.6, 5.1 Hz, 1H, H–C-1), 3.73 (dd, J =13.2, 2.7 Hz, 1H, H_aH_bC-4), 3.45 (dd, J =13.2, 5.1 Hz, 1H, H_aH_bC-4), 1.48 (s, 3H), 1.44 (s, 3H), 1.36 (d, J =6.3 Hz, 3H), 1.35 (d, J =6.3 Hz, 9H). ¹³C NMR (CDCl₃): δ =109.9, 77.1 (d, J =6.8 Hz), 76.8 (d, J =6.0 Hz), 72.4 and 72.1 (2d, J =7.2 Hz, COP), 68.4 (d, J =163.8 Hz, C-1), 52.6 (s, C-4), 27.3, 27.2, 24.5 (d, J =3.0 Hz, CCOP), 24.4 (d, J =3.0 Hz, CCOP), 24.2 (d, J =4.5 Hz, CCOP) and 24.1 (d, J =5.3 Hz, CCOP). ³¹P NMR (CDCl₃): δ =20.12. Anal. Calcd for C₁₃H₂₆N₃O₆P: C, 44.44; H, 7.46; N, 11.96. Found: C, 44.75; H, 7.71; N, 11.91%.

The phosphonate (1R,2R,3S)-29b. Mp 54–56 °C, from hexanes. IR (film): ν =3284, 2985, 2935, 2103, 1219, 997 cm⁻¹. $[\alpha]_D^{20}$ –47.5 (c 2.53, CHCl₃). ¹H NMR (CDCl₃): δ =4.85–4.73 (m, 2H), 4.28–4.20 (m, 2H, H–C-3, H–C-2), 3.75 (dd, J =11.4, 2.7 Hz, 1H, H–C-1), 3.59 (dd, J =13.2, 3.3 Hz, 1H, H_aH_bC-4), 3.39 (dd, J =13.2, 4.5 Hz, 1H, H_aH_bC-4), 1.48 (s, 3H), 1.45 (s, 3H), 1.37 (d, J =6.3 Hz, 3H), 1.36 (d, J =6.0 Hz, 6H), 1.34 (d, J =6.3 Hz, 3H). ¹³C NMR (CDCl₃): δ =110.5, 77.3 (C-2), 76.0 (d, J =11.3 Hz, C-3), 72.3 and 72.0 (2d, J =6.8 Hz, COP), 67.4 (d, J =163.1 Hz, C-1), 51.8 (s, C-4), 27.3, 27.3, 24.6 (d, J =3.0 Hz, CCOP), 24.4 (d, J =3.8 Hz, CCOP), 24.3 (d, J =5.3 Hz, CCOP) and 24.1 (d, J =5.3 Hz, CCOP). ³¹P NMR (CDCl₃): δ =19.88. Anal. Calcd for C₁₃H₂₆N₃O₆P: C, 44.44; H, 7.46; N, 11.96. Found: C, 44.71; H, 7.72; N, 11.78%.

4.2.4. Dibenzyl (1S,2R,3S)- and (1R,2R,3S)-4-azido-1,2,3-trihydroxy-2,3-O-isopropylidenebutylphosphonates, (1S,2R,3S)-30a and (1R,2R,3S)-30b. According to the general procedure employing the aldehyde (2R,3S)-17 (0.476 g, 2.57 mmol) and dibenzylphosphite (0.606 g, 2.31 mmol), a 3:1 mixture of the phosphonates (1S,2R,3S)-30a and (1R,2R,3S)-30b was obtained. After purification on a silica gel column with chloroform–ethyl acetate–methanol (200/1/0.5, v/v), (1S,2R,3S)-30a (0.683 g, 59%) as a white powder and (1R,2R,3S)-30b (0.274 g, 24%) as a colourless oil were obtained.

The phosphonate (1S,2R,3S)-30a. Mp 105–106 °C, from ethyl acetate–hexanes. IR (KBr): ν =3222, 2995, 2923, 2102, 1271, 1222, 997, 744, 698 cm⁻¹. $[\alpha]_D^{20}$ –47.8 (c 1.28, CHCl₃). ¹H NMR (CDCl₃): δ =7.37–7.26 (m, 10H), 5.14–5.02 (m, 4H, CH₂OP), 4.31 (ddd, J =7.5, 5.0, 3.0 Hz, 1H, H–C-3), 4.17 (ddd, J =7.5, 6.0, 4.5 Hz, 1H, H–C-2), 4.09 (dd, J =7.5, 6.0 Hz, 1H, H–C-1), 3.62 (dd, J =13.2, 3.0 Hz, 1H, H_aH_bC-4), 3.35 (dd, J =13.2, 5.1 Hz, 1H, H_aH_bC-4), 1.44 (s, 3H), 1.38 (s, 3H). ¹³C NMR (CDCl₃): δ =135.8 and 135.8 (2d, J =6.0 Hz, C_{ipso}), 128.7, 128.7, 128.6, 128.1, 128.0, 110.3, 78.1 (d, J =9.4 Hz), 76.5 (d, J =5.4 Hz), 69.1 (d, J =160.6 Hz, C-1), 68.8 and 68.6 (2d, J =7.2 Hz, COP), 52.6 (s, C-4), 27.3, 27.2. ³¹P NMR (CDCl₃): δ =22.96. Anal. Calcd for C₂₁H₂₆N₃O₆P: C, 56.37; H, 5.86; N, 9.39. Found: C, 56.41; H, 5.92; N, 9.41%.

The phosphonate (1R,2R,3S)-30b. IR (film): ν =3259, 2988, 2934, 2103, 1242, 1217, 1018, 737, 698 cm⁻¹. $[\alpha]_D^{20}$ –46.2 (c 2.50, CHCl₃). ¹H NMR (CDCl₃): δ =7.38–7.26 (m, 10H), 5.18–5.03 (m, 4H, CH₂OP), 4.26–4.18 (m, 2H, H–C-2, H–C-3), 3.85 (dd, J =11.6, 2.1 Hz, 1H, H–C-1), 3.49 (dd, J =

13.2, 3.6 Hz, 1H, H_aH_bC-4), 3.35 (dd, J =13.2, 4.5 Hz, 1H, H_aH_bC-4), 1.45 (s, 3H), 1.39 (s, 3H). ¹³C NMR (CDCl₃): δ =136.2 and 136.0 (2d, J =6.0 Hz, C_{ipso}), 128.7, 128.7, 128.6, 128.1, 128.1, 110.6, 77.0 (s, C-2), 75.6 (d, J =11.3 Hz, C-3), 68.7 and 68.5 (2d, J =6.9 Hz, COP), 67.3 (d, J =161.2 Hz, C-1), 51.6 (s, C-4), 27.3, 27.1. ³¹P NMR (CDCl₃): δ =22.79. Anal. Calcd for C₂₁H₂₆N₃O₆P: C, 56.37; H, 5.86; N, 9.39. Found: C, 56.23; H, 5.81; N, 9.61%.

4.2.5. Dimethyl (1S,2R,3R)- and (1R,2R,3R)-4-azido-1,2,3-trihydroxy-2,3-O-isopropylidenebutylphosphonates, (1S,2R,3R)-31a and (1R,2R,3R)-31b. According to the general procedure, from the aldehyde (2R,3R)-17 (0.263 g, 1.42 mmol) and dimethyl phosphite (0.117 mL, 1.28 mmol), a 4:1 mixture of the phosphonates (1S,2R,3R)-31a and (1R,2R,3R)-31b (0.419 g) was obtained. After chromatography with chloroform–methanol (150/1–100/1, v/v) only minute quantities of impure (1S,2R,3R)-31a (purity ca. 90%) and (1R,2R,3R)-31b (purity ca. 90%) were separated as yellowish oils.

The phosphonate (1S,2R,3R)-31a. ¹H NMR (CDCl₃): δ =4.44–4.32 (m, 2H, H–C-2, H–C-3), 4.04 (dd, J =9.0, 5.4 Hz, 1H, H–C-1), 3.84 and 3.83 (2d, J =10.5 Hz, 6H), 3.67 (dd, J =13.2, 3.3 Hz, 1H, H_aH_bC-4), 3.53 (dd, J =13.2, 7.5 Hz, 1H, H_aH_bC-4), 1.50 (s, 3H), 1.40 (s, 3H). ³¹P NMR (CDCl₃): δ =26.67.

The phosphonate (1R,2R,3R)-31b. ¹H NMR (CDCl₃): δ =4.54 (ddd, J =7.2, 5.1, 1.8 Hz, 1H, H–C-2), 4.38 (dddd, J =7.5, 7.2, 5.1, 1.8 Hz, 1H, H–C-3), 4.04 (dd, J =12.6, 1.8 Hz, 1H, H–C-1), 3.85 and 3.83 (2d, J =10.5 Hz, 6H), 3.71 (dd, J =12.6, 7.5 Hz, 1H, H_aH_bC-4), 3.50 (dd, J =12.6, 5.1 Hz, 1H, H_aH_bC-4), 1.55 (s, 3H), 1.41 (s, 3H). ³¹P NMR (CDCl₃): δ =24.31.

4.2.6. Diethyl (1S,2R,3R)- and (1R,2R,3R)-4-azido-1,2,3-trihydroxy-2,3-O-isopropylidenebutylphosphonates, (1S,2R,3R)-32a and (1R,2R,3R)-32b. From the aldehyde (2R,3R)-17 (208 mg, 1.12 mmol) and diethyl phosphite (0.13 mL, 1.0 mmol), a 4:1 mixture of the phosphonates (1S,2R,3R)-32a and (1R,2R,3R)-32b (0.463 g) was obtained. Attempts to purify the crude product by the silica gel chromatography with chloroform–methanol (200/1, v/v) failed.

4.2.7. Diisopropyl (1S,2R,3R)- and (1R,2R,3R)-4-azido-1,2,3-trihydroxy-2,3-O-isopropylidenebutylphosphonates, (1S,2R,3R)-33a and (1R,2R,3R)-33b. From the aldehyde (2R,3R)-17 (0.337 mg, 1.82 mmol) and diisopropyl phosphite (0.27 mL, 1.63 mmol), a 4:1 mixture of the phosphonates (1S,2R,3R)-33a and (1R,2R,3R)-33b was obtained (0.543 g). An attempt at purifying the crude product by the silica gel chromatography with chloroform–methanol (100/1, v/v) failed.

4.2.8. Dibenzyl (1S,2R,3R)- and (1R,2R,3R)-4-azido-1,2,3-trihydroxy-2,3-O-isopropylidenebutylphosphonates, (1S,2R,3R)-34a and (1R,2R,3R)-34b. According to the general procedure employing the aldehyde (2R,3R)-17 (0.945 g, 5.10 mmol) and dibenzylphosphite (1.34 g, 5.10 mmol), a 4:1 mixture of the phosphonates (1S,2R,3R)-34a and (1R,2R,3R)-34b was obtained. Purification on a

silica gel column with chloroform–ethyl acetate–methanol (200/1/0.5, v/v) gave (1*S*,2*R*,3*R*)-**34a** (1.34 g, 59%) and (1*R*,2*R*,3*R*)-**34b** (0.353 g, 15%) as white powders.

The phosphonate (1*S*,2*R*,3*R*)-34a. Mp 110.1–110.6 °C, from ethyl acetate–hexanes; IR (KBr): $\nu = 3212, 2088, 1484, 1240, 1140, 1056, 936 \text{ cm}^{-1}$. $[\alpha]_{\text{D}}^{20} + 25.8$ (c 1.18, CHCl₃). ¹H NMR (CDCl₃): $\delta = 7.37\text{--}7.26$ (m, 10H), 5.15–5.00 (m, 4H, CH₂OP), 4.43–4.34 (m, 2H, H–C-2, H–C-3), 4.05 (dd, $J = 9.3, 4.8 \text{ Hz}$, 1H, H–C-1), 3.60 (dd, $J = 13.2, 3.3 \text{ Hz}$, 1H, H_aH_bC-4), 3.46 (dd, $J = 13.2, 7.5 \text{ Hz}$, 1H, H_aH_bC-4), 1.42 (s, 3H), 1.34 (s, 3H). ¹³C NMR (CDCl₃): $\delta = 136.3$ and 136.2 (2d, $J = 5.7 \text{ Hz}$, C_{ipso}), 128.7, 128.7, 128.6, 128.6, 128.1, 128.0, 109.9, 77.3 (d, $J = 13.6 \text{ Hz}$, C-3), 75.5 (s, C-2), 68.8 and 68.6 (2d, $J = 7.2 \text{ Hz}$, COP), 66.7 (d, $J = 160.8 \text{ Hz}$, C-1), 51.0 (s, C-4), 28.1, 25.8. ³¹P NMR (CDCl₃): $\delta = 25.02$. Anal. Calcd for C₂₁H₂₆N₃O₆P: C, 56.37; H, 5.86; N, 9.39. Found: C, 56.26; H, 5.55; N, 9.65%.

The phosphonate (1*R*,2*R*,3*R*)-34b. Mp 78.2–79.0 °C, from diethyl ether–hexanes. IR (KBr): $\nu = 3241, 2079, 1472, 1249, 1130, 1059, 940 \text{ cm}^{-1}$. $[\alpha]_{\text{D}}^{20} + 36.0$ (c 1.03, CHCl₃). ¹H NMR (CDCl₃): $\delta = 7.37\text{--}7.32$ (m, 10H), 5.17–5.02 (m, 4H, CH₂OP), 4.55 (ddd, $J = 6.9, 5.1, 1.8 \text{ Hz}$, 1H, H–C-2), 4.31 (dddd, $J = 7.8, 6.9, 5.1, 1.8 \text{ Hz}$, 1H, H–C-3), 4.00 (dd, $J = 12.3, 1.8 \text{ Hz}$, 1H, H–C-1), 3.64 (dd, $J = 12.6, 7.8 \text{ Hz}$, 1H, H_aH_bC-4), 3.40 (dd, $J = 12.6, 5.1 \text{ Hz}$, 1H, H_aH_bC-4), 1.48 (s, 3H), 1.37 (s, 3H). ¹³C NMR (CDCl₃): $\delta = 136.2$ and 136.0 (2d, $J = 5.7 \text{ Hz}$, C_{ipso}), 128.6, 128.6, 128.6, 128.5, 128.4, 128.3, 128.1, 128.0, 109.4, 76.3 (d, $J = 13.7 \text{ Hz}$, C-3), 74.6 (d, $J = 1.4 \text{ Hz}$, C-2), 68.8 and 68.4 (2d, $J = 7.2 \text{ Hz}$, COP), 66.6 (d, $J = 160.9 \text{ Hz}$, C-1), 51.5 (s, C-4), 27.1, 24.9. ³¹P NMR (CDCl₃): $\delta = 22.69$. Anal. Calcd for C₂₁H₂₆N₃O₆P: C, 56.37; H, 5.86; N, 9.39. Found: C, 56.29; H, 5.59; N, 9.37%.

4.3. Dibenzyl 4-azido-1,2,3-trihydroxybutylphosphonates **35** (general procedure)

Enantiomerically pure dibenzyl 4-azido-1,2,3-trihydroxy-2,3-*O*-isopropylidenebutylphosphonates, (1*S*,2*R*,3*S*)-**30a** or (1*R*,2*R*,3*S*)-**30b** or (1*S*,2*R*,3*R*)-**34a** (0.40 mmol) were dissolved in aqueous methanol (20 mL) and Dowex 50W×4 (H⁺) (1.00 g) was added. The slurry was stirred at 70 °C for 4 h. Cooled solution was filtered, the resin was washed with methanol and water. After concentration the solid residue was crystallised from methanol–water to give pure dibenzyl 4-azido-1,2,3-trihydroxybutylphosphonates as white amorphous solids.

4.3.1. The phosphonate (1*S*,2*R*,3*S*)-35. From the phosphonate (1*S*,2*R*,3*S*)-**30a** (0.196 g, 0.438 mmol), the triol (1*S*,2*R*,3*S*)-**35** (0.140 g, 78%) was obtained. Mp 138.0–138.6 °C. IR (KBr): $\nu = 3384, 3288, 2096, 1488, 1256, 1240, 1140, 1040, 940 \text{ cm}^{-1}$. $[\alpha]_{\text{D}}^{20} + 17.4$ (c 1.04, CH₃OH). ¹H NMR (CD₃OD): $\delta = 7.37\text{--}7.28$ (m, 10H), 5.10 and 5.08 (2d, $J = 8.1 \text{ Hz}$, 4H, CH₂OP), 4.13 (dd, $J = 9.3, 4.5 \text{ Hz}$, 1H, H–C-1), 4.03 (dddd, $J = 7.8, 5.1, 1.5, 1.2 \text{ Hz}$, 1H, H–C-3), 3.80 (ddd, $J = 9.3, 9.0, 1.5 \text{ Hz}$, 1H, H–C-2), 3.47 (dd, $J = 12.6, 7.8 \text{ Hz}$, 1H, H_aH_bC-4), 3.31 (dd, $J = 12.6, 5.1 \text{ Hz}$, 1H, H_aH_bC-4). ¹³C NMR (CD₃OD): $\delta = 136.2$ and 136.0 (2d, $J = 5.7 \text{ Hz}$, C_{ipso}), 129.5, 129.4, 129.1, 129.0, 72.2 (d, $J = 2.3 \text{ Hz}$, C-2), 70.4 (d, $J = 11.3 \text{ Hz}$, C-3), 69.5 and 69.3 (2d, $J = 7.2 \text{ Hz}$, COP), 69.5 (d, $J = 163.8 \text{ Hz}$, C-1), 55.0 (s, C-4).

³¹P NMR (CD₃OD): $\delta = 26.45$. Anal. Calcd for C₁₈H₂₂N₃O₆P: C, 53.07; H, 5.44; N, 10.32. Found: C, 53.25; H, 5.34; N, 10.23%.

4.3.2. The phosphonate (1*R*,2*R*,3*S*)-35. From the phosphonate (1*R*,2*R*,3*S*)-**30b** (0.154 g, 0.342 mmol), the triol (1*R*,2*R*,3*S*)-**35** (0.120 g, 86%) was obtained. Mp 73.6–74.2 °C. IR (KBr): $\nu = 3361, 3276, 2101, 1481, 1247, 1231, 1150, 1037, 937 \text{ cm}^{-1}$. $[\alpha]_{\text{D}}^{20} - 2.6$ (c 1.03, CH₃OH). ¹H NMR (CD₃OD): $\delta = 7.42\text{--}7.31$ (m, 10H), 5.12 (d, $J = 8.0 \text{ Hz}$, 2H, CH₂OP), 5.07 (dd, $J = 8.1, 3.0 \text{ Hz}$, 2H, CH₂OP), 4.40 (dd, $J = 9.6, 3.9 \text{ Hz}$, 1H, H–C-1), 3.95–3.87 (m, 2H, H–C-3, H–C-2), 3.38 (d, $J = 5.4 \text{ Hz}$, 2H, H_aH_bC-4). ¹³C NMR (CD₃OD): $\delta = 137.8$ and 137.6 (2d, $J = 5.7 \text{ Hz}$, C_{ipso}), 129.6, 129.4, 129.1, 129.0, 128.7, 72.8 (d, $J = 10.6 \text{ Hz}$, C-3), 72.1 (d, $J = 3.8 \text{ Hz}$, C-2), 69.9 and 69.2 (2d, $J = 6.8 \text{ Hz}$, COP), 69.4 (d, $J = 162.3 \text{ Hz}$, C-1), 54.7 (s, C-4). ³¹P NMR (CD₃OD): $\delta = 24.02$. Anal. Calcd for C₁₈H₂₂N₃O₆P×H₂O: C, 50.83; H, 5.69; N, 9.89. Found: C, 50.72; H, 5.89; N, 9.82%.

4.3.3. The phosphonate (1*S*,2*R*,3*R*)-35. From the phosphonate (1*S*,2*R*,3*R*)-**34a** (0.173 g, 0.387 mmol), the triol (1*S*,2*R*,3*R*)-**35** (0.117 g, 74%) was obtained. Mp 113.1–113.8 °C, from methanol–water; IR (KBr): $\nu = 3352, 3269, 2090, 1474, 1251, 1242, 1139, 1042, 943 \text{ cm}^{-1}$. $[\alpha]_{\text{D}}^{20} + 3.1$ (c 1.8, CH₃OH). ¹H NMR (CD₃OD): $\delta = 7.39\text{--}7.28$ (m, 10H), 5.16–4.99 (m, 4H, CH₂OP), 4.25 (dd, $J = 8.4, 6.0 \text{ Hz}$, 1H, H–C-1), 4.07 (ddd, $J = 6.6, 6.6, 3.3 \text{ Hz}$, 1H, H–C-3), 3.91 (ddd, $J = 17.1, 6.6, 6.0 \text{ Hz}$, 1H, H–C-2), 3.48 (dd, $J = 13.0, 3.3 \text{ Hz}$, 1H, H_aH_bC-4), 3.41 (dd, $J = 13.0, 6.6 \text{ Hz}$, 1H, H_aH_bC-4). ¹³C NMR (CD₃OD): $\delta = 138.0$ and 137.9 (2d, $J = 5.7 \text{ Hz}$, C_{ipso}), 129.5, 129.4, 129.3, 129.0, 74.8 (d, $J = 2.0 \text{ Hz}$, C-2), 73.0 (d, $J = 6.9 \text{ Hz}$, C-3), 70.8 (d, $J = 161.6 \text{ Hz}$, C-1), 69.8 and 69.1 (2d, $J = 7.6 \text{ Hz}$, COP), 54.8 (s, C-4). ³¹P NMR (CD₃OD): $\delta = 26.26$. Anal. Calcd for C₁₈H₂₂N₃O₆P: C, 53.07; H, 5.44; N, 10.32. Found: C, 52.85; H, 5.19; N, 10.23%.

4.3.4. Dibenzyl 4-azido-1,2,3-triacetyloxybutylphosphonates, (1*S*,2*R*,3*S*)-36. Standard acetylation of the phosphonate (1*S*,2*R*,3*S*)-**35a** (0.043 g, 0.11 mmol) with acetic anhydride (0.035 mL, 0.37 mmol) in the presence of NEt₃ (0.052 mL, 0.37 mmol) and one crystal of DMAP in chloroform (1 mL) gave the crude triacetate (1*S*,2*R*,3*S*)-**36** (0.040 g; purity >95%) as a colourless oil. ¹H NMR (CDCl₃): $\delta = 7.38\text{--}7.25$ (m, 10H), 5.58 (ddd, $J = 11.4, 9.3, 2.4 \text{ Hz}$, 1H, H–C-2), 5.42 (dd, $J = 9.3, 7.5 \text{ Hz}$, 1H, H–C-1), 5.30 (ddd, $J = 7.2, 4.8, 2.4 \text{ Hz}$, 1H, H–C-3), 5.11–4.92 (m, 4H, CH₂OP), 3.39 (dd, $J = 13.2, 4.8 \text{ Hz}$, 1H, H_aH_bC-4), 3.31 (dd, $J = 13.2, 7.2 \text{ Hz}$, 1H, H_aH_bC-4), 2.08 (s, 3H), 2.02 (s, 3H), 1.98 (s, 3H). ³¹P NMR (CDCl₃): $\delta = 19.40$.

4.3.5. (4*R*,5*R*,6*S*)-4-azidomethyl-6-(*O*,*O*-dibenzylphosphoryl)-5-hydroxy-2-phenyl-1,3-dioxane, **37.** To a solution of the phosphonate (1*S*,2*R*,3*R*)-**35** (0.029 g, 0.071 mmol) in chloroform-*d* (0.7 mL) and benzaldehyde dimethyl acetal (0.021 mL, 0.14 mmol) a crystal of *p*-toluenesulfonic acid was added. The progress of the reaction was monitored by ³¹P NMR spectroscopy at room temperature for 48 h. After concentration the residue was chromatographed on a silica gel column with chloroform–methanol (100/1, v/v) to give (4*R*,5*R*,6*S*)-**37** (0.030 g, 83%) as a white solid, which was

recrystallised from ethyl acetate–petroleum ether. Mp 106.9–107.2 °C. IR (KBr): $\nu=3384, 3184, 2096, 1488, 1256, 1208, 1052, 976 \text{ cm}^{-1}$. $[\alpha]_{\text{D}}^{20} +21.3$ (*c* 0.96, CHCl_3). ^1H NMR (CDCl_3): $\delta=7.45\text{--}7.25$ (m, 15H), 5.47 (s, 1H, H–C-2), 5.20–5.07 (m, 4H, CH_2OP), 3.95 (dd, $J=9.8, 7.4$ Hz, 1H, H–C-6), 3.87–3.74 (m, 2H, H–C-4, H–C-5), 3.62 (dd, $J=13.2, 1.3$ Hz, 1H, $H_aH_b\text{C-N}$), 3.48 (s, 1H, HO) 3.47 (dd, $J=13.2, 4.6$ Hz, 1H, $H_aH_b\text{C-N}$). ^{13}C NMR (CDCl_3): $\delta=136.6, 135.7$ and 135.5 (2d, $J=5.7$ Hz, C_{ipso}), 129.4, 128.9, 128.8, 128.7, 128.4, 128.2, 128.1, 126.3, 102.0 (d, $J=14.6$ Hz, C-2), 80.6 (d, $J=14.0$ Hz, C-4), 76.8 (d, $J=166.6$ Hz, C-6), 69.6 and 69.0 (2d, $J=7.2$ Hz, COP), 62.8 (d, $J=2.3$ Hz, C-5), 51.4 (d, $J=2.9$ Hz, CH_2N_3). ^{31}P NMR (CDCl_3): $\delta=20.28$. Anal. Calcd for $\text{C}_{26}\text{H}_{26}\text{N}_3\text{O}_6\text{P}\times 0.5\text{H}_2\text{O}$: C, 60.46; H, 5.27; N, 8.14. Found: C, 60.22; H, 5.45; N, 8.15%.

4.4. 4-Amino-1,2,3-trihydroxybutylphosphonic acids **16** (general procedure)

Enantiomerically pure dibenzyl 4-azido-1,2,3-trihydroxybutylphosphonates, (1*S*,2*R*,3*S*)-**35** or (1*R*,2*R*,3*S*)-**35** or (1*S*,2*R*,3*R*)-**35** (0.25 mmol) were dissolved in methanol (10 mL) and 10% Pd/C (4 mg) was added. The slurry was stirred under hydrogen atmosphere at room temperature for 24–48 h. After 1 h distilled water (10 mL) was injected to make stirring possible. The catalyst was filtered off on a layer of Celite and the aqueous solution was concentrated in vacuo to give oily residues, which were crystallised from aqueous ethanol to afford creamy amorphous powders.

4.4.1. The phosphonic acid (1*S*,2*R*,3*S*)-16. From the phosphonate (1*S*,2*R*,3*S*)-**35** (0.103 g, 0.253 mmol), the phosphonic acid (1*S*,2*R*,3*S*)-**16** (0.037 g, 72%) was obtained. IR (KBr): $\nu=3500\text{--}2500$ (broad), 1632, 1536, 1140, 1080, 1052, 920 cm^{-1} . $[\alpha]_{\text{D}}^{20} +16.1$ (*c* 1.0, 5% ammonia). ^1H NMR (D_2O): $\delta=4.24$ (dd, $J=6.0, 6.0$ Hz, 1H, H–C-3), 3.84–3.75 (m, 2H, H–C-1, H–C-2), 3.26–3.16 (m, 2H, $H_aH_b\text{C-4}$). ^{31}P NMR (D_2O): $\delta=18.28$. Anal. Calcd for $\text{C}_4\text{H}_{12}\text{NO}_6\text{P}\times \text{H}_2\text{O}$: C, 21.92; H, 6.44; N, 6.39. Found: C, 21.99; H, 6.53; N, 6.16%.

4.4.2. The phosphonic acid (1*R*,2*R*,3*S*)-16. From the phosphonate (1*R*,2*R*,3*S*)-**35** (0.083 g, 0.20 mmol), the phosphonic acid (1*R*,2*R*,3*S*)-**16** (0.035 g, 85%) was obtained. IR (KBr): $\nu=3500\text{--}2500$ (broad), 1641, 1529, 1145, 1076, 1043, 925 cm^{-1} . $[\alpha]_{\text{D}}^{20} +2$ (*c* 0.9, 5% ammonia). ^1H NMR (D_2O): $\delta=4.20$ (ddd, $J=8.7, 3.9, 3.6$ Hz, 1H, H–C-3), 3.87–3.77 (m, 2H, H–C-1, H–C-2), 3.22 (dAB, $J_{\text{AB}}=13.0$ Hz, $J=3.9$ Hz, 1H, $H_aH_b\text{C-4}$), 3.17 (dAB, $J_{\text{AB}}=13.0$ Hz, $J=8.7$ Hz, 1H, $H_aH_b\text{C-4}$). ^{31}P NMR (D_2O): $\delta=17.07$. Anal. Calcd for $\text{C}_4\text{H}_{12}\text{NO}_6\text{P}$: C, 23.89; H, 6.01; N, 6.97. Found: C, 23.79; H, 5.71; N, 6.74%.

4.4.3. The phosphonic acid (1*S*,2*R*,3*R*)-16. From the phosphonate (1*S*,2*R*,3*R*)-**35** (0.079 g, 0.19 mmol), the phosphonic acid (1*S*,2*R*,3*R*)-**16** (0.030 g, 77%) was obtained. IR (KBr): $\nu=3500\text{--}2500$ (broad), 1637, 1534, 1139, 1085, 1055, 917 cm^{-1} . $[\alpha]_{\text{D}}^{20} +12.4$ (*c* 1.0, 5% ammonia). ^1H NMR (D_2O): $\delta=4.20$ (dd, $J=8.1, 2.6$ Hz, 1H, H–C-3), 4.05–3.85 (m, 2H, H–C-1, H–C-2), 3.38 (dAB, $J_{\text{AB}}=13.0$ Hz, $J=2.6$ Hz, 1H, $H_aH_b\text{C-4}$), 3.16 (dAB, $J_{\text{AB}}=13.0$ Hz, $J=8.1$ Hz, 1H, $H_aH_b\text{C-4}$). ^{31}P NMR (D_2O): $\delta=$

17.54. Anal. Calcd for $\text{C}_4\text{H}_{12}\text{NO}_6\text{P}\times \text{H}_2\text{O}$: C, 21.92; H, 6.44; N, 6.39. Found: C, 21.62; H, 6.58; N, 6.13%.

Acknowledgements

Financial support from the Medical University of Łódź (503-314-1 and 502-13-853) is gratefully acknowledged. The authors wish to express their gratitude to Mrs. Jolanta Płocka for her excellent technical assistance and to Mr. Rafał Janusz, MSc for his preliminary experiments in the synthesis of **27a**, **27b**, **28a** and **28b**.

References and notes

- Kukhar, V. P.; Hudson, H. P. *Aminophosphonic and Aminophosphinic Acids. Chemistry and Biological Activity*; Wiley: New York, 1999.
- Fregenhagen, A.; Angst, C.; Peter, H. H. *J. Antibiot.* **1995**, *48*, 1043–1045. Rapp, C.; Jung, G.; Kluger, M.; Loeffler, W. *Liebigs Ann. Chem.* **1988**, 655–661.
- Green, A.; Walls, S.; Wise, A.; Green, R. K.; Martin, A. K.; Marshall, F. H. *Br. J. Pharmacol.* **2000**, *131*, 1766–1774. Ong, J.; Marino, V.; Parker, D. A. S.; Kerr, D. I. B. *Naunyn-Schmiedeberg's Arch. Pharmacol.* **1998**, *357*, 408–412.
- Davies, J.; Francis, A. A.; Jones, A. W.; Watkins, J. C. *Neurosci. Lett.* **1981**, *21*, 77–81.
- Bräuner-Osborne, H.; Egebjerg, J.; Nielsen, E.Ø.; Madsen, U.; Krogsgaard-Larsen, P. *J. Med. Chem.* **2000**, *43*, 2609–2645.
- Bräuner-Osborne, H.; Krogsgaard-Larsen, P. *Br. J. Pharmacol.* **1998**, *123*, 269–274.
- Cox, R. J.; Gibson, J. S.; Mayo Martin, M. B. *Chem. BioChem.* **2002**, *3*, 874–886.
- Adams, L. A.; Charmant, J. P. H.; Cox, R. J.; Walter, M.; Whittingham, W. G. *Org. Biomol. Chem.* **2004**, *2*, 542–553.
- Wehbe, J.; Rolland, V.; Fruchier, A.; Roumestant, M.-L.; Martinez, J. *Tetrahedron: Asymmetry* **2004**, *15*, 851–858.
- Fagg, G. E.; Olpe, H. R.; Pozza, M. F.; Baud, J.; Steinmann, M.; Schmutz, M.; Portet, C.; Baumann, P.; Thedinga, K.; Bittiger, H. *Br. J. Pharmacol.* **1990**, *99*, 791–797.
- Allan, R. D.; Hanrahan, J. R.; Hambley, T. W.; Johnston, G. A.; Mewett, K. N.; Mitrovic, A. D. *J. Med. Chem.* **1990**, *33*, 2905–2915.
- Hanrahan, J. R.; Taylor, P. C.; Errington, W. *J. Chem. Soc., Perkin Trans. 1* **1997**, 493–502.
- Hutchison, A. J.; Williams, M.; Angst, C.; de Jesus, R.; Blanchard, L.; Jackson, R. H.; Wilusz, E. J.; Murphy, D. E.; Bernard, P. S.; Schneider, J.; Campbell, T.; Guida, W.; Sills, M. A. *J. Med. Chem.* **1989**, *32*, 2171–2178.
- Claesson, A.; Swahn, B.-M.; Edvinsson, K. M.; Molin, H.; Sandberg, M. *Bioorg. Med. Chem. Lett.* **1992**, *2*, 1247–1250.
- Swahn, B.-M.; Edvinsson, K. M.; Kallin, E.; Larsson, U.; Berge, O.-G.; Molin, H.; Pelcman, B.; Claesson, A. *Bioorg. Med. Chem.* **1997**, *5*, 1293–1299.
- Whitten, J. P.; Muench, D.; Cube, R. V.; Nyce, P. L.; Baron, B. M.; McDonald, I. A. *Bioorg. Med. Chem. Lett.* **1991**, *1*, 441–444.
- Cox, J. M.; Hawkes, T. R.; Bellini, P.; Ellis, R. M.; Barrett, R.; Swanborough, J. J.; Russell, S. E.; Walker, P. A.; Barnes, N. J.;

- Knee, A. J.; Lewis, T.; Davies, P. R. *Pestic. Sci.* **1997**, *50*, 297–311.
18. Vince, R.; Hua, M.; Caperelli, C. A. *Nucleosides, Nucleotides* **1996**, *15*, 1711–1718.
19. Russell, R. G. G. *Phosphorus, Sulfur Silicon* **1999**, *144–146*, 793–820.
20. Wróblewski, A. E.; Głowacka, I. E. *Tetrahedron: Asymmetry* **2002**, *13*, 989–994.
21. Holy, A. *Collect. Czech. Chem. Commun.* **1981**, *46*, 173–179.
22. Bergmeier, S. C.; Seth, P. P. *J. Org. Chem.* **1997**, *62*, 2671–2674.
23. Carmack, M.; Kelly, C. J. *J. Org. Chem.* **1968**, *33*, 2171–2173.
24. Bouzide, A.; Sauve, G. *Org. Lett.* **2002**, *4*, 2329–2332.
25. Robert, F.; Delbecq, F.; Nguéfacq, C.; Sinou, D. *Eur. J. Inorg. Chem.* **2000**, 351–358. Bose, D. S.; Gurjar, M. K. *Synth. Commun.* **1989**, *19*, 3313–3321.
26. Mancuso, A. J.; Swern, D. *Synthesis* **1981**, 165–185.
27. Dunigan, J.; Weigel, L. O. *J. Org. Chem.* **1991**, *56*, 6225–6227.
28. Cohen, N.; Banner, B. L.; Lopresti, R. J.; Wong, F.; Rosenberger, M.; Liu, Y.-Y.; Thom, E.; Liebman, A. A. *J. Am. Chem. Soc.* **1983**, *105*, 3661–3672. Cohen, N.; Banner, B. L.; Laurenzano, A. J.; Carozza, L. *Org. Synth.* **1985**, *63*, 127–135.
29. Hanessian, S. *J. Org. Chem.* **1969**, *34*, 675–681.
30. Stevens, R. V.; Beaulieu, N.; Chan, W. H.; Daniewski, A. R.; Takeda, T.; Waldner, A.; Williard, P. G.; Zutter, U. *J. Am. Chem. Soc.* **1986**, *108*, 1039–1049.
31. Chandra, K. L.; Chandrasekhar, M.; Singh, V. K. *J. Org. Chem.* **2002**, *67*, 4630–4633.
32. Dess, B. M.; Martin, J. C. *J. Org. Chem.* **1983**, *48*, 4155–4156. Dess, B. M.; Martin, J. C. *J. Am. Chem. Soc.* **1991**, *113*, 7277–7287.
33. Wróblewski, A. E.; Balcerzak, K. B. *Tetrahedron: Asymmetry* **2001**, *12*, 427–431.
34. Hanaya, T.; Miyoshi, A.; Noguchi, A.; Kawamoto, H.; Armour, M. A.; Hogg, A. M.; Yamamoto, H. *Bull. Chem. Soc. Jpn.* **1990**, *63*, 3590–3594.
35. Hammerschmidt, F.; Li, Y. F. *Tetrahedron* **1994**, *50*, 10253–10264.
36. Wróblewski, A. E.; Balcerzak, K. B. *Tetrahedron* **1998**, *54*, 6833–6840.
37. Moore, R. E.; Bartolini, G.; Barchi, J.; Bothner-By, A. A.; Dadok, J.; Ford, J. *J. Am. Chem. Soc.* **1982**, *104*, 3776–3779.
38. Wróblewski, A. E. *Liebigs Ann. Chem.* **1986**, 1854–1862.
39. Wróblewski, A. E.; Głowacka, I. E. *Tetrahedron: Asymmetry* **2004**, *15*, 1457–1464.
40. Neeser, J.-R.; Tronchet, J. M. J.; Charollais, E. J. *Can. J. Chem.* **1983**, *61*, 2112–2120.
41. Adiwidjaja, G.; Meyer, B.; Thiem, J. Z. *Naturforsch.* **1979**, *34b*, 1547–1551.
42. Buchanan, G. W.; Bourque, K.; Seeley, A. *Magn. Reson. Chem.* **1986**, *24*, 360–367.
43. Bentrude, W. G.; Setzer, W. N. In *Phosphorus-31 NMR Spectroscopy in Stereochemical Analysis*; Verkade, J. G., Quin, L. D., Eds.; VCH: Deerfield, 1987; Chapter 11.
44. Altona, C.; Sundaralingam, M. *J. Am. Chem. Soc.* **1973**, *95*, 2333–2344.
45. Benezra, C. *J. Am. Chem. Soc.* **1973**, *95*, 6890–6894.

The synthesis of a single enantiomer of a major α -mycolic acid of *M. tuberculosis*

Juma'a R. Al Dulayymi, Mark S. Baird* and Evan Roberts

Department of Chemistry, University of Wales, Bangor, Gwynedd LL57 2UW, UK

Received 29 June 2005; revised 30 August 2005; accepted 15 September 2005

Available online 2 November 2005

Abstract—We report a synthesis of a single enantiomer of a mycolic acid from *Mycobacterium tuberculosis* containing a di-*cis*-cyclopropane. The method can be simply varied to modify the chain lengths or the absolute stereochemistry of either cyclopropane. © 2005 Elsevier Ltd. All rights reserved.

1. Introduction

Tuberculosis, caused by *Mycobacterium tuberculosis*, kills some 3 m people each year and accounts for about 25% of preventable deaths. It has been estimated that between a quarter and a half of the world population is infected with the organism, though in most cases this does not lead to the development of the disease.¹ A limited number of drugs is available for treating TB; however, the emergence of multi-drug-resistant strains of the bacterium with associated fatality rates of 40–60% is a serious problem. Many other mycobacteria are either obligate or opportunistic pathogens.¹ *M. leprosa* causes leprosy, which afflicts over 12 m people; other mycobacteria cause opportunistic infections in immunologically compromised patients, for example, in AIDS. Mycobacteria are resistant to many common antibiotics, chemotherapeutic agents and disinfectants. This resistance is partly because the cell wall, containing a complex heteropolymer involving a series of esters of very long chain 'mycolic acids', is particularly impermeable. The barrier is probably caused by a parallel alignment of mycolic acids in the inner leaflet. The balance of these structures, which is dependent on the mycobacterial species, changes membrane permeability and fluidity and hence resistance to a therapeutic agent. Mycolic acids are highly complex but include long-chain (*R,R*)- β -hydroxy-acids ($R^1\text{CH}(\text{OH})\text{CH}(\text{CO}_2\text{H})R''$), commonly containing *cis*-cyclopropanes, α -methyl-*trans*-cyclopropanes, α -methyl- β -keto- and α -methyl- β -methoxy- groups in the R^1 -chain and a simple long-chain alkyl group in the R'' position,^{2–4} such as compounds 1–4 below (Scheme 1). Mycolic acids

containing *trans*-cyclopropanes at the position in the chain closest to the hydroxyacid are reported to have a particular effect on the cell wall and therefore on the sensitivity of mycobacterial species to hydrophobic antibiotics.⁵ Mycolic acids are present both as bound tetramycolyl penta-arabinose clusters and as extractable trehalose 6,6'-dimycolates ('cord factor').^{1,6} Cord factors protect mice against *Klebsiella pneumoniae* or *Listeria monocytogenes*, disrupt mitochondrial and sub-mitochondrial membranes, are granulomagenic,⁷ adjuvant active, and a virulence factor. Lipid fractions from *M. bovis* show antituberculosis and antitumour immunogenicity, effects that are directly dependent on the content of a mycolic acid fraction.

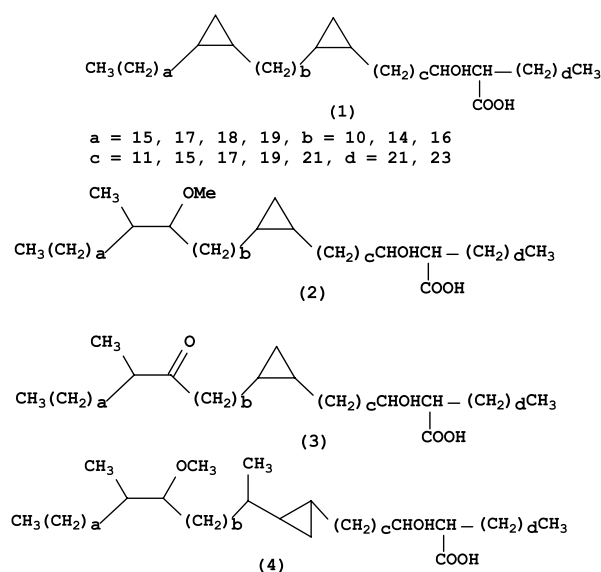

Scheme 1.

Keywords: Tuberculosis mycolic acid.

* Corresponding author. Tel.: +44 1 248382374; fax: +44 1 248370528; e-mail: chs028@bangor.ac.uk

A correlation between lung cancer and pulmonary tuberculosis has been discussed.⁷ ‘Cord factor appears to be one of the most potent immuno-modulators in the mycobacterial cell’.^{7b} Thus, the detection of antibodies against cord factor produced in the serum of patients with pulmonary tuberculosis is clinically useful in the rapid serodiagnosis of the disease;⁸ similar approaches have been reported for the serodiagnosis of Hansen’s disease/leprosy and for *Rhodococcus ruber*.⁹ The need to characterise the molecular mechanism for such responses is identified. The availability of unique mycolic acids is seen as key; the availability of the derived cord factors also offers the potential for improved ELISA assays for disease.

Mycolic acids from Mycobacteria, usually containing 70–90 carbons, are present as complex mixtures with varying values of a–d above, the exact composition depending on the species. Structural assignment has often been based on mass spectra of mixtures of homologues.¹⁰ It is often difficult from the early literature to judge the certainty with which a structure has been assigned or, indeed, which actual values of a–d have been determined. However, recent detailed studies have clarified the situation considerably.^{11,1} Moreover, although the hydroxyacid grouping is known to be of *R,R*-configuration, the absolute stereochemistries of the other groups are not known. There is some evidence that the 1-methyl-2-methoxy unit at the distal position from the hydroxy acid in mycolic acids (**2**) is *S,S*,¹² while other reports identify an *R*-stereochemistry for the three stereo-centres of an α -methyl-*trans*-epoxy unit.¹³ Much is now known about the enzymes controlling the biosynthesis of mycolic acids,¹⁴ and it has been proposed, for example, that the *cis*-cyclopropane unit, the α -methyl-*trans*-cyclopropane and the α -methyl- β -alkoxy unit are formed from a *Z*-alkene through a common intermediate (Scheme 2).¹⁵ A consequence of this would be that the three sub-units should have a common absolute stereochemistry at the carbon bearing the methyl group and C-1 of the *cis*-cyclopropane.

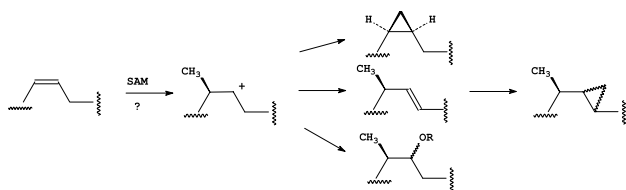

Scheme 2.

Among the most important of these acids are those containing two *cis*-cyclopropanes. The acid **5** (or **1**, $a=19$, $b=14$, $c=11$, $d=23$) was reported by Minnikin and Polgar to be the major mycolic acid of *M. tuberculosis* var *hominis*.² Syntheses of the ‘mero-mycolic acid’ **6** as a mixture of four isomeric di-*cis*-cyclopropanes,¹⁶ and of a single enantiomer of compound **7** have been reported (Scheme 3).¹⁷ The synthesis of single stereoisomers of individual mycolic acids may lead to a fuller understanding of their biosynthesis and of the structures of bacterial cell walls and to cord factor antibodies derived from discrete mycolic acids characteristic of individual bacteria.

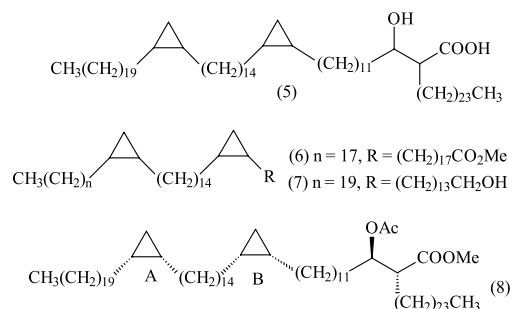

Scheme 3.

We now report the synthesis of a single enantiomer **8** of the mycolic acid **5**,² protected at the acid and alcohol positions.[†] The stereochemistry of the cyclopropanes A and B is that, which could have a common biosynthetic precursor with some *S*-methyl-branched mycolates.¹⁸ The synthetic method used, which can be varied to allow the synthesis of either absolute stereochemistry of each cyclopropane, involved the use of a common precursor for the two chiral cyclopropane units, C–C bonds being created at the positions shown below (Scheme 4).

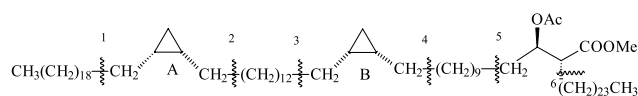

Scheme 4.

The (1*S*,2*R*)-aldehyde **13** was prepared by a method described earlier from (1*S*,2*R*)-butyryloxymethyl-2-formylcyclopropane **10**.¹⁹ The first step required the generation of an ylid from the nonadecyltriphenylphosphonium salt **9**. This was prepared from nonadecanol by conversion into the bromide by standard methods, followed by reaction with triphenylphosphine. The nonadecanol was itself prepared efficiently either by oxidation of eicosene to nonadecanoic acid,²⁰ and reduction, or by the coupling of heptylmagnesium bromide to 12-bromodecanol in the presence of dilithium tetrachlorocuprate (Scheme 5).

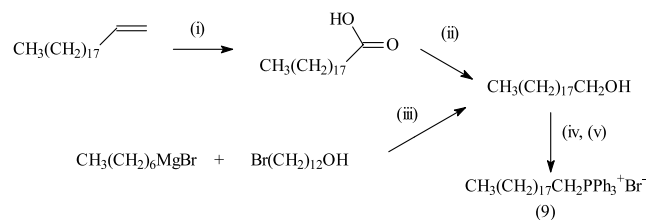

Scheme 5. (i) KMnO_4 , $\text{CH}_3(\text{CH}_2)_{15}\text{NMe}_3\text{Br}$, $\text{H}_2\text{O}/\text{HOAc}$ (78%); (ii) $\text{LiAlH}_4/\text{THF}$ (83%); (iii) Li_2CuCl_4 , THF (91%); (iv) aq HBr , $\text{Bu}_4\text{N}^+\text{Br}^-$ (99%); (v) PPh_3 , toluene (85%).

Reaction of (**10**) with the salt (**9**) and butyllithium in tetrahydrofuran led to the ester (**11**) as a mixture of *E* and *Z*-isomers in ratio 1:6. This was first reduced to the corresponding alcohols and then the double bond was saturated using di-imide generated from hydrazine hydrate,

[†] A preliminary account of these results has already been published (Al Dulayymi, J. R.; Baird, M. S. and Roberts, E. *J. Chem. Soc., Chem. Comm.* **2003**, 228–229).

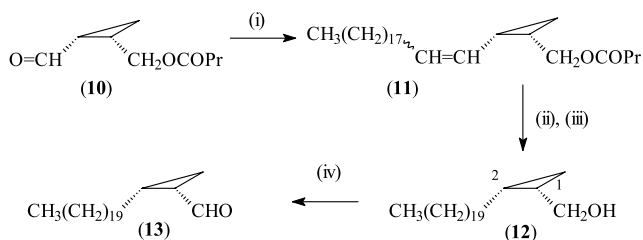

Scheme 6. (i) $\text{Me}(\text{CH}_2)_{18}\text{PPh}_3\text{Br}$ (**9**), BuLi , THF (81%, 6:1 *Z/E*), (ii) LiAlH_4 , THF (95%), (iii) N_2H_4 , NaIO_4 , AcOH , CuSO_4 , *i*-PrOH (80%); (iv) PCC , CH_2Cl_2 (90%).

sodium periodate and copper sulphate in acetic acid and isopropanol. The derived alcohol **12** was then readily oxidised to aldehyde (**13**) (Scheme 6).

The aldehyde **13** was homologated to give **14** by reaction with 1-carbomethoxy-12-triphenylphosphoniumundecyl iodide and base, again to give a mixture of *E*- and *Z*-alkenes, followed by the same sequence of reduction to the corresponding alcohols, hydrogenation of the alkenes using di-imide, and then oxidation to the aldehyde (Scheme 7).

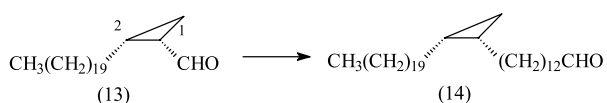

Scheme 7. (i) $\text{MeO}_2\text{C}(\text{CH}_2)_{11}\text{PPh}_3\text{I}$, MeONa , THF, DMF (70%); (ii) LiAlH_4 , THF (92%); (iii) N_2H_4 , NaIO_4 , AcOH , CuSO_4 , *i*-PrOH (85%); (iv) PCC , CH_2Cl_2 (93%).

The second cyclopropane unit was prepared by a similar route, though in this case a Julia reaction was used in place of Wittig coupling. Ester **15**¹⁹ was converted into sulphone **16** by reaction with the thiazole **17**, triphenylphosphine and diethyl azodicarboxylate then oxidation of the derived thioether.²¹ The sulphone was treated with aldehyde **14** in a modified Julia reaction,²¹ to give a 1:1 mixture of *E*- and *Z*-alkenes **18**. Reduction to the corresponding alcohols using lithium aluminium hydride followed by hydrogenation of the alkene, again using di-imide gave a single enantiomer of alcohol **19** (Scheme 8).

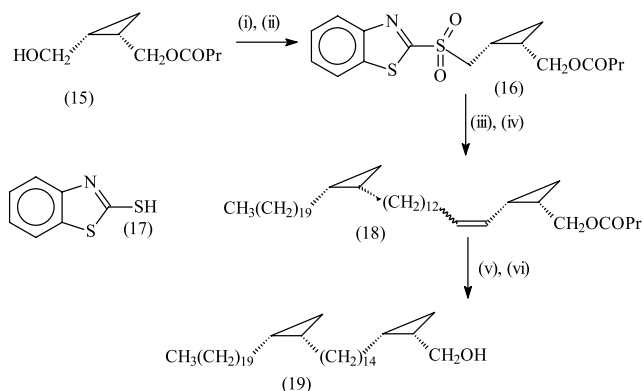

Scheme 8. (i) (**17**), PPh_3 , DEAD ; (ii) H_2O_2 or MCPBA , CH_2Cl_2 ; (iii) LiHMDS ; (iv) (**14**) (43% two steps); (v) LiAlH_4 ; (vi) NH_2NH_2 , NaIO_4 , CuSO_4 , AcOH , *i*-PrOH (77% two steps).

The remaining major problem was to link the single enantiomer of the dicyclopropane unit to the hydroxyacid portion of the target molecule **8**. Syntheses of a shorter chain dialkyl mycolic acid containing no cyclopropane ring as the *R,R*-isomer has been reported earlier.^{22,23} In the present work, a modified approach for the synthesis of **8** was used. Ring opening of the epoxide **20**²⁴ with a Grignard reagent prepared from 9-bromononan-1-ol tetrahydropyranyl ether led to a single enantiomer of the mono-protected diol **21** (as a diastereomeric mixture at the OTHP group) in 86% yield. This was transformed in four steps into the diol **22** (Scheme 9).

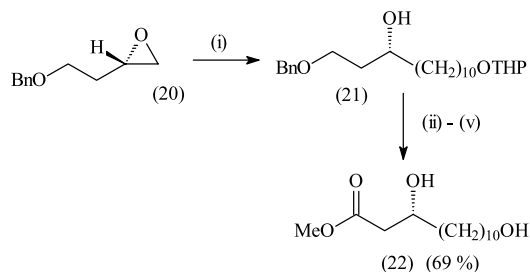

Scheme 9. (i) $\text{BrMg}(\text{CH}_2)_9\text{OTHP}$, CuI , 2 h, -30°C (86%); (ii) imidazole, DMF, $\text{Bu}^t\text{SiMe}_2\text{Cl}$ (93%); (iii) H_2 , Pd/C , MeOH (84%); (iv) NaIO_4 , $\text{RuCl}_3 \cdot \text{H}_2\text{O}$, CH_3CN , H_2O , CCl_4 (69%); (v) MeOH , H_2SO_4 .

1-Iodotetracosane (**24**) was prepared by coupling dodecylmagnesium bromide to 12-bromododecanol to give tetracosan-1-ol (**23**) (90%), bromination with NBS and triphenylphosphine (93%) to give 1-bromotetracosane and then conversion of the bromide into the iodide with sodium iodide in acetone (86%) (Scheme 10).

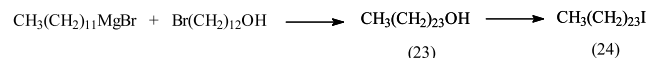

Scheme 10.

The diol **22** was protected at the primary alcohol group as a silyl ether and then alkylated,²⁵ using 1-iodotetracosane to give the hydroxy ester **25** using a method that has been applied to shorter chain alkyl mycolic acids,²³ although the yield was moderate at best. Protection of the secondary alcohol in **25** as the acetate, deprotection of the primary alcohol and oxidation led to the aldehyde **26** (Scheme 11).

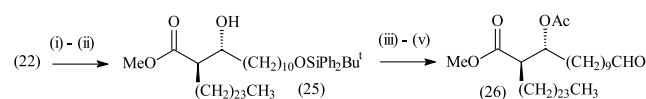

Scheme 11. (i) $\text{Bu}^t\text{Ph}_2\text{SiCl}$, DMAP , Et_3N (84%); (ii) LDA , $\text{CH}_3(\text{CH}_2)_{23}\text{I}$, HMPA (31%); (iii) Ac_2O , pyridine (86%); (iv) F^- (75%); (v) PCC (95%).

In the final stages of the synthesis, the single enantiomer of protected aldehyde **26** was coupled to the dicyclopropane **19**. Reaction of alcohol **19** with the thiazole **17**, triphenylphosphine and diethyl azodicarboxylate then oxidation of the derived thioether as before gave the sulphone **27**. Treatment of this with the aldehyde **26** and base in a Julia reaction led to a mixture of *Z*- and *E*-alkenes **28**; hydrogenation with di-imide generated from dipotassium azodicarboxylate and acid gave the saturated

protected mycolic acid **8**,²⁶ $[\alpha]_D^{22} +4.2$ (c 0.735, CHCl_3) (Scheme 12).

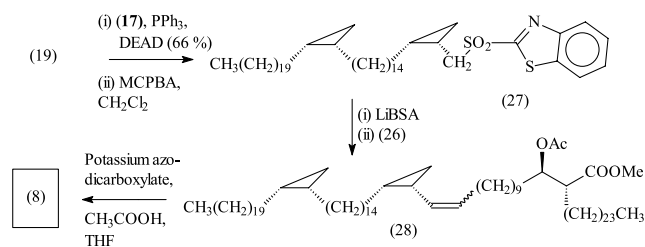

Scheme 12.

The ^1H and ^{13}C NMR spectra of **8** were essentially identical to those of a sample extracted from *M. tuberculosis* and then protected ($[\alpha]_D +3.7$),²⁷ which is a mixture of homologues in which **8** predominates. However, it must be recognised that in such large molecules, identity of ^1H and ^{13}C NMR spectra is no guarantee that the relative stereochemistries are identical. The specific rotation of the synthetic material ($[\alpha]_D +4.2$) was also close to that of the natural mixture of homologues; in this case the rotation is probably dominated by the chirality of the hydroxy acid part of the molecule and not indicative of the chirality of the cyclopropanes. The mass spectrum of **8** measured either using MALDI or electrospray MS gave a molecular ion pattern (Fig. 2) which corresponded to the major isomer of the natural sample (Fig. 1). Studies to further compare the natural and synthetic samples in order to establish the stereochemistry of the former are under way.

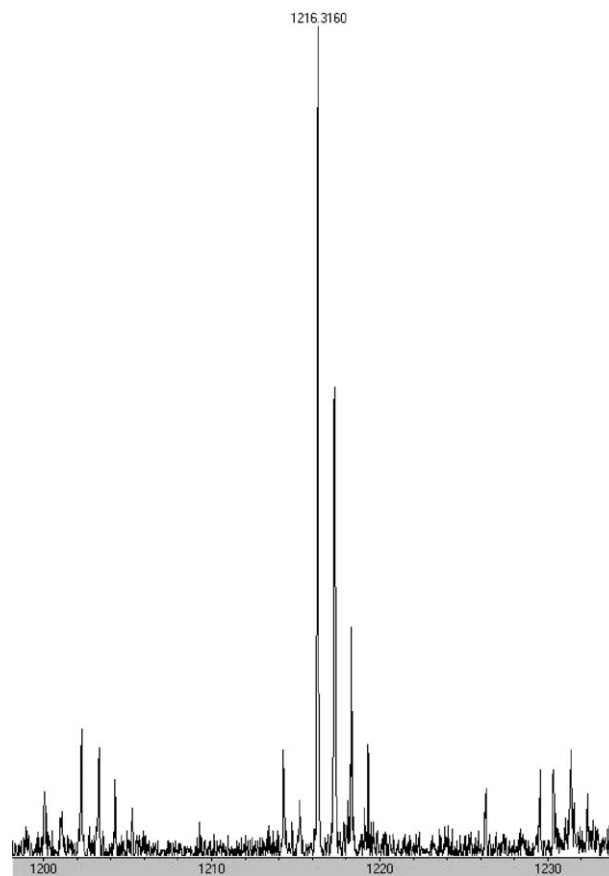

Figure 2. MALDI MS of synthetic protected α -mycolic acid (**8**).

2. Experimental

2.1. General

Chemicals used were obtained from commercial suppliers or prepared from them by methods described. Solvents, which had to be dry, for example, ether, tetrahydrofuran were dried over sodium wire. Petroleum was of boiling point 40–60 °C. Reactions carried under inert conditions, were carried out under a slow stream of nitrogen. Reactions carried out at low temperatures were cooled using a bath of methylated spirit with liquid nitrogen. Silica gel (Merck 7736 silica gel) and silica plates used for thin layer and column chromatography were obtained from Aldrich. Organic solutions were dried over anhydrous magnesium sulphate.

GLC's were carried out on a Perkin-Elmer Model 8410 using a capillary column (15 m \times 0.53 mm). IR spectra were carried out on a Perkin-Elmer 1600 F.T.I.R. spectrometer as liquid films. NMR spectra were recorded on a Bruker AC250 or Advance500 spectrometer. $[\alpha]_D$ values were recorded in CHCl_3 on a POLAAR 2001 Optical Activity polarimeter. Mass spectra were recorded on Bruker Microtof or Maldi tof instruments or by the EPSRC MS service in Swansea.

2.1.1. Nonadecanoic acid. Potassium permanganate (80 g, 506 mmol) was added in portions of 1.5 g over 2 h to a mechanically stirred solution of eicosene (50 g,

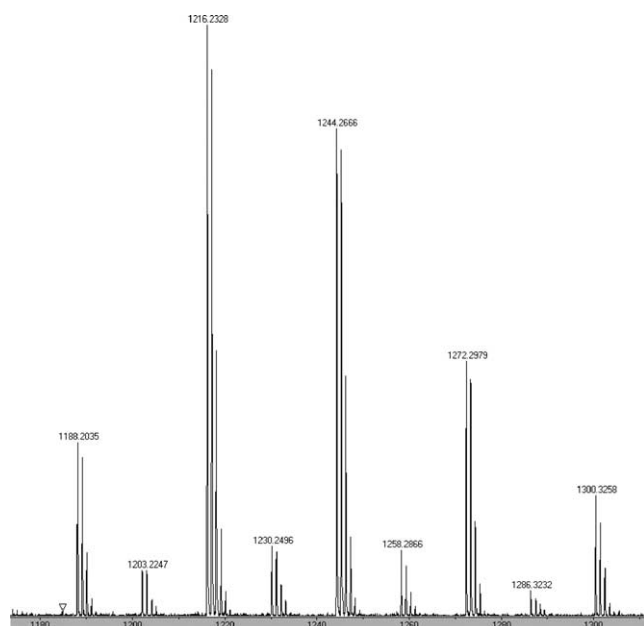

Figure 1. MALDI MS of natural mixture of protected α -mycolic acid homologues.

Variation of the chain lengths in the above sequence or adjustment of the absolute stereochemistry by using the enantiomers of either or both of the cyclopropanes **14** and **16** can be used to provide a simple and flexible approach to any *cis*-dicyclopropane mycolic acid.^{19,28}

178.57 mmol), water (1000 ml), acetic acid (20 ml), hexadecyltrimethylammonium bromide (6 g) and sulphuric acid 1 M (120 ml) in dichloromethane (1000 ml) at 3 °C. The mixture was stirred for 16 h at room temperature, then quenched carefully with satd aq sodium metabisulphite until a clear solution was obtained. The organic layer was separated and the aqueous layer was extracted with dichloromethane (2×400 ml). The combined organic layers were dried, concentrated to 400 ml, decanted from a small amount of insolubles and then cooled to −10 °C for 12 h. The solid was filtered, washed with cold dichloromethane (60 ml) and petroleum (50 ml) and dried to give nonadecanoic acid as a white solid (41.4 g, 78%) (mp 65–67 °C, lit.:²⁰ mp 67–68 °C), which showed δ_{H} (250 MHz, CDCl_3): 2.44 (2H, t, $J=7.0$ Hz), 1.65 (2H, pent, $J=6.9$ Hz), 1.25 (30H, br s), 0.85 (3H, t, $J=7.1$ Hz); δ_{C} : 179.8, 34.1, 31.9, 29.7, 29.4, 29.4, 29.2, 29.1, 24.7, 22.7, 20.3, 14.1; ν_{max} : 3703 (very broad) cm^{-1} .

2.1.2. 1-Nonadecanol. *Method A.* Nonadecanoic acid (30 g, 100 mmol) in tetrahydrofuran (500 ml) was added dropwise over 15 min to a suspension of lithium aluminium hydride (6 g, 157.9 mmol) in tetrahydrofuran (200 ml) at room temperature. The mixture was refluxed for 1 h, then quenched carefully with freshly prepared satd aq sodium sulphate (40 ml) followed by the addition of anhydrous magnesium sulphate (10 g). The mixture was stirred vigorously for 10 min, filtered through a pad of Celite and washed with tetrahydrofuran (2×50 ml). The filtrate was evaporated and the residue was recrystallized from methanol (500 ml) and water (30 ml) at −10 °C for 12 h then washed with cold methanol (50 ml) to give 1-nonadecanol as a white solid (23.75 g, 83%) (mp 60–62 °C, lit.:²⁹ mp 62 °C), which showed δ_{H} (250 MHz, CDCl_3): 3.65 (2H, t, $J=7.1$ Hz), 1.62 (2H, pent, $J=6.8$ Hz), 1.3 (33H, br s), 0.92 (3H, t, $J=7.1$ Hz); δ_{C} : 63.1, 32.8, 31.9, 29.7, 29.4, 29.4, 25.7, 22.7, 14.1; ν_{max} : 3430 cm^{-1} .

Method B. 1-Bromoheptane (13.6 g, 76 mmol) was added dropwise to a suspension of magnesium turnings (1.97 g, 81 mmol) in dry tetrahydrofuran (80 ml) at a rate sufficient to maintain a steady reflux. Once the exothermic reaction had subsided, the mixture was heated under reflux for 1 h then cooled to −10 °C, when 12-bromododecanol (5.3 g, 20 mmol) in tetrahydrofuran (50 ml) was added. The mixture was cooled to −40 °C followed by the addition of dilithium tetrachlorocuprate (5 ml), then stirred for 2 h at this temperature and at room temperature for 12 h. Satd aq ammonium chloride (100 ml) was added together with ethyl acetate (100 ml). The organic layer was separated and the aqueous layer was re-extracted with ethyl acetate (2×50 ml). The combined organic layers were washed with water, dried and evaporated to give a residue, which was treated with petroleum (50 ml). The solution was cooled to −10 °C for 12 h and the solid was filtered off to give 1-nonadecanol (5.2 g, 91%), which showed identical spectra to those above.

2.1.3. 1-Bromononadecane. 1-Nonadecanol (23.75 g, 83.62 mmol) was added to a stirred solution of hydrobromic acid (48%, 100 ml) and tetrabutylammonium bromide (1 g). The mixture was refluxed for 3 h, cooled to room temperature and diluted with dichloromethane (120 ml) and water (300 ml). The aqueous layer was re-extracted

with dichloromethane (2×40 ml), and the combined organic layers were washed with satd aq sodium bicarbonate (200 ml), satd aq sodium chloride (200 ml), and dried. The solvent was evaporated to give a solid; chromatography eluting with petroleum and ether (10:0.5) gave a white solid, 1-bromononadecane (28.7 g, 99%), mp 35–37 °C (lit.:³⁰ mp 37 °C), which showed δ_{H} (250 MHz, CDCl_3): 3.44 (2H, t, $J=6.7$ Hz), 1.86 (2H, pent, $J=6.7$ Hz), 1.65–1.22 (32H, br m), 0.93 (3H, t, $J=6.4$ Hz); δ_{C} : 33.9, 32.9, 31.9, 29.7 (very broad), 29.6, 29.4, 28.8, 28.2, 22.7, 14.1; ν_{max} : 2960, 1460, 1261, 1215 cm^{-1} .

2.1.4. Nonadecyltriphenylphosphonium bromide (9). 1-Bromononadecane (29 g, 83.5 mmol) was added to a stirred solution of triphenylphosphine (33.00 g, 125 mmol) in toluene (250 ml). The mixture was refluxed for 120 h. The solvent was evaporated and petroleum (100 ml) was added and again evaporated. The residue was treated with diethyl ether (150 ml) and stirred for 1 h; by this time a slurry of fine crystals had formed. These were filtered, washed well with ether and dried to give a white solid, 1-nonadecyltriphenylphosphonium bromide (**9**) (43.5 g, 85%) which showed δ_{H} (250 MHz, CDCl_3): 7.9–7.45 (15H, m), 3.8–3.72 (2H, m), 1.66–1.51 (4, m), 1.23 (30H, br s), 0.83 (3H, t, $J=7.0$ Hz); δ_{C} : 135, 133.7, 133.6, 130.6, 130.4, 119.1, 117.8, 31.9, 30.5, 30.3, 29.7, 29.3, 29.2, 23.2, 22.7, 14.1.

2.1.5. (1S,2R)-(2-Eicosylcyclopropyl)methanol (12). (A) *n*-Butyl lithium (24 ml, 34.8 mmol) was added dropwise to a stirred solution of 1-nonadecyltriphenylphosphonium bromide (**9**) (18.0 g, 29.5 mmol) in dry tetrahydrofuran (180 ml) under nitrogen at −40 °C. The mixture was allowed to reach room temperature and stirred for 1 h, then cooled to −50 °C and (1S,2R)-butyryloxy-methyl-2-formylcyclopropane (**10**)^{19,28} (4.2 g, 24.6 mmol) in dry tetrahydrofuran (20 ml) was added. The mixture was stirred at room temperature overnight. Satd aq ammonium chloride (150 ml) was added dropwise to quench the reaction, followed by the addition of petroleum–ether (1/1) (120 ml). The organic layer was separated and the aqueous layer was re-extracted with petroleum/ether (2×50 ml). The combined organic phases were washed with satd aq sodium chloride, dried and evaporated to give a residue, which was purified by chromatography eluting with petroleum–ether (5/2) to give (6:1)-*Z,E* butyric acid 2-eicos-1-enyl-cyclopropylmethyl ester (**11**) (7.13 g, 81%) which showed δ_{H} (250 MHz, CDCl_3) (major isomer): 5.45 (1H, br td, $J=7.3$, 10.7 Hz), 5.05 (1H, br t, $J=10.7$ Hz), 4.13 (1H, dd, $J=7.2$, 11.7 Hz), 3.96 (1H, dd, $J=8.1$, 11.7 Hz), 2.28 (2H, t, $J=7.35$ Hz), 2.13 (2H, br q, $J=6.7$ Hz), 1.76–1.68 (1H, m), 1.65 (2H, sext, $J=7.3$ Hz), 1.22–1.05 (33H, br m), 1.05 (1H, dt, $J=4.8$, 8.3 Hz), 0.94 (3H, t, $J=7.3$ Hz), 0.88 (3H, t, $J=6.4$ Hz), 0.37 (1H, br q, $J=5.5$ Hz); (minor isomer): 5.58 (1H, td, $J=6.7$, 15.2 Hz), 5.25 (1H, br dd, $J=7.64$, 15.2 Hz), 2.12–2.01 (2H, br m) (the remaining signals were obscured by the major isomer); δ_{C} (for two isomers): 173.6, 133.5, 127.3, 65.0, 64.9, 36.2, 32.6, 31.9, 29.7, 29.3, 29.2, 27.6, 22.6, 18.5, 16.5, 16.3, 14.2, 14.06, 13.6, 12.2, 10.3; ν_{max} : 1737, 1465 cm^{-1} .

(B) The above mixture of esters (7 g, 0.166 mol) in tetrahydrofuran (20 ml) was added dropwise to a stirred

suspension of lithium aluminium hydride (1 g) in tetrahydrofuran (80 ml) at room temperature. The mixture was refluxed for 1 h when TLC showed no starting material was left, then worked up as before to give a white solid. This was purified by chromatography on silica eluting with petroleum–ether (5/2) to give 6:1 *Z,E*-2-eicos-1-enyl-cyclopropylmethanol (5.54 g, 95%) [$[\alpha]_D^{24} + 27.5$ (*c*, 0.24 g in 10 ml CHCl_3) (mp 43–45 °C), which showed δ_H (250 MHz, CDCl_3) (major isomer): 5.45 (1H, br td, $J=7.3$, 10.7 Hz), 5.05 (1H, br t, $J=10.7$ Hz), 3.69 (1H, dd, $J=6.5$, 11.65 Hz), 3.43 (1H, dd, $J=8.7$, 11.64 Hz), 2.15–2.07 (2H, br m), 1.70–1.55 (1H, m), 1.45–1.15 (34H, br m), 0.95 (1H, dt, $J=4.74$, 8.23 Hz), 0.83 (3H, t, $J=6.1$ Hz), 0.32 (1H, br q, $J=5.4$ Hz); (2nd isomer): δ_H 5.65–5.52 (1H, td, $J=6.7$, 15.2 Hz), 5.25 (1H, br dd, $J=7.64$, 15.2 Hz), 1.95 (2H, br m), 1.53–1.46 (1H, m); the remaining signals were obscured by the major isomer; δ_C (for two isomers): 132.3, 132.1, 127.8, 127.6, 63.6, 63.3, 34.8, 32.6, 31.9, 29.9, 29.6, 29.5, 29.3, 27.6, 22.6, 20.65, 20.4, 18.9, 18.1, 14.1, 13.9, 12.3, 10.5; ν_{max} : 3400 cm^{-1} .

(C) Sodium (meta)periodate (30.55 g, 142.8 mmol) in hot water (90 ml) was added over 90 min at 70–80 °C to a stirred solution of the above mixture of alcohols (5 g, 14.28 mmol) in isopropanol (250 ml), acetic acid (2 ml), satd aq copper sulphate (2 ml) and hydrazine hydrate (20 ml). The mixture was stirred for 2 h to reach room temperature and worked up as before to give (1*S*,2*R*)-(2-eicosylcyclopropyl)methanol (**12**) (4.03 g, 80%) as a white solid, [$[\alpha]_D^{22} - 7.5$ (*c* 1.30, CHCl_3) (mp 60–62 °C) [Found: C, 81.8; H, 13.7; $\text{C}_{24}\text{H}_{48}\text{O}$ requires: C, 81.74; H, 13.72], which showed δ_H (250 MHz, CDCl_3): 3.65 (1H, dd, $J=7.1$, 11.3 Hz), 3.58 (1H, dd, $J=8$, 11.3 Hz), 1.72–1.31 (40H, m), 1.34–1.14 (1H, m), 0.88 (3H, t, $J=6.4$ Hz), 0.71 (1H, dt, $J=4.5$, 8.3 Hz), -0.01 (1H, br q, $J=5.2$ Hz); δ_C : 63.4, 31.9, 30.2, 29.7, 29.3, 28.5, 22.7, 18.2, 16.2, 14.1, 9.5; ν_{max} : 3400 cm^{-1} .

2.1.6. (1*S*,2*R*)-2-Eicosylcyclopropanecarbaldehyde (13). (1*S*,2*R*)-2-(Eicosylcyclopropyl)methanol (6.3 g, 17.86 mmol) in dichloromethane (30 ml) was added to a stirred suspension of pyridinium chlorochromate (7.95 g, 37 mmol) in dichloromethane (170 ml) at room temperature. After stirring vigorously for 3 h, TLC showed no starting material. Diethyl ether (400 ml) was added and the mixture was filtered through a pad of Celite, then through a pad of silica, which was washed well with ether and the filtrate was evaporated to give a solid. Chromatography on silica eluting with petroleum–ether (5/2) gave (1*S*,2*R*)-2-eicosylcyclopropanecarbaldehyde (**13**) (5.63 g, 90%) as a white solid (mp 42–44 °C) [Found: C, 82.1; H, 13.2; $\text{C}_{24}\text{H}_{46}\text{O}$ requires: C, 82.21; H, 13.22], which showed δ_H (250 MHz, CDCl_3): 9.34 (1H, d, $J=5.5$ Hz), 1.87–1.81 (1H, m), 1.75–1.04 (41H, m), 0.87 (3H, t, $J=7$ Hz); δ_C : 201.8, 31.9, 29.95, 29.7 (very broad), 29.6, 29.5, 29.3, 29.2, 28.2, 27.8, 24.8, 22.7, 14.7, 14.1; ν_{max} : 1694 cm^{-1} ; [$[\alpha]_D^{22} - 3.9$ (*c* 1.22, CHCl_3).

2.1.7. 12-(Triphenyl- λ^5 -phosphanyl)dodecanoic acid methyl ester iodide. (A) Methyl 12-bromododecanoate (25 g, 85.3 mmol) was added to a stirred solution of sodium iodide (38.4 g, 256 mmol) in acetone (250 ml) at room temperature, followed by the addition of sodium

bicarbonate (10.75 g, 128 mmol). The mixture was refluxed for 3 h, when GLC showed no starting material. The solvent was evaporated and the residue was diluted with water (100 ml), and dichloromethane (250 ml). The organic layer was separated and the aqueous layer was re-extracted with dichloromethane (2 × 50 ml). The combined organic layers were washed with satd aq sodium thiosulphate, dried and evaporated to give a pale yellow oil, which was purified by chromatography on silica eluting with petroleum–ether (5/1) to give methyl 12-iodododecanoate³¹ (26.1 g, 90%) as a colourless oil, which showed δ_H (250 MHz, CDCl_3): 3.60 (3H, s), 3.12 (2H, br t, $J=7.0$ Hz), 2.24 (2H, t, $J=7.4$ Hz), 1.75 (2H, br pent, 7 Hz), 1.55–1.45 (2H, m), 1.42–1.17 (14H, m); δ_C : 176.9, 51.4, 34.1, 33.5, 30.4, 29.4, 29.3, 29.2, 28.5, 24.9, 7.2; ν_{max} : 1730 cm^{-1} .

(B) The above ester (36 g, 105.8 mmol) was added to a stirred solution of triphenylphosphine (50 g, 190.6 mmol) in benzene (150 ml) and refluxed for 42 h. The solvent was evaporated and ether (200 ml) was added. A very viscous lower layer separated and this was agitated with the ether upper layer as well as possible. The ether layer was decanted off and the procedure was repeated with ether (2 × 200 ml). The bottom layer was evaporated under vacuum to leave an orange/yellow viscous oil, 12-(triphenyl- λ^5 -phosphanyl)dodecanoic acid methyl ester iodide³² (39.8 g, 62%), which showed δ_H (250 MHz, CDCl_3): 7.75–7.62 (15H, m), 3.55 (3H, s), 3.54–3.37 (2H, br m), 2.19 (2H, t, $J=7.4$ Hz), 1.63–1.45 (6H, m), 1.21–1.45 (12H, m); δ_P : 23.4 ppm.

2.1.8. 13-((1*S*,2*R*)-2-Eicosylcyclopropyl)tridecan-1-ol. Sodium methoxide (4.1 g, 75.9 mmol) was added to a stirred solution of 12-(triphenyl- λ^5 -phosphanyl)dodecanoic acid methyl ester iodide (46.62 g, 77 mmol) in dry dimethylformamide (190 ml) under nitrogen at -7 °C. The mixture was allowed to reach 0 °C for 10 min, then room temperature for 20 min, then cooled to -2 °C, followed by the addition of (1*S*,2*R*)-2-eicosylcyclopropanecarbaldehyde (**13**) (5.63 g, 16 mmol) in tetrahydrofuran (20 ml) and dimethylformamide (80 ml). The mixture was stirred at ambient temperature for 18 h. Satd aq ammonium chloride (25 ml) was added and the mixture was then diluted with water (1400 ml) and dichloromethane (160 ml). The organic phase was separated and the aqueous layer re-extracted with dichloromethane (3 × 50 ml). The combined organic phases were washed with a half satd aq sodium chloride (500 ml), dried and evaporated to yield a brownish residue. This was stirred with a 1:1 mixture of ether/petroleum (2 × 300 ml), filtered through a pad of silica, then evaporated to give a brown oil. The residue was purified by chromatography on silica eluting with petroleum–ether (10/0.5) to give *Z*-(1*S*,2*R*)-13-(2-eicosylcyclopropyl)tridec-12-enoic acid methyl ester (6.10 g, 69.5%) (with a minor amount of the *E*-isomer). The ester (5.5 g, 10 mmol) in tetrahydrofuran (20 ml) was added to a stirred suspension of lithium aluminium hydride (1.1 g) in tetrahydrofuran (120 ml) at room temperature, then refluxed for 2.5 h. When TLC showed no starting material was left, satd aq sodium sulphate (5 ml) was added, followed by anhydrous magnesium sulphate. The solids were filtered off, washed with tetrahydrofuran and the filtrate was evaporated to give crude *Z*-(1*S*,2*R*)-13-(2-eicosylcyclopropyl)tridec-12-en-1-ol (4.8 g, 92%), which was used for next step

without purification. Sodium (meta)periodate (18.6 g, 86.8 mmol) in hot water (90 ml) was added over 70 min at 70–80 °C, to a stirred solution of the alcohol (4.5 g, 8.7 mmol) in isopropyl alcohol (200 ml), acetic acid (2 ml), satd aq copper sulphate (2 ml) and hydrazine hydrate (20 ml). The mixture was stirred for 2 h to reach room temperature, then diluted with water (300 ml) and dichloromethane (450 ml). Because of the low solubility of the product, the mixture was warmed almost to the boiling point of dichloromethane to allow separation. The aqueous layer was re-extracted with warm dichloromethane (3 × 100 ml). The combined organic phases were washed with water (300 ml), dried and evaporated to give a solid, which was recrystallized from benzene to give a white solid, 13-((1*S*,2*R*)-2-eicosylcyclopropyl)tridecan-1-ol (3.84 g, 85%) (mp 74–76 °C) [Found: C, 83.1; H, 14.1; C₃₆H₇₂O requires: C, 82.99; H, 13.92], which showed δ_{H} (250 MHz, CDCl₃): 3.60 (2H, t, $J=6.56$ Hz), 1.66–1.12 (63H, m), 0.84 (3H, t, $J=6.4$ Hz), 0.6–0.54 (3H, m), –0.36 to –0.39 (1H, m); δ_{C} : 63.1, 32.8, 31.9, 30.2, 29.7, 29.4, 29.2, 28.7, 25.7, 22.67, 15.80, 14.1, 10.9; ν_{max} : 3400 cm^{–1}, $[\alpha]_{\text{D}}^{22}$ –2.04 (c 1.03, CHCl₃).

2.1.9. 13-((1*S*,2*R*)-2-Eicosylcyclopropyl)tridecanal (14).

13-((1*S*,2*R*)-2-Eicosylcyclopropyl)tridecan-1-ol (1.3 g, 2.51 mmol) was dissolved in hot dichloromethane (50 ml) and added to a refluxing suspension of pyridinium chlorochromate (1.3 g, 6.03 mmol) in dichloromethane (50 ml). The mixture was stirred vigorously under reflux for 1 h. When TLC showed no starting material, the mixture was allowed to reach room temperature, diluted with diethyl ether (100 ml) and filtered through a pad of Celite and then through a pad of silica. The silica was washed with a 1:1 mixture of ether/petroleum (60 ml). The combined filtrate was evaporated to give a residue. Chromatography on silica eluting with petrol–ether (5/1) gave a white solid, 13-((1*S*,2*R*)-2-eicosylcyclopropyl)tridecanal (14) (1.2 g, 93%) as a white solid, $[\alpha]_{\text{D}} -1.69$ (c 1.19, CHCl₃), mp 64–66 °C, [Found: C, 83.2; H, 13.5; C₃₆H₇₀O requires: C, 82.81; H, 13.59], which showed δ_{H} (250 MHz, CDCl₃): 9.72 (1H, t, $J=1.8$ Hz), 2.38 (2H, dt, $J=1.8, 7.3$ Hz), 1.62–1.56 (4H, m), 1.45–1.04 (56H, m), 0.84 (3H, t, $J=6.4$ Hz), 0.64–0.52 (3H, m), –0.37 (1H, q, $J=3.65$ Hz); δ_{C} : 203, 43.9, 31.9, 30.2, 29.7, 29.4, 29.3, 29.2, 28.7, 22.7, 22.1, 15.76, 14.1, 10.9; ν_{max} : 1720 cm^{–1}.

2.1.10. Butyric acid (1*S*,2*R*)-2-(benzothiazole-2-sulfonylmethyl)cyclopropylmethyl ester (16).

(A) Diethyl azodicarboxylate (11.14 g, 63.9 mmol) in dry tetrahydrofuran (25 ml) was added to a stirred solution of butyric acid (1*S*,2*R*)-2-hydroxymethylcyclopropylmethyl ester (15)^{19,28} (10 g, 58.1 mmol), triphenylphosphine (16.77 g, 63.9 mmol) and 2-mercaptobenzthiazole (17) (10.69 g, 63.9 mmol) in tetrahydrofuran (120 ml) at 0 °C. After 18 h at room temperature, the solvent was evaporated and the residue was treated with petrol–ether (5/2), filtered and the filter cake was washed with petrol/ether. The combined organic layers were evaporated to give a pale yellow oil. Chromatography on silica eluting with 5:2 petrol/ether gave butyric acid (1*S*,2*R*)-2-(benzothiazole-2-ylsulfanylmethyl)cyclopropylmethyl ester (14.4 g, 77%) [Found: M⁺ 321.083; C₁₆H₁₉O₂S₂N requires: 321.086], which

showed δ_{H} (250 MHz, CDCl₃): 7.83 (1H, dm, $J=8.04$ Hz), 7.72 (1H, dm, $J=8.4$ Hz), 7.46–7.33 (1H, m), 7.27–7.22 (1H, m), 4.32 (1H, dd, $J=6.5, 12.1$ Hz), 3.98 (1H, dd, $J=8.5, 12$ Hz), 3.52 (1H, dd, $J=7.5, 13.27$ Hz), 3.34 (1H, dd, $J=7.4, 13.27$ Hz), 2.34 (2H, t, $J=7.3$ Hz), 1.65 (2H, sext, $J=5.3$ Hz), 1.45–1.32 (2H, m), 0.93 (3H, t, $J=7.3$ Hz), 0.95–0.85 (1H, m), 0.37 (1H, br q, $J=5.6$ Hz); δ_{C} : 173.7, 166.8, 153.2, 135.2, 126.0, 124.2, 21.4, 121, 64.1, 36.2, 33.9, 18.4, 16.13, 15.7, 13.7, 11.0; ν_{max} : 1733, 1458, 1427, 1180 cm^{–1}; $[\alpha]_{\text{D}}^{24} +4.9$ (c 2.4, CHCl₃).

(B) *Method (1)*. *m*-Chloroperbenzoic acid (20.2 g, 116.8 mmol) in dichloromethane (100 ml) was added slowly to a stirred solution of butyric acid (1*S*,2*R*)-2-(benzothiazol-2-ylsulfanylmethyl)cyclopropylmethyl ester (12.5 g, 38.9 mmol) and sodium bicarbonate (14.72 g, 175.2 mmol) in dichloromethane (100 ml) at 5 °C. The mixture was stirred for 16 h at room temperature, when TLC showed no starting material. The solvent was evaporated and the residue was diluted with ethyl acetate and quenched slowly with satd aq sodium metabisulphite (25 ml). The organic layer was separated and the aqueous layer was extracted with ethyl acetate (2 × 100 ml). The combined organic layers were washed with satd aq sodium bicarbonate (30 ml), water (50 ml), dried, filtered and evaporated to give a pale yellow oil, which was columned on silica eluting with petroleum–ether (1/1) to give butyric acid (1*S*,2*R*)-2-(benzothiazole-2-sulfonylmethyl)cyclopropylmethyl ester (16) (11.3 g, 82.3%) which showed δ_{H} (250 MHz, CDCl₃): 8.21–8.15 (1H, m), 7.99–7.95 (1H, m), 7.62–7.45 (2H, m), 4.24 (1H, distorted dd, $J=6, 12$ Hz), 3.83–3.72 (2H, m), 3.35 (1H, distorted dd, $J=9.5, 14.7$ Hz), 2.22 (2H, t, $J=7.4$ Hz), 1.65 (2H, sext, $J=7.4$ Hz), 1.38–1.30 (2H, m), 0.95–0.8 (4H, m, including t, $J=7.36$ Hz), 0.28 (1H, br q, $J=5.7$ Hz); δ_{C} : 173.4, 165.8, 152.6, 136.8, 128, 127.6, 125.4, 122.3, 63.6, 55.1, 4, 18.35, 14.4, 13.6, 9.7, 9.1; ν_{max} : 1730, 1707, 1470, 762 cm^{–1}, $[\alpha]_{\text{D}}^{24} -58.34$ (c 1.59, CHCl₃); m/z : M⁺ (353), 266 (M⁺ – C₄H₇O₂), 155 (M⁺ – C₇H₄S₂O₂N).

Method (2). To a stirred solution of butyric acid (1*S*,2*R*)-2-(benzothiazol-2-ylsulfanylmethyl)cyclopropylmethyl ester (4.0 g, 12.46 mmol) in methylated spirit (100 ml) at 5 °C was added dropwise a yellow solution of ammonium molybdate tetrahydrate (1.48 g, 1.17 mmol) in 35% H₂O₂ (5.44 ml, 56 mmol). The resulting yellow suspension was stirred for 2 at this temperature and then at room temperature for 16 h. The solvent was evaporated and the residue was diluted with water (30 ml) then extracted with dichloromethane (3 × 50 ml). The combined organic layers were washed with brine, dried and evaporated to give a residue, which was purified by column on silica eluting with petroleum–ether (1/1) to give butyric acid (1*S*,2*R*)-2-(benzothiazole-2-sulfonylmethyl)cyclopropylmethyl ester (16) (4.06 g, 92.5%).

2.1.11. {(1*S*,2*R*)-2-[14-((1*S*,2*R*)-2-Eicosylcyclopropyl)tetradecyl]cyclopropyl}methanol (19).

Lithium hexamethyldisilazide (16 ml, 1 M) was added to a stirred solution of 13-((1*S*,2*R*)-2-eicosylcyclopropyl)tridecanal (16) (4.3 g, 8.3 mmol) and butyric acid (1*S*,2*R*)-2-(benzothiazole-2-sulfonylmethyl)cyclopropylmethyl ester (4.6 g, 12.6 mmol) in tetrahydrofuran (100 ml) under nitrogen at –15 °C.

The mixture was allowed to reach room temperature and stirred for 24 h, then quenched with satd aq ammonium chloride (50 ml) followed by the addition of dichloromethane (200 ml). The organic layer was separated and the aqueous layer was re-extracted with dichloromethane (2 × 50 ml). The combined organic layers were washed with 50% brine solution (200 ml), dried and evaporated to give a thick dark brown residue. The residue was purified by chromatography on silica eluting with petroleum–ether (5/1) to give a 1:1 mixture *E/Z* of butyric acid (1*S*,2*S*)-2-[14-((1*S*,2*R*)-2-icosylcyclopropyl)tetradec-1-enyl]cyclopropylmethyl esters (**18**) (2.34 g, 43%). The product (2.3 g) was dissolved in tetrahydrofuran (20 ml), added to a stirred suspension of lithium aluminium hydride (1 g) in tetrahydrofuran (100 ml) and refluxed for 2 h, when TLC showed no starting material. The mixture was quenched with satd aq sodium sulphate (3 ml) and worked up as before to give a white solid, *E/Z*-{(1*S*,2*S*)-2-[14-((1*S*,2*R*)-2-icosylcyclopropyl)tetradec-1-enyl]cyclopropyl}methanol (1.8 g, 86%). The crude product (1.8 g) was dissolved in propan-2-ol (150 ml) and mixed with hydrazine hydrate (15 ml), acetic acid (1.5 ml) and satd aq copper sulphate (1.5 ml). The mixture was stirred and heated to 75 °C, then sodium (meta)periodate (15 g) in warm water (60 ml) was added in portions maintaining the temperature below 85 °C. The mixture was allowed to cool to room temperature and worked up as before to give a solid, which was purified by recrystallisation from petroleum–ether (10/1) to give {(1*S*,2*R*)-2-[14-((1*S*,2*R*)-2-icosylcyclopropyl)tetradecyl]cyclopropyl}methanol (**19**) (16 g, 89%) (Found: C, 83.9; H, 13.8. C₄₁H₈₀O requires: C, 83.60; H, 13.68) which showed δ_{H} (250 MHz, CDCl₃): 3.69–3.53 (2H, m), 1.84–1.21 (67H, br m), 1.15–1.05 (1H, m), 0.95–0.85 (5H, m, including a triplet with coupling constant 6.8 Hz), 0.75–0.5 (3H, m), –0.04 (1H, br q, *J* = 5.5 Hz), –0.33 (1H, br q, *J* = 5.5 Hz), δ_{C} : 63.6, 31.9, 30.2, 29.7 (very broad), 29.3, 28.7, 28.5, 22.7, 18.1, 16.1, 15.7, 14.1, 10.9, 9.5, ν_{max} : 3300 cm⁻¹, $[\alpha]_{\text{D}}^{22}$ –4.55 (*c* 1.17, CHCl₃).

2.1.12. (R)-(+)-1-Benzylxy-3-hydroxy-13-tetrahydropranyl-oxyltridecane (21). 1-Bromo-9-tetrahydropranyl-oxynonane³⁷ (12.93 g, 0.042 mol) in tetrahydrofuran (15 ml) was added dropwise to magnesium turnings (1.31 g, 0.054 mol) in tetrahydrofuran (20 ml) under nitrogen. The mixture was refluxed for 2 h, then cooled to room temperature and added dropwise to a stirred solution of purified copper iodide (0.53 g, 0.0028 mol)³⁹ in dry tetrahydrofuran (30 ml) at –30 °C. After 10 min a solution of (*S*)(–)-(2-benzylxyethyl)oxirane (**20**)³⁶ (5 g, 0.028 mol) in tetrahydrofuran (10 ml) was added dropwise. The mixture was stirred for 3 h at –30 °C, when TLC showed no starting material, quenched with satd aq ammonium chloride (10 ml) and allowed to reach room temperature. The product was extracted with ethyl acetate (3 × 50 ml); the combined organic layers were washed with water (30 ml), dried and evaporated to give a colourless oil; chromatography on silica eluting with petroleum–ethyl acetate (5/2) gave (*R*)-(+)–1-benzylxy-3-hydroxy-13-tetrahydropranyl-oxyltridecane (**21**) (9.8 g, 86%) (Found: C, 73.4; H, 10.1; C₂₅H₄₂O₄ requires: C, 73.84; H, 10.41) which showed δ_{H} (250 MHz, CDCl₃): 7.32 (5H, br s), 4.57 (1H, br t, *J* = 4.25 Hz), 4.13 (2H, s), 3.77–3.66 (5H, m), 3.52–3.41 (1H, m), 3.35 (1H, dt, *J* = 6.9, 9.8 Hz), 1.96–1.81

(1H, m), 1.75 (2H, pent, *J* = 6.1 Hz), 1.65–1.25 (24H, br m); δ_{C} : 137.9, 128.4, 127.7, 127.6, 98.8, 73.3, 71.45, 69.3, 67.7, 62.3, 37.4, 36.4, 30.8, 29.7, 29.7, 29.6, 29.55, 29.5, 29.5, 26.2, 25.7, 25.6, 25.5, 19.7; ν_{max} : 3455 cm⁻¹; $[\alpha]_{\text{D}}^{20}$ +7.77 (*c* 1.62, CHCl₃).

2.1.13. (R)-(+)-1-Benzylxy-3-acetoxy-13-tetrahydropranyl-oxyltridecane. 1-Benzylxy-3-hydroxy-13-tetrahydropranyl-oxyltridecane (3 g, 0.0074 mol) was mixed with acetic anhydride (15 ml) and anhydrous pyridine (15 ml) at room temperature. The mixture was stirred for 16 h then toluene (20 ml) was added and the solvent was evaporated to give an oil. The residue was purified by chromatography on silica eluting with petroleum–ethyl acetate (5/0.5) to give (*R*)-1-benzylxy-3-acetoxy-13-tetrahydropranyl-oxyltridecane (2.97 g, 90%) as a colourless oil (Found: C, 72.2; H, 9.9; C₂₇H₄₄O₅ requires: C, 72.28; H, 9.88), which showed δ_{H} (250 MHz, CDCl₃): 7.28 (5H, br s), 5.00 (1H, br p, *J* = 4.3 Hz), 4.57 (1H, t, *J* = 3.9 Hz), 4.43 (2H, s), 3.95–3.85 (1H, m), 3.74 (1H, dt, *J* = 7, 9.4 Hz), 3.52–3.41 (3H, m), 3.87 (1H, dt, *J* = 6.7, 9.75 Hz), 1.96 (3H, s), 1.85–1.83 (2H, br m), 1.6–1.4 (8H, m), 1.35–1.25 (16H, br m); δ_{C} : 170.7, 138.3, 128.3, 127.7, 127.5, 98.8, 73.0, 71.9, 67.65, 66.8, 62.3, 34.4, 34.3, 30.8, 29.7, 29.5, 29.5, 26.2, 25.5, 25.2, 21.2, 19.7; ν_{max} : 1737 cm⁻¹; $[\alpha]_{\text{D}}^{20}$ –12.1 (*c* 1.3, CHCl₃).

2.1.14. (R)-1-Hydroxy-3-acetoxy-13-tetrahydropranyl-oxyltridecane. (*R*)-1-Benzylxy-3-acetoxy-13-tetrahydropranyl-oxyltridecane (6.5 g, 0.014 mol) in methanol (350 ml) was stirred with Pd/C (10%) under a hydrogen atmosphere for 30 h. TLC showed no starting material; the mixture was filtered through Celite and evaporated to give an oil. This was purified by chromatography on silica eluting with petroleum–ethyl acetate (5/1) to give (*R*)-1-hydroxy-3-acetoxy-13-tetrahydropranyl-oxyltridecane as a colourless oil (4.71 g; 91.5%), (Found: C, 66.8; H, 10.6; C₂₀H₃₈O₅ requires: C, 67.00; H, 10.68) which showed δ_{H} (250 MHz, CDCl₃): 5.52–4.82 (1H, m), 4.56 (1H, br t, *J* = 4.3 Hz), 3.92–3.81 (1H, m), 3.75–3.68 (1H, m), 3.65–3.55 (1H, m), 3.54–3.45 (2H, m), 3.42–3.35 (1H, m), 2.34 (1H, br s), 2.10 (3H, s), 1.80 (2H, s), 1.7–1.4 (10H, m), 1.25 (16H, br s); δ_{C} : 171.9, 98.8, 71.6, 67.6, 62.3, 58.5, 37.4, 34.5, 30.7, 29.7, 29.5, 29.4, 29.3, 26.2, 25.5, 25.4, 21.1, 19.6; ν_{max} : 3453, 1736 cm⁻¹; $[\alpha]_{\text{D}}^{20}$ –12.2 (*c* 1.45, CHCl₃).

2.1.15. (R)-(+)-1-Benzylxy-3-*t*-butyldimethylsilyloxy-13-tetrahydropranyl-oxyltridecane. (i) *Method A.* Triethylamine (4.11 g, 0.04 mol) was added to a stirred solution of (*R*)-(+)–1-benzylxy-3-hydroxy-13-tetrahydropranyl-oxyltridecane (6.6 g, 0.016 mol) in dry dichloromethane (20 ml) under nitrogen. The mixture was stirred for 10 min then *t*-butyldimethylsilylchloride (2.94 g, 0.019 mol) in dry dichloromethane (5 ml) was added, followed by dimethylaminopyridine (300 mg) in dichloromethane (3 ml). The mixture was stirred for 48 h, then quenched with water (10 ml). The organic layer was separated and the aqueous layer re-extracted with dichloromethane (2 × 50 ml). The combined organic layers were dried and evaporated to give an oil; chromatography on silica eluting with petroleum–ether (5/1) gave (*R*)-(+)–1-benzylxy-3-*t*-butyldimethylsilyloxy-13-tetrahydropranyl-oxyltridecane (5.3 g, 62.7%) (Found: C, 71.2;

H 10.7; C₃₁H₅₆O₄S requires: C, 71.48; H, 10.84) which showed δ_{H} (250 MHz, CDCl₃): 7.32 (5H, br s), 4.60 (1H, br m), 4.53 (1H, d, $J=11.6$ Hz), 4.46 (1H, d, $J=11.6$ Hz), 3.95–3.7 (3H, m), 3.62–3.45 (3H, m, including a triplet with $J=6.7$ Hz), 3.42–3.34 (1H, m), 1.93–1.71 (2H, m), 1.65–1.50 (6H, m), 1.45–1.22 (18H, br m), 0.88 (9H, s), 0.054 (3H, s), 0.045 (3H, s); δ_{C} : 138.6, 128.3, 127.6, 127.5, 98.8, 72.9, 69.5, 67.7, 67.3, 62.3, 37.6, 36.9, 30.77, 29.8, 29.8, 29.6, 29.6, 29.5, 29.5, 26.2, 25.9, 25.5, 25.0, 19.7, 18.1, –4.4, –4.6; ν_{max} : 2926, 2854, 1119, 1034 cm⁻¹.

(ii) **Method B.** (*R*)-(+)-1-Benzyloxy-3-hydroxy-13-tetrahydropyranyloxytridecane (10 g, 0.025 mol) in dry DMF (10 ml) was added to a stirred solution of imidazole (4.36 g, 0.064 mol) in dry DMF (40 ml) at 5 °C, followed by the addition of *t*-butyldimethylsilylchloride (4.83 g, 0.032 mol). The mixture was allowed to reach room temperature and stirred for 4 h. When TLC showed no starting material, the reaction was quenched with water (200 ml) and the product was extracted with dichloromethane (3 × 100 ml). The combined organic layers were washed with water (2 × 100 ml), dried and evaporated to give an oil; chromatography on silica eluting with petroleum and ethyl acetate (5:0.5) gave (*R*)-(+)-1-benzyloxy-3-*t*-butyl-dimethylsilyloxy-13-tetrahydropyranyloxytridecane (11.9 g, 93%) which showed identical spectra to those obtained above.

2.1.16. (*R*)-1-Hydroxy-3-*t*-butyldimethylsilyloxy-13-tetrahydropyranyloxytridecane. A solution of (*R*)-1-benzyloxy-3-*t*-butyldimethyl-silyloxy-13-tetrahydropyranyloxytridecane (7 g; 0.0134 mol) in methanol (350 ml) was stirred with Pd/C (1.5 g; 10%) under a hydrogen atmosphere for 30 h. When the TLC showed no starting material, the mixture was filtered through Celite and evaporated to give an oil. Chromatography on silica eluting with 5:1 petroleum/ethyl acetate gave (*R*)-1-hydroxy-3-*t*-butyldimethyl-silyloxy-13-tetrahydropyranyloxytridecane (4.86 g; 84%), (Found: C, 67.0; H, 11.7; C₂₄H₅₀O₄Si requires: C, 66.92; H, 11.70) which showed δ_{H} (250 MHz, CDCl₃): 4.53 (1H, br t, $J=4.3$ Hz), 3.92–3.75 (3H, m), 3.71–3.63 (2H, m), 3.54–3.42 (1H, m), 3.35 (1H, dt, $J=6.9, 9.4$ Hz), 1.85–1.72 (2H, m), 1.68–1.44 (10H, m), 1.23 (15H, br s), 0.84 (9H, s), 0.04 (3H, s), 0.03 (3H, s); δ_{C} : 98.8, 72.0, 67.7, 62.3, 60.35, 37.65, 36.8, 30.75, 29.7, 29.5, 29.5, 26.2, 25.8, 25.5, 25.3, 21.0, 19.67, 17.94, 14.16, –4.4, –4.7; ν_{max} : 3445, 2928, 1077 cm⁻¹; $[\alpha]_{\text{D}}^{20}$ –7.3 (*c* 1.2, CHCl₃).

2.1.17. Methyl (*R*)-3,10-dihydroxytridecanoate (22). (*R*)-1-Hydroxy-3-*t*-butyldimethylsilyloxy-13-tetrahydropyranyloxytridecane (2.9 g; 0.0067 mol) in carbon tetrachloride (15 ml) was added over 4 h at 20 °C with stirring to a solution of sodium (meta)periodate (4.33 g; 0.02 mol) and ruthenium(III)chloride hydrate (56 mg; 0.0003 mol) in acetonitrile (30 ml), carbon tetrachloride (15 ml) and water (40 ml). The mixture was stirred for an additional 16 h, then diluted with dichloromethane (50 ml). The aqueous layer was re-extracted with dichloromethane (2 × 50 ml). The combined organic layers were dried and evaporated to give a thick black oil, which was dissolved in ether (100 ml) and filtered through a pad of Celite; the solvent was evaporated and the residue was dissolved in methanol (50 ml) and concentrated sulphuric acid (2 ml). The mixture was refluxed for 6 h, then cooled to room

temperature and the solvent evaporated. The residue was dissolved in dichloromethane (50 ml) and washed with satd aq sodium bicarbonate (10 ml) and water (15 ml). The aqueous layer was re-extracted with dichloromethane (2 × 30 ml). The combined organic layers were dried and evaporated to give a brown precipitate. Chromatography eluting with petroleum/ethyl acetate (1:1) ($R_{\text{f}}=0.24$) gave methyl (*R*)-3,10-dihydroxytridecanoate (22) as a white solid (1.2 g; 69%), (mp 55–57 °C) (Found: C, 64.7; H, 10.8; C₁₄H₂₈O₄ requires: C, 64.58; H, 10.83), which showed δ_{H} (250 MHz, CDCl₃): 4.00–3.91 (1H, m), 3.65 (3H, s), 3.57 (2H, t, $J=6.7$ Hz), 2.46 (1H, dd, $J=3.6, 16.4$ Hz), 2.32 (1H, dd, $J=7.75, 16.4$ Hz), 2.15 (2H, br s), 1.66–1.53 (2H, br m), 1.48–1.25 (16H, br m); δ_{C} : 173.5, 67.97, 62.96, 51.7, 41.1, 36.5, 32.7, 29.5, 29.5, 29.4, 29.3, 25.7, 25.4; ν_{max} : 3300, 1737 cm⁻¹; $[\alpha]_{\text{D}}^{24}$ –15.6 (*c* 1.035, CHCl₃).

2.1.18. Tetracosan-1-ol (23). 1-Bromododecane (45.14 g, 0.118 mol) in tetrahydrofuran (50 ml) was added to magnesium turnings (5.2 g, 0.217 mol) in dry tetrahydrofuran (150 ml) at a rate sufficient to maintain a steady reflux. Once the exothermic reaction had subsided, the mixture was heated under reflux for 3 h. When GLC showed no starting material was left, the Grignard reagent was cooled (0 to –5 °C) then 12-bromododecanol (15 g, 0.0566 mol) in tetrahydrofuran (120 ml) was added. The reaction was cooled again to –50 °C followed by the addition of dilithium tetrachlorocuprate (13 ml, 0.1 M solution). The mixture was stirred for 2 h at this temperature and at room temperature for 12 h, then satd aq ammonium chloride (150 ml) and dilute hydrochloric acid (60 ml, 8 M solution) were added. The mixture was extracted with hot ethyl acetate (2 × 300 ml). The combined organic layers were washed with brine, dried and evaporated to give crude product; recrystallisation from ethyl acetate gave tetracosanol (23) as a white solid (17.96 g, 90%). An analytical sample was further purified by column on silica eluting with petroleum–ethyl acetate (5/1) (mp 74–76 °C, lit.:^{33,29} mp 75.5 °C) (Found: C, 81.5; H, 14.2; C₂₄H₅₀O requires: C, 81.28; H, 14.21) which showed δ_{H} (250 MHz, CDCl₃): 3.60 (2H, t, $J=6.4$ Hz), 1.55–1.45 (4H, m), 1.26 (41H, br s), 0.88 (3H, t, $J=6.7$ Hz); δ_{C} : 63.1, 32.8, 31.9, 29.7, 29.6, 29.6, 29.4, 29.35, 25.7, 22.6, 14.1; ν_{max} : 3300 cm⁻¹.

2.1.19. 1-Bromotetracosane. Triphenylphosphine (8.53 g, 0.032 mol) was added to a stirred suspension of tetracosan-1-ol (9.6 g, 0.027 mol) in dry dichloromethane (250 ml), followed by *N*-bromosuccinimide (6.27 g, 0.035 mol) at ~25 °C. The exothermic reaction was controlled using a water bath. The mixture was stirred at room temperature for 5 h when TLC showed no starting material, then quenched with water (200 ml) and the organic layer separated. The aqueous layer was extracted with dichloromethane (2 × 100 ml). The combined organic layers were dried and evaporated to give a solid, which was refluxed with petroleum (500 ml) and ethyl acetate (20 ml) then filtered. The filtrate was evaporated to give a white solid; chromatography eluting with petroleum–ethyl acetate (5/1) gave a white solid, 1-bromotetracosane (10.5 g, 93%) (mp 49–51 °C, lit.:³⁴ mp 51–52.5 °C) (Found: C, 69.3; H, 11.7; C₂₄H₄₉Br requires: C, 69.04; H, 11.83) which showed δ_{H} (250 MHz, CDCl₃): 3.36 (2H, t, $J=6.7$ Hz), 1.82

(2H, pent, $J=6.7$ Hz), 1.62–1.15 (42H, br s), 0.84 (3H, t, $J=6.2$ Hz); δ_{C} : 34.0, 32.8, 31.9, 29.7 (very broad), 29.6, 29.5, 29.4, 29.35, 28.8, 28.2, 22.7, 14.1; ν_{max} : 2960, 1463, 1261, 1215 cm^{-1} .

2.1.20. 1-Iodotetracosane (24). Sodium iodide (11.33 g, 0.075 mol) was added to a stirred solution of 1-bromotetracosane (10.5 g, 0.025 mol) in acetone (400 ml). Sodium bicarbonate (2.3 g, 0.0277 mol) was added and the mixture was refluxed for 5 h then cooled and evaporated. Water (100 ml) was added and the mixture was extracted with hot dichloromethane (3×100 ml). The combined organic layers were dried, and evaporated to give a solid; chromatography on silica eluting with petroleum–ethyl acetate (5/1) gave 1-iodotetracosane (**24**)³⁸ (10.0 g, 86%) as a creamy white solid (mp 52–54 °C, lit.:³⁵ mp 52–53 °C) (Found: C, 61.9; H, 10.6; $\text{C}_{24}\text{H}_{49}\text{I}$ requires: C, 62.05; H, 10.63) which showed δ_{H} (250 MHz, CDCl_3): 3.14 (2H, t, $J=6.97$ Hz), 1.75 (2H, pent, $J=6.7$ Hz), 1.50–1.20 (42H, br s), 0.83 (3H, t, $J=6.5$ Hz); δ_{C} : 33.55, 31.9, 30.5, 29.7, 29.6, 29.5, 29.4, 28.5, 22.7, 14.1, 9.1, 7.4; ν_{max} : 2950, 1462, 1165, 719 cm^{-1} .

2.1.21. Methyl (R)-3-hydroxy-13-*t*-butyldiphenylsilyloxytridecanoate. Triethylamine (1.77 g; 0.0175 mol) was added to a stirred solution of methyl (R)-3,10-dihydroxytridecanoate (1.3 g; 0.005 mol) in dry dichloromethane (15 ml). After 10 min, *t*-butyldiphenylsilyl chloride (1.78 g, 0.0065 mol) in dichloromethane (3 ml) was added, followed by dimethylaminopyridine (61 mg) in dichloromethane (3 ml). The mixture was stirred for 4 h, when TLC showed no starting material, then quenched with water (10 ml) and worked-up as before to give an oil. Chromatography on silica eluting with 5:1 petrol/ethyl acetate gave a colourless oil, methyl (R)-3-hydroxy-13-*t*-butyldiphenylsilyloxytridecanoate (2.1 g; 84%). (Found: C, 72.0; H, 9.2; $\text{C}_{30}\text{H}_{46}\text{O}_4\text{Si}$ requires: C, 72.24; H, 9.30), which showed δ_{H} (250 MHz, CDCl_3): 7.77–7.40 (4H, m), 7.46–7.73 (6H, m), 4.08–4.00 (1H, m), 3.73 (3H, s), 3.66 (2H, t, $J=6.1$ Hz), 2.87 (1H, br d, $J=4.27$ Hz), 2.54 (1H, dd, $J=3.6, 16.4$ Hz), 2.38 (1H, dd, $J=8.5, 16.4$ Hz), 1.66–1.52 (2H, m), 1.45–1.22 (16H, br m) 1.09 (9H, s); δ_{C} : 173.6, 135.6, 134.8, 134.2, 129.6, 129.4, 127.7, 127.5, 67.9, 64.0, 51.7, 41.0, 36.4, 32.6, 29.6, 29.5, 29.4, 26.9, 26.5, 25.8, 25.5, 19.2; ν_{max} : 3455, 1738 cm^{-1} ; $[\alpha]_{\text{D}}^{24} -10.6$ (c 0.97, CHCl_3).

2.1.22. Methyl (2R,3R)-3-hydroxy-2-tetracosanyl-13-*t*-butyldiphenylsilyloxytridecanoate (25). Butyllithium (6.8 ml; 0.01 mol, 1.5 M in hexane) was added to a stirred solution of diisopropylamine (1.02 g; 0.01 mol) in dry tetrahydrofuran (10 ml) at -10 °C, allowed to reach room temperature for 15 min, then the solution of lithium diisopropylamide was cooled to -50 °C and methyl (R)-3-hydroxy-13-*tert*-butyldiphenylsilyloxytridecanoate (2.03 g; 0.00407 mol) in dry tetrahydrofuran (8 ml) was added dropwise at below -40 °C. The reaction was allowed to reach -10 °C, when a mixture of 1-iodotetracosane (2.83 g; 0.006 mol), and hexamethylphosphoramide (1.5 g; 0.008 mol) in tetrahydrofuran (10 ml) was added. The mixture was slowly allowed to reach 10 °C, stirred for 22 h, then quenched with satd aq ammonium chloride (15 ml) and extracted with ethyl acetate (3×50 ml). The combined organic layers were washed with water

(2×20 ml), dried and evaporated to give a residue. Chromatography on silica eluting with petrol–ethyl acetate (5/0.5) gave methyl (2R,3R)-3-hydroxy-2-tetracosanyl-13-*t*-butyldiphenylsilyloxytridecanoate (**25**) (1.05 g; 31%), as a white solid, mp 46–48 °C (Found: C, 77.4; H, 11.0; $\text{C}_{54}\text{H}_{94}\text{O}_4\text{Si}$ requires: C, 77.63; H, 11.34), which showed δ_{H} (250 MHz, CDCl_3): 7.71–7.67 (4H, m), 7.44–7.22 (6H, m), 3.73 (3H, s), 3.70 (1H, m), 3.67 (2H, t, $J=6.4$ Hz), 2.45 (1H, br dt, $J=5.8, 9.0$ Hz; integration showed two protons, which reduced to one after shaking with D_2O), 1.85–1.21 (64H, br m), 1.07 (9H, s), 0.90 (3H, t, $J=6.4$ Hz); δ_{C} : 176.2, 135.56, 134.2, 129.4, 127.5, 72.3, 64.0, 51.45, 50.8, 35.7, 32.6, 31.9, 29.7, 29.55, 29.4, 29.35, 27.4, 26.9, 25.8, 22.7, 19.2, 14.1; ν_{max} : 3358, 1713 cm^{-1} ; $[\alpha]_{\text{D}}^{22} +4.46$ (c 1.03, CHCl_3).

2.1.23. (2R,3R)-3-Acetoxy-2-tetracosanyl-13-hydroxytridecanoate. (A) A mixture of acetic anhydride (10 ml) and anhydrous pyridine (10 ml) was added to a stirred solution of methyl (2R,3R)-3-hydroxy-2-tetracosanyl-13-*t*-butyldiphenylsilyloxytridecanoate (**25**) (0.89 g; 0.96 mmol) in dry toluene (7 ml). The mixture was stirred for 16 h at room temperature then diluted with toluene (10 ml); the solvent was evaporated under reduced pressure to give an oil. Chromatography on silica eluting with petrol–ethyl acetate (5/0.5) gave methyl (2R,3R)-3-acetoxy-2-tetracosanyl-13-*t*-butyldiphenylsilyloxytridecanoate (0.73 g, 86%) as a thick oil (Found: C, 77.1; H, 11.2; $\text{C}_{56}\text{H}_{96}\text{O}_5\text{Si}$ requires: C, 76.65; H, 11.03) which showed δ_{H} : 7.72–7.67 (4H, m), 7.55–7.36 (6H, m) 5.15–5.11 (1H, m), 3.70 (3H, s), 3.67 (2H, t, $J=6.7$ Hz), 2.64 (1H, ddd, $J=4.25, 6.7, 10.67$ Hz), 2.04 (3H, s), 1.62–1.52 (6H, m), 1.30 (58H, br s), 1.07 (9H, s), 0.90 (3H, t, $J=6.1$ Hz); ν_{max} : 1742 cm^{-1} , $[\alpha]_{\text{D}}^{22} +6.9$ (c 1.39, CHCl_3).

(B) Tetra-*n*-butylammonium fluoride (1.8 ml, 1 M solution, 1.8 mmol) was added with stirring to methyl (2R,3R)-3-acetoxy-2-tetracosanyl-13-*t*-butyldiphenylsilyloxytridecanoate (0.62 g; 0.71 mmol) in dry tetrahydrofuran (10 ml) at ca. 5 °C. The mixture was stirred for 16 h at room temperature when TLC showed no starting material; the solution was evaporated, the residue quenched with water (10 ml) and the product extracted with dichloromethane (3×30 ml). The combined organic layers were dried and evaporated to give a thick oil. Chromatography on silica, eluting with petrol–ethyl acetate (5/1.5) gave methyl (2R,3R)-3-acetoxy-2-tetracosanyl-13-hydroxytridecanoate as a white solid (0.32 g, 74%) (mp 52–54 °C) (Found: C, 75.4; H, 12.2; $\text{C}_{40}\text{H}_{78}\text{O}_5$ requires: C, 75.18; H, 12.3) which showed δ_{H} (250 MHz, CDCl_3): 5.08 (1H, ddd, $J=4.2, 7, 11.3$ Hz), 3.67 (3H, s), 3.63 (2H, t, $J=6.4$ Hz), 2.61 (1H, ddd, $J=4.2, 6.7, 10.7$ Hz), 2.03 (3H, s), 1.65–1.55 (6H, m), 1.25 (59H, br s), 0.88 (3H, t, $J=7$ Hz); δ_{C} : 173.6, 170.3, 74.1, 63, 51.5, 49.6, 32.75, 31.9, 31.7, 29.6, 29.6, 29.5, 29.5, 29.4, 29.4, 28.1, 27.4, 25.7, 24.96, 22.6, 20.9; ν_{max} : 3415, 1731 cm^{-1} ; $[\alpha]_{\text{D}}^{22} +10.14$ (c 1.015, CHCl_3).

2.1.24. ((1R, 2R)-1-Acetoxy-11-oxoundecyl)hexacosanoic acid methyl ester (26). Methyl (2R,3R)-3-acetoxy-2-tetracosanyl-13-hydroxytridecanoate (0.2 g, 0.0031 mol) in dichloromethane (3 ml) was added to a suspension of pyridinium chlorochromate (0.17 g, 0.0078 mol) in dichloromethane (10 ml) at room temperature. A black

colour appeared after 10 min; after 2 h, TLC showed no starting material, and the reaction was diluted with ether (50 ml) and filtered through a pad of silica. The solvent was evaporated to give a solid. Chromatography eluting with petrol and ethyl acetate (5:1) gave a white solid, ((1*R*, 2*R*)-1-acetoxy-11-oxoundecyl)hexacosanoic acid methyl ester (**26**) (0.19 g, 95%) (Found: C, 75.8; H, 11.8; C₄₀H₇₆O₅ requires: C, 75.42; H, 12.02) which showed δ_{H} (250 MHz, CDCl₃): 9.73 (1H, t, $J=1.8$ Hz), 5.03 (1H, ddd, $J=4.2, 7, 11.3$ Hz), 3.64 (3H, s), 2.57 (1H, ddd, $J=4.2, 6.7, 10.7$ Hz), 2.38 (2H, dt, $J=1.8, 7.2$ Hz), 2.03 (3H, s), 1.95–1.08 (62H, br s), 0.88 (3H, t, $J=7$ Hz); δ_{C} : 202.9, 173.6, 170.3, 74.1, 51.5, 49.6, 43.9, 31.9, 31.7, 29.7 (very broad), 29.3, 29.1, 28.1, 27.5, 25.0, 22.6, 22.0, 21.0, 14.1; ν_{max} : 2917, 2849, 1741 cm⁻¹; $[\alpha]_{\text{D}}^{22} +9.8$ (c 1.06, CHCl₃).

2.1.25. 2-((1*S*,2*R*)-2-[14-((1*S*,2*R*)-2-Eicosylcyclopropyl)tetradecyl]cyclopropylmethanesulfonyl)benzothiazole (27**).** (A) Diethyl azodicarboxylate (1.06 g, 6.1 mmol) in dry tetrahydrofuran (10 ml) was added to a stirred solution of {(1*S*,2*R*)-2-[14-((1*S*,2*R*)-2-eicosylcyclopropyl)tetradecyl]cyclopropyl}methanol (2.5 g, 4.23 mmol), triphenylphosphine (1.57 g, 6.0 mmol) and 2-mercaptobenzothiazole (0.88 g, 5.28 mmol) in dry tetrahydrofuran (25 ml) at 0 °C. The mixture was allowed to reach room temperature and stirred for 48 h. The solvent was evaporated and the residue was dissolved in ether (50 ml) and petroleum (50 ml), then filtered through a pad of silica and evaporated to give a pale yellow oil. Chromatography on silica eluting with 10:0.5 petrol/ether gave 2-((1*S*,2*R*)-2-[14-((1*S*,2*R*)-2-eicosylcyclopropyl)tetradecyl]cyclopropylmethanesulfonyl)benzothiazole (2.1 g, 66%) which showed δ_{H} (250 MHz, CDCl₃): 7.88 (1H, br dd, $J=0.6, 8.25$ Hz), 7.76 (1H, br dd, $J=6, 8$ Hz), 7.44 (1H, br dt, $J=1.5, 8.5$ Hz), 7.30 (1H, dt, $J=1.22, 8$ Hz), 3.48 (1H, dd, $J=7.6, 15.5$ Hz), 3.39 (1H, dd, $J=7.9, 12.5$ Hz), 1.65–1.22 (66H, br m), 0.92–0.83 (6H, m), 0.68–0.59 (3H, m), 0.09–0.05 (1H, m), –0.30 to –0.35 (1H, m); δ_{C} : 167.4, 153.3, 135.2, 125.9, 124.0, 121.4, 120.9, 34.8, 31.9, 30.2, 30.0, 29.7 (very broad), 29.6, 29.3, 28.7, 28.5, 22.7, 17.7, 15.8, 14.9, 14.1, 12.3, 10.9; ν_{max} : 2923, 1455, 1426 cm⁻¹, $[\alpha]_{\text{D}}^{22} -6.38$ (c 1.36, CHCl₃).

(B) *m*-Chloroperbenzoic acid (3 g) in dichloromethane (25 ml) was added slowly to a stirred solution of 2-((1*S*,2*R*)-2-[14-((1*S*,2*R*)-2-eicosylcyclopropyl)tetradecyl]cyclopropylmethanesulfonyl)benzothiazole (2 g, 2.8 mmol) and sodium bicarbonate (1.7 g, 20 mmol) in dichloromethane (30 ml) at 5 °C. The mixture was stirred for 48 h at room temperature, when TLC showed no starting material. Work up as before gave a yellow solid, which was purified by chromatography on silica eluting with 5:2 petroleum/diethyl ether to give 2-((1*S*,2*R*)-2-[14-((1*S*,2*R*)-2-eicosylcyclopropyl)tetradecyl]cyclopropylmethanesulfonyl)benzothiazole (**27**) (1.36 g, 62%) [Found: C, 74.4; H, 10.6; N, 2.0; C₄₈H₈₃O₂S₂N requires: C, 74.84; H, 10.86; N, 1.82] [Found M⁺: 770.5927, C₄₈H₈₃O₂S₂N requires: 770.5943] which showed δ_{H} (250 MHz, CDCl₃): 8.24 (1H, br d, $J=8$ Hz), 8.03 (1H, dd, $J=1.2, 8$ Hz), 7.68–7.57 (2H, m), 3.74 (1H, dd, $J=5.2, 14.3$ Hz), 3.34 (1H, dd, $J=9.45, 14.3$ Hz), 1.95–1.12 (66H, br m), 0.99–0.89 (5H, m, including a triplet with a coupling constant $J=6.4$ Hz), 0.81–0.72 (1H, m), 0.71–0.52 (3H, m), 0.01 (1H, br q, $J=5.5$ Hz), –0.31 (1H, q, $J=5.5$ Hz), δ_{C} : 166.1, 152.6, 136.8,

127.9, 127.6, 125.4, 122.3, 55.7, 31.9, 30.2, 29.7 (very broad), 29.3, 29.0, 28.7, 22.7, 15.8, 15.8, 14.1, 11.3, 10.9, 8.8; ν_{max} : 2922, 1707, 1468 cm⁻¹, $[\alpha]_{\text{D}}^{22} +14.8$ (c 0.81, CHCl₃).

2.1.26. (R)-2-((R)-1-Acetoxy-12-((1*S*,2*R*)-2-[14-((1*S*,2*R*)-2-eicosylcyclopropyl)tetradecyl]cyclopropyl)dodec-11-enyl)hexacosanoic acid methyl ester. Lithium hexamethyldisilazide (0.5 ml, 0.49 mmol) was added dropwise to a stirred solution of (**26**) (0.19 g, 0.3 mmol) and (**27**) (0.253 g, 0.33 mmol) in dry THF (15 ml) under nitrogen at –5 °C. The reaction was exothermic and the temperature rose to 5 °C resulting in a dark orange solution. It was allowed to reach room temperature and stirred for 24 h, then cooled to 0 °C and quenched with satd aq ammonium chloride (5 ml). The product was extracted with ethyl acetate (2 × 20 ml), dried and evaporated to give a thick oil, which was purified by chromatography on silica eluting with petroleum–ether (10/0.5) to give ca. 1.7:1 *E*:*Z* (*R*)-2-((*R*)-1-acetoxy-12-((1*S*,2*R*)-2-[14-((1*S*,2*R*)-2-eicosylcyclopropyl)tetradecyl]cyclopropyl)dodec-11-enyl)hexacosanoic acid methyl ester (**28**) (0.13 g, 37%) which showed δ_{H} (250 MHz, CDCl₃) (major isomer): 5.53 (1H, br dt, $J=6.6, 15.1$ Hz), 5.18 (1H, br dd, $J=8.5, 15.1$ Hz), 5.11 (1H, m), 3.68 (3H, s), 2.62 (1H, ddd, $J=4.2, 6.7, 10.7$ Hz), 2.18–2.12 (1H, m), 2.03 (3H, s), 2.00–1.95 (2H, m) 1.75–1.48 (14H, br m), 1.45–1.12 (113H, m), 0.97–0.82 (9H, including a triplet, $J=7$ Hz), 0.72–0.62 (2H, m), 0.58 (1H, dt, $J=4.1, 8$ Hz), 0.12 (1H, br q, $J=5.35$ Hz), –0.31 (1H, br q, $J=5.3$ Hz); δ_{H} (minor isomer): 5.43 (1H, br t, $J=11.0$ Hz), 5.05 (1H, br t, $J=11.0$ Hz), the remaining signals were obscured by those of the major isomer, δ_{C} : 173.6, 170.3, 130.4, 130.13, 129.5, 74.1, 51.5, 49.6, 32.7, 31.9, 31.7, 30.2, 29.7 (very broad), 29.5, 29.5, 29.3, 29.1, 28.7, 28.1, 27.45, 25.0, 22.6, 21, 18.4, 18.24, 15.75, 14.1, 13.9, 12.3, 10.9; ν_{max} : 2917, 2849, 1745, 1467, 1234, 1021 cm⁻¹; mass spectra: FAB, m/z : 1214 (M+Na)⁺ for C₈₁H₁₅₄O₄ (1191.1847), NOBA matrix showed: 121/894/1046/1132/1214.

2.1.27. (R)-2-((R)-1-Acetoxy-12-((1*S*,2*R*)-2-[14-((1*S*,2*R*)-2-eicosylcyclopropyl)tetradecyl]cyclopropyl)dodecyl)hexacosanoic acid methyl ester (8**).** Dipotassium azodicarboxylate (1.5 g, 7.73 mmol) was added to a stirred solution of (**28**) (0.05 g, 0.042 mmol) in dry THF (7 ml) at 10 °C under nitrogen resulting in a yellow suspension. A solution of glacial acetic acid (2 ml) in dry THF (4 ml) was added dropwise over 16 h, after which a white precipitate had formed. The mixture was cooled to 0 °C and quenched slowly with satd aq ammonium chloride (5 ml). The product was extracted with ethyl acetate (2 × 25 ml). The combined organic layers were washed with water (20 ml), dried and evaporated to give a thick oil, which solidified slowly; however, the ¹H NMR spectra showed that there was still starting material left. The procedure was repeated for another 16 h and the residue was purified by chromatography on silica eluting with petroleum–ether (10/0.5) to give (*R*)-2-((*R*)-1-acetoxy-12-((1*S*,2*R*)-2-[14-((1*S*,2*R*)-2-eicosylcyclopropyl)tetradecyl]cyclopropyl)dodecyl)hexacosanoic acid methyl ester (**8**) as a semi-solid (0.03 g, 60%) (Found: C, 81.5; H, 12.9; C₈₁H₁₅₆O₄ requires: C, 81.47; H, 13.17); which showed δ_{H} (500 MHz): 5.11–5.07 (1H, ddd, $J=4.2, 7, 11.3$ Hz, CHOCOCH₃), 3.68 (3H, s, OCH₃), 2.64–2.60 (1H, ddd,

$J=4.2, 6.7, 10.7$ Hz, $CHCO$), 2.03 (3H, s, $COCH_3$) 1.61–1.15 (134H, br m, CH satd), 0.88 (6H, t, $J=6.45$ Hz, $2\times$ terminal CH_3), 0.68–0.62 (4H, m, $4\times CH$ cyclopropane), 0.58–0.53 (2H, dt, $J=4, 8$ Hz, $2\times HCH$, of the cyclopropane), -0.31 to -0.34 (2H, br q, $J=5.5$ Hz, $2\times HCH$ of cyclopropane); δ_C : 173.6, 170.3, 74.1 (–), 51.5 (–), 49.6 (–), 31.9 (+), 31.7 (+), 30.2(+), 29.7 (very broad, +), 29.5 (+), 29.4 (+), 29.3(+), 28.7 (+), 28.1(+), 27.5(+), 24.96(+), 22.6(+), 21(–), 15.8(–), 14.1(–), 10.9(+)[$+^{ve}=CH_2$, $-^{ve}=CH$, CH_3]; ν_{max} : 2921, 2849, 1736 cm^{-1} ; $[\alpha]_D^{22} +4.22$ (c 0.735, $CHCl_3$).

Acknowledgements

We thank Professor D. E. Minnikin for valuable discussions. Thanks are also due to the EPSRC MS Service in Swansea and to Dr. B. Grail of the School of Biological Sciences, Bangor, for obtaining the mass spectra of **8**.

References and notes

- (a) Brennan, P. J.; Nikaido, H. *Annu. Rev. Biochem.* **1995**, *64*, 29–63. (b) Qureshi, N.; Takayama, K.; Jordi, H. C.; Schnoes, H. K. *J. Biol. Chem.* **1978**, *253*, 5411–5417. (c) Minnikin, D. E.; Daffe, M.; Draper, P. *Adv. Microbial Phys.* **1998**, *39*, 131–203. (d) Minnikin, D. E.; Kremer, L.; Dover, L. G.; Besra, G. S. *Chem. Biol.* **2002**, *9*, 545.
- Minnikin, D. E.; Polgar, N. *J. Chem. Soc., Chem. Commun.* **1967**, 312–314, 916–918. (See also pp 1172–1174).
- Yuan, Y.; Crane, D. C.; Musser, J. M.; Sreevatsan, S.; Barry, C. E. *J. Biol. Chem.* **1997**, *272*, 10041–10049. George, K. M.; Yuan, Y.; Sherman, D. S.; Barry, C. E. *J. Biol. Chem.* **1995**, *272*, 27292–27298.
- Dobson, G.; Minnikin, D. E.; Minnikin, S. M.; Parlett, J. H.; Goodfellow, M.; Ridell, M.; Magnusson, M. In *Chemical Methods in Bacterial Systematics*; Minnikin, D. E., Goodfellow, M., Eds.; Academic: London, 1985; p 237.
- Glickman, M. S.; Cahill, S. M.; Jacobs, W. R. *J. Biol. Chem.* **2001**, *276*, 2228–2233.
- Toubiana, R.; Desh, B. C.; Defaye, J.; Mompon, G.; Toubiana, M.-J. *Carbohydr. Res.* **1975**, *44*, 308–312. Prome, J.-C.; Lacave, C.; Ahibo-Coffy, A.; Savagnac, A. *Eur. J. Biochem.* **1976**, *63*, 543–552. Baer, H. H.; Wu, X. *Carbohydr. Res.* **1993**, *245*, 347.
- See, for example, Matsunaga, I.; Oka, S.; Fujiwara, N.; Yano, I. *J. Biochem.* **1996**, *120*, 663–670. Parant, M.; Audibert, F.; Parant, F.; Chelid, L.; Soler, E.; Polonsky, J.; Lederer, E. *Infect. Immunol.* **1978**, *20*, 12–19. Tanaka, A.; Sugiyama, K.; Azuma, I.; Yamamura, Y.; Kato, M.; Goren, M. B. *Infect. Immun.* **1976**, *13*, 776–781. Sueoka, E.; Nishiwaki, S.; Okabe, S.; Iida, N.; Suganuma, M.; Yano, I.; Aoki, K.; Fujiki, H. *Jpn. J. Cancer Res.* **1995**, *86*, 749–755. Yano, I. *Kekkaku* **1998**, *73*, 37–42.
- See, for example, Pan, J.; Fujiwara, N.; Oka, S.; Maekura, R.; Ogura, T.; Yano, I. *Microbiol. Immunol.* **1999**, *43*, 863–869. Fujiwara, N.; Pan, J.; Enomoto, K.; Terano, Y.; Honda, T.; Yano, I. *FEMS Immunol. Med. Microbiol.* **1999**, *24*, 141–149. He, H.; Oka, S.; Han, Y.; Yamamura, Y.; Kusunose, E.; Kusunose, M.; Yano, I. *Microbiol. Immunol.* **1991**, *76*, 201–204. Maekura, R.; Nakagawa, M.; Nakamura, Y.; Higara, T.; Yamamura, Y.; Ito, M.; Ueda, E.; Yano, S.; He, H.; Oka, S.; Kashima, K.; Yano, I. *Am. Rev. Respir. Dis.* **1993**, *148*, 997–1001.
- Wang, L.; Izumi, S.; He, H.; Fujiwara, N.; Saita, N.; Yano, I.; Kobayashi, K.; Tatsumi, N. *Jpn. J. Lepr.* **1999**, *68*, 165–174. Fujiwara, N.; Oka, S.; Ide, M.; Kashima, K.; Honda, T.; Yano, I. *Microbiol. Immunol.* **1999**, *43*, 785–793.
- See, for example, Gensler, W. J.; Marshall, J. P. *Chem. Phys. Lipids* **1977**, *19*, 128–143.
- For the analysis of mycolic acids see, for example, Watanabe, M.; Aoyagi, Y.; Mitome, H.; Fujita, T.; Naoki, H.; Ridell, M.; Minnikin, D. E. *Microbiology* **2002**, *148*, 1881. Watanabe, M.; Aoyagi, Y.; Ridell, M.; Minnikin, D. E. *Microbiology* **2001**, *147*, 1825. Minnikin, D. E.; Kremer, L.; Dover, L. G.; Besra, G. S. *Chem. Biol.* **2002**, *9*, 545.
- Lacave, C.; Lanéelle, M.-A.; Daffé, M.; Montrozier, H.; Rols, M.-P.; Asselineau, C. *Eur. J. Biochem.* **1987**, *163*, 369. Asselineau, C.; Asselineau, J.; Tocanne, G. *Bull. Soc. Chim. Fr.* **1966**, 1992.
- Daffé, M.; Lanéelle, M. A.; Lacave, C. *Res. Microbiol.* **1991**, *142*, 397–403. Dubnau, E.; Lanéelle, M.-A.; Soares, S.; Benichou, A.; Vaz, T.; Prome, D.; Prome, J. C.; Daffé, M.; Quemard, A. *Mol. Microbiol.* **1997**, *23*, 313.
- See, for example, Lee, R. E.; Armour, J. W.; Takayama, K.; Brennan, P. J.; Besra, G. S. *Biochim. Biophys. Acta* **1997**, *1346*, 275–284. Grogan, D. W.; Cronan, J. E. *Microbiol. Mol. Biol. Rev.* **1997**, *61*, 429–441. Asselineau, C.; Asselineau, J.; Lanéelle, G.; Lanéelle, M.-A. *Prog. Lipid Res.* **2002**, *41*, 501. Kremer, L.; Baulard, A. R.; Besra, G. S. In *Molecular Genetics of Mycobacteria*; Hatfull, G. F., Jacobs, W. R., Eds.; American Society for Microbiology: Washington, DC, 2000; pp 173–190.
- Yuan, Y.; Mead, D.; Schroeder, B. G.; Zhu, Y. Q.; Barry, C. E. *J. Biol. Chem.* **1998**, *273*, 21282–21290. Yuan, Y.; Barry, C. E. *Proc. Nat. Acad. Sci. U.S.A.* **1996**, *93*, 12828–12833.
- Gensler, W. J.; Marshall, J. P.; Langone, J. J.; Chen, J. C. *J. Org. Chem.* **1977**, *42*, 118–125.
- Baird, M. S.; Al Dulayymi, J. R.; Roberts, E. *Tetrahedron Lett.* **2000**, *41*, 7107–7110.
- Dubneau, E.; Laneelle, M.-A.; Soares, S.; Benichou, A.; Vaz, T.; Prome, D.; Prome, J.-C.; Daffé, M.; Quemard, A. *Mol. Microbiol.* **1997**, *23*, 313–322.
- Grandjean, D.; Pale, P.; Cuche, J. *Tetrahedron* **1991**, *47*, 1215.
- Krapcho, A. P.; Larson, J. R.; Eldridge, J. M. *J. Org. Chem.* **1977**, *42*, 3749–3753.
- Baudin, J. B.; Hareau, G.; Julia, S. A.; Ruel, O. *Tetrahedron Lett.* **1991**, *32*, 1175–1178. Blakemore, J. R.; Kocienski, P. J.; Marzcak, S.; Wicha, J. *Synthesis* **1999**, 1209–1215. Smith, N. D.; Kocienski, P. J.; Street, S. D. A. *Synthesis* **1996**, 652–666.
- Kitano, Y.; Kobayashi, Y.; Sato, F. *J. Chem. Soc., Chem. Commun.* **1985**, 498–499.
- Utaka, M.; Higashi, H.; Takeda, A. *J. Chem. Soc., Chem. Commun.* **1987**, 1368–1369.
- Prepared from (*R*)-aspartic acid based on, Frick, J. A.; Klassen, J. B.; Bathe, A.; Abramson, J. M.; Rappoport, H. *Synthesis* **1992**, 621.
- Fujisawa, T.; Fujimura, A.; Sato, F. *Bull. Chem. Soc. Jpn.* **1988**, *61*, 1273–1279.
- Jorgensen, W. *J. Am. Chem. Soc.* **1969**, *91*, 6430–6443.
- We thank Prof. D. E. Minnikin for providing a sample of natural α -mycolic acid.²

28. Coxon, G. D.; Knobl, S.; Roberts, E.; Baird, M. S.; Al Dulayymi, J. R.; Minnikin, D. E. *Tetrahedron: Asymmetry* **2003**, *14*, 1211–1222.
29. Watanabe, A. *Bull. Chem. Soc. Jpn.* **1963**, *36*, 336–340.
30. Delpeuch, J.-J. *Bull. Soc. Chim. Fr.* **1966**, 1631.
31. Bricard, L.; Kunesch, G. *Synth. Commun.* **1993**, *23* 18, 2547.
32. Bai, D.; Bo, Y.; Zhou, Q. *Tetrahedron Lett.* **1990**, 2161–2164.
33. This has previously been prepared by reduction of the corresponding acid or its esters (Watanabe, A. *Bull. Chem. Soc. Jpn.*, **1961**, *34*, 398–402), from the corresponding alkene or alkyne by hydroboration (Brown, H. C.; Iyer, R. R.; Bhat, N. G. Racherla, U. S.; Brown, C. A. *Tetrahedron*, **1992**, *48*, 9187), or from tetracos-10-yn-1-ol (Menger, F. M.; Yamasaki, Y. *J. Am. Chem. Soc.* **1993**, *115*, 3840).
34. This has previously been prepared from the alcohol by reaction with HBr (Lukes, C. *Collect. Czech. Chem. Commun.*, **1958**, *23*, 497, 500) or PBr₃ (Lukes, C. *Collect. Czech. Chem. Commun.*, **1958**, *23*, 1100, 1102, 1107) or by coupling of octadecylmagnesium bromide to 1,6-dibromohexane in the presence of Li CuCl₄.³⁵
35. Gensler, W.; Alam, I.; Prasad, R. S.; Radhakrishnan, A. I.; Laudhun, A. P. C. *Tetrahedron* **1979**, *35*, 2595–2600.
36. Frick, J. A.; Klassen, J. B.; Bathe, A.; Abramson, J. M.; Rapoport, H. *Synthesis* **1992**, 621–623.
37. Sharma, A.; Chattopadhyay, S. *J. Org. Chem.* **1998**, *63*, 6128. Wolfgang, M.; Clemensk, H.; Juergen, S.; Gladysz, J. A. *Synthesis* **2003**, *8*, 1279.
38. The iodide has previously been prepared either by this method or direct from the alcohol by reaction with iodine and phosphorus.³⁵
39. Linstrumelle, G.; Krieger, J. K.; Whiteside, G. M. *Org. Synth.* **1976**, *55*, 103–113.

Oxidative nucleophilic substitution of hydrogen in nitroarenes with phenylacetic acid derivatives

Mieczysław Mąkosza,* Krystyna Kamińska-Trela, Maciej Paszewski and Małgorzata Bechcicka

Institute of Organic Chemistry, Polish Academy of Sciences, ul. Kasprzaka 44/52, PL-01-224 Warsaw, Poland

Received 9 June 2005; revised 1 September 2005; accepted 15 September 2005

Available online 10 October 2005

Dedicated to Professor V. I. Minkin on the occasion of his 70th birthday

Abstract—Oxidative nucleophilic substitution of hydrogen (ONSH) in nitroarenes with carbanion of isopropyl phenyl acetate gives various products depending on the conditions and oxidant. The reaction carried out in liquid ammonia and KMnO_4 oxidant gives *iso*-propyl α -hydroxy- α -nitroarylphenylacetates formed via hydroxylation of the initial ONSH products. In some cases additionally dimeric, trimeric and tetrameric products are formed. In THF and $\text{Bu}_4\text{N}^+\text{MnO}_4^-$ or DDQ oxidants simple ONSH products are formed whereas oxidation by dimethyl dioxirane (DMD) gave *iso*-propyl hydroxyaryl phenyl acetates. The dimeric and trimeric products are apparently formed via coupling of nitrobenzylic radicals generated in course of oxidation with nitrobenzylic carbanions of the ONSH products.
© 2005 Elsevier Ltd. All rights reserved.

1. Introduction

Oxidative nucleophilic substitution of hydrogen (ONSH), in nitroarenes and other electron deficient arenes is presently a well recognized process.^{1–6} Of particular interest and value is introduction of carbon substituents into nitroaromatic rings via oxidation of σ^{H} adducts of carbon nucleophiles such as Grignard reagents^{7–9} and carbanions¹⁰ to nitroarenes. In our recent studies we have shown that this reaction proceeds efficiently between nitroarenes and tertiary (methinic) carbanions generated from 2-phenylalkanenitriles¹¹ and esters of *iso*-butyric¹² and 2-phenylpropionic acids.¹³ Addition of these carbanions to nitroarenes proceeds mainly *para* to the nitro group and the produced σ^{H} adducts are oxidized by KMnO_4 ^{11–13} in liquid ammonia or DDQ in THF giving products of ONSH in *para* positions. It should be noted that oxidation with KMnO_4 is sensitive to steric hindrances, bulky substituents *ortho* to the addition site (*meta* to the nitro group) hinder or inhibit the oxidation process.¹¹ On the other hand, oxidation of these σ^{H} adducts with dimethyl dioxirane (DMD) in THF gives *para* substituted phenols.^{14,15} This oxidant reacts directly with negatively charged nitro group

of the σ^{H} adducts in a process analogous to the Nef reaction.¹⁵

Oxidation of σ^{H} adducts of secondary (methylene) carbanions to nitroarenes is somewhat more complicated process because the addition can take place at *ortho* and *para* positions so isomeric σ^{H} adducts and subsequently ONSH products can be formed. Moreover the products in which hydrogen of the methylenic group is replaced with a nitroaromatic ring are much stronger CH acids than the carbanion precursors thus in the case the reaction media contain basis agents, the ONSH products could be deprotonated and further oxidized. The highly stabilized nitrobenzylic carbanions of the ONSH products are weak nucleophiles and do not form σ^{H} adducts with nitroarenes so disubstitution via ONSH is not observed. There are many reported examples of ONSH process with secondary carbanions in which atmospheric oxygen acted as the oxidant, usually in these cases the reaction requires excess of base.^{10,16,17} It is therefore supposed that σ^{H} adducts of such carbanions are further deprotonated before being oxidized with oxygen. The reaction of secondary carbanion of phenylacetone nitrile with nitrobenzene in liquid ammonia and KMnO_4 oxidant gave a mixture of *o*- and *p*-nitrobenzophenones.¹⁸ It seems that the initial ONSH products formed by oxidation of the σ^{H} adducts *ortho* and *para* to the nitro group were deprotonated and the produced carbanions oxidized to cyanohydrines that dissociated to benzophenones.

Keywords: Carbanions; Nitroarenes; σ -Adducts; Oxidation; Nucleophilic substitution.

* Corresponding author. Tel.: +48 22 3432334; fax: +48 22 6326681; e-mail: icho-s@icho.edu.pl

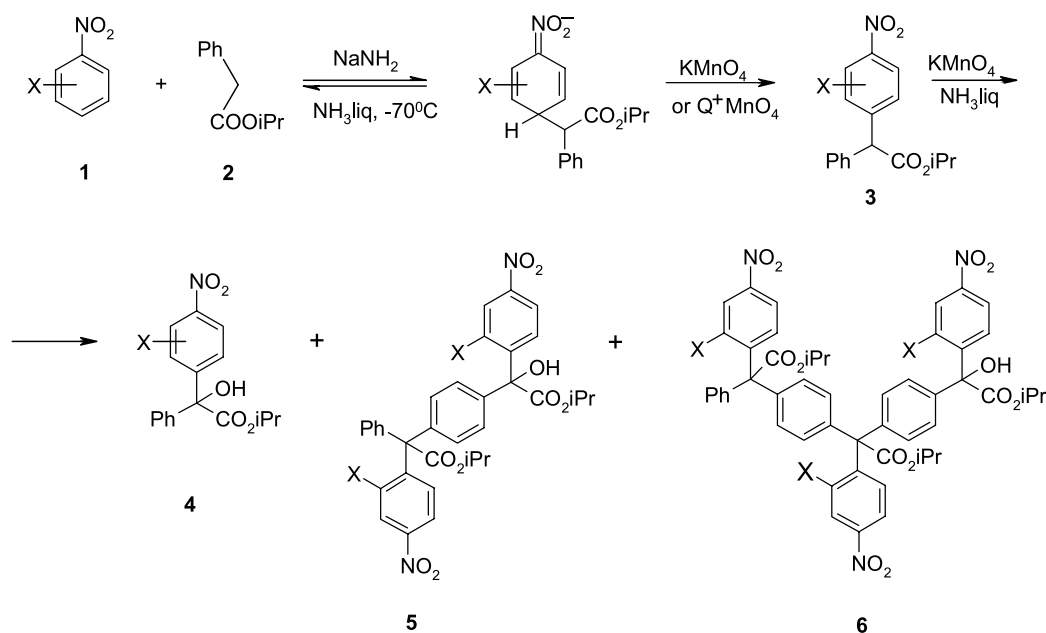

Scheme 1.

2. Results and discussion

The products of ONSH reaction in nitroarenes by carbanions of alkyl phenylacetates—esters of nitroaryl phenylacetic acids—upon deprotonation and further oxidation should form esters of α -hydroxy nitroaryl phenylacetic acids. Since such esters should be stable under these conditions we have studied ONSH reaction in a series of substituted nitrobenzenes **1a–o** with carbanion of *iso*-propyl phenylacetate **2**. The reactions were carried out in liquid ammonia, the carbanions generated by action of NaNH_2 and the intermediate σ^{H} adducts oxidized with KMnO_4 . Since the expected ONSH products **3a** should be strong CH acids the base was used in excess. The reaction of **2** with nitrobenzene **1a** in ratio 1:1 gave not a simple ONSH product **3a**, but *iso*-propyl 2-phenyl-2-*p*-nitrophenyl-2-hydroxypropionate **4a**, in moderate yield 40%. Obviously, the expected initially formed ONSH product was further deprotonated and oxidized in form of nitrobenzylic carbanion to the hydroxy ester. When nitrobenzene was used in an excess (2 equiv) yield of **4a** was much higher: 78%. It seems therefore that in the former case, due to moderate electrophilicity of **1a**, the addition equilibrium was not sufficiently shifted to the σ^{H} adducts, hence in further experiments nitroarenes were used in excess. It should be mentioned that under these conditions the ONSH reaction proceeded only *para* to the nitro group. Similar products were formed in the reaction of **2** with a series of nitroarenes **1b–m**.

The reaction of **2** with *m*-halonitrobenzenes **1c,e,g,h**, and **j** was more complicated. Besides of the expected α -hydroxyesters **4c,e,g,h,j**, produced via hydroxylation of the initial ONSH products, substantial quantities of products of higher molecular weight were isolated from the reaction mixtures. For instance the reaction of **2** with *m*-chloronitrobenzene **1e** gave expected hydroxyester **4e** 29% and two other products **5e** and **6e**. On the basis of detailed MS (EI and ESI experiments), ^1H and ^{13}C NMR analysis including

correlation spectra of the compounds **5e** and **6e** they were assigned dimeric and trimeric structures, respectively, as shown in Scheme 1. Detailed analyses of the NMR spectra of compounds **5** and **6** are presented at the end of the paper. Results of the reaction of **2** with nitroarenes and KMnO_4 oxidant are given in Table 1

Table 1. Oxidation of σ^{H} adducts of **2**[−] to nitroarenes by KMnO_4 in $\text{NH}_3(\text{liq})$ and by $\text{Bu}_4\text{N}^+\text{MnO}_4^-$ in THF (Scheme 1)

X	ArNO ₂ No.	Products, No. yields							
		KMnO ₄ /NH ₃ liq ^a				Q ⁺ MnO ₄ [−] / THF ^b			
H	1a	4a	78						
2-F	1b	4b	77				3b	45	
3-F	1c	4c	39	5c	27	6c	5	3c	20
2-Cl	1d	4d	57					3d	30
3-Cl	1e	4e	29	5e	39	6e	15	3e	69
2-Br	1f	4f	60					3f	26
3-Br	1g	4g	27	5g	48	6g	17	3g	73
3-I	1h	4h	22	5h	37	6h	13		
3-MeO	1j	4j	29	5j	19	6j	23 ^c		
2-CN	1k	4k	47						
2-NT ^d	1l	4l	26						
1-NN ^e	1m	4m	40						

^a Ratio ArNO₂: **2** = 2.

^b Ratio ArNO₂: **2** = 1.2.

^c Tetramer **6j**[†] was also isolated.

^d 2-Nitrothiophene.

^e 1-Nitronaphthalene.

It should be stressed that compounds **5** and **6** were formed only when the reacting nitroarene contained a substituent X located *meta* to the nitro group. It appears that this substituent affects the reaction course due to its steric, not electronic, effects because products **5** and **6** were formed also in the reaction of **2** with nitrobenzene substituted in *meta* position not only with halogens but also with electrodonating group (X = OMe), *m*-nitroanisole **1j**. It appears that hydroxy esters **3** and dimeric and trimeric products **5** and **6** are formed as a result of oxidation of

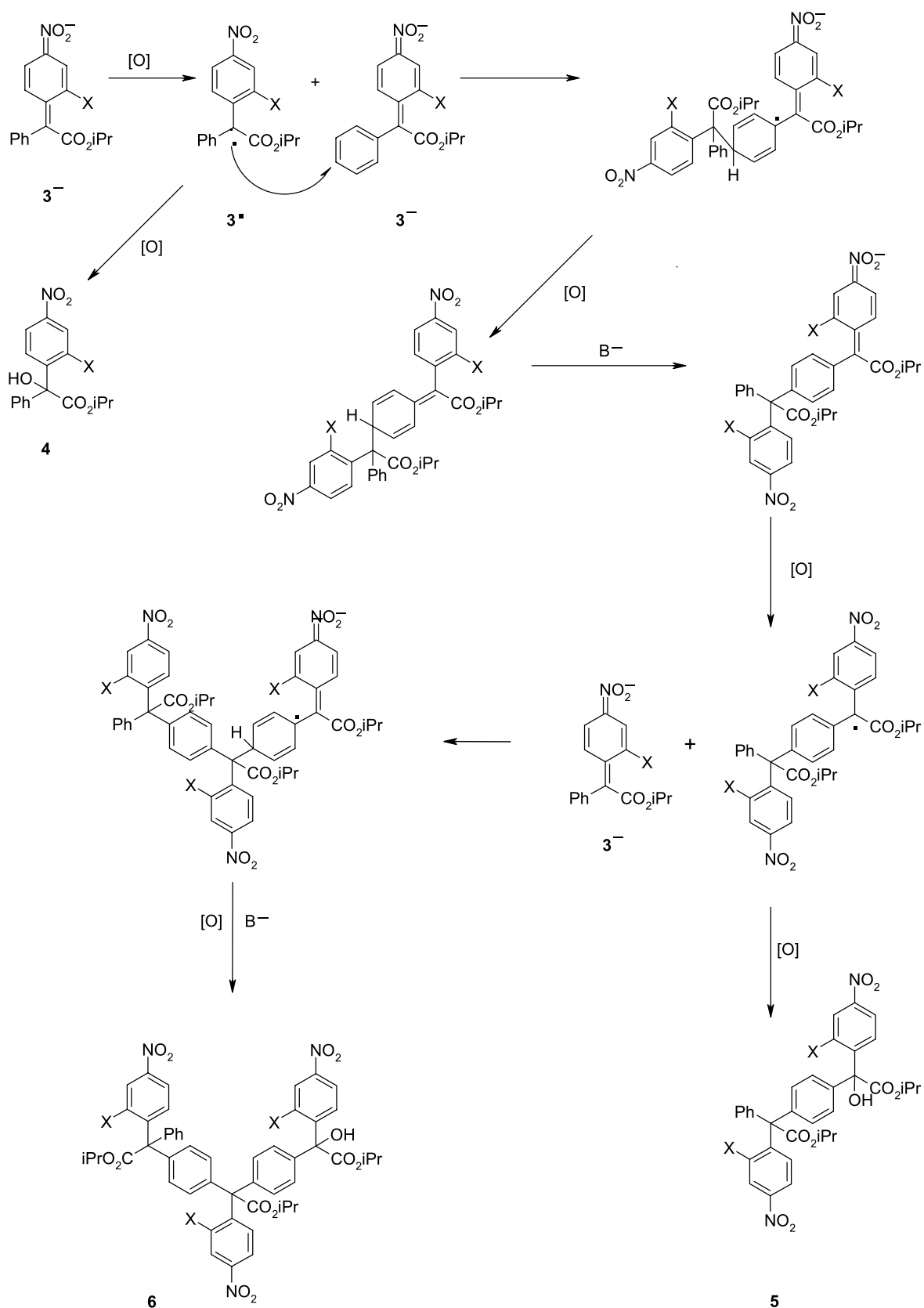

Scheme 2.

carbanions of initial ONSH products **3**. In the oxidation of the initial products of ONSH in nitroarenes containing substituents X in *meta* position formation of dimeric products **5** competes with the hydroxylation reaction. In

order to confirm that products **4**, **5** and **6** are indeed formed via oxidation of nitrobenzylic carbanions of the initial ONSH products, **3a** and **3e** were prepared independently via S_NAr of halogen in 4-fluoro and 3,4-dichloronitrobenzene

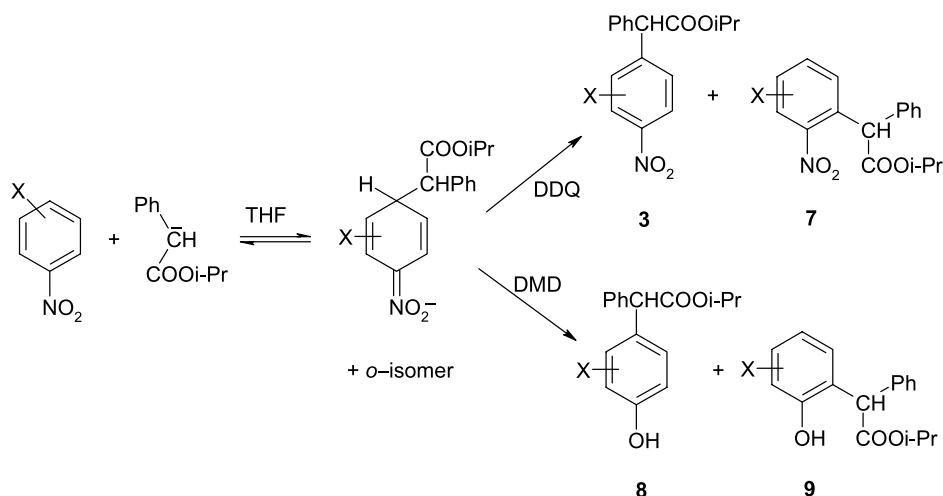

Scheme 3.

with carbanion of **2**. These nitroarylated esters **3a** and **3e** dissolved in liquid ammonia are deprotonated by the solvent to a low degree, addition of NaNH_2 to such solutions converts **3a** and **3e** into carbanions $\mathbf{3a}^-$ and $\mathbf{3e}^-$ that are stable and can be recovered upon acidification of the solution with NH_4Cl . Treatment of a solution of carbanion of **3a** in NH_3 liquid with KMnO_4 gave **4a** whereas carbanion of **3e** gave a mixture of **4e**, **5e** and **6e**, respectively. Composition of the latter mixture was similar to that obtained in the direct reaction of **2** with 3-chloronitrobenzene. These results confirm that of **4**, **5** and **6** are produced by further conversion of **3** as shown in Scheme 1.

It appears that compounds **5** and **6** are formed via coupling of carbanions $\mathbf{3}^-$ with free radicals of **3**, produced by oxidation of carbanions of **3** by KMnO_4 . A speculative pathway of formation of **4** and **5** is shown in Scheme 2. Perhaps substituents X hinder conjugation of the carbanionic and free radical centers in $\mathbf{3}^-$ and $\mathbf{3}\cdot$ with the nitroaryl rings, whereas steric hindrances prevent addition of $\mathbf{3}\cdot$ to the carbanion α - to the alkoxy carbonyl group. Thanks to the increased electron density on unsubstituted phenyl ring of $\mathbf{3}^-$ it adds electrophilic radical $\mathbf{3}\cdot$ giving anion-radical, that is subsequently oxidized, deprotonated and hydroxylated to **5**. On the other hand, direct oxidation of $\mathbf{3}\cdot$ with KMnO_4 gave **4**. Thus competition between formation of **4** and **5** seems to depend on relation of rates of direct oxidation $\mathbf{3}\cdot \rightarrow \mathbf{4}$ and addition of $\mathbf{3}\cdot$ to $\mathbf{3}^-$, that is affected by steric effects of substituents X. Similar carbanion coupling under oxidative condition has been previously observed.^{19,20}

In order to verify this hypothesis we have done additional experiments changing ratio and order of mixing of the reactants. However changes of the procedure, for example, slow addition of a solution of σ^{H} adducts to a solution of KMnO_4 did not change the outcome of the reaction. Attempts to arrest the reaction of $\mathbf{2}^-$ with ArNO_2 , carried out in NH_3 and KMnO_4 oxidant, on the stage of **3** by using small amounts of the base and oxidant gave negative results. In such experiments mixtures of starting materials and products **3**, **4** (and **5** and **6**) were produced.

Formation and oxidation of σ^{H} adducts with permanganate anions can be carried out not only in liquid NH_3 but also in moderately polar solvents, for example, THF, provided a soluble salt of this anion is used. Indeed, treatment of **2** with *t*-BuOK in THF produced carbanions that form σ^{H} adducts upon addition of ArNO_2 . Oxidation of such system with tetrabutylammonium permanganate, results in formation of ONSH products **3** in moderate to good yields. Interestingly no hydroxylated esters **4** were formed under these conditions and the reaction proceeded only *para* to the nitro group. Results of these reactions are presented in Table 1.

Another oxidant, widely used for oxidation of the anionic σ^{H} adducts, is DDQ. For obvious reasons it cannot be used in the reactions carried out in liquid ammonia. Oxidation of σ^{H} adducts of $\mathbf{2}^-$ to nitroarenes generated in THF with DDQ gave somewhat different results as compared with oxidation by Q^+MnO_4^- . As it was mentioned earlier, permanganate anions oxidize efficiently only σ^{H} adducts *para* to the nitro group so with KMnO_4 and Q^+MnO_4^- oxidants the reaction of **2** with nitroarenes **1** gave products **3**, **4** (and **5** and **6**), in which hydrogen located *para* to the nitro group was substituted by the carbanion moiety. Oxidation of σ^{H} adducts with DDQ is less sensitive to steric hindrances and the reaction of $\mathbf{2}^-$ with nitroarenes and DDQ oxidant always gives mixtures of *para* and *ortho* isomers of the ONSH products **3** and **7**, respectively (Scheme 3, Table 2).

Since oxidation of the σ^{H} adducts of $\mathbf{2}^-$ and nitroarenes by DDQ in THF is not accompanied with hydroxylation we have applied this system for the ONSH in nitrobenzene **1a** and 4-chloronitrobenzene **1o** with phenylacetonitrile carbanion. This reaction proceeded efficiently giving a mixture of 2-nitrophenyl and 4-nitrophenyl phenylacetonitrile **10a** and **11a** and 2-nitro-5-chlorophenyl acetonitrile **11o**, respectively. Further hydroxylation of the ONSH products was not observed (Scheme 4).

Although oxygen is a moderately active oxidant, it can oxidize σ^{H} adducts, particularly those produced by

Table 2. Oxidation of σ^H adducts of 2^- to nitroarenes by DDQ in THF (Scheme 3)

ArNO ₂		Products			
X	No.	No. yield			
H	1a	3a	16	7a	30 ^a
2-F	1b	3b	36	7b	17 ^b
3-F	1c	3c^c	54		
2-Cl	1d	3d	44	7d	23 ^a
3-Cl	1e	3e	59	7e	10 ^a
2-Br	1f	3f	32	7f	24 ^b
3-Br	1g	3g	56	7g	9 ^b
1-NN ^d	1m	3m	12	7m	75 ^a
3-CN	1n	3n	32	7n	53 ^a
4-Cl	1o			7o	78 ^a

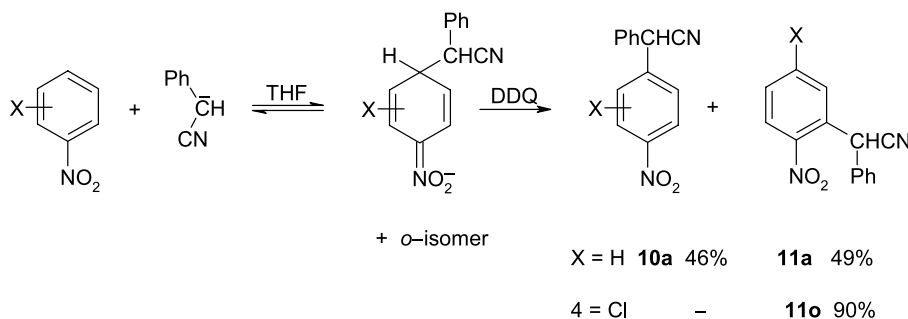
^a Ratio ArNO₂: **2** = 2.^b Ratio ArNO₂: **2** = 1.2.^c Small amount of a mixture containing isomeric products *ortho*-substitution was formed but not separated.^d 1-Nitronaphthalene.**Scheme 4.**

secondary carbanions that under the reaction conditions can be deprotonated to dianions. We have made a few experiments in order to oxidize σ^H adducts of 2^- to nitroarenes in liquid ammonia and in THF bubbling oxygen through the reaction mixtures. Indeed under these conditions the oxidation proceeded giving mixtures of ONSH products **3**, and hydroxylated products **4** but usually in low overall yields so this line of experiments was not pursued.

As it was mentioned earlier oxidation of the σ^H adducts of tertiary carbanions to nitroarenes with dimethyldioxirane, DMD, gave *p*-substituted phenols—the oxidation proceeded at the negatively charged nitro group.^{14,15}

In our experiments we have found that oxidation of σ^H adducts of secondary carbanions 2^- to nitroarenes with DMD proceeds also along this pathway to give mixtures of

Table 3. Oxidation of σ^H adducts of 2^- to nitroarenes by DMD in THF (Scheme 3)^a

ArNO ₂		Products			
X	No.	No. yield			
2-Cl	1d	8d	49	9d	17
3-Cl	1e	8e	65	9e	12
2-Br	1f	8f	42	9f	18
3-Br	1g	8g	76	9g	20
1-NN	1m	8m	19	9m	42
4-Cl	1o			9o	60

^a Ratio ArNO₂: **2** = 1.2.

o- and *p*-isomers of substituted phenols usually in good yields (Table 3).

2.1. Detailed analysis of the NMR spectra of compounds 5–6

The structures of compounds **3**, **4**, **7**, **8** and **9** (see Schemes 1 and 3) could be easily established on the basis of ¹H NMR spectra only, but a special effort has to be made in order to prove the structures of the products of higher molecular weight (**5** and **6**), which were obtained when KMnO₄ was used as the oxidizing agent (see Scheme 1). For all these compounds a meticulous analysis of the ¹H and ¹³C NMR data including *g*-HSQC and *g*-HMQC spectra has to be performed. A similar analysis has to be made also for compounds **4c**, **4e**, **4g**, **4h** and **4j** which served as the model compounds.

The ¹H and ¹³C NMR data obtained for compound **5g** has been collected in Table 4, for compounds **4c**, **4e**, **4g**, **4h** and **4j** in Tables 5 and 6, and for compounds **5** in Tables 7 and 8 (Tables 5–8 are available in Supplementary data). This form of the presentation of the vast NMR material revealed the trends occurring in the chemical shifts under the influence of substituents and provided us with an additional check of the correctness of the assignments made on the basis of the correlation spectra.

An analysis of the spectra has been performed in two steps. In the first step, the signals in the ¹H and ¹³C NMR spectra of the 3-substituted α -hydroxyesters, **4c**, **4e**, **4g**, **4h** and **4j**, were assigned on the basis of the general knowledge of substituent effects, and the preliminary assignments have been confirmed by means of the *g*-HSBC and *g*-HMBC spectra.

In the second step the ¹H and ¹³C NMR spectra of the products of the oxidation reaction denoted as **5** have been compared with the spectra of the corresponding compounds **4**. It becomes immediately clear that the spectra of these new compounds contain two fragments which are very similar, in some cases almost identical, to the spectra of compounds **4**. The differences observed can be easily interpreted in terms of the substitution effects. Furthermore, many of the signals are apparent doublets, the differences between them being in the range of several Hz at 11.7 T, which is typical of the pairs of diastereoisomers. A thorough

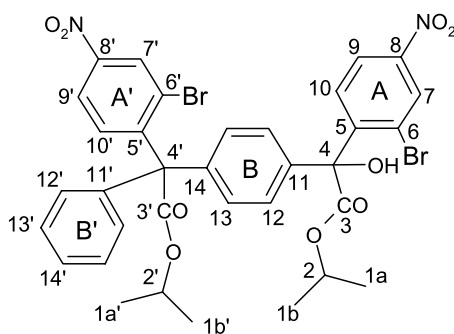
Table 4. ^1H (in parentheses) and ^{13}C NMR spectra of bromo dimer **5g** measured in CDCl_3 and acetone- d_6 and the relevant g -HMB correlation peaks; all data are in ppm against $\text{TMS}^{\text{a,b,c}}$ 

	In CDCl_3	In CD_3COCD_3	HMBC	C/HNo.	In CDCl_3	In CD_3COCD_3	HMBC
2	72.12; 72.11 (5.22) ^{dd}	71.58; 71.56 (5.17) ^c		2'	70.69 (5.22) ^d	71.13 (5.17) ^c	
3	172.31; 172.30	172.15; 172.10	2, OH, CH3	3'	170.45; 170.41	170.98	2', CH3
4	80.73; 80.70	81.83; 81.88	10,12	4'	67.10; 67.08	67.83	10',12',13
5	147.67	149.54; 149.51	7,9,OH	5'	150.69; 150.65	151.60	7',9', 10'
6	124.30	124.82	7,9,10	6'	126.84; 126.81	127.35	7',9',10'
7	129.32 (8.480)	129.70 (8.445)	9,10	7'	129.00; 128.98 (8.485)	129.45 (8.470; 8.466)	9'
8	147.57; 147.53	148.54	7,9,10	8'	147.00	148.01	7',9', 10'
9	121.63; 121.62 (8.015; 8.008)	122.59 (8.133; 8.128)	7,10	9'	121.71 (8.080; 8.076)	122.74 (8.189; 8.187)	7',10'
10	131.63; 131.60 (7.037; 7.009)	132.19; 132.16 (7.287; 7.264)		10'	132.01 (7.012; 7.009)	133.19 (7.121; 7.119)	
11	138.31; 138.28	140.30; 140.27	12,13,OH	11'	141.26; 141.22	141.76; 141.72	13'
12	126.72; 126.67 (7.602)	127.82; 127.78 (7.657)		12'	129.83 (7.23)	130.73 (7.314)	13'
13	130.42; 130.37 (7.41)	130.97; 130.93 (7.448)		13'	128.52; 128.50 (7.35) ^f	129.21; 129.20 (7.384) ^g	14'
14	140.54; 140.53	142.13; 142.09	12	14'	128.03; 128.00 (7.35) ^f	128.64; 128.63 (7.384) ^g	12',13'
OH	(4.370; 4.357)				(5.8)		

^a Signals of the protons 1 and 1' (centred at ca. 1.26 ppm) and carbons 1 and 1' (centred at ca. 21.5 ppm) are strongly overlapped.

^b J_{HH} coupling values are almost identical with those observed for the corresponding compounds **4** (see Table 5 in Supplementary data) and therefore are not shown in this Table.

^c g -HSQ correlation peaks are shown in Table 8 (see Supplementary data).

^{d-g} Signals overlapped.

analysis of the g -HSBC and g -HMBC spectra performed for compounds **5** indicated that, as a matter of fact, a dimeric structure should be assigned to them (see Scheme 1). As an example the spectra obtained for the bromo derivative **5g**, are discussed below more closely.

The measurements of the spectra for this compound have been performed in CDCl_3 and acetone- d_6 solutions and at two magnetic fields, 9.4 and 11.7 T. This allowed us to clarify the problems when an accidental overlap of the signals occurred and to discriminate between a genuine coupling and a splitting of the signals due to the presence of diastereoisomers.

Out of the two groups of signals corresponding to the quaternary aliphatic carbons, appearing at about 80 and at 67 ppm, those at the lower field should be assigned to carbon 4 and those at the higher field to carbon 4'. The correlation signals observed in the g -HMBC spectra recorded in acetone- d_6 between these two carbons and protons at 7.287; 7.264 and 7.121; 7.119 ppm allow one to assign the latter to H10 and H10', respectively. Subsequent assignment of all the remaining signals of rings A and A'

becomes easy. Further crucial information is provided by the correlations observed in the CDCl_3 solution between the proton of the OH group and the carbon signals at 172.31; 172.30, 147.67 and 138.31; 138.28 ppm which can be consequently assigned to carbons C3, C5 and C11, respectively. The correlations (in acetone- d_6) between carbon C4' and signals at 7.121; 7.119, 7.314 and 7.448 ppm indicate that the latter belong to H10', H12' and H13, respectively.

A similar analysis performed for the compounds with still higher molecular weights showed that the trimeric and tetrameric structures should be assigned to them (see Scheme 1). However, a precise assignment of the signals to particular hydrogen and carbon atoms in ^1H and ^{13}C NMR spectra, respectively, is rather difficult for obvious reasons. First of all, the number of diastereoisomers increases causing further splitting of the signals and secondly, a discriminating influence of the OH group on the shielding of the atoms in more remote rings is almost negligible. As a result, in many cases a strong overlap of the signals occurs. Therefore, the NMR data for compounds **6** have been included in

Section 3, where only tentative assignments have been proposed.

3. Conclusions

Secondary carbanions of isopropyl phenyl acetate **2** add to nitroarenes in positions of *ortho* and *para* to the nitro group. The produced anionic σ^H adducts can be oxidized by a variety of oxidants. Permanganate anions oxidize only σ^H adducts *para* to the nitro group, the final outcome depends on the conditions. In liquid ammonia the initially formed ONSH products **3** are oxidized further to esters of α -hydroxyacids **4** and, in some cases, undergo dimerization to **5** and trimerization to **6**. This unprecedented process is observed in the reaction of *m*-substituted nitroarenes and proceeds apparently via coupling of carbanions with free radicals, generated during oxidation of the carbanions. On the other hand, oxidation of the σ^H adducts with tetrabutylammonium permanganate carried out in THF gave ONSH products **3**, under these conditions only σ^H adducts in *para* positions are oxidized. DDQ oxidizes both *ortho* and *para* σ^H adducts thus in the reaction of **2**⁻ with nitroarenes and DDQ oxidant mixtures of isomeric ONSH products are formed. Oxidation of σ^H adducts of **2**⁻ to nitroarenes with DMD proceeds at the negatively charged nitrogroup of the *ortho* and *para* σ^H adducts that results in formation of isomeric substituted phenols.

4. Experimental

4.1. General

¹H and ¹³C NMR spectra were recorded with a Mercury-400BB (400 MHz) and Bruker DRX 500 instruments. Mass spectra were measured on AMD 604 Inectra GmBH spectrometer using EI or ESI. For analytical TLC Merck alufolien sheets Kieselgel 60 F₂₅₄ were used. For column chromatography silica gel 230–400 mesh Merck was used. DMF was distilled over calcium hydride and stored over molecular sieves, THF was distilled over potassium benzophenone ketyl. Acetone solution of DMD was prepared according to the literature procedure.²¹ All reactions were performed under argon atmosphere.

Nitroarenes, DDQ, phenylacetonitrile and potassium *tert*-butoxide were commercial products. Commercially available potassium permanganate was ground. Isopropyl phenylacetate was synthesized from phenylacetic acid and *iso*-propyl alcohol.¹³ Tetrabutylammonium permanganate was prepared as follows: To a stirred solution of tetrabutylammonium bromide (5.2 mmol) in water (15 ml) a solution of potassium permanganate 5 mmol in water (100 ml) was added. The precipitated product was filtered, washed with water (10 ml) and dried in vacuum until constant weight. The product can be stored in fridge for no longer than 1 month. Caution: dry tetrabutylammonium permanganate is explosive thus it must not be heated during drying. All usual precautions should be taken. For safety reason we dried the product in small, 3–4 mmol portions.

4.2. Procedures for the oxidative substitution of hydrogen with carbanion of **2**

Procedure A. Oxidation with KMnO₄ in liquid ammonia. To a suspension of sodium amide freshly prepared from sodium (120 mg, 5.2 mmol) in liquid ammonia (ca 25 ml), at –70 °C, *iso*-propyl phenylacetate **2** (360 mg, 2 mmol) in THF (1.5 ml) was added. After 3 min nitroarene **1** (4 or 2.4 mmol) in THF (1.5 ml) was added dropwise in 1 min. The reaction mixture was stirred for additional 3 min, and solid potassium permanganate (632 mg, 4 mmol) was added in one portion. The reaction mixture was stirred for 4 min and quenched with solid ammonium chloride (ca. 400 mg, 8 mmol). The cooling bath was removed and ammonia was evaporated. To the residue a saturated aqueous solution of oxalic acid was added and the mixture was extracted with ethyl acetate (3 × 20 ml). The combined organic layers were dried over MgSO₄. The solvent was evaporated and the products were purified by column chromatography with AcOEt/hexane as eluent.

Procedure B. Oxidation with DDQ. To a solution of *t*-BuOK (112 mg, 1 mmol) in THF (10 ml) at –70 °C, a solution of *iso*-propyl phenylacetate **2** (1 mmol) in THF (1.5 ml) was added. After 3 min nitroarene **1** (1.2 mmol) in THF (1.5 ml) was added dropwise during 1 min and the mixture was stirred for 3 min at –70 °C. Then solution of DDQ (273 mg, 1.2 mmol) in DMF (2 ml) was added and the reaction mixture was stirred for 5 min, quenched with saturated aqueous NH₄Cl (0.2 ml) and the cooling bath was removed. The reaction mixture was poured to water (100 ml) and extracted with ethyl acetate (3 × 20 ml) and extracts were washed with brine and dried over MgSO₄. The solvent was evaporated and products were purified by column chromatography in AcOEt/hexane. With some cases we were not able to separate the isomeric products **3** and **7** by column chromatography, so compositions of the mixtures were established by ¹H NMR spectroscopy.

Procedure C. Oxidation with Q⁺MnO₄⁻. Experiments were conducted according to procedure B. Instead of DDQ solid Q⁺MnO₄⁻ was added. After quench 10 ml of saturated aqueous solution of oxalic acid was added and procedure B was followed.

Procedure D. Oxidation with DMD. Experiments were conducted according to procedure B. Instead of DDQ water (0.02 ml, 1 mmol) and acetone solution of DMD (ca. 1.2 mmol, 20 ml of ca. 0.06 M) was added to the mixture. The color changed to bright yellow. After 5 min of stirring, saturated aqueous NH₄Cl (0.2 ml) was added the cooling bath was removed and procedure B was followed.

4.2.1. *iso*-Propyl α -(4-nitrophenyl)phenylacetate **3a.** Colourless oil. ¹H NMR (400 MHz, CDCl₃): δ = 1.22 (d, 3H, *J* = 6.2 Hz), 1.25 (d, 3H, *J* = 6.2 Hz), 5.06 (s, 1H), 5.06–5.14 (m, 1H), 7.27–7.38 (m, 5H), 7.47–7.51 (m, 2H), 8.15–8.19 (m, 2H). ¹³C NMR (CDCl₃): δ = 21.54, 21.63, 56.93, 69.27, 123.66, 127.74, 128.39, 128.89, 129.58, 137.42, 146.14, 147.03, 170.8. MS (EI): *m/z* (%) = 299 (M⁺, 6), 212 (100), 196 (28), 165 (66), 105 (29), 43 (79). Anal. Calcd for C₁₇H₁₇NO₄: C, 68.22; H, 5.72; N, 4.68. Found: C, 68.17; H, 5.74; N, 4.45.

4.2.1.1. iso-Propyl α -(2-nitrophenyl)phenylacetate 7a. Colourless oil. $^1\text{H NMR}$ (400 MHz, CDCl_3): δ =1.17 (d, 1.8H, J =6.2 Hz), 1.23 (d, 1.2H, J =6.2 Hz), 1.25 (d, 1.2H, J =6.2 Hz), 1.28 (d, 1.8H, J =6.2 Hz), 5.06 (s, 0.4H), 5.06–5.17 (m, 1H), 5.62 (s, 0.6), 7.08–7.16 (m, 0.6H), 7.15–7.33 (m, 3H), 7.33–7.45 (m, 3H), 7.46–7.51 (m, 1.5H), 8.02 (dd, 0.6H, J =1.51, 8 Hz), 8.17 (m, 0.6H). $^{13}\text{C NMR}$ (CDCl_3): δ =21.41, 21.55, 21.64, 21.68, 53.41, 56.94, 69.17, 69.28, 123.67, 124.81, 127.77, 128.07, 128.4, 128.9, 128.96, 129.16, 129.58, 131.6, 133.07, 134.14, 136.72, 137.42, 146.14, 148.87, 170.82.

4.2.2. iso-Propyl α -(3-fluoro-4-nitrophenyl)phenylacetate 3b. Colourless oil. $^1\text{H NMR}$ (400 MHz, CDCl_3): δ =1.22 (d, 3H, J =6.3 Hz), 1.26 (d, 3H, J =6.3 Hz), 5.0 (s, 1H), 5.03–5.13 (m, 1H), 7.22–7.26 (m, 1H), 7.28–7.31 (m, 4H), 7.32–7.39 (m, 3H), 7.99–8.06 (m, 1H). $^{13}\text{C NMR}$ (CDCl_3): δ =21.51, 21.64, 56.69, 69.54, 118.69 (d, J_{CF} =21.1 Hz), 124.78 (d, J_{CF} =5 Hz), 126.12 (d, J_{CF} =3 Hz), 128.02, 128.33, 129.07, 136.77, 147.83 (d, J_{CF} =9 Hz), 155.4 (d, J_{CF} =265 Hz), 170.3 MS (EI): m/z (%)=317 (M^+ , 1), 257 (27), 230 (100), 214 (43), 183 (66), 105 (31), 43 (98). Anal. Calcd for $\text{C}_{17}\text{H}_{16}\text{FNO}_4$: C, 64.35; H, 5.08; N, 4.41. Found: C, 64.4; H, 5.1, N, 4.38.

4.2.3. iso-Propyl α -(3-fluoro-2-nitrophenyl)phenylacetate 7b. Colourless oil. $^1\text{H NMR}$ (400 MHz, CDCl_3): δ =1.2 (d, 0.9H, J =6.2 Hz), 1.22 (d, 2.1H, J =6.3 Hz), 1.25–1.28 (d+d, 3H, J =6.3, 6.2 Hz), 5.0 (s, 0.7H), 5.03–5.13 (m, 1H), 5.17 (s, 0.3H), 7.06–7.12 (m, 0.3H), 7.12–7.21 (m, 0.3H), 7.21–7.31 (m, \sim 4H), 7.31–7.45 (m, \sim 4H), 7.97–8.06 (m, 0.7H). $^{13}\text{C NMR}$ (CDCl_3): δ =21.44, 21.52, 21.57, 21.64, 51.85, 51.86, 56.69, 69.55, 69.63, 115.91, 116.1, 118.58, 118.8, 124.75, 124.8, 126.1, 126.13, 127.97, 128.03, 128.34, 128.64, 128.99, 129.07, 129.16, 131.79, 131.87, 136.21, 136.77, 147.78, 147.86, 152.62, 154.11, 156.75, 169.96, 170.3.

4.2.4. iso-Propyl α -(2-fluoro-4-nitrophenyl)phenylacetate 3c. Colourless oil. $^1\text{H NMR}$ (400 MHz, CDCl_3): δ =1.21 (d, 3H, J =6.24 Hz), 1.26 (d, 3H, J =6.23 Hz), 5.11 (m, 1H), 5.28 (s, 1H), 7.28–7.44 (m, 6H), 7.91–7.99 (m, 2H). $^{13}\text{C NMR}$ (CDCl_3): δ =21.46, 21.59, 50.21, 69.5, 111.09 (d, J_{CF} =27 Hz), 119.2 (d, J_{CF} =4 Hz), 128.03, 128.63, 129.07, 130.8 (d, J_{CF} =4 Hz), 134.07 (d, J_{CF} =15 Hz), 135.79, 147.78 (d, J_{CF} =9 Hz), 159.83 (d, J_{CF} =251.5 Hz), 170.1. MS (EI): m/z (%)=317 (M^+ , 2), 230 (100), 214 (18), 183 (44), 105 (9), 43 (71). HRMS (ES) calcd for $\text{C}_{17}\text{H}_{16}\text{FNO}_4\text{Na}$: 340.0956. Found: 340.0976.

4.2.5. iso-Propyl α -(3-chloro-4-nitrophenyl)phenylacetate 3d. Colourless oil. $^1\text{H NMR}$ (400 MHz, CDCl_3): δ =1.22 (d, 3H, J =6.2 Hz), 1.27 (d, 3H, J =6.2 Hz), 4.99 (s, 1H), 5.04–5.14 (m, 1H), 7.26–7.4 (m, 6H), 7.51 (d, 1H, J =1.9 Hz), 7.84 (d, 1H, J =8.4 Hz). $^{13}\text{C NMR}$ (CDCl_3): δ =21.52, 21.65, 56.46, 69.52, 125.72, 127.27, 127.87, 127.97, 128.32, 129.05, 132.06, 136.89, 145.08, 146.63, 170.39. MS (EI): m/z (%)=333 (M^+ , 1), 273 (16), 246 (100), 230 (33), 165 (62), 105 (29), 43 (82). Anal. Calcd for $\text{C}_{17}\text{H}_{16}\text{ClNO}_4$: C, 61.18; H, 4.83; N, 4.2; Cl, 10.62. Found: C, 61.25; H, 4.86; N, 4.33; Cl, 10.52.

4.2.5.1. iso-Propyl α -(3-chloro-2-nitrophenyl)

phenylacetate 7d. Colourless oil. $^1\text{H NMR}$ (400 MHz, CDCl_3): δ =1.16–1.24 (m, 3H), 1.26 (d, 3H, J =6.3 Hz), 4.95 (s, 0.3H), 4.99 (s, 0.7H), 5.04–5.14 (m, 1H), 7.26–7.4 (m, 5H), 7.4–7.44 (m, 0.3H), 7.51 (d, 0.7H, J =1.9 Hz), 7.84 (d, 0.7H, J =8.4 Hz). $^{13}\text{C NMR}$ (CDCl_3): δ =21.47, 21.52, 21.65, 51.78, 56.46, 69.52, 69.7, 124.99, 125.72, 127.27, 127.87, 127.95, 127.98, 128.32, 128.35, 128.98, 129.05, 129.15, 129.43, 130.72, 132.06, 132.68, 136.27, 136.88, 169.8, 170.4.

4.2.6. iso-Propyl α -(2-chloro-4-nitrophenyl)phenylacetate 3e. Colourless oil. $^1\text{H NMR}$ (400 MHz, CDCl_3): δ =1.21 (d, 3H, J =6.4 Hz), 1.26 (d, 3H, J =6.2 Hz), 5.05–5.19 (m, 1H), 5.49 (s, 1H), 7.26–7.3 (m, 1H), 7.32–7.41 (m, 5H), 8.03 (ddd, 1H, J =0.4, 2.4, 8.6 Hz), 8.27 (d, 1H, J =2.4 Hz). $^{13}\text{C NMR}$ (CDCl_3): δ =21.45, 21.61, 54.21, 69.48, 121.67, 124.53, 128.01, 128.76, 129.07, 130.94, 135.11, 135.92, 144.08, 147.19, 170.12. MS (EI): m/z (%)=333 (M^+ , 1), 273 (9), 246 (100), 230 (22), 165 (59), 43 (74). Anal. Calcd for $\text{C}_{17}\text{H}_{16}\text{ClNO}_4$: C, 61.18; H, 4.83; N, 4.2; Cl, 10.62. Found: C, 61.07, H, 4.93, N, 4.11, Cl, 10.54.

4.2.6.1. iso-Propyl α -(4-chloro-2-nitrophenyl)phenylacetate 7e. Colourless oil. $^1\text{H NMR}$ (400 MHz, CDCl_3): δ =1.16 (d, 0.45H, J =6.3 Hz), 1.21 (d, 2.5H, J =6.2 Hz), 1.27 (d, 3H, J =6.3 Hz), 5.08–5.15 (m, 1H), 5.45 (s, 0.85H), 5.57 (s, 0.15H), 7.02–7.05 (d, 0.15H, J =8.5 Hz), 7.22–7.29 (m, 2H), 7.32–7.42 (m, 5H), 7.44 (dd, 0.15H, J =2.2, 8.5 Hz), 8.02–8.06 (m, 0.85H), 8.27 (d, 0.85H, J =2.3 Hz). $^{13}\text{C NMR}$ (CDCl_3): δ =21.46, 21.63, 21.63, 21.67, 53.06, 54.22, 69.04, 69.49, 121.68, 124.56, 128, 128.76, 129.09, 129.12, 130.95, 132.75, 132.9, 133.08, 133.92, 135.13, 135.94, 136.25, 144.09, 147.22, 170.14, 170.47.

4.2.7. iso-Propyl α -(3-bromo-4-nitrophenyl)phenylacetate 3f. Colourless oil. $^1\text{H NMR}$ (400 MHz, CDCl_3): δ =1.23 (d, 3H, J =6.3 Hz), 1.26 (d, 3H, J =6.3 Hz), 4.98 (s, 1H), 5.03–5.16 (m, 1H), 7.27–7.39 (m, 5H), 7.40–7.44 (m, 1H), 7.70 (d, 1H, J =1.8 Hz), 7.80 (d, 1H, J =8.5 Hz). $^{13}\text{C NMR}$ (CDCl_3): δ =21.52, 21.65, 56.36, 69.5, 114.63, 125.71, 127.95, 128.31, 128.53, 129.03, 135.02, 136.92, 144.98, 148.5, 170.4. MS (EI): m/z (%)=377 (M^+ , 1), 317 (16), 290 (100), 274 (21), 195 (27), 165 (56), 105 (17), 43 (43). Anal. Calcd for $\text{C}_{17}\text{H}_{16}\text{BrNO}_4$: C, 53.99; H, 4.26; N, 3.7. Found: C, 54.2; H, 4.25; N, 3.57.

4.2.7.1. iso-Propyl α -(3-bromo-2-nitrophenyl)phenylacetate 7f. Colourless oil. $^1\text{H NMR}$ (400 MHz, CDCl_3): δ =1.2–1.23 (m, 3H), 1.27 (m, 3H), 4.96 (s, 0.4H), 4.98 (s, 0.6H), 5.03–5.16 (m, 1H), 7.23–7.3 (m, 2H), 7.3–7.43 (m, 4H), 7.57 (dd, 0.4H, J =1.3, 8.1 Hz), 7.69–7.71 (m, 0.6H), 7.81 (d, 0.6H, J =8.3 Hz). $^{13}\text{C NMR}$ (CDCl_3): δ =21.47, 21.53, 21.65, 51.91, 56.37, 69.5, 69.68, 112.78, 114.63, 125.71, 127.93, 127.95, 128.31, 128.53, 128.97, 129.03, 129.81, 130.95, 132.56, 132.69, 135.2, 136.32, 136.92, 144.98, 148.5, 169.81, 170.4.

4.2.8. iso-Propyl α -(2-bromo-4-nitrophenyl)phenylacetate 3g. Colourless oil. $^1\text{H NMR}$ (400 MHz, CDCl_3): δ =1.23 (d, 3H, J =6.3 Hz), 1.27 (d, 3H, J =6.2 Hz), 5.06–5.18 (m, 1H), 5.46 (s, 1H), 7.26–7.34 (m, 3H), 7.34–7.42 (m, 3H), 8.08 (ddd, 1H, J =0.4, 2.4, 8.7 Hz), 8.46 (d, 1H, J =2.4 Hz). $^{13}\text{C NMR}$ (CDCl_3): δ =21.48, 21.66, 56.67,

69.52, 122.24, 125.17, 127.82, 128.02, 128.75, 129.09, 131.06, 136.2, 145.75, 147.13, 170.11. MS (EI): m/z (%) = 377 (M^+ , 1), 317 (8), 290 (95), 274 (19), 211 (20), 165 (100), 43 (91). Anal. Calcd for $C_{17}H_{16}BrNO_4$: C, 53.99; H, 4.26; N, 3.7. Found: C, 54.3; H, 4.47; N, 3.58.

4.2.8.1. iso-Propyl α -(4-bromo-2-nitrophenyl)phenylacetate 7g. Colourless oil. 1H NMR (400 MHz, $CDCl_3$): δ = 1.2–1.24 (d+d, 3H, J = 6.3, 6.3 Hz), 1.26–1.29 (d+d, 3H, J = 6.2, 6.2 Hz), 5.06–5.18 (m, 1H), 5.46 (s, 0.85H), 5.55 (s, 0.15H), 6.97 (d, 0.15H, J = 8.5 Hz), 7.22–7.3 (m, ~2H), 7.3–7.44 (m, ~4H), 7.59 (ddd, 0.15H, J = 0.4, 2.1, 8.5 Hz), 8.08 (ddd, 0.85H, J = 0.4, 2.5, 8.7 Hz), 2.16 (d, 0.15H, J = 2.1 Hz), 8.46 (d, 0.85H, J = 2.5 Hz).

4.2.9. iso-Propyl 1-(4-nitronaphthyl)phenylacetate 7m. Yellow crystals, mp 156–158 °C (hexane/ethyl acetate). 1H NMR (400 MHz, $CDCl_3$): δ = 1.24 (d, 3H, J = 6.4 Hz), 1.26 (d, 3H, J = 6.3 Hz), 5.05–5.19 (m, 1H), 5.21 (s, 1H), 1.29–1.38 (m, 5H), 7.5 (d, 1H, J = 8.8 Hz), 7.55–7.65 (m, 2H), 7.74–7.76 (m, 1H), 7.84–7.91 (m, 2H). ^{13}C NMR ($CDCl_3$): δ = 21.56, 21.58, 51.83, 69.47, 121.77, 124.21, 126.42, 127.51, 127.71, 127.95, 128.12, 128.42, 128.65, 128.89, 130.51, 132.84, 136.98, 147.63, 170.26. MS (EI) m/z = 303 (13), 262 (37), 261 (48), 218 (52), 105 (100), 77 (22), 43 (29). Anal. Calcd for $C_{21}H_{19}NO_4$: C, 72.19; H, 5.42; N, 4.01. Found: C, 71.47; H, 5.23; N, 3.72.

4.2.10. iso-Propyl α -(2-cyano-4-nitrophenyl)phenylacetate 3n. Colourless oil, 1H NMR (400 MHz, $CDCl_3$): δ = 1.16 (d, 3H, J = 6.2 Hz), 1.28 (d, 3H, J = 6.2 Hz), 5.05–5.15 (m, 1H), 5.62 (s, 1H), 7.04 (dd, 1H, J = 2.3 Hz), 7.23–7.27 (m, 1H), 7.35–7.44 (m, 5H), 8.01 (d, 1H, J = 8.8 Hz). ^{13}C NMR ($CDCl_3$): δ = 21.37, 21.68, 53.48, 69.46, 126.34, 128.17, 128.3, 129.18, 129.23, 131.76, 135.88, 136.32, 139.75, 147.07, 170.34. MS (ES, MeOH): m/z (%) = 347 (M^+ + Na), HRMS (ES) calcd for $C_{18}H_{16}N_2O_4Na$: 347.1002. Found: 347.1019.

4.2.11. iso-Propyl α -(4-cyano-2-nitrophenyl)phenylacetate 7n. Colourless oil, 1H NMR (400 MHz, $CDCl_3$): δ = 1.16 (d, 3H, J = 6.2 Hz), 1.28 (d, 3H, J = 6.2 Hz), 5.05–5.15 (m, 1H), 5.65 (s, 1H), 7.22–7.27 (m, 2H), 7.25 (d, 1H, J = 8.1 Hz), 7.38–7.45 (m, 3H), 7.74 (dd, 1H, J = 8.1, 1.6 Hz), 8.31 (d, 1H, J = 1.6 Hz). ^{13}C NMR ($CDCl_3$): δ = 21.6, 21.91, 53.88, 70.1, 112.81, 116.62, 128.56, 128.64, 129.33, 129.63, 133.26, 135.7, 136.02, 139.48, 149.22, 170.1. MS (ES, MeOH): m/z (%) = 347 (M^+ + Na), HRMS (ES) calcd for $C_{18}H_{16}N_2O_4Na$: 347.1002. Found: 347.1017.

4.2.12. iso-Propyl α -(5-chloro-2-nitrophenyl)phenylacetate 7o. White crystals, mp 133–134 °C (heptane). 1H NMR (400 MHz, $CDCl_3$): δ = 1.16 (d, 3H, J = 6.2 Hz), 1.28 (d, 3H, J = 6.2 Hz), 5.05–5.15 (m, 1H), 5.62 (s, 1H), 7.04 (dd, 1H, J = 2.3 Hz), 7.23–7.27 (m, 1H), 7.35–7.44 (m, 5H), 8.01 (d, 1H, J = 8.8 Hz). ^{13}C NMR ($CDCl_3$): δ = 21.37, 21.68, 53.48, 69.46, 126.34, 128.17, 128.3, 129.18, 129.23, 131.76, 135.88, 136.32, 139.75, 147.07, 170.34. MS (EI): m/z (%) = 315 (2), 273 (37), 246 (48), 229 (34), 194 (24), 165 (41), 105 (58), 77 (37), 43 (100). HRMS (EI) calcd for $C_{17}H_{16}N_2O_4Cl$: 333.07679. Found: 333.07717. Anal. Calcd for $C_{17}H_{16}ClNO_4$: C, 61.16; H, 4.83; N, 4.2; Cl, 10.62. Found: C, 61.2; H, 4.86; N, 4.03; Cl, 10.55.

4.2.13. α -(4-Nitrophenyl)phenylacetoneitrile 10a. Colourless oil. 1H NMR (400 MHz, $CDCl_3$): δ = 5.25 (s, 1H), 7.3–7.47 (m, 5H), 7.52–7.57 (m, 2H), 8.2–8.28 (m, 2H). ^{13}C NMR ($CDCl_3$): δ = 42.27, 118.46, 124.39, 126.61, 127.69, 128.7, 128.91, 129.58, 134.35, 142.7. MS (EI): m/z (%) = 238 (M^+ , 100), 221 (17), 192 (37), 165 (58). Anal. Calcd for $C_{14}H_{10}N_2O_4$: C, 70.58; H, 4.23; N, 11.76. Found: C, 70.72; H, 4.5; N, 11.53.

4.2.14. α -(2-Nitrophenyl)phenylacetoneitrile 11a. Colourless oil. 1H NMR (400 MHz, $CDCl_3$): δ = 6.17 (s, 1H), 7.3–7.4 (m, 5H), 7.53–7.58 (m, 1H), 7.68–7.75 (m, 2H), 8.07 (dd, 1H, J = 1.3, 8.2 Hz). ^{13}C NMR ($CDCl_3$): δ = 38.3, 118.61, 125.77, 127.87, 128.51, 129.31, 129.68, 130.53, 130.94, 134.07, 134.14, 147.66. MS (EI): m/z (%) = 238 (M^+ , 1), 221 (100), 204 (90), 190 (70), 167 (72), 77 (30). Anal. Calcd for $C_{14}H_{10}N_2O_4$: C, 70.58; H, 4.23; N, 11.76. Found: C, 70.6; H, 4.49; N, 11.74.

4.2.15. α -(5-Chloro-2-nitrophenyl)phenylacetoneitrile 11o. Colourless oil. 1H NMR (400 MHz, $CDCl_3$): δ = 6.19 (s, 1H), 7.29–7.35 (m, 2H), 7.35–7.44 (m, 3H), 7.52 (dd, 1H, J = 8.8, 2.4 Hz), 7.69 (d, 1H, J = 2.4 Hz), 8.04 (d, 1H, J = 8.8 Hz). ^{13}C NMR ($CDCl_3$): δ = 38.17, 118.08, 127.3, 127.87, 129.01, 129.5, 129.89, 130.93, 132.55, 133.33, 140.85, 145.8. MS (EI): m/z (%) = 271 (M^+ – 1, 1), 255 (71), 238 (94), 229 (36), 201 (39), 190 (100), 166 (88), 77 (57). Anal. Calcd for $C_{14}H_9ClN_2O_2$: C, 61.66; H, 3.33; N, 10.27; Cl, 13. Found: C, 61.59; H, 3.33; N, 10.06; Cl, 13.04.

4.2.16. iso-Propyl α -hydroxy- α -(4-nitrophenyl)phenylacetate 4a. Colourless oil. 1H NMR (400 MHz, $CDCl_3$): δ = 1.23 (d, 3H, J = 6.2 Hz), 1.3 (d, 3H, J = 6.4 Hz), 4.42 (s, 1H), 5.14–5.24 (m, 1H), 7.32–7.39 (m, 5H), 7.68 (m, 2H), 8.18 (m, 2H). ^{13}C NMR ($CDCl_3$): δ = 21.46, 21.51, 71.95, 80.37, 123.03, 126.96, 128.47, 128.51, 128.58, 131.74, 132.03, 141.41, 147.48, 148.77, 172.68. MS (EI): m/z (%) = 315 (M^+ , 1), 228 (100), 150 (67). Anal. Calcd for $C_{17}H_{17}NO_5$: C, 64.75; H, 5.43; N, 4.44. Found: C, 64.9; H, 5.25; N, 4.31.

4.2.17. iso-Propyl α -hydroxy- α -(3-fluoro-4-nitrophenyl)phenylacetate 4b. White crystals, mp 69–75 °C (hexane/AcOEt). 1H NMR (400 MHz, $CDCl_3$): δ = 1.25 (d, 3H, J = 6.2 Hz), 1.32 (d, 3H, J = 6.3 Hz), 4.42 (s, 1H), 5.11–5.29 (m, 1H), 7.35–7.38 (m, 5H), 7.44 (ddd, 1H, J = 8.7, 1.9, 0.96 Hz), 7.5 (dd, 1H, J = 12.2, 1.9 Hz), 8.02 (dd, 1H, J = 8.7, 7.6 Hz). ^{13}C NMR ($CDCl_3$): δ = 21.47, 21.52, 72.28, 79.99, 117.76 (d, J_{CF} = 22.1 Hz), 123.75 (d, J_{CF} = 3 Hz), 125.47 (d, J_{CF} = 2 Hz), 126.77, 128.62, 128.73, 126.51 (d, J_{CF} = 8 Hz), 141, 150.44 (d, J_{CF} = 4 Hz), 155.02 (d, J_{CF} = 264.5 Hz), 172.09. HRMS (ES) calcd for $C_{17}H_{15}FNO_5$: 332.0929. Found: 332.0910.

4.2.18. iso-Propyl α -hydroxy- α -(2-fluoro-4-nitrophenyl)phenylacetate 4c. White crystals, mp 73–76 °C (hexane/AcOEt). 1H NMR Table 4, ^{13}C NMR Table 5 MS (EI): m/z (%) = 333 (M^+ , 2), 246 (M^+ – 87, 100), 168 (63), 122 (18). Anal. Calcd for $C_{17}H_{16}FNO_5$: C, 61.26; H, 4.84; N, 4.2. Found: C, 61.09; H, 4.91; N, 4.21.

4.2.19. iso-Propyl α -hydroxy- α -(3-chloro-4-nitrophenyl)phenylacetate 4d. White crystals, mp 65–70 °C (hexane/

AcOEt). ^1H NMR (400 MHz, CDCl_3): δ = 1.25 (d, 3H, J = 6.2 Hz), 1.32 (d, 3H, J = 6.4 Hz), 4.43 (s, 1H), 5.2 (m, 1H), 7.3–7.4 (m, 5H), 7.53 (dd, 1H, J = 8.6, 2.0 Hz), 7.76 (d, 1H, J = 2.0 Hz), 7.83 (d, 1H, J = 8.6 Hz). ^{13}C NMR (CDCl_3): δ = 21.45, 21.48, 72.21, 79.89, 125.01, 126.69, 126.8, 126.97, 128.58, 128.66, 130.87, 141.04, 147.03, 147.64, 172.17. MS (EI): m/z (%) = 349 (M^+ , 1), 262 (100), 184 (28), 105 (13). Anal. Calcd for $\text{C}_{17}\text{H}_{16}\text{ClNO}_5$: C, 58.38; H, 4.61; N, 4.0; Cl, 10.14. Found: C, 58.38; H, 4.41; N, 3.97; Cl, 9.98.

4.2.20. *iso*-Propyl α -hydroxy- α -(2-chloro-4-nitrophenyl) phenylacetate 4e. White crystals, mp 65–75 °C (heptane). ^1H NMR Table 4, ^{13}C NMR, Table 5 MS (EI): m/z (%) = 349 (M^+ , 2), 262 (100), 184 (41). Anal. Calcd for $\text{C}_{17}\text{H}_{16}\text{ClNO}_5$: C, 58.38; H, 4.61; N, 4.0; Cl, 10.14. Found: C, 58.18; H, 4.81; N, 3.98; Cl, 9.94.

4.2.21. *iso*-Propyl α -hydroxy- α -(3-bromo-4-nitrophenyl) phenylacetate 4f. White crystals, mp 68–75 °C (heptane). ^1H NMR (400 MHz, CDCl_3): δ = 1.26 (d, 3H, J = 6.3 Hz), 1.32 (d, 3H, J = 6.3 Hz), 4.39 (s, 1H), 5.16–5.24 (m, 1H), 7.3–7.44 (m, 5H), 5.58 (dd, 1H, J = 8.6, 2 Hz), 7.8 (d, 1H, J = 8.6 Hz), 7.96 (d, 1H, J = 2 Hz). ^{13}C NMR (CDCl_3): δ = 21.49, 21.52, 72.24, 79.23, 114.09, 125.01, 126.85, 127.68, 128.6, 128.69, 134.03, 141.09, 147.5, 148.97, 172.24. MS (EI): m/z (%) = 393 (M^+ , 2), 306 (100), 228 (30), 105 (20), 77 (15), 43 (21). Anal. Calcd for $\text{C}_{17}\text{H}_{16}\text{BrNO}_5$: C, 51.79; H, 4.09; N, 3.55. Found: C, 51.52; H, 4.28; N, 3.49.

4.2.22. *iso*-Propyl α -hydroxy- α -(2-bromo-4-nitrophenyl) phenylacetate 4g. Colourless oil. ^1H NMR Table 4, ^{13}C NMR, Table 5 MS (EI): m/z (%) = 393 (M^+ , 1), 306 (M^+ – 87, 100), 262 (42), 228 (43), 184 (25), 105 (27), 77 (21), 43 (27). Anal. Calcd for $\text{C}_{17}\text{H}_{16}\text{BrNO}_5$: C, 51.79; H, 4.09; N, 3.55. Found: C, 51.65; H, 3.91; N, 3.6.

4.2.23. *iso*-Propyl α -hydroxy- α -(2-iodo-4-nitrophenyl) phenylacetate 4h. Colourless oil. ^1H NMR Table 4, ^{13}C NMR, Table 5 MS (EI): m/z (%) = 441 (M^+ , 2), 354 (100), 276 (39). HRMS (ES) calcd for $\text{C}_{17}\text{H}_{16}\text{INO}_5\text{Na}$: 463.9965. Found: 463.9986. Anal. Calcd for $\text{C}_{17}\text{H}_{16}\text{INO}_5$: C, 46.28; H, 3.66; N, 3.17. Found: C, 47.83; H, 3.95; N, 2.95.

4.2.24. *iso*-Propyl α -hydroxy- α -(2-methoxy-4-nitrophenyl) phenylacetate 4j. White crystals, mp 104–112 °C (heptane). ^1H NMR (400 MHz, CDCl_3): δ = 1.19–1.3 (m, 6H), 3.97 (s, 3H), 4.44 (s, 1H), 5.14 (m, 1H), 6.91 (d, 1H, J = 8.6 Hz), 7.37–7.47 (m, 3H), 7.68 (dd, 1H, J = 8.6, 2.2 Hz), 7.69–7.72 (m, 2H), 7.77 (d, 1H, J = 2.2 Hz). ^{13}C NMR (CDCl_3): δ = 21.39, 21.42, 55.92, 70.63, 77.92, 105.71, 115.36, 127.04, 128.2, 128.47, 130.04, 138.21, 138.64, 148.66, 157.59, 173.27. MS (EI): m/z (%) = 345 (M^+ , 1), 258 (100), 180 (62). Anal. Calcd for $\text{C}_{18}\text{H}_{19}\text{NO}_6$: C, 62.6; H, 5.55; N, 4.06. Found: C, 62.51; H, 5.68; N, 4.11.

4.2.25. *iso*-Propyl α -hydroxy- α -(3-cyano-4-nitrophenyl) phenylacetate 4k. Colourless oil, ^1H NMR (400 MHz, CDCl_3): δ = 1.25 (d, 3H, J = 6.2 Hz), 1.35 (d, 3H, J = 6.3 Hz), 4.41 (s, 1H), 5.16–5.24 (m, 1H), 7.3–7.37 (m, 2H), 7.37–7.42 (m, 3H), 7.97 (dd, 1H, J = 8.8, 2.1 Hz), 8.09 (dd, 1H, J = 2.1, 0.3 Hz), 8.27 (dd, 1H, J = 8.8, 0.4 Hz). ^{13}C NMR (CDCl_3): δ = 21.5, 21.54, 72.62, 79.88, 107.55,

114.96, 124.99, 126.55, 128.9, 129.06, 132.77, 134.73, 144.77, 147.64, 149.05, 171.5. MS (EI): m/z (%) = 340 (M^+ , 1), 253 (M^+ – 87, 100), 175 (47). Anal. Calcd for $\text{C}_{18}\text{H}_{16}\text{N}_2\text{O}_5$: C, 63.52; H, 4.74; N, 8.23. Found: C, 63.43; H, 4.96; N, 8.14.

4.2.26. *iso*-Propyl α -hydroxy- α -[2-(5-nitrothiophenyl) phenylacetate 4l. Colourless oil. ^1H NMR (400 MHz, CDCl_3): δ = 1.19 (d, 3H, J = 6.2 Hz), 1.28 (d, 3H, J = 6.2 Hz), 4.65 (s, 1H), 5.14 (m, 1H), 6.38 (d, 1H, J = 5.6 Hz), 7.3 (d, 1H, J = 5.6 Hz), 7.38–7.45 (m, 3H), 7.66–7.69 (m, 2H). ^{13}C NMR (CDCl_3): δ = 21.47, 21.52, 70.92, 126.09, 128.45, 128.77, 129.48, 131.32, 139.29, 145.56, 147.94, 171.11. MS (EI): m/z (%) = 321 (M^+ , 1), 234 (M^+ – 87, 100), 200 (25), 156 (95), 105 (20), 77 (17), 43 (22). Anal. Calcd for $\text{C}_{15}\text{H}_{15}\text{NO}_5\text{S}$: C, 56.07; H, 4.7; N, 4.36. Found: C, 55.84; H, 4.81; N, 4.23.

4.2.27. *iso*-Propyl α -hydroxy- α -[2-(1-nitronaphthyl)]-phenylacetate 4m. Colourless oil. ^1H NMR (400 MHz, CDCl_3): δ = 1.23 (d, 3H, J = 6.4 Hz), 1.36 (d, 3H, J = 6.2 Hz), 4.21 (s, 1H), 5.27 (m, 1H), 7.03 (d, 1H, J = 8.8 Hz), 7.4–7.46 (m, 3H), 7.51–7.55 (m, 2H), 7.56–7.66 (m, 2H), 7.78 (m, 2H), 7.86 (m, 1H). ^{13}C NMR (CDCl_3): δ = 21.41, 21.59, 71.78, 80.62, 122.06, 124.7, 126.85, 127.05, 127.71, 127.75, 128.59, 128.66, 128.74, 129.34, 130.81, 133.34, 141.23, 146.16, 171.82. MS (EI): m/z (%) = 365 (M^+ , 2), 278 (M^+ – 87, 100), 200 (32), 105 (11). Anal. Calcd for $\text{C}_{21}\text{H}_{19}\text{NO}_5$: C, 69.03; H, 5.24; N, 3.83. Found: C, 69.18; H, 5.44; N, 3.63.

4.2.28. *iso*-Propyl 2-(2-fluoro-4-nitrophenyl)-2{4-[1-(2-fluoro-4-nitrophenyl)-1-hydroxy-2-*iso*-propoxy-2-oxoethyl]-phenyl}-2-phenylacetate 5c. ^1H NMR Table 6, ^{13}C NMR, Table 7. MS (EI): m/z (%) = 561 (M^+ – 87, 100), 474 (M^+ – 2 × 87, 32), 306 (10), 43 (67). Anal. Calcd for $\text{C}_{34}\text{H}_{30}\text{F}_2\text{N}_2\text{O}_9$: C, 62.96; H, 4.66; N, 4.32. Found: C, 63.38; H, 4.68; N, 3.95.

4.2.29. *iso*-Propyl 2-(2-chloro-4-nitrophenyl)-2{4-[1-(2-chloro-4-nitrophenyl)-2-hydroxy-2-*iso*-propoxy-2-oxoethyl]-phenyl}-2-phenylacetate 5e. ^1H NMR Table 6, ^{13}C NMR, Table 7 MS (LSIMS+): m/z = 703 (M^+ + 23). MS (EI): m/z (%) = 593 (M^+ – 87, 100), 506 (40), 43 (35). HRMS (EI) calcd for (M -87 (COO*i*Pr)) $\text{C}_{30}\text{H}_{23}\text{Cl}_2\text{N}_2\text{O}_7$: 593.08823. Found: 593.08804. Anal. Calcd for $\text{C}_{34}\text{H}_{30}\text{Cl}_2\text{N}_2\text{O}_9$: C, 59.92; H, 4.44; N, 4.11; Cl, 10.4. Found: C, 59.67; H, 4.59; N, 4.27; Cl, 9.51.

4.2.30. *iso*-Propyl 2-(2-bromo-4-nitrophenyl)-2{4-[1-(2-bromo-4-nitrophenyl)-1-hydroxy-2-*iso*-propoxy-2-oxoethyl]phenyl}-2-phenylacetate 5g. White crystals. ^1H NMR Table 6, ^{13}C NMR, Table 7. MS (ES) (CHCl_3): m/z = 793. MS (EI): m/z (%) = 683 (M^+ – 87, 100), 639 (32), 596 (40), 552 (15), 43(85). HRMS (ES) calcd for $\text{C}_{34}\text{H}_{30}\text{Br}_2\text{N}_2\text{O}_9\text{Na}$: 791.0210. Found: 791.0239. Anal. Calcd for $\text{C}_{34}\text{H}_{30}\text{Br}_2\text{N}_2\text{O}_9$: C, 53.01; H, 3.92; N, 3.64. Found: C, 54.05; H, 4.45; N, 3.48.

4.2.31. *iso*-Propyl 2-(2-iodo-4-nitrophenyl)-2{4-[1-(2-iodo-4-nitrophenyl)-1-hydroxy-2-*iso*-propoxy-2-oxoethyl]-phenyl}-2-phenylacetate 5h. White powder. ^1H NMR

Table 6, ^{13}C NMR, Table 7. MS (ES): m/z (%) = 887 ($\text{M}^+ + 23$).

4.2.32. iso-Propyl 2-(2-methoxy-4-nitrophenyl)-2{4-[1-(2-methoxy-4-nitrophenyl)-1-hydroxy-2-iso-propoxy-2-oxoethyl]phenyl}-2-phenylacetate 5j. Colourless oil. ^1H NMR Table 6, ^{13}C NMR, Table 7. MS (LSIMS+): m/z (%) = 695 ($\text{M}^+ + 23$), 655, 585 ($\text{M}^+ - 87$). HRMS (ES) calcd for $\text{C}_{36}\text{H}_{36}\text{N}_2\text{O}_{11}\text{Na}$: 695.2211. Found: 695.2231. Anal. Calcd for $\text{C}_{36}\text{H}_{36}\text{N}_2\text{O}_{11}$: C, 64.28; H, 5.39; N, 4.16. Found: C, 63.98; H, 5.55; N, 3.98.

4.2.33. Fluoro trimer 6c. Colourless oil. ^1H NMR (400 MHz, CDCl_3): δ = 1.2–1.29 (m, 18H), 4.39 (s, 1H), 5.15–5.25 (m, 3H), 6.97–7.06 (m, 2H), 7.1–7.17 (m, 1H), 7.17–7.28 (m), 7.30–7.38 (m, 5H), 7.55–7.59 (m, 2H), 7.88–8.0 (m, 6H). ^{13}C NMR (CDCl_3): δ = 21.21, 21.3, 2121.16, 21.36, 21.42, 63.3, 63.54, 70.31, 70.44, 72.14, 111.12 (d, J = 29.2 Hz), 111.29 (d, J = 28 Hz), 111.65 (d, J = 27.53 Hz), 118.78 (d, J = 3.4 Hz), 118.85 (d, J = 3 Hz), 118.94 (d, J = 3 Hz), 126.68, 126.72, 127.96, 128.4, 129.36, 129.55, 129.77, 130.57, 130.7, 130.73, 130.84, 137.03–137.12 (m), 137.9–137.93 (m), 138.9 (d, J = 12.8 Hz), 139.12–139.25 (m), 139.76–139.84 (m), 140.4–140.47 (m), 148.03–148.18 (m), 148.73 (d, J = 9.2 Hz), 159.3, 159.35, 159.37, 161.34, 169.37, 161.39, 170.11, 170.28, 172.3. ^{19}F NMR (CDCl_3): δ = -107.6–(-107.8) (m, 1F), -101.2–(-101) (m, 1F), -100.95–(-101) (m, 1F). MS (EI) m/z (%) = 876 ($\text{M}^+ - 87$, 24), 789 (5), 149 (68), 43 (100).

4.2.34. Chloro trimer 6e. Colourless oil. ^1H NMR (400 MHz, CDCl_3): δ = 1.2–1.3 (m, 18H), 4.41 (s, 1H), 5.15–5.3 (m, 3H), 6.98–7.06 (m, 3H), 7.15–7.45 (m), 7.58–7.65 (m, 1H), 7.93–8.08 (m, 3H), 8.25–8.29 (m, 3H). ^{13}C NMR (400 MHz, CDCl_3): δ = 21.03, 21.3, 21.36, 21.4, 21.47, 65.32, 65.57, 70.49, 70.63, 72.08, 72.11, 79.55, 79.75, 121.17, 121.24, 121.36, 125.39, 125.41, 125.51, 125.77, 126.73, 126.79, 127.95, 128.43, 129.49, 129.72, 129.99, 130.02, 130.08, 130.14, 131.38, 131.59, 131.73, 135.44, 136.65, 138.18, 139.5, 139.58, 140.02, 140.05, 140.09, 140.18, 140.22, 140.69, 140.75, 146.09, 146.13, 147.19, 147.26, 147.86, 148.78, 148.8, 148.84, 149.05, 149.09, 170.24, 170.37, 170.4, 172.36. MS (ES): m/z (%) = 1034 ($\text{M} + \text{Na}$) $^+$.

General remarks concerning spectra of compounds **6g**, **6h**, **6j** and **6j'**: (a) denotes approximate average for a group of slightly non-equivalent protons or carbons; (b) denotes that no efforts were made to assign chemical shifts to individual ^1H or ^{13}C nuclei within this group; H' (C'), H'' (C'') and H''' (C''') denotes that the particular protons (or carbons) belong to subsequent aromatic rings A' (B'), A'' (B'') or A''' (B'''), for atom numbering see Tables 6 or 7. For additional comments see also the main body of the text.

4.2.35. Bromo trimer 6g. Yellowish, amorphous powder (^1H and ^{13}C NMR spectra measured in acetone- d_6).

$\text{C}(\text{CH}_3)_2$ (1.25, 18 H) a , OH (5.700, 1H), H2, H2', H2'' (5.12, 3H) a , H10', H10'' (7.152d; 7.150d; 7.143d; 7.140d, 1H, 7.095, 1H) b , H10 (ca. 7.28, a signal hidden under aromatic signals), Ar (7.30, 7.37, 9H) a , H13 (7.444, 2H), H12 (7.668, 2H), H9 (8.109dd, 1H), H9', H9'' (8.179, 2H) a , H7', H7''

(8.442, 2H) a,b , H7 (8.463d, 1H) C1, C1', C1'' (21.54), C2(71.59; 71.56), C3(172.11; 172.06), C4 (81.93), C5(149.52), C6(124.82), C7(129.70), C8(148.54), C9(122.60), C10 (132.18; 132.16), C11 (140.47), C12 (128.01; 127.98), C13(130.84), C14(141.92), C2', C2''(71.27, 71.13) b , C3', C3''(170.99; 170.97, 170.90) b , C4', C4''(67.72; 67.70, 67.53; 67.51) b , C5', C5''(151.61, 151.40) b , C6', C6''(127.33), C7', C7'' (129.45, 129.53) b , C8', C8''(148.00, 148.05), C9', C9''(122.74, 122.80), C10', C10''(133.16, 131.10), C11', C11''(141.24, 141.65) b , C12', C12''(130.53, 130.82) b , C13', C13''(130.71, 129.22) b , C14', (140.96; 140.91) b , C14'' (128.64). MS (ES, negative ions): m/z = 1170. Anal. Calcd for $\text{C}_{51}\text{H}_{44}\text{N}_3\text{Br}_3\text{O}_{13}$: C, 53.42, H, 3.87; N, 3.66; Br, 20.64. Found: C, 53.2, H, 4.09; N, 3.86; Br, 20.51.

4.2.36. Iodo trimer 6h. Yellowish, amorphous powder (^1H and ^{13}C NMR measured in CDCl_3).

$\text{C}(\text{CH}_3)_2$ (1.32, 18 H) a , OH (4.336; 4.326; 4.324; 4.322; 1H), H2, H2', H2'' (5.12, 3H) a,b , H10, H10', H10''(6.96, 3H) a,b , Ar (7.25, 7.37, 11 H) a , H12 (7.585 2H), H9 (8.055dd, 1H), H9', H9'' (8.155, 2H) a,b , H7 (8.808d, 1H), H7', H7'' (8.782, 2H) a,b C1, C1' (21.5) a,b , C2(72.26), C3(172.07), C4 (81.94; 81.91), C5(149.79), C6(96.51), C7(136.56), C8(147.12), C9(122.33), C10(131.70), C11(139.05; 139.03), C12(127.04; 126.98), C13(130.52; 130.48), C14(141.06), C2', C2''(70.89; 70.86, 71.03; 70.99) b , C3', C3''(170.52, 170.48) b , C4', C4''(68.92, 68.70) b , C5', C5''(153.58; 153.55, 153.31; 153.24; 153.19) b , C6', C6''(101.86, 101.80) b , C7', C7'' (136.18, 136.04) b , C8', C8''(146.36, 146.28) b , C9', C9''(122.25, 122.20) b , C10', C10''(131.58, 131.02) b , C11', C11''(139.78, 141.06) b , C12', C12''(129.93, 130.48) b , C13', C13''(129.89, 128.55) b , C14', (140.67; 140.63), C14''(128.01). MS (ES) m/z = 1310.1 ($\text{C}_{51}\text{H}_{44}\text{N}_3\text{I}_3\text{O}_{13}\text{Na}$).

4.2.37. Methoxy trimer 6j. Yellowish, amorphous powder (^1H and ^{13}C NMR measured in CDCl_3) $\text{C}(\text{CH}_3)_2$ (1.19, 18H) a,b , $\text{OCH}_3' - \text{OCH}_3''$ (3.74, 6H) a,b , OCH_3 , (3.96, 3H), OH (4.41, 1H), H2, H2', H2'' (5.12, 3H) a , H10, H10', H10'' (6.90, 3H) a , Ar (7.25, 11 H) a , H12 (7.58, 2H), H7, H7', H7'', H9, H9', H9'' (7.72, 6H) a,b C1, C1', C1'' (21.39), C2(70.71; 70.67), C3(173.13), C4 (77.88), C5(138.40; 138.31), C6(157.62), C7(105.74), C8(148.71), C9(115.51), C10(129.90), C11(137.16), C12(126.49; 126.42), C13(129.90), C14(141.14), OCH_3 (55.93) C2', C2''(69.30, 69.21) b , C3', C3''(171.15, 171.05) b , C4', C4''(63.41, 63.18) b , C5', C5'' (140.28, 140.33) b , C6', C6'' (157.57, 157.51) b , C7', C7'' (105.42, 105.35) b , C8', C8''(148.16, 148.09) b , C9', C9'' (115.44, 115.43) b , C10', C10'' (129.90) b , C11', C11''(139.83), C12'(129.61), C12''(129.35), C13' (129.53), C13'' (127.79), C14' (140.78), C14'' (127.24). MS (LSIMS+) m/z (%) = 1022($\text{M}^+ + 23$), 982, 912 ($\text{M}^+ - 87$). Anal. Calcd for $\text{C}_{54}\text{H}_{53}\text{N}_3\text{O}_{16}$: C, 64.68; H, 5.34; N, 4.2. Found C, 64.93; H, 5.52; N, 3.75.

4.2.38. Methoxy tetramer 6j'. Yellowish, amorphous powder (^1H and ^{13}C NMR measured in CDCl_3) $\text{C}(\text{CH}_3)_2$ (1.19, 24 H) a,b , $\text{OCH}_3' - \text{OCH}_3'''$ (3.74, 9H) a , OCH_3 , (3.95, 3H), OH (4.396; 4.390; 4.378; 4.376, 1H), H2, H2', H2'', H2''' (5.12, 4H) a , H10-10''' (6.90, 4H) a , Ar (7.17, 10 H) a , Ar

(7.28 5H)^a, H12 (7.58, 2H), H7-7^{'''} and H9-9^{'''} (7.72, 8H)^a C1, C1', C1'', C1^{'''} (21.39)^{a,b}, C2(70.70; 70.66), C3(173.10), C4 (77.94), C5(138.49; 138.40), C6 (157.68), C7 (105.83; 105.81), C8(148.77), C9(115.51), C10(130 vs, broad), C11(137.28), C12 (126.54; 126.46), C13(129.5), C14(141.22; 141.17; 141.12), OCH₃ (55.96) C2', C2'', C2^{'''} (69.31, 69.24; 69.20)^b, C3', C3'', C3^{'''} (171.14, 171.11, 171.03 broad)^b, C4', C4'', C4^{'''} (63.46, 63.24; 63.23, 63.11)^b, C5', C5'', C5^{'''} (a group of the signals at 140.3)^b, C6', C6'', C6^{'''} (157.63, 157.59, 157.57)^b, C7', C7'', C7^{'''} (105.52; 105.49, 105.43; 105.40)^b, C8', C8'', C8^{'''} (148.23, 148.17, 148.16)^b, C9', C9'', C9^{'''} (115.45 vs, broad signal), C10', C10'', C10^{'''} (130, vs, broad), C11', C11'', C11^{'''} (a group of the signals at about 140)^b, C12', C12'', C12^{'''}, C13', C13'' (129.55, 129.38; 129.34, vs, broad signals)^b, C13^{'''} (127.80), C14', C14'' (140.86, 140.41)^b, C14^{'''} (127.26). MS (ES) *m/z* = 1349.4 (C₇₂H₇₀N₄O₂₁Na).

4.2.39. iso-Propyl α -(3-chloro-2-hydroxyphenyl)phenylacetate 8d. Colourless oil. ¹H NMR (500 MHz, CDCl₃): δ = 1.21 (d, 3H, *J* = 6.3 Hz), 1.23 (d, 3H, *J* = 6.3 Hz), 4.87 (s, 1H), 5.07 (m, 1H), 5.66 (s, 1H), 6.94 (d, 1H, *J* = 8.4 Hz), 7.11 (dd, 1H, *J* = 8.4, 2.2 Hz), 7.25–7.35 (m, 6H). ¹³C NMR (CDCl₃): δ = 21.59, 21.64, 56.11, 68.82, 116.16, 119.86, 127.3, 128.35, 128.64, 128.69, 129.08, 132.07, 138.48, 150.51, 171.78. MS (EI): *m/z* (%) = 304 (M⁺, 13), 217 (100), 182 (20), 136 (20), 107 (22). HRMS (EI) calcd for C₁₇H₁₇³⁵ClO₃: 304.08662. Found: 304.08594.

4.2.40. iso-Propyl α -(3-chloro-4-hydroxyphenyl)phenylacetate 9d. Colourless oil. ¹H NMR (400 MHz, CDCl₃): δ = 1.22 (d, 3H, *J* = 6.3 Hz), 1.25 (d, 3H, *J* = 6.2 Hz), 5.1 (m, 1H), 5.24 (s, 1H), 6.37 (s, 1H), 6.78–6.83 (m, 1H), 6.99–7.03 (m, 1H), 7.25 (dd, 1H, *J* = 8.3, 1.7 Hz), 7.27–7.35 (m, 5H). ¹³C NMR (CDCl₃): δ = 21.58, 21.64, 52.2, 69, 120.48, 120.76, 126.91, 127.36, 128.11, 128.53, 128.61, 137.16, 149.4, 172.37. MS (EI): *m/z* (%) = 304 (M⁺, 18), 244 (29), 217 (100), 182 (32). Anal. Calcd for C₁₇H₁₇ClO₃: C, 67; H, 5.62; Cl, 11.63. Found: C, 66.86; H, 5.79; Cl, 11.33.

4.2.41. iso-Propyl α -(2-chloro-4-hydroxyphenyl)phenylacetate 8e. White crystals, mp 133–134 °C (heptane). ¹H NMR (500 MHz, CDCl₃): δ = 1.2 (d, 3H, *J* = 6.3 Hz), 1.27 (d, 3H, *J* = 6.3 Hz), 5.12 (sep, 1H, *J* = 6.3 Hz), 5.31 (s, 1H), 6.18 (s, 1H), 6.82 (d, 1H, *J* = 8.6 Hz), 6.48 (dd, 1H, *J* = 8.6, 2.6 Hz), 6.82 (d, 1H, *J* = 2.6 Hz), 7.20–7.36 (m, 5H). ¹³C NMR (CDCl₃): δ = 21.48, 21.64, 53.74, 69.34, 114.29, 116.59, 127.42, 128.33, 128.76, 128.84, 130.74, 134.37, 137.2, 155.7, 172.99. MS (EI): *m/z* (%) = 304 (M⁺, 14), 244 (25), 217 (100), 182 (19). Anal. Calcd for C₁₇H₁₇ClO₃: C, 67; H, 5.62; Cl, 11.63. Found: C, 66.96; H, 5.7; Cl, 11.66.

4.2.42. iso-Propyl α -(4-chloro-2-hydroxyphenyl)phenylacetate 9e. Colourless oil. ¹H NMR (400 MHz, CDCl₃): δ = 1.29 (d, 3H, *J* = 6.2 Hz), 1.31 (d, 3H, *J* = 6.2 Hz), 5 (s, 1H), 5.14 (sep, 1H, *J* = 6.2 Hz), 6.86 (dd, 1H, *J* = 8.2, 2.2 Hz), 6.93 (d, 1H, *J* = 2.2 Hz), 7.03 (d, 1H, *J* = 8.2 Hz), 7.16–7.22 (m, 2H), 7.25–7.35 (m, 3H), 8.17 (s, 1H). ¹³C NMR (CDCl₃): δ = 21.59, 21.63, 55.1, 70.42, 118.5, 120.74, 122.41, 127.51, 127.56, 128.76, 132.16, 134.65, 136.46, 155.94, 174.85. MS (EI): *m/z* (%) = 304 (M⁺, 18), 244 (32), 217 (100), 182 (22). HRMS (EI) calcd for C₁₇H₁₇³⁵ClO₃:

304.08662. Found: 304.08801. Anal. Calcd for C₁₇H₁₇ClO₃: C, 67; H, 5.62; Cl, 11.63. Found: C, 66.77; H, 5.91; Cl, 11.14.

4.2.43. iso-Propyl α -(3-bromo-2-hydroxyphenyl)phenylacetate 8f. Colourless oil. ¹H NMR (400 MHz, CDCl₃): δ = 1.2–1.25 (m, 6H), 4.87 (s, 1H), 5.01–5.13 (m, 1H), 6.94 (d, 1H, *J* = 8.4 Hz), 7.16 (dd, 1H, *J* = 8.4, 2.2 Hz), 7.26–7.36 (m, 5H), 7.42 (d, 1H, *J* = 2.2 Hz). ¹³C NMR (CDCl₃): δ = 21.6, 21.65, 56.01, 68.82, 110.16, 115.98, 126.4, 127.3, 128.33, 128.65, 129.45, 132, 132.48, 138.5, 151.44, 171.76. MS (EI): *m/z* (%) = 348 (M⁺, 13), 263 (100), 261 (99), 182 (34), 152 (14), 43 (17). HRMS (EI) calcd for C₁₇H₁₇⁷⁹NO₃: 348.03611. Found: 348.03671.

4.2.44. iso-Propyl α -(3-bromo-4-hydroxyphenyl)phenylacetate 9f. Colourless oil. ¹H NMR (400 MHz, CDCl₃): δ = 1.22 (d, 3H, *J* = 6.2 Hz), 1.25 (d, 3H, *J* = 6.3 Hz), 5.04–5.16 (m, 1H), 5.24 (s, 1H), 6.39 (s, 1H), 6.75 (m, 1H), 7.04 (dd, 1H, *J* = 7.8, 1.3 Hz), 7.26–7.36 (m, 5H), 7.39 (dd, 1H, *J* = 8, 1.3 Hz). ¹³C NMR (CDCl₃): δ = 21.58, 21.64, 52.5, 69.02, 110.91, 121.35, 126.84, 127.36, 128.32, 128.59, 128.63, 129.33, 131.17, 137.15, 150.24, 172.42. MS (EI): *m/z* (%) = 348 (M⁺, 16), 288 (36), 261 (100), 182 (47), 152 (21), 43 (28). HRMS (EI) calcd for C₁₇H₁₇⁷⁹BrO₃: 348.03611. Found: 348.03571.

4.2.45. iso-Propyl α -(2-bromo-4-hydroxyphenyl)phenylacetate 8g. White crystals, mp 127–128 °C (heptane). ¹H NMR (400 MHz, CDCl₃): δ = 1.2 (d, 3H, *J* = 6.4 Hz), 1.28 (d, 3H, *J* = 6.3 Hz), 5.13 (m, 1H), 5.31 (s, 1H), 6.15 (s, 1H), 6.54 (dd, 1H, *J* = 8.5, 2.6 Hz), 6.84 (d, 1H, *J* = 8.5 Hz), 6.95 (d, 1H, *J* = 2.6 Hz), 7.21–7.4 (m, 5H). ¹³C NMR (CDCl₃): δ = 21.5, 21.66, 56.06, 69.28, 114.85, 119.77, 124.9, 127.39, 128.76, 128.8, 129.97, 130.86, 137.86, 137.44, 155.62, 172.83. MS (EI): *m/z* (%) = 348 (M⁺, 11), 306 (5), 288 (25), 261 (100), 182 (74), 181 (55). Anal. Calcd for C₁₇H₁₇BrO₃: C, 58.47; H, 4.91. Found: C, 58.6; H, 5.01.

4.2.46. iso-Propyl α -(4-bromo-2-hydroxyphenyl)phenylacetate 9g. Colourless oil. ¹H NMR (400 MHz, CDCl₃): δ = 1.28 (d, 3H, *J* = 6.2 Hz), 1.31 (d, 3H, *J* = 6.3 Hz), 5 9s, 1H), 5.14 (m, 1H), 6.96 (d, 1H, *J* = 8.3 Hz), 7.01 (dd, 1H, *J* = 8.6, 1.9 Hz), 7.08 (d, 1H, *J* = 1.9 Hz), 7.17–7.22 (m, 2H), 7.26–7.34 (m, 3H), 8.13 (s, 1H). ¹³C NMR (CDCl₃): δ = 21.58, 21.61, 55, 70.38, 121.29, 122.46, 123.02, 123.66, 127.56, 128.75, 132.37, 136.39, 155.98, 174.71. MS (EI): *m/z* (%) = 348 (M⁺, 22), 306 (8), 288 (26), 261 (100), 181 (22). Anal. Calcd for C₁₇H₁₇BrO₃: C, 58.47; H, 4.91. Found: C, 58.6; H, 4.92.

4.2.47. iso-Propyl α -(1-4-hydroxynaphthyl)phenylacetate 8m. White crystals. Mp 150–152 °C (hexane/ethyl acetate) ¹H NMR (500 MHz, CDCl₃): δ = 1.28 (d, 3H, *J* = 6.3 Hz), 1.36 (d, 3H, *J* = 6.2 Hz), 5.12 (s, 1H), 5.17 (m, 1H), 7.2–7.3 (m, 6H), 7.38 (d, 1H, *J* = 8.4 Hz), 7.45–7.5 (m, 2H), 7.75–7.79 (m, 1H), 8.31–8.36 (m, 1H), 9.21 (s, 1H). ¹³C NMR (CDCl₃): δ = 21.63, 21.73, 56.71, 70.64, 115.93, 120.1, 122.82, 125.31, 126.53, 126.61, 127.18, 127.41, 127.45, 128.72, 129.37, 134.49, 136.91, 151.73, 175.9. MS (EI): *m/z* (%) = 320 (M⁺, 24), 260 (43), 231 (100). HRMS (EI) calcd for C₂₁H₂₀O₃: 320.14124. Found: 320.14188.

4.2.48. iso-Propyl α -(2-1-hydroxynaphthyl)phenylacetate 9m. White crystals, mp 134–135 °C (hexane/ethyl acetate) ^1H NMR (400 MHz, CDCl_3): δ = 1.16 (d, 3H, J = 6.3 Hz), 1.30 (d, 3H, J = 6.2 Hz), 5.03–12 (m, 1H), 5.12 (s, 1H), 6.53 (s, 1H), 7.28–7.43 (m, 6H), 7.72–7.77 (m, 2H), 8.02–8.08 (m, 1H), 8.08–8.14 (m, 1H). ^{13}C NMR (CDCl_3): δ = 21.4, 21.66, 51.59, 69.24, 126.2, 126.79, 128.15, 129, 129.16, 131.93, 131.99, 133.86, 133.96, 134.51, 136.54, 149, 170.14, 184.44, 185.02. MS (EI): m/z (%) = 320 (M^+ , 18), 260 (47), 231(100). HRMS (EI) calcd for $\text{C}_{21}\text{H}_{20}\text{O}_3$: 320.14124. Found: 320.14076.

4.2.49. iso-Propyl α -(5-chloro-2-hydroxy)phenylacetate 9o. White crystals, mp 97–99 °C (heptane), ^1H NMR (400 MHz, CDCl_3): δ = 1.29 (d, 3H, J = 6.2 Hz), 1.3 (d, 3H, J = 6.3 Hz), 5.03 (s, 1H), 5.10–5.18 (m, 1H), 6.79, (d, 1H, J = 8.5 Hz), 7.07 (d, 1H, J = 2.5 Hz), 7.13 (dd, 1H, J = 8.5, 2.5 Hz), 7.24–7.35 (m, 5H), 7.8–8.0 (bs, 1H). ^{13}C NMR (CDCl_3): δ = 21.56, 54.42, 70.1, 118.79, 125.05, 125.84, 127.56, 127.82, 128.75, 128.95, 130.48, 153.57, 174.17. MS (ES, MeOH): m/z (%) = 327 (M^+ + Na). Anal. Calcd for $\text{C}_{17}\text{H}_{17}\text{ClO}_3$: C, 67.00; H, 5.62; Cl, 11.63. Found: C, 66.81; H, 5.73; Cl, 11.87.

Supplementary data

Supplementary data associated with this article can be found, in the online version at [10.1016/j.tet.2005.09.053](https://doi.org/10.1016/j.tet.2005.09.053)

References and notes

1. Chupakhin, O. N.; Charushin, V. N.; van der Plas, H. C.

Nucleophilic Aromatic Substitution of Hydrogen; Academic: San Diego, 1994.

2. Mąkosza, M. *Russ. Chem. Bull.* **1996**, *45*, 491.
3. Terrier, F. *Nucleophilic Aromatic Displacement, The Influence of Nitro Group*; VCH: New York, 1991.
4. Rose-Munch, F.; Gagliardini, V.; Renard, C.; Rose, E. *Coord. Chem. Rev.* **1998**, *178*, 249.
5. (a) Mąkosza, M.; Staliński, K. *Pol. J. Chem.* **1999**, *73*, 151. (b) Mąkosza, M.; Paszewski, M. *Pol. J. Chem.* **2004**, *79*, 163.
6. Schmitt, S.; Baumgarten, M.; Simon, J.; Hafner, K. *Angew. Chem., Int. Ed.* **1998**, *37*, 1078.
7. Bartoli, G. *Acc. Chem. Res.* **1984**, *17*, 109.
8. Mąkosza, M.; Surowiec, M. *J. Organomet. Chem.* **2001**, *624*, 167.
9. Gallardo, I.; Guirado, G.; Marquet, J. *J. Org. Chem.* **2003**, *68*, 631.
10. Mąkosza, M.; Sypniewski, M. *Tetrahedron* **1994**, *50*, 4913.
11. Mąkosza, M.; Stalinski, K. *Chem. Eur. J.* **1997**, *3*, 2025.
12. Mąkosza, M.; Surowiec, M. *Tetrahedron* **2003**, *59*, 6261.
13. Mąkosza, M.; Surowiec, M.; Paszewski, M. *Arkivoc* **2004**, *2*, 172.
14. Adam, W.; Mąkosza, M.; Stalinski, K.; Zhao, C. G. *J. Org. Chem.* **1998**, *63*, 4390.
15. Adam, W.; Mąkosza, M.; Zhao, C. G.; Surowiec, M. *J. Org. Chem.* **2000**, *65*, 1099.
16. Moskalev, N.; Barbasiewicz, M.; Mąkosza, M. *Tetrahedron* **2004**, *60*, 374.
17. Mąkosza, M.; Paszewski, M. *Synthesis* **2002**, *15*, 2203.
18. Stalinski, K. PhD dissertation, Institute of Organic Chemistry PAS, Warsaw, 1998.
19. Lawrence, N. J.; Lamarche, O.; Thurrab, N. *Chem. Commun.* **1999**, 689.
20. Renaud, P.; Fox, M. A. *J. Org. Chem.* **1988**, *53*, 3745.
21. Adam, W.; BiaŁas, J.; Hadijarapoglou, L. *Chem. Ber.* **1991**, *124*, 2377.

New acyclic receptors containing pyridazine units. The influence of π -stacking on the selective transport of lipophilic phenethylamines

Lucrecia Campayo,^a Fabián Calzado,^a M. Carmen Cano,^a María J. R. Yunta,^a Mercedes Pardo,^{a,*}
Pilar Navarro,^b M. Luisa Jimeno,^b Fernando Gómez-Contreras^a and Ana M. Sanz^a

^aDepartamento de Química Orgánica, Facultad de Química, Universidad Complutense, 28040 Madrid, Spain

^bInstituto de Química Médica, Centro de Química Orgánica Manuel Lora-Tamayo, CSIC, c/Juan de la Cierva 3, 28006 Madrid, Spain

Received 16 December 2004; revised 5 July 2005; accepted 14 September 2005

Available online 10 October 2005

Abstract—The synthesis of four new series of acyclic heteroaromatic receptors is described. They are built by two flexible polyether chains functionalised at their end with pyridazinone or methylpyridazine rings and connected by pyridine or benzene units. Their ability as carriers of lipophilic and hydrophilic phenethylamines and metallic cations has been evaluated. Transport rates show that, in general, these compounds are much more efficient carriers of lipophilic amines than of dopamine and Na^+ , K^+ and Ca^{2+} ions. Their transport selectivities towards phenethylamine and homoveratrylamine are discussed on the basis of their structural features. Molecular modelling studies suggest that interaction of the aromatic moiety of the guest with the pyridazinone rings via double π -stacking, or with the pyridine ring by single π -stacking, should be responsible of their enhanced efficacy and selectivity in the transport of lipophilic phenethylamines.

© 2005 Elsevier Ltd. All rights reserved.

1. Introduction

β -Phenylethylamine derivatives are very interesting molecules, which biological functions depend in part on their hydrophilic or lipophilic character. Thus, dopamine and norepinephrine are hydrophilic neurotransmitter catecholamines that govern a broad range of essential body functions and, therefore, they are considered as important targets in therapeutic research.^{1,2} However, a great number of lipophilic β -phenylethylamines such as amphetamine, methamphetamine, and their methoxy- and/or methylenedioxy derivatives are psychotropic drugs able to produce a variety of undesirable neurotoxic effects.^{3–5} In fact, the fast impact of methamphetamine (commonly named speed) on brain has been related with its strong lipophilic character.⁶

The combination of the impressive development of supramolecular chemistry in recent years and the pharmaceutical interest of catecholamines has inspired many research groups to prepare a wide range of artificial hosts for dopamine and/or norepinephrine with acyclic, mono-cyclic or bicyclic structure.^{7–11}

However, the design of receptors for the selective binding of psychotropic drugs has received much less attention till now.¹² In this field, our research group has reported a series of tetraester crowns containing two 3,5-disubstituted 1*H*-pyrazole rings, which behave as selective monocationic hosts for amphetamine and related compounds.^{13,14}

It is generally believed that most of the drugs with dependence liability are able to affect dopaminergic transmission. That accounts for the interest in developing synthetic receptors that can mimic the selective complexation of the above-mentioned drugs in relation to dopamine and metallic cations involved in neurotransmission mechanism. Those compounds should be useful tools for unravelling the complex mechanism underlying the neurotoxicity of amphetamines and related drugs.¹⁵

Concerning this matter, we have recently described a new series of cyclic heteroaromatic receptors with structures **1a–c** (Fig. 1), which selectively complex and transport ammonium with respect to Na^+ , K^+ and Ca^{2+} ions.¹⁶

Molecular modelling studies suggest that the nitrogen atoms at the pyridine and the pyridazinone units play an important role in the formation of the ammonium complexes.

Keywords: Pyridazine receptors; Lipophilic phenethylamines carriers.

* Corresponding author. Tel.: +34 913944230; fax: +34 913944103; e-mail: merpar@quim.ucm.es

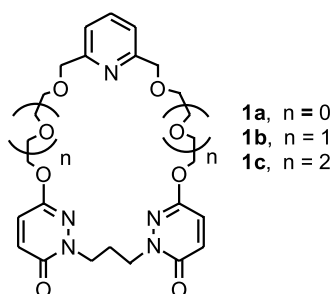

Figure 1. Cyclic heteroaromatic ammonium hosts.

Now, with the idea of increasing the ability of this type of compounds as β -phenethylamine receptors, we have undertaken the synthesis of ditopic acyclic hosts of related structure, able to simultaneously interact with the ammonium ion by hydrogen bonding and the aromatic ring by π -stacking, as schematised in Figure 2. It is well known the important role that π -stacking interactions play in stabilising host–guest complexes.^{17,18}

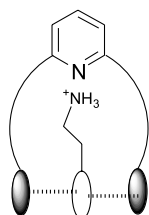

Figure 2. Model for β -phenethylamines receptors.

With that goal in mind, we have prepared four series of compounds (**2–5**). In the first one, a pyridine ring is used as a connector of two flexible chains containing a variable number of ethylenedioxy units functionalised at their end with *N*-methylpyridazinone rings (**2a–c**, Fig. 3).

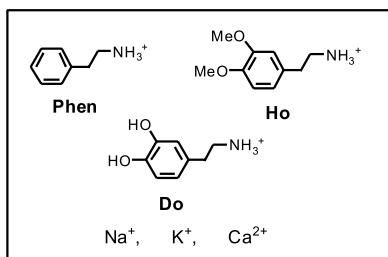
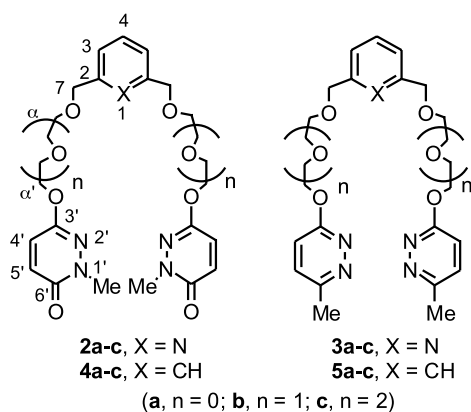

Figure 3. New series of acyclic heteroaromatic β -phenethylamines receptors.

In order to evaluate the influence of the electronic density at the terminal rings on the complexation, the pyridazinone units were substituted by others of methylpyridazine (**3a–c**).

On the other hand, for considering the contribution of the pyridine ring in the stabilisation of the complexes by formation of $^+NH \cdots N$ hydrogen bonds, we have also prepared two additional series (**4a–c** and **5a–c**) in which the pyridine ring was substituted by benzene.

2. Results and discussion

2.1. Synthesis and characterisation of receptors 2–5

The synthesis of receptors **2–5** has been performed in two consecutive steps as indicated in Scheme 1.

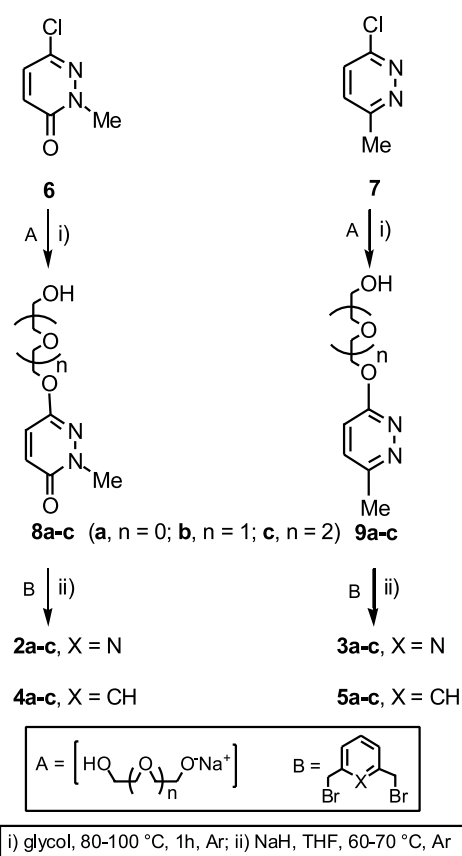

Scheme 1. General synthesis of the hosts.

Treatment of 3-chloro-1-methyl-6-pyridazinone (**6**) or 3-chloro-6-methylpyridazine (**7**) with the mono-sodium salt of ethylene glycol, diethylene glycol and triethylene glycol afforded, respectively, the precursors **8a–c** and **9a–c** with yields around 80%. The reactions took place at 80–100 °C by using the corresponding glycol as the solvent.

In a second step, reaction of **8a–c** or **9a–c** with 2,6-bis(bromomethyl)pyridine (2:1 molar ratio) in the presence of sodium hydride led to, respectively, receptors **2a–c** and **3a–c**. Compounds **4a–c** and **5a–c** were obtained in a similar way starting from 1,3-bis(bromomethyl)benzene in variable yields (32–83%).

Table 1. ^{13}C NMR [CD_3OD , δ (ppm)] chemical shifts of the most significant carbons in compounds **2–5**

	2a	2b	2c	3a	3b	3c	4a	4b	4c	5a	5b	5c
C_4	139.2	139.1	139.1	139.2	139.1	139.1	129.5	129.4	129.4	129.5	129.4	129.4
$\text{C}_{3,5}$	121.8	121.6	121.7	121.8	121.7	121.7	128.2	128.2	128.2	128.0	128.2	128.2
$\text{C}_{2,6}$	160.0	159.1	159.0	159.0	159.1	159.1	139.7	139.8	139.9	139.6	139.9	139.9
C_1	—	—	—	—	—	—	128.2	128.2	128.3	128.5	128.3	128.4
C_7	74.4	74.4	74.4	74.5	74.5	74.5	73.9	74.0	74.0	73.9	74.0	74.1
C_α	70.0	70.1	69.9	70.3	70.4	70.4	69.1	70.1	70.1	69.3	70.4	70.4
C_α'	67.6	67.6	67.6	67.6	67.6	67.6	67.6	67.6	67.7	66.3	67.6	67.6
$\text{C}_{3'}$	154.6	154.7	154.5	165.3	165.3	165.3	154.6	154.7	154.7	165.1	165.3	167.8
$\text{C}_{4'}$	128.6	128.6	128.7	119.8	119.7	119.7	128.7	128.7	128.7	119.6	119.8	119.8
$\text{C}_{5'}$	133.2	133.1	133.2	132.5	132.5	132.5	133.1	133.1	133.1	132.5	132.5	132.5
$\text{C}_{6'}$	161.3	161.3	161.4	156.9	156.9	156.9	161.2	161.2	161.2	156.7	156.8	156.9

All the compounds synthesised were purified by flash column chromatography and isolated as pure low melting point solids or oils.

Structures were assigned on the basis of analytical and spectroscopic data. Molecular ions obtained from FAB or EI techniques fit the proposed structures and agree in most cases with the base peak, as can be seen in Section 3.

For an accurate identification of the ^1H and ^{13}C NMR spectra signals, 2D experiments (gCOSY, gHSQC and gHMBC) were specially useful. Interesting criteria obtained in the signals assignment are immediately after. The ^1H NMR diazine signals are easily differentiated from those of the pyridine and benzene rings, appearing as neat AB systems with coupling constants in the range of 9.6–9.9 Hz. On the contrary, pyridine protons are shown as doublets and triplets of 2:1 relative intensities with coupling constants in the range of 8 Hz. Finally, the benzene ring originates a more complex pattern, with H_1 (see Fig. 3 for numbering) appearing always as the highest chemical shift for pyridazinone derivatives or the highest chemical shift in the benzene ring for the methylpyridazine ones.

In the ^{13}C NMR spectra (Table 1) $\text{C}_{6'}$ is the most deshielded signal in the pyridazinone derivatives (**2** and **4**), but this feature corresponds to $\text{C}_{3'}$ in the methylpyridazine compounds (**3** and **5**). The methylene groups linked to the pyridine ring are about 0.5 ppm more deshielded than those of the benzene ring. The more shielded methylene groups of the polyethylene glycol units are those neighbouring the diazine moiety.

2.2. Ionophoric properties in relation to structural features for receptors **2–5**

We have measured the ability of compounds **2–5** as carriers of the ammonium ion of phenethylamine (Phen) and homoveratrylamine (Ho). Both amines have been taken as elementary models of lipophilic psychotropic drugs structurally related to amphetamine and their methoxy- and/or methylenedioxy derivatives. We have also evaluated the selectivity against the hydrophilic dopamine (Do) and biologically significant metallic cations (Na^+ , K^+ and Ca^{2+}).

Transport rates have been determined by using a bulk liquid membrane of chloroform, following a classical procedure in which the transport process occurs by carrier mediated facilitated diffusion along the concentration gradient of the guest salts. (See Section 3).^{19,20}

The results obtained for the new acyclic series **2–5** are shown in Table 2 together with those corresponding to the cyclic analogues **1**, which had not been previously evaluated as carriers of phenethylamine derivatives.¹⁶

It can be observed that all the compounds assayed behave as much more efficient carriers of the lipophilic ammonium ions than of the hydrophilic dopaminium. Moreover, they also exhibit an excellent selectivity in relation to the metallic ions.

As a rule, acyclic derivatives **2–4** show higher transport rates for both phenethylamine and homoveratrylamine than

Table 2. Transport rates ($\mu\text{M h}^{-1}$) for alkali, alkaline earth and organic ammonium ions through a 7×10^{-4} M chloroform solution of receptors **1–5**

Compound	Phen	Ho	Do	Na^+	K^+	Ca^{2+}
1a	10.0	16.1	0.5	4.9	2.6	1.3
1b	13.7	9.1	0.8	6.3	6.9	4.9
1c	0.1	2.4	0.9	3.3	4.5	2.0
2a	15.3	29.5	1.2	1.7	1.6	0.6
2b	61.3	13.2	1.0	1.7	0.9	0.6
2c	46.2	11.8	0.8	6.2	6.5	5.0
3a	37.6	31.6	1.0	1.0	3.9	0.3
3b	52.0	27.4	0.9	1.6	4.8	1.2
3c	34.3	31.9	0.3	3.8	7.4	2.2
4a	4.9	16.7	1.0	1.0	0.1	0.7
4b	65.5	33.6	1.6	1.0	2.7	0.8
4c	18.9	22.1	1.4	4.0	2.0	2.3
5a	6.2	18.4	1.4	2.7	2.3	0.8
5b	6.9	18.3	2.6	4.9	1.8	1.1
5c	5.3	15.3	2.8	3.2	2.5	5.9

the cyclic ones with the same chain length. Furthermore, all the **5a–c** derivatives are better carriers of homoveratrylamine than the **1a–c** series.

Concerning the relative transport efficiency of the acyclic compounds, it should be noted that in all of them the best phenethylamine transport values correspond to the **b** series that contains diethylenedioxy units. The homoveratrylamine transport values are more random and less dependent of the chain length.

With the idea of performing a rational consideration of the transport activity/structure relation, we have focused our attention in a common structural feature: the presence of the diethylenedioxy chain as a spacer. That selection was made because previous molecular modelling suggested that this chain has the most adequate length for allowing simultaneous interaction of the ammonium group and the aromatic ring of the guest with the receptor. Therefore, in the following discussion, we will refer only to the best phenethylamine carriers **2b–5b**.

When comparing the pyridazinone functionalised compounds (**2b** and **4b**) with those ones containing methylpyridazine units (**3b** and **5b**), it is shown that an increase in the electronic density of the terminal rings leads always to lower phenethylamine transport rates. With respect to homoveratrylamine, this fact is also true when the connector is the benzene ring.

Concerning the nature of the connector ring, it should be noted that phenethylamine transport rates are scarcely affected when the pyridine ring of **2b** ($\nu = 61.3 \mu\text{Mh}^{-1}$) is changed by benzene in **4b** ($\nu = 65.5 \mu\text{Mh}^{-1}$). However, homoveratrylamine is clearly best transported in the presence of the benzene connector ring (**2b**, $\nu = 13.2 \mu\text{Mh}^{-1}$; **4b**, $\nu = 33.6 \mu\text{Mh}^{-1}$). In contrast, compound **3b**, functionalised with a pyridine connector, is a much better carrier of both lipophilic amines than its benzene analogue **5b**.

Table 3 displays the excellent selectivity found for the lipophilic amines against dopamine in the two pyridazinone derivatives **2b** and **4b** and in the methylpyridazine derivative **3b**. Compound **5b** clearly appears as the less efficient and selective carrier (i.e., **2b** is 20 times more selective for phenethylamine with respect to dopamine than **5b**).

Table 3. Selected transport rates selectivity

Compound	Phen/Do	Ho/Do
2b	61.3	13.2
4b	40.9	21.0
3b	57.8	30.4
5b	2.6	7.0

The lesser transport rates usually found for homoveratrylamine with respect to phenethylamine could be due in part to the presence of the methoxy groups, which makes more difficult the extraction process from the aqueous phase. The interaction among homoveratrylamine and the water

molecules is supposedly stronger than that one of phenethylamine.

In order to evaluate both the ammonium-receptors interactions and the π -stacking features involved for the most promising carriers found in this work, we have performed molecular modelling of the phenethylamine and homoveratrylamine complexes of ligands **2b–5b**. The additive AMBER force field has been used because it is especially adequate for describing the complexation processes of our ligands, since it is one of the best methods²¹ in reproducing H-bonding and π -stacking stabilisation energies. Methodology and conventions adopted are summarised in Section 3.

Figure 4 displays the most stable conformations obtained for the phenethylamine complexes of **2b–5b**. Intermolecular hydrogen bonds linking ligands heteroatoms with the ammonium ion are also shown in every case.

Compounds **2b** and **4b** exhibit double π -stacking between the aromatic ring of the guest and the two π -deficient pyridazinone units, and it is shown that the three aromatic rings are disposed in a nearly parallel way. On the other hand, the ammonium group is hydrogen bonded to oxygen atoms O₁₁ and O₁₄ belonging to one of the side chains of **2b**. The ammonium complexation in **4b** takes place in a similar way by interaction with the O₈ and O₁₄ atoms at the same side chain of the host. It has been stated above that both **2b** and **4b** are very good phenethylamine carriers. Therefore, it seems that the pyridine ring is not playing an essential role in the complexation with respect to the benzene unit.

In contrast, when the pyridazinone rings of **2b** are substituted by the more electron-rich methylpyridazine units (**3b**), molecular modelling suggests that the guest disposition is reversed, so that the four methylpyridazine nitrogen atoms simultaneously interact with two hydrogen atoms of the ammonium group, whereas only a single π -stacking between the ring of the guest and the pyridine unit can be observed. Bradshaw and Izatt had previously reported that kind of aromatic interaction for the complexation of 1-naphtylethylamine with crown ethers containing a pyridine ring.²²

A similar disposition is found for the benzene ligand **5b**. Bifurcated and trifurcated hydrogen bonds with the methylpyridazine nitrogen atoms are found for the ammonium ion of the guest, and the interaction between the aromatic rings of host and guest is even worse because they are located in very unfavourable disposition for allowing effective π -stacking. These facts account again for the influence of that kind of interaction, since **3b** and **5b** are worse phenethylamine carriers than **2b** and **4b**.

The complexation models of homoveratrylamine with **2b–5b** (Fig. 5) follow very similar patterns to those described above, but with some significant modifications that could explain the transport rates differences obtained for that amine with respect to phenethylamine.

In the **2b** complex, the ammonium group exhibits single hydrogen bonding with the pyridine heteroatom, and

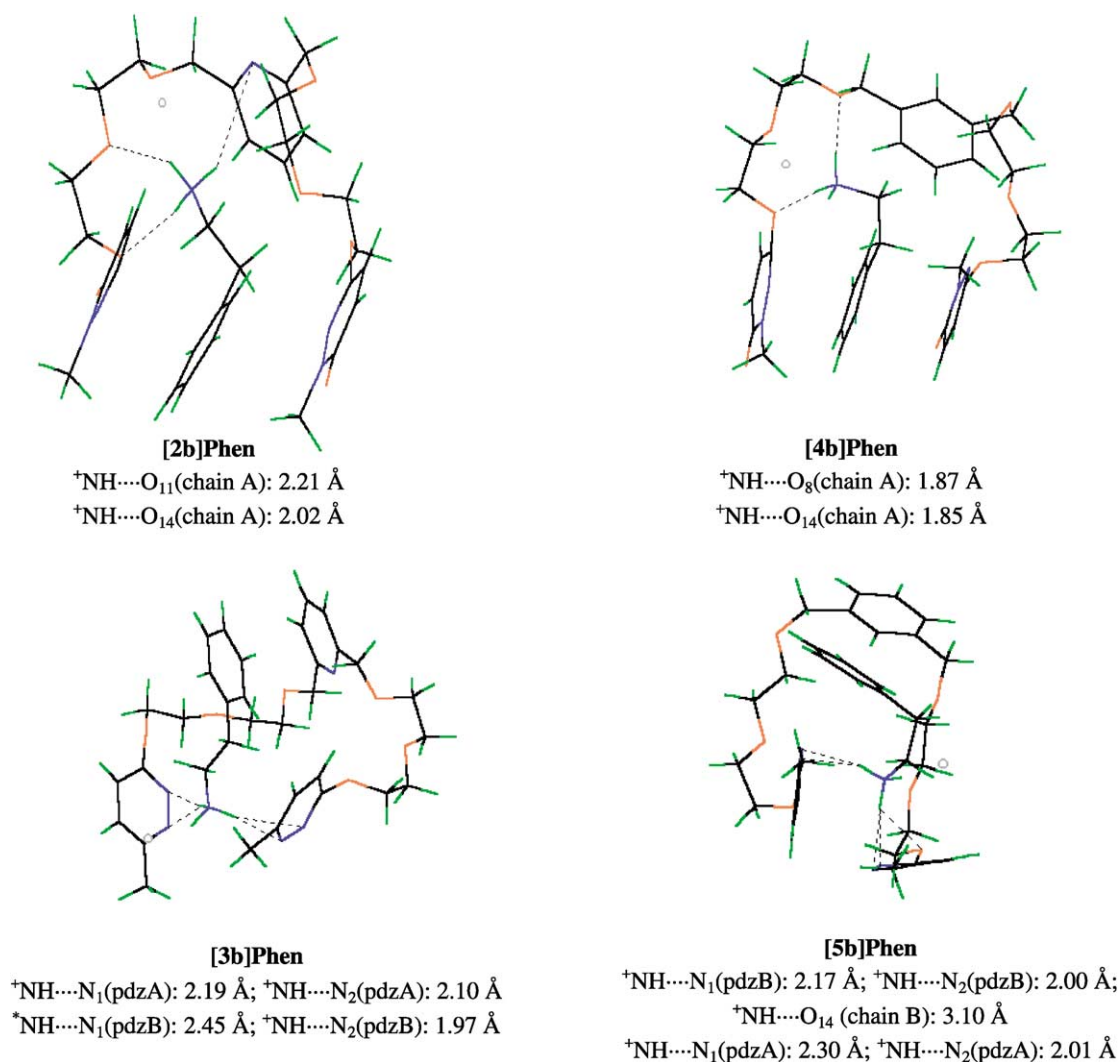

Figure 4. Molecular modelling and hydrogen bonding lengths for the **2b–5b** complexes with phenethylamine.

another one bifurcated with one nitrogen of the pyridazone unit and with the neighbouring oxygen. The aromatic ring of the host remains parallel to both diazine rings, but it is rotated about 45° with respect to the phenethylamine complex. On the other hand, two ammonium protons are single-linked to two oxygen atoms located at different sides of the **4b** benzene ring, and that interaction seems to favour an orientation of the aromatic ring of the guest that is similar to that found in the **2b** and **4b** phenethylamine complexes. We think that these results could explain the higher efficiency in homoveratrylamine transport found for **4b** with respect to **2b**, confirming the predominant role of π -stacking interactions.²³

If we turn now towards the **3b** and **5b** homoveratrylamine complexes, the reversion of the host–guest disposition found for phenethylamine is also found here. In both cases the ammonium group interacts in a bifurcate way with the methylpyridazine nitrogen atoms and there is supplementary bonding with one oxygen at the flexible side-chain. The main difference rests on the fact that the interaction between the aromatic ring of the amine and another one of the host is clearly observed in the **3b** model, whereas no π -stacking is found in the **5b** complex. That is again reflected in the

transport effectiveness, since **5b** is a much poorer carrier of homoveratrylamine.

In an effort to confirm the structural differences suggested by molecular modelling, we have selected the 1:1 phenethylamine complexes of ligands **2b** and **3b** and performed more detailed NMR studies. In a first instance, those complexes were formed in situ in a 9:1 $\text{CDCl}_3/\text{CD}_3\text{OH}$ solution and the corresponding ^{13}C NMR spectra were registered and compared with those obtained from the free ligands and the amine under the same conditions. We did not use an excess of phenethylamine because the stoichiometry could change due to the acyclic character of the ligands involved. A detailed consideration of the spectra showed that the behaviour of ligands **2b** and **3b** against complexation seems quite different, because shielding and deshielding are reversed or modified in the ring moieties after complexation. However, the chemical shifts variations obtained are very small and not significant, as could be expected for this kind of acyclic and flexible ligands. Therefore, these results can only be considered as indicative.

In search of more significative data, we performed then the

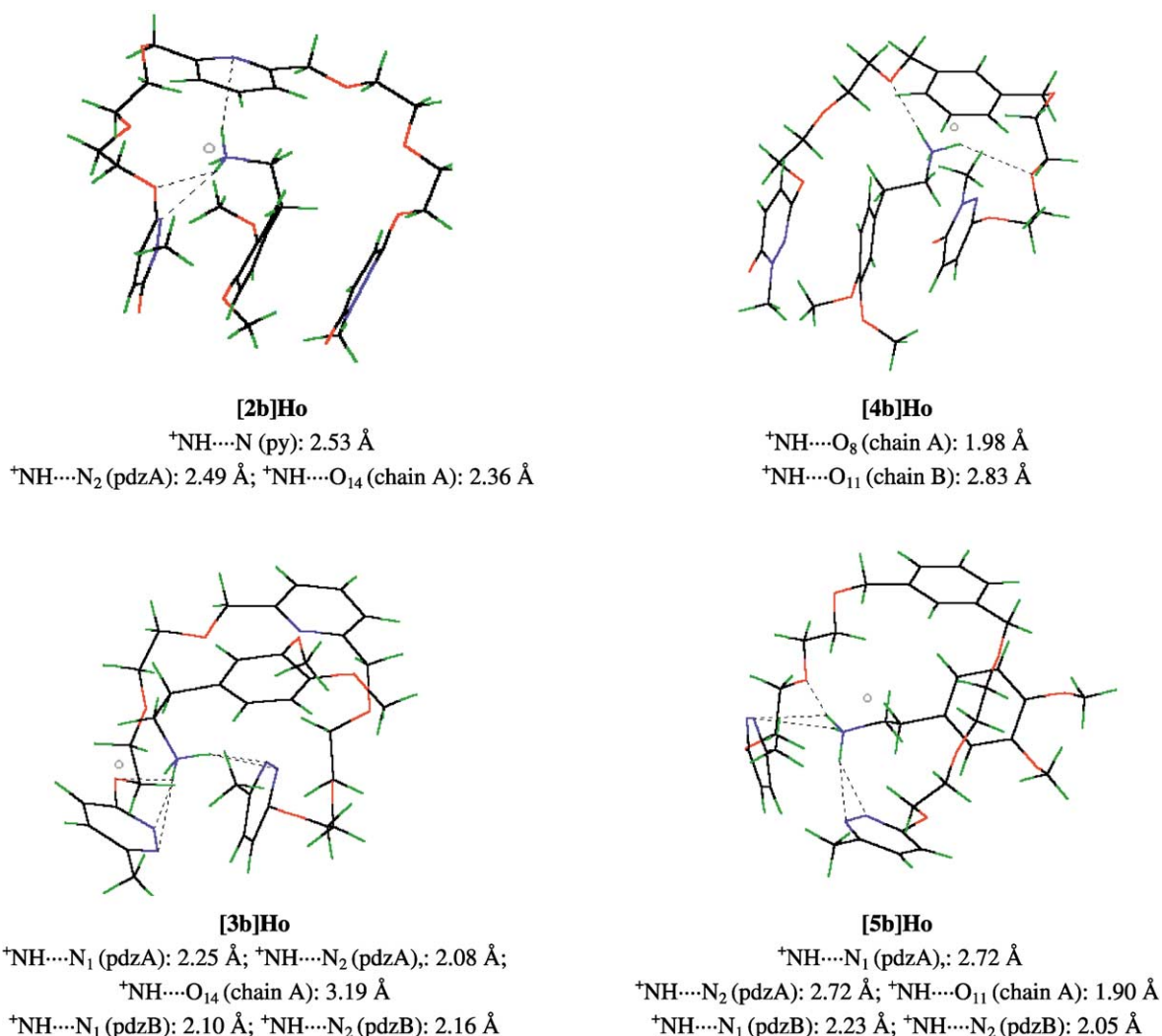

Figure 5. Molecular modelling and hydrogen bonding lengths for the **2b–5b** complexes with homoveratrylamine

2D-ROESY and 2D-NOESY spectra under the same conditions indicated above. Spectra of the free ligands show plenty of correlations corresponding to intramolecular NOE and ROE effects, as could be expected from the high conformational flexibility supposed for **2b** and **3b**. In the phenethylamine complexes, new intramolecular and intermolecular cross-peaks are found.

A more detailed study of the **[2b]Phen** complex allows to determine the presence of cross-peaks between the N-Me hydrogens at the pyridazinone ring of the ligand and those at the aromatic moiety of phenethylamine, and also between the methylene groups α and β with respect to the pyridine ring (see Fig. 6) and the methylene next to the ammonium of phenethylamine. This result are in agreement with a disposition in which the aliphatic chain of phenethylamine is located inside the cavity, whereas the aromatic ring points to the outside neighbouring to the pyridazinone rings, in accordance with the model proposed in Figure 4.

On the other hand, the **[3b]Phen** complex exhibits intramolecular correlations between the C_6 -Me protons at one of the pyridazine units of the ligand and the H_4 , hydrogen of the second unit, indicating the close proximity

of both rings. Furthermore, the appearance of intermolecular cross-peaks between the α and β methylene groups of the ligand and the *meta* hydrogens of the phenethylamine ring is indicative that the last one is now located inside the cavity (see Fig. 6). These data agree with the model proposed in Figure 4. In consequence, we think that NMR experiments reasonably support the hypothesis suggested by molecular modelling.

In conclusion, we have prepared new series of acyclic

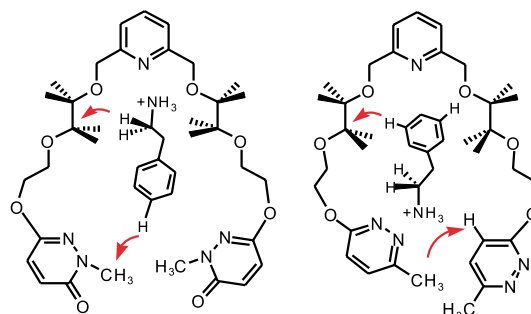

Figure 6. Selected ROESY correlations exhibited by the **[2b]Phen** and **[3b]Phen** complexes.

receptors that behave as effective and selective carriers of lipophilic phenethylamines, by the formation of ditopic complexes stabilised both by π -stacking and hydrogen bonding. Among them, the pyridazinone derivatives **2b** and **4b** are the most efficient and are also the compounds with stronger interactions involving the aromatic moieties. As proposed in our initial planning, π -stacking seems to play an important role and rules the structure of the complexes on the basis of the respective electronic densities of the aromatic rings in host and guest.

3. Experimental

3.1. General

Reagents were purchased from commercial suppliers and used without further purification unless otherwise stated. Ligands were prepared in dry solvents under an argon atmosphere. All the reactions were monitored using thin-layer chromatography (TLC) on precoated aluminium sheets of silica gel, and compounds were detected with UV light and/or iodine chamber. Flash column chromatography was performed in the indicated solvent and supported on silica gel (particle size 0.040–0.063 mesh). Melting points were determined in a Gallenkamp apparatus. ^1D NMR spectra (^1H and ^{13}C) were recorded at room temperature using TMS as internal reference (chemical shifts in δ values, J in Hz) on a Bruker AC 200 or on a VARIAN VXR300S spectrometers. Two-dimensional (2D) spectra were recorded on a Varian Unity 500 instrument working at 499.88 MHz (^1H) and 125.71 MHz (^{13}C). gCOSY, gHSQC and gHMBC were acquired using standard conditions. ROESY spectra were recorded with 300 and 500 mixing times. A total of $2 \times 200 \times 2048$ data matrix with 64 scans per t_1 value was collected. Gaussian line broadening and a sine-bell function were used in weighting the t_2 and t_1 dimensions, respectively. After two-dimensional Fourier transformations, the spectra were obtained as $2k \times 2k$ matrices, and were phase and baseline corrected in both dimensions. NOESY spectra resulted from $2 \times 200 \times 2048$ data matrices with 64 scans per t_1 value. The spectral data were acquired at 298 K with 300 and 500 ms mixing times. The time domain data were zero filled to yield $2k \times 2k$ spectral data matrices and were processed in a similar way to those of the 2D ROESY spectra described above.

Mass spectra were recorded by electronic impact (EI) at 70 eV, or by the fast atomic bombardment (FAB) technique using a *m*-nitrobenzyl alcohol matrix. Elemental analyses (C, H and N) were performed on a Perkin-Elmer 2400 CHN apparatus.

3-Chloro-1-methyl-6-pyridazinone was prepared by treatment of 3-hydroxy-1-methyl-6-pyridazinone with phosphorus oxychloride.²⁴

3.2. Synthesis of 3-alkoxy-1-methylpyridazin-6-ones (8a–c)

To a solution of 7 mmol (160 mg) of sodium in excess of the appropriate glycol (5 mL) 3.5 mmol (500 mg) of 3-chloro-1-methyl-6-pyridazinone (**6**) was slowly added. The mixture

was heated to 100 °C for 1 h and excess of glycol was removed under reduced pressure. The residue was diluted with water (ca. 3–5 mL) and extracted with chloroform. The crude product was purified by flash chromatography using toluene/ethyl acetate/chloroform/methanol 1:2:1:1, v:v as eluent.

3.2.1. 3-(2-Hydroxyethoxy)-1-methylpyridazin-6-one (8a). R_f 0.35. Yield 68%; mp 68–70 °C. IR (KBr) ν : 3400 (OH), 1675, 1600 cm^{-1} . ^1H NMR (CD_3OD) δ : 7.18 (1H, d, $J=9$ Hz, 4'-H), 6.96 (1H, d, $J=9$ Hz, 5'-H), 4.23 (2H, m, α' -H), 3.85 (2H, m, CH_2OH), 3.64 (3H, s, N- CH_3). ^{13}C NMR (CD_3OD) δ : 161.3, 154.8, 133.1, 128.7, 69.8, 61.0, 40.0. MS m/z (%): 170 (26, M^+), 126 (54), 98 (100). Anal. Calcd for $\text{C}_7\text{H}_{10}\text{N}_2\text{O}_3$: C, 49.4; H, 5.9; N, 16.5. Found: C, 49.2; H, 5.8; N, 16.2.

3.2.2. 3-[2-(2-Hydroxyethoxy)-ethoxy]-1-methylpyridazin-6-one (8b). R_f 0.46. Yield 52%; mp 88–90 °C. IR (KBr) ν : 3390 (OH), 1660, 1500 cm^{-1} . ^1H NMR (CD_3OD) δ : 6.97 (1H, d, $J=9$ Hz, 4'-H), 6.91 (1H, d, $J=9$ Hz, 5'-H), 4.31 (2H, m, α' -H), 3.83 (2H, m, β' -H), 3.64 (2H, m, γ' -H), 3.77 (2H, m, CH_2OH), 3.65 (3H, s, N- CH_3). ^{13}C NMR (CD_3OD) δ : 159.5, 152.4, 132.7, 126.6, 72.6, 69.1, 66.3, 61.7, 39.6. MS m/z (%): 214 (6, M^+), 126 (55), 45 ($\text{C}_2\text{H}_5\text{O}$, 100). Anal. Calcd for $\text{C}_9\text{H}_{14}\text{N}_2\text{O}_4$: C, 50.5; H, 6.6; N, 13.1. Found: C, 50.7; H, 6.4; N, 13.1.

3.2.3. 3-{2-[2-(2-Hydroxyethoxy)-ethoxy]-ethoxy}-1-methylpyridazin-6-one (8c). R_f 0.57. Yield 59%; mp 64–66 °C. IR (KBr) ν : 3350, 1660, 1590 cm^{-1} . ^1H NMR (CD_3OD) δ : 7.0 (1H, d, $J=9$ Hz, 4'-H), 6.91 (1H, d, $J=9$ Hz, 5'-H), 4.31 (2H, m, α' -H), 3.83 (2H, m, β' -H), 3.71 (2H, m, CH_2OH), 3.62 (6H, m, γ' , δ' , ϵ' -H), 3.64 (3H, s, N- CH_3). ^{13}C NMR (CD_3OD) δ : 159.5, 152.4, 132.7, 126.7, 72.6, 70.7, 70.4, 69.2, 66.2, 61.7, 39.5. MS m/z (%): 258 (1, M^+), 126 (15), 45 ($\text{C}_2\text{H}_5\text{O}$, 100). Anal. Calcd for $\text{C}_{11}\text{H}_{18}\text{N}_2\text{O}_5$: C, 51.15; H, 7.0; N, 10.85. Found: C, 50.9; H, 7.0; N, 10.6.

3.3. Synthesis of 3-alkoxy-6-methylpyridazines (9a–c)

To a solution of 2 mmol (50 mg) of sodium in excess of the appropriate glycol (3 mL) 1 mmol (130 mg) of 3-chloro-6-methylpyridazine (**7**) was slowly added. The mixture was heated to 100 °C for 1 h and excess of glycol was removed under reduced pressure. The residue was diluted with water (ca. 3 mL) and extracted with chloroform. The crude product was purified by flash chromatography using toluene/ethyl acetate/ethanol 1:1:0.3, v:v as eluent.

3.3.1. 3-(2-Hydroxyethoxy)-6-methylpyridazine (9a). R_f 0.33. Yield 71%; mp 71–74 °C. IR (KBr) ν : 3450 (OH), 1600 cm^{-1} . ^1H NMR (CD_3OD) δ : 7.50 (1H, d, $J=9$ Hz, 5'-H), 7.13 (1H, d, $J=9$ Hz, 4'-H), 4.49 (2H, m, α' -H), 3.91 (2H, m, CH_2OH), 2.56 (3H, s, CH_3). ^{13}C NMR (CD_3OD) δ : 165.5, 156.9, 132.4, 119.8, 69.8, 61.3, 20.9. MS m/z (%): 137 (100, $\text{M}^+ - 17$), 111 (33). Anal. Calcd for $\text{C}_7\text{H}_{10}\text{N}_2\text{O}_2$: C, 54.9; H, 6.3; N, 18.2. Found: C, 55.1; H, 6.3; N, 18.4.

3.3.2. 3-[2-(2-Hydroxyethoxy)-ethoxy]-6-methylpyridazine (9b). R_f 0.29. Yield 77%; yellow oil. IR (CHCl_3) ν : 3500–3100 (OH), 1610, and 1590 cm^{-1} . ^1H NMR

(CD₃OD) δ : 7.50 (1H, d, $J=9$ Hz, 5'-H), 7.10 (1H, d, $J=9$ Hz, 4'-H), 4.56 (2H, m, α' -H), 3.87 (2H, m, β' -H), 3.67 (2H, m, CH₂OH), 3.55 (2H, m, γ' -H), 2.56 (3H, s, CH₃). ¹³C NMR (CD₃OD) δ : 165.3, 156.9, 132.5, 119.8, 73.5, 70.3, 67.6, 62.3, 20.9. MS (FAB) m/z (%) 199 (1, MH⁺), 181 (1, M⁺ - 17), 137 (26), 111 (100), 110 (37). Anal. Calcd for C₉H₁₄N₂O₃·0.5H₂O: C, 52.2; H, 7.3; N, 13.5. Found: C, 52.2; H, 7.2; N, 13.1.

3.3.3. 3-{2-[2-(2-Hydroxyethoxy)-ethoxy]-ethoxy}-6-methylpyridazine (9c). R_f 0.14. Yield 84%; yellow oil. IR (CHCl₃) ν : 3350 (OH), 1610 cm⁻¹. ¹H NMR (CD₃OD) δ : 7.50 (1H, d, $J=9$ Hz, 5'-H), 7.11 (1H, d, $J=9$ Hz, 4'-H), 4.55 (2H, m, α' -H), 3.88 (2H, m, β' -H), 3.70–3.50 (8H, m, γ' , δ' , ϵ' -H, and CH₂OH), 2.56 (3H, s, CH₃). ¹³C NMR (CD₃OD) δ : 165.3, 156.9, 132.5, 119.8, 73.7, 71.5, 71.4, 70.4, 67.5, 62.2, 20.9. MS m/z (%) 243 (10, MH⁺), 225 (1, M⁺ - 17), 137 (45), 111 (100), 110 (43). Anal. Calcd for C₁₁H₁₈N₂O₄·0.5H₂O: C, 52.6; H, 7.6; N, 11.15. Found: C, 52.7; H, 7.6; N, 10.9.

3.4. General procedure for the preparation of pyridine receptors 2 and 3

To a suspension of 4 mmol of sodium hydride in 60 mL of anhydrous THF a solution of 2 mmol of the appropriate hydroxy derivative **8** or **9** in 40 mL of dry THF and a solution of 1 mmol of 2,6-bis(bromomethyl)pyridine in 40 mL of anhydrous THF were slowly and simultaneously added. The reaction mixture was heated at 60–70 °C for 6 h, stirred at room temperature overnight, diluted with water, and extracted with chloroform. Solvent was removed under reduced pressure and the residue was chromatographed on silicagel using as eluent a mixture of toluene/ethyl acetate/chloroform/methanol 1:2:1:0.5, v:v.

3.4.1. 2,6-Bis[2-(1-methyl-6-oxopyridazin-3-yloxy)-ethoxymethyl]pyridine (2a). R_f 0.54. Yield 49%; mp 89–92 °C. IR (KBr) ν : 3010, 1675 (C=O), 1595, 1255 cm⁻¹. ¹H NMR (CD₃OD) δ : 7.82 (1H, t, $J=8$ Hz, 4-H), 7.42 (2H, d, $J=8$ Hz, 3,5-H), 7.16 (2H, d, $J=9$ Hz, 4'-H), 6.95 (2H, d, $J=9$ Hz, 5'-H), 4.67 (4H, s, 7-H), 4.38 (4H, m, α' -H), 3.91 (4H, m, α -H), 3.63 (6H, s, N-CH₃). ¹³C NMR (CD₃OD) δ : 161.3, 160.0, 154.6, 139.2, 133.2, 128.6, 121.8, 74.4, 69.9, 67.6, 40.0. MS m/z (%) 444 (78, MH⁺), 153 (34), 138 (46), 107 (39). Anal. Calcd for C₂₁H₂₅N₅O₆: C, 57.0; H, 5.7; N, 15.8. Found: C, 57.0; H, 5.8; N, 15.6.

3.4.2. 2,6-Bis[2-[2-(1-methyl-6-oxopyridazin-3-yloxy)-ethoxy]-ethoxymethyl]pyridine (2b). R_f 0.41. Yield 55%; yellow oil. IR (CHCl₃) ν : 3010, 1670 (C=O), 1600, 1230 cm⁻¹. ¹H NMR (CD₃OD) δ : 7.79 (1H, t, $J=8$ Hz, 4-H), 7.42 (2H, d, $J=8$ Hz, 3,5-H), 7.16 (2H, d, $J=9$ Hz, 4'-H), 6.93 (2H, d, $J=9$ Hz, 5'-H), 4.63 (4H, s, 7-H), 4.31 (4H, m, α' -H), 3.84 (4H, m, β' -H), 3.74 (8H, m, β and α -H), 3.63 (6H, s, N-CH₃). ¹³C NMR (CD₃OD) δ : 161.3, 159.1, 154.7, 139.1, 133.1, 128.6, 121.6, 74.4, 71.7, 71.5, 70.1, 67.6, 40.0. MS (FAB) m/z (%) 532 (44, MH⁺), 155 (30), 139 (20). Anal. Calcd for C₂₅H₃₃N₅O₈·H₂O: C, 54.6; H, 6.4; N, 12.7. Found: C, 54.85; H, 6.2; N, 12.4.

3.4.3. 2,6-Bis[2-[2-(1-methyl-6-oxopyridazin-3-yloxy)-ethoxy]-ethoxymethyl]pyridine (2c). R_f 0.33.

Yield 37%; yellow oil. IR (CHCl₃) ν : 3060, 1665 (C=O), 1590, 1265 cm⁻¹. ¹H NMR (CDCl₃) δ : 7.69 (1H, t, $J=8$ Hz, 4-H), 7.37 (2H, d, $J=8$ Hz, 3,5-H), 6.95 (2H, d, $J=9$ Hz, 4'-H), 6.88 (2H, d, $J=9$ Hz, 5'-H), 4.67 (4H, s, 7-H), 4.29 (4H, m, α' -H), 3.83 (4H, m, β' -H), 3.72 (16H, m, γ' , γ , β , and α -H), 3.64 (6H, s, N-CH₃). ¹³C NMR (CDCl₃) δ : 159.4, 158.0, 152.4, 137.4, 132.6, 126.7, 120.4, 74.1, 70.8, 70.7, 70.4, 69.3, 66.3, 39.6. MS m/z (%) 620 (5, MH⁺), 619 (10, M⁺); 125 (7). Anal. Calcd for C₂₉H₄₁N₅O₁₀·H₂O: C, 54.6; H, 6.75; N, 11.0. Found: 54.8; H, 6.7; N, 10.9.

3.4.4. 2,6-Bis[2-(6-methylpyridazin-3-yloxy)-ethoxymethyl]pyridine (3a). R_f 0.22. Yield 74%; pale yellow oil. IR (CHCl₃) ν : 3010, 1610, 1445, 1220, 1050 cm⁻¹. ¹H NMR (CD₃OD) δ : 7.80 (1H, t, $J=8$ Hz, 4-H), 7.50 (2H, d, $J=9$ Hz, 5'-H), 7.42 (2H, d, $J=8$ Hz, 3,5-H), 7.11 (2H, d, $J=9$ Hz, 4'-H), 4.67 (4H, s, 7-H), 4.62 (4H, m, α' -H), 3.96 (4H, m, α -H), 2.56 (6H, s, CH₃). ¹³C NMR (CD₃OD) δ : 165.3, 159.0, 156.9, 139.2, 132.5, 121.8, 119.8, 74.5, 70.3, 67.6, 20.9. MS (FAB) m/z (%) 412 (82, MH⁺), 302 (64), 153 (15), 137 (100), 121 (20), 105 (18). Anal. Calcd for C₂₁H₂₅N₅O₄: C, 61.25; H, 6.1; N, 17.0. Found: C, 61.0; H, 6.2; N, 16.7.

3.4.5. 2,6-Bis[2-[2-(6-methylpyridazin-3-yloxy)-ethoxymethyl]pyridine (3b). R_f 0.40. Yield 29%; yellow oil. IR (CHCl₃) ν : 3020, 1605, 1450, 1220, 1050 cm⁻¹. ¹H NMR (CD₃OD) δ : 7.77 (1H, t, $J=8$ Hz, 4-H), 7.47 (2H, d, $J=9$ Hz, 5'-H), 7.42 (2H, d, $J=8$ Hz, 3,5-H), 7.08 (2H, d, $J=9$ Hz, 4'-H), 4.62 (4H, s, 7-H), 4.56 (4H, m, α' -H), 3.96 (4H, m, β' -H), 3.75 (8H, m, β and α -H), 2.55 (6H, s, CH₃). ¹³C NMR (CD₃OD) δ : 165.3, 159.1, 156.9, 139.1, 132.5, 121.6, 119.7, 74.5, 71.7, 71.5, 70.4, 67.6, 20.9. MS (FAB) m/z (%) 500 (100, MH⁺), 499 (6, M⁺), 153 (8), 137 (61), 121 (12), 105 (13). Anal. Calcd for C₂₅H₃₃N₅O₆·H₂O: C, 58.0; H, 6.2; N, 12.7. Found: C, 58.0; H, 6.7; N, 12.5.

3.4.6. 2,6-Bis[2-[2-[2-(6-methylpyridazin-3-yloxy)-ethoxy]-ethoxy]-ethoxymethyl]pyridine (3c). R_f 0.16. Yield 39%; yellow oil. IR (CHCl₃) ν : 3020, 1605, 1450, 1220, 1050 cm⁻¹. ¹H NMR (CD₃OD) δ : 7.79 (1H, t, $J=8$ Hz, 4-H), 7.48 (2H, d, $J=9$ Hz, 5'-H), 7.43 (2H, d, $J=8$ Hz, 3,5-H), 7.07 (2H, d, $J=9$ Hz, 4'-H), 4.61 (4H, s, 7-H), 4.55 (4H, m, α' -H), 3.88 (4H, m, β' -H), 3.71–3.66 (16H, m, γ' , γ , β , and α -H), 2.55 (6H, s, CH₃). ¹³C NMR (CD₃OD) δ : 165.3, 159.1, 156.9, 139.1, 132.5, 121.7, 119.7, 74.5, 71.7, 71.5, 70.4, 67.6, 20.9. MS (FAB) m/z (%) 588 (100, MH⁺), 587 (7, M⁺), 153 (10), 137 (72), 121 (16), 105 (13). Anal. Calcd for C₂₉H₄₁N₅O₈·H₂O: C, 57.5; H, 7.1; N, 11.6. Found: C, 57.4; H, 7.1; N, 11.2.

3.5. General procedure for the preparation of benzene receptors 4 and 5

To a suspension of 3 mmol of sodium hydride in 20 mL of anhydrous THF a solution of 2 mmol of the appropriate hydroxy derivative in 25 mL of dry THF and a solution of 1 mmol of 1,3-bis(bromomethyl)benzene in 25 mL of anhydrous THF were slowly and simultaneously added. The reaction mixture was heated at 65–70 °C for 6 h, stirred at room temperature overnight, diluted with water, and extracted with chloroform. Solvent was removed under reduced pressure and the residue was chromatographed on

silicagel using as eluent a mixture of toluene/ethyl acetate/ethanol 2:1:0.5, v:v.

3.5.1. 1,3-Bis[2-(1-methyl-6-oxopyridazin-3-yloxy)-ethoxymethyl]benzene (4a). R_f 0.63. Yield 29%; yellow oil. IR (CHCl₃) ν : 3060, 1670, 1590, 1265, 1110 cm⁻¹. ¹H NMR (CD₃OD) δ : 7.35 (1H, s, 1-H), 7.34–7.27 (3H, m, 3,4,5-H), 7.13 (2H, d, $J=9$ Hz, 4'-H), 6.93 (2H, d, $J=9$ Hz, 5'-H), 4.58 (4H, s, 7-H), 4.31 (4H, m, α' -H), 3.81 (4H, m, α -H), 3.60 (6H, s, N-CH₃). ¹³C NMR (CD₃OD) δ : 161.3, 154.7, 139.7, 133.1, 129.5, 128.7, 128.2, 128.1, 73.9, 69.1, 67.6, 40.0. MS (FAB) m/z (%) 443 (100, MH⁺), 289 (29), 153 (77), 136 (56), 120 (16), 104 (21). Anal. Calcd for C₂₂H₂₆N₄O₆·0.5H₂O: C, 58.5; H, 6.0; N, 12.4. Found: C, 58.2; H, 6.2; N, 11.8.

3.5.2. 1,3-Bis{2-[2-(1-methyl-6-oxopyridazin-3-yloxy)-ethoxy]-ethoxymethyl}benzene (4b). R_f 0.56. Yield 32%; colourless oil. IR (CHCl₃) ν : 3070, 1670 (C=O), 1550; 1270, 1110 cm⁻¹. ¹H NMR (CD₃OD) δ : 7.34 (1H, s, 1-H), 7.30–7.26 (3H, m, 3,4,5-H), 7.13 (2H, d, $J=9$ Hz, 4'-H), 6.93 (2H, d, $J=9$ Hz, 5'-H), 4.54 (4H, s, 7-H), 4.30 (4H, m, α' -H), 3.82 (4H, m, β' -H), 3.71 (4H, m, α -H), 3.64 (4H, m, β -H), 3.62 (6H, s, N-CH₃). ¹³C NMR (CD₃OD) δ : 161.3, 154.7, 139.8, 133.1, 129.4, 128.7, 128.2, 128.1, 74.0, 71.7, 70.7, 70.1, 67.6, 40.0. MS (FAB) m/z (%) 531 (MH⁺, 27%), 154 (100), 136 (77), 120 (16), 104 (11). Anal. Calcd for C₂₆H₃₄N₄O₈·H₂O: C, 56.9; H, 6.6; N, 10.2. Found: C, 57.2; H, 6.6; N, 10.3.

3.5.3. 1,3-Bis(2-{2-[2-(1-methyl-6-oxopyridazin-3-yloxy)-ethoxy]-ethoxy}-ethoxymethyl)benzene (4c). R_f 0.51. Yield 64%; colourless oil. IR (CHCl₃) ν : 3080, 1670 (C=O), 1550; 1270, 1110 cm⁻¹. ¹H NMR (CD₃OD) δ : 7.34 (1H, s, 1-H), 7.31–7.26 (3H, m, 3,4,5-H), 7.14 (2H, d, $J=9$ Hz, 4'-H), 6.93 (2H, d, $J=9$ Hz, 5'-H), 4.54 (4H, s, 7-H), 4.28 (4H, m, α' -H), 3.81 (4H, m, β' -H), 3.66–3.55 (16H, m, γ' , γ , β , and α -H), 3.62 (6H, s, N-CH₃). ¹³C NMR (CD₃OD) δ : 161.3, 154.7, 139.9, 133.1, 129.4, 128.7, 128.3, 128.2, 74.0, 71.7, 70.7, 70.1, 67.7, 40.0. MS (FAB) m/z (%) 619 (27, MH⁺), 361 (10), 154 (100), 136 (80), 120 (16). Anal. Calcd for C₃₀H₄₂N₄O₁₀·H₂O: C, 56.6; H, 6.9; N, 8.8. Found: C, 56.3; H, 6.9; N, 8.7.

3.5.4. 1,3-Bis[2-(6-methylpyridazin-3-yloxy)-ethoxy-methyl]benzene (5a). R_f 0.39. Yield 55%; yellow oil. IR (CHCl₃) ν : 1600, 1550, 1270, 1040 cm⁻¹. ¹H NMR (CD₃OD) δ : 7.40 (2H, d, $J=9$ Hz, 5'-H), 7.36 (1H, s, 1-H), 7.27 (3H, m, 3, 4, 5-H), 7.09 (2H, d, $J=9$ Hz, 4'-H), 4.57 (4H, s, 7-H), 4.55 (4H, m, α' -H), 3.84 (4H, m, α -H), 2.53 (6H, s, CH₃). ¹³C NMR (CD₃OD) δ : 165.1, 156.7, 139.6, 132.5, 129.3, 128.5, 128.0, 119.8, 73.9, 69.3, 66.3, 20.7. MS (FAB) m/z (%) 411 (2, MH⁺), 273 (100), 153 (2), 137 (29), 110 (60). Anal. Calcd for C₂₂H₂₆N₄O₄·0.5H₂O: C, 63.0; H, 6.4; N, 13.4. Found: C, 62.7; H, 6.55; N, 14.1.

3.5.5. 1,3-Bis{2-[2-(6-methylpyridazin-3-yloxy)-ethoxy]-ethoxymethyl}benzene (5b). R_f 0.27. Yield 56%; colourless oil. IR (CHCl₃) ν : 1600, 1460, 1215 cm⁻¹. ¹H NMR (CD₃OD) δ : 7.46 (2H, d, $J=9$ Hz, 5'-H), 7.32 (1H, s, 1-H), 7.17 (3H, m, 3, 4, 5-H), 7.07 (2H, d, $J=9$ Hz, 4'-H), 4.52 (4H, s, 7-H), 4.57 (4H, m, α' -H), 3.86 (4H, m, β' -H), 3.68 (8H, m, β and α -H), 2.43 (6H, s, CH₃). ¹³C NMR (CD₃OD)

δ : 165.3, 156.8, 139.9, 132.5, 129.4, 128.4, 128.2, 119.8, 74.0, 71.7, 70.7, 70.4, 67.6, 20.9. MS (FAB) m/z (%) 499 (100, MH⁺), 317 (28), 301 (308), 153 (3), 137 (30), 111 (57). Anal. Calcd for C₂₆H₃₄N₄O₆·H₂O: C, 60.45; H, 7.0; N, 10.85. Found: C, 60.35; H, 6.85; N, 10.7.

3.5.6. 1,3-Bis(2-{2-[2-(6-methylpyridazin-3-yloxy)-ethoxy]-ethoxy}-ethoxymethyl)benzene (5c). R_f 0.25. Yield 75%; colourless oil. IR (CHCl₃) ν : 1600, 1460, 1215, 1100 cm⁻¹. ¹H NMR (CD₃OD) δ : 7.44 (2H, d, $J=9$ Hz, 5'-H), 7.36 (1H, s, 1-H), 7.22 (3H, m, 3, 4, 5-H), 7.06 (2H, d, $J=9$ Hz, 4'-H), 4.52 (4H, s, 7-H), 4.56 (4H, m, α' -H), 3.86 (4H, m, β' -H), 3.66 (16H, m, γ' , γ , β , and α -H), 2.54 (6H, s, CH₃). ¹³C NMR (CD₃OD) δ : 167.8, 156.9, 139.9, 132.5, 129.4, 128.4, 128.2, 119.8, 74.1, 71.7, 70.7, 70.4, 67.6, 20.9. MS (FAB) m/z (%) 587 (91, MH⁺), 361 (37), 345 (27), 153 (9), 137 (63), 111 (100). Anal. Calcd for C₃₀H₄₂N₄O₈·H₂O: C, 59.6; H, 7.3; N, 9.3. Found: C, 59.25; H, 7.4; N, 9.6.

3.6. Transport rates measurement

Transport experiments were performed at room temperature following a known procedure^{19,20} in a U-tube (9 mm, id). The membrane phase (3 mL of chloroform, Uvasol, Merck), in which the carrier is dissolved (7×10^{-4} mol L⁻¹), lay below and bridged the two aqueous phases. The first aqueous phase (1 mL) contains 5×10^{-5} mol L⁻¹ of LiOH, 10^{-1} mol L⁻¹ of alkali or ammonium nitrate, and 2×10^{-3} mol L⁻¹ of the corresponding alkali or ammonium picrate. The second aqueous phase contains 1 mL of deionized water. The membrane phase is slowly and constantly stirred by a magnetic bar. The picrate concentration in the second aqueous phase, monitored spectroscopically by UV ($\lambda=355$ nm), was confirmed to increase linearly with running time (<12 h) and the initial transport rates were calculated. In each case, a similar experiment was carried out in the absence of carrier. The values indicated in Table 3 were estimated from the differences in the transport rates of carrier-containing systems and blank systems (no carrier present). Dibenzo [18]crown-6 was taken as reference ligand, and it showed the following transport rates ($\mu\text{M h}^{-1}$): Na⁺ 22.5; K⁺ 198.2; Ca²⁺ 2.4; Phen 39.2; Ho 22.3; Do 3.1.

3.7. Molecular modelling

Molecular modelling studies were carried out using the AMBER²⁵ method implemented in the Hyperchem package.²⁶ The required parameters were extracted from the lit.^{16,27}

Ions are not separated far away and nor solvated in chloroform. Consequently, there is the need to use counterions. We have used the chloride anion in our calculations to mimic the picrate anion, as Wang et al.²⁸ used it and claimed that the cavities sizes of the hosts should not strongly depend on the anions used in the simulations, although the strength of interaction of the picrate anion with the environment is lesser than that of the chloride anion. In the absence of explicit solvent molecules, a constant dielectric factor qualitatively simulates the chloroform environment, as it is considered that intermolecular

electrostatic interactions should not die off fast with the distance, since chloroform has a low dielectric constant.

In all cases, geometries were minimized to a maximum energy gradient of 0.1 Kcal/Å mol using the Polak-Ribiere algorithm, and simulated annealing procedure was used to cover all conformational space running molecular dynamics at 400 K, with equilibration for 10 ps, followed by simulation for 45 ps with a time step of 1 fs. Trajectory frames were collected every 100 steps. A set of trajectory frames were selected on the basis of potential energy, with $\Delta E < 5$ kcal/mol. These selected trajectory frames were minimized until rms of 0.1 kcal/Å mol. To optimise host-guest interactions the amine hydrochloride was moved and docked into the cavity of the ligand, taking into account the structures showing stabilising interactions, such as hydrogen bonding or π -stacking, and also the conformational preferences of 2-phenylethylamines.²⁹ Three main approximation ways were chosen: the ammonium cationic head, the aromatic framework, and the ‘collapsed’ conformation. After that, the energy of the complex was minimized with no restrains.

Acknowledgements

The authors thank the Spanish Comision Interministerial de Ciencia y Tecnología for financial support given to this research work (SAF99-0063). We are also grateful to the contributions of the Centro de Resonancia Magnética Nuclear for determining the 1D NMR spectra and the Centro de Microanálisis of the Univ. Complutense de Madrid for elemental analyses.

References and notes

- (a) Hoffman, B. B.; Lefkowitz, R. J. In *Goodman and Gilman's the pharmacological basis of therapeutics*; Hardman, J. G., Limbird, L. E., Molinoff, P. B., Ruddon, R. W., Eds.; McGraw-Hill: New York, 1996; Chapters 10, 22 and 24. (b) Ligett, S. B. *Pharmacology* **2000**, *61*, 167–173. (c) Bock, M. G.; Patane, M. A. *Ann. Rep. Med. Chem.* **2000**, *35*, 221–230.
- Sidhu, A.; Laurelle, M.; Vernier, P. Dopamine receptors and transporters In *Neurological disease and therapy series*, Vol. 56; Marcel Dekker: New York, 2003.
- Klaassen, C. D.; O'Brien, C. P. In *Goodman and Gilman's the pharmacological basis of therapeutics*; Hardman, J. G., Limbird, L. E., Molinoff, P. B., Ruddon, R. W., Eds.; McGraw-Hill: New York, 1996; Chapters 4 and 24.
- (a) Psychotropic agents handbook. Remick, R., Burgmann, A., Thompson, D., Schieldrop, P., Eds.; IGR Publications (Canada), 2003. (b) Keitner, N. L.; Folks, D. G. Psychotropic drugs 4th ed.; Mosby (Elsevier), 2005.
- (a) Mortensen, O. V.; Amara, S. G. *Eur. J. Pharmacol.* **2003**, *479*, 159–170. (b) O'Shea, E.; Esteban, B.; Camarero, J.; Green, A. R. *Neuropharmacology* **2001**, *40*, 65–74. (c) Simantov, R. *Life Sci.* **2004**, *74*, 803–814. (d) Cole, J. C.; Sumnall, H. R. *Pharmacol. Ther.* **2003**, *98*, 35–58.
- Seiden, L. S.; Cleven, M. S. In *Methamphetamine and related drugs: toxicity and resulting behavioural changes in response to pharmacological probes*; Asghare, K., de Souza, E., Eds.; Pharmacology and toxicology of amphetamine and related designer drugs. National institute on drug abuse research monograph 94; US government printing office: Washington, DC, 1989; pp 146–160.
- (a) Behr, J. P.; Lehn, J.-M.; Vierling, P. *Helv. Chim. Acta* **1982**, *65*, 1853–1867. (b) Kimura, E.; Watanabe, A.; Kodama, M. *J. Am. Chem. Soc.* **1983**, *105*, 2063–2066. (c) Kimura, A.; Fujioka, H.; Kodama, M. *J. Chem. Soc., Chem. Commun.* **1986**, 1158–1159. (d) Hayakawa, H.; Kido, K.; Kanematsu, K. *J. Chem. Soc., Perkin Trans. 1* **1988**, 511–519.
- (a) Campayo, L.; Bueno, J. M.; Ochoa, C.; Navarro, P.; Jiménez-Barbero, J.; Pèpe, G.; Samat, A. *J. Org. Chem.* **1997**, *62*, 2684–2693. (b) Rodríguez-Franco, M. I.; San Lorenzo, P.; Martínez, A.; Navarro, P. *Tetrahedron* **1999**, *55*, 2763–2772.
- (a) Lamarque, L.; Miranda, C.; Navarro, P.; Escartí, F.; García-España, E.; Latorre, J.; Ramírez, J. A. *J. Chem. Soc., Chem. Commun.* **2000**, 1337–1338. (b) Lamarque, L.; Navarro, P.; Miranda, C.; Arán, V. J.; Ochoa, C.; Escartí, F.; García-España, E.; Latorre, J.; Luis, S. V.; Miravet, J. F. *J. Am. Chem. Soc.* **2001**, *123*, 10560–10570.
- (a) Herm, M.; Schrader, T. *Chem. Eur. J.* **2000**, *6*, 47–53. (b) Herm, M.; Molt, O.; Schrader, T. *Chem. Eur. J.* **2002**, *8*, 1485–1499. (c) Molt, O.; Rübelling, D.; Schrader, T. *J. Am. Chem. Soc.* **2003**, *125*, 12086–12087.
- Escuder, B.; Rowan, A. E.; Feiters, M. C.; Nolte, R. J. M. *Tetrahedron* **2004**, *60*, 291–300.
- (a) Behr, J. P.; Lehn, J. M.; Vierling, P. *J. Chem. Soc., Chem. Commun.* **1976**, 621–623. (b) Busmann, W.; Lehn, J. M.; Oesch, U.; Plumeré, P.; Simon, W. *Helv. Chim. Acta* **1981**, *64*, 657–661.
- (a) Domènech, A.; García-España, E.; Navarro, P.; Reviriego, F. *Talanta* **2000**, *51*, 625–636. (b) Reviriego, F.; Navarro, P.; Domènech, A.; García-España, E. *J. Chem. Soc., Perkin Trans. 2* **2002**, 1634–1638. (c) Reviriego, F.; Navarro, P.; Domènech, A.; García-España, E. *J. Supramol. Chem.* **2002**, *2*, 115–122.
- Sanz, A. M.; Navarro, P.; Gómez-Contreras, F.; Pardo, M.; Pèpe, G.; Samat, A. *Can. J. Chem.* **1998**, *76*, 1174–1179.
- Nichols, D. E. *Pharmacol. Ther.* **2004**, *101*, 131–181 and references cited herein.
- Campayo, L.; Pardo, M.; Cotillas, A.; Jauregui, O.; Yunta, M. J. R.; Cano, M. C.; Gómez-Contreras, F.; Navarro, P.; Sanz, A. M. *Tetrahedron* **2004**, *60*, 979–986.
- Meyer, E. A.; Castellano, R. K.; Diederich, F. *Angew. Chem., Int. Ed.* **2003**, *42*, 1210–1250, and references cited therein.
- (a) Janiak, C. *J. Chem. Soc., Dalton Trans.* **2000**, 3885–3896. (b) Hunter, C. H.; Lawson, K. R.; Perkins, J.; Urch, C. J. *J. Chem. Soc., Perkin Trans. 2* **2001**, 651–669.
- Navarro, P.; Pueyo, E.; Rodríguez-Franco, M. I.; Samat, A. *Tetrahedron* **1990**, *46*, 2917–2926.
- (a) Fierros, M.; Rodríguez-Franco, M. I.; Navarro, P.; Conde, S. *Bioorg. Med. Chem. Lett.* **1994**, *4*, 2523–2526. (b) Rodríguez-Franco, M. I.; Fierros, M.; Martínez, A.; Navarro, P.; Conde, S. *Bioorg. Med. Chem.* **1997**, *5*, 363–367.
- Hobza, P.; Kabelac, M.; Sponer, J.; Mejzlik, P.; Vondrasek, J. *J. Comput. Chem.* **1997**, *18*, 1136–1150.
- Zhang, X. X.; Bradshaw, J. S.; Izatt, R. M. *Chem. Rev.* **1997**, *97*, 3313–3361.
- Hunter, C. A.; Sanders, J. K. M. *J. Am. Chem. Soc.* **1990**, *112*, 5525–5534.
- Eichenberger, K.; Staeheling, A.; Druey, J. *Helv. Chim. Acta* **1954**, *37*, 837–840.

25. Cornell, W. D.; Cieplak, P.; Bayly, C.; Gould, I. R.; Merz, K. M.; Ferguson, D. M.; Spellmeyer, D. C.; Fox, T.; Caldwell, J. W.; Kollman, P. A. *J. Am. Chem. Soc.* **1995**, *117*, 5179–5197.
26. *Hyperchem 6.0*, Hypercube Inc.
27. (a) Jimenez, R.; Sanz, A. M.; Gomez-Contreras, F.; Cano, M. C.; Yunta, M. J. R.; Pardo, M.; Campayo, L. *Heterocycles* **2004**, *63*, 1299–1310. (b) Miranda, C.; Escartí, F.; Lamarque, L.; Yunta, M. J. R.; Navarro, P.; Garcia-España, E.; Jimeno, M. L. *J. Am. Chem. Soc.* **2004**, *126*, 823–833.
28. Wang, J.; Kollman, P. A. *J. Am. Chem. Soc.* **1998**, *120*, 11106–11114.
29. Urban, J. J.; Cronin, C. W.; Roberts, R. R.; Famini, G. R. *J. Am. Chem. Soc.* **1997**, *119*, 12292–12299.

Synthesis of novel C4-linked imidazole ribonucleoside phosphoramidites for probing general acid and base catalysis in ribozyme

Lisa Araki,^a Shinya Harusawa,^{a,*} Maho Yamaguchi,^a Sumi Yonezawa,^a Natsumi Taniguchi,^a David M. J. Lilley,^b Zheng-yun Zhao^b and Takushi Kurihara^a

^aOsaka University of Pharmaceutical Sciences, 4-20-1, Nasahara, Takatsuki, Osaka 569-1094, Japan

^bDepartment of Biochemistry, MSI/WTB Complex, University of Dundee, Dundee DD1 5EH, UK

Received 28 July 2005; accepted 13 September 2005

Available online 10 October 2005

Abstract—We describe the synthesis of novel C4-linked imidazole ribonucleoside phosphoramidite (PA) **1a** by which the imidazole moiety is incorporated into VS ribozyme to study its role in general acid and base catalysis. Investigation of protecting groups for the imidazole-*N* first indicated that pivaloyloxymethyl (POM) was adequate as an *N*-protecting group for the imidazole nucleoside, which could be readily removed under mild basic conditions. Further, the synthetic method was extended to synthesis of 2'-deoxy- and 2'-*O*-allyl nucleoside PAs **1b** and **1c**.

© 2005 Elsevier Ltd. All rights reserved.

1. Introduction

The VS ribozyme is the largest of a group of nucleolytic ribozymes that include hammerhead, hairpin, and HDV ribozymes, and catalyzes the site-specific cleavage of a phosphodiester linkage to generate products containing 2', 3'-cyclic phosphate and 5'-OH termini.¹ We recently indicated that the A730 loop of VS ribozyme was an important component of the active site in general acid and base catalysis (Fig. 1).² In particular, the adenine (A756) in the A730 loop is a critical base in the cleavage,³ because sequence variants at the position 756 are especially impaired in the cleavage and ligation activity. In these studies, we have used a trans-acting VS ribozyme, where a three-piece ribozyme-substrate system was used, as illustrated in Figure 1.

Been and co-workers previously reported a phenomenon called 'imidazole rescue': cleavage activity of the uracil-substituted mutant (α C76U) at the active site in HDV antigenomic ribozyme could be restored by addition of exogenous imidazole.⁴ This is probably due to rare circumstances in which the active site region of HDV is quite open to the solvent. By contrast, in the case of A756G

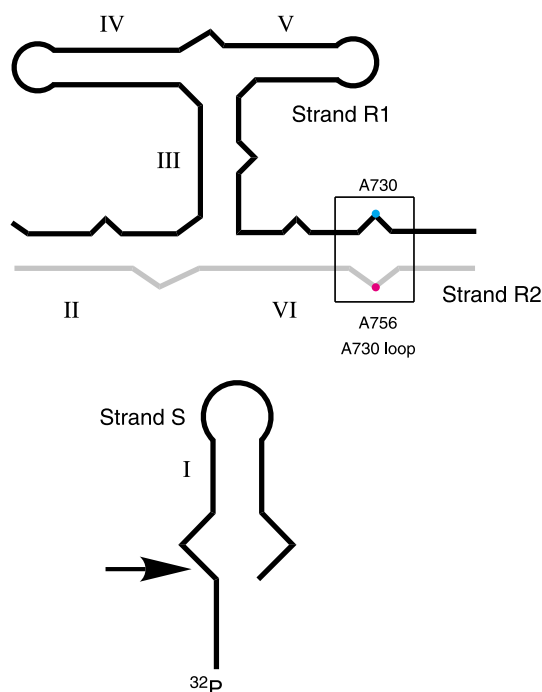

Figure 1. Schematic of a substrate and VS ribozyme, with helices numbered and the cleavage position arrowed. The trans-acting VS ribozyme was used in our studies where the substrate and ribozyme were separated. The A730 loop is boxed.

Keywords: Imidazole; Phosphoramidite; Ribozyme; POM; RNA.

* Corresponding author. Tel.: +81 72 690 1087; fax: +81 72 690 1086; e-mail: harusawa@gly.oups.ac.jp

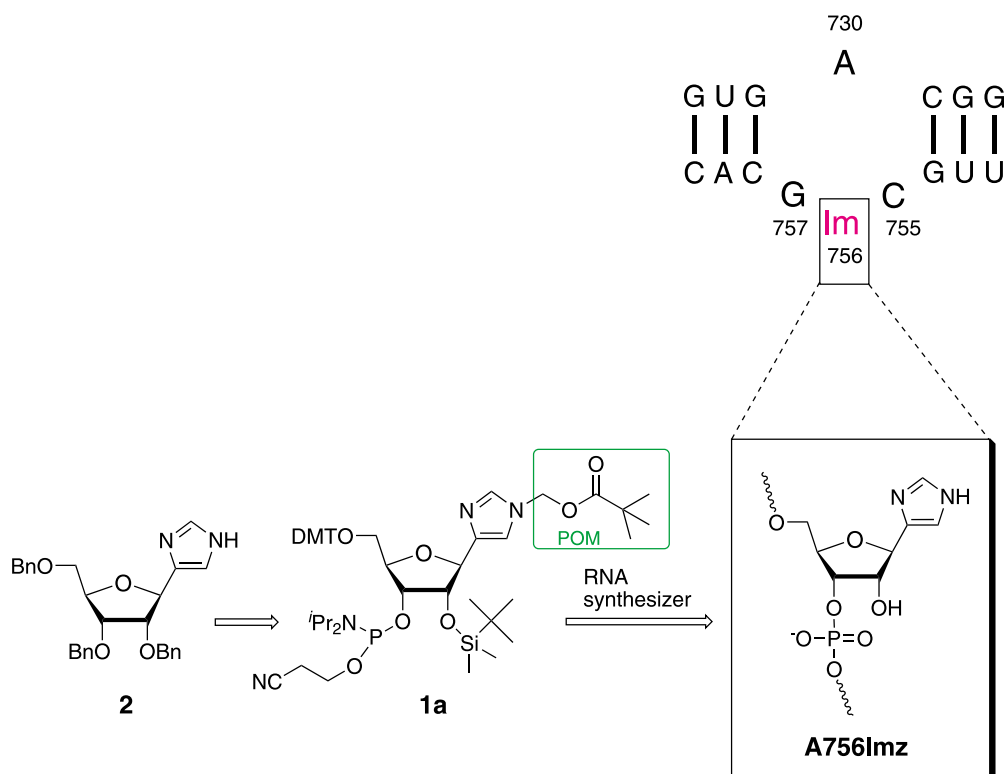

Figure 2. Incorporation of the imidazole into A756 of VS ribozyme using phosphoramidite **1a**.

or A756 abasic variants of VS ribozyme, addition of imidazole in the medium failed to restore the activity, possibly due to the fact that the active site is buried in a cliff between stem I and IV, therefore preventing free imidazole entering the active site.³

From these results, we have developed a new chemical strategy for determining the role of acid–base catalysis in a ribozyme function, in which C4-linked imidazole was placed into A756 of VS ribozyme covalently as a pseudonucleobase (Fig. 2).⁵ In this study, a novel C4-linked imidazole ribonucleoside phosphoramidite (PA) **1a** was subjected to a *t*BDMS approach of RNA automatic synthesis to provide an imidazole-substituted VS ribozyme (A756 Imz) in an average 99% coupling yield. The A756 Imz catalyzed the almost-complete cleavage of a substrate stem-loop at the correct position. Although the rate is slow ($K_{\text{obs}} = 0.01 \text{ min}^{-1}$), it was comparable to that of the uracil-substituted HDV ribozyme in the presence of exogenous imidazole.⁴ The result powerfully supported a direct role of the nucleobase at position 756 in the chemistry of natural VS ribozyme.⁵

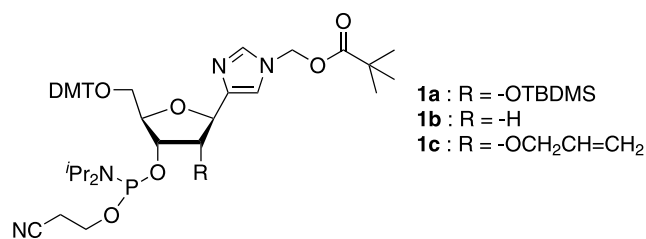

Figure 3. Novel C4-linked imidazole ribonucleoside PAs.

We herein describe the chemical synthesis of the imidazole ribonucleoside PA **1a**,⁶ which is a crucial building block in the construction of the imidazole-containing oligonucleotides, starting from 4(5)-2,3,5-tri-*O*-benzyl- β -ribofuranosylimidazole **2**.⁷ The key feature of the synthesis is the use of the pivaloyloxymethyl (POM) group as an efficient *N*-protecting group of imidazole. In connection with this study, 2'-deoxy-3'-*O*-PA **1b** and 2'-*O*-allylribonucleoside-3'-*O*-PA **1c** were synthesized, since removal of the 2'-hydroxy group from the ribose of A756 led to a small (10-fold slower) reduction in the rate of cleavage.³ (Fig. 3)

2. Results and discussion

2.1. An adequate protecting group for imidazole-*N* in the RNA synthesis

We reported an efficient and stereoselective synthesis of tri-*O*-benzyl- β -ribofuranosylimidazole **2**, 4(5)- β -D-ribofuranosylimidazole **3a**, its *N*^{im}-ethoxycarbonyl compound **3b**, which were useful intermediates to supply related nucleosides.^{7,8} First, 5'-*O*-dimethoxytritylation of non-protected or *N*^{im}-ethoxycarbonylated imidazole C-nucleosides (ICNs) **3a** or **3b** was attempted according to the ordinary PA synthesis.⁹ Although the ethoxycarbonyl group of imidazole-*N* could be removed by aqueous ammonia,^{7b} dimethoxytritylation of **3a** or **3b** failed to give the desired compounds (Scheme 1). Instability of 5'-*O*-dimethoxytrityl (DMT) products seems responsible for the failure, but the result emphasized the need for a suitable protecting group of imidazole-*N*.

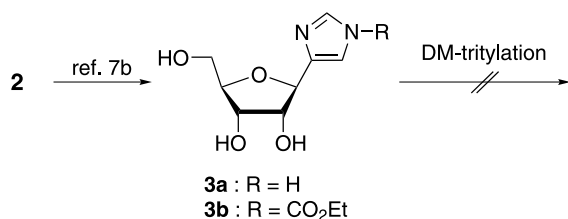

Scheme 1. Attempted direct tritylation of **3a** and **3b**.

Bergstrom et al.¹⁰ previously reported the synthesis of 2'-deoxy- β -ribofuranosylimidazole with *p*-nitrophenylethyl (PNPE)¹¹ as a protecting group at imidazole-*N*. They described that PNPE could be removed by treatment with DBU, but they did not give any experimental details. We thus examined whether the PNPE group at the imidazole-*N* could be easily removed by DBU in the ribo-situation. As a nitro group could be reduced under debenzoylation-condition such as catalytic hydrogenation, we assumed a protecting group, *p*-trifluoromethylphenylethyl group, which could be stable under such reductive conditions. Reaction of tribenzyl compound **2** with PNPE bromide afforded PNPE-protected ICN **4a** (86%) as an 8:1 isomeric mixture at the *N*^{im} position (**Scheme 2**). Treatment of **4a** with DBU (5 equiv) in acetonitrile at room temperature (rt) did not remove the PNPE group, but prolonged refluxing (20 h) of the reaction mixture gave **2** in only 22% yield. These results indicated that the PNPE group was not appropriate for protection of imidazole-*N* in the RNA synthesis. *p*-Trifluoromethylphenylethyl-protected ICN **4b** (36%) was similarly obtained from **2**, but reaction of **4b** with DBU was ineffective.

We envisaged the indispensable factors as a protecting group for imidazole-*N* in RNA synthesis by the *t*BDMS approach: (1) The factor, which might contribute to the

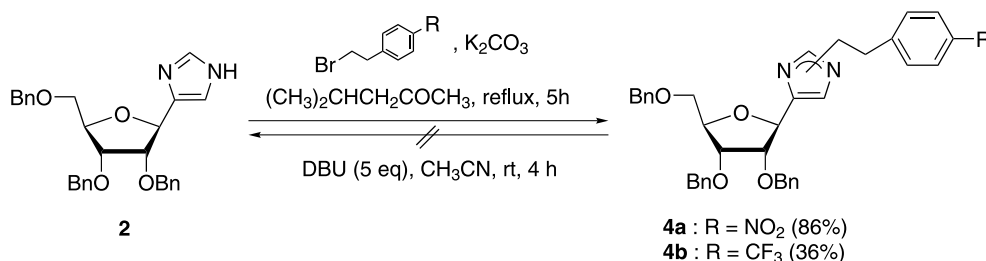

Scheme 2. Attempted imidazole *N*-protection and deprotection.

stability of the synthetic intermediates in the whole process via the building block **1a** from **2**. (2) The factor, which should be compatible with the deprotection-condition [28% aqueous ammonia–ethanol (3/1, v/v)] at the end of the solid-phase RNA synthesis by the *t*BDMS–phosphoramidite approach. (3) The factor, which could be tolerated under the debenzoylation-condition of 2',3',5'-tri-*O*-benzyl-*N*-protected ICNs **5**.^{7b} (4) Further, the factor which might increase the extraction and isolation of each synthetic intermediate. We investigated the protecting group from the viewpoint of the factors (2) and (3), and focused our attention on *p*-anisoyl (An),¹² 2,2,2-trichloroethoxycarbonyl (Troc),¹³ and the POM groups¹⁴ as candidates. They were introduced

into the imidazole-*N* of **2** via the corresponding chlorides to give **5a** (74%), **5b** (89%), and **5c** (94%) as single isomers (**Table 1**). The location of the protecting groups was tentatively assigned to be τ -nitrogen because *N*-acylation of the imidazole ring occurs regioselectively on the less-hindered τ -nitrogen.¹⁵ The substituents on the imidazole-*N* could be readily removed to give back **2** by aqueous ammonia–MeOH (1/3, v/v) at rt after 3 h in 73–92% yields.

Next, the protected imidazoles **5a–c** were evaluated under catalytic debenzoylation as shown in **Table 2**. Hydrogenolysis of **5a** (An) or **5b** (Troc) over Pd–C cleaved their *N*^{im}-substituted groups as well as benzyl groups to give a non-protected imidazole C-nucleoside **3a** (R¹, R², R³ = H, quant) (**Table 2**, entries 1 and 2). However, POM-protected imidazole **5c** interestingly maintained the POM group under the reduction conditions to give partial debenzoylated products **6** and **7** (**Table 2**, entry 3). Further, treatment of **5c** with Pd(OH)₂–C/cyclohexene in refluxing ethanol produced *N*-POM–ICN **8** in quantitative yield. Accordingly, the POM group satisfied the factors (2) and (3) required for the protecting group of imidazole-*N*.

Zaramella and co-workers recently reported a convenient method for positioning of the imidazole-protecting group, in which ¹H–¹⁵N heteronuclear multiple bond correlation (HMBC) in the NMR method was used for several histidine derivatives.¹⁶ We then applied the method to **8** to determine the location of the POM group at the τ -nitrogen: a ¹H(C1')/¹⁵N(τ) cross-peak could clearly be seen in ¹H–¹⁵N HMBC signals [δ (ppm) ¹⁵N (τ) 176.1, ¹⁵N (π) 247.1, and ¹H (C1') 4.66] (**Scheme 3**), since the signal of the substituted imidazole-*N* always appeared at lower chemical shift (δ) than that of the unsubstituted one.

The utility of the POM group may be pointed out in RNA

Table 1. Preparation of imidazole *N*-protected nucleosides

Entry	Reaction condition (equiv, h)	5 (%)	5 to 2 (%)
1	<i>p</i> -CH ₃ OC ₆ H ₄ COCl (1.1), ^t Pr ₂ NEt, pyridine, 1.5	5a , 74	73
2	Cl ₃ CCH ₂ OCOC(1.1), DMAP, benzene, 4	5b , 89	89
3	(CH ₃) ₃ CCO ₂ CH ₂ Cl (1.5), NaH, THF, 3	5c , 94	92

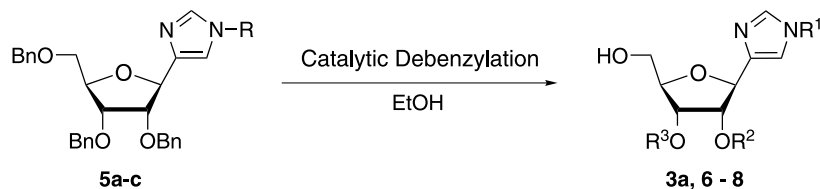
Table 2. Catalytic debenzoylation of *N*-protected imidazoles

Entry	Reaction conditions	Product	Yield (%)
1	5a (An), H ₂ /10% Pd-C (3 kg/cm ²), 16 h	3a , R ¹ , R ² , R ³ =H	Quant
2	5b (Troc), H ₂ /5% Pd-C (1 kg/cm ²), 6 h	3a , R ¹ , R ² , R ³ =H	Quant
3	5c (POM), H ₂ /10% Pd-C (3 kg/cm ²), 16 h	6 , R ¹ =POM, R ² , R ³ =Bn 7 , R ¹ =POM, R ² =H, R ³ =Bn or R ¹ =POM, R ² =Bn, R ³ =H	22 33
4	5c (POM), 20% Pd(OH) ₂ -C, cyclohexene, reflux, 3 h	8 , R ¹ =POM, R ² , R ³ =H	Quant

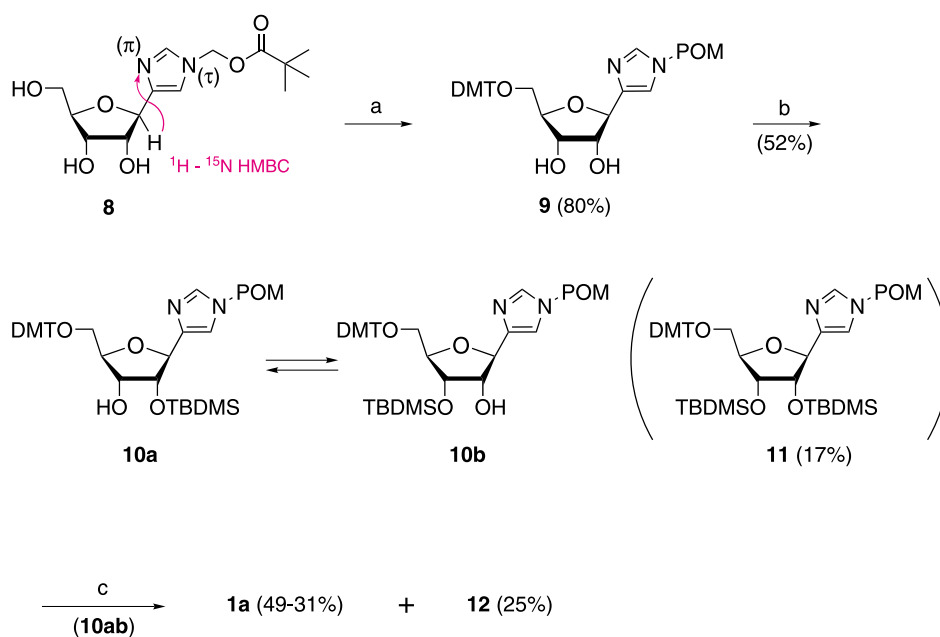
**Scheme 3.** Preparation of imidazole PA **1a**. Reagents and conditions: (a) DMTCl, Et₃N, cat. DMAP, pyridine; (b) TBDMSOTf, pyridine, -40 °C, MS 4 Å; (c) (tPr₂N)₂POCH₂CH₂CN, 4,5-DCl, ClCH₂CH₂Cl, 40 °C, 15 h.

automatic synthesis: (1) In the capping step, the unreacted 5'-hydroxy group is acetylated with acetic anhydride to prevent the growing oligonucleotide chain with a nucleoside deletion,⁹ whereas activated *N*^{im}-carbonyl groups (as in **5a,b**) may be susceptible to potential exchange-reactions at this stage, leading to complexities. (2) Base-protecting groups are conventionally removed in the final step of RNA synthesis by an ammonia and ethanol mixture [28% aqueous NH₃-EtOH (3/1, v/v)] at 60 °C for 16 h. As the POM group can be removed under faster and milder conditions, it is particularly attractive to sensitive RNA such as Cy5 labelled RNA where deprotection is recommended at rt to minimize the destruction of cyanine dye. Obviously, the very mild conditions require other bases to be protected with more labile groups such as PAC or TAC for RNA monomers A, G, and C. Hence, the *N*-POM group is the most suitable and practical protecting group for the imidazole RNA.

2.2. Synthesis of imidazole ribonucleoside PA **1a**

5'-*O*-DMT-2'-*O*-*tert*-butyldimethylsilyl(TBDMS)-3'-*O*-cyanoethyl-diisopropylphosphoramidite **1a** was synthesized in three steps from the *N*-POM-imidazole **8** (Scheme 3). After DM-tritylation of **8**, 5'-*O*-DMT-ribonucleoside **9** (80%) was isolated immediately through a basic silica gel bed, because the DMT group of **9** was removed by neutral or standard silica gel chromatography. In this note, the basic silica gel was used for the purification and isolation of the labile compounds containing the DMT group. Although the silylation reaction of the 2'-hydroxy group can be controlled to some extent by using AgNO₃ as an additive,¹⁷ silylation of **9** with TBDMSOTf did not proceed in the presence of AgNO₃ and pyridine in THF. On the other hand, treatment of **9** with TBDMSOTf in pyridine led to an inseparable 1:1 mixture **10ab** (52%) of 2'-*O*-TBDMS and 3'-*O*-TBDMS isomers, together with a 2',3'-bis-*O*-substituted derivative

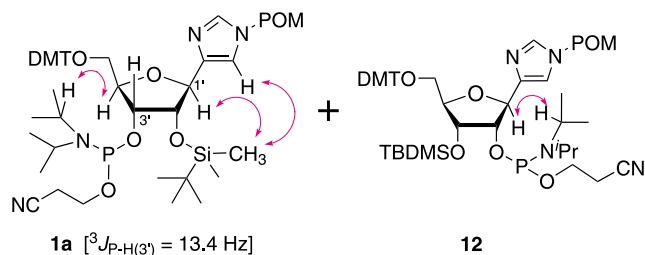
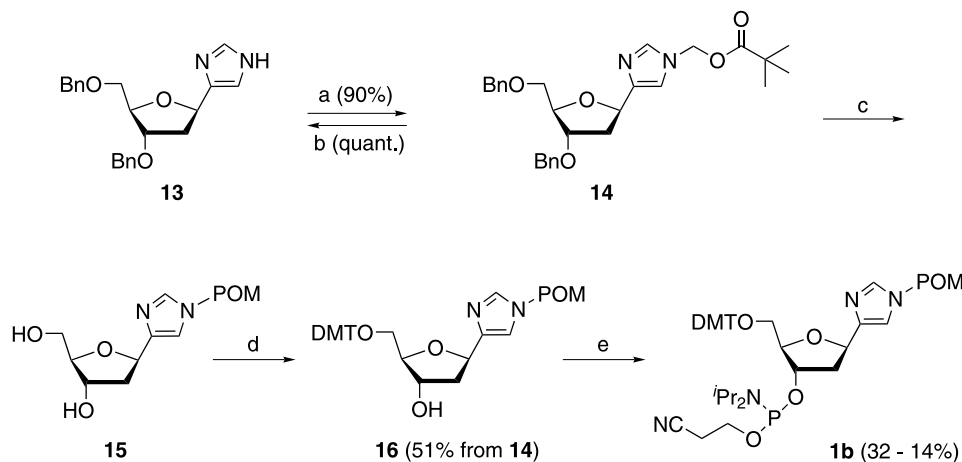

Figure 4. The NOESY experiments of phosphoramidites **1a** and **12**. Arrows indicate interactions between sets of two protons.

11 (17%). Unfortunately, since the TBDMS group readily migrated between the 2'- and the 3'-hydroxy function, the desired 2'-protected ribonucleoside **10a** was not separated as a stable compound.¹⁸ Thus, the mixture **10ab** was subjected to phosphitylation. Treatment of **10ab** with 2-cyanoethyl *N,N,N',N'*-tetraisopropylphosphoramidite in the presence of diisopropylammonium tetrazolide (DIPT) in dichloromethane at rt (90 h) generated 3'- and 2'-phosphoramidites **1a** and **12** in low yields. Alternatively, use of 4,5-

dicyanoimidazole (DCI) as an activator and heating at 40 °C for 15 h in 1,2-dichloroethane improved the reaction to provide **1a** and **12** in the range of 49–31 and 25% yields, respectively. Since the final phosphoramidite **1a** was decomposed on a standard TLC plate (Merck 60 F₂₅₄), the purification of the crude product was not straightforward. However, further efforts clarified that the phosphoramidite **1a** could be purified by a basic preparative TLC plate.

The stereochemical assignment of phosphoramidites **1a** and **12** was indicated by the observation of an NOESY between the C1' and Si-Me protons of **1a**, as illustrated in Figure 4, while NOE enhancement between C1' and NCHMe₂ protons in **12** was observed. It was further supported by observation of a $^3J_{P-H}$ (C3') coupling constant [$^3J_{P-H(C3')} = 13.4$ Hz] with the aid of the 31P -decoupled 1H NMR spectrum of **1a** [31P NMR: δ 148.9 ppm (CD₃CN) as a singlet-like peak for two P-diastereoisomers]. Although MS measurement of PAs has been problematic owing to their labile properties, we have very recently found that the accurate molecular weight (MW) of PAs may be generally



Scheme 4. Preparation of imidazole PA **1b**. Reagents and conditions: (a) NaH, POMCl, rt; (b) 28% NH₃-MeOH (1/4, v/v), rt, 3 h; (c) 20% Pd(OH)₂-C, cyclohexene, EtOH, reflux, 3 h; (d) DMTCl·Et₃N, DMAP (cat.), py, rt; (e) (*i*-Pr₂N)₂POCH₂CH₂CN, DIPT, 40 °C, 46 h.

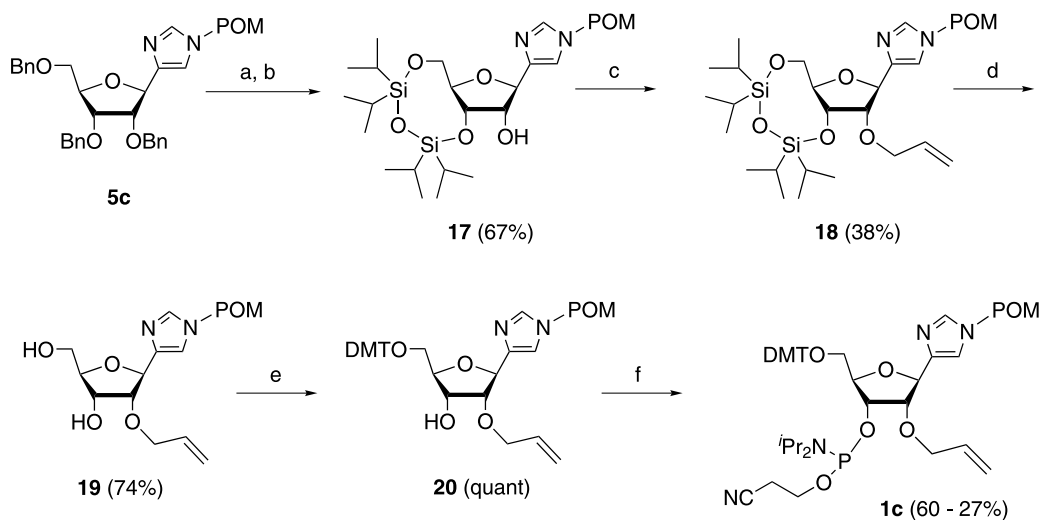

Scheme 5. Preparation of imidazole 2'-allyl ribonucleoside PA **1c**. Reagents and condition: (a) Table 2, entry 4; (b) TIPDSCl₂, 0 °C then py, rt, 3 h; (c) allyl ethyl carbonate, Pd₂(dba)₃, Ph₃P, reflux, 15 h; (d) HF, TMEDA, 0 °C then rt, 2.5 h; (e) DMTCl, Et₃N, DMAP (cat.), py, rt, 19 h; (f) (*i*-Pr₂N)₂POCH₂CH₂CN, 4, 5-DCl, rt, 24 h.

determined by using a suitable matrix system, triethanolamine (TEOA)–NaCl, on liquid secondary ion (LSI) MS equipped with a double-focusing mass spectrometer. The present method successfully revealed the molecular-related ion $[M+Na]^+$ of **1a** at m/z 953.4625, leading to the composition formula ($C_{50}H_{71}N_4O_9PSi$).¹⁹ Purified imidazole phosphoramidite **1a** was stored for several months at -20°C to check its long-term stability, but ^{31}P and ^1H NMR measurements of the stored compound did not show any substantial decomposition.

2.3. Synthesis of 2'-deoxy- and 2'-O-allyl nucleoside PAs **1b** and **1c**

The synthetic method using POM protection of imidazole-*N* was extended to the preparation of 2'-deoxy- and 2'-*O*-allyl imidazole C-nucleoside PAs **1b** and **1c** (Schemes 4 and 5). It is noted that 2'-*O*-allyl nucleosides are potent antisense molecules because of their high nuclease resistance.²⁰ The imidazole-*N* of 3',5'-di-*O*-benzyl-2'-deoxy-D-ribonucleosides **13**^{7b} was analogously protected by the POM group to give 3',5'-di-*O*-benzyl-*N*-protected ICN **14** (90%). Subsequent debenzoylation followed by DM-tritylation gave 5'-*O*-DMT-2'-deoxyribonucleoside **16** (51%). Phosphitylation of **16** produced the fully protected 2'-deoxy nucleoside PA **1b** (32–14%). The moderate yield of **1b** was due to isolation problems caused by column chromatography. The feasibility of **1b** as a protecting group of the *N*^{im}-POM group on 2'-deoxy-D-ribonucleosides was examined by restoration of *N*-protected imidazole **14** into unsubstituted imidazole **13** in aqueous ammonia–MeOH.

For the synthesis of 2'-*O*-allyl imidazole C-nucleoside PAs **1c**, 3',5'-*O*-TIPDS-protection (TIPDS = 1,1,3,3-tetraisopropylidisiloxanediy) was carried out to give **17** (67%), starting from tribenzylated POM–ICN **5c** (Scheme 5), as the regioselective formation for 2'-*O*-allyl ribonucleosides had been reported.^{21a} Palladium-catalyzed allylation^{21a,b} of the 2'-hydroxy group of **17** produced a 2'-*O*-allyl compound **18** (38%). Desilylation of **18** gave a 3', 5'-dihydroxy compound **19** (74%). Further, DM-tritylation (quant) followed by phosphitylation provided the desired 2'-*O*-allyl nucleoside PA **1c** (60–27%).

3. Conclusion

A novel C4-linked ICN PA **1a** was designed and synthesized starting from tribenzylribofuranosylimidazole **2**. The imidazole PA enabled incorporation of the imidazole moiety into VS ribozyme in order to elucidate its roles in the general acid and base catalysis of ribozyme. In the synthetic study, POM was first introduced as a protecting group of imidazole-*N* and it could be readily removed under mild basic conditions. Further, the imidazole nucleoside **1a** places the base at the natural C1-atom, while other modified nucleosides with imidazole attached to the nucleobase have been reported.²² As the imidazole base may be incorporated at any site in an RNA sequence using **1a**, the present approach would be applied to other situations in which nucleobase participation is suspected. 2'-Deoxy and 2'-*O*-allyl analogues **1b** and **1c** could be applicable to insert the imidazole into modified DNA and RNA oligonucleotides.

Further work on application of the imidazole oligonucleotides is under way and will be published in due course.

4. Experimental

4.1. General

The melting points were determined on a hot-stage apparatus and are uncorrected. IR spectra were recorded on a Shimadzu IR-435 spectrometer. ^1H and ^{13}C NMR spectra were taken with tetramethylsilane as an internal standard on a Varian Gemini-200, Varian Mercury-300, and Varian UNITY INOVA-500 spectrometers. Reactions with air- and moisture-sensitive compounds were carried out under an argon atmosphere. Unless otherwise noted, all extracts were dried over Na_2SO_4 , and the solvent was removed in a rotary evaporator under reduced pressure. Unless otherwise stated, Fuji Silysia FL-60D silica gel, Fuji Silysia BW-127ZH silica gel, and Merck 60 F₂₅₄ were used for flash column chromatography, column chromatography and thin-layer chromatography (TLC), respectively. As for the basic (N–H) silica gel, Chromatorex NH-DM 1020 (Fuji Silisia Chemical Ltd) was used. The accurate molecular weight measurements of nucleoside PAs **1a**, **1b**, and **1c** were determined by MS spectrometry using a novel matrix system, triethanolamine (TEOA)–NaCl, on LSIMS equipped with a double-focusing MS spectrometer.¹⁹

4.1.1. 4(5)-(2,3,5-Tri-*O*-benzyl- β -D-ribofuranosyl)-1-[2-(4-nitrophenyl)ethyl]imidazole (4a**).** To a solution of **2** (81 mg, 0.17 mmol) in 4-methyl-2-pentanone (0.5 ml) was added a solution of *p*-nitrophenethyl bromide (56 mg, 0.24 mmol) in 4-methyl-2-pentanone (0.5 ml) followed by potassium carbonate (50 mg, 0.36 mmol). The resulting mixture was refluxed for 5 h and then evaporated. The residue was dissolved with EtOAc and the resulting solution was washed with water, brine. The organic layers were dried, and evaporated. The crude oil was purified by flash column chromatography [80% EtOAc in hexane] to give **4a** (90 mg, 86%) as a colorless oil; IR (film, cm^{-1}) 1600, 1510, 1450, 1345 (NO_2); ^1H NMR (CDCl_3) δ 2.95 (t, 6/4H, $J=7.2$ Hz), 3.09 (t, 2/4H, $J=7.2$ Hz), 3.50 (dd, 1H, $J=9.5$, 3.8 Hz), 3.77 (dd, 1H, $J=9.5$, 3.8 Hz), 3.98 (t, 2H, $J=3.6$ Hz), 4.02–4.72 (m, 8H), 4.96 (d, 1/4H, $J=6.5$ Hz), 5.10 (d, 3/4H, $J=3.8$ Hz), 6.86 (s, 1H), 7.08 (d, 2H, $J=8.6$ Hz), 7.15 (s, 1H), 7.25–7.35 (m, 15H), 8.08 (d, 2H, $J=8.6$ Hz); HRMS(EIMS) calcd for $\text{C}_{37}\text{H}_{37}\text{N}_3\text{O}_6$ [(M)⁺]: 619.2680, found 619.2681.

4.1.2. 4(5)-(2,3,5-Tri-*O*-benzyl- β -D-ribofuranosyl)-1-[2-(4-trifluoromethylphenyl)ethyl]imidazole (4b**).** The same procedure (**4a**) was used for the preparation of **4b** (44 mg, 36%, a colorless oil) from **2** (90 mg, 0.19 mmol); ^1H NMR (CDCl_3) δ 2.92 (t, 6/4H, $J=6.8$ Hz), 3.05 (t, 2/4H, $J=7.2$ Hz), 3.62 (dd, 1H, $J=10.3$, 3.5 Hz), 3.76 (dd, 1H, $J=10.3$, 3.5 Hz), 3.97 (t, 2H, $J=6.8$ Hz), 4.02–4.68 (m, 9H), 4.98 (d, 1/4H, $J=6.8$ Hz), 5.10 (d, 3/4H, $J=3.5$ Hz), 6.85 (s, 1H), 7.07 (d, 2H, $J=7.2$ Hz), 7.12–7.39 (m, 16H), 7.48 (d, 2H, $J=7.2$ Hz).

Conversion of **4a into **2**.** A mixture of **4a** (45 mg, 0.07 mmol) and DBU (56 mg, 0.37 mmol) in acetonitrile

(2 ml) was refluxed for 20 h. After cooling, acetic acid (28 mg) was then added. The reaction mixture was evaporated to give a residue, which was subsequently dissolved in CH_2Cl_2 . The organic layer was washed with water, dried over anhydrous MgSO_4 , and evaporated to give a residue. Chromatography using EtOAc in hexane (60–100%) gave a mixture (colorless oil, 37 mg), showing ca. 1:3 ratio of **2** (22%) and **4a** (65%) from ^1H NMR.

4.1.3. 4-(2,3,5-Tri-*O*-benzyl- β -D-ribofuranosyl)-1-(4-methoxybenzoyl)imidazole (5a). To a mixture of **2** (101 mg, 0.22 mmol) and diisopropylethylamine (56 mg, 0.43 mmol) in pyridine (1 ml) was added *p*-anisoyl chloride (74 mg, 0.43 mmol) in pyridine (1 ml). The resulting mixture was stirred for 1.5 h and then evaporated to give a residue, which was subsequently diluted with EtOAc. The organic layer was washed with 1.5 N HCl followed by brine. The organic layers were dried, and evaporated. The resulting crude oil was purified by flash column chromatography on silica gel using 50% EtOAc in hexane to give compound **5a** (96 mg, 74%) as a colorless oil; ^1H NMR (CDCl_3) δ 3.61 (dd, 1H, $J=10.3$, 4.8 Hz), 3.70 (dd, 1H, $J=10.3$, 4.0 Hz), 3.88 (s, 3H), 4.06 (t, 1H, $J=5.6$ Hz), 4.25 (t, 1H, $J=4.8$ Hz), 4.33 (dt, 1H, $J=5.6$, 4.0 Hz), 4.47–4.69 (m, 6H), 5.11 (d, 3/4H, $J=4.0$ Hz), 6.98 (d, 2H, $J=9.1$ Hz), 7.21–7.35 (m, 15H), 7.48 (s, 1H), 7.76 (d, 2H, $J=9.1$ Hz), 8.09 (d, 2H, $J=1.4$ Hz); HRMS(EIMS) calcd for $\text{C}_{37}\text{H}_{36}\text{N}_2\text{O}_6$ [(M) $^+$]: 604.2571, found 604.2571.

4.1.4. 2,2,2-Trichloroethyl 4-(2,3,5-tri-*O*-benzyl- β -D-ribofuranosyl)imidazole-1-carboxylate (5b). A mixture of **2** (57 mg, 0.12 mmol), trichloroethoxycarbonyl chloride (29 mg, 0.13 mmol), pyridine (12 mg, 0.16 mmol), and a catalytic amount of 4-DMAP (1 mg) in benzene (3.5 ml) was stirred for 3 h. After H_2O (0.5 ml) was added to the mixture, the solvent was evaporated to give a residue, which was subsequently dissolved with EtOAc. The organic layer was washed with water, brine, dried, and evaporated to give a crude oil. It was purified by flash column chromatography using 20% EtOAc in hexane to give **5b** (69 mg, 89%) as a colorless oil; ^1H NMR (CDCl_3) δ 3.60 (dd, 1H, $J=10.9$, 4.3 Hz), 3.70 (dd, 1H, $J=10.9$, 3.9 Hz), 4.05 (t, 1H, $J=5.8$ Hz), 4.21 (t, 1H, $J=4.8$ Hz), 4.32 (dt, 1H, $J=5.8$, 4.3 Hz), 4.45–4.65 (m, 6H), 4.91 (d, 1H, $J=11.6$ Hz), 5.00 (d, 1H, $J=11.6$ Hz), 5.07 (d, 1H, $J=4.8$ Hz), 7.18–7.36 (m, 15H), 7.44 (s, 1H), 8.12 (s, 1H).

4.1.5. [4-(2,3,5-Tri-*O*-benzyl- β -D-ribofuranosyl)imidazolyl]methyl 2,2-dimethylpropionate (5c). Under stirring, 60% NaH (72 mg, 1.80 mmol) in mineral oil was added to THF (7 ml) to give a suspension. A solution of **2** (562 mg, 1.20 mmol) in THF (3 ml) was added to the suspension, and the resulting mixture was stirred at rt for 3 h. Then, a solution of chloromethyl pivaloate (271 mg, 1.80 mmol) in THF (8 ml) was added. After 1 h, H_2O (0.5 ml) was added and the whole was evaporated to give a residue, which was subsequently dissolved with EtOAc. The organic layer was washed with water, brine, dried, and evaporated. The crude product was purified by flash column chromatography on silica gel using 50% EtOAc in hexane to give compound **5c** (654 mg, 94%) as a colorless oil; ^1H NMR (CDCl_3) δ 1.15 (s, 9H), 3.63 (dd, 1H, $J=7.3$, 3.1 Hz), 3.71 (dd, 1H, $J=7.3$, 3.1 Hz), 4.03 (t, 1H, $J=3.1$ Hz), 4.20 (t, 1H, $J=2.9$ Hz),

4.26 (m, 1H), 4.44–4.67 (m, 6H), 5.06 (d, 1H, $J=2.9$ Hz), 5.64 (dd, 1H, $J=19.5$, 7.3 Hz), 7.03 (s, 1H), 7.21–7.38 (m, 15H), 7.61 (s, 1H).

Conversion of 5c into 2. A mixture of **5c** (20 mg, 0.04 mmol) in methanol (1.5 ml) and 28% aqueous NH_3 (0.5 ml) was stirred 3 h at rt. After evaporation, the resulting residue was purified by flash column chromatography using AcOEt to give **2** (15 mg, 92%) as a colorless oil. By the same procedure, **5a** and **5b** were converted into **2** in 74 and 89% yields, respectively.

Catalytic debenzoylation of 5a (Table 2, entry 1). A solution of **5a** (52 mg, 0.09 mmol) in EtOH (8 ml) was hydrogenated over 10% Pd on carbon²³ (35 mg) at 3.0 kg/cm² for 16 h. After filtration through Celite, the filtrate was evaporated to give a residue, which was purified by column chromatography to give **3a**^{7b} (17 mg, quant).

Catalytic debenzoylation of 5b (Table 2, entry 2). By the same procedure as above (Table 2, entry 1), **5b** (30 mg, 0.05 mmol) in EtOH (5 ml) was hydrogenated over 5% Pd on carbon²³ (20 mg) at 1.0 kg/cm² for 6 h to give **3a**^{7b} (10 mg, quant).

Catalytic debenzoylation of 5c (Table 2, entry 3). By the same procedure as above (Table 2, entry 1), **5c** (36 mg, 0.06 mmol) in EtOH (6 ml) was hydrogenated over 5% Pd on carbon²³ (25 mg) at 3.0 kg/cm² for 16 h to give **6** (7 mg, 22%) and **7** (8 mg, 33%).^{7b}

4.1.6. [4-(β -D-Ribofuranosyl)imidazolyl]methyl 2,2-dimethylpropionate (8) (Table 2, entry 4). A mixture of **5c** (206 mg, 0.35 mmol), 20% Pd(OH)₂-C²³ (124 mg), and cyclohexene (1.1 ml, 10.56 mmol) in EtOH (10 ml) was refluxed for 3 h. After filtration through Celite, the filtrate was evaporated to give a residue, which was purified by column chromatography [MeOH–EtOAc (1/20)] to give **8** (111 mg, quant) as a colorless oil; ^1H NMR (CD_3OD) δ 1.18 (s, 9H), 3.52–4.19 (m, 5H), 4.66 (d, 1H, $J=5.4$ Hz), 6.02 (s, 2H), 7.45 (s, 1H), 8.36 (s, 1H). LSIMS *m/z*: 315 [(M+H) $^+$]. The τ positioning of POM group on the imidazole ring was determined by means of a ^1H – ^{15}N HMBC experiment [conditions: 25 °C, 499.7 MHz for ^1H and 50.7 MHz for ^{15}N ; δ (ppm) relative to external DMF (103.2 ppm)]; ^1H – ^{15}N HMBC (CD_3OD) δ 176.1 [^{15}N (τ)], 247.1 [^{15}N (π)], and the cross peak coordinate 247.1/4.66 [$^1\text{H}(\text{C}1')$].¹⁶

4.1.7. [4-(5-*O*-DMT- β -D-ribofuranosyl)imidazolyl]methyl 2,2-dimethylpropionate (9). Compound **8** (111 mg, 0.35 mmol) was coevaporated with pyridine (2 ml) three times and redissolved in pyridine (2 ml) again. DMTCl (188 mg, 0.51 mmol), Et₃N (0.07 ml, 0.51 mmol), and DMAP (1 mg, 0.01 mmol) were added to the pyridine solution of **8**. After the mixture was stirred overnight, methanol (1 ml) was added to the reaction mixture. The solvent was removed to give a residue, which was purified through NH-silica gel bed with chloroform to give compound **9** (174 mg, 80%) as white amorphous product; ^1H NMR (CD_3OD) δ 1.09 (s, 9H), 3.15–3.38 (overlapped with CD_3OD), 3.76 (s, 6H), 3.99–4.13 (m, 3H), 4.79 (d, 1H, $J=5.3$ Hz), 5.73–5.92 (m, 2H),

6.82 (d, 4H, $J=8.3$ Hz), 7.12–7.49 (m, 10H), 7.81 (s, 1H); LSIMS m/z 617 [(M+1)⁺].

4.1.8. [4-(5-*O*-DMT-2(3)-*O*-TBDMS- β -*D*-ribofuranosyl)imidazolyl]methyl 2,2-dimethylpropionate (10ab). Compound **9** (314 mg, 0.51 mmol) was coevaporated with pyridine (2 ml) three times and dissolved in pyridine (5 ml) again. TBDMSOTf (0.13 ml, 0.56 mmol) was added to a solution of **9** at -40°C . The reaction mixture was stirred for 5 min and then evaporated. The crude product was chromatographed by NH-silica gel chromatography using gradient solvent system [20–30% EtOAc in hexane] to give compound **11** (33 mg, 8%) and **10ab** (250 mg, 67%) in that order. **Compound 10ab.** A pale yellow amorphous product; ^1H NMR (CDCl_3) δ 0.00 (s, 3H), 0.06 (s, 3H), 0.88 (s, 9H), 1.16 (s, 9H), 2.70 (m, 1H), 3.16 (dd, 1/3H, $J=11.0$, 4.3 Hz), 3.25 (dd, 2/3H, $J=11.0$, 4.3 Hz), 3.37 (dd, 1/3H, $J=11.0$, 3.1 Hz), 3.38 (dd, 2/3H, $J=11.0$, 3.1 Hz), 3.78 (s, 6H), 4.07 (m, 2/3H), 4.24 (m, 2/3H), 4.46 (t, 1H, $J=4.3$ Hz), 4.76 (d, 2/3H, $J=5.1$ Hz), 4.82 (d, 1/3H, $J=5.1$ Hz), 5.73 (q, 2H, $J=10.2$ Hz), 6.80 (d, 4H, $J=10.2$ Hz), 7.08 (s, 2/3H), 7.12 (s, 1/3H), 7.16–7.52 (m, 9H), 7.62 (s, 1H); HRMS(EIMS) calcd for $\text{C}_{41}\text{H}_{54}\text{N}_2\text{O}_8\text{Si}$ [(M)⁺] 730.3647, found 730.3649. **Compound 11.** A pale yellow amorphous; ^1H NMR (CDCl_3) δ -0.10 (s, 3H), -0.08 (s, 3H) -0.04 (s, 6H), 0.79 (s, 9H), 0.82 (s, 9H), 1.10 (s, 9H), 3.18 (dd, 1H, $J=10.3$, 4.5 Hz), 3.37 (dd, 1H, $J=10.3$, 4.5 Hz), 3.76 (s, 6H), 4.04 (t, 1H, $J=4.3$ Hz), 4.09 (m, 1H), 4.22 (t, 1H, $J=4.3$ Hz), 4.84 (d, 1H, $J=4.3$ Hz), 5.61 (d, 1H, $J=10.8$ Hz), 5.72 (d, 1H, $J=10.8$ Hz), 6.80 (d, 4H, $J=9.0$ Hz), 7.08 (s, 1H), 7.14–7.51 (m, 9H), 7.59 (s, 1H).

4.1.9. {4-[5-*O*-DMT-2-*O*-TBDMS-3-*O*-(2-*CE-N,N*-diisopropylphosphoramidite)- β -*D*-ribofuranosyl]imidazolyl}methyl 2,2-dimethylpropionate (1a) and {4-[5-*O*-DMT-3-*O*-TBDMS-2-*O*-(2-*CE-N,N*-diisopropylphosphoramidite)- β -*D*-ribofuranosyl]imidazolyl}methyl 2,2-dimethylpropionate (12). Compound **10ab** (93 mg, 0.13 mmol) was coevaporated with dichloroethane (2 ml) three times and dissolved in dichloroethane (1.5 ml) again. To the solution was added 4,5-DCI (19 mg, 0.16 mmol) and 2-cyanoethyl *N,N,N',N'*-tetraisopropylphosphodiamidite (0.09 ml, 0.26 mmol). The resulting mixture was stirred at 40°C for 15 h and then evaporated. The residual oil was chromatographed (25% EtOAc in hexane) by NH-silica gel chromatography to give partially purified **12** (25%) and **1a** (49%) in that order. The desired PA **1a** was further carefully purified on a preparative NH-TLC with 50% EtOAc in hexane to give **1a** (37 mg, 31%), while PA **12** remained without further purification owing to its instability. **Compound 1a.** A white foam; $R_f=0.69$ (50% EtOAc/hexane); ^1H NMR (500 MHz, CDCl_3) δ -0.09 (s, 3H), -0.03 (s, 3H), 0.82 (s, 9H), 1.00 (d, 6H, $J=7.0$ Hz), 1.14 (s, 9H), 1.16 (d, 6H, $J=7.0$ Hz), 2.55–2.68 (m, 2H), 3.16 (dd, 1H, $J=10.0$, 4.0 Hz), 3.40 (dd, 1H, $J=10.0$, 5.0 Hz), 3.52–3.60 (m, 2H), 3.78 (s, 6H), 3.82–3.88 (m, 1H), 3.90–3.96 (m, 1H), 4.21 (t, 3/2H, $J=3.5$ Hz), 4.49 (t, 1/2H, $J=3.0$ Hz), 4.49 (dd, 1H, $J=7.0$, 4.0 Hz), 4.80 (d, 1H, $J=7.0$ Hz), 5.69 (d, 1H, $J=10.5$ Hz), 5.75 (d, 1H, $J=10.5$ Hz), 6.79 (dd, 4H, $J=9.0$ Hz), 7.11 (d, 1H, $J=2.5$ Hz), 7.16–7.20 (m, 1H), 7.26–7.28 (m, 3H), 7.39 (dd, 3H, $J=6.0$ Hz), 7.49–7.52 (m, 2H), 7.62 (d, 1H, $J=1.5$ Hz); ^{13}C NMR

(CDCl_3) δ -4.8 , -4.7 , 18.2, 20.4, 24.5, 24.6, 24.6, 24.7, 25.9, 26.9, 27.0, 29.7, 38.7, 42.8, 42.9, 55.2, 58.6, 58.7, 64.3, 67.7, 73.9, 76.5, 78.5, 82.7, 86.2, 113.0, 113.1, 117.7, 118.4, 126.6, 127.7, 128.4, 130.3, 130.3, 136.1, 136.1, 138.0, 141.7, 145.0, 158.4, 177.6; ^{31}P NMR (202 MHz, CD_3CN) δ 148.9; HRMS(LSIMS)¹⁹ calcd for $\text{C}_{50}\text{H}_{71}\text{N}_4\text{O}_9\text{SiP}+\text{Na}$ [(M+Na)⁺] 953.4621, found 953.4625. **Compound 12.** A white powder; $R_f=0.75$ (50% EtOAc/hexane); ^1H NMR (500 MHz, CD_3CN) δ -0.10 (s, 3H), 0.02 (s, 3H), 0.77 (s, 9H), 1.07 (s, 9H), 1.08 (d, 3H, $J=5.0$ Hz), 1.16 (d, 9H, $J=8.3$ Hz), 2.52–2.53 (m, 2H), 3.00 (dd, 1H, $J=11.0$, 7.4 Hz), 3.30 (dd, 1H, $J=7.4$, 3.7 Hz), 3.55–3.65 (m, 2H), 3.75 (s, 6H), 3.70–3.85 (m, 2H), 3.95–4.05 (m, 1H), 4.30–4.35 (m, 2H), 4.92 (s, 1H), 5.75 (s, 2H), 6.84 (d, 4H, $J=8.0$ Hz), 7.14 (s, 1H), 7.2–7.5 (br m, 9H), 7.61 (s, 1H); ^{31}P NMR (202 MHz, CD_3CN) δ 149.1, 150.7; HRMS (LSIMS)¹⁹ calcd for $\text{C}_{50}\text{H}_{71}\text{N}_4\text{O}_9\text{SiP}+\text{Na}$ [(M+Na)⁺] 953.4621, found 953.4618.

4.1.10. [4-(3,5-Di-*O*-benzyl-2-deoxy- β -*D*-ribofuranosyl)imidazolyl]methyl 2,2-dimethylpropionate (14). By the same procedure as used for the preparation of **5c**, 2-deoxy compound **13**^{7b} (1480 mg, 4.06 mmol) was converted to **14** (1750 mg, 90%) as a colorless oil; ^1H NMR (CDCl_3) δ 1.14 (s, 9H), 2.20–2.38 (m, 2H), 3.53 (dd, 1H, $J=7.0$, 5.8 Hz), 3.64 (dd, 1H, $J=7.0$, 4.7 Hz), 4.08–4.26 (m, 2H), 4.55 (d, 4H, $J=6.25$ Hz), 5.13 (dd, 1H, $J=5.8$, 4.7 Hz), 7.00 (s, 1H), 5.75 (s, 2H), 7.20–7.40 (m, 11H), 7.60 (s, 1H); HRMS(EIMS) calcd for $\text{C}_{28}\text{H}_{34}\text{N}_2\text{O}_5$ [(M)⁺] 478.2466, found 478.2464.

Conversion of 14 into 13. To a solution of **14** (114 mg, 0.24 mmol) in methanol (10 ml) 28% aqueous NH_3 (2.5 ml) was added and then the whole was stirred for 3 h at rt. After evaporation, the resulting residue was purified by flash column chromatography (70–100% AcOEt) to give **13** (87 mg, quant) as a colorless oil.

4.1.11. [4-(5-*O*-DMT-2-deoxy- β -*D*-ribofuranosyl)imidazolyl]methyl 2,2-dimethylpropionate (16). By the same procedures as used for the preparations of **8** and **9**, 2-deoxy compound **14** (229 mg, 0.48 mmol) was converted to a crude diol **15**, which was subsequently tritylated to give **16** (146 mg, 51%) as a colorless oil; ^1H NMR (CDCl_3) δ 1.16 (s, 9H), 2.10–2.44 (m, 2H), 3.12–3.26 (m, 1H), 3.32–3.45 (m, 1H), 3.80 (s, 6H), 3.92–4.08 (m, 1H), 4.38–4.50 (m, 1H), 5.10–5.22 (m, 1H), 6.78 (s, 2H), 6.80 (d, 4H, $J=8.0$ Hz) 7.00 (s, 1H), 7.16–7.40 (m, 9H), 7.60 (s, 1H).

4.1.12. {4-[5-*O*-DMT-2-deoxy-3-*O*-(2-*CE-N,N*-diisopropylphosphoramidite)- β -*D*-ribo-furanosyl]imidazolyl}methyl 2,2-dimethylpropionate (1b). By the same procedure for **1a**, compound **16** (129 mg, 0.22 mmol) was coevaporated with dichloroethane (2 ml) three times and dissolved in dichloroethane (1.0 ml) again. To the solution of **16** was added DIPT (18 mg, 0.11 mmol) and 2-cyanoethyl *N,N,N',N'*-tetraisopropylphosphodiamidite (0.08 ml, 0.24 mmol). The resulting mixture was stirred at 40°C for 46 h and then evaporated. The residual oil was chromatographed by NH-silica gel chromatography to give partially purified **1b** (56 mg, 32%). PA **1b** was further purified on a preparative NH-TLC with 65% EtOAc in hexane to give **1b** (25 mg, 14%) as a colorless oil; **1b**: ^1H

NMR (500 MHz, CDCl₃) δ 1.13 (s, 12H), 1.26 (s, 9H), 2.27–2.30 (m, 2H), 2.45 (dt, 2H, $J=6.5, 2.8$ Hz), 3.23 (d, 2H, $J=5.0$ Hz), 3.57–3.63 (m, 2H), 3.66–3.74 (m, 2H), 3.79 (s, 6H), 4.15–4.19 (m, 1H), 4.50–4.56 (m, 1H), 5.15 (dd, 1H, $J=9.2, 5.8$ Hz), 5.75 (d, 2H, $J=2.6$ Hz), 6.81 (d, 4H, $J=8.4$ Hz), 7.04–7.06 (m, 1H), 7.17–7.22 (m, 1H), 7.23–7.29 (m, 3H), 7.30–7.36 (m, 4H), 7.43–7.47 (m, 2H), 7.61 (d, 1H, $J=1.0$ Hz); ¹³C NMR (CDCl₃) δ 20.2, 24.5, 24.7, 26.8, 29.7, 38.7, 43.3, 55.2, 59.4, 64.2, 67.7, 75.1, 76.5, 86.1, 97.5, 113.0, 116.6, 126.7, 127.7, 128.3, 130.2, 136.2, 138.0, 143.4, 158.4, 177.6; ³¹P NMR (202 MHz, CD₃CN) δ : 148.7; HRMS (LSIMS)¹⁹ calcd for C₄₄H₅₇N₄O₈P+Na [(M+Na)⁺] 823.3809, found 823.3801.

4.1.13. {4-[3,5-*O*-(1,1,3,3-Tetraisopropylidisiloxane-1,3-diyl)- β -*D*-ribofuranosyl]imidazolyl}methyl 2,2-dimethylpropiolate (17). A mixture of **5c** (755 mg, 1.29 mmol), 20% Pd(OH)₂-C²³ (453 mg), and cyclohexene (3.9 ml, 38.80 mmol) in EtOH (30 ml) was refluxed for 3 h. After filtration through Celite, the filtrate was evaporated to give triol **8** (437 mg), which was subsequently dissolved with dry pyridine (18 ml). 1,3-Dichloro-1,1,3,3-tetraisopropylidisiloxane (0.4 ml) was added dropwise to the pyridine solution of **8** at 0 °C. The resulting mixture was stirred for 1 h at the same temperature and then at rt for 3 h. After evaporation, the crude product was purified by flash column chromatography (30–50% EtOAc in hexanes) to obtain **17** (481 mg, 67%) as a colorless oil; ¹H NMR (CDCl₃) δ 0.94–1.12 (m, 28H), 1.18 (s, 9H), 3.00 (br s, 1H), 3.94–4.10 (m, 3H), 4.27 (dd, 1H, $J=12.0, 7.7$ Hz), 4.46 (t, 1H, $J=12.0$ Hz), 4.77 (d, 1H, $J=7.7$ Hz), 5.78 (s, 2H), 7.10 (s, 1H), 7.66 (s, 1H); HRMS(EIMS) calcd for C₂₆H₄₈N₂O₇Si₂ [(M)⁺] 556.2997, found 556.2988.

4.1.14. {4-[2-*O*-Allyl-3,5-*O*-(1,1,3,3-tetraisopropylidisiloxane-1,3-diyl)- β -*D*-ribofuranosyl]imidazolyl}methyl 2,2-dimethylpropiolate (18). Compound **17** (481 mg, 0.87 mmol) was rendered anhydrous by coevaporation with dry pyridine three times. The residue was repeated coevaporated with dry toluene and finally dissolved in dry THF (9 ml). Triphenylphosphine (45 mg, 0.17 mmol) and tris(dibenzylideneacetone)-dipalladium (0) (16 mg, 0.017 mmol) were added. Finally, allyl ethyl carbonate (0.2 ml, 1.74 mmol) was added dropwise with stirring, and the reaction mixture was refluxed for 15 h and then evaporated. The residue was purified by flash column chromatography (10–30% EtOAc in hexanes) to obtain **18** (197 mg, 38%) as a colorless oil; ¹H NMR (CDCl₃) δ 0.92–1.12 (m, 28H), 1.16 (s, 9H), 3.97 (dd, 1H, $J=12.7, 2.4$ Hz), 4.00–4.06 (m, 3H), 4.11 (dd, 1H, $J=12.7, 2.4$ Hz), 4.16–4.43 (m, 2H), 4.97 (s, 1H), 5.15 (dq, 1H, $J=10.1, 1.9$ Hz), 5.32 (dq, 1H, $J=17.5, 1.9$ Hz), 5.76 (dd, 1H, $J=15.9, 10.6$ Hz), 5.87–6.01 (ddt, 1H, $J=17.5, 10.1, 5.0$ Hz), 7.10 (s, 1H), 7.62 (s, 1H); HRMS(EIMS) calcd for C₂₉H₅₂N₂O₇Si₂ [(M)⁺] 596.3310, found 596.3308.

4.1.15. [4-(2-*O*-Allyl- β -*D*-ribofuranosyl)imidazolyl]methyl 2,2-dimethylpropiolate (19). A solution of TMEDA (0.3 ml, 1.98 mmol) in CH₃CN (0.3 ml) and HF (46% aqueous solution, 57 μ l) was added to a small round-bottom flask at 0 °C. The HF/TMEDA mixture was stirred at 0 °C for 10 min, and a solution of **18** (197 mg, 0.33 mmol) in CH₃CN (2.3 ml) was added dropwise over 5 min. The

resulting mixture was stirred at 0 °C for 30 min and then at rt for 2.5 h. The solvent was evaporated to give a residue, which was subsequently purified by flash column chromatography (5–15% MeOH in EtOAc) to obtain **19** (86 mg, 74%) as a colorless oil; ¹H NMR (CDCl₃) δ 1.17 (s, 9H), 3.62 (dd, 1H, $J=12.6, 4.2$ Hz), 3.77 (dd, 1H, $J=12.6, 3.1$ Hz), 3.90–3.97 (m, 2H), 3.98 (ddt, 1H, $J=13.1, 5.3, 1.6$ Hz), 4.08 (ddt, 1H, $J=13.1, 5.3, 1.6$ Hz), 4.19 (dd, 1H, $J=5.2, 4.5$ Hz), 4.77 (d, 1H, $J=6.6$ Hz), 5.07 (ddt, 1H, $J=10.3, 1.6, 1.2$ Hz), 5.16 (dq, 1H, $J=17.4, 1.6$ Hz), 5.82 (ddt, 1H, $J=17.4, 10.3, 5.3$ Hz), 5.94 (s, 2H), 7.32 (s, 1H), 7.84 (s, 1H); HRMS(EIMS) calcd for C₁₇H₂₇N₂O₆ [(M+H)⁺] 355.1867, found 355.1869.

4.1.16. [4-(2-*O*-Allyl-5-*O*-DMT- β -*D*-ribofuranosyl)imidazolyl]methyl 2,2-dimethylpropiolate (20). By the same procedure as used for the preparation of **9**, a mixture of allyl compound **19** (43 mg, 0.12 mmol), DMTCI (66 mg, 0.18 mmol), Et₃N (0.03 ml, 0.18 mmol), and DMAP (0.4 mg, 0.003 mmol) was stirred at rt for 19 h to give **20** (81 mg, quant) as an amorphous product; ¹H NMR (CDCl₃) δ 1.12 (s, 9H), 3.28 (dd, 1H, $J=10.0, 4.8$ Hz), 3.38 (dd, 1H, $J=10.0, 3.9$ Hz), 3.78 (s, 6H), 4.00–4.28 (m, 5H), 4.97 (d, 1H, $J=3.8$ Hz), 5.17 (dd, 1H, $J=10.3, 1.4$ Hz), 5.26 (dd, 1H, $J=17.1, 3.0, 1.4$ Hz), 5.69 (q, 2H, $J=10.8$ Hz), 5.90 (ddt, 1H, $J=17.1, 15.7, 5.4$ Hz), 6.81 (d, 4H, $J=9.0$ Hz), 7.07 (br s, 1H), 7.14–7.50 (m, 9H), 7.62 (br d, 2H, $J=1.3$ Hz); ¹³C NMR (CDCl₃) δ 27.1, 55.3, 64.2, 67.7, 71.2, 71.4, 78.2, 82.1, 82.9, 86.0, 112.7, 117.2, 126.2, 127.3, 127.9, 129.8, 133.5, 135.6, 137.7, 141.6, 144.5, 157.8, 176.8 (CO); HRMS(EIMS) calcd for C₃₈H₄₄N₂O₈ [(M)⁺] 656.3095, found 656.3091.

4.1.17. {4-[2-*O*-Allyl-5-*O*-DMT-3-*O*-(2-*CE*-*N,N*-diisopropylphosphoramidite)- β -*D*-ribofuranosyl]imidazolyl}methyl 2,2-dimethylpropiolate (1c). By the same procedure for **1a**, compound **20** (43 mg, 0.07 mmol) was dissolved in dichloromethane (0.3 ml). To the solution was added a solution of DCI (6 mg, 0.05 mmol) in CH₃CN (0.05 ml) followed by CETPA (21 μ l, 0.07 mmol). After the mixture was stirred at rt for 12 h, DCI (6 mg, 0.05 mmol) in CH₃CN (0.05 ml) and 2-cyanoethyl *N,N,N',N'*-tetraisopropylphosphodiamidite (21 μ l, 0.07 mmol) were added. The resulting mixture was further stirred for 12 h at rt and then evaporated. The residual oil was chromatographed using benzene by NH-silica gel chromatography to give partially purified **1c** (33 mg, 60%). The semi-purified **1c** was further purified by NH-silica gel (35% EtOAc in hexane) to give **1c** (15 mg, 27%) as a colorless oil; ¹H NMR (500 MHz, CDCl₃) δ 1.00 (s, 2H), 1.08–1.40 (m, 19H), 2.32 (t, 1H, $J=6.5$ Hz), 2.61 (q, 1H, $J=5.9$ Hz), 3.20 (td, 2H, $J=8.8, 3.8$ Hz), 3.33–3.65 (m, 5H), 3.78 (s, 6H), 4.00–4.45 (m, 5H), 4.98 (t, 1H, $J=5.3$ Hz), 5.11 (br d, 1H, $J=9.5$ Hz), 5.23 (d, 1H, $J=17.3$ Hz), 5.60–5.77 (m, 2H), 5.80–5.95 (m, 1H), 6.80 (dd, 4H, $J=8.3, 6.4$ Hz), 7.10 (br d, 1H, $J=3.7$ Hz), 7.16–7.30 (m, 3H), 7.31–7.39 (m, 4H), 7.44–7.50 (m, 2H), 7.61 (s, 1H); ³¹P NMR (202 MHz, CDCl₃) δ 149.7, 150.4; HRMS(LSIMS)¹⁹ calcd for C₄₇H₆₂N₄O₉P [(M+H)⁺] 857.4251, found 857.4252; calcd for C₄₇H₆₁N₄O₉PNa [(M+Na)⁺] 879.4070, found 879.4069; calcd for C₄₇H₆₁N₄O₉PK [(M+K)⁺] 895.3810, found 895.3811.

Acknowledgements

We are grateful to Dr. Y. Hari at Graduate School of Pharmaceutical Sciences, Nagoya City University, for helpful discussions. The authors thank Mr. K. Minoura for help with measurements of NMR. We also thank Mr. A. Miwa at Fuji Silysia Chemical Ltd for his kind advice on the purification of the products. We acknowledge financial support [Grant No. 16590024 (S. H.), No. 17790024 (L. A), and No 16590089 (T. K.)] and a Grant-in-Aid for High Technology Research from the Ministry of Education, Science, Sports, and Culture, Japan.

References and notes

- Saville, B. J.; Collins, R. A. *Cell* **1990**, *61*, 685–696.
- Lafontaine, D. A.; Wilson, T. J.; Norman, D. G.; Lilley, D. M. J. *J. Mol. Biol.* **2001**, *312*, 663–674.
- Lafontaine, D. A.; Wilson, T. J.; Zhao, Z.; Lilley, D. M. J. *J. Mol. Biol.* **2002**, *323*, 23–34.
- Perrotta, A. T.; Shih, I.-h.; Been, M. D. *Science* **1999**, *286*, 123–126.
- Zhao, Z.; McLeod, A.; Harusawa, S.; Araki, L.; Yamaguchi, M.; Kurihara, T.; Lilley, D. M. J. *J. Am. Chem. Soc.* **2005**, *127*, 5026–5027.
- Preliminary communication: Araki, L.; Harusawa, S.; Yamaguchi, M.; Yonezawa, S.; Taniguchi, N.; Lilley, D. M. J.; Zhao, Z.; Kurihara, T. *Tetrahedron Lett.* **2004**, *45*, 2657–2661.
- (a) Harusawa, S.; Murai, Y.; Moriyama, H.; Ohishi, H.; Yoneda, R.; Kurihara, T. *Tetrahedron Lett.* **1995**, *36*, 3165–3168. (b) Harusawa, S.; Murai, Y.; Moriyama, H.; Imazu, T.; Ohishi, H.; Yoneda, R.; Kurihara, T. *J. Org. Chem.* **1996**, *61*, 4405–4411. (c) Araki, L.; Harusawa, S.; Suzuki, H.; Kurihara, T. *Heterocycles* **2000**, *53*, 1957–1973.
- (a) Harusawa, S.; Imazu, T.; Takashima, S.; Araki, L.; Ohishi, H.; Kurihara, T.; Yamamoto, Y.; Yamatodani, A. *Tetrahedron Lett.* **1999**, *40*, 2561–2564. (b) Hashimoto, T.; Harusawa, S.; Araki, L.; Zuiderveld, O. P.; Smit, M. J.; Imazu, T.; Takashima, S.; Yamamoto, Y.; Sakamoto, Y.; Kurihara, T.; Leurs, R.; Bakker, R. A.; Yamatodani, A. *J. Med. Chem.* **2003**, *46*, 3162–3165. (c) Harusawa, S.; Araki, L.; Kurihara, T. *J. Synth. Org. Chem. Jpn.* **2003**, *61*, 682–693.
- For reviews, see: (a) Caruthers, M. H.; Barone, A. D.; Beaucage, S. L.; Dodds, D. R.; Fisher, E. F.; Mc Bride, L. J.; Matteucci, M.; Stabinsky, Z.; Tang, J.-Y. *Methods Enzymol.* **1987**, *154*, 287–315. (b) Usman, N.; Ogilvie, K. K.; Jiang, M.-Y.; Cedergren, R. J. *J. Am. Chem. Soc.* **1987**, *109*, 7845–7854. (c) Wincott, F.; DiRenzo, A.; Shaffer, C.; Grimm, S.; Tracz, D.; Workman, C.; Sweedler, D.; Gonzalez, C.; Scaringe, S.; Usman, N. *Nucleic Acids Res.* **1995**, *23*, 2677–2684.
- Bergstrom, D. E.; Zhang, P.; Zhou, J. *J. Chem. Soc., Perkin Trans. 1* **1994**, 3029–3034.
- Greene, T. W.; Wuts, P. G. M. *Protective Groups in Organic Synthesis*, 3rd ed.; Wiley: New York, 1999; pp 615–631, and references therein.
- Kamimura, T.; Masegi, T.; Urakami, K.; Honda, S.; Sekine, M.; Hata, T. *Chem. Lett.* **1983**, 1051–1054.
- Kiso, Y.; Inai, M.; Kitagawa, K.; Akita, T. *Chem. Lett.* **1983**, 739–742.
- N-POM group has been used in purine, xanthine, pyrrole, indole systems and so on as a protecting group. (a) Rasmussen, M.; Leonard, N. J. *J. Am. Chem. Soc.* **1967**, *89*, 5439–5445. (b) Holmes, B. N.; Leonard, N. J. *J. Org. Chem.* **1976**, *41*, 568–571. (c) Holschbach, M. H.; Fein, T.; Krummeich, C.; Lewis, R. G.; Wutz, W.; Schwabe, U.; Unterlugauer, D.; Olsson, R. A. *J. Med. Chem.* **1998**, *41*, 555–563. (d) Dhanak, D.; Reese, C. B. *J. Chem. Soc., Perkin Trans. 1* **1986**, 2181–2186. (e) Pieles, U.; Beijer, B.; Bohmann, K.; Weston, S.; O'Loughlin, S.; Adam, V.; Sproat, B. S. *J. Chem. Soc., Perkin Trans. 1* **1994**, 3423–3429. (f) Taylor, E. C.; Young, W. B. *J. Org. Chem.* **1995**, *60*, 7947–7952.
- Olofson, R. A.; Kendall, R. V. *J. Org. Chem.* **1970**, *35*, 2246–2248.
- Zaramella, S.; Heinonen, P.; Yeheskiely, E.; Strömberg, R. *J. Org. Chem.* **2003**, *68*, 7521–7523.
- Hakimelahi, G. H.; Proba, Z. A.; Ogilvie, K. K. *Can. J. Chem.* **1982**, *60*, 1106–1113.
- Jones, S. S.; Reese, C. B. *J. Chem. Soc., Perkin Trans. 1* **1979**, 2762–2764.
- Fujitake, M.; Harusawa, S.; Araki, L.; Yamaguchi, M.; Lilley, D. M. J.; Zhao, Z.; Kurihara, T. *Tetrahedron* **2005**, *61*, 4689–4699.
- (a) Sproat, B. S.; Iribarren, A.; Beijer, B.; Pieles, U.; Lamond, A. I. *Nucleosides Nucleotides* **1991**, *10*, 25–36. (b) Sproat, B. S.; Iribarren, A. M.; Garcia, R. G.; Beijer, B. *Nucleic Acids Res.* **1991**, *19*, 733–738.
- (a) Kumar, V.; Gopalakrishnan, V.; Ganesh, K. N. *Bull. Chem. Soc. Jpn.* **1992**, *65*, 1665–1667. (b) Lakhmiri, R.; Lhoste, R.; Sinou, D. *Tetrahedron Lett.* **1989**, *30*, 4669–4672.
- (a) Santoro, S. W.; Joyce, G. F.; Sakthivel, K.; Gramatikova, S.; Barbas, C. F., III. *J. Am. Chem. Soc.* **2000**, *122*, 2433–2439. (b) Gurlain, T.; Sidorov, A.; Mignet, N.; Thorpe, S. J.; Lee, S. E.; Grasby, J. A.; Williams, D. M. *Nucleic Acids Res.* **2001**, *29*, 1898–1905.
- Pd–C (5 and 10%) and 20% Pd(OH)₂–C were purchased from Wako Pure Chemicals and Aldrich, respectively.

New enantioselective method for hydration of alkenes using cyclodextrins as phase transfer catalyst

Artur R. Abreu,^a Iva Costa,^a Carla Rosa,^a Luísa M. Ferreira,^a Ana Lourenço^a
and Pedro P. Santos^{b,*}

^aREQUIMTE, Departamento de Química, FCT-UNL, 2829-516 Caparica, Portugal

^bCQE, Instituto Superior Técnico, Departamento de Eng^a Química, UTL, Avenida Rovisco Pais, 1049-001 Lisboa, Portugal

Received 4 July 2005; revised 9 September 2005; accepted 12 September 2005

Available online 14 October 2005

Abstract—A new enantioselective/inverse phase transfer catalysis (IPTC) reaction for the Markovnikov hydration of double bonds by an oxymercuration–demercuration reaction with cyclodextrins as catalysts was disclosed. Moderate ee (up to 32%) and yields (14–60%) were obtained for allylic amines and protected allylic alcohols as starting materials.
© 2005 Elsevier Ltd. All rights reserved.

1. Introduction

The enantioselective functionalization of alkenes is extremely important in synthetic organic chemistry and much effort has been expended for the development of new synthetic methods.¹ The epoxidation of allylic alcohols with titanium tartarate complexes (Sharpless) and of styrene-like olefins with porphyrin complexes (Katsuki–Jacobsen) are two prominent ways of asymmetric functionalization of olefins.¹ For asymmetric hydration of a terminal double bond, Sharpless or Jacobsen asymmetric epoxidation followed by hydride opening of the resulting epoxide ring might be a satisfactory solution (Scheme 1). However, the scope of this strategy is limited by the epoxidation step as the asymmetric epoxidation of some olefins cannot be accomplished.¹

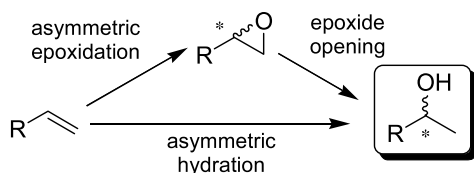

Scheme 1. Main synthetic strategies for asymmetric hydration of terminal double bonds.

Alternatively, Markovnikov-like hydration of double bonds may be performed by the classical oxymercuration–

demercuration process. The reaction of mercuric acetate with unsaturated substrates leads to the addition of a hydroxyl group to one side of the double bond and mercury to the other side, via a mercurinium ion intermediate. Reduction of the C–Hg bond with sodium borohydride in aqueous sodium hydroxide yields the alcohol corresponding to a Markovnikov addition of water to the double bond.² The enantioselective version of this reaction was achieved by the use of optically active mercuric salts but low yields and moderate ee were observed.³ Another drawback of this method is that the mercuric salts are not readily available and have to be synthesized. Oxymercuration of (1:1) complexes of olefin– β -cyclodextrin is also not a practical proposition.⁴

The present new method of hydration of alkenes using cyclodextrins was developed to overcome difficulties observed with some alkenes where the Sharpless/Jacobsen epoxidation failed to produce enantioselective epoxides.

2. Results and discussion

To improve synthetic efficiency of the hemisynthesis of homopumiliotoxins⁵ from jussiaeines⁶ the enantioselective hydration of a double bond was needed (Scheme 2).

Piperidine model compounds were used as starting materials to develop the synthetic procedure. A piperidine ring containing an exocyclic double bond (**1**) was produced from a protected 3-hydroxymethylene piperidine, similar to the starting natural products. The enantioselective

Keywords: Reduction; IPTC; Oxymercuration; Cyclodextrin; Hydration.

* Corresponding author. Tel.: +351 218417878; fax: +351 218417122

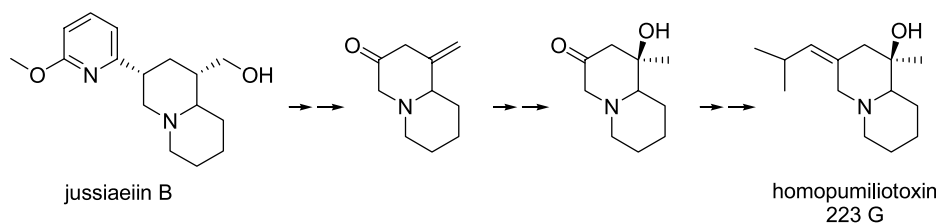

Scheme 2. Proposed pathway for the hemisynthesis of homopumiliotoxins from jussiaeines.

epoxidation/hydride opening by Sharpless and Jacobsen/Katsuky catalysts were assayed but both failed.

A new synthetic method for direct enantioselective hydration of the double bond was searched and an inverse phase transfer catalysis (IPTC) process with a chiral catalyst looked promising and therefore, investigated.

PTC reactions have been extensively applied to promote a variety of interfacial reactions with small molecules and several enantioselective methods have been developed (for example, Michael additions and reductions).⁷ IPTC reactions—where a lipophilic reactant is transported to the aqueous phase by the catalyst—are still rare and only limited examples have been reported. We now report the first example of an enantioselective IPTC hydration reaction, promoting the hydration of alkenes via an oxymercuration–demercuration process.

The intermediate of the oxymercuration reaction results from the attack of the neutral alkene to the water soluble mercuric salt in the usual solvent system aqueous THF.⁸ A two phase PTC reaction would allow to control the contact between the alkene and the mercuric salt, as the former will stay in the organic phase and the latter in the aqueous phase. A neutral PTC catalyst would be the right choice to carry the alkene to the aqueous phase and to create an asymmetric environment where the reaction would take place (Fig. 1).

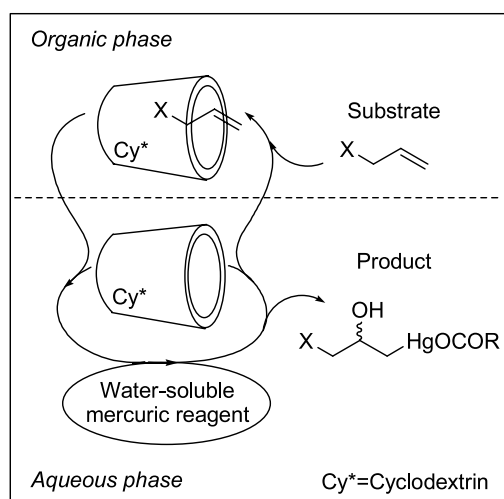
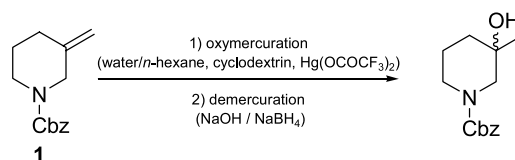

Figure 1. Simplified mechanism of an IPTC process mediated by cyclodextrins.

Neutral cyclodextrins were tested as phase transfer catalysts. They are cyclic polymeric sugars with a basket-like structure and are known to behave as chiral phase

transfer reagents.⁹ Stereochemical (size of the hydrophobic cavity) and stereoelectronic effects may have strong influence on the behaviour of the cyclodextrin as IPTC catalyst.

Surprisingly or not, enantioselectivity was observed when the oxymercuration–demercuration process of **1** (Scheme 3) was conducted in a two phase water–*n*-hexane (1/1) system with α - and β -cyclodextrin as IPTC catalyst (Table 1, entries 1,2).



Scheme 3. Enantioselective oxymercuration–demercuration of the piperidine derivative **1**.

Following this result, several other alkenes were tested. The alkenes were reacted with different molar quantities of mercuric salts in a water–*n*-hexane mixture (1/1) containing a phase transfer catalyst with formation of oxymercurationals. These intermediates were not isolated but submitted to demercuration with alkaline borohydride.

Depending on the demercuration conditions the dihydroxylation product was also formed¹⁰. The demercuration reaction was conducted under inert atmosphere to increase the yield of monoalcohol product. The resulting alcohols were purified by preparative thin-layer chromatography and the ees were determined by HPLC on chiral stationary phase or by ¹H NMR experiments (using chiral shift reagents or Mosher's esters) (Tables 1 and 2).

Unfunctionalized alkenes like styrene failed to react under the IPTC conditions. However, hydration of allylic amines and allylic protected alcohols was successful and moderate enantioselectivity was observed. As usual, this reaction gave excellent chemoselectivity with formation of the more substituted alcohol.

A study of the reaction conditions was carried out with the allylic alcohol **2** as starting material (Table 2). The use of ultrasound, previously applied to prepare the mercuric salt in situ,¹¹ increased significantly the reaction rate (entries 1–4). Even though Hg(OCOCH₃)₂ gives better yields than Hg(OCOCH₃)₂, enantioselectivity was only achieved with the latter (entries 5 and 7). The yield of the process was increased using an excess of the mercuric compound (entries 8–11). For this substrate, β -cyclodextrin was a better catalyst (entries 5–9) and higher enantioselectivity

Table 1. Reaction conditions, yields and ee for IPTC oxymercuration–demercuration of allylic amines

Substrate	Entry	IPTC catalyst (cyclodextrin)	Time (h)	Yield (%)	ee (%)
	1	β	4	58	25 ^a
	2	α	4	36	32 ^a
	3	2,6-Di- <i>O</i> -methyl- β	4	36	18 ^a
	4	Random methyl- β	4	38	11 ^a
	5 ^b	β	0.7	60	15 ^a
	6 ^b	α	0.7	27	17 ^a
	7 ^b	2,6-Di- <i>O</i> -methyl- β	0.7	53	11 ^a
	8 ^b	Random methyl- β	0.7	46	14 ^a
	9	β	2	31	25 ^a
	10	α	2	40	11 ^a
	11	2,6-Di- <i>O</i> -methyl- β	2	60	11 ^a
	12	Random methyl- β	2	43	10 ^a
	13	β	3	40	30 ^c
	14	α	3	42	11 ^c
	15	2,6-Di- <i>O</i> -methyl- β	3	25	28 ^c
	16	Random methyl- β	3	55	31 ^c
	17	β	2	30	0 ^c
	18	α	2	32	0 ^c
	19	2,6-Di- <i>O</i> -methyl- β	2	27	6 ^c
	20	Random methyl- β	2	14	0 ^c

^a ee calculated by ¹H NMR experiment by addition of chiral shift reagent (Eu(hfpc)₃).

^b Hg(OCOCH₃)₂ as oxymercuration agent.

^c ee calculated by ¹H NMR experiment of the Mosher's esters.

was obtained by lowering the temperature of the reaction mixture (entry 12–14). The best conditions were found to be 3 mol equiv of mercuric acetate in H₂O/*n*-hexane with β -cyclodextrin as IPTC catalyst, at 0 °C with ultrasound hydration process always operates and reduces the observed ee (entry 15, 19% yield at 0 °C obtained without PTC catalyst).

Allylic amines showed similar behaviour. The optimized

process for **2** was applied to four different allylic amines with four different cyclodextrins as catalysts. It looks like that an aromatic ring must be present in the substrate to achieve enantioselectivity (Table 1, entries 17–20). The best results are always obtained with α - or β -cyclodextrin. Modified cyclodextrins (2,6-di-*O*-methyl and random methyl cyclodextrins) neither improve yield nor enantioselectivity. *N*-allyl-*N*-benzylmethanamine is an interesting example as the benzyl group may be removed by catalytic hydrogenation.

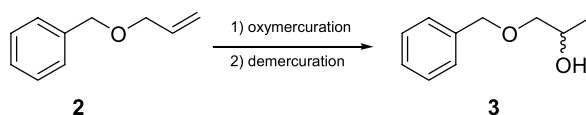
Table 2. Reaction conditions, yields and ee for IPTC oxymercuration–demercuration of allylic alcohol (**2**)

Entry	Mercuric salt	Solvent	Mixing	IPTC catalyst (cyclodextrin)	Temperature (°C)	Time (h)	Yield (%)	ee (%)
1	Hg(OCOCH ₃) ₂ (1 equiv)	H ₂ O/THF	Magnetic stirring	—	20	6	41	0 ^{a,b}
2	Hg(OCOCH ₃) ₂ (1 equiv)	H ₂ O/ <i>n</i> -hexane	Magnetic stirring	—	20	24	35	—
3	Hg(OCOCH ₃) ₂ (1 equiv)	H ₂ O/THF	Ultra sound	—	20	1.5	52	—
4	Hg(OCOCH ₃) ₂ (1 equiv)	H ₂ O/THF	Ultra sound	—	20	1.5	42	—
5	Hg(OCOCH ₃) ₂ (1 equiv)	H ₂ O/ <i>n</i> -hexane	Ultra sound	β	20	0.5	52	0 ^a
6	Hg(OCOCH ₃) ₂ (1 equiv)	H ₂ O/ <i>n</i> -hexane	Ultra sound	α	20	0.75	38	0 ^a
7	Hg(OCOCH ₃) ₂ (1 equiv)	H ₂ O/ <i>n</i> -hexane	Ultra sound	β	20	0.5	20	16 ^a
8	Hg(OCOCH ₃) ₂ (1 equiv)	H ₂ O/ <i>n</i> -hexane	Ultra sound	α	20	0.75	18	0 ^a
9	(2 equiv)	H ₂ O/ <i>n</i> -hexane	Ultra sound	β	20	0.75	35	15 ^a
10	(3 equiv)	H ₂ O/ <i>n</i> -hexane	Ultra sound	β	20	0.75	52	15 ^a
11	(4 equiv)	H ₂ O/ <i>n</i> -hexane	Ultra sound	β	20	0.75	52	14 ^a
12	(3 equiv)	H ₂ O/ <i>n</i> -hexane	Ultra sound	β	25	0.70	52	15 ^a
13	(3 equiv)	H ₂ O/ <i>n</i> -hexane	Ultra sound	β	0	0.75	51	25 ^{a,b}
14	(3 equiv)	H ₂ O/ <i>n</i> -hexane	Ultra sound	β	−75	5	0	—
15	(3 equiv)	H ₂ O/ <i>n</i> -hexane	Ultra sound	—	0	0.75	19	—

^a ee calculated by ¹H NMR experiment by addition of chiral shift reagent (Eu(hfpc)₃).

^b ee calculated by HPLC on chiral stationary phase.

3. Experimental

Melting points were recorded on a Reichert-Thermovar hot stage apparatus and are reported uncorrected. Infrared (IR) spectra were recorded on Perkin Elmer Spectrum 1000 as KBr pellets or as film over NaCl plates.

Proton and carbon nuclear magnetic resonance spectra (^1H and ^{13}C NMR) were recorded on Bruker ARX (400 MHz) spectrometer. Chemical shifts are expressed in ppm, downfield from TMS ($\delta=0$) as an internal standard; J values are given in Hz. The exact attribution of NMR signals was preformed using two dimensional NMR experiments.

Mass spectra were taken with a Micromass GC-TOF (GCT) mass spectrometer. Microanalyses were performed on a Thermo Finnigan-CE Instruments Flash EA 1112 CHNS series microanalyser. The analyses were performed by the analytical services laboratory of REQUIMTE.

All reagents and solvents were reagent grade and were purified and dried by standard methods.

Organic extracts were dried over anhydrous sodium sulfate. Analytical thin-layer chromatography was performed on Merck Kieselgel 60, F254 silica gel 0.2 mm thick plates. For preparative TLC (PTLC) Merck Kieselgel 60, F254 silica gel 0.5, and 1 mm thick plates (20×20 cm) were used. Column chromatography was eluted over Merck Kieselgel 60 (240–400 μm) silica gel.

HPLC was performed on a system equipped with a Dionex P680 pump, UVD340S detector and Carolcel OD column.

3.1. Synthesis of non commercial olefins

3.1.1. 3-Methylenepiperidine-1-carboxylic acid benzyl ester (1). 3-Hydroxymethylenepiperidine was treated with benzylchloroformate by standard method¹² to obtain the Cbz derivative: yellow oil, IV: ν_{max} (cm^{-1}) 3436, 1678; ^1H NMR (CDCl_3) δ 7.40–7.26 (5H, m, ArH), 5.12 (2H, s, CH_2 benzylic), 3.98–3.78 (2H, m, $\text{N}(\text{Cbz})\text{C}_\alpha\text{H}_{\text{eq}}$), 3.48 (2H, m, CH_2OH), 3.09–2.93 (2H, m, $\text{N}(\text{Cbz})\text{C}_\alpha\text{H}_{\text{ax}}$), 1.81–1.65 (3, m, CHCH_2OH , $\text{N}(\text{Cbz})\text{C}_\beta\text{H}_{\text{eq}}$, $\text{N}(\text{Cbz})\text{C}_\gamma\text{H}_{\text{eq}}$), 1.45 (1H, m, $\text{N}(\text{Cbz})\text{C}_\beta\text{H}_{\text{ax}}$), 1.26–1.19 (1H, m, $\text{N}(\text{Cbz})\text{C}_\gamma\text{H}_{\text{ax}}$); ^{13}C NMR (CDCl_3) δ 155.0, 136.8, 128.6–126.9 (5C), 67.0, 64.3, 46.5, 44.8, 33.0, 26.8, 24.0. This compound was tosylated by standard method¹³ to obtain the tosylated derivative: white solid, mp 60–62 °C, IV: ν_{max} (cm^{-1}) 1694, 1354; ^1H NMR (CDCl_3) δ 7.76 (2H, d, $J=7.48$ Hz, HTs), 7.38–7.26 (8H, m, ArH), 5.10 (2H, s, CH_2 benzylic), 3.96–3.84 (4H, m, $\text{N}(\text{Cbz})\text{C}_\alpha\text{H}_{\text{eq}}$, CH_2OTs) 2.85 (1H, m, $\text{N}(\text{Cbz})\text{C}_\alpha\text{H}_{\text{ax}}$), 2.68–2.60 (1H, m, $\text{N}(\text{Cbz})\text{C}_\alpha\text{H}_{\text{ax}}$), 2.44 (3H, s, CH_3), 1.89–1.84 (1H, m, CHCH_2OTs), 1.75 (1H, m, $\text{N}(\text{Cbz})\text{C}_\gamma\text{H}_{\text{eq}}$) 1.66–1.61 (1H, m, $\text{N}(\text{Cbz})\text{C}_\beta\text{H}_{\text{eq}}$), 1.45–1.42 (1H, m, $\text{N}(\text{Cbz})\text{C}_\beta\text{H}_{\text{ax}}$), 1.26–1.21 (1H, m, $\text{N}(\text{Cbz})\text{C}_\gamma\text{H}_{\text{ax}}$); ^{13}C NMR (CDCl_3) δ 155.2, 144.9, 136.7, 132.7, 129.9–127.9, 71.6, 67.1, 46.3, 44.3, 35.3, 26.6, 23.9, 21.6. Anal. Calcd for $\text{C}_{21}\text{H}_{25}\text{NO}_5\text{S}$: C, 62.51; H, 6.25; N, 3.47; S, 7.95 found C, 62.15; H, 6.17; N, 3.41; S, 7.75. This compound was treated with potassium *t*-butoxide (1.1 equiv) in DMSO (1.6 M) under inert atmosphere at room temperature for 2 h. Then the reaction

was quenched with water and extracted with ethyl ether, the organic phase dried and concentrated to dryness under vacuum. The residue was chromatographed by column chromatography with ethyl acetate–*n*-hexane (1/2). Compound (1)¹⁴ was obtained as a colourless oil, IV: ν_{max} (cm^{-1}) 1698, 1656; ^1H NMR (CDCl_3) δ 7.36–7.28 (5H, m, ArH), 5.13 (2H, s, CH_2 benzylic), 4.84–4.77 (2H, m, CCH_2), 3.96 (2H, s, $\text{N}(\text{Cbz})\text{CH}_2\text{C}$), 3.52 (2H, t, $J=5.6$ Hz, $\text{N}(\text{Cbz})\text{CH}_2\text{CH}_2$), 2.27 (2H, t, $J=5.6$ Hz, CCH_2CH_2), 1.64 (2H, m, CCH_2CH_2); ^{13}C NMR (CDCl_3) δ 155.1, 142.4, 136.9, 128.4–127.8, 110.2, 66.9, 50.5, 44.2, 32.6, 26.5.

3.1.2. *N*-allyl-*N*-benzylmethylamine (4).¹⁵ To *N*-benzylmethylamine and NaH (1.1 equiv) in dry DMF (0.8 M) at 0 °C allylbromide (1.1 equiv) was added. The reaction was completed in 1 h at room temperature. Water was added and the mixture extracted 3× with ethyl acetate, the organic phases dried and concentrated to dryness under vacuum. Compound (4) was obtained as a colourless oil (76%), ^1H NMR (CDCl_3) 7.36–7.26 (5H, m, ArH), 5.92 (1H, m, CH), 5.17 (2H, m, CH_2CH), 3.50 (2H, s, CH_2 benzylic), 3.03 (2H, d, $J=6.3$ Hz, NCH_2CH), 2.19 (3H, s, NCH_3).

3.1.3. *N*-allyl-*N*-cyclohexylmethylamine (6).¹⁶ This compound was prepared from cyclohexylmethylamine by the same procedure as compound (4). Compound (6) was purified by extraction to an acidic phase (HCl 10%), neutralization and recovered with dichloromethane. By evaporation of the dried organic phase the pure compound was obtained as a colourless oil (79%), ^1H NMR (CDCl_3) 5.84 (1H, m, CHallyl), 5.13 (2H, m, $\text{CH}_2\text{CHallyl}$), 3.10 (2H, d, $J=6.0$ Hz, NCH_2CH), 2.37 (1H, m, NCH), 2.22 (3H, s, NCH_3), 1.78 (4H, m, H-cyclohexyl), 1.61 (1H, m, H-cyclohexyl), 1.21 (4H, m, cyclohexyl), 1.07 (1H, m, cyclohexyl).

3.2. Oxymercuration–demercuration reactions

Standard homogeneous conditions. To 10 ml of H_2O –THF mixture (1/1) the mercuric reagent was added followed by the addition of the alkene (0.4 mmol). After alkene consumption, 4 ml of NaOH (3 M) were added under inert atmosphere followed by the addition of NaBH_4 (1 equiv) in 2 ml of NaOH (3 M). The mixture was stirred until complete flocculation of Hg^0 . The THF was evaporated, the aqueous phase extracted with ethyl acetate, the organic phase dried and concentrated to dryness under vacuum. The resulting alcohol was purified by plate chromatography.

Heterogeneous conditions. The alkene (0.4 mmol) was dissolved in 5 ml of *n*-hexane followed by the addition, at the pretended temperature, of cyclodextrin (0.04 mmol), 5 ml of water and the mercuric reagent. After alkene consumption, 4 ml of NaOH (3 M) were added under inert atmosphere followed by the addition of NaBH_4 (1 equiv) in 2 ml of NaOH (3 M). The mixture was stirred until complete flocculation of Hg^0 and then extracted with ethyl acetate, the organic phase dried and concentrated to dryness under vacuum. The resulting alcohol was purified by plate chromatography.

By the above procedures the following compounds were prepared. The spectral data were in accordance with

literature: 1-benzyloxypropan-2-ol (**3**),¹⁷ 1-(benzylmethylamino)-propan-2-ol,¹⁸ 1-imidazol-1-yl-propan-2-ol,¹⁹ 3-hydroxy-3-methylpiperidine-1-carboxylic acid benzyl ester.²⁰

3.2.1. 1-(Cyclohexylmethylamino)-propan-2-ol. The alcohol was obtained as a colourless oil, ¹H NMR (CDCl₃) 3.71 (1H, m, CHOH), 2.82 (1H, br l, OH), 2.38–2.34 (2H, m, CH₂N), 2.25 (3H, s, NCH₃), 2.22 (1H, m, NCH), 1.80 (3H, m, H-cyclohexyl), 1.65 (2H, m, H-cyclohexyl), 1.61 (1H, m, H-cyclohexyl), 1.33–1.01 (5H, m, cyclohexyl), 1.11 (3H, d, *J*=6.1 Hz, CH₃CH); ¹³C NMR (CDCl₃) δ 63.5, 62.4 (CHOH, CHN), 61.2 (CH₂N), 37.2 (CH₂N), 29.7, 29.3, 28.2, 26.3, 26.0, 19.9 (CH₃C).

3.3. Methods for ee determination

By the addition of a chiral shift reagent. To a CDCl₃ solution of the alcohol (4.7×10^{-2} mmol), Eu(hfpc)₃ (0.2 equiv) was added and the resulting solution was analysed by ¹H NMR.

By HPLC on a chiral column. A mixture of **2** and **3** was eluted with *n*-hexane–isopropanol (99/1) resulting on the retention times: 14 min for **2**, and 38, 42 min for each enantiomer of **3**.

By formation of Mosher's esters. The Mosher's esters were prepared by the addition of 1 equiv of Mosher's acid chloride to the alcohol in a CH₂Cl₂ solution in the presence of base (K₂CO₃). The diastereomer pair was purified by thin-layer chromatography and analysed by ¹H NMR.

4. Conclusions

A completely new and simple method of asymmetric hydration of terminal double bonds of allylic amines and protected allylic alcohols was discovered. The readily available α- and β-cyclodextrins were able to induce enantioselectivity to the hydration method via an IPTC process. Moderate yields and ees were obtained. Results were found to be dependent on the starting alkene and on reaction conditions. Although there were previously reported methods for enantioselective hydration of allylic alcohols, no equivalent method was up-to-date available for the direct enantioselective functionalization of allylic amines. The present method was able to induce enantioselectivity to the direct hydration of allylic amines. Further developments to improve this new method (yields and enantioselectivity) are underway and will be reported.

Acknowledgements

We would like to thank Carlos M. Afonso and Nuno Lourenço from IST, UTL, Lisbon, for chiral HPLC analyses. We thank to FEDER and POCTI programs for financial support.

References and notes

- Katsuki, T. In *Catalytic asymmetric synthesis*; Ojima, I, Ed. 2nd ed.; Wiley-VCH: New York, 2000; pp 287–325.
- Larock, R. C. *Angew. Chem., Int. Ed. Engl.* **1978**, *17*, 27–37.
- Sugita, T.; Yamasaki, Y.; Itoh, O.; Ichikawa, K. *Bull. Chem. Soc. Jpn.* **1974**, *47*, 1945–1947.
- Rao, K. R.; Sampathkumar, H. M. *Synth. Commun.* **1993**, *23*, 1877–1885.
- Garraffo, H. M.; Spande, T. F.; Daly, J. W.; Baldessari, A.; Gros, E. G. *J. Nat. Prod.* **1993**, *56*, 357–373.
- Máximo, P.; Lourenço, A. *J. Nat. Prod.* **2000**, *63*, 201–204.
- Takahashi, K. *Chem. Rev.* **1998**, *98*, 2013–2033.
- Brown, H. C.; Geoghegan, P. J.; Kurek, J. T. *J. Org. Chem.* **1981**, *46*, 3810–3812.
- Cabou, J.; Bricout, H.; Hapiot, F.; Monflier, E. *Catal. Commun.* **2004**, *5*, 265–270.
- Kitching, W. In Trost, B., Fleming, I., Eds. 1st ed.; *Comprehensive organic synthesis*; Pergamon: Oxford, 1991; Vol. 7, pp 613–638.
- Einhorn, J.; Einhorn, C.; Luche, J. L. *J. Org. Chem.* **1989**, *54*, 4479–4481.
- Greene, T. W.; Wuts, P. G. M. *Protective groups in organic synthesis*. 3rd ed.; Wiley: New York, 1999; pp 494–653.
- Organic syntheses*; Wiley: New York, 1988; Collect. Vol. 6, p 586; Collect. Vol. 55, p 57.
- Deamici, M.; Frolund, B.; Hjeds, H.; Krosgaardlarsen, P. *Eur. J. Med. Chem.* **1991**, *26*, 625–631.
- Aggarwal, V. K.; Fang, G. Y.; Charmant, J. P. H.; Meek, G. *Org. Lett.* **2003**, *5*, 1757–1760.
- Tweedie, V. L.; Allabash, J. C. *J. Org. Chem.* **1961**, *26*, 3676–3681.
- Gaunt, M. J.; Yu, J. Q.; Spencer, J. B. *J. Org. Chem.* **1998**, *63*, 4172–4173.
- Freifelder, M.; Moore, M. B.; Vernsten, M. R.; Stone, G. R. *J. Am. Chem. Soc.* **1958**, *80*, 4320–4323.
- Cooper, G.; Irwin, W. *J. Org. Mass Spectrom.* **1975**, *10*, 885–895.
- Aitken, S. J.; Grogan, G.; Chow, C. S. Y.; Turner, N. J.; Flitsch, S. L. *J. Chem. Soc., Perkin Trans. 1* **1998**, 3365–3370.

Synthesis of tricyanovinyl-substituted thienylpyrroles and characterization of the solvatochromic, electrochemical and non-linear optical properties

M. Manuela M. Raposo,^{a,*} Ana M. R. C. Sousa,^a G. Kirsch,^b F. Ferreira,^c M. Belsley,^c
E. de Matos Gomes^c and A. Maurício C. Fonseca^a

^a*Centro de Química, Universidade do Minho, Campus de Gualtar, 4710-057 Braga, Portugal*

^b*Laboratoire d'Ingénierie Moléculaire et Biochimie Pharmacologique, UFR SciFA, Université de Metz, 1, Boulevard Arago, Metz Technopôle, 57078 Metz Cedex 3, France*

^c*Departamento de Física, Universidade do Minho, Campus de Gualtar, 4710-057 Braga, Portugal*

Received 19 April 2005; revised 15 July 2005; accepted 9 September 2005

Available online 26 October 2005

Abstract—Tricyanovinyl-substituted 1-(alkyl)aryl-2-(2'-thienyl)pyrroles **1** have been synthesized by direct tricyanovinylation reaction of 1-(alkyl)aryl-2-(2'-thienyl)pyrroles **2** using TCNE. The tricyanovinyl-derivatives **1** display dramatic reductions in both their optical and electrochemical band gaps relative to thienylpyrrole precursors **2**. The solvatochromic behavior of compounds **1** was investigated in a variety of solvents. Hyper-Rayleigh scattering was used to measure the first hyperpolarizabilities β of the mentioned compounds. The β values show that the new compounds prepared could be used on the manufacture of materials with good non-linear (NLO) properties.

© 2005 Elsevier Ltd. All rights reserved.

1. Introduction

Novel conjugated organic molecules containing both donor and acceptor moieties have attracted much attention because they are critical components for many great advanced technologies such as non-linear optical (NLO), photo- and electroluminescent devices, and photovoltaic devices. Organic NLO materials have many advantages over inorganic materials, such as large nonlinear optical coefficients, greater ease for synthetic design, simple preparation and lower cost.^{1–3} It has been revealed that the second order hyperpolarizabilities (β) of heterocyclic chromophores are often higher than their benzene analogues.^{4–12} Recently we have also demonstrated that donor–acceptor substituted bithiophenes and terthiophenes have many favorable features as NLO materials.^{13–16} Conjugated thiophene and pyrrole derivatives as donors combined with substituted acceptor groups are promising candidates among such D–A systems due to their numerous applications. Unlike the thiophene or furane analogues, the

pyrrole ring can be further substituted on the nitrogen atom so that the electron density of the chromophore can be changed. In addition, replacing the N–H group of the pyrrole ring with another substituent would eliminate some intramolecular hydrogen bond, which might also affect their macroscopic structures and NLO properties. Some of these molecules, in particular the thienylpyrroles, have served as prospective monomers for non-linear optical materials and organic conductive polymers. The latter combine high electrical conductivity, with thermal and environmental stability.^{17–29} In the last few years donor substituted tricyanovinyl compounds have received a lot of interest. Due to their strong solvatochromic properties, which mainly originate from their donor–acceptor substitution, they can be used as model compounds for dyes with strong NLO properties. Such dyes have found applications in manufacturing new materials capable of generating special electrooptical effects, such as frequency doubling or wave mixing.^{20–24,30} Therefore, tricyanovinyl-derivatives **1** represent promising candidates for NLO and other applications. As part of our continuing interest in non-linear optical material^{13–16,31,32} we have synthesized new tricyanovinyl-substituted thienylpyrroles **1**, by tricyanovinylation reaction of thienylpyrroles **2** described by us recently.³³

Keywords: Tricyanovinylation; Donor–acceptor thienylpyrroles; Chromophores; Solvatochromism; Electrochemistry; Hyper-Rayleigh scattering (HRS); Non-linear optical (NLO) material.

* Corresponding author. Tel.: +351 253 604381; fax: +351 253 678983; e-mail: mfox@quimica.uminho.pt

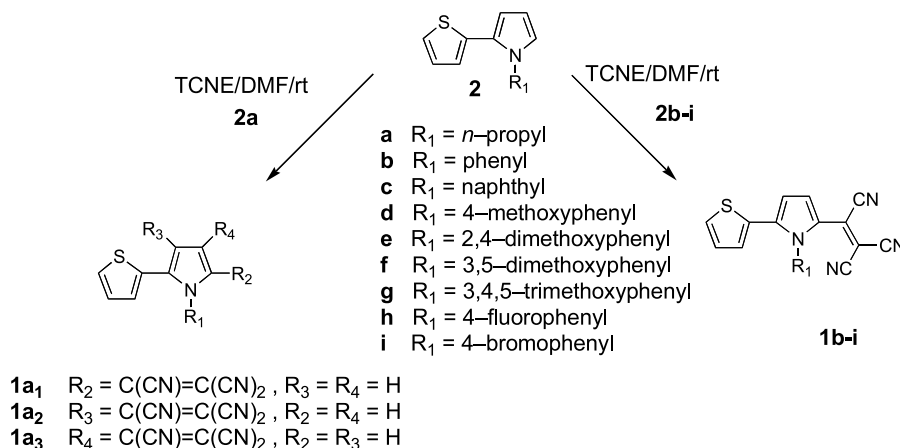

Scheme 1. Synthesis of tricyanovinyl-thienylpyrroles **1a–i** from thienylpyrroles **2a–i** by tricyanovinylation reaction with TCNE.

2. Results and discussion

2.1. Synthesis

Recently we have developed a method for the synthesis of 1-aryl-2-(2'-thienyl)pyrroles **2**.³³ These compounds have proved to be versatile substrates in tricyanovinylation reactions, allowing us to prepare several new donor-acceptor substituted thienylpyrroles.

Electrophilic substitution reactions of thienylpyrroles were found to be very selective. According to earlier reports, the pyrrole nitrogen atom has a greater ability to delocalize the positive charge of σ -complexes than the sulfur atom in thiophene; pyrrole is therefore, considerably more reactive towards electrophilic substitution than thiophene. Even when both α -positions of the pyrrole ring are occupied, electrophilic substitution will preferentially occur in the β -position of the pyrrole ring rather than the α -position of the thiophene ring.^{34–38} The reactivity of these systems has been demonstrated with the use of electrophilic reactions producing derivatives with the electrophile substituted primarily on the pyrrole ring.^{37–44}

Accordingly, tricyanovinylation of thienylpyrroles **2** proceeded selectively in the pyrrole ring to form the corresponding tricyanovinyl-substituted thienylpyrroles **1**. The synthesis of tricyanovinyl derivatives **1a–i** is outlined in **Scheme 1**. The tricyanovinyl-group was introduced in a manner similar to that of previously reported procedure.¹³

Tricyanovinylation was carried out in DMF within 15 min–180 min at room temperature. Under these conditions 1-aryl-2-(2'-thienyl)pyrroles **2b–i** reacted regioselectively forming 1-aryl-2-(2'-thienyl)-5-tricyanovinylpyrroles **1b–i** in 31–73% yield (**Table 1**). 1-*n*-Propyl-2-(2'-thienyl)pyrrole **1a** behaves quite differently in this reaction (**Scheme 1**): the main reaction product was **1a₂** (29%) and results from the substitution at the 3-position of the pyrrole ring; in addition, the 5- and 4-tricyanovinyl-substituted pyrrole derivatives **1a₁** (12%) and **1a₃** (8%) were also isolated (**Table 1**, entries 1–3). In interpreting these results it seems appropriate to take into account the possible steric influence of the *n*-propyl group impeding the substitution at the α -position of the pyrrole ring.³⁶

The structures of tricyanovinyl-substituted pyrrole derivatives **1** were unambiguously confirmed by their analytical and spectral data. In the ¹H NMR spectrum of 5-tricyanovinyl-substituted pyrrole derivative **1a₁** two signals at about 6.82 and 7.62 ppm were detected. Both signals appear as doublets with coupling constants of 4.5 Hz indicating the presence of two adjacent protons (3-H and 4-H) at the corresponding pyrrole moiety. In the ¹H NMR spectrum of 3-tricyanovinyl-substituted pyrrole derivative **1a₂** two signals at about 7.18 and 7.34 ppm were detected. Both signals appear as doublets with coupling constants of 3.3 Hz. These signals were attributed to the 5-H and 4-H in the pyrrole moiety. In the ¹H NMR spectrum of 4-tricyanovinyl-substituted pyrrole derivative **1a₃** two signals at about 7.15 and 8.13 ppm were detected. Both

Table 1. Yields, IR and UV–vis data of tricyanovinyl-thienylpyrroles **1** and thienylpyrroles **2**

Entry	Compound	λ_{\max} (ϵ) (nm) ^a	Compound	R	Yield (%)	λ_{\max} (ϵ) (nm) ^a	$h\nu_{\text{ICT}}$ (eV)	IR ν_{CN} (cm ⁻¹)
1	2a	291.0 (1800)	1a₁	<i>n</i> -Propyl	12	491.5 (16,640)	2.52	2215
2	2a	—	1a₂	<i>n</i> -Propyl	29	408.5 (12,360)	3.04	2217
3	2a	—	1a₃	<i>n</i> -Propyl	8	416.0 (10,201)	2.98	2221
4	2b	294.5 (9208)	1b	Phenyl	35	511.5 (19,086)	2.42	2211
5	2c	288.5 (15,638)	1c	Naphthyl	34	516.5 (32,160)	2.40	2207
6	2d	290.0 (11,410)	1d	4-Methoxyphenyl	50	519.0 (31,639)	2.39	2212
7	2e	286.5 (10,093)	1e	2,4-Dimethoxyphenyl	63	525.5 (36,407)	2.36	2210
8	2f	282.0 (9950)	1f	3,5-Dimethoxyphenyl	37	514.5 (24,604)	2.41	2216
9	2g	281.5 (8477)	1g	3,4,5-Trimethoxyphenyl	73	519.0 (30,842)	2.39	2207
10	2h	293.0 (8505)	1h	4-Fluorophenyl	37	510.5 (30,176)	2.43	2204
11	2i	289.5 (7939)	1i	4-Bromophenyl	31	509.0 (30,457)	2.44	2213

^a All the UV–vis spectra were run in ethanol.

signals appear as doublets with coupling constants of 2.1 Hz. These signals were attributed to the 3-H and 5-H in the pyrrole moiety. In all the ^1H NMR spectra of tricyanovinyl-substituted pyrrole derivatives **1a–i** three signals at about 7.08–7.35 (multiplet), 7.30–7.58 (doublet) and 7.45–7.92 (double doublet) were detected. These signals were attributed, respectively, to the 4', 3' and 5'-H protons in the thiophene moiety.

The tricyanovinyl derivatives synthesized are colored with metallic luster. As for similar compounds, the color of the tricyanovinyl-substituted pyrroles **1** depend on the substituent on the nitrogen of the pyrrole ring.^{21–25}

2.2. UV–vis study of tricyanovinyl-substituted thienylpyrroles

All the tricyanovinyl-substituted thienylpyrroles **1** synthesized are deeply colored compounds, which exhibit intense absorptions in the UV–vis range. The position of these absorptions is influenced by the structure of the compounds, for example, by the substituent on the nitrogen atom of the pyrrole ring and by the position of substitution of the tricyanovinyl group on the pyrrole ring.

The electronic spectra of tricyanovinyl-thienylpyrrole derivatives **1** were recorded in ethanol (Table 1). Dramatic differences in energy occur upon tricyanovinyl-substitution of thienylpyrroles **1**. For example, thienylpyrrole **2e** ($\lambda_{\text{max}} = 286.5$ nm) is shifted 239 nm upon tricyanovinyl substitution (tricyanovinyl-derivative **1e**, $\lambda_{\text{max}} = 525.5$ nm) (Figure 1, Table 1, entry 7). These effects have been attributed to the stabilization of LUMO by the electron-withdrawing groups.⁴⁵ The influence of the substituent on the nitrogen atom of the pyrrole ring is demonstrated by comparison of the absorption maxima of compounds **1a₁** and **1e** as the longest wavelength transition is shifted from 491.5 nm in 1-(*n*-propyl)-2-(2'-thienyl)-5-tricyanovinylpyrrole **1a₁** (Table 1, entry 1) to 525.5 nm for 1-(2'',4''-dimethoxyphenyl)-2-(2'-thienyl)-5-tricyanovinylpyrrole **1e** (Table 1, entry 7). The influence of the position of the tricyanovinyl group on the pyrrole ring on λ_{max} of absorption for tricyanovinyl

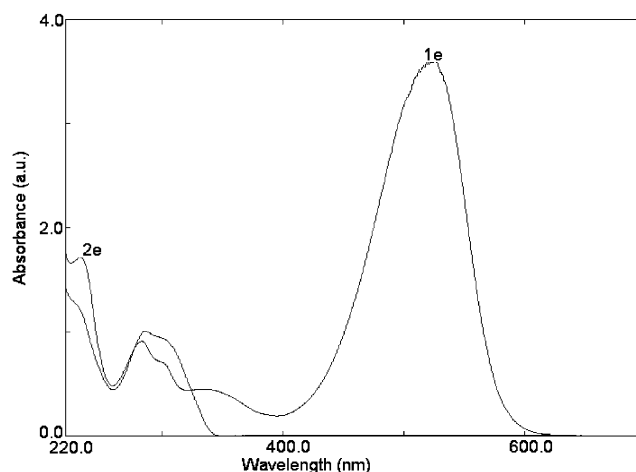

Figure 1. UV–vis spectra of compounds **1e** and **2e** recorded in ethanol.

derivatives **1a₁–1a₃** is noteworthy. The difference in λ_{max} values ($\Delta\lambda_{\text{max}}$) between the three compounds (**1a₁–1a₃**) is in the range of 75–83 nm (Table 1, entries 1–3). As expected, the introduction of the tricyanovinyl group in the 5-position of the pyrrole ring (**1a₁**), relative to the same acceptor group in the 3-position (**1a₂**), results in a bathochromic shift in the λ_{max} of absorption for **1a₁** due to more extensive electron delocalization.

It is widely recognized that low energy bands in the UV–vis. spectra⁴⁶ and large solvatochromism^{7,47,48} are good indicators of potential NLO properties.

2.3. Solvatochromic behavior of tricyanovinyl-substituted thienylpyrroles

To evaluate the intermolecular forces between the solvents and the solute molecules and in order to determine the best indicator dye, we carried out a preliminary study of the absorption spectra for compounds **1** in solvents of different solvation character (cyclohexane, ethyl acetate and DMF). The highest energy transitions are found with non-polar solvents (cyclohexane). More polar solvents such as DMF resulted in lower energy transitions. This behavior has been

Table 2. Solvatochromic data [λ_{max} (nm) and $\bar{\nu}_{\text{max}}$ (cm^{-1}) of the charge-transfer band] for tricyanovinyl-thienylpyrroles **1a₁**, **1a₂** and **1g** in selected solvents with π^* values by Kamlet and Taft⁴⁹

Solvent ^a	π^* ^b	Compound 1a₁		Compound 1a₂		Compound 1g	
		λ_{max} (nm)	$\bar{\nu}_{\text{max}}$ (cm^{-1})	λ_{max} (nm)	$\bar{\nu}_{\text{max}}$ (cm^{-1})	λ_{max} (nm)	$\bar{\nu}_{\text{max}}$ (cm^{-1})
<i>n</i> -Hexane	−0.08	468.8	21,331	—	—	502.5	19,900
Cyclohexane	0.00	470.2	21,268	395.2	25,240	506.5	19,743
Diethyl ether	0.27	480.8	20,799	404.4	24,728	513.0	19,493
Ethyl acetate	0.55	485.4	20,602	407.6	24,534	513.0	19,493
Toluene	0.54	490.2	20,400	407.4	24,546	519.5	19,249
Ethanol	0.54	491.2	20,358	407.4	24,546	519.0	19,268
THF	0.58	490.2	20,400	408.2	24,498	517.0	19,342
Methanol	0.60	490.2	20,400	405.6	24,655	520.0	19,231
Acetone	0.71	491.0	20,367	410.4	24,366	518.0	19,305
Acetonitrile	0.75	494.0	20,243	412.2	24,260	518.5	19,286
Chloroform	0.76 ⁵⁰	497.8	20,088	412.8	24,225	525.5	19,029
Dichloromethane	0.82	500.6	19,976	415.8	24,050	526.0	19,011
DMF	0.88	499.0	20,049	417.0	23,980	528.0	18,939
DMSO	1.00	506.6	19,739	421.0	23,697	533.5	18,744

^a Solvent used as received.

^b The correlation coefficient r obtained for the linear solvation energy relationship with π^* values by Kamlet and Taft for aliphatic and dipolar aprotic solvents was $r = 0.9830$ (**1a₁**), 0.9658 (**1a₂**) and 0.9419 for (**1g**).

Table 3. Cyclic voltammetry data for thienylpyrroles **2** and 5-tricyanovinyl-substituted thienylpyrroles **1** at a glassy carbon electrode

Compound	Thienylpyrroles 2		Tricyanovinyl-substituted thienylpyrroles 1			
	Oxidation E_{pa} (V) ^a	Compound	Oxidation E_{pa} (V) ^a	Reduction ^a		Band gap (eV) ^b
				$-^1E_{1/2}$ (V)	$-^2E_{pc}$ (V)	
2a	0.57	1a₁	1.11	0.92	1.61	2.03
2b	0.53	1b	0.95	1.00	1.70	1.95
2c	0.54	1c	0.96	1.02	1.73	1.98
2d	0.48	1d	0.94	1.14	1.80	2.08
2e	0.45	1e	0.92	1.05	1.75	1.97
2f	0.48	1f	0.95	1.01	1.78	1.96
2g	0.46	1g	0.94	1.06	1.72	2.00
2h	0.55	1h	0.97	0.94	1.78	1.91
2i	0.54	1i	0.98	0.99	1.70	1.97

^a Solution approximately 1–2 mM in each compounds in acetonitrile 0.10 M [NBu₄][BF₄] was used, and the scan rate was 100 mV s⁻¹, potentials versus the ferrocenium–ferrocene-couple.

^b $E_{HOMO} = 4.39 + E_{ox}$ (eV) and $E_{LUMO} = E_{red} + 4.39$ (eV).

defined as a positive solvatochromic response ($\Delta\nu = 649$ cm⁻¹ for **1b** and $\Delta\nu = 1260$ cm⁻¹ for **1a₂**) that is related to a greater stabilization of the excited state relative to the ground state with increasing polarity of the solvent. We found that compounds **1a₁** ($\Delta\nu = 1228$ cm⁻¹), **1a₂** ($\Delta\nu = 1260$ cm⁻¹) and **1g** ($\Delta\nu = 804$ cm⁻¹) showed the longest shifts in wavenumber maxima so a full solvatochromic study involving 14 solvents was carried out (Table 2).

The maxima of the wavenumbers for **1a₁**, **1a₂**, and **1g** measured in 14 solvents as well the corresponding wavelength λ are listed in Table 2 and compared to the π^* determined by Kamlet and Taft.^{49,50}

In view of the pronounced solvatochromism, the good correlation with π^* values for the 14 solvents investigated and the long wavelength absorption in the visible range, **1a₁**, **1a₂**, and **1g** seemed to be a very appropriate solvent polarity indicating dyes (Table 2).

2.4. Electrochemical study of tricyanovinyl-substituted thienylpyrroles

The redox properties of tricyanovinyl-substituted thienylpyrroles **1** were investigated by cyclic voltammetry (Table 3). All compounds displayed one oxidative process under the experimental conditions. The precursors thienylpyrroles **2** showed an irreversible oxidation. Upon tricyanovinyl-substitution, the compounds display oxidation at more positive potentials as a consequence of the destabilizing effect of the electron-withdrawing tricyanovinyl group.⁵¹ For example, the 1-phenyl-2-(2'-thienyl)pyrrole **2b** display an oxidation at $E_{pa} = 0.53$ V and the correspondent tricyanovinyl derivative **1b** display an oxidation at $E_{pa} = 0.95$ V, corresponding to the formation of the cation radical. The tricyanovinyl-substituted thienylpyrroles display two reduction processes (Table 3, Fig. 2). For all compounds, the first process is stable on the cyclic voltammetry scale. A cathodic shift of reduction peak potentials was observed for 1-aryl-thienylpyrroles **1b–i** relative to 1-propyl-thienylpyrrole **1a₁**. For example, 1-*n*-propyl-2-(2'-thienyl)pyrrole **1a₁** displays a reversible reduction $E_{1/2} = 0.92$ V and 1-(2'',4''-dimethoxyphenyl)-2-(2'-thienyl)-5-tricyanovinylpyrrole **1e** displays a reversible reduction at $E_{pa} = 1.05$ V. The results show that oxidative

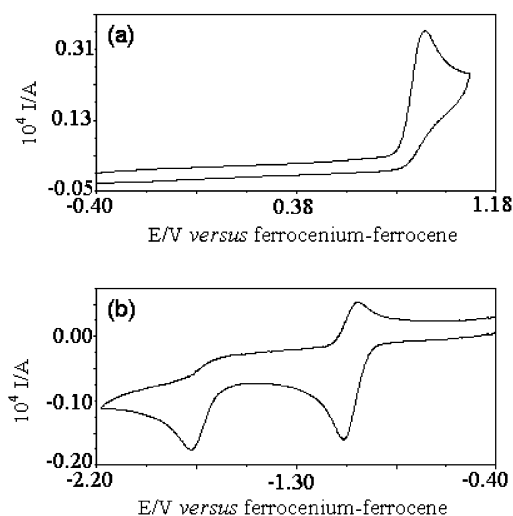

Figure 2. Cyclic voltammograms of 5-tricyanovinyl-thienylpyrrole **1d**, recorded in acetonitrile – 0.1 M [NBu₄][BF₄] at a vitreous carbon electrode (area = 0.049 cm²). Scan rate = 200 mV s⁻¹, concentration of compound = 10⁻³ M. (a) Between –0.40 and 1.18 V versus ferrocenium–ferrocene; (b) between –0.40 and –2.20 V versus ferrocenium–ferrocene.

and reductive peak potentials are influenced by the substituents on the nitrogen of the pyrrole ring.

Electrochemical band gaps, (Table 3), were calculated as described previously⁵² from the potentials of the anodic and cathodic processes and agree well with the calculated optical band gaps. To our knowledge, these are among the lowest band-gap materials based on thienylpyrrole derivatives.

2.5. Non-linear optical study of tricyanovinyl-substituted thienylpyrroles

We have used the Hyper-Rayleigh scattering (HRS) method⁵³ to measure the first hyperpolarizability β of the tricyanovinyl derivatives **1** using the 1064 nm fundamental wavelength of a laser beam. Dioxane was used as a solvent, and the β values were measured against a reference solution of *p*-nitroaniline (PNA)⁵⁴ in the same solvent. Table 4 shows the measured values of β together with the lowest energy absorption maximum of each compound. We have used the two-level model to calculate the static second-order hyperpolarizability β_0 ^{55–57} the results being included in

Table 4. UV–vis absorptions, β values, β_0 values for PNA and for compounds **1**^a

Compound	λ_{max} (nm)	$\beta/10^{-30}$ esu ^b	$\beta_0/10^{-30}$ esu ^c
1a₁	486	254	30
1a₂	408	317	105
1a₃	414	240	80
1b	504	244	19
1c	506	234	17
1d	510	253	17
1e	514	263	13
1f	508	221	15
1g	512	225	13
1h	506	290	21
1i	504	280	22
PNA	352	16.9 ^{58,59}	8

^a Experimental hyperpolarizabilities and spectroscopic data measured in dioxane solutions.

^b All the compounds are transparent at the 1064 nm fundamental wavelength.

^c Data corrected for resonance enhancement at 532 nm using the two-level model with $\beta_0 = \beta [1 - (\lambda_{\text{max}}/1064)^2][1 - (\lambda_{\text{max}}/532)^2]$; damping factors not included 1064 nm.^{55–57}

Table 4. The β_0 values are calculated using a very simple two-level model and are only indicative. The static hyperpolarizability (β_0) values should, therefore, be treated with caution.

The β values of compounds **1b–c**, **1f–g** are virtually identical and 13–14 times of that of PNA, suggesting that, the donating properties of these aryl-thienylpyrrole moieties are comparable. However, derivatives **1d–e** (having one or two methoxy-groups at *ortho* or *ortho–para* position on the aromatic ring) and compounds **1h** and **1i** (having one halogen, F or Br, at *para* position on the aromatic ring) show higher β values. The β values are 15–17 times that of PNA, whereas the β_0 values are 2–3 times of PNA. Compound **1a₂**, having a propyl group at the 1-position of the pyrrole ring and the tricyanovinyl acceptor group at 3-position exhibit the large β and β_0 values. The β value of **1a₂** is 19 times that of PNA and 13 times of β_0 .

Comparison of the β values for **1a₁–1a₃** shows that the substitution of the tricyanovinyl-group at the 3-position on the pyrrole ring leads to a larger nonlinearity than the same acceptor group at 4- (**1a₃**) or at 5-position (**1a₁**).

Donor–acceptor thienylpyrrole derivatives **1** were completely characterized by elemental analysis and/or HRMS, ¹H NMR and ¹³C NMR spectroscopy, UV–vis, IR spectroscopy and cyclic voltammetry (Tables 1–3).

3. Conclusions

In summary, we have synthesized new tricyanovinyl-substituted thienylpyrroles **1** by direct tricyanovinylation reaction of thienylpyrroles **2** with TCNE. These compounds exhibit dramatic changes in both their electronic and redox properties in relation to the precursor materials.

The solvatochromic behavior of compounds **1** was determined by regression analyses of absorption maxima in 14 solvents. Due to their pronounced solvatochromic properties tricyanovinyl-substituted thienylpyrroles and

especially compounds **1a₁**, **1a₂** and **1g** are suitable to investigate the solvent polarity by means of their absorption wavenumbers.

Hyper-Rayleigh scattering was used to determine the first hyperpolarizability, β , the data showing that β is dependent on the substituent on the pyrrole ring (alkyl or aryl) and on the position of substitution (3, 4 or 5) of the acceptor group on the pyrrole ring. It also show that the compounds have high molecular nonlinearities as their values are 10–20 times higher than the well none PNA molecule.

In agreement with the solvatochromic, electrochemical and non-linear optical studies the new compounds prepared could be used on the manufacture of semi-conductor materials or materials with strong non-linear (NLO) properties.

4. Experimental

4.1. General

¹H NMR spectra were obtained on a Varian Unity Plus Spectrometer at 300 MHz and ¹³C NMR spectra were determined on a Varian Unity Plus Spectrometer at 75.4 MHz using the solvent peak as internal reference. The solvents are indicated in parenthesis before the chemical shift values (δ relative to TMS). Mps were determined on a Gallenkamp apparatus and are uncorrected. Infrared spectra were recorded on a Perkin Elmer 1600 FTIR spectrophotometer. UV–vis absorption spectra were obtained using a Shimadzu UV/2501PC spectrophotometer. EI mass spectra EI (70 eV) and HRMS were run on a Unicam GC–MS 120. Elemental analysis was carried out on a Leco CHNS-932. Voltammetric measurements were performed using a potentiostat/galvanostat AUTOLAB/PSTAT 12 with a low current module ECD from ECO-CHEMIE and the data analysis was processed by the General Purpose Electrochemical System software package also from ECO-CHEMIE. Three electrode, two-compartment cells equipped with vitreous carbon-disc working electrodes, a platinum-wire secondary electrode and a silver-wire pseudo-reference electrode were employed for cyclic voltammetric measurements. The concentrations of the compounds were typically 1–2 mmol dm⁻³ and 0.1 mol dm⁻³ [NBu₄][BF₄] was used as the supporting electrolyte in acetonitrile solvent. The potential was measured with respect to ferrocinium–ferrocene as an internal standard. Column chromatography was performed on Merck silica gel 60 (Art 9385). Light petroleum refers to solvent boiling in the range 40–60 °C.

The experimental set-up for hyper-Rayleigh measurements is very similar to the one presented by Clays et al.⁵³ The incident beam came from a Q-switched Nd:YAG laser (10 Hz, ~20 mJ, ~10 ns) at a fundamental wavelength of 1064 nm and was focused in the solution (beam diameter ~0.5 mm). The Hyper-Rayleigh signal was normalized by a second harmonic signal from a quartz plate to compensate for laser power fluctuations. The concentrations of the solutions under study were chosen so that the corresponding relative Hyper-Rayleigh signals fall within the dynamic

range of the apparatus. All solutions were previously filtered (0.2 μm porosity) to avoid spurious signals from suspended impurities. The first hyperpolarizabilities β of the molecules in dioxane solutions were measured using the external reference method.⁵⁴ For two dilute solutions of chromophores with dominant hyperpolarizabilities along the charge transfer axis, in the same solvent, the relative hyperpolarizability is given by $\beta/\beta_{\text{ref}} = m/m_{\text{ref}}$ where m is the coefficient of variation of HRS signal with chromophore concentration. The reference chosen was a solution of PNA 1×10^{-2} M, in dioxane since its β is known from EFISH measurements for the same wavelength.^{58,59} For each solution, we estimated the linear coefficients m using two experimental points: HRS signal for the solvent and HRS signal for the solution. From the calibration value $\beta_{\text{PNA/p-dioxane}} = 16.9 \pm 0.4 \times 10^{-30}$ esu, the determined β values of the present compounds. The error associated with the HRS measured β values is 10%.

The synthesis of thienylpyrroles **1** has been described elsewhere.³³

4.1.1. General procedure for the synthesis of tricyanovinyl-thienylpyrroles **1 from thienylpyrroles **2** by tricyanovinylation with tetracyanoethylene (TCNE).** A solution of thienylpyrroles **2** (0.1 g, 0.40 mmol) in DMF (1 ml) was cooled at 0 °C and then TCNE (0.40 mmol) was added slowly. The reaction mixture was stirred during different reaction times (15 min–3 h) at room temperature. After this time the mixture was poured into ice/water. The organic layer was diluted in chloroform, washed with water and dried with anhydrous MgSO_4 . Evaporation of the organic extract under reduced pressure gave the crude tricyanovinyl-pyrroles **1**, which were purified by ‘flash’ chromatography on silica with increasing amounts of ether in light petroleum as eluent to give the pure products.

Tricyanovinylation of **1a** gave a mixture of 1-propyl-2-(2'-thienyl)-5-tricyanovinylpyrrole **1a₁**, 1-propyl-2-(2'-thienyl)-3-tricyanovinylpyrrole **1a₂** and 1-propyl-2-(2'-thienyl)-4-tricyanovinylpyrrole **1a₃**. The first component eluted was 1-propyl-2-(2'-thienyl)-5-tricyanovinylpyrrole **1a₁** as a dark red solid with metallic luster (12%). Mp: 146.5–146.8 °C. UV (EtOH): λ_{max} nm ($\epsilon/\text{M}^{-1} \text{cm}^{-1}$) 491.5 (16,640), 368.5 (6640), 274.5 (8130). IR (Nujol) ν 2215 (CN), 1500, 1458, 1432, 1325, 1163, 1141, 1094, 850, 790, 705 cm^{-1} . ^1H NMR (Acetone- d_6) δ 0.83 (t, 3H, $J=7.2$ Hz, $\text{NCH}_2\text{CH}_2\text{CH}_3$), 1.70–1.90 (m, 2H, $\text{NCH}_2\text{CH}_2\text{CH}_3$), 4.58 (t, 2H, $J=7.8$ Hz, $\text{NCH}_2\text{CH}_2\text{CH}_3$), 6.82 (d, 1H, $J=4.5$ Hz, 3-H), 7.31–7.35 (m, 1H, 4'-H), 7.58 (dd, 1H, $J=3.4$, 1.2 Hz, 3'-H), 7.62 (d, 1H, $J=4.5$ Hz, 4-H), 7.84 (dd, 1H, $J=5.4$, 1.2 Hz, 5'-H). ^{13}C NMR (CDCl_3) δ 10.52, 25.06, 48.09, 112.90, 113.14, 113.49, 115.80, 124.07, 126.15, 126.30, 128.33, 129.26, 129.31, 130.99, 142.29. MS (EI) m/z (%): 292 (M^+ , 52), 250 (33), 249 (100), 224 (8), 205 (6), 163 (6). HRMS: m/z (EI) for $\text{C}_{16}\text{H}_{12}\text{N}_4\text{S}$; calcd 292.0783; found: 292.0773. Anal. Calcd for $\text{C}_{16}\text{H}_{12}\text{N}_4\text{S}$: C, 65.74; H, 4.11; N, 19.17; S, 10.97. Found: C, 65.46; H, 4.37; N, 18.71; S, 11.17. The second component eluted was 1-propyl-2-(2'-thienyl)-4-tricyanovinylpyrrole **1a₃** as a dark orange solid (8%). Mp: 121.3–122.4 °C. UV (EtOH): λ_{max} nm ($\epsilon/\text{M}^{-1} \text{cm}^{-1}$) 416.0 (10,201), 355.5 (15,154), 268.5 (10,437), 240.0 (12,046). IR (Nujol) ν 2221 (CN), 1546,

1467, 1413, 1334, 1268, 1047, 984, 955, 845, 796, 726, 693, 666, 551 cm^{-1} . ^1H NMR (Acetone- d_6) δ 0.87 (t, 3H, $J=7.2$ Hz, $\text{NCH}_2\text{CH}_2\text{CH}_3$), 1.82 (m, 2H, $\text{NCH}_2\text{CH}_2\text{CH}_3$), 4.30 (t, 2H, $J=7.8$ Hz, $\text{NCH}_2\text{CH}_2\text{CH}_3$), 7.15 (d, 1H, $J=2.1$ Hz, 3-H), 7.22–7.26 (m, 1H, 4'-H), 7.39 (dd, 1H, $J=3.6$, 1.2 Hz, 3'-H), 7.70 (dd, 1H, $J=5.4$, 1.2 Hz, 5'-H), 8.13 (d, 1H, $J=2.1$ Hz, 5-H). MS (EI) m/z (%): 292 (M^+ , 98), 281 (17), 263 (15), 251 (10), 250 (100), 249 (14), 236 (5), 223 (9), 209 (6), 208 (12), 207 (94), 205 (7), 191 (6), 162 (5), 96 (8). HRMS: m/z (EI) for $\text{C}_{16}\text{H}_{12}\text{N}_4\text{S}$; calcd 292.0783; found: 292.0793. The third component eluted was 1-propyl-2-(2'-thienyl)-3-tricyanovinylpyrrole **1a₂** as a dark yellow solid (29%). Mp: 118.9–119.1 °C. UV (EtOH): λ_{max} nm ($\epsilon/\text{M}^{-1} \text{cm}^{-1}$) 408.5 (12,360), 370.0 (13,090), 260.0 (9000). IR (Nujol) ν 2217 (CN), 1562, 1513, 1300, 1270, 1221, 1178, 1112, 945, 846, 762, 719, 534 cm^{-1} . ^1H NMR (Acetone- d_6) 0.88 (t, 3H, $J=7.5$ Hz, $\text{NCH}_2\text{CH}_2\text{CH}_3$), 1.65–1.85 (m, 2H, $\text{NCH}_2\text{CH}_2\text{CH}_3$), 4.02 (t, 2H, $J=7.5$ Hz, $\text{NCH}_2\text{CH}_2\text{CH}_3$), 7.18 (d, 1H, $J=3.3$ Hz, 5-H), 7.29–7.33 (m, 1H, 4'-H), 7.34 (δ , 1H, $J=3.3$ Hz, 4-H), 7.41 (dd, 1H, $J=3.4$, 1.2 Hz, 3'-H), 7.92 (dd, 1H, $J=5.1$, 1.2 Hz, 5'-H). ^{13}C NMR (CDCl_3) δ 11.01, 24.23, 49.52, 109.56, 111.92, 112.60, 112.92, 117.14, 125.17, 126.80, 128.03, 130.91, 133.26, 134.40, 134.78. MS (EI) m/z (%): 292 (M^+ , 100), 263 (30), 236 (47), 224 (48), 196 (11), 170 (8), 147 (7), 109 (5), 86 (4). HRMS: m/z (EI) for $\text{C}_{16}\text{H}_{12}\text{N}_4\text{S}$; calcd 292.0783; found: 292.0788. Anal. Calcd for $\text{C}_{16}\text{H}_{12}\text{N}_4\text{S}$: C, 65.74; H, 4.11; N, 19.17; S, 10.97. Found: C, 65.77; H, 4.33; N, 18.83; S, 11.13.

4.1.2. 1-Phenyl-2-(2'-thienyl)-5-tricyanovinylpyrrole **1b.** Gold-like lustrous crystals (35%). Mp: 184.8–185.7 °C. UV (EtOH): λ_{max} nm ($\epsilon/\text{M}^{-1} \text{cm}^{-1}$) 511.5 (19,086), 376.0 (11,580), 271.5 (9690). IR (Nujol) ν 2211 (CN), 1505, 1403, 1321, 1240, 1229, 1198, 1091, 987, 896, 848, 782, 774, 716, 697 cm^{-1} . ^1H NMR (Acetone- d_6) δ 7.08–7.10 (m, 1H, 4'-H), 7.18 (d, 1H, $J=4.5$ Hz, 3-H), 7.30 (dd, 1H, $J=3.9$, 1.2 Hz, 3'-H), 7.60 (dd, 1H, $J=5.1$, 1.2 Hz, 5'-H), 7.66–7.69 (m, 5H, $5 \times \text{Ar-H}$), 7.92 (d, 1H, $J=4.5$ Hz, 4-H). ^{13}C NMR (CDCl_3) δ 110.85, 113.12, 113.96, 114.17, 123.64, 125.98, 127.66, 127.80, 129.06, 129.34, 130.12, 130.24, 131.08, 131.92, 134.67, 142.03. MS (EI) m/z (%): 326 (M^+ , 100), 300 (5), 100 (8). HRMS: m/z (EI) for $\text{C}_{19}\text{H}_{10}\text{N}_4\text{S}$; calcd 326.0626; found: 326.0626.

4.1.3. 1-Naphthyl-2-(2'-thienyl)-5-tricyanovinylpyrrole **1c.** Gold-like lustrous crystals (34%). Mp: 175.1–176.2 °C. UV (EtOH): λ_{max} nm ($\epsilon/\text{M}^{-1} \text{cm}^{-1}$) 516.5 (32,160), 286.0 (10,753). IR (Nujol) ν 2207 (CN), 1594, 1505, 1463, 1376, 1318, 1261, 1205, 1169, 1112, 954, 895, 848, 809, 776, 743, 709, 612 cm^{-1} . ^1H NMR (Acetone- d_6) δ 6.97–7.02 (m, 1H, 4'-H), 7.20 (m, 1H, Ar-H), 7.35 (dd, 1H, $J=3.9$, 1.2 Hz, 3'-H), 7.40 (d, 1H, $J=4.8$ Hz, 3-H), 7.45 (dd, 1H, $J=5.1$, 1.2 Hz, 5'-H), 7.60–7.70 (m, 2H, $2 \times \text{Ar-H}$), 7.76–7.82 (m, 1H, Ar-H), 7.98 (dd, 1H, $J=7.7$, 1.2 Hz, Ar-H), 8.14 (d, 1H, $J=4.8$ Hz, 4-H), 8.17–8.20 (m, 1H, Ar-H), 8.38 (br d, 1H, $J=8.4$ Hz, Ar-H). ^{13}C NMR (CDCl_3) δ 110.90, 113.09, 114.13, 114.15, 121.05, 123.80, 125.35, 125.55, 127.56, 127.61, 128.07, 128.88, 128.95, 129.13, 129.46, 129.50, 130.76, 130.85, 132.06, 132.72, 134.26, 142.68. MS (EI) m/z (%): 376 (M^+ , 100), 375 (12), 346 (4), 311 (11), 273 (2), 241 (2), 136 (4), 127 (6), 126 (3), 69 (5). HRMS: m/z (EI) for $\text{C}_{23}\text{H}_{12}\text{N}_4\text{S}$; calcd 376.0783; found: 326.0781.

4.1.4. 1-(4''-Methoxyphenyl)-2-(2'-thienyl)-5-tricyanovinylpyrrole 1d. Dark red solid with metallic luster (50%). Mp: 156.9–157.2 °C. UV (EtOH): λ_{\max} nm ($\epsilon/M^{-1} \text{ cm}^{-1}$) 519.0 (31,639), 339.5 (4716), 297.5 (7226), 281.5 (7154), 232.5 (19,927). IR (Nujol) ν 2212 (CN), 1506, 1465, 1432, 1404, 1381, 1322, 1254, 1201, 1020, 987 cm^{-1} . ^1H NMR (Acetone- d_6) δ 3.97 (s, 3H, OCH_3), 7.09–7.13 (m, 1H, 4'-H), 7.17–7.23 (m, 3H, 3-H and 2 \times Ar-H), 7.43 (dd, 1H, $J=3.9, 1.2$ Hz, 3'-H), 7.56 (d, 2H, $J=9.2$ Hz, 2 \times Ar-H), 7.61 (dd, 1H, $J=5.1, 1.2$ Hz, 5'-H), 7.92 (d, 1H, $J=4.8$ Hz, 4-H). ^{13}C NMR (CDCl_3) δ 55.70, 111.06, 113.29, 113.96, 114.12, 115.30, 123.54, 125.83, 126.77, 127.74, 128.18, 129.14, 129.47, 131.16, 131.32, 142.36, 162.19. Anal. Calcd for $\text{C}_{20}\text{H}_{12}\text{N}_4\text{O}_2\text{S}$: C, 67.35; H, 3.40; N, 15.73; S, 9.00. Found: C, 67.03; H, 3.69; N, 15.40; S, 8.93.

4.1.5. 1-(2'',4''-Dimethoxyphenyl)-2-(2'-thienyl)-5-tricyanovinylpyrrole 1e. Red-violet solid with metallic luster (63%). Mp: 182.8–183.8 °C. UV (EtOH): λ_{\max} nm ($\epsilon/M^{-1} \text{ cm}^{-1}$) 525.5 (36,407), 335.0 (4502), 292.0 sh. (7730), 283.5 (9088), 232.5 (17,173). IR (Nujol) ν 2210 (CN), 1616, 1588, 1505, 1465, 1434, 1403, 1381, 1314, 1294, 1259, 1230, 1212, 1200, 1161, 1135, 1096, 1027, 986, 942, 850, 803, 787 cm^{-1} . ^1H NMR (Acetone- d_6) δ 3.83 (s, 3H, OCH_3), 3.97 (s, 3H, OCH_3), 6.77 (dd, 1H, $J=8.7, 2.7$ Hz, 5''-H), 6.86 (d, 1H, $J=2.7$ Hz, 3''-H), 7.11–7.14 (m, 1H, 4'-H), 7.24 (d, 1H, $J=4.8$ Hz, 3-H), 7.39 (d, 1H, $J=8.7$ Hz, 6''-H), 7.53 (dd, 1H, $J=3.9, 1.2$ Hz, 3'-H), 7.61 (dd, 1H, $J=5.2, 1.2$ Hz, 5'-H), 7.95 (d, 1H, $J=4.8$ Hz, 4-H). ^{13}C NMR (CDCl_3) δ 55.76, 55.93, 99.95, 105.46, 111.19, 113.63, 114.03, 114.47, 115.60, 123.79, 125.25, 127.65, 128.08, 129.06, 129.57, 131.19, 131.95, 142.69, 158.35, 164.04. Anal. Calcd for $\text{C}_{21}\text{H}_{14}\text{N}_4\text{O}_2\text{S}$: C, 65.27; H, 3.63; N, 14.50; S, 8.30. Found: C, 65.27; H, 3.86; N, 14.03; S, 8.38.

4.1.6. 1-(3'',5''-Dimethoxyphenyl)-2-(2'-thienyl)-5-tricyanovinylpyrrole 1f. Bronze-like lustrous crystals (37%). Mp: 149.3–150.3 °C. UV (EtOH): λ_{\max} nm ($\epsilon/M^{-1} \text{ cm}^{-1}$) 514.5 (24,604), 341.5 (4413), 286.0 (8144), 222.0 sh. (1851). IR (Nujol) ν 2216 (CN), 1607, 1512, 1466, 1429, 1407, 1292, 1238, 1209, 1176, 1157, 1005, 850, 768, 718 cm^{-1} . ^1H NMR (Acetone- d_6) δ 3.87 (s, 6H, 2 \times OCH_3), 6.86 (br s, 3H, 2'', 4'' and 6''-H), 7.10–7.14 (m, 1H, 4'-H), 7.17 (d, 1H, $J=4.8$ Hz, 3-H), 7.40 (dd, 1H, $J=2.7, 1.2$ Hz, 3'-H), 7.63 (dd, 1H, $J=5.2, 1.2$ Hz, 5'-H), 7.89 (d, 1H, $J=4.8$ Hz, 4-H). ^{13}C NMR (CDCl_3) δ 55.82, 103.39, 108.72, 110.93, 113.21, 113.98, 114.03, 123.53, 126.03, 127.32, 127.81, 129.07, 129.48, 130.95, 135.77, 141.74, 161.70. MS (EI) m/z (%): 386 (M^+ , 100), 360 (8), 149 (7), 98 (8). HRMS: (EI) m/z (%) for $\text{C}_{21}\text{H}_{14}\text{N}_4\text{O}_2\text{S}$; calcd 386.0837; found 386.0847.

4.1.7. 1-(3'',4'',5''-Trimethoxyphenyl)-2-(2'-thienyl)-5-tricyanovinylpyrrole 1g. Bronze-like lustrous crystals (73%). Mp: 206.8–207.6 °C. UV (EtOH): λ_{\max} nm ($\epsilon/M^{-1} \text{ cm}^{-1}$) 519.0 (30,842), 339.5 (4855), 283.0 (7558), 235.0 sh. (1493), 209.0 (48,174). IR (liquid film) ν 2207 (CN), 1593, 1503, 1426, 1402, 1383, 1297, 1227, 1185, 1166, 1126, 1080, 851, 830, 776, 673, 504 cm^{-1} . ^1H NMR (Acetone- d_6) δ 3.87 (s, 9H, 3 \times OCH_3), 7.04 (s, 2H, 2'' and 6''-H), 7.11–7.15 (m, 1H, 4'-H), 7.21 (d, 1H, $J=5.1$ Hz, 3-H), 7.48 (dd, 1H, $J=3.0, 1.2$ Hz, 3'-H), 7.64 (dd, 1H, $J=$

4.8, 1.2 Hz, 5'-H), 7.92 (d, 1H, $J=5.1$ Hz, 4-H). ^{13}C NMR (CDCl_3) δ 56.56, 61.49, 107.93, 111.15, 113.31, 113.85, 114.13, 123.59, 125.73, 127.79, 127.84, 129.19, 129.42, 129.70, 130.91, 141.43, 142.06, 154.24. MS (EI) m/z (%): 416 (M^+ , 100), 401 (9), 361 (5). HRMS: m/z (EI) for $\text{C}_{22}\text{H}_{16}\text{N}_4\text{O}_3\text{S}$; calcd 416.0943; found: 416.0991.

4.1.8. 1-(4''-Fluorophenyl)-2-(2'-thienyl)-5-tricyanovinylpyrrole 1h. Gold-like lustrous crystals (37%). Mp: 187–188 °C. UV (EtOH): λ_{\max} nm ($\epsilon/M^{-1} \text{ cm}^{-1}$) 510.5 (30,176), 333.0 (4248), 296.0 (6311), 228.8 (9076). IR (Nujol) ν 2204 (CN), 1503, 1466, 1433, 1403, 1380, 1320, 1194, 1090, 989, 851, 816, 775 cm^{-1} . ^1H NMR (Acetone- d_6) δ 7.10–7.14 (m, 1H, 4'-H), 7.20 (d, 1H, $J=4.8$ Hz, 3-H), 7.38 (dd, 1H, $J=3.9, 1.2$ Hz, 3'-H), 7.47 (t, 2H, $J=8.7$ Hz, 2 \times Ar-H), 7.63 (dd, 1H, $J=5.2, 1.2$ Hz, 5'-H), 7.77 (dd, 2H, $J=9.3, 4.8$ Hz, 2 \times Ar-H), 7.94 (d, 1H, $J=4.8$ Hz, 4-H). ^{13}C NMR (Acetone- d_6) δ 110.58, 112.18, 114.44, 114.91, 115.00, 117.86 (d, $J=23.2$ Hz, C3'', C5''), 124.18, 126.83, 128.64, 128.84, 130.68, 130.69, 131.90, 133.87 (d, $J=9.5$ Hz, C2'', C6''), 142.83, 165.35 (d, $J=249.8$ Hz, C4''). MS (EI) m/z (%): 344 (M^+ , 100), 318 (5), 242 (5), 208 (3), 169 (3), 145 (3), 95 (4), 84 (4), 69 (11). HRMS: m/z (EI) for $\text{C}_{19}\text{H}_9\text{FN}_4\text{S}$; calcd 344.0532; found: 344.0530.

4.1.9. 1-(4''-Bromophenyl)-2-(2'-thienyl)-5-tricyanovinylpyrrole 1i. Red-pink with metallic luster (31%). Mp: 175.1–175.4 °C. UV (EtOH): λ_{\max} nm ($\epsilon/M^{-1} \text{ cm}^{-1}$) 509.0 (30,457), 332.0 (4986), 293.0 (7093), 230.0 (19,779). IR (Nujol) ν 2213 (CN), 1505, 1427, 1401, 1322, 1231, 1200, 1067, 1014, 986, 846, 830, 786, 746, 724, 683, 634 cm^{-1} . ^1H NMR (Acetone- d_6) δ 7.10–7.14 (m, 1H, 4'-H), 7.18 (d, 1H, $J=4.8$ Hz, 3-H), 7.36 (dd, 1H, $J=3.8, 1.2$ Hz, 3'-H), 7.64 (dd, 1H, $J=5.1, 1.2$ Hz, 5'-H), 7.67 (d, 2H, $J=8.7$ Hz, 2 \times Ar-H), 7.89 (d, 2H, $J=8.7$ Hz, 2 \times Ar-H), 7.92 (d, 1H, $J=4.8$ Hz, 4-H). MS (EI) m/z (%): 406 (M^{+81}Br , 100), 404 (M^{+79}Br , 97), 403 (7), 325 (9), 297 (6), 249 (5), 216 (5), 196 (3), 163 (4), 149 (8), 136 (6), 76 (5). HRMS: m/z (EI) for $\text{C}_{19}\text{H}_9\text{BrN}_4\text{S}$; calcd 405.9711; found: 405.9726. Anal. Calcd for $\text{C}_{19}\text{H}_9\text{BrN}_4\text{S}$: C, 56.29; H, 2.22; N, 13.83; S, 7.92. Found: C, 56.12; H, 2.69; N, 13.22; S, 7.97.

Acknowledgements

Thanks are due to Foundation for Science and Technology (Portugal) for financial support through IBQF (UM) and through POCTI, FEDER (ref. POCTI/QUI/37816/2001).

References and notes

- Zyss, D. S. In *Non Linear Optical Properties of Organic Molecules and Crystals, Vols. 1 and 2*; Academic: Orlando, 1987.
- Prasad, P. N.; Williams, D. J. *Introduction to Nonlinear Optical Effects in Molecules and Polymers*; Wiley: New York, 1991; pp 132–174.
- Drost, K. J.; Jen, A. K.-I.; Rao, V. P. *Chem. Tech.* **1995**, 25, 16 and references cited therein.

4. Rao, V. P.; Jen, A. K.-I.; Wong, K. I.; Drost, K. J. *Tetrahedron Lett.* **1993**, *34*, 1747.
5. Mignani, G.; Leising, F.; Meyrueix, R.; Samson, M. *Tetrahedron Lett.* **1990**, *31*, 4743.
6. Effenberger, F.; Wurthner, F. *Angew. Chem.* **1993**, *105*, 742.
7. Effenberger, F.; Wurthner, F. *Angew. Chem., Int. Ed. Engl.* **1993**, *32*, 719.
8. Effenberger, F.; Wurthner, F.; Steybe, F. *J. Org. Chem.* **1995**, *60*, 2082.
9. Hutchins, M. G.; Ferguson, I.; McGeein, D. J.; Morley, J. O.; Ziss, J.; Ledoux, I. *J. Chem. Soc., Perkin Trans. 2* **1995**, *171*, 176.
10. Bedworth, P. V.; Cai, Y.; Jen, A.; Marder, S. R. *J. Org. Chem.* **1996**, *61*, 2242.
11. Steybe, F.; Effenberger, F.; Beckman, S.; Kramer, P.; Glania, C.; Wortmann, R. *Chem. Phys.* **1997**, *219*, 317.
12. Steybe, F.; Effenberger, F.; Gubler, U.; Bosshard, C.; Gunter, P. *Tetrahedron* **1998**, *54*, 8469.
13. Raposo, M. M. M.; Kirsch, G. *Tetrahedron* **2003**, *59*, 4891.
14. Raposo, M. M. M.; Fonseca, A. M. C.; Kirsch, G. *Tetrahedron* **2004**, *60*, 4071.
15. Raposo, M. M. M.; Fonseca, A. M. C.; Kirsch, G. *Mater. Sci. Forum* **2004**, *455–456*, 157.
16. Batista, R. M. F.; Costa, S. P. G.; Raposo, M. M. M. *Tetrahedron Lett.* **2004**, *45*, 2825.
17. Lucchesini, F. *Tetrahedron* **1992**, *48*, 9951.
18. Roncali, J. *Chem. Rev.* **1992**, *92*, 711.
19. Roncali, J. *Chem. Rev.* **1997**, *97*, 173.
20. Ogura, K.; Yanay, H.; Miokawa, M.; Akazome, M. *Tetrahedron Lett.* **1999**, *40*, 8887.
21. Zhao, R.; Akazome, M.; Matsumoto, S.; Ogura, K. *Tetrahedron* **2002**, *58*, 10225 and references cited there in.
22. Zhao, R.; Akazome, M.; Matsumoto, S.; Ogura, K. *Bull. Chem. Soc. Jpn.* **2002**, *75*, 2359.
23. Zhao, R.; Matsumoto, S.; Akazome, M.; Ogura, K. *Tetrahedron* **2002**, *58*, 10233.
24. Ogura, K.; Zhao, R.; Jiang, M.; Akazome, M.; Matsumoto, S.; Yamaguchi, K. *Tetrahedron Lett.* **2003**, *44*, 3595.
25. Just, P. E.; Chane-Ching, K. I.; Lacaze, P. C. *Tetrahedron* **2002**, *58*, 3467.
26. Kotkar, D.; Joshi, V.; Ghosh, P. K. *J. Chem. Soc., Chem. Commun.* **1988**, 917.
27. Parakka, J. P.; Cava, M. P. *Synth. Met.* **1995**, *68*, 275.
28. McCullough, R. D.; Lowe, R. D.; Jayaraman, M.; Anderson, D. *J. Org. Chem.* **1993**, *58*, 904.
29. Ono, K.; Totani, H.; Ohkita, M.; Saito, K.; Kato, M. *Heterocycles* **2004**, *64*, 223.
30. Eckert, K.; Schroder, A.; Hartmann, H. *Eur. J. Org. Chem.* **2000**, 1327 and references cited therein.
31. Raposo, M. M. M.; Kirsch, G. *Heterocycles* **2001**, *55*, 1487.
32. Costa, F.; Silva, C. J. R.; Raposo, M. M. M.; Fonseca, A. M.; Neves, I. C.; Carvalho, A. P.; Pires, J. *Microporous Mesoporous Mater.* **2004**, *72*, 111.
33. Raposo, M. M. M.; Sampaio, A. M. B. A.; Kirsch, G. *Synthesis* **2005**, *2*, 199.
34. Jackson, A. H. In *Pyrrroles*; Jones, R. A., Ed.; The Chemistry of Heterocyclic Compounds; Wiley: New York, 1990; Vol. 48, p 295; Part 1, and references cited therein.
35. Beleńkii, L. I. *Kim. Geterotsikl. Soed.* **1980**, *12*, 1587.
36. Beleńkii, L. I. *Heterocycles* **1994**, *37*, 2029.
37. Boukou-Poba, J.-P.; Farnier, M.; Guillard, R. *Tetrahedron Lett.* **1979**, *20*, 1717.
38. Boukou-Poba, J.-P.; Farnier, M.; Guillard, R. *Can. J. Chem.* **1981**, *59*, 2962.
39. Trofimov, B. A.; Korostova, S. E.; Mikhaleva, A. I.; Nesterenko, R. N.; Sigalov, M. V.; Voronov, V. K.; Polovnikova, R. I. *Zh. Org. Kim.* **1982**, *18*, 894.
40. Korostova, S. E.; Nesterenko, R. N.; Mikhaleva, A. I.; Shevchenko, S. G.; Kalabin, G. A.; Polovnikova, R. I. *Kim. Geterotsikl. Soedin.* **1990**, 273.
41. Korostova, S. E.; Nesterenko, R. N.; Mikhaleva, A. I.; Shevchenko, S. G.; Kalabin, G. A.; Polovnikova, R. I. *Kim. Geterotsikl. Soed.* **1991**, 337.
42. Korostova, S. E.; Mikhaleva, A. I.; Trofimov, B. A. *Russ. Chem. Rev. (Engl. Transl.)* **1999**, *68*, 459.
43. Trofimov, B. A.; Sobenina, L. N.; Demenev, A. P.; Mikhaleva, A. I.; Ushakov, I. A.; Tarasova, O. A.; Smirnov, V. I.; Petrushenko, K. B.; Vokin, A. I.; Murzina, N. M.; Myachina, G. F. *Arkivok* **2001**, *ix*, 37.
44. Raposo, M. M. M.; Sousa, A. M. R. C.; Fonseca, A. M. C.; Kirsch, G. *Tetrahedron* **2005**, *61*, 8249.
45. Casado, J.; Pappenfus, T. M.; Miller, L. L.; Mann, K. R.; Orti, E.; Viruela, P. M.; Pou-Amerigo, R.; Hernandez, V.; Navarrete, J. T. L. *J. Am. Chem. Soc.* **2003**, *125*, 2524.
46. Rao, V. P.; Jen, A. K.-Y.; Wang, K. Y.; Drost, K. J. *J. Chem. Soc., Chem. Commun.* **1993**, 1118.
47. Gilat, S. L.; Kawai, S. H.; Lehn, J.-M. *J. Chem. Soc., Chem. Commun.* **1993**, 1439.
48. Gilat, S. L.; Kawai, S. H.; Lehn, J.-M. *Chem. Eur. J.* **1995**, *1*, 275.
49. Kamlet, M. J.; Abboud, J.-L.M.; Abraham, M. H.; Taft, R. W. *J. Org. Chem.* **1983**, *48*, 2877.
50. Kamlet, M. J.; Abboud, J.-L.M.; Abraham, M. H.; Taft, R. W. *J. Am. Chem. Soc.* **1977**, *99*, 6027.
51. McCormac, T.; Farrell, D. *Electrochim. Acta* **2001**, *46*, 3287.
52. Pei, J.; Ni, J.; Zhou, X. H.; Cao, X. Y.; Lai, Y. H. *J. Org. Chem.* **2002**, *67*, 8104.
53. Clays, K.; Persoons, A. *Rev. Sci. Instrum.* **1992**, *63*, 3285.
54. Clays, K.; Persoons, A. *Phys. Rev. Lett.* **1991**, *66*, 2980.
55. Oudar, J. L. *J. Chem. Phys.* **1977**, *67*, 446.
56. Oudar, J. L.; Chemla, D. S. *J. Chem. Phys.* **1977**, *66*, 2664.
57. Zyss, J.; Oudar, J. L. *Phys. Rev. A* **1982**, *26*, 2016.
58. Teng, C. C.; Garito, A. F. *Phys. Rev. B* **1983**, *28*, 6766.
59. Stahelin, M.; Burland, D. M.; Rice, J. E. *Chem. Phys. Lett.* **1992**, *191*, 245.



Comparative reactivity of *N'*-(5-benzoyl/ethoxycarbonyl)thiazol-2-yl-*N,N*-dimethylformamidines with ketenes

Parvesh Singh, Alka Marwaha, Harmeet Singh and Mohinder P. Mahajan*

Department of Applied Chemistry, Guru Nanak Dev University, Amritsar 143005, Punjab, India

Received 14 June 2005; revised 18 August 2005; accepted 1 September 2005

Available online 28 October 2005

Abstract—The comparative account of the reactivities of *N'*-[(5-benzoyl and ethoxycarbonyl)thiazol-2-yl]-*N,N*-dimethylformamidines (**1a** and **1b**), tremendously influenced by the electronic nature of the substituents on C-5 of the thiazolic ring with various monosubstituted and conjugated ketenes is reported herein. The DA cycloadditions of the dienyl pyrimidinone **3h** with both symmetrical as well as unsymmetrical dienophiles leading to the formation of various thiazolic pyrimidinone derivatives are also reported.

© 2005 Published by Elsevier Ltd.

1. Introduction

The advent of various diazabutadienes as potential 4π components has extended their versatility by allowing easy access to various functionalized six-membered heterocycles.¹ Their cycloaddition reactions with ketenes continue to be an important area of scientific quest because of their synthetic potential and interesting mechanistic features.² Considerable attention has also been paid to for the development of suitable synthetic methodologies for efficient synthesis of appropriately substituted diazabutadienes including 1,3-diaza-1,3-butadienes.³ Recent reports from our laboratory have shown the development of simpler methods for the preparation of various acyclic 1,3-diazabuta-1,3-dienes and their successful utilization in [4+2] cycloaddition reactions with a variety of ketenes⁴ yielding a spectrum of biologically and medicinally important pyrimidinones.

In recent years, while in the process of synthesis and cycloadditions of cross-conjugated heterodienes starting from thiourea and its analogues, we came across two reports by Deniaud et al. regarding the synthesis and reactions with α -haloketones/acrylic dienophiles and reactions of the subsequent thiazolic/thiazinic diazadienes with various dienophiles such as acrylates and simple ketenes leading to the formation of various heterobicyclic compounds.⁵

The synthetic versatility of thiazolic diazadienes, despite

being excellent synthons, has largely remained unexplored. These have been reported to undergo [4+2] cycloadditions with highly reactive unsubstituted ketenes, generated, in situ, by the cracking of acetone or by treatment of methyl/ethylmalonyl chloride with triethylamine, leading to the formation of thiazolo-pyrimidinone derivatives.⁵ Their cycloadditions with other ketenes remained unattempted either because it evaded their attention or the authors failed to obtain any isolable product. Our continued interest in azadiene–ketene cycloadditions, relatively less explored chemistry of these thiazolic diazadienes towards ketenes and the significant pharmacological importance of the functionalized pyrimidinones have prompted us to examine the reactions of these thiazolic diazadienes with various simple and conjugated ketenes.

2. Results and discussion

The treatment of *N'*-[(5-benzoyl)thiazol-2-yl]-*N,N*-dimethylimidoforamide **1a** with monosubstituted ketenes such as phenyl, phenoxy, chloro, bromo, and cyano ketenes, generated, in situ, by the dropwise addition of their corresponding acid chlorides in triethylamine at room temperature. Careful chromatography of the crude adducts resulted in the isolation of the products albeit in yields much lower than (25–36%) normally obtained in other diazadiene–ketene reactions (Scheme 1).

The isolated products were characterized as thiazolo-pyrimidinones **2** on the basis of the available spectral evidences and analytical data (Scheme 2). The detailed spectral features are given in the Section 2; only the salient

Keywords: Azadienes; Ketenes; Cycloadditions; Thiazolic pyrimidinones; DA reactions.

* Corresponding author. Tel.: +91 183 2258802 09x3320; fax: +91 183 2258819 20; e-mail: mahajanmohinderp@yahoo.co.in

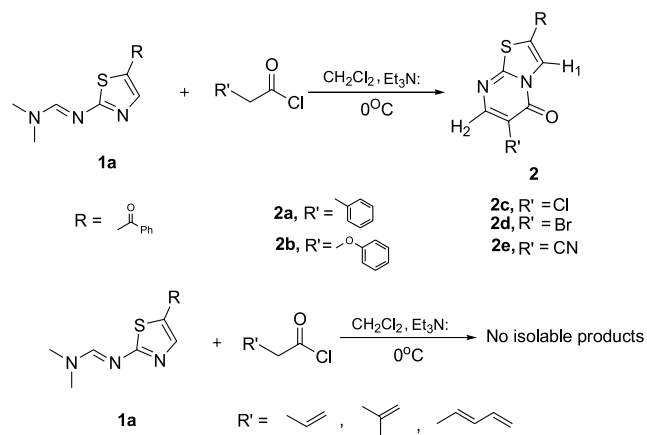

Scheme 1.

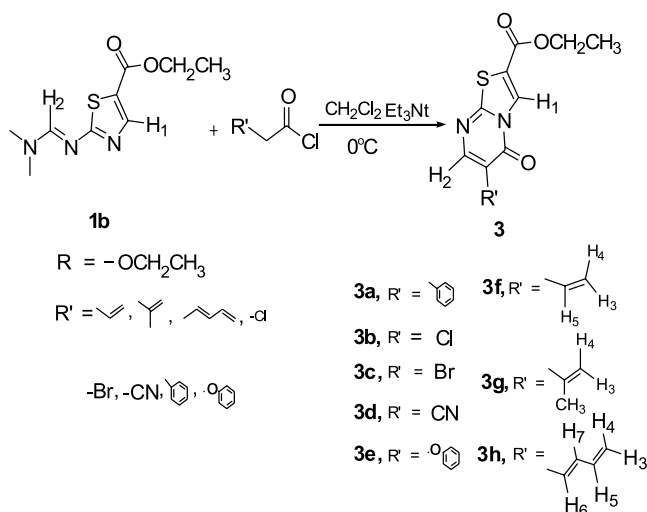

Scheme 2.

features being mentioned here. The compound 2-benzoyl-6-phenyl-thiazolo[3,2-*a*]pyrimidin-5-one **2a**, for example, analyzed for $\text{C}_{19}\text{H}_{12}\text{N}_2\text{O}_2\text{S}$, exhibited a molecular ion peak at m/z 332 (M^+) in the mass spectrum and the IR spectrum (KBr) showed a strong absorption peak at 1685 cm^{-1} due to α,β -unsaturated carbonyl group. The ^1H spectrum showed characteristic two singlets for deshielded olefinic protons H_1 and H_2 at δ 8.24 and 8.53, respectively. The structure of the compound **2a** was further corroborated by the ^{13}C spectrum, which showed characteristic peaks at δ 119.4, 128.0, 128.2, 128.4, 128.6, 129.0, 129.2, 130.1, 132.7, 133.9, 135.7, 152.0, 157.7, 161.5 and 186.4.

However, the reactions of **1a** with conjugated ketenes, such as vinyl, isopropenyl and butadienyl, generated, in situ, from the corresponding acid halides and triethyl amine, were found to be very sluggish and all attempts, by varying the reaction conditions, invariably resulted in an intractable mixture, from which no pure product could be isolated. It was felt that it may probably be the result of lower nucleophilicity of the thiazolic nitrogen of **1a** resulting, in turn, in its lower reactivity, largely being attributed to the extended conjugation of the π -electrons across the carbonyl group as shown in Figure 1.

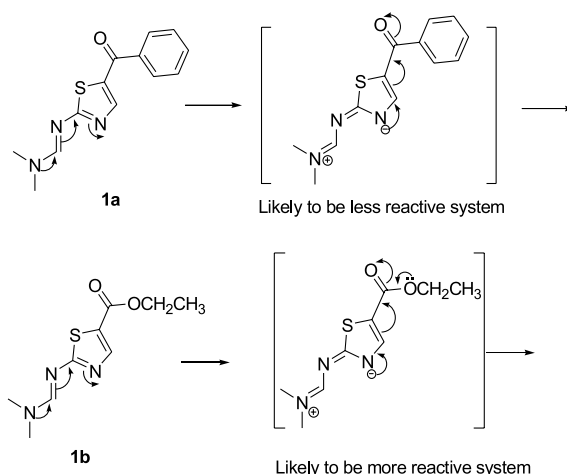

Figure 1.

Keeping this rationale in mind, it was thought that the nature of the substituents (withdrawing or donating) on carbonyl carbon may alter the nucleophilicity and hence the reactivity of the thiazolic nitrogen of such diaza-1,3-dienes. It was believed that the substitution of the phenyl on the carbonyl carbon by an alkoxy group might result in its lower electrophilicity and in turn higher nucleophilicity of thiazolic nitrogen of these thiazolic dienes. Keeping this in view, the desired system N' -[(5-ethoxycarbonyl)thiazol-2-yl]- N,N -diethylimidoforamide (**1b**) was prepared according to the reported procedure and its reactions with monosubstituted and conjugated ketenes were examined. As expected, the reactions of **1b** with monosubstituted ketenes such as phenyl, chloro, bromo, cyano and phenoxyketenes, generated in situ, from the corresponding acid chlorides in the presence of triethylamine in dry dichloromethane at 0°C , were found to be very neat and yielded a variety of substituted thiazolo-pyrimidinone derivatives **3** in good yields (72–88%)

The isolated compounds **3** were characterized on the basis of available spectral evidences and analytical data. The compound **3a**, characterized as 6-phenyl-5-oxo-5*H*-thiazolo[3,2-*a*]pyrimidine-2-carboxylic acid ethyl ester, showed in its ^1H NMR spectrum a triplet at δ 1.41 for $-\text{CH}_3$, a quartet at δ 4.40 for $-\text{CH}_2$ and two characteristic singlets at δ 7.98 and 8.57 for protons H_1 and H_2 , respectively, along with the multiplets for aromatic protons. Also a molecular ion peak at m/z 300 in the mass spectrum confirmed the structure of the compound.

The conjugated ketenes have been reported to participate as 4π as well as 2π component in [4+2] cycloaddition reactions.⁶ Hence, in order to compare the dienic properties of the thiazolic diazadienes with conjugated ketenes, we have examined the reactions of thiazolic diazadiene **1b** with various conjugated ketenes viz vinyl, isopropenyl and dienyl ketenes, generated in situ, from their corresponding acid chlorides in the presence of triethylamine. To our delight, the reactions were found to be very neat resulting in novel bicyclic thiazolic pyrimidinones **3** (75–90%) (Table 1).

The isolated products **3f–h** were characterized on the basis of the spectral and analytical evidences. The compound

Table 1. Yields and melting points of compounds (**2a–e**)

Compound no.	Ketene used	R = -phenyl	
		Yield (%)	Melting point (°C)
2a	Phenyl	36	158–160
2b	Phenoxy	25	135–136
2c	Chloro	34	185–187
2d	Bromo	28	177–179
2e	Cyano	31	166–167
—	Vinyl	—	—
—	Isopropenyl	—	—
—	Butadienyl	—	—

5-oxo-6-vinyl-5H-thiazolo[3,2-*a*]pyrimidine-2-carboxylic acid ethyl ester (**3f**), for example, analyzed for $C_{11}H_{10}N_2O_3S$, showed a molecular ion peak at m/z 250 in the mass spectrum and the IR spectrum (KBr) showed a strong absorption peak at 1670 cm^{-1} due to α,β -unsaturated carbonyl group and another peak at 1730 cm^{-1} corresponding to the carbonyl of an ester group. The ^1H spectrum exhibited a characteristic triplet at δ 1.43 and a quartet at δ 4.43 for $-\text{OCH}_2\text{CH}_3$ group. A doublet of doublets (dd) at δ 5.44 ($J=10.0, 1.4\text{ Hz}$) corresponding vinylic proton (H_3), one dd at δ 6.25 ($J=16.0, 1.4\text{ Hz}$) for vinylic proton (H_4) and one dd at δ 6.64 ($J=16.0, 10.0\text{ Hz}$) for vinylic proton (H_5) also support the structure of the product. The ^{13}C spectrum showed characteristic peaks at δ 14.2 and 62.8 corresponding to $-\text{CH}_3$ and $-\text{CH}_2$ carbons of the $-\text{OCH}_2\text{CH}_3$ group. Other peaks at 116.4, 118.1, 120.7, 127.1, 128.5, 151.2, 156.9, 159.8 and 160.8 were also in agreement with the assigned structure of the compound.

In recent years, various functionalized pyrimidinones, substituted either at C-5 or C-6 position, have emerged as broad spectrum drugs in the field of chemotherapy and selective antitumour, antiviral, antitubercular and antifungal

activities are documented in the literature.⁷ It was felt that 5-dienyl pyrimidinones **3h** can be utilized as functional synthons in Diels–Alder cycloadditions reactions for a variety of such substituted fused pyrimidinones.⁸ Therefore, we carried out the Diels–Alder cycloaddition reactions of the resulted bicyclic pyrimidinone **3h** with various symmetrical as well as unsymmetrical dienophiles (Scheme 3).

The reactions of **3h** with symmetrical dienophiles such as *N*-phenylmaleimide, *N*-*p*-tolylmaleimide and maleic anhydride, carried out in refluxing toluene for 16–18 h, were found to be highly diastereoselective resulting in exclusive formation of *endo* adducts **4**. The structures of these *endo* adducts were assigned on the basis of their spectral data and elemental analysis. The compound **4a**, for example, analyzed for $C_{23}H_{17}N_3O_5S$, showed a molecular ion peak at m/z 447 in the mass spectrum and two strong peaks at 1708 and 1666 cm^{-1} due to an ester carbonyl and α,β -unsaturated carbonyl groups, respectively, in the IR spectrum. The ^1H spectrum exhibited an unresolved ddd at δ 2.40 ($J=7.5, 15.3\text{ Hz}$) for H_{6a} , an unresolved ddd at δ 2.99 ($J=4.5, 15.3\text{ Hz}$) for H_{6b} , a ddd at δ 3.44 ($J=1.8, 7.2, 9.3\text{ Hz}$) for H_7 , a dd at δ 3.79 ($J=6.9, 9.1\text{ Hz}$) for H_8 and an unresolved dd at δ 3.97 ($J=6.6\text{ Hz}$) for H_3 in addition to the multiplets in range 6.21–6.23 for protons H_4 and H_5 . Also apparent two sharp singlets at δ 7.99 and 8.58 corresponding to protons H_1 and H_2 , respectively. The presence of an unresolved dd at δ 3.97 ($J=6.6\text{ Hz}$) for H_3 proton clearly depicts the *syn* stereo-chemical relationship with H_8 proton, thus establishing the *endo* nature of the adduct. The ^{13}C spectrum showed peaks at δ 14.1 ($-\text{CH}_3$), 24.3 [C (H-6)], 33.4 [C (H-7)], 39.8 [C (H-8)], 42.0 [C (H-3)], 62.7 ($-\text{OCH}_2$), 120.7, 126.2, 126.7, 128.0, 128.2, 128.4, 128.9, 129.4, 131.6, 151.7, 158.3, 159.7, 161.1, 176.2 and 178.3, which were in agreement with the structure assigned above.

The reactions of **3h** with unsymmetrical dienophiles such as methylacrylate and acrylonitrile, in refluxing toluene carried out for 16–18 h, led to the formation of the products, which were found to be a mixture of regioisomers (*ortho/meta*: 70:30), their relative ratio being estimated on the basis of the spectral data of the compounds isolated. The major isomer was found to be *ortho-endo* adduct as shown by the presence of a doublet of doublet at δ 4.13 for proton H_3 having coupling constants 3.2 and 9.2 Hz, peaks characteristic for *ortho* addition, in the proton spectrum of **5a**. This also confirmed its *syn* stereochemistry with regards to the neighbouring proton H_8 . The *ortho-endo* adduct was further corroborated with the help of ^{13}C and DEPT NMR analysis, the details being mentioned in the experimental section. The *exo-endo* nature of the *meta* regio-isomer was not ascertained due to complexity of the spectra.

In conclusion, a generalized and relevant study regarding the reactivity of thiazolic diazadienes **1a** and **1b**, with monosubstituted as well as conjugated ketenes has been investigated leading to the synthesis of various novel bicyclic thiazolic pyrimidinone derivatives **2** and **3**. The manuscript assumes further significance as the 5-dienyl-pyrimidinone **3h**, thus obtained, has been used as a precursor in the synthesis of various substituted bicyclic pyrimidinones **4** and **5** by carrying out reactions with

**Scheme 3.**

Table 2. Yields and melting points of compounds (**3a–h**)

Compound no.	Ketene used	R = -OC ₂ H ₅	
		Yield (%)	Melting point (°C)
3a	Phenyl	85	183–184
3b	Chloro	82	193–194
3c	Bromo	72	143–145
3d	Cyano	73	132–133
3e	Phenoxy	88	140–141
3f	Vinyl	75	135–136
3g	Isopropenyl	80	155–156
3h	Butadienyl	90	150–151

symmetrical as well as unsymmetrical dienophiles. The biological and medicinal importance of these pyrimidinones is well established in the literature¹¹ (Table 2).

3. Experimental

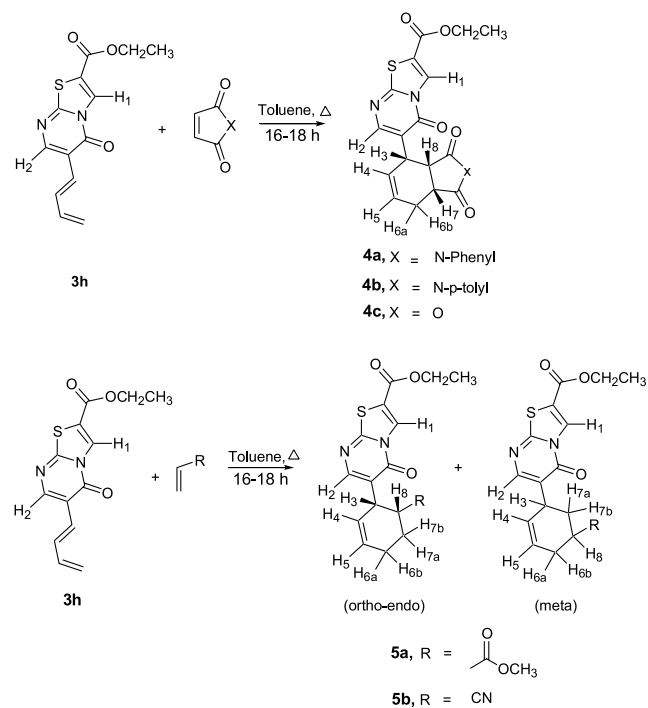
Melting points were determined by open capillary method using Veego Precision Digital Melting Point apparatus (MP-D) and are uncorrected. IR spectra were recorded on a Shimadzu D-8001 spectrophotometer. ¹H NMR spectra were recorded in deuteriochloroform with Bruker AC-E 200 (200 MHz) and AC-E 300 (300 MHz) spectrometers using TMS as internal standard. Chemical shift values are expressed as ppm downfield from TMS and *J* values are in Hz. Splitting patterns are indicated as s: singlet, d: doublet, t: triplet, m: multiplet and q: quartet. ¹³C NMR spectra were also recorded on a Bruker AC-200E (50.4 MHz) or AC-E 300 (75.0 MHz) spectrometers in a deuteriochloroform using TMS as internal standard. Mass spectra were recorded on Shimadzu GCMS-QP-2000 mass spectrometer. Elemental analyses were performed on Heraeus CHN-O-Rapid Elemental Analyzer. Column chromatography was performed on a silica gel (60–120) mesh or Harrison Research Chromatotron using 2 mm plates (silica gel PF₂₅₄). Dichloromethane dried over di-phosphorous pentoxide and after distillation stored over molecular sieves (4 Å).

3.1. Starting materials

DMF-DMA⁹, *N'*-[5-(benzoyl)thiazol-2-yl]-*N,N*-dimethylformamide (**1a**),⁵ *N'*-bis [(dimethylamino)methylene]thiourea, *N'*-[5-(ethoxycarbonyl)thiazol-2-yl]-*N,N*-dimethylformamide (**1b**), were prepared according to the reported procedures. Crotonyl-, 3,3-dimethylacryl-, bromoacetyl-, cyanoacetyl-, phenoxyacetyl-, phenylacetyl-, chlorides and sorbyl chloride¹⁰ were prepared from the corresponding acid and thionyl chloride. Chloroacetyl chloride and thionyl chloride were distilled before use.

3.2. General procedure for preparation of *N'*-[5-(benzoyl)thiazol-2-yl]-*N,N*-dimethylformamide (**1a**), *N'*-[5-(ethoxycarbonyl)thiazol-2-yl]-*N,N*-di-methylformamide (**1b**)

A solution of phenacyl bromide (5 mmol)/ethylbromoacetate (5 mmol) and *N'*-bis [(dimethylamino) methylene] thiourea (5 mmol) in dichloromethane (15 mL) was stirred under nitrogen at room temperature for 15 min and then triethylamine (10 mmol) was added. The reaction mixture

was then stirred for a further 10 h. After removal of the solvent, the residue was chromatographed with dichloromethane–ethylacetate (4/1) as eluent. Solid material was thus, obtained by recrystallisation from diethyl ether.

3.2.1. *N'*-[5-(Benzoyl)thiazol-2-yl]-*N,N*-dimethylformamide (1a**).** Pale yellow solid, yield: 73%; mp 106–108 °C. Anal. Calcd for C₁₃H₁₃N₃OS: C, 60.21; H, 5.05; N, 16.20. Found: C, 59.98; H, 4.97; N, 16.01%. IR (KBr) ν_{\max} : 2920, 1620, 1401 cm⁻¹. δ_{H} (200 MHz, CDCl₃): 3.10 [s, 3H, N(CH₃)₂], 3.12 [s, 3H, N(CH₃)₂], 7.40–7.76 (m, 5H, Ar), 7.81 (s, 1H, H₁), 8.25 (s, 1H, H₂). δ_{C} (75 MHz, CDCl₃): 35.3 and 41.4 [2C, N(CH₃)₂], 126.8 (SCCO), 130.3, 131.7, 133.2, 137.2, 149.2 (C-4), 156.5 (NCH), 178.2 (SCN) and 185.6 (CO). *m/z*: 259 (M⁺).

3.2.2. *N'*-[5-(Ethoxycarbonyl)thiazol-2-yl]-*N,N*-di-methylformamide (1b**).** Pale white crystalline solid, yield: 86%; mp 116–118 °C. Anal. Calcd for C₉H₁₃N₃O₂S: C, 47.56; H, 5.77; N, 18.49. Found: C, 47.88; H, 5.62; N, 18.35%. IR (KBr) ν_{\max} : 3080, 1712, 1618, 1401 cm⁻¹. δ_{H} (200 MHz, CDCl₃): 1.29 (t, 3H, *J*=8.0 Hz, -O-C-CH₃), 3.01 [s, 3H, N(CH₃)₂], 3.04 [s, 3H, N(CH₃)₂], 4.23 (q, 2H, *J*=8.0 Hz, -OCH₂), 7.89 (s, 1H, H₁), 8.27 (s, 1H, H₂). δ_{C} (75 MHz, CDCl₃): 14.1 (-CH₃), 35.4 and 41.6 [2C, N(CH₃)₂], 62.8 (-OCH₂), 127.2 (SCCO), 149.6 (C-4), 158.5 (NCH), 172.1 (SCN) and 179.2 (CO). *m/z*: 227 (M⁺).

3.3. General procedure for the reaction of thiazolic 1,3-diazadienes **1** with conjugated and monosubstituted ketenes

General procedure. To a well-stirred solution of diazadiene **1** (10 mmol) and triethylamine (40 mmol) in dry methylene chloride (30 mL) was added drop wise a solution of crotonyl chloride/3,3-dimethylacryl chloride/sorbyl chloride/chloroacetyl chloride/bromoacetyl chloride/cyanoacetyl chloride/phenyl acetyl chloride/phenoxyacetyl chloride (20 mmol) in dry methylene chloride (30 mL) over a period of 1 h at room temperature (0 °C). After completion of the reaction (TLC), the reaction mixture was first washed with saturated sodium bicarbonate solution (2 × 25 mL) and water (2 × 50 mL) and the organic layer dried over anhydrous sodium sulfate. Removal of solvent under reduced pressure yielded the crude product, which was purified by silica gel column chromatography using a mixture of ethylacetate and hexane (1:10, v/v).

3.3.1. 2-Benzoyl-6-phenyl-thiazolo[3,2-*a*]pyrimidin-5-one (2a**).** Colourless solid, yield: 36%; mp 158–160 °C. Anal. Calcd for C₁₉H₁₂N₂O₂S: C, 68.66; H, 3.64; N, 8.43. Found: C, 68.52; H, 3.56; N, 8.32. IR (KBr) ν_{\max} : 1685, 1587, 1225 cm⁻¹. δ_{H} (200 MHz, CDCl₃): 7.42–7.93 (m, 10H, ArH), 8.24 (s, 1H, H₁), 8.53 (s, 1H, H₂). δ_{C} (75 MHz, CDCl₃): 119.4, 128.0, 128.2, 128.4, 128.6, 129.0, 129.2, 130.1, 132.7, 133.9, 135.7, 152.0, 157.7, 161.5 and 186.4. *m/z*: 332 (M⁺).

3.3.2. 2-Benzoyl-6-phenoxy-thiazolo[3,2-*a*]pyrimidin-5-one (2b**).** Colourless crystalline solid, yield: 25%; mp 135–136 °C. Anal. Calcd for C₁₉H₁₂N₂O₃S: C, 65.50; H, 3.47; N, 8.04. Found: C, 65.65; H, 3.41; N, 7.98. IR (KBr) ν_{\max} : 1682, 1579, 1230 cm⁻¹. δ_{H} (200 MHz, CDCl₃):

7.37–7.98 (m, 10H, ArH), 8.31 (s, 1H, H₁), 8.62 (s, 1H, H₂). δ_{C} (75 MHz, CDCl₃): 120.1, 127.2, 128.1, 128.3, 128.6, 129.1, 129.3, 129.9, 131.1, 133.1, 133.9, 151.1, 158.2, 163.0 and 187.0. m/z : 348 (M⁺).

3.3.3. 2-Benzoyl-6-chloro-thiazolo[3,2-*a*]pyrimidin-5-one (2c). Colourless solid, yield: 34%; mp 185–187 °C. Anal. Calcd for C₁₃H₇ClN₂O₂S: C, 53.71; H, 2.43; N, 9.64. Found: C, 53.82; H, 2.38; N, 9.55. IR (KBr) ν_{max} : 1682, 1546, 1323, cm⁻¹. δ_{H} (200 MHz, CDCl₃): 7.27–7.94 (m, 5H, ArH), 8.23 (s, 1H, H₁), 8.63 (s, 1H, H_b). δ_{C} (75 MHz, CDCl₃): 116.2, 124.5, 125.7, 129.0, 132.4, 134.3, 136.7, 150.8, 154.2, 162.2 and 185.8. m/z : 290 (M⁺).

3.3.4. 2-Benzoyl-6-bromo-thiazolo[3,2-*a*]pyrimidin-5-one (2d). Colourless solid, yield: 28%; mp 177–179 °C. Anal. Calcd for C₁₃H₇BrN₂O₂S: C, 46.58; H, 2.11; N, 8.36. Found: C, 46.42; H, 2.16; N, 8.32. IR (KBr) ν_{max} : 1676, 1539, 743 cm⁻¹. δ_{H} (200 MHz, CDCl₃): 6.92–7.01 (m, 5H, ArH), 8.12 (s, 1H, H₁), 8.58 (s, 1H, H₂). δ_{C} (75 MHz, CDCl₃): 117.2, 125.4, 126.6, 129.1, 131.7, 134.5, 135.9, 152.0, 153.4, 160.6 and 185.2. m/z : 335 (M⁺).

3.3.5. 2-Benzoyl-6-cyano-thiazolo[3,2-*a*]pyrimidin-5-one (2e). Light yellow solid, yield: 31%; mp 166–167 °C. Anal. Calcd for C₁₄H₇N₃O₂S: C, 59.78; H, 2.51; N, 14.94. Found: C, 59.82; H, 2.44; N, 14.87. IR (KBr) ν_{max} : 2218, 1688, 817 cm⁻¹. δ_{H} (200 MHz, CDCl₃): 7.34–7.99 (m, 5H, ArH), 8.06 (s, 1H, H₁), 8.45 (s, 1H, H₂). δ_{C} (75 MHz, CDCl₃): 115.7, 118.6, 127.2, 127.8, 130.2, 131.9, 135.4, 136.0, 155.6, 163.1, 164.2 and 186.1 m/z : 281 (M⁺).

3.3.6. 6-Phenyl-5-oxo-5H-thiazolo[3,2-*a*]pyrimidine-2-carboxylic acid ethyl ester (3a). Pale white solid, yield: 85%; mp 183–184 °C. Anal. Calcd for C₁₅H₁₂N₂O₃S: C, 59.99; H, 4.03; N, 9.33. Found: C, 59.87; H, 3.97; N, 9.27%. IR (KBr) ν_{max} : 1726, 1652, 1597, 743 cm⁻¹. δ_{H} (200 MHz, CDCl₃): 1.41 (t, 3H, $J=8.0$ Hz, –O–C–CH₃), 4.40 (q, 2H, $J=8.0$ Hz, –OCH₂), 6.99–7.37 (m, 5H, ArH) 7.98 (s, 1H, H₁), 8.57 (s, 1H, H₂). δ_{C} (75 MHz, CDCl₃): 14.1 (–CH₃), 62.9 (–OCH₂), 116.7, 121.8, 123.5, 126.7, 129.8, 137.3, 143.6, 154.4, 157.0, 158.1 and 160.0. m/z : 300 (M⁺).

3.3.7. 6-Chloro-5-oxo-5H-thiazolo[3,2-*a*]pyrimidine-2-carboxylic acid ethyl ester (3b). Colourless solid, yield: 82%; mp 193–194 °C. Anal. Calcd for C₉H₇ClN₂O₃S: C, 41.79; H, 2.73; N, 10.83. Found: C, 41.82; H, 2.61; N, 10.74%. IR (KBr) ν_{max} : 1728, 1682, 1546, 1323, 923, 744 cm⁻¹. δ_{H} (200 MHz, CDCl₃): 1.43 (t, 3H, $J=8.0$ Hz, –O–C–CH₃), 4.46 (q, 2H, $J=8.0$ Hz, –OCH₂), 8.23 (s, 1H, H₁), 8.63 (s, 1H, H₂). δ_{C} (75 MHz, CDCl₃): 14.1 (–CH₃), 63.1 (–OCH₂), 115.6, 122.2, 126.8, 151.3, 154.9, 159.5 and 161.2. m/z : 258 (M⁺).

3.3.8. 6-Bromo-5-oxo-5H-thiazolo[3,2-*a*]pyrimidine-2-carboxylic acid ethyl ester (3c). Pale yellow solid, yield: 72%; mp 143–145 °C. Anal. Calcd for C₉H₇BrN₂O₃S: C, 35.66; H, 2.33; N, 9.24. Found: C, 35.49; H, 2.26; N, 9.09%. IR (KBr) ν_{max} : 1730, 1666, 742 cm⁻¹. δ_{H} (200 MHz, CDCl₃): 1.42 (t, 3H, $J=8.0$ Hz, –O–C–CH₃), 4.45 (q, 2H, $J=8.0$ Hz, –OCH₂), 8.19 (s, 1H, H₁), 8.54 (s, 1H, H₂). δ_{C} (75 MHz, CDCl₃): 14.2 (–CH₃), 62.8 (–OCH₂), 115.6, 123.2, 126.9, 152.4, 155.9, 159.7 and 163.1. m/z : 303 (M⁺).

3.3.9. 6-Cyano-5-oxo-5H-thiazolo[3,2-*a*]pyrimidine-2-carboxylic acid ethyl ester (3d). Colourless solid, yield: 73%; mp 132–133 °C. Anal. Calcd for C₁₀H₇N₃O₃S: C, 48.19; H, 2.83; N, 16.86. Found: C, 48.28; H, 2.79; N, 16.79%. IR (KBr) ν_{max} : 1742, 1327, 732 cm⁻¹. δ_{H} (200 MHz, CDCl₃): 1.39 (t, 3H, $J=8.0$ Hz, –O–C–CH₃), 4.38 (q, 2H, $J=8.0$ Hz, –OCH₂), 8.21 (s, 1H, H₁), 8.49 MHz (s, 1H, H₂). δ_{C} (75 MHz, CDCl₃): 14.1 (–CH₃), 63.6 (–OCH₂), 115.7, 118.8, 124.3, 125.5, 151.7, 154.9, 160.2 and 163.5. m/z : 249 (M⁺).

3.3.10. 6-Phenoxy-5-oxo-5H-thiazolo[3,2-*a*]pyrimidine-2-carboxylic acid ethyl ester (3e). Colourless solid, yield: 88%; mp 140–141 °C. Anal. Calcd for C₁₅H₁₂N₂O₄S: C, 56.95; H, 3.82; N, 8.86. Found: C, 56.86; H, 3.74; N, 8.71%. IR (KBr) ν_{max} : 1728, 1666, 1512, 1334, 1078, 783 cm⁻¹. δ_{H} (200 MHz, CDCl₃): 1.43 (t, 3H, $J=8.0$ Hz, –O–C–CH₃), 4.49 (q, 2H, $J=8.0$ Hz, –OCH₂), 7.33–7.78 (m, 5H, ArH), 8.28 (s, 1H, H₁), 8.75 (s, 1H, H₂). δ_{C} (75 MHz, CDCl₃): 14.2 (–CH₃), 63.0 (–OCH₂), 119.4, 120.8, 127.5, 128.2, 128.4, 128.5, 133.0, 152.1, 157.4, 160.0, and 161.1. m/z : 316 (M⁺).

3.3.11. 5-Oxo-6-vinyl-5H-thiazolo[3,2-*a*]pyrimidine-2-carboxylic acid ethyl ester (3f). Colourless solid, yield: 75%; mp 135–136 °C. Anal. Calcd for C₁₁H₁₀N₂O₃S: C, 52.79; H, 4.03; N, 11.19. Found: C, 52.71; H, 3.99; N, 11.11%. IR (KBr) ν_{max} : 1730, 1670, 1504, 1247 cm⁻¹. δ_{H} (200 MHz, CDCl₃): 1.43 (t, 3H, $J=8.0$ Hz, –O–C–CH₃), 4.43 (q, 2H, $J=8.0$ Hz, –OCH₂), 5.44 (dd, 1H, $J=10.0$, 1.4 Hz, H₃), 6.25 (dd, 1H, $J=16.0$, 1.4 Hz, H₄), 6.64 (dd, 1H, $J=16.0$, 10.0 Hz, H₅), 8.07 (s, 1H, H₁), 8.62 (s, 1H, H₂). δ_{C} (75 MHz, CDCl₃): 14.2 (–CH₃), 62.8 (–OCH₂), 116.4, 118.1, 120.7, 127.1, 128.5, 151.2, 156.9, 159.8 and 160.8 m/z : 250 (M⁺).

3.3.12. 5-Oxo-6-isopropenyl-5H-thiazolo[3,2-*a*]pyrimidine-2-carboxylic acid ethyl ester (3g). Colourless crystalline solid, yield: 80%; mp 155–156 °C. Anal. Calcd for C₁₂H₁₂N₂O₃S: C, 54.53; H, 4.58; N, 10.60. Found: C, 54.49; H, 4.50; N, 10.56%. IR (KBr) ν_{max} : 1726, 1666, 1591, 1353 cm⁻¹. δ_{H} (200 MHz, CDCl₃): 1.37 (t, 3H, $J=8.0$ Hz, –O–C–CH₃), 2.16 (s, 3H, –CH₃), 4.39 (q, 2H, $J=.0$ Hz, –OCH₂), 5.28 (s, 1H, H₃), 5.79 (s, 1H, H₄), 8.04 (s, 1H, H₁), 8.59 (s, 1H, H₂). δ_{C} (75 MHz, CDCl₃): 14.1 (–CH₃), 19.8 (olefinic-CH₃), 62.7 (–OCH₂), 117.1, 118.4, 121.2, 128.0, 128.7, 150.9, 157.1, 159.7 and 161.2. m/z : 264 (M⁺).

3.3.13. 5-Oxo-6-dienyl-5H-thiazolo[3,2-*a*]pyrimidine-2-carboxylic acid ethyl ester (3h). Yellow crystalline solid, yield: 90%; mp 150–151 °C. Anal. Calcd for C₁₃H₁₂N₂O₃S: C, 56.51; H, 4.38; N, 10.14. Found: C, 56.39; H, 4.34; N, 10.01%. IR (KBr) ν_{max} : 1726, 1668, 1548, 1093, 902 cm⁻¹. δ_{H} (200 MHz, CDCl₃): 1.40 (t, 3H, $J=8.0$ Hz, –O–C–CH₃), 4.42 (q, 2H, $J=8.0$ Hz, –OCH₂), 5.19 (dd, 1H, $J=10.0$, 2.0 Hz, H₃), 5.36 (dd, 1H, $J=16.0$, 2.0 Hz, H₄), 6.41–6.50 (m, 2H, H₅, H₆), 7.30 (m, 1H, H₇) 8.05 (s, 1H, H₁), 8.60 (s, 1H, H₂). δ_{C} (75 MHz, CDCl₃): 14.1 (–CH₃), 62.8 (–OCH₂), 116.4, 118.8, 120.8, 124.4, 127.2, 133.2, 137.5, 150.9, 156.8, 159.8 and 160.8. m/z : 276 (M⁺).

3.4. General procedure for Diels–Alder cycloaddition between **3c** and dienophiles

Bicyclic pyrimidinone **3c** (5.0 mmol) and dienophiles [*N*-phenylmaleimide (5.0 mmol), *N*-tolylmaleimide (5.0 mmol), maleic anhydride (5.0 mmol), methylacrylate (5.2 mmol) and acrylonitrile (5.2 mmol)] were refluxed in dry toluene for 16–18 h. The solvent was removed under reduced pressure and the crude product thus obtained was purified by recrystallisation from a mixture (1:5, v/v) of ethylacetate and hexane.

3.4.1. 6-(1,3-Dioxo-2-phenyl-2,3,3a,4,7,7a-hexahydro-1H-isoindol-4-yl)-5-oxo-5H-thiazolo[3,2-*a*]pyrimidine-2-carboxylic acid ethyl ester (4a). Light yellow solid, yield: 82%; mp 207–208 °C. Anal. Calcd for C₂₃H₁₉N₃O₅S: C, 61.46; H, 4.26; N, 9.35. Found: C, 61.86; H, 4.61; N, 9.32%. IR (KBr) ν_{\max} : 1708, 1666, 1510, 1386 cm⁻¹. δ_{H} (300 MHz, CDCl₃): 1.42 (t, 3H, *J* = 7.2 Hz, –O–C–CH₃), 2.40 (unresolved ddd, *J* = 7.5, 15.3 Hz, 1H, H_{6a}), 2.99 (unresolved ddd, *J* = 4.5, 15.3 Hz, 1H, H_{6b}), 3.44 (ddd, *J* = 1.8, 7.2, 9.3 Hz, 1H, H₇), 3.79 (dd, *J* = 6.9, 9.1 Hz, 1H, H₈), 3.97 (unresolved dd, *J* = 6.6 Hz, 1H, H₃), 4.42 (q, *J* = 7.2 Hz, 2H, –OCH₂), 6.21–6.23 (m, 2H, H₄ and H₅), 7.15–7.43 (m, 5H, ArH), 7.99 (s, 1H, H₁), 8.58 (s, 1H, H₂). δ_{C} (75 MHz, CDCl₃): 14.1 (–CH₃), 24.3 [C (H-6)], 33.4 [–C (H-7)], 39.8 [–C (H-8)], 42.0 [–C (H-3)], 62.7 (–OCH₂), 120.7, 126.2, 126.7, 128.0, 128.2, 128.4, 128.9, 129.4, 131.6, 151.7, 158.3, 159.7, 161.1, 176.2 and 178.3. *m/z*: 449 (M⁺).

3.4.2. 6-(1,3-Dioxo-2-*p*-tolyl-2,3,3a,4,7,7a-hexahydro-1H-isoindol-4-yl)-5-oxo-5H-thiazolo[3,2-*a*]pyrimidine-2-carboxylic acid ethyl ester (4b). Pale white solid, yield: 81%; mp 213–215 °C. Anal. Calcd for C₂₄H₂₁N₃O₅S: C, 62.19; H, 4.57; N, 9.07. Found: C, 62.49; H, 4.22; N, 8.99%. IR (KBr) ν_{\max} : 1712, 1669, 1512 cm⁻¹. δ_{H} (300 MHz, CDCl₃): 1.41 (t, 3H, *J* = 7.2 Hz, –O–C–CH₃), 2.39 (s, 3H, –CH₃), 2.42 (unresolved ddd, *J* = 7.5, 15.2 Hz, 1H, H_{6a}), 3.01 (unresolved ddd, *J* = 4.2, 15.2 Hz, 1H, H_{6b}), 3.43 (ddd, *J* = 1.8, 7.5, 9.5 Hz, 1H, H₇), 3.81 (dd, *J* = 6.6, 9.2 Hz, 1H, H₈), 3.96 (unresolved dd, *J* = 6.8 Hz, 1H, H₃), 4.41 (q, *J* = 7.2 Hz, 2H, –OCH₂), 6.20–6.23 (m, 2H, H₄ and H₅), 6.98–7.01 (d, *J* = 8.0 Hz, 2H, ArH), 7.02–7.04 (d, *J* = 8.0 Hz, 2H, ArH), 7.98 (s, 1H, H₁), 8.59 (s, 1H, H₂). δ_{C} (75 MHz, CDCl₃): 14.1 (–O–C–CH₃), 20.9 (–CH₃), 24.3 [–C (H-6)], 33.3 [–C (H-7)], 39.9 [–C (H-8)], 42.1 [–C (H-3)], 62.8 (–OCH₂), 120.6, 125.8, 126.4, 127.8, 128.4, 129.1, 130.2, 131.4, 135.2, 152.6, 158.2, 159.6, 161.2, 176.3 and 178.2. *m/z*: 463 (M⁺).

3.4.3. 6-(1,3-Dioxo-1,3,3a,4,7,7a-hexahydro-isobenzofuran-4-yl)-5-oxo-5H-thiazolo[3,2-*a*]pyrimidine-2-carboxylic acid ethyl ester (4c). Colorless solid, yield: 72%; mp 219–221 °C. Anal. Calcd for C₁₇H₁₄N₂O₆S: C, 54.54; H, 3.77; N, 7.48. Found: C, 54.68; H, 3.67; N, 7.34%. IR (KBr) ν_{\max} : 1710, 1665, 1514 cm⁻¹. δ_{H} (300 MHz, CDCl₃): 1.42 (t, 3H, *J* = 7.2 Hz, –O–C–CH₃), 2.40 (unresolved ddd, *J* = 7.4, 15.1 Hz, 1H, H_{6a}), 2.99 (unresolved ddd, *J* = 4.3, 15.2 Hz, 1H, H_{6b}), 3.44 (ddd, *J* = 1.7, 7.2, 9.5 Hz, 1H, H₇), 3.82 (dd, *J* = 6.5, 9.5 Hz, 1H, H₈), 3.97 (unresolved dd, *J* = 6.6 Hz, 1H, H₃), 4.41 (q, *J* = 7.2 Hz, 2H, –OCH₂), 6.19–6.23 (m, 2H, H₄ and H₅), 7.99 (s, 1H, H₁), 8.61 (s, 1H, H₂). δ_{C}

(75 MHz, CDCl₃): 14.1 (–O–C–CH₃), 24.4 [–C (H-6)], 34.1 [–C (H-7)], 39.5 [–C (H-8)], 42.2 [–C (H-3)], 62.7 (–OCH₂), 122.6, 125.8, 127.8, 128.4, 130.2, 135.2, 158.2, 158.9, 160.4, 175.3 and 177.2. *m/z*: 374 (M⁺).

3.4.4. 6-(6-Methoxycarbonyl-cyclohex-2-enyl)-5-oxo-5H-thiazolo[3,2-*a*]pyrimidine-2-carboxylic acid ethyl ester (ortho)/6-(5-methoxycarbonyl-cyclohex-2-enyl)-5-oxo-5H-thiazolo[3,2-*a*]pyrimidine-2-carboxylic acid ethyl ester (meta) (5a). Colourless crystalline solid, yield: 68%; mp 103–104 °C. Anal. Calcd for C₁₇H₁₈N₂O₅S: C, 56.34; H, 5.01; N, 7.73. Found: C, 56.61; H, 4.95; N, 7.69%. IR (KBr) ν_{\max} : 1724, 1683, 1508 cm⁻¹. δ_{H} (300 MHz, CDCl₃): 1.40 [t, 6H, *J* = 7.2 Hz, 2 × –O–C–CH₃ (*o* and *m*)], 1.72–1.80 [m, 2H, H_{7a}, H_{7b} (*o*)], 1.91–1.93 [m, 2H, H_{7a}, H_{7b} (*m*)], 2.14–2.20 [m, 2H, H_{6a}, H_{6b} (*o*)], 2.22–2.24 [m, 2H, H_{6a}, H_{6b} (*m*)], 2.89–2.91 [m, 1H, H₈ (*m*)], 3.01 [unresolved dd, *J* = 5.4, 7.5 Hz, 1H, H₈ (*o*)], 3.58 [s, 3H, –OCH₃ (*o*)], 3.64 [s, 3H, –OCH₃ (*m*)], 3.95 [ddd, *J* = 3.1, 5.4, 10.5 Hz, 1H, H₃ (*m*)], 4.13 [dd, *J* = 3.2, 9.2 Hz, 1H, H₃ (*o*)], 4.41 [q, *J* = 7.2 Hz, 4H, 2 × –CH₂ (*o* and *m*)], 5.61–5.63 [m, 1H, H₄ (*m*)], 5.64–5.66 [m, 1H, H₄ (*o*)], 5.98–6.00 [m, 1H, H₅ (*m*)], 6.01–6.03 [m, 1H, H₅ (*o*)], 7.88 [s, 1H, H₁ (*o*)], 7.91 [s, 1H, H₁ (*m*)], 8.51 [s, 1H, H₂ (*o*)], 8.53 [s, 1H, H₂ (*m*)]. δ_{C} (75 MHz, CDCl₃): 14.2 [–O–C–CH₃ (*o* and *m*)], 21.5 [–C (H-7) (*m*)], 22.5 [–C (H-7) (*o*)], 22.6 [–C (H-6) (*o*)], 24.2 [–C (H-6) (*m*)], 29.1 [–C (H-8) (*o*)], 30.1 [–C (H-8) (*m*)], 34.3 [–C (H-3) (*m*)], 37.2 [–C (H-3)], 52.8 [–OCH₃ (*o*)], 53.4 [–OCH₃ (*m*)], 62.7 [–OCH₂ (*o* and *m*)], 117.4 (*o*), 118.0 (*m*), 120.9 (*o*), 121.0 (*m*), 123.3 (*o*), 123.5 (*m*), 127.3 (*o*), 127.4 (*m*), 129.5 (*o*), 130.2 (*m*), 152.1 (*o*), 152.3 (*m*), 153.6 (*o*), 153.7 (*m*), 159.5 (*o*), 160.1 (*m*), 162.2 (*o*), 162.3 (*m*), 163.6 (*o*) and 163.7 (*m*). *m/z*: 362 (M⁺).

3.4.5. 6-(6-Cyano-cyclohex-2-enyl)-5-oxo-5H-thiazolo[3,2-*a*]pyrimidine-2-carboxylic acid ethyl ester (ortho)/6-(5-cyano-cyclohex-2-enyl)-5-oxo-5H-thiazolo[3,2-*a*]pyrimidine-2-carboxylic acid ethyl ester (meta) (5b). Light yellow crystalline solid, yield: 75%; mp 107–108 °C. Anal. Calcd for C₁₆H₁₅N₃O₃S: C, 58.34; H, 4.59; N, 12.76. Found: C, 58.51; H, 4.41; N, 12.69%. IR (KBr) ν_{\max} : 1718, 1676, 1508 cm⁻¹. δ_{H} (300 MHz, CDCl₃): 1.41 [t, 6H, *J* = 7.2 Hz, 2 × –O–C–CH₃ (*o* and *m*)], 1.71–1.82 [m, 2H, H_{7a}, H_{7b} (*o*)], 1.88–1.92 [m, 2H, H_{7a}, H_{7b} (*m*)], 2.15–2.19 [m, 2H, H_{6a}, H_{6b} (*o*)], 2.21–2.24 [m, 2H, H_{6a}, H_{6b} (*m*)], 2.89–2.91 [m, 1H, H₈ (*m*)], 3.03 [unresolved dd, *J* = 5.4, 7.4 Hz, 1H, H₈ (*o*)], 3.89 [ddd, *J* = 3.2, 5.4, 10.5 Hz, 1H, H₃ (*m*)], 4.11 [dd, *J* = 3.2, 9.6 Hz, 1H, H₃ (*o*)], 4.43 [q, *J* = 7.2 Hz, 4H, 2 × –CH₂ (*o* and *m*)], 5.59–5.62 [m, 1H, H₄ (*m*)], 5.63–5.68 [m, 1H, H₄ (*o*)], 5.88–5.99 [m, 1H, H₅ (*m*)], 6.03–6.08 [m, 1H, H₅ (*o*)], 7.84 [s, 1H, H₁ (*o*)], 7.89 [s, 1H, H₁ (*m*)], 8.52 [s, 1H, H₂ (*o*)], 8.53 [s, 1H, H₂ (*m*)]. δ_{C} (75 MHz, CDCl₃): 14.1 [–O–C–CH₃ (*o* and *m*)], 21.6 [–C (H-7) (*m*)], 22.5 [–C (H-7) (*o*)], 22.7 [–C (H-6) (*o*)], 24.2 [–C (H-6) (*m*)], 28.8 [–C (H-8) (*o*)], 30.2 [–C (H-8) (*m*)], 34.4 [–C (H-3) (*m*)], 37.2 [–C (H-3)], 62.9 [–OCH₂ (*o* and *m*)], 118.7 (*o*), 118.8 (*m*), 121.0 (*o*), 121.2 (*m*), 124.4 (*o*), 124.7 (*m*), 126.7 (*o*), 126.8 (*m*), 129.5 (*o*), 130.1 (*m*), 152.0 (*o*), 152.1 (*m*), 152.9 (*o*), 153.0 (*m*), 157.5 (*o*), 157.6 (*m*), 159.6 (*o*), 159.7 (*m*), 162.1 (*o*) and 162.3 (*m*). *m/z*: 329 (M⁺).

Acknowledgements

We are grateful to CSIR, New Delhi for Junior Research Fellowship to Parvesh Singh for the financial support under grant no. 01(1872/03/EMR-II).

References and notes

1. For recent reviews on azadienes see: (a) Boger, D. L. *Tetrahedron* **1983**, *39*, 2869. (b) Boger, D. L. *Chem. Tract- Org. Chem.* **1996**, *9*, 149. (c) Barluenga, J.; Tomas, M. *Adv. Heterocycl. Chem.* **1993**, *57*, 1. (d) Boger, D. L. In *Comprehensive Organic Synthesis*, Trost, B. M., Fleming, I., Eds.; Pergamon: Oxford, 1991; Vol. 5. (e) Ghosez, L. *Stereocontrolled Organic Synthesis*; Blackwell: London, 1994; p 193. (f) Boger, D. L.; Weinreb, S. M. *Hetero Diels–Alder Methodology in Organic Synthesis*; Academic: San Diego, 1987. (g) Jayakumar, S.; Ishar, M. P.; Mahajan, M. P. *Tetrahedron* **2002**, *58*, 379–471.
2. (a) Wurthwein, E. U.; Luthadart, P. *Tetrahedron Lett.* **1988**, *29*, 921. (b) Luthadart, P.; Moller, M. H.; Rodewald, U.; Wurthwein, E. U. *Chem. Ber.* **1989**, *122*, 1705. (c) Mastuda, I.; Yamamoto, S.; Ishii, Y. *J. Chem. Soc., Perkin Trans. 1* **1976**, 1528. (d) Rossi, E.; Abbiati, G.; Pini, E. *Tetrahedron* **1997**, *53*, 14107.
3. Mazumdar, S. N.; Mahajan, M. P. *Synthesis* **1990**, 417.
4. (a) Mazumdar, S. N.; Mahajan, M. P. *Tetrahedron* **1991**, *47*, 1473. (b) Mazumdar, S. N.; Ibnusaud, I.; Mahajan, M. P. *Tetrahedron Lett.* **1986**, *27*, 5875. (c) Mazumdar, S. N.; Mukherjee, S.; Sharma, A. K.; Sengupta, D.; Mahajan, M. P. *Tetrahedron* **1994**, *50*, 7579. (d) Sharma, A. K.; Mahajan, M. P. *Heterocycles* **1995**, *40*, 787. (e) Jayakumar, S.; Singh, P.; Mahajan, M. P. *Tetrahedron* **2004**, *60*, 4315.
5. (a) Landreau, C.; Deniaud, D.; Reliquet, A.; Meslin, J. C. *Eur. J. Org. Chem.* **2003**, 421–424. (b) Landreau, C.; Deniaud, D.; Meslin, J. C. *J. Org. Chem.* **2003**, *68*, 4912.
6. (a) Berge, J. M.; Rey, M.; Dreiding, A. S. *Helv. Chim. Acta* **1982**, *65*, 2230–2241. (b) Barbaro, G.; Battaglia, A.; Giorgianni, P. *J. Org. Chem.* **1987**, *52*, 3289–3296.
7. (a) Botta, M.; Occhionero, F.; Nicoletti, R.; Mastromarino, P.; Conti, C.; Margini, M.; Saladino, R. *Bioorg. Med. Chem.* **1999**, *7*, 1925. (b) Botta, M.; Parlato, M. C.; Mugnaini, C.; Renzulli, M. L.; Corelli, F. *ARKIVOC* **2004**, *5*, 349.
8. Sharma, A. K.; Jayakumar, S.; Hundal, M. S.; Mahajan, M. P. *J. Chem. Soc., Perkin Trans. 1* **2002**, 774–784.
9. Brinkmeyer, R. S.; Abdullah, R. F. *The chemistry of formamide acetals, Tetrahedron report* **1979** Vol. 35, pp 1675–1735.
10. Sharma, A. K.; Mazumdar, S. N.; Mahajan, M. P. *J. Org. Chem.* **1996**, *61*, 5506.
11. Boyd, H. F.; Fell, S. C. M.; Hickley, D. M. B.; Ife, R. J.; Leach, C. A.; Macphee, C. H.; Milliner, K. J.; Pinto, I. L.; Rawlings, A.; Smith, S. A.; Stansfield, I. G.; Stanway, S. J.; Theobald, C. J.; Whittaker, C. M. *Bioorg. Med. Chem. Lett.* **2002**, *12*, 51.

Amine side arm effect on the ion selectivity of 12-crown-O₃N derivatives with an amine arm in aqueous and acetonitrile solutions

Katsuhiko Okano,^a Hiroshi Tsukube^b and Kenzi Hori^{c,*}

^aTokyo R&D Center, Daiichi Pharmaceutical Co. Ltd, Kitakasai, Edogawa, Tokyo 134-8630, Japan

^bDepartment of Chemistry, Graduate School of Science, Osaka City University, Osaka 558-8585, Japan

^cDepartment of Applied Chemistry and Chemical Engineering, Faculty of Engineering, Yamaguchi University, Tokiwadai, Ube 755-8611, Japan

Received 7 July 2005; revised 2 August 2005; accepted 24 August 2005

Available online 2 November 2005

Abstract—Molecular geometries of crown ether derivatives play an important role in capturing and transporting alkali metal ions such as Li⁺ and Na⁺. As selectivity of the ions is observed in solution, it is necessary to know their molecular structures in solutions. Recently, we investigated stable conformations of 12-crown-O₃N and its alkali ion complexes in aqueous and acetonitrile solutions. In the present study, we applied a procedure similar to that in previous papers to investigate the side arm effect of 12-crown-O₃N with an amine arm for capturing Li⁺ and Na⁺ in the two solutions. It was confirmed that the stable structures of Li⁺ and Na⁺ complexes in solutions, especially the geometry of the amine side arm, are highly solvent-dependent. This conformational difference is the key to understanding the high Li⁺ selectivity of 12-crown-O₃N derivatives with an amine side arm in acetonitrile.

© 2005 Elsevier Ltd. All rights reserved.

1. Introduction

Crown ethers have an interesting function in that they capture and transport alkali metal ions selectively. For example, it is known that 15-crown-5 selectively forms a complex with Na⁺ and 18-crown-6 with K⁺.¹ Since Pedersen first synthesized the cyclic ethers, the size relation between ions and cavities of crown ethers has been considered to be the most important reason for this selectivity.² In polar solvents, however, such as water, alcohol, and so on, 12-crown-4 shows little selectivity for small ions although the crown ether has an optimal hole for Li⁺. It was experimentally found that the stability of complexes depends highly on the solvents used.¹ These results show that not only the ion–hole relationship but also the solvent effect are important for the ion selectivity. Later, it was pointed out that the solvent effect rather than spatial factors largely participates in ion selectivity.³

It was known that the addition of a side arm with donor atom, especially nitrogen atom, to the crown ring remarkably enhances the selectivity for Li⁺. Especially, an amine side

arm is very effective for improving this property of 12-crown-O₃N derivatives. For example, 12-crown-O₃N with an amine side arm, **1**, showed high transport capability for Li⁺.⁴

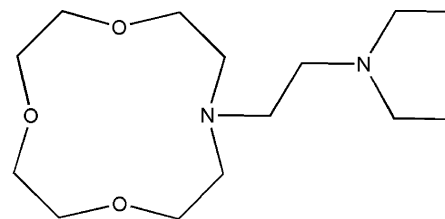

1: N-(N,N-diethyl-aminoethylen)-12-Crown-O₃N

To investigate the effect of the amine side arm on ion selectivity, changes in ¹³C NMR chemical shifts were observed in methanol and acetonitrile by adding alkaline metal ions such as Li⁺ and Na⁺ to methanol or acetonitrile solutions of **1**.⁵ We obtained the following results.

(1) The changes in the ¹³C NMR chemical shifts of the crown carbon are approximately proportional to the Na⁺ concentration up to the 2:1 = Na⁺:**1** in methanol. In contrast, little changes in the shift of the arm carbon were observed. Similar but small changes in the shifts were observed for the Li⁺ titration. This experimental result

Keywords: Stable conformations in solution; Monte Carlo simulation; Ab initio molecular orbital calculations; 12-Crown-O₃N.

* Corresponding author. Tel.: +81 83685928; fax: +81 836859201; e-mail: kenji@sparklx.chem.yamaguchi-u.ac.jp

indicated that neither Li^+ nor Na^+ accepts the nitrogen atom of the amine arm as a ligand in methanol.

(2) Addition of Li^+ to an acetonitrile solution of **1** causes changes in the ^{13}C NMR chemical shifts of both the arm and the ring carbon up to a 1:1 ratio of ions and the crown. While a similar change of the chemical shift for the ring carbon was observed for the Na^+ titration, that of the arm carbon was much smaller than that for Li^+ . The excess ions do not produce further shifts on either of the carbons.

According to the experimental results, we concluded that **1** encapsulates Li^+ using the nitrogen arm in acetonitrile, a solvent less polar than methanol. However, it is still uncertain why the combination of solvent and the ion causes such a large difference in selectivity of the crown derivative. In the present study, we investigated the side arm effect to elucidate the relationship between selectivity and the stability of complexes of **1** and an alkali ion, not only in water but also in acetonitrile, by applying a procedure similar to that used in previous reports.⁶

2. Method of calculations

2.1. Quantum mechanical calculations

Li^+ and Na^+ complexes of **1** including one solvent molecule, the solvated complex, were optimized using the Gaussian98 program⁷ at the RHF/6-31G* level⁸ of theory. The potential curves for solvated complexes depending on the dihedral angle of the side arm were obtained by calculating energies at the B3LYP/6-31G**//RHF/6-31G* level of theory. The results are listed in Table 1.

Table 1. Relative energies of complexes in solutions depending on changes in the dihedral angle of the amine arm

$\Delta\theta$	WLi	ALi	WNa	ANa
0	0.00 (0.00)	0.00 (0.00)	0.00 (0.00)	0.00 (0.00)
10	0.31 (0.80)	0.40 (0.38)	0.24 (0.48)	0.10 (0.19)
20	1.53 (1.96)	1.03 (0.98)	-0.83 (1.44)	1.04 (0.70)
30	3.61 (3.66)	2.27 (2.28)	0.08 (2.99)	0.69 (0.28)
40	5.20 (5.74)	1.94 (2.28)	1.54 (5.13)	1.31 (0.52)
50	-0.94 (5.05)	1.97 (2.66)	2.17 (5.51)	2.10 (1.38)
60	-0.59 (4.30)	3.66 (3.79)	-6.18 (5.21)	3.42 (2.76)
70	0.43 (4.03)	4.94 (4.50)	-5.18 (5.38)	3.93 (3.46)
80	-3.26 (3.97)	4.58 (4.05)	-5.06 (6.13)	3.99 (3.49)
90	-4.25 (4.76)	2.50 (2.45)	-2.99 (7.23)	4.05 (3.76)
100	-2.26 (5.62)	0.06 (0.45)	-2.42 (8.31)	4.35 (4.60)

Values in parentheses are relative energies of complexes in the vacuum.

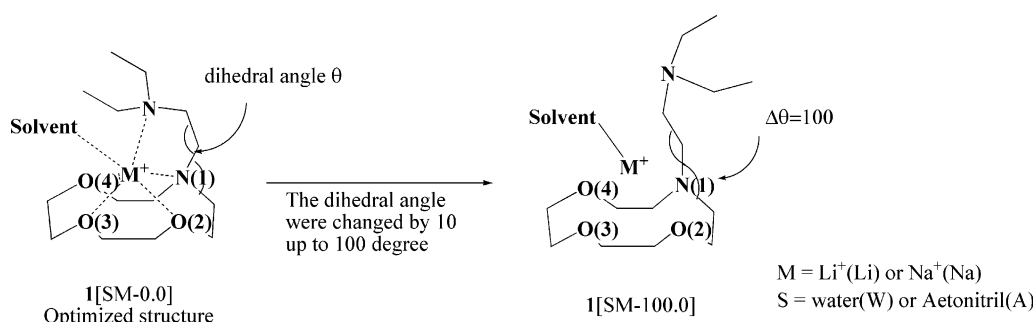
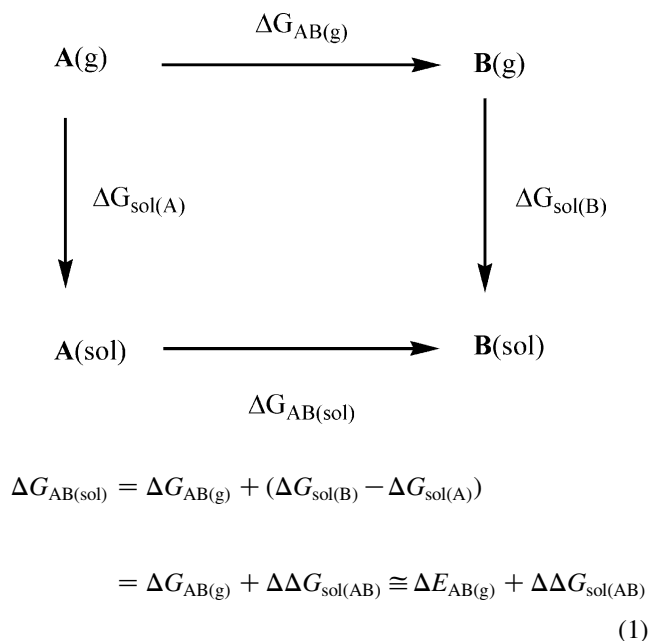

Figure 1. Fixed dihedral angle in optimizing complexes with the amine arm.

The optimized structures with fixed dihedral angles are represented as **1**[SM- $\Delta\theta$], where S means the kind of solvent (W, water or A, acetonitrile) and M represents the metal ion (Li, Li^+ , Na, Na^+). θ is the angle made by the amine arm and the crown ring as shown in Figure 1. $\Delta\theta$ shows the difference of the dihedral angle from that in the optimized structure. For example, **1**[ANa-0.0] in the figure represents the optimized structure for the complex of **1** and Na^+ including one acetonitrile molecule in the vacuum. Complexes in the solutions are represented as **1**[SM, $\Delta\theta$]_{sol} as will be discussed later.

2.2. Monte Carlo simulations

The statistical perturbation theory (SPT)⁹ was applied to calculate the difference in free energy of solvation $\Delta\Delta G_{\text{sol}(\text{AB})}$ between two structures, A and B, that have different dihedral angles. The thermodynamic cycle for calculating the energy is shown below. MC simulations in aqueous and MeCN solutions were used for calculating $\Delta\Delta G_{\text{sol}(\text{AB})}$ by using the BOSS Version 3.5 program.¹⁰ Eq. 1 was used for calculating $\Delta G_{\text{AB}(\text{sol})}$ (sol, acetonitrile or water), a free energy difference in solution. $\Delta G_{\text{AB}(\text{g})}$, a free energy difference in the gas phase, is approximated to $\Delta E_{\text{AB}(\text{g})}$, an energy difference in the gas phase obtained from ab initio MO or density functional theory (DFT) calculations. Potential curves in solutions were obtained by plotting $\Delta G_{\text{AB}(\text{sol})}$.



MC simulations were performed for an orthorhombic box, which contains a solute as well as 500 TIP4P waters or 267 acetonitrile as solvents. Metropolis sampling and periodic boundary conditions were employed. The range of movement was chosen to yield an acceptance rate of 30–40% for new configurations. The run for each window involved the equilibration for 10^6 configurations, followed by averaging over an additional 10^6 configurations. The electrical charges for MC simulations were calculated by applying the Merz–Singh–Kollman scheme¹¹ at the same level of theory.

3. Results and discussion

3.1. Structures of Li^+ and Na^+ complexes with one solvent molecule in the vacuum

First of all, the geometry of the complex of **1** with Li^+ including one water molecule, **1**[WLi-0.0], was optimized at the RHF/6-31G* level of theory. In this case, an initial structure was made from the optimized structure of the Li^+ complex of 12-crown- O_3N by adding the amine arm, and then, another optimization with one water molecule was performed. Similar optimizations were made for the Na^+ complex **1**[WNa-0.0]. Initial structures for complexes with one acetonitrile molecule, **1**[ALi-0.0] and **1**[ANa-0.0], were obtained by replacing a water molecule with an acetonitrile molecule. All the optimized geometries are shown in Figure 2.

According to the Na–X (X = O or N) lengths, four donor atoms in the crown ring, one water molecule and the nitrogen atom in the arm coordinate to Na^+ in **1**[WNa-0.0] so that the complex possesses six-fold coordination geometry. On the other hand, **1**[WLi-0.0] is considered to take a five-coordination geometry since O(3), locating the opposite side of the arm with the nitrogen atom, occupies a rather distant position, that is, Li–O(3):3.058 Å. Similar five-coordination geometries were

optimized for both the Li^+ and Na^+ complexes of **1** including one acetonitrile, **1**[ALi-0.0] and **1**[ANa-0.0]. The O(3) atoms in these optimized structures locate in a position lower than the mean plane of the crown ring.

3.2. Potential energy profiles of the Li^+ complexes along the rotation of the dihedral angle both in a vacuum and in the two solutions

The RHF/6-31G* calculation was performed for optimizing **1**[WLi-10.0] with the fixed dihedral angle, that is, an optimization whose dihedral angle is rotated by 10.0° from the most stable geometry and then fixed. Similar geometry optimizations were performed until $\Delta\theta = 100.0^\circ$. Optimized structures with $\Delta\theta = 50$ and 100° are shown in Figure 3. As the amine arm of **1**[WLi-100.0] no longer coordinates to Li^+ , the central metal ion takes a five-coordination geometry with four ring donors and a water molecule as ligands. Figure 4 plots energies of the solvated Li^+ complexes with different dihedral angles $\Delta\theta$ at the B3LYP/6-31G**//RHF/6-31G* level of theory. The potential curve of **1**[WLi- $\Delta\theta$] (open circles) has a peak around $\Delta\theta = 40.0$, which was less stable by 6 kcal mol^{-1} than that with $\Delta\theta = 0.0$; then it changes within $4\text{--}6 \text{ kcal mol}^{-1}$. Therefore, the structure of **1**[WLi-0.0] was calculated to be the most stable in a vacuum. As **1**[WLi-100.0] was calculated to be less stable, at only $5.5 \text{ kcal mol}^{-1}$ than **1**[WLi-0.0], the ion tends to accept the side arm nitrogen and take a five-coordination geometry in the vacuum.

Although there is also a peak of the potential curve at $\Delta\theta = 40$ in aqueous solution (closed circles), the shape of the curve is very different from that in the vacuum. It has local minima around both $\Delta\theta = 50$ and 90° . **1**[WLi-50.0]_{sol} and **1**[WLi-90.0]_{sol} are more stable by about 1.0 and $4.0 \text{ kcal mol}^{-1}$ than **1**[WLi-0.0]_{sol}. Figure 5 displays snapshots of Monte Carlo simulation on **1**[WLi-10.0]_{sol} and **1**[WLi-90.0]_{sol}. As the O(3)– Li^+ length was calculated to

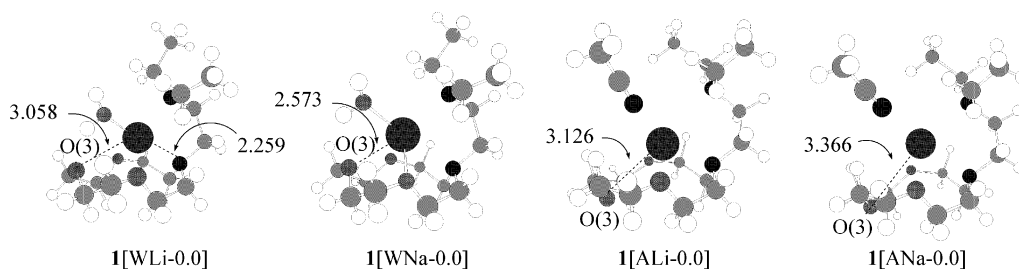

Figure 2. Optimized structures of the solvated complexes with Li^+ or Na^+ ions.

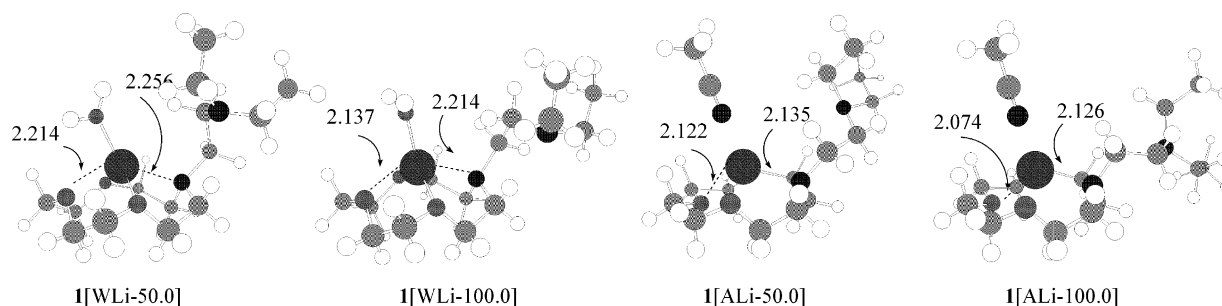

Figure 3. Optimized structures with fixed dihedral angles for the solvated 12-crown- O_3N complexes with Li^+ and Na^+ ions.

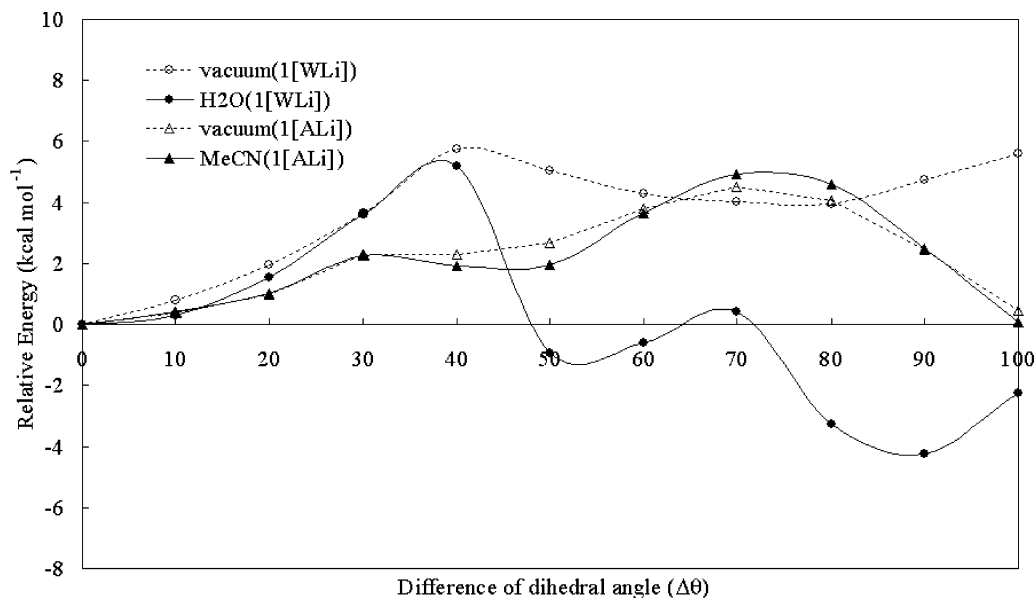

Figure 4. Potential energy profiles of Li^+ complexes both in the vacuum and in aqueous and acetonitrile solutions.

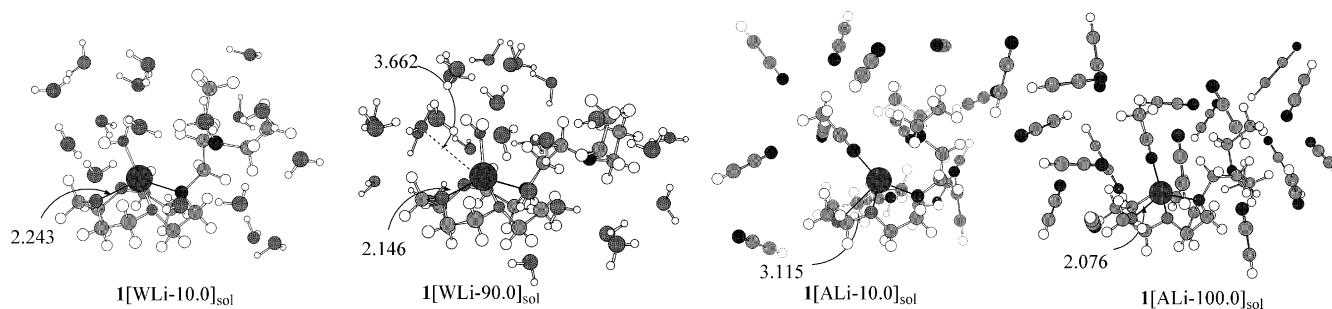

Figure 5. Water and acetonitrile molecules around the 12-crown- O_3N moiety and Li^+ in snapshots of the MC calculations.

be 2.137 Å of $\mathbf{1}[\text{WLi-100.0}]_{\text{sol}}$, the oxygen in the ring coordinates to the ion instead of that in the amine arm. Therefore, the coordination number is the same for these structures. One solvent molecule from the Monte Carlo simulation comes close to Li^+ , although the Li-O distance is still ca. 3.662 Å. Many solvent waters surround the nitrogen atom of the side arm. These interactions are responsible for the stability of the complex with the open arm in aqueous solution. The potential curve in aqueous solution indicates that the nitrogen atom of the amine arm hardly coordinates to Li^+ in aqueous solution. This result is consistent with the experimental findings, as indicated above.

The shape of the curve of $\mathbf{1}[\text{ALi}]$ in acetonitrile is very similar to that in the vacuum. Both curves (open and closed triangles) have maxima near $\Delta\theta = 70^\circ$, which were less stable by ca. 5 kcal mol $^{-1}$ than $\mathbf{1}[\text{ALi-0.0}]$. It is important to point out that $\mathbf{1}[\text{ALi-100.0}]$ is almost as stable as $\mathbf{1}[\text{ALi-0.0}]$. Figure 5 displays snapshots of the Monte Carlo simulation on $\mathbf{1}[\text{ALi-10.0}]_{\text{sol}}$ and $\mathbf{1}[\text{ALi-100.0}]_{\text{sol}}$. Their lengths of $\text{O}(3)-\text{Na}^+$ were calculated to be 3.115 and 2.076 Å. All the donor atoms in the ring coordinate to the ion in the latter structure. Solvent acetonitriles surround the nitrogen atom of the side arm, although the numbers of solvents are smaller than those

in $\mathbf{1}[\text{WLi-90.0}]$. These interactions are responsible for the stability of the complex with the open arm. The low barrier height indicates that frequent interconversion between the two conformations, $\mathbf{1}[\text{ALi-0.0}]$ and $\mathbf{1}[\text{ALi-100.0}]$, is possible and almost half of the complexes encapsulate the small ion in acetonitrile.

3.3. Potential energy profiles of the Na^+ complexes along the rotation of the dihedral angle both in the vacuum and in the solutions

Potential energy scans on the dihedral angle were also performed for the solvated Na^+ complex in the vacuum. Figure 6 shows optimized structures of the solvated complexes with $\Delta\theta = 50.0$ and 100.0° . In $\mathbf{1}[\text{ANa-100.0}]$, the $\text{Na}^+-\text{O}(3)$ distance was calculated to be 2.481 Å. Therefore, Na^+ accepts $\text{O}(3)$ as the fifth ligand, whereas the amine nitrogen of the arm no longer interacts with the ion while the $\text{O}(3)$ does not act as a ligand in $\mathbf{1}[\text{ANa-0.0}]$ in Figure 2. On the other hand, this change in the coordination geometry does not occur on either $\mathbf{1}[\text{WNa-50.0}]$ or $\mathbf{1}[\text{WNa-100.0}]$, since all the donor atoms of the crown ring coordinate to Na^+ in $\mathbf{1}[\text{WNa-0.0}]$. These geometrical features, depending on the combination of the solvent and the ion, are closely related to shapes of the potential energies of the Na^+ complexes as shown in Figure 7.

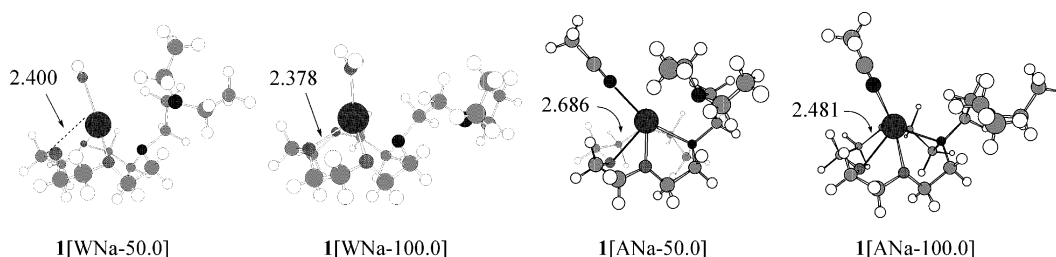

Figure 6. Optimized conformations of solvated Na^+ complexes of 12-crown- O_3N with fixed dihedral angles between the amine arm and the crown ring.

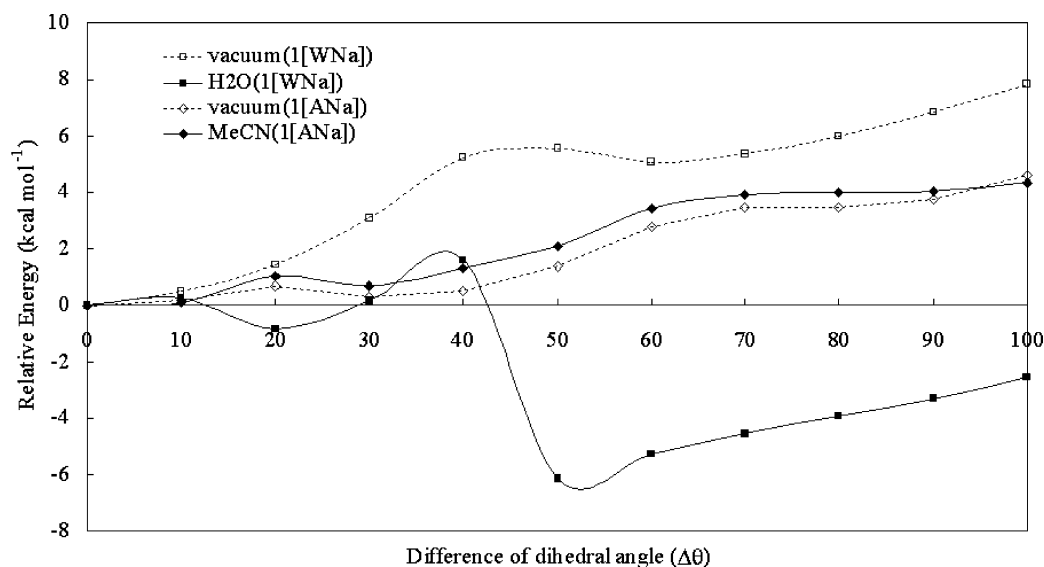

Figure 7. Potential energy profiles of Na^+ complexes in aqueous and acetonitrile solutions.

Figure 7 displays the potential energies for **1**[WNa] and **1**[ANa]. In the vacuum, **1**[WNa] (open circles) has a local maximum of ca. 6 kcal mol^{-1} around $\Delta\theta=40^\circ$, and the energies change very little between $\Delta\theta=40$ and 100° . The shape in aqueous solution (closed circle) is very different from that in the vacuum. There is a peak of ca. 2 kcal mol^{-1} near $\Delta\theta=40^\circ$, and a minimum near $\Delta\theta=50^\circ$. **1**[WNa-50.0]_{sol} is calculated to be more stable by ca. 7 kcal mol^{-1} than **1**[WNa-0.0]_{sol}. We conclude that in aqueous solution, donor atoms of the crown ring can coordinate to Na^+ , and no interactions exist between the ion and the side arm nitrogen.

The titration experiment of Na^+ to the methanol solution of **1** causes rather large changes in the ^{13}C NMR chemical shifts of the crown ring. On the contrary, almost no changes were observed in those of the side arm. These experimental results indicate that the side arm nitrogen cannot interact with the Na^+ ion in the polar solvent, although the donor atoms in the ring coordinate to the ion. The shape of the potential curve is consistent with the experimental findings.

While the shape of a potential curve for **1**[WNa] in the vacuum is different from that in aqueous solution, those of **1**[ANa] are very similar and almost overlap each other (open and closed triangles). A low energy maximum of ca. 1 kcal mol^{-1} is seen at $\Delta\theta=20^\circ$. The increase of $\Delta\theta$ destabilizes the complex, although the energy difference between **1**[ANa-0.0]_{sol} and **1**[ANa-100.0]_{sol} is as small as

ca. 4 kcal mol^{-1} . This result shows that the nitrogen atom of the side arm works weakly to encapsulate Na^+ . It is possible to consider a rapid rotation of the side arm along the N–C bond because of a low barrier for the rotation. The weak interaction is not good for encapsulating and transporting Na^+ , while the rotation prevents another crown from coordinating to the ion to make a sandwich type complex as reported by Gokel¹² for the 12-crown- O_3N , the crown ligand without side arms.

In the titration experiment of Na^+ to the acetonitrile solution of **1**, changes in the ^{13}C NMR chemical shifts of the crown ring were observed to be almost proportional to the Na^+ concentration up to the ratio of $[\text{Na}^+]/[\mathbf{1}]$ 0:1. This indicates that the sandwich type complex hardly forms in the acetonitrile solution of **1**, so that the calculated results are also consistent with this experiment.

Figure 8 displays snapshots of the Monte Carlo simulation on **1**[WNa-50.0]_{sol} and **1**[ANa-100.0]_{sol}. In **1**[WNa-50.0]_{sol} another water molecule, which was generated by Monte Carlo simulation was located near to Na^+ and its distance was 3.392 \AA . This weak interaction of solvent molecule and Na^+ was supposed to be stabilized **1**[WNa-50.0]_{sol} in water. On the other hand, there was no remarkable change without the distance of Na^+ and O(2) for **1**[ANa] in acetonitrile solution. It seems to be that the difference of the weak interaction was reflected in the tendency of the potential curves on **Figure 7**.

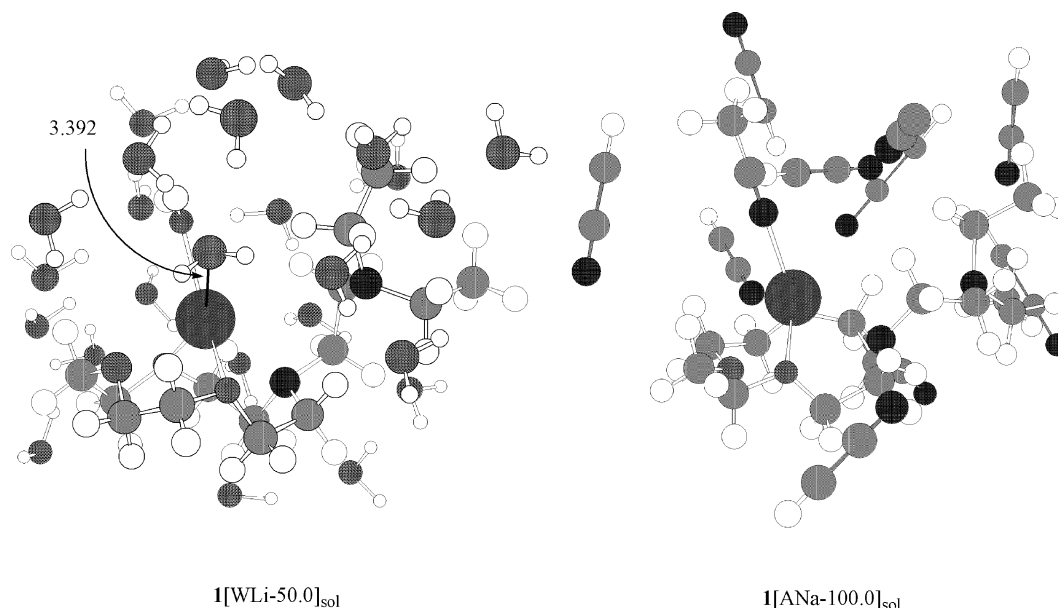

Figure 8. Water and acetonitrile molecules around the 12-crown- O_3N moiety and Na^+ in snapshots of the MC calculations for **1**[WNa-50.0] and **1**[ANa-100.0].

4. Concluding remarks

In the present study, the side arm effect was investigated in both aqueous and acetonitrile solutions for the Li^+ selectivity of **1**. It was confirmed that **1**[WLi-90], in which the amine arm does not act as a ligand for Li^+ , is most stable in aqueous solution. That is, in a strong polar environment, the amine arm is useless to encapsulate alkali ions. However, in a less polar solvent, such as MeCN, the amine arm was considered to be equilibrated between the open and the encapsulated form.

1[WNa-50.0]_{sol}, in which the amine arm does not act as a ligand for Na^+ , is most stable in aqueous solution. In contrast, **1**[ANa-0.0]_{sol}, in which the amine arm coordinated to the Na^+ ion is most stable. These results are very consistent with experiments for the ^{13}C NMR chemical shifts.

References and notes

- Izatt, R. M.; Pawlak, K.; Bradshaw, J. S.; Bruening, R. L. *Chem. Rev.* **1991**, *91*, 1721.
- Pedersen, C. *J. Am. Chem. Soc.* **1967**, *89*, 7017.
- Hori, K.; Inoue, T.; Tsukube, H. *Tetrahedron* **1996**, *52*, 8199.
- Hori, K.; Tsukube, H. *J. Inclusion Phenom. Mol. Recognit. Chem.* **1998**, *32*, 311.
- (a) Tsukube, H.; Hori, K.; Inoue, T. *Tetrahedron Lett.* **1993**, *34*, 6749. (b) Tsukube, H.; Inoue, T.; Hori, K. *J. Org. Chem.* **1994**, *59*, 8047.
- (a) Hori, K.; Dou, N.; Okano, K.; Ohgami, A.; Tsukube, H. *J. Comput. Chem.* **2001**, *23*, 1226. (b) Okano, K.; Tsukube, H.; Hori, K. *Tetrahedron* **2004**, *60*, 10877.
- Gaussian 03*, revision A11, Frisch, M. J.; Trucks, G. W.; Schlegel, H. B.; Scuseria, G. E.; Robb, M. A.; Cheeseman, J. R.; Montgomery, J. A., Jr.; Vreven, T.; Kudin, K. N.; Burant, J. C.; Millam, J. M.; Iyengar, S. S.; Tomasi, J.; Barone, V.; Mennucci, B.; Cossi, M.; Scalmani, G.; Rega, N.; Petersson, G. A.; Nakatsuji, H.; Hada, M.; Ehara, M.; Toyota, K.; Fukuda, R.; Hasegawa, J.; Ishida, M.; Nakajima, T.; Honda, Y.; Kitao, O.; Nakai, H.; Klene, M.; Li, X.; Knox, J. E.; Hratchian, H. P.; Cross, J. B.; Bakken, V.; Adamo, C.; Jaramillo, J.; Gomperts, R.; Stratmann, R. E.; Yazyev, O.; Austin, A. J.; Cammi, R.; Pomelli, C.; Ochterski, J. W.; Ayala, P. Y.; Morokuma, K.; Voth, G. A.; Salvador, P.; Dannenberg, J. J.; Zakrzewski, V. G.; Dapprich, S.; Daniels, A. D.; Strain, M. C.; Farkas, O.; Malick, D. K.; Rabuck, A. D.; Raghavachari, K.; Foresman, J. B.; Ortiz, J. V.; Cui, Q.; Baboul, A. G.; Clifford, S.; Cioslowski, J.; Stefanov, B. B.; Liu, G.; Liashenko, A.; Piskorz, P.; Komaromi, I.; Martin, R. L.; Fox, D. J.; Keith, T.; Al-Laham, M. A.; Peng, C. Y.; Nanayakkara, A.; Challacombe, M.; Gill, P. M. W.; Johnson, B.; Chen, W.; Wong, M. W.; Gonzalez, C.; Pople, J. A. Gaussian, Inc., Wallingford CT, 2004.
- Ditchfield, R.; Hehre, W. J.; Pople, J. A. *J. Chem. Phys.* **1971**, *54*, 724.
- (a) Zwanzig, R. W. *J. Chem. Phys.* **1954**, *22*, 1420. (b) Jorgensen, W. L.; Blake, J. F.; Lim, D. C.; Severance, D. L. *J. Chem. Soc., Faraday Trans.* **1994**, *90*, 1727.
- BOSS, version 3.5, Jorgensen, W. L. *Acc. Chem. Res.* **1989**, *22*, 184.
- (a) Besler, B. H.; Merz, K. M.; Kollman, P. A. *J. Comput. Chem.* **1990**, *11*, 431. (b) Singh, U. C.; Kollman, P. A. *J. Comput. Chem.* **1984**, *5*, 129.
- White, B. D.; Arnold, K. A.; Garrell, R. L.; Fronczek, F. R.; Gandour, R. D.; Gockel, G. W. *J. Org. Chem.* **1987**, *52*, 1128.