

HIGH HEATING RATE THERMAL ANALYSIS*

A. J. BEARDELL, J. STALEY AND C. CAMPBELL

Pyrotechnics Branch, Explosives Division, Picatinny Arsenal, Dover, N. J. 07801 (U.S.A.)

ABSTRACT

A high heating rate method to investigate the presence or absence of transient events during the run-up to ignition of reactive solids was developed. The instrument is capable of recording the temperature-time trace of a sample heated at rates that range from 0.1 to 20°C msec⁻¹. An infrared detector focused on microgram quantities of the sample is used to measure temperature and the sample is heated by use of a platinum ribbon which constitutes one arm of a Wheatstone bridge. The feasibility of the method is demonstrated using calcium oxalate as the test sample. The exotherms and endotherms attributable to this substance were observed at heating rates up to 1.17°C msec⁻¹. The major disadvantage of the method is the change in emissivity that may occur during the heating cycle, which will cause deviations in the temperature calibration. An analysis of the events leading to the ignition of nitrocellulose is also presented.

INTRODUCTION

The ignition of energetic materials, e.g., propellants or pyrotechnics, occurs within a few milliseconds by use of a squib or some ignition source in which the heating rate is in the order of 1 to 100°C msec⁻¹. The physical and chemical processes that occur during the run-up to ignition are usually not amenable to investigation because of the transient nature of the events. The use of isothermal methods below the ignition temperature of conventional DTA to investigate pre-ignition and ignition processes may not be applicable because sufficient time is allowed to elapse for phase transitions to occur, evolved gases to escape and slow reactions to take place. A technique that appears to offer great advantage in the measurement of the presence or absence of transient events is high heating rate thermal analysis in which the heating rate approaches that of an ignition process.

Previous studies involving high heating rate thermal analysis include the investigations of Wunderlich and Wolpert¹ and Baer and Ryan^{2,3}. The former used a conventional approach to achieve heating rates as high as 0.01°C msec⁻¹. Using

*Presented at the 5th North American Thermal Society Meeting, Peterborough, Ontario, Canada, June 8-14, 1975.

heat transfer theory they showed that at heating rates of about $10^{\circ}\text{C msec}^{-1}$ the sample size must be in the microgram range to assure a minimum temperature gradient across the sample. Bouck et al.³ prepared a thin unsupported film of the sample which was heated with a high intensity lamp. The sample temperature change as a function of time was measured with an infrared detector. Analysis of the temperature-time curve using a computerized temperature-time trace as reference produced the ΔT vs. T plot. Since the sample was not in contact with a heat sink, any heat absorbed or produced contributed to the temperature of the system at any instant after the event. A heat transfer analysis of the model used by Baer and Ryan showed that at a heating rate of $0.3^{\circ}\text{C msec}^{-1}$ the film must be about 10^{-2} cm thick to maintain a temperature gradient below 10°C .

The approach taken here consists in the use of an infrared detection method to measure temperature and a thin platinum ribbon heat source on which a 50 to 200 μg sample is deposited.

EXPERIMENTAL

Apparatus

The purpose of the apparatus is to measure the temperature as a function of time of a composition which is heated at a high constant rate, and to provide a linear

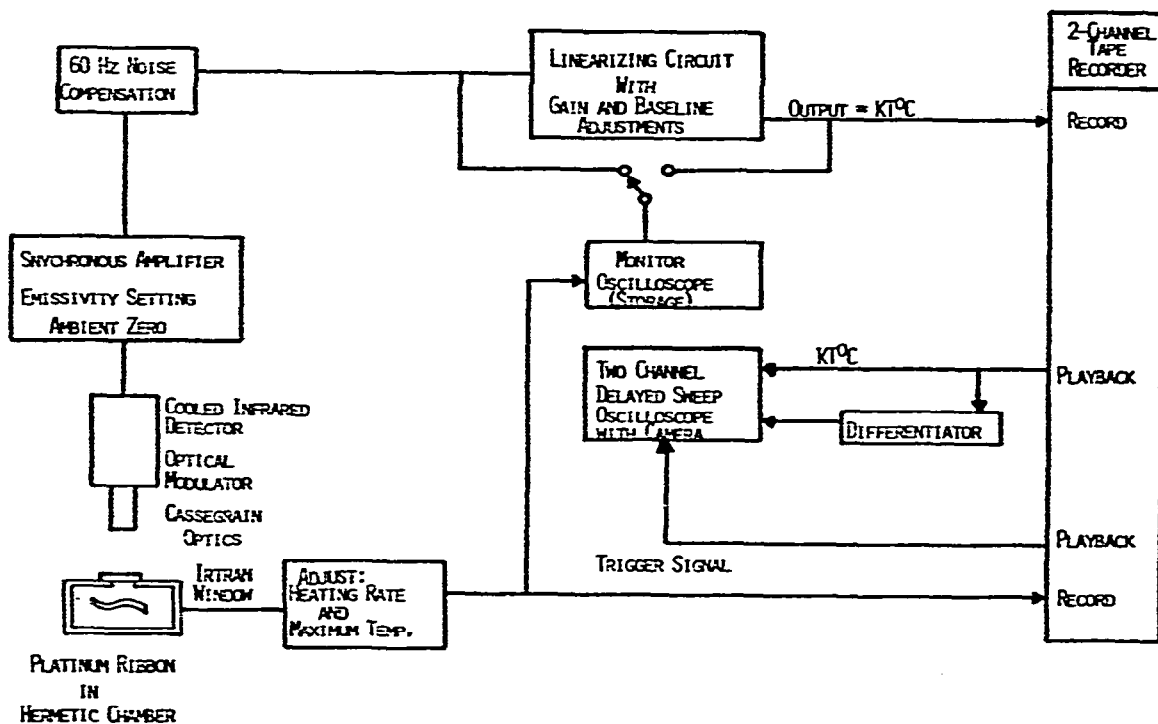

Fig. 1. Schematic of high heating rate apparatus.

readout of temperature versus time. The derivative of temperature with respect to time is also taken, and is analogous to the curve obtained in differential thermal analysis. A schematic of the apparatus is shown in Fig. 1.

The system is composed of a wide band infrared detector to convert temperature to an electrical analog, a controlled source of heat for the sample, electronics to process the detector output voltage and provisions for recording the final curve.

Temperature measurement

The temperature is measured using a Barnes RM-2A infrared radiometric microscope. It consists of a cooled (liquid nitrogen) indium antimonide detector with cassegrain optics and a 600 Hz tuning fork radiation modulator. Its associated electronics provides synchronous demodulation of the chopped 600 Hz carrier, an input gain adjustment to compensate for differing emissivities of the target, and an offset adjustment for ambient temperature fluctuations.

The temperature-dependent output of the circuit has a bandwidth from DC to 400 Hz. When the full bandwidth of the microscope amplifier is used, there is a substantial amount of 60 Hz ripple superimposed on the signal from targets below 200°C. A 60 Hz sine wave with adjustable amplitude and phase is summed with the signal and reduces the ripple to 30% of its original value.

An ideal detector, one with infinite spectral band-width and perfect linearity, would provide an output signal proportional to T^4 , where T is the target temperature in degrees Kelvin. Because the detector used has a finite band-width, this relationship does not hold. Calibration with a black body simulator as a target shows the actual response to be: $e_1 = K(T)^n$, where T is degrees centigrade and n varies from 2.65 to 2.92. The inverse of this function is approximated by a modified power series of the form $A + Be_1 + Ce_1^{1/2} + De_1^{1/4} = e_2$ where e_1 is the output voltage of the microscope amplifier and e_2 is the output of the linearizing circuit, which is composed of square root modules and summing amplifiers. The circuit follows the relationship:

$$e_2 = KT(^{\circ}\text{C}),$$

with a linearity of +3.8%–1.2% from 60 to 1000°C, and +0.08%–1.2% from 125 to 1000°C. An adjustable voltage subtracted from e_2 allows the final recorded display to be started at any appropriate temperature and a variable gain output amplifier permits scaling to conform to the desired Y-axis coordinates.

Precision black body heat sources ranging in temperature from 60 to 600°C were used for temperature calibration of the detector. After focusing the detector on the appropriate radiation source, the output of the detector amplifier versus temperature was measured. The results were used to compute the coefficients of the power series ($A + Be_1 + Ce_1^{1/2} + De_1^{1/4} = e_2$) used in the linearizing circuit. For temperatures above 600°C, the values provided by the manufacturer of the infrared detector were used. The good conformity of the manufacturer's curve to the measured values below 600°C warranted its use in this extrapolation.

When the amplitude and baseline of the linearizer output were adjusted to

conform to the ordinate of the desired graphic readout, the temperature calibration at selected points (every 100°C) was repeated every two or three days. The detector housing is provided with an adjustable stop (iris diaphragm) to maintain the output from high temperature sources within the linear range of the detector and the electronics. The setting of the diaphragm is sensitive to mechanical disturbances and it must be reset at least every day by focusing on the radiation source at 600°C.

Heat source

A Chemical Data Systems 190 pyroprobe normally used in pyrolysis gas chromatography equipment was used as the heat source. It consists of a platinum resistance ribbon (2 × 0.1 in.) forming one arm of a Wheatstone bridge. The applied voltage is electronically controlled by a feedback circuit which responds to the control settings and makes corrections by sensing the resistance of the ribbon (which is a function of its temperature). The ribbon may be heated at pre-selected rates from 1 to 20°C msec⁻¹, to any temperature from 130 to 1000°C, and maintained at that temperature for periods from 20 msec to 20 sec. The sample to be examined is deposited on the central part of the ribbon which is housed in a hermetically sealed chamber fitted with an infrared transmitting window. The assembly, which allows the reaction to take place at various pressures (or in a vacuum) and in different atmospheres, is placed in the adjustable stage of the infrared microscope. The pyroprobe control circuit provides a trigger signal synchronous with the start of the heating cycle.

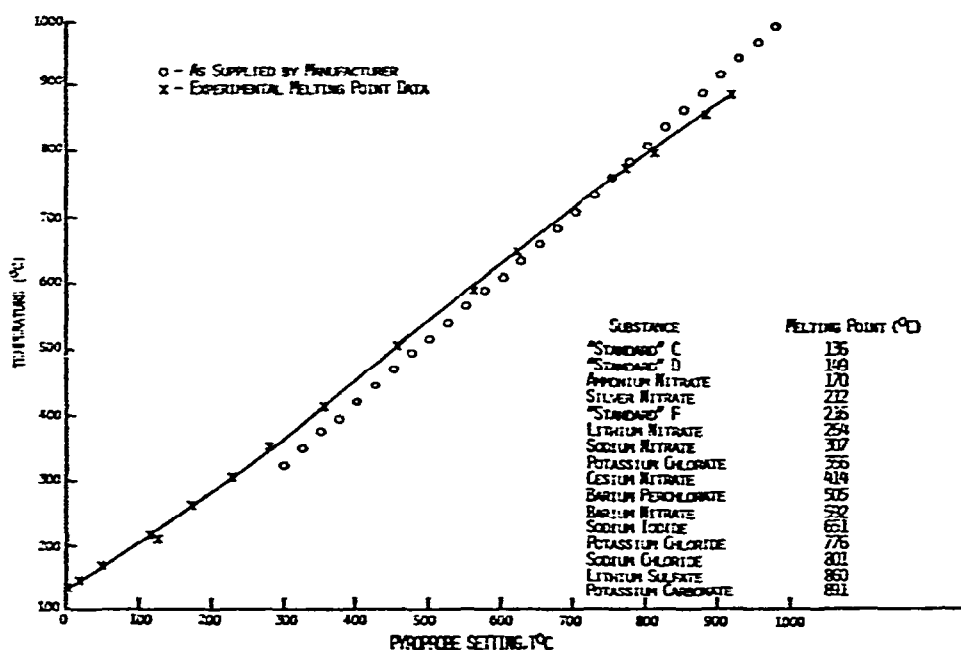

Fig. 2. Melting point calibration curve of platinum ribbon heat source.

The manufacturer of the pyroprobe supplies a calibration curve of platinum ribbon temperature versus control setting. Certain anomalous results of early experiments led to the use of melting point techniques to check the probe calibration. Figure 2 illustrates the discrepancies found and lists the compositions used. Because the reactions to which the probe is exposed very likely change its electrical characteristics and because the supplied curve does not extend below 300°C, it was necessary to use the melting point data as a more nearly true indication of temperature versus control setting. Radiometric measurement of the temperature of a platinum ribbon is a difficult procedure because its emissivity changes with temperature, and any alteration of the surface characteristics due to the heating of samples may cause permanent changes in its emissivity.

Recording systems

The experiment is generally started with the platinum ribbon and sample at ambient temperature. After all system adjustments are made, including those for the desired heating rate and maximum temperature, the experiment is initiated by switching on the pyroprobe controller. The linearizer output, KT (°C) versus time, is recorded on one channel of an FM tape recorder and at the same time may be viewed on a storage oscilloscope. The pyroprobe controller provides a trigger pulse synchronous with the start of the experiment which is recorded on a second tape channel and is also used to trigger the sweep of the storage scope. Results are immediately available for gross inspection on the oscilloscope face. The recorded curve and trigger pulse may be played back at any time to a delayed sweep oscilloscope where any desired portion of the temperature vs. time curve may be expanded, photographed and examined for detail. Concurrently, a differentiating circuit allows display of the derivative, dT/dt , on the second scope channel.

Emissivity measurements

As previously noted, the amplifier for the infrared microscope is provided with an input gain control to compensate for different target emissivities (E). For an emissivity of 1, the gain is 1; for other emissivities, the gain is $1/E$. To measure the emissivity of a target being viewed, the gain control is set so that the output voltage is equal to that from a black body at the same temperature and the value of E is read directly from the potentiometer dial. A switchable X10 attenuator permits reading values of E from 0.01 to 1.0.

Using the pyroprobe temperatures from melting point measurements, the emissivity of the platinum probe versus temperature was measured and is plotted in Fig. 3. A comparison of emissivity data from the literature⁴ with measured data is also shown in the Figure. The values subsequently used (as represented by the solid line of Fig. 3) for correction of temperature/time curves are heavily weighted in favor of our own experimental results. A $\pm 20\%$ error in emissivity setting results in readout error in indicated temperature of $\pm 7\%$.

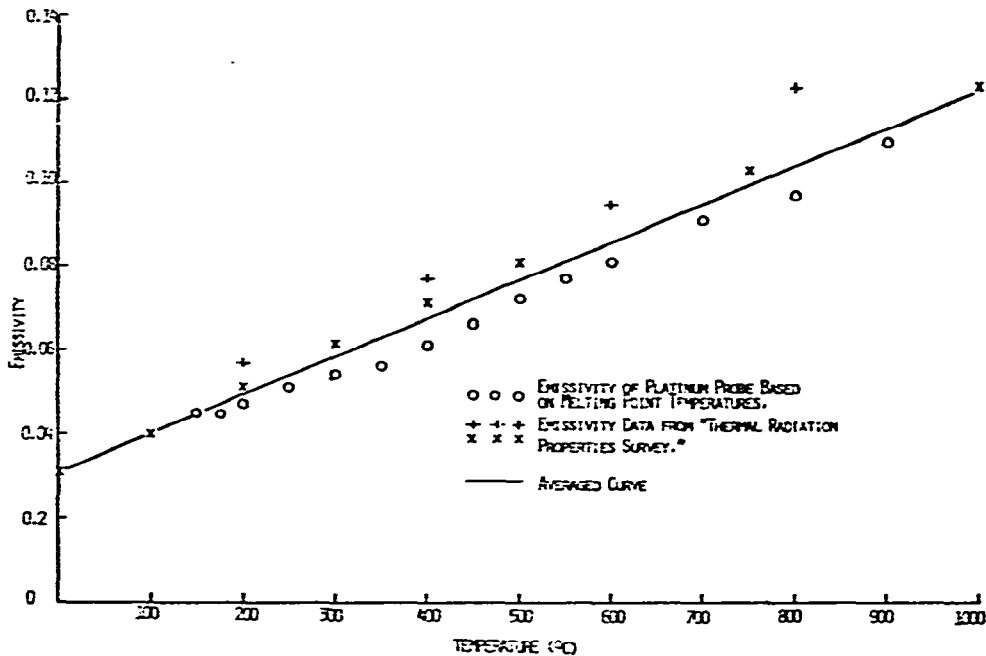

Fig. 3. Comparison of emissivity data from the literature with data measured using melting point technique for a platinum ribbon.

Heating rate

Figures 4 through 6 show the pyroprobe temperature versus elapsed time (from initiation of the heating cycle) for three representative heating rates. The input gain was set for the proper emissivity at 800°C and the probe temperature controller was set to heat the platinum to a maximum of 950°C (the highest obtainable with this particular ribbon). The resulting curves were then corrected for the variations in emissivity with temperature. The straight line in each figure represents the heating rate designated by the control setting. In all cases there is a low heating rate at the beginning and end of the cycle, and a linear portion which occupies the central 60 to 70% of the recorded temperature range (100–800°C) with the actual heating rate of the linear portion being greater than that chosen by the setting.

When a maximum temperature setting for the probe is chosen, it does not follow that the temperature will rise with even approximate linearity to that point. The heating circuit senses the approach to maximum and starts to shut down well in advance (a deliberate effect, to avoid overshoot). Setting the maximum temperature well above the range to be recorded adds a substantial amount to the "linear" part of the curve. This effect is illustrated in Fig. 7.

Sample deposition

The infrared microscope views an area approximately $5 \times 10^{-4} \text{ cm}^2$, making it possible to use an extremely small size sample, which is required to minimize the temperature gradient and the effect of the sample on the heated platinum ribbon.

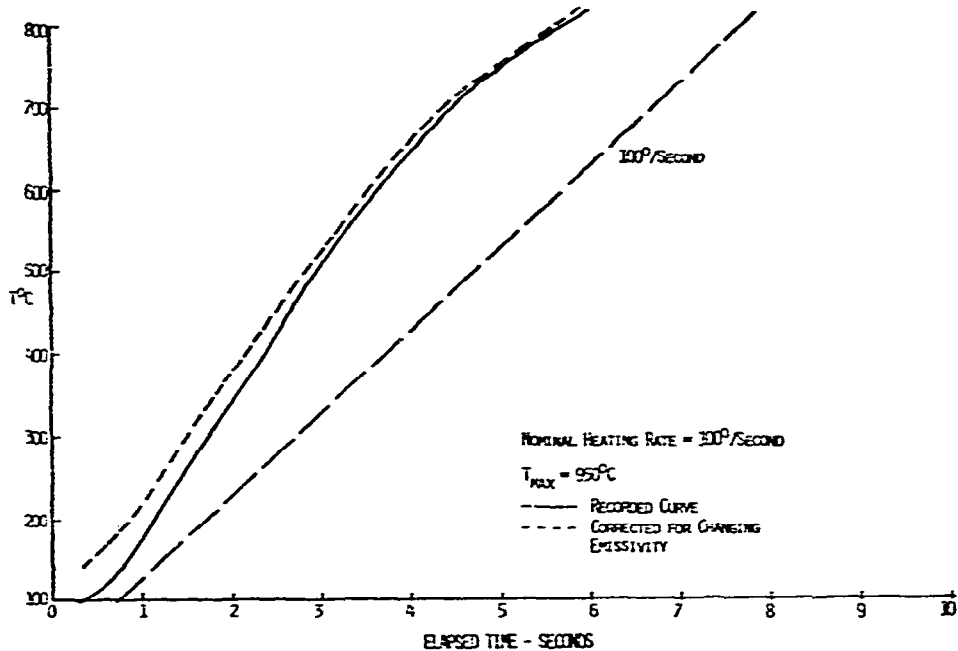

Fig. 4. Recorded and corrected temperature-time trace of platinum probe at a nominal heating rate of $100^{\circ}\text{C sec}^{-1}$.

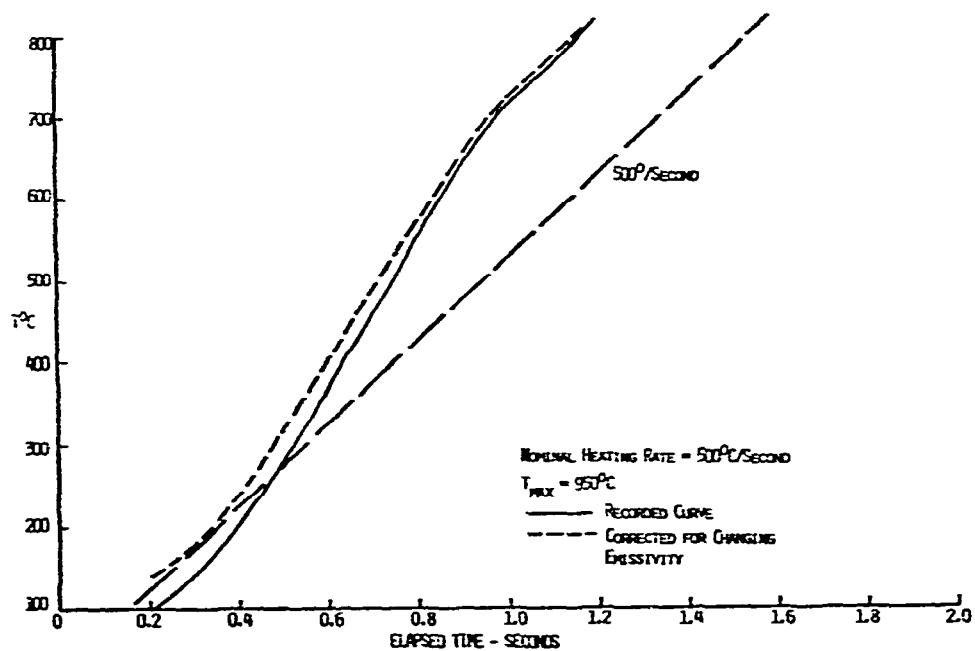

Fig. 5. Recorded and corrected temperature-time trace of platinum probe at a nominal heating rate of $500^{\circ}\text{C sec}^{-1}$.

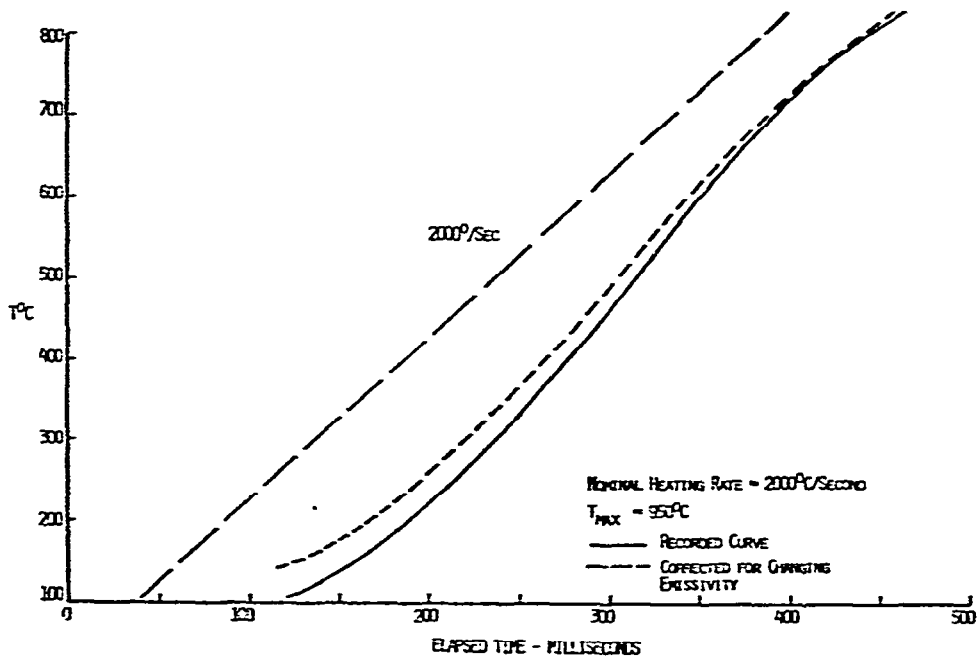

Fig. 6. Recorded and corrected temperature-time trace of platinum probe at a nominal heating rate of $2000^{\circ}\text{C sec}^{-1}$.

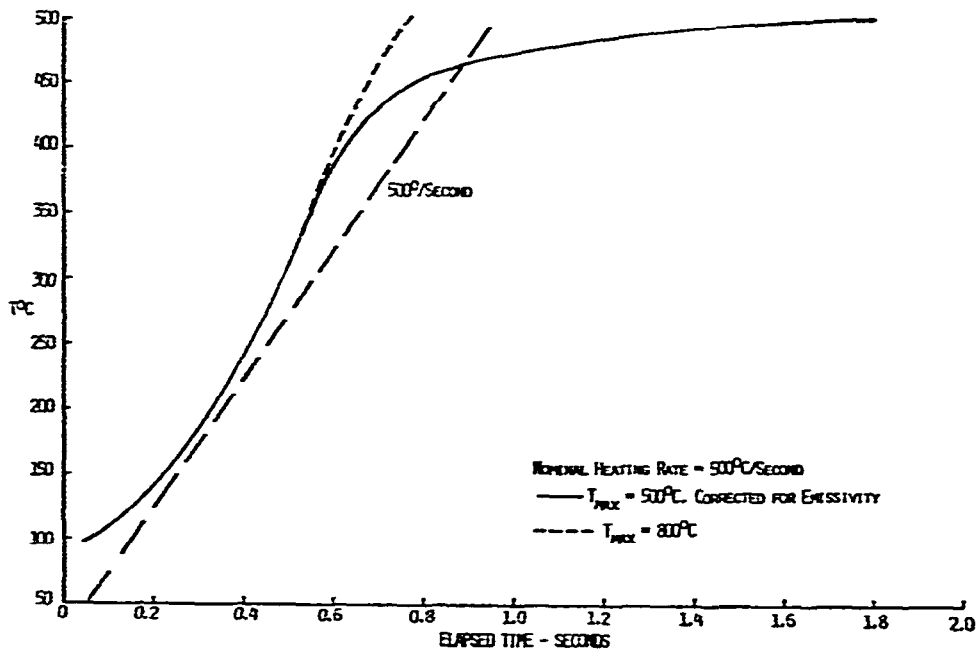

Fig. 7. Illustration of the effect of maximum temperature setting on the range of linear temperature rise rate of the platinum probe.

Good contact of the sample on the metal surface is necessary for efficient heat transfer and good adhesion is required to maintain the sample stationary.

Samples were deposited on the platinum ribbon by two methods. In the first, a small drop of known volume ($\sim 10 \mu\text{l}$) of a solution of the substance to be tested is deposited on the ribbon after which the ribbon is heated to about 100°C to evaporate the solvent. In other instances the end of a fine syringe needle is wet with some appropriate liquid to permit a small amount of the sample to adhere to the tip. The sample is then force flowed onto the ribbon and again the liquid is evaporated off. The techniques permit a known weight to be deposited on the ribbon which varied between 50 to $200 \mu\text{g}$.

RESULTS

Calcium oxalate

The DTA of calcium oxalate has been extensively investigated and was considered suitable to demonstrate the applicability of the high heating rate instrumentation. Shown in Fig. 8 are temperature-time traces (Curves A, B and C) of calcium oxalate hydrate in which the heating rates are 270, 750 and $1170^\circ\text{C sec}^{-1}$. In each curve endothermic dehydration is indicated by the change in slope in the vicinity of 200 to 300°C . The differentiation of the temperature-time trace shows the process more clearly. The peak temperature for the dehydration of calcium oxalate by conventional DTA is 230°C . The values obtained here are 210 (or 240°C) at a heating rate of $270^\circ\text{C sec}^{-1}$, 243°C at a heating rate of $750^\circ\text{C sec}^{-1}$ and 220°C at a heating rate of $1170^\circ\text{C sec}^{-1}$. The emissivities shown in the figures were experimentally acquired at a platinum surface temperature of 150°C . Thus, it is not surprising that the dehydration temperatures conform closely to the true values. The high value obtained at a heating rate of $750^\circ\text{C sec}^{-1}$ may be attributed, in fact, to the higher emissivity of that sample relative to the others. Emissivity measurements on a number of samples reveal that the emissivity increases with the increase in the thickness of the surface layer, however, the nature of this relationship, which was investigated in some detail, has not been resolved. The double peak (at 210 and 240°C) observed in the $270^\circ\text{C sec}^{-1}$ run was generally not observed and one of these may not be real.

The decomposition of calcium oxalate occurs at 510°C according to the reaction



The high heating rate thermal analysis shows exotherms at 615°C at a heating rate of $270^\circ\text{C sec}^{-1}$, 525°C at a heating rate of $750^\circ\text{C sec}^{-1}$ and 570°C at a heating rate of $1170^\circ\text{C sec}^{-1}$. These values are only approximate because of: (1) the possibility that the reaction is accompanied by an emissivity change; and (2) there are variations in the thickness of the sample layer, which influences the temperature gradient across the sample. The partial decomposition of CaC_2CO_4 to CO is an endothermic process; however, if the sample is heated in air, as was done in the trials reported here, the reaction of CO with oxygen produces an exotherm. Thus, the phenomena provide an

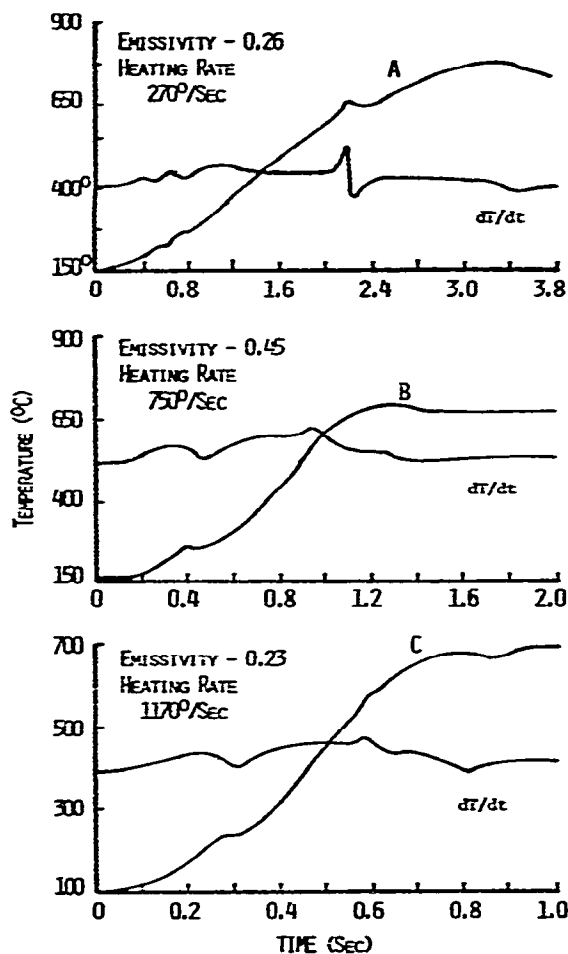

Fig. 8. High heating rate thermal analysis of calcium oxalate at heating rates of (A) $270^\circ\text{C sec}^{-1}$; (B) $750^\circ\text{C sec}^{-1}$; and (C) $1170^\circ\text{C sec}^{-1}$.

excellent method to determine if the observed change in slope of the high heating rate temperature–time trace in the vicinity of 525°C for calcium oxalate is due to a change in emissivity or to self-heating of the sample. Therefore the thermal analysis of $\text{CaC}_2\text{O}_4 \cdot \text{H}_2\text{O}$ was also performed with the sample under one atmosphere of nitrogen. The results show that the exotherm observed at $\sim 525^\circ\text{C}$ reverts to an endotherm under these conditions, from which it was concluded that the observed peaks do, indeed, represent a temperature change.

The carbon monoxide produced during the decomposition of calcium oxalate has been shown to undergo a disproportionation reaction when the sample is heated in the inert atmosphere⁷, thus



The formation of carbon explains the change in color from white to grey as was

observed by Simons and Newkirk⁵. A similar, more pronounced effect was observed in the high heating rate experiment. Using a heating rate of $\sim 500^\circ\text{C sec}^{-1}$ under one atmosphere of nitrogen the sample turned a greyish black; the blackness deepened when the experiment was performed at a nitrogen pressure of 25 psia. In addition, two heatings were required to decompose the sample. The first heating produced only the endotherm representing the dehydration step while the second heating produced the endotherms resulting from the decomposition of the oxalate and the carbonate. Thus, it appears that the decomposition of the oxalate is inhibited or becomes more sluggish if the disproportionation reaction of CO is allowed to occur. This aspect of the decomposition of calcium oxalate bears further scrutiny, however, the experiment demonstrates that the high heating rate method can provide qualitative information on the kinetics of fast reactions.

The decomposition process may also be accompanied by an emissivity change, in which case the height of the endothermic or exothermic peaks will be altered and the temperature calibration will be shifted. To check this possibility, the emissivity of calcium oxalate hydrate (or its decomposition products) was measured over the temperature range of 150 to 850°C and the temperature-time trace was corrected for emissivity. The results, shown in Fig. 9, indicate that the emissivity change has only a

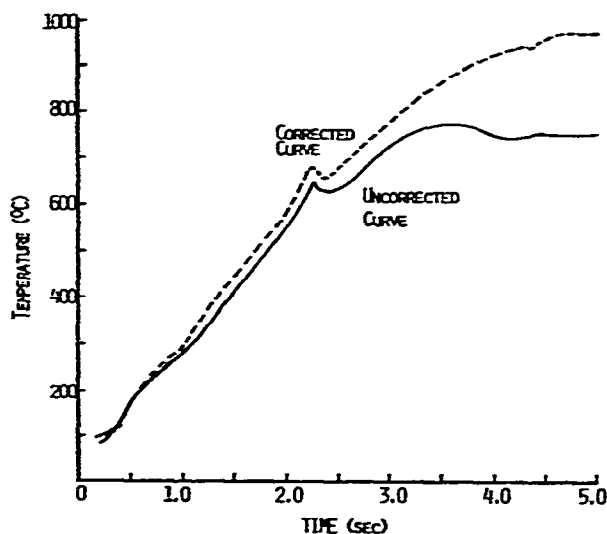

Fig. 9. Temperature-time trace of calcium oxalate at a heating rate of $270^\circ\text{C sec}^{-1}$ with and without emissivity correction.

minor effect on the temperature-time trace up to 700°C above which a very pronounced change takes place. At about 700°C the decomposition of calcium carbonate proceeds according to the reaction



Thus, it appears that the emissivity change due to this decomposition masks the heat

effect. The corrected curve (Fig. 9) produces an endothermic process at approximately 900°C which undoubtedly is caused by the decomposition of the carbonate.

Nitrocellulose

Nitrocellulose will ignite at about 200°C using conventional DTA at heating rates of 10 to 15°C min⁻¹ and the curve shows no distinguishing features below the ignition temperature. However, Rideal and Robertson⁶ have observed that the ignition of nitrocellulose is preceded by a liquefaction process. Presumably the liquefaction is caused by depolymerization and partial degradation of the material. A high heating rate thermal analysis was performed on 13.2% N nitrocellulose to determine if the liquefaction process preceding ignition is observable. The experiment was performed using about 0.1 mg of nitrocellulose deposited on the platinum ribbon from a concentrated acetone solution. The results are shown in Fig. 10. The heating rate is 535°C sec⁻¹ with the probe being heated in air. An exotherm was observed at

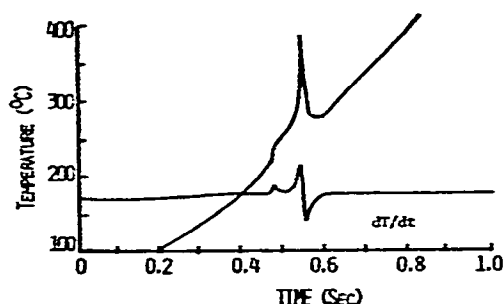

Fig. 10. High heating rate thermal analysis of 13.2% N nitrocellulose at a heating rate of 535°C sec⁻¹.

240°C which was followed, 65 msec later, by ignition at 280°C. Thermal theory of ignition predicts that the ignition temperature of nitrocellulose ranges between 275 to 300°C. The discrepancy between this temperature and a low heating rate (10°C min⁻¹) DTA ignition temperature (205°C) is explained by the possibility that DTA only detects the start of the reaction and cannot discriminate between the start of the reaction and the spontaneous ignition of the entire sample. The data reported here demonstrate these distinguishing features of the events leading to the ignition of nitrocellulose, which will be fully considered in a future paper.

REFERENCES

- 1 B. Wunderlich and L. M. Wolpert, in H. G. Wiedemann (Ed.), *Thermal Analysis, Vol. I, Advances in Instrumentation*, Berkhauser Verlag, Basel and Stuttgart, 1972, p. 17.
- 2 J. R. Cheng, N. W. Ryan and A. D. Baer, *Twelfth Symposium (International) on Combustion*, The Combustion Institute, 1969, p. 215.
- 3 L. S. Bouck, A. D. Baer and N. W. Ryan, *Fourteenth International Symposium on Combustion*, The Combustion Institute, 1973, p. 165.
- 4 G. G. Gulareff, J. E. Janssen and R. H. Torborg, *Thermal Radiation Properties Survey*, Honeywell Research Center, 1960.

- 5 E. L. Simons and A. E. Newkirk, *Talanta*, II (1964) 549.
- 6 E. K. Rideal and A. J. B. Robertson, *Third Symposium on Combustion, Flare and Explosion Phenomena*, Williams and Wilkins Co., Baltimore, Md., 1949, p. 536.
- 7 C. Lenchitz, E. Hayes, R. W. Velicky, L. Schlosberg and N. P. Suk, *Combust., Sci. Technol.*, 7 (1973) 1.