



**NONRESIDENT
TRAINING
COURSE**



September 1992

Journalist 1 & C

NAVEDTRA 14129

Although the words “he,” “him,” and “his” are used sparingly in this course to enhance communication, they are not intended to be gender driven or to affront or discriminate against anyone.

**NAVAL EDUCATION AND TRAINING
PROGRAM MANAGEMENT SUPPORT ACTIVITY
PENSACOLA, FLORIDA 32509-5000**

November 1992

Errata #1

Specific Instructions and Errata
for
Training Manual
JOURNALIST 1 & C

1. No attempt has been made to issue corrections for errors in typing, punctuation, etc.
2. Training Manual . . . _____

Cross out page 7-14 and insert replacement page 7-14 (reverse side of this errata).

Family, friends, squadron mates mourn loss of VT-4 instructor

A memorial service was held earlier this week at the Naval Aviation Memorial Chapel for Lt. Thomas Douglas Waterbury. The VT-4 flight instructor was killed April 15, during carrier operations in the Gulf of Mexico, approximately 70 miles south of Pensacola.

The 28-year-old naval officer was a resident of Little Silver, N.J., and a 1985 graduate of the U.S. Merchant Marine Academy at Kings Point, N.Y.

According to Navy officials, Waterbury and another pilot from VT-19, NAS Meridian, Miss., crashed after their T-2C Buckeye jet trainer was launched from the USS Forrestal.

Both aviators ejected, but rescuers were only able to find one pilot.

Several hundred people, including Lt. Waterbury's family, Vice Adm. Jack Fetterman and former Pensacola Mayor Vince Whitbbs, were on hand to pay their final respects to the man VT-4 Commanding Officer Cmdr. Pat Tilley described as "full of compassion and a love for life." Following the ceremony, a flight of four T-2s passed overhead in a "missing man" formation.

Prior to reporting to VT-4 in May 1991, Lt. Waterbury had served as an E-2 pilot with VAW-117 at NAS Miramar, Calif.



Lt. Thomas D. Waterbury
1983-1992

Serving the Cradle of
Naval Aviation since 1921

Gospoort

Vol. 58, No. 18

Serving the Cradle of Naval Aviation Pensacola, Florida

April 24, 1992

Corry Station instructor picked as CNET SoY

By Ensign Eric K. Dolan

CNET Public Affairs

CTT1 James H. Henderson Jr., an instructor assigned to NTTC Corry Station, was recently selected as the CNET Sailor of the Year.

In presenting the master training specialist with the CNET Sailor of the Year plaque, Vice Adm. Jack Fetterman, Chief of Naval Education and Training said, "Collectively, all our candidates have gone above and beyond. They are Sailor of the Year nominees because they simply enjoy what they are doing."

One of five finalists competing for the prestigious title, Petty Officer Henderson credited his winning philosophy to his father. "Winners make it happen. Losers watch it happen," he told those present for the Sailor of the Year banquet.

A native of Covington, Ky., Petty Officer Henderson is an assistant company commander and instructor in the Cryptologic Training Department's Basic School. As an instructor in the school he was instrumental in 14 students winning the prestigious Samuel F. B. Morse Award.



CTT1 James H. Henderson is presented with a plaque naming him CNET Sailor of the Year by Chief of Naval Education and Training, Vice Adm. Jack Fetterman.

Prior to his selection as CNET Sailor of the Year, Petty Officer Henderson was selected as the Chief of Naval Tech-

nical Training Command's Sailor of the Year.

Henderson will now go on to compete for the title of Chief of Naval Operations Sailor of the Year. The CNO Sailor of the Year competition will be held in Washington, D.C., next month.

Other nominees for CNET Sailor of the Year were:

DS1 Joseph F. McClelland Jr., representing the Commander, Training Command, U.S. Atlantic Fleet. McClelland is an instructor at the Fleet and Mine Warfare Training Center, Charleston, S.C.

OS1 David A. Pearson, representing the Commander, Training Command, U.S. Pacific Fleet. Pearson is a master training specialist for the Air Control Division, San Diego.

Lt1 David P. Nesbitt, representing the Chief of Naval Air Training Command, NAS Meridian, Miss. Nesbitt is assigned to the NAS Meridian Legal Office.

HM1 Lynn C. Martin, representing Naval Education and Training Direct Reporters, Pensacola Naval Hospital. Martin is leading petty officer of the Branch Medical Clinic.

Orange Park school captures NJROTC Field Day crown

By Gregory P. Stallworth

CNET Public Affairs

Approximately 380 high school students participated in the second annual Navy League National NJROTC Field Day Championship held last weekend aboard NAS. Participating cadets represented nine of the top NJROTC drill teams from New Jersey, New York, Virginia, North Carolina, Georgia, Florida, Mississippi and Texas. The event, sponsored by the Pensacola Chapter of the Navy League of the United States, encompassed two days of rigorous military drill, athletic and academic competition.

Activities came to a dramatic ending with an awards ceremony held at the Naval Aviation Schools Command parade grounds, presided over by Rear Adm. Louise C. Wilmot, Vice Chief of Naval Education and Training. Parents stood on the side lines wearing proud smiles as the cadets stood in rigid formation anx-

iously waiting for the announcement of winners. Loud cheers greeted the announcement awarding the overall championship to the unit from Orange Park High School, Orange Park, Fla.

"We're extremely proud to have won," said Cmdr. Charles Lusk, Naval Science Instructor at Orange Park High School. "Our success can be attributed to the dedication and hard work that all of our students put forth. The competition was tough, but our team effort put us over the edge."

Recognizing the NJROTC program as a means to starting a successful career, one Orange Park High School student said being a part of NJROTC is one of the most rewarding things he has ever done. It's an organization that his parents fully support.

"NJROTC has opened a lot of doors for me that I probably would have never been able to open by myself," Cadet Michael Klappmeyer

said. "Since the very start, my dad loved the idea of my being a part of the program, but my mother was a little skeptical at first. Now that she has seen what the program is really about, she likes it and is really getting into it." He added that through NJROTC he has been awarded a four-year NROTC college scholar-

ship which he plans to use at Auburn University, Jacksonville University or the Illinois Institute of Technology.

The unit from Middleburg High School, Middleburg, Fla., placed second, while the cadets from George Washington High School, Danville, Va., placed third.



Rear Adm. Louise Wilmot, Vice Chief of Naval Education and Training, congratulates NJROTC cadets on their winning performance during last week's Field Day Championships.

Published by Pensacola Progress Company, a service firm in no way associated with the Department of the Navy. Opinions contained herein are not official expressions of the Department of the Navy nor do the advertisements constitute Department of the Navy or NAS Pensacola endorsement of products or services advertised.

PREFACE

By enrolling in this self-study course, you have demonstrated a desire to improve yourself and the Navy. Remember, however, this self-study course is only one part of the total Navy training program. Practical experience, schools, selected reading, and your desire to succeed are also necessary to successfully round out a fully meaningful training program.

THE COURSE: This self-study course is organized into subject matter areas, each containing learning objectives to help you determine what you should learn along with text and illustrations to help you understand the information. The subject matter reflects day-to-day requirements and experiences of personnel in the rating or skill area. It also reflects guidance provided by Enlisted Community Managers (ECMs) and other senior personnel, technical references, instructions, etc., and either the occupational or naval standards, which are listed in the *Manual of Navy Enlisted Manpower Personnel Classifications and Occupational Standards*, NAVPERS 18068.

THE QUESTIONS: The questions that appear in this course are designed to help you understand the material in the text.

VALUE: In completing this course, you will improve your military and professional knowledge. Importantly, it can also help you study for the Navy-wide advancement in rate examination. If you are studying and discover a reference in the text to another publication for further information, look it up.

*1992 Edition Prepared by
JOC Dave Marr*

Published by
NAVAL EDUCATION AND TRAINING
PROFESSIONAL DEVELOPMENT
AND TECHNOLOGY CENTER

**NAVSUP Logistics Tracking Number
0504-LP-026-7880**

Sailor's Creed

“I am a United States Sailor.

I will support and defend the Constitution of the United States of America and I will obey the orders of those appointed over me.

I represent the fighting spirit of the Navy and those who have gone before me to defend freedom and democracy around the world.

I proudly serve my country's Navy combat team with honor, courage and commitment.

I am committed to excellence and the fair treatment of all.”

CONTENTS

CHAPTER	Page
1. Public Affairs Office Management1-1
2. Public Affairs In Adverse News Situations2-1
3. The Command Information Bureau3-1
4. Media Relations4-1
5. Community Relations and Special Events5-1
6. Speeches6-1
7. Newspaper Staff Supervision7-1
8. Broadcast Management8-1
9. Audience Surveys9-1
APPENDIX	
I. Sample Format for a Public Affairs Plan	AI-1
II. Sample Public Affairs Annex to an Operation Order	AII-1
III. CIB Plan	AIII-1
IV. Adverse Incident Plan	AIV-1
V. Ship Commissioning Plan.	AV-1
VI. Ship Decommissioning Plan	AVI-1
VII. Special Events ChecklistAVII-1
VIII. References Used to Develop the TRAMAN	AVIII-1
INDEX	INDEX-1

CREDITS

The illustrations listed below are included in this edition of *Journalist 1 & C*, through the courtesy of the designated sources. Permission to use these illustrations is gratefully acknowledged. Permission to reproduce illustrations and other materials in this publication must be obtained from the source.

SOURCE

FIGURES

Public Relations Quarterly

1-15

Que Corporation, a division of
Prentice Hall Computer Publishing

7-7

INSTRUCTIONS FOR TAKING THE COURSE

ASSIGNMENTS

The text pages that you are to study are listed at the beginning of each assignment. Study these pages carefully before attempting to answer the questions. Pay close attention to tables and illustrations and read the learning objectives. The learning objectives state what you should be able to do after studying the material. Answering the questions correctly helps you accomplish the objectives.

SELECTING YOUR ANSWERS

Read each question carefully, then select the BEST answer. You may refer freely to the text. The answers must be the result of your own work and decisions. You are prohibited from referring to or copying the answers of others and from giving answers to anyone else taking the course.

SUBMITTING YOUR ASSIGNMENTS

To have your assignments graded, you must be enrolled in the course with the Nonresident Training Course Administration Branch at the Naval Education and Training Professional Development and Technology Center (NETPDTC). Following enrollment, there are two ways of having your assignments graded: (1) use the Internet to submit your assignments as you complete them, or (2) send all the assignments at one time by mail to NETPDTC.

Grading on the Internet: Advantages to Internet grading are:

- you may submit your answers as soon as you complete an assignment, and
- you get your results faster; usually by the next working day (approximately 24 hours).

In addition to receiving grade results for each assignment, you will receive course completion confirmation once you have completed all the

assignments. To submit your assignment answers via the Internet, go to:

<http://courses.cnet.navy.mil>

Grading by Mail: When you submit answer sheets by mail, send all of your assignments at one time. Do NOT submit individual answer sheets for grading. Mail all of your assignments in an envelope, which you either provide yourself or obtain from your nearest Educational Services Officer (ESO). Submit answer sheets to:

COMMANDING OFFICER
NETPDTC N331
6490 SAUFLEY FIELD ROAD
PENSACOLA FL 32559-5000

Answer Sheets: All courses include one “scannable” answer sheet for each assignment. These answer sheets are preprinted with your SSN, name, assignment number, and course number. Explanations for completing the answer sheets are on the answer sheet.

Do not use answer sheet reproductions: Use only the original answer sheets that we provide—reproductions will not work with our scanning equipment and cannot be processed.

Follow the instructions for marking your answers on the answer sheet. Be sure that blocks 1, 2, and 3 are filled in correctly. This information is necessary for your course to be properly processed and for you to receive credit for your work.

COMPLETION TIME

Courses must be completed within 12 months from the date of enrollment. This includes time required to resubmit failed assignments.

PASS/FAIL ASSIGNMENT PROCEDURES

If your overall course score is 3.2 or higher, you will pass the course and will not be required to resubmit assignments. Once your assignments have been graded you will receive course completion confirmation.

If you receive less than a 3.2 on any assignment and your overall course score is below 3.2, you will be given the opportunity to resubmit failed assignments. **You may resubmit failed assignments only once.** Internet students will receive notification when they have failed an assignment--they may then resubmit failed assignments on the web site. Internet students may view and print results for failed assignments from the web site. Students who submit by mail will receive a failing result letter and a new answer sheet for resubmission of each failed assignment.

COMPLETION CONFIRMATION

After successfully completing this course, you will receive a letter of completion.

ERRATA

Errata are used to correct minor errors or delete obsolete information in a course. Errata may also be used to provide instructions to the student. If a course has an errata, it will be included as the first page(s) after the front cover. Errata for all courses can be accessed and viewed/downloaded at:

<http://www.advancement.cnet.navy.mil>

STUDENT FEEDBACK QUESTIONS

We value your suggestions, questions, and criticisms on our courses. If you would like to communicate with us regarding this course, we encourage you, if possible, to use e-mail. If you write or fax, please use a copy of the Student Comment form that follows this page.

For subject matter questions:

E-mail: n313.products@cnet.navy.mil
Phone: Comm: (850) 452-1001, Ext. 2169
DSN: 922-1001, Ext. 2169
FAX: (850) 452-1370
(Do not fax answer sheets.)
Address: COMMANDING OFFICER
NETPDTC (CODE N313)
6490 SAUFLEY FIELD ROAD
PENSACOLA FL 32509-5237

For enrollment, shipping, grading, or completion letter questions

E-mail: fleetservices@cnet.navy.mil
Phone: Toll Free: 877-264-8583
Comm: (850) 452-1511/1181/1859
DSN: 922-1511/1181/1859
FAX: (850) 452-1370
(Do not fax answer sheets.)
Address: COMMANDING OFFICER
NETPDTC (CODE N331)
6490 SAUFLEY FIELD ROAD
PENSACOLA FL 32559-5000

NAVAL RESERVE RETIREMENT CREDIT

If you are a member of the Naval Reserve, you will receive retirement points if you are authorized to receive them under current directives governing retirement of Naval Reserve personnel. For Naval Reserve retirement, this course is evaluated at 15 points. These points will be credited in units, as follows:

Unit 1 - 12 points upon satisfactory completion of assignments 1 through 7.

Unit 2 - 3 points upon satisfactory completion of assignments 8 and 9.

(Refer to *Administrative Procedures for Naval Reservists on Inactive Duty*, BUPERSINST 1001.39, for more information about retirement points.)

COURSE OBJECTIVES

In completing this nonresident training course, you will demonstrate a knowledge of the subject matter by correctly answering questions on the following: Public Affairs Office Management, Public Affairs in Adverse News Situations; The Command Information Bureau; Media Relations; Community Relations and Special Events; Speeches; Newspaper Staff Supervision; Broadcast Management; and Audience Surveys.

Student Comments

Course Title: Journalist 1 & C

NAVEDTRA: 14129 **Date:** _____

We need some information about you:

Rate/Rank and Name: _____ SSN: _____ Command/Unit _____

Street Address: _____ City: _____ State/FPO: _____ Zip _____

Your comments, suggestions, etc.:

Privacy Act Statement: Under authority of Title 5, USC 301, information regarding your military status is requested in processing your comments and in preparing a reply. This information will not be divulged without written authorization to anyone other than those within DOD for official use in determining performance.

NETPDTC 1550/41 (Rev 4-00)

CHAPTER 1

PUBLIC AFFAIRS OFFICE MANAGEMENT

There are many senior JO assignments in the Navy in which you may be called upon to manage your own shop. A JO1 at a small shore installation, for example, may be the managerial backbone of a collateral duty public affairs officer (PAO) who can devote only a fraction of his time to public affairs. The same JO1 may perform in an independent duty billet where he will be expected to perform the duties and assume the responsibilities of a PAO. Practically every senior JO is called, at one time or another, to take charge of the office when the PAO is absent.

As a JO1 or JOC, you must be ready to step in and effectively manage a public affairs office, either as the lone administrator or as the PAO's assistant.

Managing a public affairs office entails several things, such as administration and file maintenance, personnel training, and even developing standard procedures for telephone etiquette and taking messages. It is a subject so broad that this manual cannot adequately cover it all in one or two chapters. However, the following pages provide the basic tools and knowledge for you to grow as a public affairs office manager and leader.

MANAGEMENT TOOLS

Learning Objective: *Recognize the administrative tools of managing a public affairs office.*

Whether you serve in an independent duty billet or work for a full-time 1650 PAO, the following three essentials are necessary for you to set up a successful public affairs office:

- The authority to do the job
- The support of the officer in command and his staff
- The resources to do the job

AUTHORITY

Your primary authority for doing the job is *Department of the Navy Public Affairs Policy and Regulations*, SECNAVINST 5720.44A. (This publication will subsequently be referred to by its short title, *PA Regs.*)

PA Regs has been issued as an instruction from the Secretary of the Navy (SECNAV) who, by law and regulation, is responsible for relationships with the Navy's publics. It not only provides policy guidance, but also outlines regulations and recommends general practices and procedures for the conduct of a public affairs program. It contains much of the authority you need to perform your job, and in addition, it provides a wealth of information and practical guidance.

Furthermore, there are usually instructions issued by area, fleet or force commanders which implement or supplement the basic provisions in *PA Regs*.

RESOURCES

As the office manager or administrative assistant to the PAO, you will be responsible for managing resources—manpower, funds, supplies and equipment—that are budgeted for public affairs.

Although your authority to do the job originates from outside the command and is delegated to the officer in command, the means for you to do the job must come from within. Individual commands must use their own funds for supplies, equipment and the payrolls of personnel engaged in public affairs work.

STAFF ORGANIZATION

Learning Objective: *Identify the organization of a Navy staff and its functions.*

A large percentage of public affairs assignments for senior JOs is with major staffs. You should become familiar with basic staff organizational procedures and the duties of key staff officers and divisions. You must know how the PAO and his staff fit into a command organization.

The modern staff organization is the evolution of centuries of experience of military commanders. Activities are divided into functional areas. Responsibilities and relationships are refined so that most military staff organizations today conform to a similar pattern.

NAVY STAFFS

A typical Navy staff structure is shown in figure 1-1. In addition to the commander (usually an admiral), the staff includes a chief of staff, personal assistants (the PAO and JOs may be included in this category) and five staff divisions. These divisions are the major structural elements of the staff and may be designated by letters and numbers as follows: administration (N-1), intelligence (N-2), operations and plans (N-3), logistics (N-4) and communications (N-5). A joint staff, comprised of personnel from more than one service, uses the letter "J" before the division number.

On small staffs (below fleet and force), titles of officers heading the various sections vary from the above designations, depending on the rank of the commander. For example, instead of a chief of staff, you might find a chief of staff officer or an assistant chief of staff for administration. It all depends on the size of the command.

The commander's personal staff performs duties prescribed by the commander and is directly responsible to him. This staff group, normally composed of aides to the commander and staff officers handling special matters over which the commander wishes to exercise close personal control, usually includes the PAO, and in major overseas commands, the political adviser.

When reporting to a new command or staff, you should examine the staff organization and become familiar with the functions of the various divisions. Become thoroughly familiar with your internal and external audiences of the organization and the extent of their knowledge of command activities.

COMMAND AND STAFF ACTION

A military organization is designed primarily to be victorious in battle. Decisive elements of a problem must be promptly identified and accurately defined. Command decisions must then be made and translated into timely orders to be carried out by subordinates.

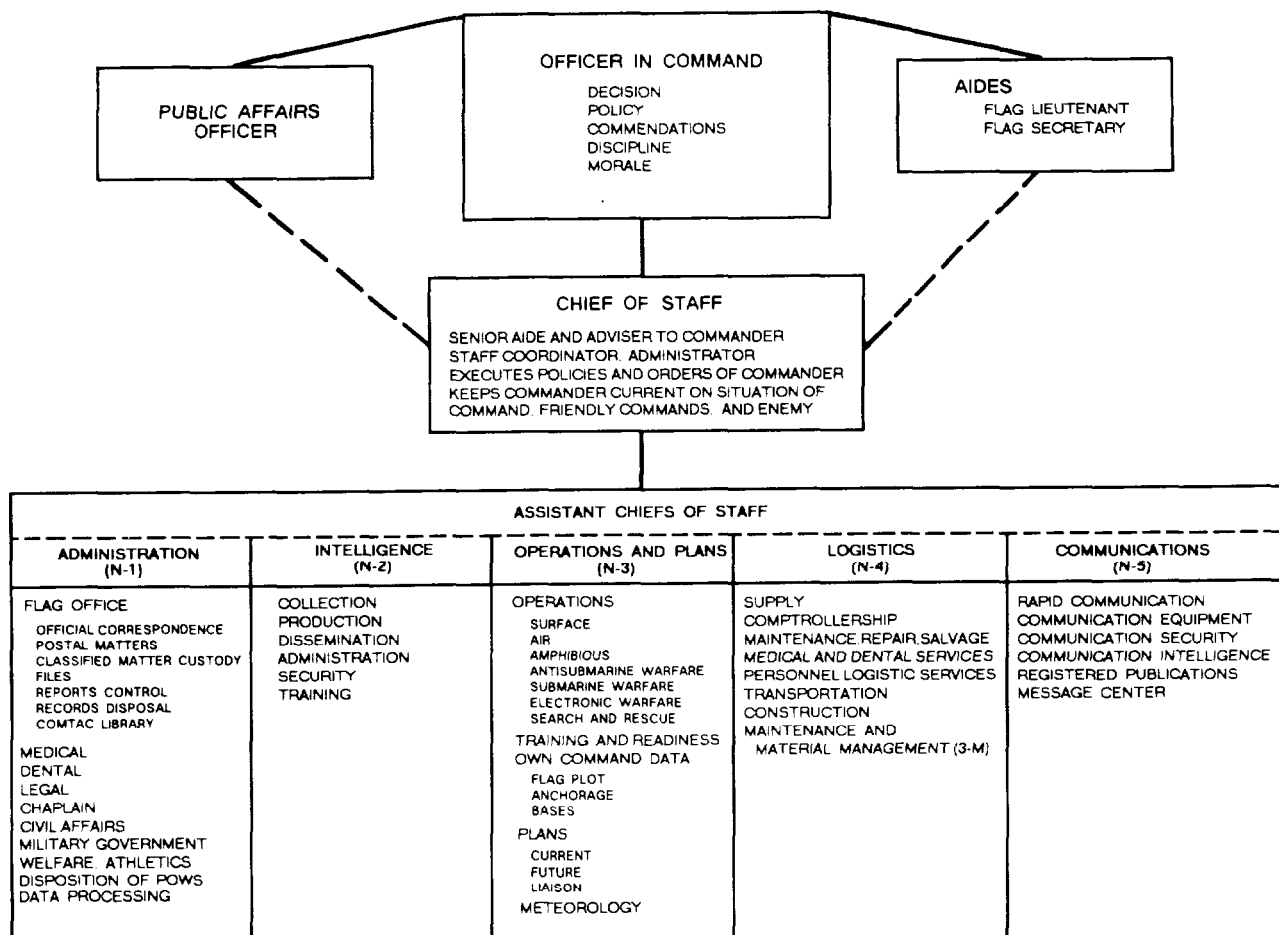

Figure 1-1. Typical modern staff organization.

Staffs are organized to assist the commander in decision-making and accomplishing the mission of the command. A staff must be immediately responsible to the needs of the commander and of subordinate units to make sure all pertinent information is available for consideration, to reduce the time needed for control, integration and coordination of operations, to reduce errors and to minimize the requirement for detailed supervision of routine matters by the commander.

STAFF FUNCTIONS

Effective staff procedures assist a commander by decreasing the number of items requiring command decisions, speeding up the processing of information into material useful to the commander in making decisions and improving the quality of the product presented to him.

It is important for personnel assigned to the public affairs staff to not only know the detailed procedures and techniques of their own office, but also those commonly used by all staff divisions. The broad functions performed by all sections of the staff in their daily activities are as follows:

- To provide advice and information
- To develop plans
- To organize resources
- To achieve coordination
- To make recommendations and decisions
- To prepare and transmit directives
- To maintain control through supervision

Advise and Provide Information

Information bearing on particular situations continuously flows into a headquarters by telephone, facsimile machine, mail, messages and word of mouth. It comes from higher and lower echelons, from intelligence reports, routine reports and personal observation and conversations.

The public affairs staff must stay current on situations within the command so it will know whether the information received will aid the commander, other staff sections or subordinates. You must judge the significance, reliability and completeness of the information. The commander should not be burdened with a mass of undeciphered information, irrelevant facts or unfounded rumors. Above all, public affairs

efforts must be objective. Facts must be prepared as they are-not as the commander would like them to be.

Develop Plans

An important staff responsibility is to anticipate the needs of the commander and the command. To plan ahead, staffs evaluate past performances, seek new information and use imagination. They collect information pertinent to anticipated missions for the command, prepare staff studies, make preliminary estimates of situations, develop plans and amend the plans as additional information is received or as situations change. Preparation for contingencies can be done only with thorough forethought. Lack of preparation inevitably leads to hasty planning, errors and omissions.

Some staffs have a separate plans and programs directorate or division, but in most commands, planning is assigned to operations. No matter where planning is assigned, it is a responsibility of all staff members to remain alert to the need for a new plan or directive. Each public affairs office is responsible for its own internal plans and for preparing the public affairs aspects of general plans drawn up by the plans division.

Organize Resources

Public affairs staffs must continually seek ways to make the best use of the limited resources of personnel, money, material and time. In any staff operation, there is a constant threat of waste, and the larger the operation, the greater the threat. To organize resources for maximum effectiveness, you cannot merely plan for the use of individual resources. You must think in terms of the total resources of the command.

Frequently, a public affairs office staff must accomplish its mission with fewer personnel than what should be in place. As the senior JO and office supervisor, you must make every effort to maintain the best qualified JO/PH teams available. You are responsible to the PAO for the training and qualifications of the people you supervise. Through proper assignment and supervision, you must get the most you can out of their efforts.

Achieve Coordination

“Coordinate” means to bring all related activities together at the correct time and in the correct order so they are in harmony for carrying out objectives. It is the

meshing of operations between commands or within a command.

Staff coordination promotes cooperation, reduces friction and decreases the number of differences requiring command decisions. Your thorough knowledge of all actions taken or proposed is essential to assure unity of action. The correlation of all staff activities depends, chiefly, upon the free interchange of information among the divisions.

Make Recommendations and Decisions

A well-oriented staff takes much of the burden of decision-making off the commander. Its members make decisions where authority exists for the action, or where the decision is in agreement with command policy.

Since responsibility for action cannot be delegated, staff officers should realize they are not acting for themselves, but for the commander.

Decisions made by staff officers are generally of a routine or technical nature. For example, although the commander may make the decision as to the nature and scope of the operational training program, the operations officer generally makes all decisions regarding such items as scheduling and phasing. At all times, the staff officer should inform the commander of any significant decisions made for him or in his name.

Normally, a commander delegates authority to his PAO to make routine news releases. The PAO, within the limits of authority delegated to him, makes routine decisions daily, as he checks security aspects, edits releases for propriety, accuracy, timing and policy and considers the overall impact on the public.

When a news story contains information in a sensitive or questionable area, a conscientious PAO verifies the facts, prepares a statement and then seeks the commander's approval. With experience, you will know when it is appropriate to prepare the statement.

Prepare and Transmit Directives

Decisions made by an individual staff officer, by detailed coordination of the entire staff, or by the commander on the spot, require implementation. On smoothly operating staffs, implementation is made possible through clear, concise directives. These directives may take the form of operation orders, letters, standard operating procedures (SOPs), notices, instructions, regulations or any other means suitable to the occasion.

Usually, a staff section prepares a directive, coordinates it with other staff sections and submits it to the commander for approval. The directive must state the intentions of the commander and contain the instructions needed to carry out the action. Then, if the commander concurs with the recommendation, all he needs to do is sign the directive, it can be published and promulgated.

The PAO prepares the public affairs portion of an operations order, an administrative instruction for the operation of a headquarters on a continuing basis, a special event or of an accident or disaster plan. The objectives of the public affairs action to be taken and the responsibilities for reporting and accomplishing the mission are stated within the directive.

Public affairs directives are basic to the accomplishment of the public affairs mission, which is to inform external and internal publics. A directive establishes relationships and responsibilities within a command so that the public affairs function of the command reflects the commander's desires and leadership.

Maintain Control Through Supervision

Staff responsibilities go beyond the issuance of directives. Staff members make sure directives are understood and carried out according to the intentions of the commander. They also recommend changes to directives to improve efficiency when practice indicates that an existing directive is inappropriate.

Control is a two-way process. In contacts with subordinate units, staff officers determine whether the standards, policies and procedures established in directives are realistic and effective. They also verify reports to determine whether the staff is getting complete data and that only necessary information is being reported. If better ways of accomplishing the mission can be found, they are adopted.

STAFF RELATIONSHIP WITH THE FLAGSHIP

The relationship between the staff and the flagship is governed by Navy Regulations. Except for matters of general discipline, which are subject to the internal regulations and routine of the ship, staff officers have no administrative connection with the flagship. Staff enlisted personnel are assigned to the flagship for administration and discipline. (At shore complexes, where there is a concentration of several large staffs, a

centralized flag administrative unit usually takes care of enlisted administration.)

The flag division officer, with the approval of the chief of staff, assigns enlisted duties, watches and battle stations, regulates leave and liberty and makes sure they carry out the flagship's administrative routine. To discharge his duties effectively, the flag division officer maintains close liaison with the XO.

Commanders usually refrain from interfering with the internal administration of the flagship. In this respect, the flagship is the same as any other ship in the command.

OFFICE LOCATION AND APPEARANCE

Learning Objective: Identify the proper location and appearance of a public affairs office.

The location and appearance of the public affairs office are important considerations. The office should be located as near as possible to the offices of the officer in command and the chief of staff, yet at the same time, it should be accessible to the news media and public. Since the public affairs office is often the public's only point of contact with the command, the location, finishings, displays and courtesy offered should make a favorable impression on visitors. An efficiently manned, attractive, but not flamboyant reception room is desirable. Visiting media representatives should have access to a newsroom or news center where they can work on or file their stories. Facilities to accommodate one or two correspondents are usually adequate.

First impressions are lasting ones, which is why you should maintain a clean, uncluttered office space. Doing this tells the public and the media that they are dealing with public affairs professionals. Make sure files, videotapes, press clips, and so forth, are properly stored when they are not in use. Maintain an immaculate coffee mess. Applying some forethought in this area will make a difference in your relations with both of these groups.

The PAO and his assistant should have separate and preferably soundproof offices to ensure privacy of conversations with sources of information, media, visitors and staff members,

Telephone service for each key member of the public affairs office is important to the success of the public affairs mission. Afloat and ashore public affairs offices should have the capability of direct dial access that bypasses the switchboard of the command. This provides a communication channel to the public should

the ship or station switchboard be overloaded or knocked out by a disaster or local emergency. If possible, the public affairs office should also have one unlisted telephone number to provide communication in the event the listed office telephones are swamped during a major disaster or news event.

Space and manpower are often wasted due to poor planning. In office management planning, you should consider such factors as the office mission, work flow and the use of personnel. If the office to which you are assigned is not functioning properly, a rearrangement may be in order.

Office arrangement is an area in which room for improvement frequently exists. Often, it is apparent from casual observation that offices are laid out with little regard to the tasks to be performed. Areas may be overcrowded in one office while space is being wasted in the office down the passageway.

Available ground transportation on a 24-hour basis is also needed for the effective operation of a public affairs office. Where military taxi service is not available on short notice, you should consider requesting the assignment of a military vehicle to provide courier service to the local media. This vehicle can also be used for public affairs personnel needing transportation in support of internal, community and public information events.

Some commands issue identification cards, badges or arm bands to key public affairs personnel which authorizes their access to disaster scenes and restricted events. The use of these devices must be authorized by a command directive to ensure that military law enforcement personnel, gate guards and other military officials honor them. Additional information on this topic may be found in Chapters 2 and 3.

NOTE: The subject just discussed is based on large staff commands ashore and large fleet-level commands afloat. The suggestions may be impossible to implement at some commands because the required space, funds and associated material/equipment are not available.

ADMINISTRATIVE PROCESSES

Learning Objectives: Determine the basic administrative processes required to manage a public affairs office.

To achieve administrative ability, you must first master the following five basic administrative processes:

- Planning
- Organizing
- Coordinating
- Supervising
- Evaluating

PLANNING

By now the word planning should be a familiar term. Every orderly process begins with planning. The administration of an office is no exception.

Planning is just another name for determining in advance the public affairs goals of the office. Every office has a number of jobs to do and a number of men and women to do them. The planning process begins when you recognize the fact that a job must be done and take steps to do something about it.

Planning covers a wide range of decisions. It includes setting goals, establishing standards, laying

ground rules or policies, determining methods and procedures and fixing day-to-day or job-to-job schedules.

To plan properly, you must collect all the information you need in advance and analyze each job thoroughly. You must attempt to foresee any problems that may arise and try to work out solutions ahead of time.

ORGANIZING

Effective management requires organization. Organizing consists of breaking down all the jobs into related units, then assigning them to the personnel most capable of doing the work in each unit.

Most large public affairs offices are organized into departments by the following functions: internal information, community relations, media relations and administration. Figure 1-2 shows a typical public affairs office organization chart. The media relations division, for example, may have a radio/television section, news photo section and a press section. A yeoman or civilian secretary might handle the clerical work. Petty officers would supervise each section with an officer responsible for the entire department.

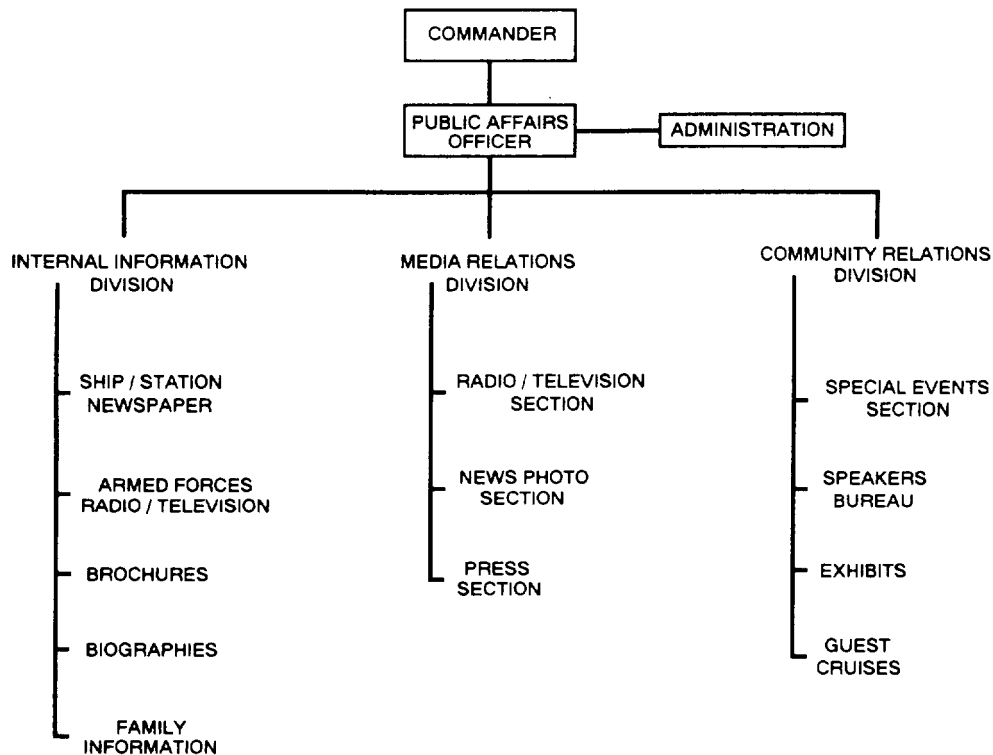

Figure 1-2.-Public affairs office organizational chart (large).

The major advantage of departmentalization is specialization. By concentrating on a single phase of work, personnel achieve specialized knowledge and skills that enable them to do the work more professionally and complete it more quickly. They are also able to establish closer working relations with media representatives.

Specialization also has its disadvantages. One disadvantage is that JOs sometimes develop a narrow point of view or "tunnel vision." Also, public affairs specialists who concentrate their efforts in just one area of public affairs may one day find themselves in a position where they are expected to perform in another area and cannot. Therefore, you should make certain that all JOs have the opportunity to cross-train in the major functions of their career field. Cross-training will be discussed later in this chapter.

In a small office with only two or three JOs, it is usually impossible to departmentalize. A small public affairs staff should be trained to function as a team with each member able to replace another in his specialty when leave, illness or major events require it.

Manning standards for public affairs offices are based on a number of factors. Installation population, surrounding community population, news potential of the mission of the command, media directly served and the proportionate allocation of total manpower spaces are usually considered in determining the manning. A one-PAO and one-JO office might serve an isolated installation. At a major installation located near a metropolis, the public affairs office staff may include several officers and enlisted specialists (PHs/JOs), plus a few civilians, particularly if the installation is a hub of DoD activity.

COORDINATING

Coordination, one of the chief goals of all administrators, deals with unifying and synchronizing everybody's actions toward achieving a common objective. Although listed here separately, coordination is not a distinct and separate function. Coordination is actually a part of all five administrative processes.

The best time to bring about coordination is at the planning level. It is only common sense that in determining what is to be done, you should also consider how it will be done and who will do it (to attain maximum efficiency with a minimum of effort from all concerned). Coordination, or teamwork, is seen in all aspects of public affairs activity.

In arranging a SECNAV Guest Cruise, for example, coordination is necessary among CHINFO, the fleet commander in chief, the type commander, the unit to which the guest is to be assigned and the guest himself. A command public visit on the invitation of the CO is another example. To make it a success, coordination is required among the CO, XO, PAO, other departments in the command, possibly other commands, news media and the civilian community. Even a simple thing like sending a picture story to a newspaper involves close coordination. If the base photo lab cannot turn out the pictures on time and the PAO is not able to get the necessary transportation for a pressrun, you are fighting a losing battle.

An important part of good coordination is proper timing. Everyone involved in a public affairs project must not only do his share, but do it on time. If one man or one department drops the ball, the entire project may come to a standstill.

Planning a public affairs project, in many cases, is like setting up the machinery for an assembly line in a manufacturing plant. The speed of the assembly line must be geared to the capabilities of the machinery and workers and to the availability of parts. You do not want one group of workers standing around idle while another group down the line finishes one job after another without a break; and, of course, if you run out of parts—that is, supplies and equipment—the entire assembly line will close down.

In a public affairs office, a good administrator sees to it that the right person is suited to the right job, that the opportunity to hone skills in a myriad of professional areas exists, that machinery to do the work is kept in good operating condition and that sufficient supplies and equipment are on hand to keep the work moving smoothly and efficiently.

SUPERVISING

As a petty officer, supervising should not be new to you. Good supervision is nothing more than good leadership. It means that you will guide your staff intelligently and check the progress of their work regularly to see that it conforms as nearly as possible to your plans. Directions should be given simply, clearly and completely. They should also be given in such a way that the staff knows what is to be done and when to do it. Depending on the job or situation, you may also have to tell them how to do it, why it must be done in a professional manner and when the required action must be completed.

Techniques

Supervision can range from almost no direct supervision of the highly experienced, to close supervision for the young and inexperienced JO. Do not oversupervise. If your workers are capable, experienced and have demonstrated their ability, it would be foolish to supervise them too closely. They may resent it, and their work may suffer.

Workers who are young and inexperienced, however, need close supervision until they can develop the skills and abilities necessary to do their jobs properly. But here, it is not so much a question of supervision as it is of training. If your workers have never done a certain type of job before, it is up to you to train them.

Always remember that the thoroughness of a completed job depends on the petty officer in charge. If you are running an office, the responsibility for any finished product is yours regardless of who does the work.

If one of your staff members writes a poor story, for example, it is up to you to edit it or have it rewritten before it goes to the PAO for approval and release. There is no excuse for giving a sloppily written story to the PAO, then blaming your JOSN or JO3 for any errors or blunders that are brought to your attention. If you continue passing the buck in this reamer, you will not only lose the respect and confidence of the PAO but that of your staff as well. Be sure that in editing and rewriting you train your juniors, as well as, improve their written work. Unless you can improve their skills and the immediate product, you will end up doing all the work yourself.

Criticism and Praise

As a senior JO, you must devote much thought as to whether a job is botched or well done. Never be too quick to criticize. Sometimes an individual may have a good reason for doing what he did in the way he did it. Avoid making unfavorable remarks just for the sake of being critical; you do not want to symbolize trouble every time you appear. Unwarranted criticism may create a feeling of hostility and even be the cause for some of the mistakes you are criticizing.

Try constructive criticism. This means not just pointing out that a job was mishandled, but also explaining how it can be remedied. Doing this will show that you are trying to be helpful. When you criticize at all, make sure you are right!

As with criticism, there is an art in giving praise and encouragement. Public commendation is an excellent aid in developing a person's morale, but do not repeatedly pat someone on the back for doing his job. Never hesitate to thank or praise an individual in such a way that others know of the praiseworthy deed. If one of your subordinates makes a good suggestion or goes out of his or her way to do a better job, give credit where it is due. Even if the suggestion is not practical, let the individual know you appreciate the thought behind it. Be courteous to juniors as well as seniors. Bear in mind that to overdo praise is to lessen its value.

Passing the Word

Every good public affairs program is based on information and understanding. Your office relations should be based on the same principle. Keep your staff informed. Make sure they understand the importance of their work and the goodwill to be gained from it for the Navy and the command. If they have to work late or do something out of the ordinary, make sure they know the reason why. Yet, be careful not to overemphasize an obvious point. Some things just do not require explanations.

EVALUATING

Learning Objective: Recognize the public affairs office programs and products that are evaluated for completeness and efficiency.

Every office manager looks for ways to perform functions in a more efficient manner. To do this, you must take a step back and objectively evaluate every facet of the public affairs office operation.

As a manager, you evaluate the effectiveness of public affairs programs and products while you supervise. Documentation will help your cause and can range from simple informal note-taking to more formal methods such as the memorandum for the record and after action reports. This will help jog your memory and lead to changes at the appropriate time.

Another dependable method of evaluating is soliciting input from the men and women actually doing the work. This bolsters pride and professionalism, encourages 100-percent effort and gives them a firm sense of responsibility.

Programs

During the evaluating process, be sure to pay close attention to your public affairs programs. Check to see

if they are performing as advertised, are as complete as possible and conform to guidance provided in *PA Regs*.

Some of the programs and projects you should closely monitor include: community relations (Adopt-A-School, speakers bureau, etc.), internal information/communications (awards ceremonies, other special events), command tours, static displays and guest cruises. Do not forget to scrutinize your training program closely, because better trained journalists result in a more efficient and professional operation. Professional training will be discussed later in this chapter.

Products

No matter the size, every public affairs office generates several print and video products, including welcome aboard brochures, command presentations, CO, XO, and C/MC biographies and official photographs, fact sheets, briefings, familygrams, cruisebooks and so on.

Evaluating and editing existing office products can be done in several ways. For example, a welcome aboard brochure can be evaluated by an entire staff as part of professional training, morning quarters or as a fully dedicated planning session. You may choose to solicit input from your staff members on a one-on-one basis, or if not time critical, the product, including your instructions, can be routed to each staff member in a folder using an office route slip.

What do you look for when you evaluate your products? Although not all-inclusive, your checklist may look something like the following types of questions:

- Is all information current and accurate?
- Are there any typographical errors?
- Are pictures properly cropped? Were the negatives reversed during the printing process?
- Are there flaws in the layout?
- Is the paper stock acceptable?
- Is the font antiquated or garish?
- For familygrams: Is the text personal and conversational? Are all newly reported crew members welcomed? Are all award winners mentioned by name? Is training and safety information included?

- For cruisebooks: Are all specifications (cover, font, paper, color, special effects) adequate? How can page layouts be improved? Is color photography used wisely? Are there any staff functions that can be consolidated or otherwise improved?
- For video/slide presentations and briefings: Is the flow of the presentation adequate? Are the edits satisfactory? Are there any extra frames that require re-editing?

INTERNAL COMMUNICATIONS

Learning Objective: Identify the role of internal communications in public affairs and the products used to carry out its mission.

Providing information to the Navy internal audience is one of the most crucial areas of public affairs. Internal communications (information) unite the leadership of the command with its people, thus improving, among other things, personnel readiness, retention, morale and the overall quality of life. The Navy internal audience is broken down into five primary divisions as follows:

- Active-duty Navy personnel
- Family members of active-duty Navy personnel
- Naval Reserve personnel and families
- Navy civilian employees
- Navy retirees and families

As the manager of a public affairs office, you can effectively direct the communications with these divisions by using a host of products, several of which are produced by the Navy Internal Relations Activity (NIRA). Established in 1972 to satisfy the internal communications need of the Navy, NRA develops the following products with the guidance of CHINFO:

NAVY NEWS SERVICE

Navy public affairs professionals say the Navy News Service is NIRA's most timely and popular product. It is a weekly address indicating group (AIG) message containing official, authoritative news and information about naval operations, policy and accomplishments. The AIG incorporates more than 3,500 addresses, including all Navy and Marine Corps activities, all unified commands and all American embassies.

The Navy's equivalent of a news wire, the Navy News Service can be used "as is" in command newspapers or broadcast copy for local news productions.

ALL HANDS

All Hands is NIRA's premiere publication. Approximately 87,000 copies are distributed worldwide every month, with an intended 1:7 copy to reader ratio. Make sure that *All Hands* is widely distributed at your command and encourage personnel to pass it along to others when they have finished reading it.

NAVY EDITOR SERVICE

The Navy Editor Service (NES) is a monthly package of original articles, fillers, camera-ready graphics and photographs designed for reprinting in Navy newspapers. Approximately 850 copies are distributed to print media editors and public affairs offices throughout the Navy. Editors of Navy publications use articles in the NES as a starting point for a larger story with local emphasis. There is no charge for the service; however, you must request it.

CAPTAIN'S CALL KIT

This is a quarterly information package of materials designed to provide COs or officers in charge with up-to-date information to use during meetings with command personnel. They may also be posted on bulletin boards or printed in command newspapers or plans of the day.

NAVY FAMILY LIFELINE

Navy Family Lifeline is a newsletter of educational and informational articles and feature stories of special interest to spouses and families. More than 180,000 copies of the newsletter are distributed quarterly to commissaries, exchanges, ombudsmen, medical treatment facilities, Family Service Centers and the Wifeline Association.

PUBLIC AFFAIRS PLANNING GUIDE

The Public Affairs Planning Guide is a calendar designed to help public affairs staffs and editors keep track of special Navy events, important historical dates, religious and national holidays and advancement examination dates as well as a wide range of health and

fitness information. About 5,600 copies of the planning guide are distributed at the start of each calendar year.

PUBLIC AFFAIRS COMMUNICATOR

Originating in July of 1989, the *Public Affairs Communicator* is a bimonthly letter of professional information distributed to 1,700 subscribers, including active duty, reserve and civilian PAOs and senior JOs, both Navy and Marine Corps. It fills the gap left by *Direction* magazine, which was canceled in 1987.

OTHER INTERNAL COMMUNICATIONS PRODUCTS

Although not produced by NIRA, two prominent media exist to assist you in communicating to the internal audience: Navy News This Week and Navy Talking Points.

Navy News This Week (NNTW)

Teaming with *All Hands* to form the CNO's primary means of informing the internal audience is Navy News This Week (NNTW), a 30-minute weekly news and feature program produced and distributed by the Navy Broadcasting Service (NBS) at its headquarters in Washington, D.C. NNTW reaches sailors aboard deployed ships and those assigned with their families overseas at remote shore locations and it is broadcast on more than 130 cable and commercial television stations in 35 states. The show reaches a potential audience in excess of 6,000,000 viewers.

Navy Talking Points

Navy Talking Points are produced by CHINFO's Plans and Policy Branch (OI-5). They provide information for speakers and writers communicating to internal and external audiences and draw upon current Navy policy statements, congressional testimony and other key, authoritative sources.

TRAINING

Learning Objective: *Recognize the significance of training in terms of the senior JO's role and the factors that contribute to effective training.*

Sometimes the word training has a negative connotation because it can be perceived as "a waste of an hour or two that could be better spent working."

The fact is, nothing can be further from the truth.

It is Monday morning, and the pace begins to quicken in the office. The PAO is on leave, and you are on your way to brief the CO on several public affairs matters. With one foot out the door, JO3 Boate asks you several questions regarding the new press release format you instituted Friday. While answering her questions, JOSN Dory, who is tasked with writing a similar release, asks you a style question regarding military titles. Meanwhile, JO2 Arts requests assistance in retrieving the sample change of command release on the computer because his "access has been denied."

All three areas could have easily been addressed during an "all-hands" training session at a less hectic time. Subject: preparing press releases.

ROLE OF THE SENIOR JO

As a senior JO in charge of a public affairs office, you are responsible for making sure your subordinates are properly trained. You are responsible to the PAO for administering and monitoring a training program that keeps your staff sharp and on the cutting edge of the journalism profession. By providing your staff with the latest information and methods, your efforts will unquestionably boost efficiency and professionalism.

Although you are responsible for administering and monitoring the training program, you should not envision yourself as the sole "trainer." When you select your training topics (using the occupational standards in the Advancement Handbook for Petty Officers for the JOs as your guide), assign members of your staff to conduct the training on a rotating basis. Have the assigned instructor develop a lesson plan and show it to you at least two days before the training session, and check for thoroughness. (Be sure to include yourself in the rotation!)

APPROPRIATION OF TIME

Training is most effective when it is held on the same day and time each week. There are several factors you should consider before selecting the day and time for training, such as work schedules and deadlines, general military training schedules and other commitments. Of course, even if you determine that Wednesday at 1400 is the best day and time to assemble your troops for a one-hour training session, a priority project or an unplanned event can arise and throw your program off kilter. When appropriating time for professional training, keep the following points in mind:

- To give some thought to primary and secondary training days and times.
- To never cancel a training session because of work commitments; postpone them.
- To be flexible.

CHARACTERISTICS OF PROPER LOCATION

The public affairs office aboard the USS *Birdfarm* is located on the second deck, just below the after brow, where the boatswain's mates of first division are removing paint and rust with needle guns, grinders, sanders and handscrapers. The noise has reached a deafening level and your conversation with the first division officer confirms your worst fears: the work will continue through 1600. Your 1400 training session with the staff is five minutes away.

Obviously, your designated trainer and the trainees will have an extremely difficult time speaking and hearing in this environment because this situation is in no way conducive to learning. That is why the office supervisor must select the training site as carefully as the topics and methods of training. The supervisor, in this case, may or may not have known about the scheduled deck work just on the other side of the overhead. Regardless of the circumstances, an alternate location should have been identified and reserved, such as a conference room, administration office or even the mess decks.

Training ashore offers a wider variety of settings and locations. Using your existing office spaces for training is fine, but as a diversion, also consider training the staff at a different location on base or even off base. This will stimulate learning and maintain interest in your training program.

For instance, your training topic in two weeks is on preparing news releases for local radio stations. Instead of just reviewing the release format and procedures in the office, you can call the news director at one of the stations, briefly discuss your training intentions, and request a representative to discuss their newsroom operations with your staff at the station. In most cases, newsroom directors, general managers and other media authority figures will be delighted to honor your request.

A major distraction during any training session is the constant ringing of the telephones and visitors who wander into the office to conduct business. You can deal with this in the following ways: (1) turn on the answering machine for the duration of your training

session (be sure to return all telephone calls) or (2) assign one of your staff members to answer the telephones and greet visitors. The latter method is preferable, and if chosen, make sure someone from the staff takes comprehensive notes to pass along to this person.

METHODS

Contrary to popular belief, professional training sessions do not have to be mundane affairs accentuated with yawns and sighs. There are no set rules or guidelines for the ways in which you administer the program. Some recommendations include using NRTC questions, a thought/teaching point of the day, the *Public Affairs Communicator*, handouts, guest speakers and encouraging outside participation.

NRTC Questions

Copy a block of questions from the JO 3 & 2, JO 1 & C and *PA Regs* nonresident training courses (NRTCs) and direct your staff to complete them in a specified amount of time. Do not allow them to use the training manuals or *PA Regs* to research the questions. When time is called, review the questions with your staff, assign scores and chart individual progress on a bulletin board or a score sheet. In larger staffs, you can pair off staff members and compete in teams. Any variation of this theme will work. Regardless of the road you take, the benefits remain the same, as described below:

- Hundreds of questions exist from which to choose from.
- Very little preparation time is needed.
- Office competition keeps everybody sharp.
- The staff remains geared up for the Navywide exams.
- It is fun!

Thought/Teaching Point of the Day

Supplementing weekly training is the “thought” or “teaching point of the day.” This is best delivered during morning quarters or at some similar point in the workday when the staff is together.

It can go something like this: “. . . And the ship’s library will be secured today and tomorrow because of painting. That is all I have—here is your professional teaching point of the day: The Navy internal audience

is broken down into five primary divisions: Active-duty Navy personnel, family members of active-duty Navy personnel, Naval Reserve personnel and families, Navy civilian employees and Navy retirees and families. . . .”

Public Affairs Communicator

Each issue of the *Public Affairs Communicator* contains a multitude of professional development articles perfectly suited for training. Distribute copies of one or two articles to your staff per training session and hold a discussion on them.

Handouts

Use any handouts available from the Defense Information School (DINFOS) (check to make sure you have the most current copies), *PA Regs*, instructions, notices, and so forth, as training tools. The yellow guidance pages in *PA Regs* are excellent sources. Localize the materials and conduct training in an open discussion format.

Guest Speakers

If you cannot get out to that radio station for training, maybe a representative of the news department can visit your office to talk for an hour about its operations. Otherwise, you can contact journalists and PAOs from nearby commands and request they give a talk on a specific training topic. Guest speakers are out there—however, it is up to you to find them.

Outside Participation

Do not subscribe to the theory that your training program is limited to your staff. When you are lining up guest speakers for training, try to establish a system that allows staff members from other public affairs offices to attend your sessions, and vice versa. The more participation you have (in one or several directions), the better your training program will be. Your making a simple telephone call or having a conversation over lunch with a colleague is usually all that is required to make the necessary arrangements.

CROSS-TRAINING

In this day and age of doing more with less, you have to be sure the members of your staff are interchangeable. That is where cross-training comes in.

If cross-training is not in place at your public affairs office, consider the predicament you can get into when a “main cog” is suddenly removed from the scene as in the following case:

A year ago, you put JO2 Vetch in charge of running educator orientation visits (EOV) in the community relations section of the office. Vetch is a superb sailor: reliable, professional and dedicated. She runs the program to perfection. In fact, you just recently drafted a letter of commendation for her.

The CDO calls late Sunday night to inform you that Vetch’s father died in Honolulu, and she is en route to attend the funeral. An EOV is scheduled for tomorrow at 0900, but, because of your own commitments, you cannot possibly fill in for her. You have got JO2 Rummy and JO3 Stone available, but they have never run an EOV. The PAO is TAD to the U.S. Naval Academy for a three-day public affairs symposium. What will you do?

Now let us install a staff that has been adequately cross trained as in the following scenario:

You get the same call from the CDO, and, after briefly pondering the situation, you remember that JO2 Rummy rotated out of the community relations section three months ago. As part of his tour there, he organized and ran two EOVs. Rummy is contacted and assigned accordingly.

Uprooting Rummy means someone will have to take over his external release writing duties. You are covered here too, because JO3 Stone, a broadcaster by trade, can do the job because she wrote external releases for four months and has it down to a science.

Get the picture? Cross-training is vital to the overall operation of a public affairs office and **must** be continuously emphasized in the overall training program.

Why such an emphasis on cross-training? Because **versatility** is the byword of the JO rating. Every JO follows a unique career pattern that mayor may not lend itself to being versatile. In some cases, you may come across a JO with a “closed loop” career path, for example, a JO3 with a 3221 NEC who only has broadcast assignments under his belt. If this individual is assigned to your public affairs office, you cannot possibly give him enough broadcast-related assignments to keep him busy. The answer is you must

get him up to speed on the operations of your office by cross-training.

Cross-training applies to you, the office manager, as well. You must be professionally qualified in every facet of office operations. It is a rare situation where the senior JO in an office does not occasionally have to write a news release, give a tour of the base or even pinch hit as a photographer. You are responsible for maintaining your basic skills and continuing to develop those in which you have limited experience.

Benefits

The benefits of a rigorous cross-training program are numerous. The individual develops a broader base of experience that can be used not only during his present duty station, but well into the future. Meanwhile, the senior journalist will enjoy the benefits gained from a public affairs office operation that can “heal” itself when main players are removed. If your resident expert on EOVs is 4,500 miles away on emergency leave, you are not left with an insurmountable problem. By shifting assignments to cross-trained individuals, you are assured that the job will get done without a compromise in quality.

Implementation

Determining the amount of cross-training each member of your staff receives is entirely up to you. However, keep in mind that you do not want the cross-training to be too brief or excessive. If your office is set up as shown in figure 1-2, consider shifting personnel among the three main public affairs office divisions every six to 12 months. A shorter period of time may not sufficiently serve your training needs or your ultimate cross-training goals, and a longer time frame may lead to stagnation and specialization.

DOCUMENTATION

Maintain professional training folders on all your staff members, to include the date and topic of the training session, and any other pertinent information. When the individual transfers, give him the folder to take to his next command.

CREDIBILITY

Learning Objective: *Recognize the principles of credibility as they apply to public affairs office management.*

Credibility, the intangible and vital requirement in any successful public affairs office, is easily defined. Simply put, credibility means believability, and without it, the ability to succeed as a manager in any public affairs endeavor is severely diminished.

So, how do you, the public affairs office manager, establish credibility? And once established, how do you maintain it in the face of mistakes or missed opportunities?

Nothing can help if you botched a project, but the following basic guidelines may prove helpful in preventing such incidents.

First, know your job, and make sure your staff knows theirs as well. Nothing can substitute for a foundation based on sound knowledge of public affairs practices and regulations coupled with a good dose of common sense. When the investigative journalist arrives at the accident site or when the congressman arrives at the main gate with a video crew, there is no time to research the problem. You have to know what to do quickly and correctly.

Second, know your command and know it well. You are not expected to be an expert on everything, but you are expected to know where to find an expert answer. Low and mid-level employees are a good source of basic information, but rely on senior management for definitive answers that should include policy considerations as well.

Using these two guidelines as a foundation, assemble additional building blocks for credibility by trying the following suggestions:

- Anticipate problems. Each week spend at least 15 minutes of uninterrupted quality time looking over the calendar for the coming three months and note activities or areas of potential public affairs involvement. Gather information and be prepared.
- Keep the boss informed. Periodic notes to the PAO (or CO, as discussed later) let him know you are working on an anticipated project or gathering information on a potential problem area. Demonstrating this initiative goes far in establishing your credibility.
- Review all material forwarded to your boss for accuracy and completeness. If you have not personally read it, do not let it leave your office.

- **Keep the chain of command informed.** Back-brief command offices and give a “heads up” to senior or subordinate commands.
- **Know the boss’s priorities and make them yours.** Redefine what you are doing to match his schedule. If the PAO is sweating out a speech he is writing for the skipper, you can bet he will not be sympathetic to your monthly publication woes.
- **Get along with others.** If you have to crawl on your belly through the mud to get the job done, do it. Then vent your frustrations in private.
- **Do not complain.** Be sure to let the boss know if you cannot meet deadlines. If the reasons are valid, the boss will usually understand. But if you have blown it, be prepared to pay the consequences.

While the media can be difficult to work with, establishing credibility with media representatives is easy. Again, a good knowledge of the craft, the command and the willingness to go the extra mile will earn you a rich return on your investment. Credibility with regard to the media is discussed in Chapter 4.

CORRESPONDENCE

Learning Objective: *Identify the elements of public affairs office correspondence.*

A senior journalist must be proficient in composing good correspondence in addition to his journalistic talents. This section covers the essentials of good correspondence composition. For more detailed instruction on the preparation of correspondence, refer to the *Department of the Navy Correspondence Manual*, SECNAVINST 5216.5 series.

The term correspondence refers to a variety of compositions which you may be called upon to prepare, such as: (1) Navy format and public affairs letters, (2) public affairs directives (standard public affairs plans, PA annexes to operation orders, Command Information Bureau (CIB) plans, adverse incident plans, etc.), (3) messages (unit SITREP, news release in message form), (4) public affairs guidance (PAG), (5) memorandum for the record and (6) point papers.

WRITING THE OFFICIAL NAVY LETTER

The basics of preparing Navy letters can be applied to all forms of official naval correspondence, including directives. A letter is more effective when you plan it

before you begin to write. A plan of some kind is necessary to make sure you have included everything you intended to include and have arranged things in a clear and orderly way. Whether you outline the letter completely, make brief notes or carry your plan in your mind will depend upon the length of the letter and your own methods of working.

Purpose

Planning cannot begin without a clear purpose. Your first step is to be sure you understand exactly what the letter is intended to do. Preparing a statement on the subject of the letter will help you clarify the purpose and furnish guidelines for what is needed and what should be omitted.

It is possible for a letter to deal with more than one subject, but usually this is not advised unless the subjects are closely related. A reply on one subject may be prepared in hours, whereas days or weeks may elapse before an appropriate answer can be made on another subject. If both questions are asked in the same letter, confusion is likely to result. Furthermore, one department of the recipient command may prepare the reply on one subject and a different department on another. So, even though you have to write several letters to the same command on the same day, it is better for you to do so than to combine unrelated matters.

The following are some common purposes of letters:

- To request permission or authorization to act
- To request that action be taken
- To supply information or instructions
- To reply to a request for permission or authorization to act
- To reply to a request that action be taken
- To reply to a request for information

While not every letter you draft will fall into one of the previous categories, the categories do serve as examples of how to analyze and plan a letter. For instance, when the purpose is to request something, you must be certain the request is definitely and clearly stated. Usually, there should also be a statement as to why the request is being made and any additional explanation or suggestions that are required or appropriate.

When a Navy form letter is written in reply, the receipt is sometimes acknowledged, not only by citing the letter as a reference but in the body of the reply. If a request has been made, the most important thing in the reply is a clear statement as to whether the request is granted or denied. Further explanation, limitations or suggestions should be included as appropriate. Long letters may need a summarizing statement as the final paragraph.

Organization

The order the various parts of the letter are arranged in should be planned with the reader in mind. A letter of request, for instance, may begin with the request itself, followed by an explanation of why the request is made. However, sometimes it may be clearer to the reader if the letter begins with a discussion of the situation and leads up to the request. A letter of reply frequently begins by acknowledging the letter received. It is important for you to do the following: (1) see the body of the letter as a succession of units, (2) arrange these units in what seems the most satisfactory order, (3) complete each unit before moving on to the next and (4) maintain continuity by providing a transition from one unit to another.

In letters of average length, each important unit may be one paragraph, although there is no rule about this. For example, an explanation of reasons why something should be done may take more than one paragraph. Some letters, on the other hand, maybe so simple that one paragraph is enough for the entire body. Just as each letter has a subject, each paragraph covers a topic or subtopic. Each paragraph has its own order structure so that one idea naturally leads to another and one paragraph leads to another.

Word Selection

Choosing the right words is a long step toward good style. The best words are those that are precise in meaning, suited to the intended reader, and as short, simple and direct as possible.

Words can miss the mark of exactness in several ways. One of the most obvious is choosing the wrong word from two that sound or look alike. How often have you read, "He was appraised of the situation. . ."? It probably would have been better in the first place simply to have said, "He was told of the situation..." but in any event, the writer should have known that to tell is to apprise, and to appraise means to evaluate.

Do you always make the correct choice between the following words: affect, effect; eminent, imminent; counsel, council, consul; adapt, adopt; principal, principle; capitol, capital? You may think of some of these as spelling problems, but they also involve knowledge of meanings. If you have trouble with any of them, you should consult the dictionary. As you become better acquainted with meanings, you will find ways of remembering them, like the following for principal and principle:

- Principal means **main** or the **main one**

- The principal of the school

- Payment of principal and interest

- Principal and alternate appointments to the U.S. Naval Academy

- The principals in the play have the main roles

- His principal objections to the plan are . . .

- Principle means **rule** or theory

- He lives according to his principles

- The principles of democracy

- He understands it in principle

In other words, whenever you can substitute “main,” you spell it “principAL.” If you can substitute “ruLE,” you spell it “principLE.” This kind of device for remembering is sometimes of help, but beware of establishing a system too hastily, because it may steer you wrong.

Among words that are related or similar in meaning, the discriminating writer usually finds that one suits his purpose better than another. Take the words **obtain**, **procure** and **secure**, for example. **Obtain** is the more general term. **Procure** has, in the Navy, a specific connotation of obtaining material through official channels and by approved supply procedures, usually for someone else, as “The supply officer procured the boiler parts,” **Secure** is often wrongly used instead of **obtain** or **procure**. Its specialized Navy use, meaning to fasten something down or make it firm, is the connect clue to its general meaning. When you say “He secured it,” meaning he obtained it, you are implying that he got it against competition and then held on to it firmly or pinned it down in some fashion. If that is not what you mean, you should use **obtained**.

Although you might say that a sailor’s **billet** is his **job**, you cannot correctly use the word **billet** in every instance where you would use **job**. While **fewer** and **less**

seem much alike in meaning, **fewer** describes number, and **less** describes quantity: “fewer UA cases”; “a ship drawing less water.”

In choosing words, always keep the person in mind for whom the letter is intended. For example, when you prepare a letter to a command senior to yours, “Your attention is invited” is used rather than “Attention is directed; and “can be maintained” is used instead of “shall be maintained.”

A directive addressed to all hands is written in language all can understand. This does not necessarily mean that only one-syllable words are used, but it does mean that the words chosen must be meaningful to all hands. How would **you** like to read a notice that began like this:

“Having cognizance of our rigid operating schedule, the commanding officer, in an attempt to ameliorate morale, is endeavoring to ascertain the proclivities of those personnel who are encountering difficulty. . .”

Paragraph Organization

A well-written paragraph has unity, meaning the ideas it contains are closely related and are arranged to develop a single topic or subtopic of the general subject. In modern official letter writing, the tendency is toward short paragraphs for the sake of readability. This requires not only that all unnecessary verbiage be pared away, but also that the subject matter be very carefully organized and subdivided.

THE TOPIC SENTENCE.— A fairly long paragraph is frequently made more effective if introduced by a topic sentence. Such a sentence makes a general statement that is developed in greater detail in the remainder of the paragraph. Below is an example adapted from a Navy publication.

Our commanders on foreign soil have more experience in the arena of international law and international relations than any governmental group, with the exception of State Department personnel. The commander in Korea is operating under an international organization, the United Nations, carrying out or enforcing an armistice or truce. If he is unfamiliar with its provisions, its implications, and its legal significance in the international community, he will be hard pressed to fulfill the responsibilities placed upon his shoulders. The commander at Guantanamo Bay, Cuba, must know the terms of the two treaties and the lease

agreement between the United States and Cuba which govern our rights to the Naval Base at Guantanamo in order not to give Castro any basis for canceling these agreements. The CO of any naval activity stationed in a foreign country must be familiar with the agreements under which he is operating; for example, base rights and Status of Forces Agreements. These are all matters of international law and international relations. It is imperative that the commander understand his position in the international scheme.

A topic sentence need not stand at the beginning of a paragraph. In fact, it is possible to have a well-written paragraph with a topic sentence in the middle or at the end. In naval correspondence, the topic sentence in the middle of the paragraph is less likely to be used. If placed at the end, it becomes a summary—a useful device for pulling the paragraph together and leaving a strong final effect. However, the summary at the end of a paragraph is not used extensively in naval letters and directives. A summary paragraph for an entire letter is sometimes appropriate.

ORDER OF SENTENCES.— A well-organized paragraph has its various ideas introduced in an orderly sequence. This sequence may be place order, chronological order, logical order or order of emphasis. The purpose of all is the same—to lead the reader along the path you want him to take with a minimum of backtracking or skipping about, and thereby leaving a clearer, stronger impression in his mind.

● Place order is used for descriptions. The following description is adapted from the report of a shipboard accident:

During preparations for the transfer of fuel, seven sections of 2 1/2-inch hose were connected and rigged between a Navy cargo ship and a fuel oil barge. The hose passed through a hold of the ship in which there were several light fixtures of the type designed for use with globes and guards. The globe and guard were missing from one light fixture, leaving the light bulb unprotected. One man was stationed in the hold and another man stood outside at a hatch that opened into it.

Notice that the writer begins with the rigging of the hose between the two ships. Then he takes us inside the hold of the cargo ship and pictures the situation there. Finally, he gives us the positions of the two men involved in the accident.

● The next two paragraphs of the report illustrate **chronological order**, the order used for narrating events and for explaining steps in a process:

Upon signal to commence the transfer of fuel, a pump was started on the barge, and pressure was applied within the hose. A section of hose in the cargo hold ruptured; the hose whipped with great force, struck and broke the unprotected light bulb.

Arcing from the filament of the broken bulb ignited combustible vapor and caused a flash fire which, although extinguished within a short time, severely burned both men. The man who was stationed inside the hatch died approximately three weeks later.

Incidentally, note the amount of concrete detail in both the description and the narrative. This is a condensed report. The original probably had much more detail, such as the names and numbers of the ships, the number of the hold and the names and rates of the men.

Below is another example of chronological order adapted from a Navy directive. In this case, we have the order in which steps are to be performed in a procedure:

A selection board convened by the Chief of Naval Personnel considers the applications of fully qualified NESEP candidates in January and February. Those candidates determined by the board to be best qualified are designated provisionally selected candidates. The names of candidates thus provisionally selected are published by a BUPERS notice in March. Provisionally selected candidates for NESEP will be further screened after selection, and prior to being ordered to the summer preparatory session, by participation in a form of the Scholastic Aptitude Test (SAT) of the College Entrance Examination Boards. This test will be forwarded to each candidate's command for administration, and will determine the candidate's admissibility to a NESEP college or university. Those who fail to qualify on the SAT will have their status as provisionally selected candidates terminated.

When there are many steps, it is often desirable, in naval correspondence, to present these in tabulated form rather than in a solid paragraph. Usually, then, they are designated by letters or numbers as appropriate.

● Because of the modern emphasis on short paragraphs, sometimes it is necessary for you to quote several paragraphs to see how a unit of subject matter is organized. This is the case in the example below, in

which ideas are arranged in **logical order**, leading to a conclusion in the final paragraph.

Let us look at the size of the Navy business-management job. You have all, no doubt, thumbed through a mail order catalog and have been impressed with the number of items available. You can buy tools, clothes, toys, drugs, stationery and all sorts of household appliances and general supplies. Actually the largest catalog carries around 100,000 different articles.

Let us compare this 100,000 with the range of items required by the Navy. In our catalogs we carry some 1,200,000 items—more than 10 times as many as you find in the largest commercial catalog. The Navy supply system carries everything from missile parts to brooms, electronic parts to potatoes and uniforms to medicines.

We issue more than 20,000,000 items each year. To meet these demands, the Navy alone carries an inventory of around \$5.5 billion.

In other words, within the total defense supply operations, the Navy portion alone is big business. Measured in terms of dollars, it is twice as large as the entire General Motors industrial complex.

This example demonstrates several things. It shows how facts can be advanced to support a conclusion. In this case, the conclusion that the Navy supply system is big business is supported by evidence of (1) the range of items carried, (2) the volume of supplies issued and (3) the size of the inventory. This is also a good example of the use of comparison (Navy supply compared to a commercial mail-order catalog) to help the reader visualize the facts offered. Emphasis is heightened in paragraph three by contrast presented in parallel structures. The final paragraph illustrates the summing up and a statement of the conclusion drawn from the evidence.

- Time-honored rules of rhetoric have established that for emphasis an item should stand first or last. This has been regarded as true whether one is speaking of the sentence, the paragraph or the piece of writing as a whole. When we think of **order of emphasis** we have this principle in mind. Whether the items placed first and last are remembered longest is open to question, but certainly, the placing of anything, either at the beginning or at the end, gives it emphasis at the moment. Which of the two positions will give the greater emphasis depends upon the individual situation.

In news writing, as you well know, the lead paragraph is the most important because people want the news quickly and often do not read through to the end of the story. Orators need a strong beginning and a strong ending. The important thing is that the writer remembers that position is a device for gaining emphasis and he should consciously use it.

WRITING THE PUBLIC AFFAIRS LETTER

The composition of a public affairs letter is an area where you have no gauge or formula to guide you. Every letter differs with the situation. However, there are some important pointers to remember.

Try to visualize the public affairs letter as a news story, and get right to the point. Tell the reader what he wants to know simply and clearly. As in a news story, the information most important to the reader should go into your lead.

Actually, the biggest battle is for you to get away from some of the poor letter-writing habits picked up in the belief that they are sound “business-like” habits. The following are some examples:

- Lengthy and unnecessary acknowledgements

The person whose letter you are answering knows what he wrote. And he knows when he wrote it. Too often we waste time with long introductions like this:

“This will acknowledge receipt of your letter of 1 May 1993 in which you requested the services of a band, color guard and marching unit to appear in your Fourth of July parade in Hialeah, Florida, and offering to reimburse the Navy for the cost of transportation and billeting.”

What does the reader know so far? Nothing. He wants to know, “Am I getting the band?” The previous acknowledgement might be rewritten like this:

“Thank you for your letter of May 1. Your interest in having Navy participation in your July 4 parade is certainly appreciated by this *command*. At present, we foresee no problems in fulfilling your request.

“Further details will be. . .”

- Needless words and information

Edit your letters just as you would a news release. Cut out unnecessary words and phrases. Stay away from words and phrases that hedge because they have the appearance of your being uncertain or unwilling to commit yourself. Some members of this group:

“Seemingly,” “it appears,” “seem to indicate,” “in general,” “as a usual case,” “it is considered.” Not only are they bad, they clutter up your letters. What is worse, they often raise needless doubts in the reader’s mind.

- Long, complex words and sentences

The purpose of letters, like news stories, is to inform, not to impress or educate. Use short, simple sentences. Write the way you talk. Say “pay,” not “remunerate,” and “use,” not “utilize.”

- Impersonal approach

Why write “it is understood” when you mean “I understand”? You do not talk that way. Why write that way? Strive for the conversational touch. If you are in the habit of using contractions such as “we’ll” and “you’re,” use them, but sparingly. Use personal pronouns, especially “you”; it interests your reader more than any other. Try to slant your letter to tell the reader what advantage he gains, not what you want.

The “Letters to the Editor” section of *All Hands* offers some good examples of the type of letters you may have to prepare. Take this one for example:

“Sir: During World War II, more specifically from 1942 to 1945, I served on board the survey ship USS *Bowditch* (AG 30). I’m curious as to whatever became of it. Would you trace down her history and enlighten me? Thanks.—W.R. Watkins, Greensboro, North Carolina”

All Hands’ reply:

“Our thanks to you for your suggestion.

“Typical of the Navy survey ship, *Bowditch* had a well-traveled career which began in Denmark in 1922 as the passenger ship *Santa Inez*.

“Purchased by the U.S. Navy 11 years later, it was renamed after Nathaniel Bowditch, the noted 19th century astronomer and navigator, and placed into commission on 1 July 1940.

“In the months preceding World War II, *Bowditch* made geodetic surveys in Little Placentia Bay, Newfoundland, Bermuda, the Bahamas, Jamaica, Cuba and Haiti. In January 1942, it steamed from its home port, Norfolk, to make surveys of waters between Panama and Colombia, near the Galapagos Islands, and off Cocos Islands, Costa Rica.

“A year later, after a brief repair period, Bowditch returned south to further survey areas in

the Caribbean, along Panama, Colombia and the Ecuador coast.

“It was assigned to the Pacific Fleet Service Force on 6 January 1944 in its initial warship capacity and served as a survey ship during the invasion of Kwajalein and Majuro Atolls from 4 February to 2 April 1944. Then it assisted in the occupation of Saipan from 22 July to 4 October that same year before participating in the capture of Okinawa from 18 April to 2 September 1945. During this siege it rescued survivors of battle-damaged USS *Montgomery* (DM 17) and patrol craft PC 1603.

“*Bowditch* remained in Okinawan waters until early November 1945 when it returned to the United States and San Francisco, decked out with three battle stars earned for its World War II service. But, within three months, it was again steaming toward the mid-Pacific to begin preliminary surveys around the Bikini Atoll in preparation for Operation CROSSROADS, the post-war atomic bomb tests.

“After the tests, it continued surveying Bikini until October when it returned to the Golden Gate city. *Bowditch* left California for Norfolk the next month and was decommissioned there on 22 January 1947, and disposed of on 9 June 1948.—Ed.”

WRITING FOR THE CO’S SIGNATURE

Certain projects and situations will require you to draft correspondence for the CO’s signature.

This is where your letter-writing skills are really put to the test. Before you start, you should research the CO’s personal views on the subject in question and his association with the addressee. In some cases, a conversation with the CO’s secretary or the XO may be necessary to get a feel for the CO’s perspective on a particular topic.

While researching, obtain answers to the following questions:

- What outlying issues could be directly or indirectly affected by your words?
- What is the appropriate tone and style?
- What is the desired purpose?

A good rule of thumb to know when you write a letter for the CO is as follows: **KISS OFF** (Keep It Simple and Short Or Face Frustration). If the addressee only needs a carburetor, do not send him instructions on

how to build a car. The letter should be no more than one page in length, with the first paragraph identifying the issue and the action recommended. Subsequent paragraphs should identify and discuss significant background information and main points supporting the recommendation. If details are absolutely necessary, include attachments.

Other points to consider are the following:

- Go easy on the modifiers. A CO does not need to say he is very interested in something. Being interested is sufficient.
- Avoid emotionalism.
- Be sure you are right. Check and double-check your logic, grammar, facts and figures and format.
- Do not expect your finished draft to fly the first time. Even the best letter writers are not psychic.

PREPARING DIRECTIVES

The format of a public affairs directive is basically the same as all official Navy directives (instructions, notices, operation orders, etc.).

Figures 1-3 through 1-6 present the standard format for directives issued in the Navy Directives System.

Public Affairs Plan

The first type of public affairs directive you should become familiar with is the SOP, or administrative instruction, which is used to make certain instructions routine, thus reducing the number, length and complexity of later directives.

Each command develops appropriate and effective SOPs based on applicable portions of published procedures of higher authority, the desires of the officer in command and the habitual procedures developed through experience.

SOPs should be sufficiently complete and detailed to advise new personnel and new units of routine practices. The necessary amount of detail depends upon the state of training, the complexity of the instructions, the size of the command and other variables.

Staff sections, divisions or departments often find it expedient to establish their own SOPs for the operation of their own departments and for the guidance of their own personnel in routine matters. Some examples normally found in public affairs offices are those

governing the release of information on accidents, handling of visitors, operation of a speakers bureau, mobilization during an emergency and coverage of parades and ceremonies.

Public affairs plans vary among different commands and may differ according to their purposes. The format illustrated in Appendix I is not an iron-bound formula. The paragraph headings, content and sequence can be changed, some paragraphs omitted or included in annexes or additional paragraphs added. Plans are written to accomplish an objective. They should not be regarded as a form to be filled out, whether applicable or not. On the other hand, most planning formats have been standardized through use by many people for many years. By following these formats intelligently, thoughts will be organized logically and the document becomes easier for the experienced reader to understand readily. The body of any plan is divided into several major sections or paragraphs which might include the following:

- Purpose
- Background
- Objectives
- Methodology
- Task organization
- Policy
- Responsibilities and tasks
- Execution

The order of presenting the various paragraphs may vary from plan to plan.

Public Affairs Annex

A plan for a fleet, force or squadron operation or exercise is issued in the form of an overall operation order (OPORD). The document pertains to the entire organization and operation of its forces. Attached to the "basic plan" or OPORD are additional sections called annexes.

An annex only deals with one aspect of an operation, for example, intelligence, communications, public affairs, and soon. The purpose of annexes is to keep the body of the plan short, clear and simple.

A public affairs annex is prepared for all training and contingency plans and appropriate operational

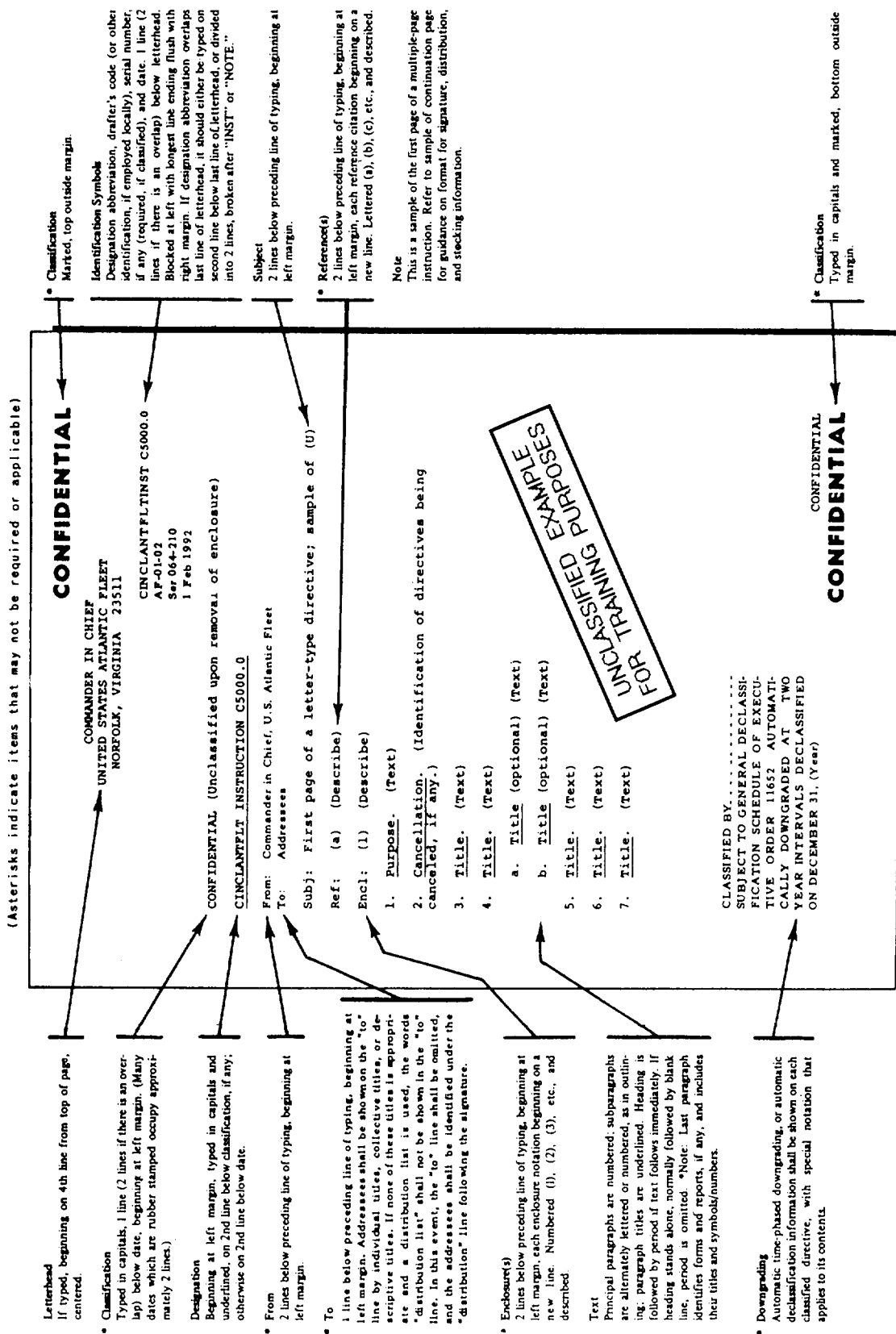

* Classification
Marked, top outside margin.

Identification Symbols
Designation abbreviation, drafter's code (or other identification, if employed locally), serial number, if any (required, if classified), and date. 1 line (2 lines if there is an overlap) below letterhead.
Blocked at left with longest line ending flush with right margin. If designation abbreviation overlaps last line of letterhead, it should either be typed on second line below last line of letterhead, or divided into 2 lines, broken after "INST" or "NOTE."

Subject
2 lines below preceding line of typing, beginning at left margin.

* Reference(s)
2 lines below preceding line of typing, beginning at left margin, each reference citation beginning on a new line. Lettered (a), (b), (c), etc., and described.

Note
This is a sample of the first page of a multiple-page instruction. Refer to sample of continuation page for guidance on format for signature, distribution, and steering information.

* Classification
Typed in capitals and marked, bottom outside margin.

Figure 1-3.-Standard Navy instruction format.

(Asterisks indicate items that may not be required or applicable)

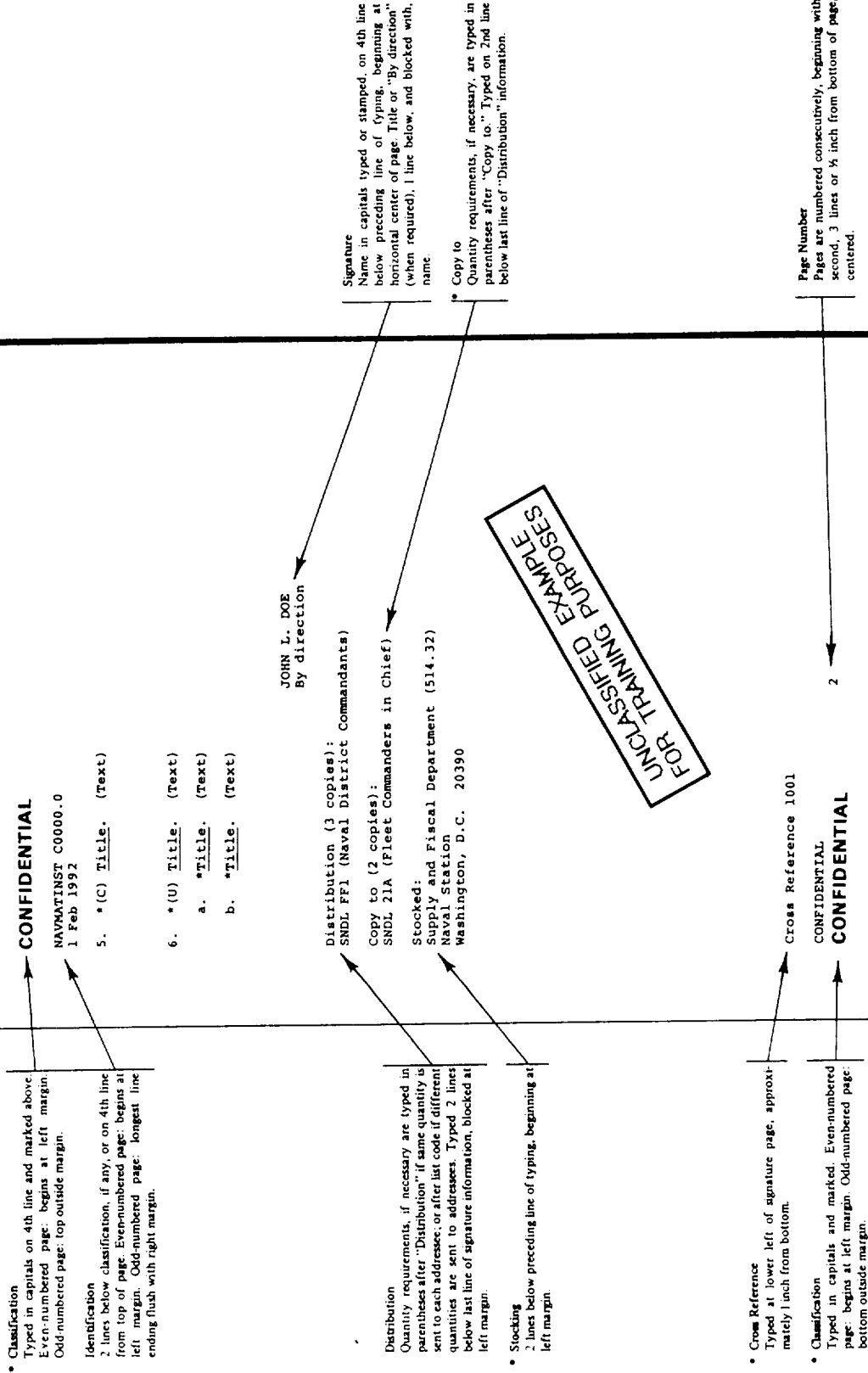

• **Classification**

Typed in capitals on 4th line and marked above.
Even-numbered page: begins at left margin.
Odd-numbered page: top outside margin.

• **Identification**

2 lines below classification, if any, or on 4th line from top of page. Even-numbered page: begins at left margin. Odd-numbered page: longest line ending flush with right margin.

• **Distribution**

Quantity requirements, if necessary, are typed in parentheses after "Distribution"; if same quantity is sent to each addressee, or after list code if different quantities are sent to addressees. Typed 2 lines below last line of signature information, blocked at left margin.

• **Stocking**

2 lines below preceding line of typing, beginning at left margin.

• **Cross Reference**

Typed at lower left of signature page, approximately 1 inch from bottom.

• **Classification**

Typed in capitals and marked. Even-numbered page: begins at left margin. Odd-numbered page: bottom outside margin.

Cross Reference 1001

CONFIDENTIAL

CONFIDENTIAL

2

Page Number

Pages are numbered consecutively, beginning with second, 3 lines or 1/2 inch from bottom of page, centered.

Figure 1-4.-Standard Navy instruction format (continuation page).

(Asterisks indicate items that may not be required or applicable)



DEPARTMENT OF THE NAVY Canc fip*: Feb 93
OFFICE OF THE CHIEF OF NAVAL OPERATIONS
WASHINGTON, D.C. 20396

IN REPLY REFER TO
OPNAVNOTE 0000
Op-09B
1 Dec 1992

OPNAV NOTICE 0000

From: Chief of Naval Operations
To: Commandants of Naval Districts

Subj: (Describe)

1. Purpose. (Text)
2. Title. (Text)
3. Title. (Text)
 - a. Title. (optional) (Text)
 - b. Title. (optional) (Text)

4. Cancellation. When action has been completed.

J. L. DOE
By direction

Distribution (3 copies):
SNDL FFI (Naval District Commandants)

Stocked:
OPNAV (09B24)

Designation

Typed in capitals and underlined, 5 lines below last line of address in letterhead, if unclassified (7 lines if classified), beginning at left margin.

Text

Next-to-last paragraph identifies forms and reports, if any, and includes their titles and symbols/numbers. If cancellation has contingent provision, this is stated in last paragraph. Date is always last day of month, except when such date would create an administrative problem.

Stocking

Not mandatory on notices, since stocks are held by ongoing offices.

Note
This sample emphasizes items peculiar to a notice.
Refer to sample instruction and continuation page
for guidance on common items.

Figure 1-5.-Standard Navy notice format.



DEPARTMENT OF THE NAVY
OFFICE OF THE SECRETARY
WASHINGTON, D. C. 20380

SECNAVINST 5215.1C CH-1
Op-09B
1 Mar 1992

SECNAV INSTRUCTION 5215.1C CHANGE TRANSMITTAL 1

From: Secretary of the Navy
To: All Ships and Stations

Subj: Department of the Navy Directives Issuance System

Encl: (1) Revised page 10

1. Purpose. To transmit new page 10, which revises procedures for preparing a change of transmittal.
2. Action. Remove page 10 of the basic instruction and insert enclosure (1).
3. Cancellation. When the required action has been taken and the change entered in the record of changes.

J. LEE DOE
Under Secretary of the Navy

Distribution:
SNDL, Parts 1 and 2
MARCORPS Lists H and I

Stocked:
Supply and Fiscal Dept. (514.32)
Naval Station
Washington, D.C. 20390

Note
This sample emphasizes items peculiar to a change transmittal. Refer to sample instruction for guidance on common items.

Designation
Complete identification of change transmittal, typed in capitals and underlined, beginning at left margin

Subject
Subject of directive being changed is always given.

Text
Last paragraph carries self-canceling provision, but does not include specific cancellation date.

Figure 1-6.—Standard Navy change transmittal format.

orders. The annex includes, but is not limited to, the following:

- Delegation of responsibility for the release of information and the general conduct of public affairs
- Scope of pictorial and written coverage desired
- General and specific instructions on policy governing information activities
- Specific instructions on such matters as briefing news media representatives, news release format, still and video documentation and news photography, radio and television arrangements, information kits, staffing of CIBs and joint information efforts and critiques or resumes of the operation

Appendix II of this manual contains an example of a public affairs annex to the OPORD.

CIB Plan

This type of public affairs plan is usually promulgated as a notice, establishing and putting into operation of a CIB to coordinate and cover information activity of special events and other news situations. Appendices III and VI of this manual show examples of CIB plans.

Adverse Incident Plan

An adverse incident plan is usually included as an appendix to each public affairs plan. The purpose of an adverse incident plan is to specify the procedure and format for the release of information concerning casualties, injuries and accidents or disasters. Appendix IV of this manual gives an example of an adverse incident plan.

MESSAGES

As a public affairs office manager, you must be familiar with the procedures for preparing naval messages.

When regular correspondence cannot be drafted due to time constraints, a message will get time-sensitive or critical information to the addressee rapidly for maximum effective use.

Messages are prepared on the Joint Message Form (DD 173/2) (fig. 1-7) to be sent by electrical telecommunications. Since the DD 173/2 is read by optical

seamer, it must be prepared in double-spaced format using an OCR typeface. Complete procedures for naval message format are contained in the Telecommunications Users Manual, Naval Telecommunications Procedures (NTP) 3. In some commands, the Joint Message Form is no longer used. It has been replaced by word processing direct transmission or giving a floppy disk to the message center. Find out what procedures are accepted at your command.

Parts of a Message

The information detailed below will show you how to prepare a simple message for transmission. Use figure 1-7 to identify the position of each block.

PAGE BLOCK.— The first digit is the number of the current page. The second digit is the total number of pages of a multipage message.

DTG/RELEASER TIME BLOCK.— The date-time group (DTG) consists of three elements: the date-time expressed in digits, the month, and the year. The first two digits of the date-time are the date of the month, the second two digits are the hour and the third pair of digits are the minute. The hour and minute reflect a standard time zone, ZULU (Z) time. This allows Navywide standardization of time designations. The month notation is the three-character month abbreviation. The year is expressed with the last two digits of the year. So, a complete DTG would read 2018202 MAY 93. The DTG will be assigned to the message according to local procedures.

PRECEDENCE BLOCK.— The precedence assigned to a message is determined by the subject matter of the text and the desired writer to reader delivery time.

The four precedence categories and the speed of service objectives for each category are as follows:

Routine.— Precedence prosign R is assigned to all types of message traffic that justify electrical transmission but are not of an urgent enough nature to require a higher precedence. Examples are messages concerning normal peacetime operations, programs and projects; stabilized tactical operations; operational plans concerning projected operations; periodic or consolidated intelligence reports; ship movements; supply and requisition and administrative, logistics, and personnel matters. The speed of service objective is within six hours. Most public affairs messages will fall into this category.

JOINT MESSAGEFORM							SECURITY CLASSIFICATION			
PAGE OF	DTG RELEASER TIME			PRECEDENCE		CLASS	SPECAT	LMI	CIC	ORIG MSG IDENT
	DATE TIME	MONTH	YR	ACT	INFO					
BOOK	MESSAGE HANDLING INSTRUCTIONS									
<p>FROM:</p> <p>TO:</p>										
DISTR										
DRAFTER TYPED NAME, TITLE, OFFICE SYMBOL, PHONE						SPECIAL INSTRUCTIONS				
RELEASER	TYPED NAME, TITLE, OFFICE SYMBOL AND PHONE					SECURITY CLASSIFICATION				
	SIGNATURE									

6
5
4
3
2
1
0

DD FORM 173/2 (OCR)
1 MAR 79

PREVIOUS EDITION IS OBSOLETE
S/N 0102-LF-000-1735

U.S. GOVERNMENT PRINTING OFFICE: 1984-430-737

Figure 1-7.-Joint Message Form (DD 173/2).

Priority.— Precedence prosign P is reserved for messages that furnish essential information for the conduct of operations in progress. Priority is the highest precedence normally authorized for administrative messages. Exceptions are messages reporting death, serious illness or serious injury which may be assigned administrative precedence.

Messages assigned the priority precedence normally include situation reports on the position of a front where an attack is impending, or where tire or air support will soon be placed; orders to aircraft formations or units to coincide with ground or naval operations; messages concerning immediate movement of naval, air or ground forces; weather observations with surface wind speeds 33 knots or less and all oceanographic observations. The speed of service objective is within three hours.

Immediate.— Precedence prosign O is reserved for messages relating to situations that gravely affect the national forces or populace and that require immediate delivery. Examples are as follows: amplifying reports of initial enemy contact; reports of unusual movements of military forces of foreign powers in time of peace or strained relations; attack orders to commit a force in reserve without delay; reports of widespread civil disturbance and requests for or directions concerning distress assistance. The speed of service objective is within 30 minutes.

Flash.— Precedence prosign Z is reserved for initial enemy contact reports or operational combat messages of extreme urgency. Examples are initial enemy contacts; messages recalling or diverting friendly aircraft about to bomb targets unexpectedly occupied by friendly forces; warnings of imminent large-scale attacks; extremely urgent intelligence messages; messages containing major strategic decisions of great urgency and reports of tropical storms, typhoons or hurricanes believed to be previously undetected. The speed of service objective is as fast as possible with an objective of less than 10 minutes.

Messages that have both action and information addressees may be assigned a single precedence, or they may be assigned a dual precedence—a higher precedence for the action addressees and a lower one for all information addressees. It is important that the assignment of dual precedence be considered on all messages with information addressees when other than routine precedence is assigned to the action addressee(s).

Classification Block

This block consists of the classification abbreviation repeated four times (UUUU, CCCC and SSSS).

Originator Message Identification (ORIG MESSAGE IDENT) Block

This block is used by the preparer to assign an identifying number to help in keeping track of messages within the command. It consists of a three-digit Julian date combined with the four-digit ZULU time that the message was typed.

Message Handling Instruction Block

The word ADMIN is typed here if a message is determined to be administrative instead of operational in nature.

From Line

The originating short title of the command as listed in the Message Address Directory (MAD), USN PLAD-1, is typed following the preprinted FROM.

To Line

The short title of the intended recipient(s) of the message is listed here after the preprinted TO. List each addressee directly under the previous one. There is no limit to the number of addressees that can be listed.

NOTE: On second and subsequent pages, the words FROM and TO preprinted on the form are ignored and typed over.

Info Line

Commands being sent the message for information only (no action required on their part) are listed here. The word INFO is typed on the form under TO in a position that allows INFO addressees to be listed directly under the TO addressees.

Classification and SSIC Line

This line shows the classification followed by the Standard Subject Identification Code (SSIC) of the subject matter. The SSIC is set off with two slashes before and after, and the number is preceded by an N to denote that the message was originated in the Navy. Example: UNCLAS//N05720//. Specific instruction on

the makeup of the classification entry can be found in NTP-3 and local operating procedures.

Subject Line

Type the word SUBJ under the classification line and follow it with the plain language subject of the message.

Text

The text of a naval message is prepared following standard paragraphing procedures. Message paragraphs are numbered, except for short one-paragraph messages or formatted messages. If the message is classified, it is marked with the proper paragraph and downgrading markings.

The punctuation marks that may be used within the text are as follows:

Hyphen (-)

Question mark (?)

Colon (:)

Dollar sign (\$)

Apostrophe (')

Ampersand (&)

Parentheses ()

Period (.)

Comma (,)

slant (/)

Quotation mark (")

Punctuation marks that may not be used are as follows:

Number symbol (#)

"At" sign (@)

Percent (%)

Fractions (1/2, 1/4)

Asterisk (*)

Underscore (_)

Cent sign (¢)

Distribution, Drafter Release Blocks

These blocks are filled in on the first page only. Local procedures determine block comments.

Security Classification Block

The unabbreviated security classification is typed in this block.

Since the message form is read by computer, each entry must be placed in a predetermined position on the paper. NTP-3 and local procedures define the margin and tab settings you will use in message preparation.

UNIT SITREP

A sailor is lost at sea. . . two jets collide while taxiing on an aircraft carrier's flight deck . . . an accident aboard a naval station results in the loss of hundreds of dollars worth of equipment...these are some of the incidents that warrant the preparation of a unit situation report (SITREP).

A unit SITREP is a message transmitted by any unit CO, officer in charge, or other commander to notify appropriate operational commanders and seniors in the chain of command of a significant event or incident.

Generally, the unit SITREP is used when an incident does not meet the criteria of the Operational Report (OPREP) 3 reporting system. An OPREP 3 is a higher level reporting system used to inform senior authority that an incident of national or high U.S. Navy interest has occurred.

Unit SITREPS are most often written by the operations department of a ship or shore command. However, there are times when a senior journalist is asked to assist in the writing of a unit SITREP.

A unit SITREP is transmitted within 20 minutes of knowledge of an event or incident under the following conditions:

- When directed
- When considered appropriate by the reporting activity
- When bomb threats have been evaluated as a hoax

Included in a unit SITREP is a brief account of the event being reported. Basic rules of journalism apply to the formulation of a SITREP. Use clear, concise statements that answer the following questions:

- What happened?
- Who was involved?
- Where did it happen?

- When did it happen?
- Why did it happen?
- What action is ongoing?
- What future action is planned?

When drafting a unit SITREP, you may not report sensitive personal information that might cause an unwarranted invasion of personal privacy of the individuals involved in the incident. These incidents include reports of spouse/child abuse, assault or rape of a service member or dependent. In sensitive circumstances where disclosure of the identity of the individuals involved might cause embarrassment or inconvenience, the personal identity of those involved should be withheld. A generic identification, such as "PO1" or "20 YR OLD FEMALE E-3" will do.

The general guideline with regard to the release of information applies to a unit SITREP: **DO NOT DELAY AN INITIAL REPORT TO GAIN ADDITIONAL INFORMATION.** Remember, you have 20 minutes to get the initial message out. The assigned precedence depends on the situation at hand.

A sample unit SITREP is shown in figure 1-8. More specific information and guidelines on the unit SITREP may be obtained in the OPNAVINST 3100.6 series (Special Incident Reporting).

NEWS RELEASE IN MESSAGE FORM

A proposed news release or statement with questions and answers for response to query in message form may accompany or immediately follow a unit SITREP. This type of release amplifies the information contained in the unit SITREP.

The proposed news release should leave the ship within one hour of the time of the incident. As with the unit SITREP, the initial release must NOT be deferred until the full story is available. An initial release, no matter how sketchy or incomplete, alerts public affairs personnel ashore at the earliest possible moment and allows them to begin preparing to assist you.

Ideally, the initial news releases and follow-up news releases should answer the same questions addressed in the unit SITREP. Some others which may come to mind (if applicable) include the following:

- What is the number of personnel injured/killed?
- How many personnel are still missing?

- Has the situation been brought under control by the time of the release, or is it still out of control?
- Were news media present? If so, provide names and affiliations. If not, so state.

As additional information becomes available and, as appropriate, submit follow-up message news releases. These releases need not be completed stories; outlines of pertinent information will assist public affairs personnel at a higher command level in handling media interest.

A sample message press release is shown in figure 1-9.

PUBLIC AFFAIRS GUIDANCE (PAG)

Public affairs guidance (PAG) is a source on what to say and what not to say on a particular issue. It is intended to convey the official Navy or command position and to anticipate any possible questions with appropriate answers.

Any issue or topic that is either likely to be of interest to the media, either external or interred, or to generate questions should have corresponding PAG written. Examples include a civilian hiring freeze at a shore facility or a ship's public visitation. The more controversial the issue, the more PAG is needed. Information derived from memoranda, tips, meetings and messages will help you decide whether or not PAG is required.

PAG relating to national or Navywide issues are written by the CHINFO Plans, Policy and Community Relations Division (01-5). You will come across CHINFO-generated PAG in your message traffic.

Before you sit down and draft PAG, you should take the following planning steps:

1. Gather information from the people involved in the issue and from official Navy sources (messages, memoranda, etc.).
2. Develop key points of contact and work closely with them.
3. Work with your points of contact, not against them. Make them understand in a tactful manner that the PAG is intended to help their mission by informing interested parties. Try to be a part of the team and take their goals and constraints into consideration.
4. Ask questions. If a question occurs to you, it will most likely occur to someone else.

ROUTINE
R 241945Z OCT 91

FM COMNAVBASE SEATTLE WA

TO CINCPACFLT PEARL HARBOR HI

INFO CNO WASHINGTON DC
COMNAVSEASYS COM WASHINGTON DC
COMNAVSURFPAC SAN DIEGO CA
CDRUSASIX AND PSF SAN FRANCISCO CA
NMPC WASHINGTON DC
COMNAVIRPAC SAN DIEGO CA
COMNAVBASE SAN FRANCISCO CA
COMNAVBASE SAN DIEGO CA
COMNAVBASE PEARL HARBOR HI
COMNAVSURFRESFOR NEW ORLEANS LA
NAVMARCORESCEN SPOKANE WA
NAVRESREDCOM REG TWO TWO SEATTLE WA

UNCLAS //N03440//

MSGID/UNIT SITREP/COMNAVBASE SEATTLE/001//

1. FIRES IN SPOKANE, WASHINGTON 100 PERCENT UNDER CONTROL.
2. NAVMARCORESREDCEN SPOKANE PROVIDED SHELTER FOR 350 FIRE FIGHTERS TWO NIGHTS 20-21 OCT 91.
 - FIRE FIGHTING EQUIPMENT TOTALED 85 UNITS, I.E., FIRE TRUCKS, TANKERS, FOOD SERVICE UNITS.
 - UNITS CAME FROM OR, WA, ID, NM
 - NAVMARCORESREDCEN USED AS AN EMERGENCY OPERATIONS CENTER BY SPOKANE COUNTY DEPT OF EMERGENCY SERVICES, SPOKANE FIRE DEPT, STATE OF WASHINGTON DEPT OF NATURAL RESOURCES, DUE TO PROXIMITY (4 MILES) OF MAJOR FIRE AREAS.
 - NAVRESCEN SELECTED AS A "GOOD STAGING AREA" BECAUSE OF SECURITY OF FACILITY, ADEQUATE PARKING SPACE FOR LARGE VEHICLE MARSHALLING AREA.

Figure 1-8.-Unit Situation Report (SITREP).

3. FACILITY LEFT CLEAN AND IN GOOD ORDER.

– ONE GLASS FRONT DOOR PANE BROKEN BY FIRE FIGHTER; REPLACEMENT COST \$400.00. STATE OF WA DEPT OF NATURAL RESOURCES IS PAYING FOR GLASS DOOR REPLACEMENT AND PROVIDING JANITORIAL SERVICES.

4. INITIAL REQUEST CAME SUNDAY 20 OCT 91. NORMAL DRILL WEEKEND IN PROGRESS WITH FULL STAFF AVAILABLE AT NAVRESCEN.

– CO, CAPT H. RALSTON, AFTER NOTIFICATION TO COMNAVBASE SEATTLE AT 1035 20 OCT 91, ESTABLISHED A 24-HOUR WATCH.

– WA ARMY NATIONAL GUARD PROVIDED SECURITY AT TWO GATES.

– MOBILE INSHORE UNDERSEA WARFARE UNIT 102, AND MARINE CORPS RESERVE INSTRUCTOR INSPECTOR STAFF PROVIDED PART OF WATCH STANDING TEAM.

– MOBILE FIELD KITCHEN ORIGINALLY SET UP IN TENT, BLOWN OVER BY WINDS GUSTING TO 52 M.P.H., REESTABLISHED IN MARCORPS BARN WITHOUT DISRUPTING MEAL SERVICE.

5. PER COMMANDING OFFICER, "WHOLE EVOLUTION WENT EXCEPTIONALLY WELL . . . GOOD EXAMPLE OF INTERAGENCY COOPERATION IN EMERGENCY."

Figure 1-8.-Unit Situation Report (SITREP)-Continued.

After you have completed the necessary planning steps, organize your information and write the PAG. Some tips are as follows:

- A single issue can be diverse in nature. In this instance, select the most important topic and make this topic the subject of the statement.
- The statement should be a clear, concise report of the issue. It is the official command statement regarding the subject. Make it as short and as simple as possible without compromising clarity.

- After the statement, write a list of likely questions and their proper answers. Ask other people who are familiar with the issue for their ideas. If the answer is not in the information you gathered initially, conduct further research to find out if that information is releasable.
- Always strive to keep the guidance easily understood, accurate and within the bounds of security and official policy.

Sample PAG is shown in figure 1-10.

IMMEDIATE
0 010001Z JAN 91

FM USS BLACKSHOE

TO COMSEVENTHFLT

INFO CINCPACFLT PEARL HARBOR HI
CHINFO WASHINGTON DC
COMNAVSURFPAC SAN DIEGO CA
APPROPRIATE GROUP/SQUADRON AND CHAIN OF COMMAND
COMUSNAVPHIL SUBIC BAY RP
SEVENTHFLT PA REP SUBIC BAY RP
FHTNC NORFOLK VA

UNCLAS //N05720//

SUBJ: ACCIDENT PRESS RELEASE

- A. CINCPACFLT OPORD 201, ANNEX F
- B. USS BLACKSHOE LTR 5720 SER 308 OF 26 DEC 90

1. IAW REF A, FOLLOWING PRESREL PROPOSED FOR RELEASE:

A. QUOTE. USS BLACKSHOE AT SEA, 31 DEC — SIX PERSONS WERE KILLED AND EIGHT INJURED — FOUR CRITICALLY — AS A FLASH FIRE SWEEPED THROUGH THIS DESTROYER'S AFTER ENGINE ROOM TODAY.

B. THE FOUR CRITICALLY INJURED MEN HAVE BEEN MEDICALLY EVACUATED TO THE U.S. NAVAL HOSPITAL AT SUBIC BAY IN THE REPUBLIC OF THE PHILIPPINES. THE OTHER INJURED MEN ARE PROGRESSING SATISFACTORILY AFTER BEING TREATED BY THE BLACKSHOE'S INDEPENDENT DUTY CORPSMAN FOR SMOKE INHALATION AND MINOR BURNS.

C. THE FIRE BROKE OUT AT 2034H AND WAS EXTINGUISHED AT 2108H AS THE SHIP WAS STEAMING ABOUT 75 NAUTICAL MILES FROM SUBIC BAY. THE SIX MEN WHO DIED WERE ON WATCH IN THE FIREROOM AND APPARENTLY WERE TRAPPED AS THE FLAMES QUICKLY SPREAD THROUGHOUT THE SPACE.

D. THE CAUSE OF THE FIRE IS NOW UNDER ROUTINE INVESTIGATION.

E. BLACKSHOE IS NOW EN ROUTE TO SUBIC BAY UNDER GREATLY REDUCED SPEED AND IS EXPECTED TO ARRIVE SHORTLY AFTER DAYBREAK.

F. IDENTITY OF THE DEAD AND INJURED PERSONNEL IS BEING WITHHELD PENDING NOTIFICATION OF NEXT OF KIN. UNQUOTE.

2. NO NEWSMEN WERE EMBARKED.

Figure 1-9.-Accident press release.

ROUTINE
R 171146Z DEC 90

FM CHINFO WASHINGTON DC

TO AIG ONE ONE ZERO FOUR ONE
AIG ONE THREE EIGHT THREE ONE
COMNAVRESFOR NEW ORLEANS LA
COMPHIBGRU THREE ATF

UNCLAS //N05720//

SUBJ: PUBLIC AFFAIRS GUIDANCE - STOP LOSS ACTION FOR NAVY
PERSONNEL

A. CNO WASHINGTON DC 131742Z DEC 90

1. THE NAVY HAS ANNOUNCED A SECOND STOP LOSS ACTION, THIS ONE APPLYING TO OFFICER AND ENLISTED MEDICAL PERSONNEL WHOSE SKILLS ARE IN SHORT SUPPLY AS A RESULT OF OPERATION DESERT SHIELD AND WHOSE EFFECTIVE DATES OF RETIREMENT OR SEPARATION FALL ON OR AFTER 2 JANUARY 1991.

2. THIS IS THE NAVY'S SECOND USE OF STOP LOSS AUTHORITY. THE NAVY'S PREVIOUS USE OF STOP LOSS AUTHORITY, AS ANNOUNCED ON DECEMBER 4, AFFECTED ONLY NAVY PERSONNEL ASSIGNED TO MARINE CORPS UNITS COMMITTED TO DESERT SHIELD, INCLUDING MEDICAL, RELIGIOUS SUPPORT AND SOME OTHER SPECIALTIES.

3. THIS NEW USE OF STOP LOSS AUTHORITY AFFECTS ALL NAVY DOCTORS, PHYSICIAN ASSISTANTS, NURSES, HOSPITAL CORPSMEN, ORAL SURGEONS AND MEDICAL SERVICE CORPS PERSONNEL IN EIGHT SPECIALTIES. THESE ARE SKILLS WHICH ARE CRITICAL AND IN SHORT SUPPLY DUE TO EXPANDED REQUIREMENTS FOR NAVY MEDICAL PERSONNEL TO SUPPORT MARINE CORPS UNITS, HOSPITAL SHIPS, OTHER CASUALTY TREATMENT SHIPS AND SHORE-BASED FLEET HOSPITALS SUPPORTING DESERT SHIELD.

4. STOP LOSS AUTHORITY PERMITS THE SERVICES TO RETAIN SERVICE MEMBERS ON ACTIVE-DUTY BEYOND THEIR RETIREMENT DATE, RELEASE FROM ACTIVE DUTY DATE (RAD), END OF OBLIGATED SERVICE (EAOS), OR — IN THE CASE OF RESERVE PERSONNEL — UNTIL THE COMPLETION OF THE MEMBERS RECALL ORDERS. BASED ON AN AUGUST PRESIDENTIAL ORDER, THE SECRETARY OF DEFENSE GRANTED STOP LOSS AUTHORITY TO THE SERVICE SECRETARIES TO USE AS NEEDED TO RETAIN PERSONNEL ESSENTIAL TO THE NATIONAL SECURITY IN POSITIONS AND SKILLS CONSIDERED CRITICAL TO OPERATION DESERT SHIELD.

Figure 1-10.-Public Affairs Guidance (PAG).

5. THE FOLLOWING QUESTIONS AND ANSWERS ARE PROVIDED FOR USE IN RESPONSE TO QUERY:

Q1. DOES THE NAVY PLAN TO USE STOP LOSS AUTHORITY FOR OTHER PERSONNEL?

A1. THE NAVY CONTINUES TO ASSESS PERSONNEL REQUIREMENTS RELATED TO DESERT SHIELD AND MAY USE STOP LOSS AUTHORITY IN ADDITIONAL CASES IF MANNING CONDITIONS OR EVENTS SO DICTATE.

Q2. WHAT PERSONNEL ARE INVOLVED IN THIS STOP LOSS ACTION?

A2. PERSONNEL AFFECTED ARE ENLISTED HOSPITAL CORPSMEN; MEDICAL CORPS OFFICERS; NURSE CORPS OFFICERS; CHIEF WARRANT OFFICERS WHO ARE PHYSICIAN'S ASSISTANTS; DENTAL CORPS OFFICERS WITH A SPECIALTY IN ORAL SURGERY; AND MEDICAL SERVICE CORPS OFFICERS WITH SPECIALTIES IN PHYSICIAN'S ASSISTANT, CLINICAL PSYCHOLOGY, ENVIRONMENTAL HEALTH, MEDICAL TECHNOLOGY, PHYSICAL THERAPY, DIETITIAN, PHARMACY AND OPTOMETRY. STOP LOSS APPLIES TO THESE INDIVIDUALS WHEN EFFECTIVE DATES OF SEPARATIONS OR RETIREMENT FALL ON OR AFTER JANUARY 2, 1991, INCLUDING NAVAL RESERVE MEDICAL PERSONNEL RECALLED FOR DESERT SHIELD.

Q3. ARE THERE EXCEPTIONS?

A3. THE STOP LOSS DOES NOT PRECLUDE THE SEPARATION OF PERSONNEL WHO ARE PROCESSED UNDER NORMAL PROCEDURES FOR HARDSHIP, DISABILITY, INVOLUNTARY ADMINISTRATIVE SEPARATION, MANDATORY RETIREMENT (INCLUDING SELECTIVE EARLY RETIREMENT OF OFFICERS AND HIGH YEAR TENURE FOR ENLISTED PERSONNEL), OR DISCHARGE UNDER THE UNIFORM CODE OF MILITARY JUSTICE. OTHERWISE, EXCEPTIONAL CASES WILL BE CONSIDERED ON A CASE-BY-CASE BASIS FOR POSSIBLE EXCEPTION.

Q4. HOW MANY PERSONNEL ARE INVOLVED?

A4. THIS ACTION APPLIES TO APPROXIMATELY 6,000 NAVY ENLISTED PERSONNEL (HOSPITAL CORPSMAN) AND 2,400 OFFICERS WHO OTHERWISE WOULD HAVE BEEN ELIGIBLE TO LEAVE ACTIVE SERVICE BETWEEN JANUARY 2 AND SEPTEMBER 30, 1991. IT ALSO APPLIES TO SOME NAVAL RESERVE HOSPITAL CORPSMEN WHOSE ENLISTMENTS WERE SCHEDULED TO EXPIRE PRIOR TO THE END OF THEIR RECALL PERIOD.

6. QUESTIONS BEYOND THE SCOPE OF THIS GUIDANCE SHOULD BE REFERRED TO THE CHINFO NAVY NEWS DESK, 703-697-5342/4627 OR NMPC PAO, 703-614-4200.

7. RELEASED BY CAPT R. S. PRUCHA.

Figure 1-10.-Public Affairs Guidance (PAG)-Continued.

MEMORANDUM FOR THE RECORD

A memorandum for the record is an important administrative tool that allows you to do the following:

- Record significant information that, otherwise, would not be recorded in writing.
- Record telephone calls in anticipation of the written word.
- Maintain a record copy of action underway and the reasons for the action.

- Pass information up the chain to keep your bosses informed.
- Keep personnel informed on key issues.
- Cover yourself.

As with a standard memorandum, the paragraphs are numbered and the margins are one inch on the left, right and bottom. Maintain a 1 1/4-inch top margin. The format for a memorandum for the record is shown in figure 1-11.

<p>Memo for the Record</p> <p>Subject: Preparing a Separate Page Memorandum for the Record</p> <p>1. Use a Separate Page Memorandum for the Record to fulfill any of the following functions:</p> <ul style="list-style-type: none">a. To record significant information that would otherwise not be recorded in writing.b. To record telephone calls in anticipation of the written word.c. To serve as a record copy of action underway and reasons for the action.d. To pass on information up the chain to keep the bosses informed within their division or agency.e. To keep personnel informed on key issues.f. To protect "thyself," <p>2. Type or write it on a separate sheet of paper in this format. Paragraphs are numbered and margins are 1 inch at the left, right and bottom with a 1 1/4 inch top margin.</p> <p style="text-align: center;">IT'S YOU JO1, USN</p>	<p>(Date of MR)</p>
---	---------------------

Memo for the Record

Use this format when adding an Explanatory MR to the last page of the record copy of the basic correspondence. The Explanatory MR is typed on the coordination tissue carbon copies at the end of the correspondence (after the signature). If the signature falls at the bottom of the page, the Explanatory MR is typed at the top of the next page, still on the coordination set of tissue carbons. The MR is usually one paragraph long; if you cannot get it all in one, number your paragraphs. You do not need a subject line, and there is no signature element. Merely sign your last name after the last word of the text. The Explanatory MR gives the reader a quick synopsis of why the correspondence was drafted in the first place, who got involved in the process and what the real significance of the correspondence is.

Figure 1-11.-Memorandum for the record.

POINT PAPER

A point paper (also called a talking or issue paper) is a concise document that provides capsulized comments for use during a meeting or conference. It can also serve as a memory tickler or a quick-reference outline for a superior (usually the CO), or as a suitable study guide for the CO to use in preparing for a press conference.

The PAO or the senior journalist normally writes a point paper. The actual style of your point papers may vary, depending on the preference of your boss. Some commands will have an instruction or notice on their preparation.

There are two varieties of point papers. Figure 1-12 is the informal point paper format, and figure 1-13 is the formal point paper format.

POINT PAPER ON PREPARATION OF INFORMAL POINT PAPERS

- A point paper is a concise document that provides succinct comments for use during a meeting or conference.
- Usually prepared by an action officer or staff member for a superior.
- Serves as a memory tickler or quick reference outline.
- Point papers are good study guides for a commander to use in preparing for press conferences where a number of areas may be discussed.
- Normally prepared in outline form and may use “telegraphic wording” rather than complete sentences.
- Style depends on user’s knowledge of subject and desires.
- Formats vary, but this example illustrates one of the most popular.
- Uses dashes before major points; further indent subordinate points.
- Use the one-dash, two-dash, three-dash sequence.
- Double-spaced between points, and try to keep it to one page.
- Avoid chronologies and masses of statistics.
- You may write a background paper to accompany a point paper, if needed.
- Think of what the user will say; include the key facts.

Figure 1-12.-Informal point paper format.

**POINT PAPER ON
FORMAL POINT PAPER FORMAT**

PROBLEM

Statement or description of topic. Type "PROBLEM" three lines from title.

BACKGROUND

A summary of what has transpired to date. Block paragraph(s).

DISCUSSION

A summary of what remains to be done. Indented, numbered paragraphs.

1. There are formal and informal point papers. Formats are not universal, but this is a sample of a formal point paper used by some major commands.

2. Prepare on 8- x 10 1/2-inch plain bond paper.

3. Center the subject or title in underscored capital letters approximately 1 inch from the top of page.

4. Place security classification and markings (if any) in accordance with security regulations.

5. Use 1-inch margins on top, right and bottom of page; use 1 1/4-inch margin on the left. Double-space all lines.

6. Use appropriate language to permit use of the paper for oral delivery without considerable paraphrasing, deletion and substitution. Write points in a brief, telegraphic style.

7. Formal point papers normally contain the five unnumbered headings you see underlined.

8. Point papers are written briefs prepared to jog the memory of managers during oral presentations; they are based on the assumption the intended user has knowledge of the subject. They may be used in conjunction with a background paper when detailed background on a subject is required.

CONCLUSION

Point papers are outline guidance papers concisely stating facts and giving a series of reminders.

RECOMMENDATION

Point papers should do the following:

1. Point out areas of disagreement.

2. Include areas of agreement.

3. Be limited to as few pages as possible.

(Enter office symbol of prepared here, in parentheses.)

Figure 1-13.-Formal point paper format.

FILES

Learning Objective: *Recognize the elements of a public affairs office filing system and the procedures associated with organizing a newspaper/magazine clip file.*

As a public affairs office manager, you must have the ability to file correspondence correctly and retrieve it quickly. The amount of time it takes you to locate a news clip or a news release from two months ago will depend on how well your files are organized.

Hardware

The types and sizes of file cabinets vary to accommodate the size of the material filed. Since materials should be filed without folding, the size of the cabinet is determined by the size of the individual sheets, documents or other items to be filed.

Four- or five-drawer, steel, letter-size cabinets are the Navy standard for correspondence and documents. The Navy standard correspondence size is 8 1/2 by 11 inches, and file cabinets available through the supply system are designed to accommodate this size. Specialized file cabinets are available for larger sized documents, such as drawings, charts or legal-sized documents.

File Folders

Standard file folders are used to keep your correspondence orderly. They are available in two sizes: letter, 9 by 11 3/4 inches and legal, 9 by 14 3/4 inches. Each folder has an area for labeling that extends above any filed material. The area may run the entire length of the folder, known as the straight cut, or may be cut in one of three positions-left, center, or right-known as one-third cut. Straight-cut folders are used, generally, when the files are thick enough to make sure the labels of adjacent folders are easily seen. One-third cut folders space the labels across the drawer so that a label will not be hidden by the folder in front of it. Figure 1-14 shows files that are one-third cut tabs.

Organization

The method of maintaining files is strictly up to the individual public affairs office manager. A basic file organization may follow the major divisions within a public affairs office (shown in figure 1-2) with individual file drawers (or entire file cabinets, if available) dedicated to the major office divisions and/or subdivisions.

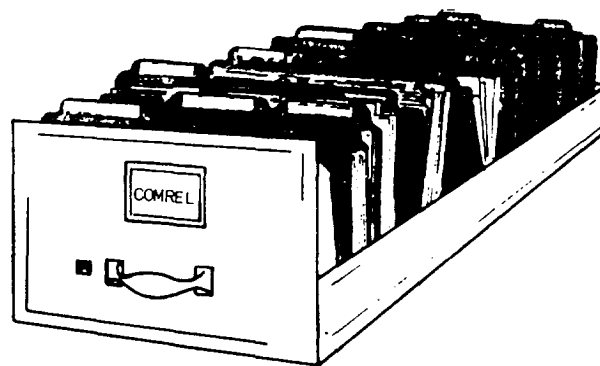

Figure 1-14. File folders with one-third cut tabs.

No matter what organizational method you choose, you should maintain files on the following items:

- Incoming and outgoing correspondence
- Memoranda (including internal office memoranda, such as memoranda for the record, and those distributed outside the office)
- Messages (incoming, outgoing, NNS, etc.)
- Stock photographs
- Stock video footage
- Biographies (CO, XO, C/MC)
- Command history
- Media contact list
- Subject files (environmental, PAG, etc.)
- News release file

Clip File

Maintaining a comprehensive newspaper/magazine clip file is an important responsibility of a public affairs office manager. This file serves the following purposes:

- To support your external release efforts by retaking articles based on locally generated releases.
- To keep the CO and PAO informed on what is being said about the command in the print media, which leads to a better understanding of the local community.
- To help the CO better understand the print media.

- To be used as a historical source for future research by your staff and visiting media representatives.
- To provide a source for clips that maybe included in the command history.

Your clip file should be a showcase for all who set eyes on it. Do not settle for sloppily cut clips with jagged edges and words missing, or clips that are stapled or taped to its backing sheet. Make sure each clip is cut from the source as straight as possible, and center mount it on an 8 1/2-by 11-inch sheet of plain bond paper using a paper adhesive, preferably rubber cement. Stapling or taping the clip to the backing sheet will not give you a professional product.

In either the upper left or upper right-hand corner of the clip sheet, type the following information: (1) name of the publication, (2) date of the publication and (3) the page number in which the clip appeared. Make a notation if the clip extended over more than one page.

Make a copy of each day's clips to forward to the CO, XO, C/MC and department heads for review. To make sure the clips do not fall out of the folder, punch two holes in the top of the mounting sheet of the clip and attach them using a two-pronged fastener. Staple or paper clip a route slip to the outside of the folder.

You may also want to analyze the clips that were developed from an office external release. This can be done by using a clip slip called "Clipanalysis."

Public Relations Quarterly explains how the CLIPANALYSIS system works.

Almost every time a public relations writer sends off a news release, a number of questions arise.

Will the publications use the release? Which publications? Why wouldn't it be used? Is it too slanted? Have the editors grown tired of the subject matter? If it is used, will it be edited, shortened, corrected or will the intent be changed?

Puzzling questions? Of course, knowing the editors helps in sorting out the dilemma. And judicial media planning plays a part in clearing the fog, but experience is the best teacher, as the saying goes.

At PR&D, a creative marketing communications firm serving the St. Louis area, we have found that the questions are becoming easier to handle, thanks to our system for analyzing experience in news release placement.

Simply put, the system provides for gathering information on what editors use and do not use. Then with the information in hand, releases are prepared to mesh with editor's requirements.

Here is how we do it: with a handy little form called a Clip Slip.

When a clipping comes back to us, we study it carefully—as anyone would—but we carry the process a couple of steps further. Comparing the clipping to the release we issued, we analyze the differences by applying the puzzling questions noted earlier. (See the sample Clip Slip in figure 1-15.)

CLIPANALYSIS

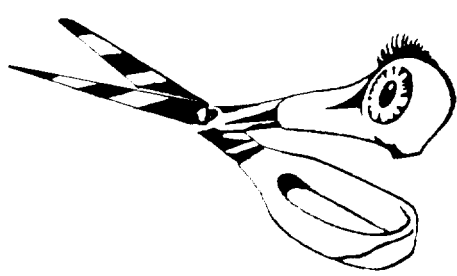

Publication St. Louis Post-Dispatch
 Date 11-2-75
 Origin internal X external _____
 Complete information? no one called for info

EDITING
 Shortened? cut 1/3
 Rewritten? Slightly - language softened - "has" rather than "is complete with"
 Editorializing? yes - eliminated persuasive language
 Lead changed? a little - "opening," rather than "grand opening"
 Intent maintained? yes

Other notes all changes were toward objectivity

Reprinted with permission from *Public Relations Quarterly*, 44 W. Market St., Rhinebeck, NY 12572, (914) 876-2081, October 11, 1991

174.IX

Figure 1-15. Sample CLIPANALYSIS.

By faithfully evaluating clippings, we have compiled a store of documented data for each publication with which we deal. Periodically, the Clip Slip information is tabulated, making it easy to spot recurring forms of editing.

In addition, a provision is made on our distribution sheets for checking off the publications using our stories. This makes for speedy study of coverage.

Like any other procedure, Clipanalysis is not a cumbersome task if the work is not allowed to pile up. The evaluation process is really quite intriguing.

The system helps our firm gauge its effectiveness in a very concrete way, but more important, it lets us know how well we are servicing our clients. This kind of evaluation is an area in which too many public relations firms are lax, and an area where advertising agencies take the lead.

The advantages of Clipanalysis are appealing to any public relations practitioner. It relieves tension by transforming guesswork about placement into documented guidelines. And it aids in relations with editors by always providing them with what they want—nothing more, nothing less, nothing unacceptable.

THE TELEPHONE

Learning Objective: *Recognize the fundamentals of telephone etiquette, properly taking messages and using answering and facsimile machines.*

Good telephone communications are vital to the smooth operation of a public affairs office. The way you conduct yourself on the telephone will leave lasting impressions, either favorable or unfavorable ones, on the person calling your office. As the public affairs office manager, you must make sure your staff is well versed on telephone procedures so favorable impressions are commonplace.

ETIQUETTE

Open a telephone conversation with a phrase identifying your office and yourself. In answering the telephone, you might say, for example, "Naval Air Station Public Affairs, Petty Officer Knott speaking, may I help you please? The following are some telephone etiquette tips:

- Slow down. Blurting out "Navalairstation-public affairs, Pettyofficer Knottspeakin,

mayIhelpyouplease?" in less than three seconds is disconcerting and has no place in public affairs office telephone communications. An introduction using a steady, conversational tone is best and will make the caller feel at ease.

- Give the caller your undivided attention. Picking up the receiver while finishing a conversation with someone in the office is annoying and rude.
- Do not eat or drink. Coming across as a "marble mouth" will do nothing to enhance your credibility and that of the office.

If the caller's identity is unknown, you should ask for a name and organization. Ask for it tactfully, for example, "May I ask who is calling, please?" or "May I have your name, please?" Avoid phrases that sound abrupt or suspicious, such as "Who is this?" or "Who's calling?"

After obtaining the caller's identity, cordially offer any assistance or answer desired by the caller. If a call is received for another member of the staff, do not put the caller on hold without telling him what you are doing. "One moment, please," followed by the action you are taking, is acceptable. **NEVER** use the long-standing, ill-advised phrase, "Wait one." Also avoid "Hold on," "Hang on," "Hold the line," "Just a minute," "Just a second," and so forth.

A good public affairs office manager will maintain a sign-in/out board where a staff member can list his time of departure, destination and an estimated time of return. This information comes in handy when handling a call for someone who is absent. Offer this information to a telephone caller if it appears appropriate.

It is often a good idea, when the person called is out, to say, "Perhaps I could help you." Even if it turns out that you cannot, the caller will appreciate your good will.

Some additional telephone etiquette tips are as follows:

- Answer the telephone as promptly as possible. It should not be left unattended during working hours.
- When you make a call, allow the person plenty of time (about 10 rings) to reach the instrument.
- If you have placed a caller on hold, return to the telephone as quickly as you can. If you see it is going to take longer than you thought, explain the difficulty, and ask if the caller would prefer to wait or to have you call back.

- Be sure your telephone conversations always demonstrate courtesy, tact and good judgment.

TAKING MESSAGES

When the person called is unavailable, offer to take a message. The memorandum of call (figure 1-16) contains several blocks of information to assist you in recording a message. USE THEM! Gather as much information as possible so the person who was called does not have to reconstruct the entire conversation with you. Also, do not be lazy and scribble the message so that it can only be deciphered by a handwriting specialist.

Even if a message is not given, make a note of the call. As soon as you hang up, place your note where the person for whom it is intended is sure to receive it.

ANSWERING/FACSIMILE MACHINES

Only a few years ago, answering and facsimile (fax) machines were considered luxury items. Today, you would be hard pressed to find an excuse not to have them in your office.

MEMORANDUM OF CALL			Previous editions usable
TO:			
<input type="checkbox"/> YOU WERE CALLED BY--	<input type="checkbox"/> YOU WERE VISITED BY--		
OF (Organization)			
<input type="checkbox"/> PLEASE PHONE ►	<input type="checkbox"/> FTS	<input type="checkbox"/> AUTOVON	
<input type="checkbox"/> WILL CALL AGAIN	<input type="checkbox"/> IS WAITING TO SEE YOU		
<input type="checkbox"/> RETURNED YOUR CALL	<input type="checkbox"/> WISHES AN APPOINTMENT		
MESSAGE			
RECEIVED BY		DATE	TIME
63-110 NSN 7540-00-634-4018		STANDARD FORM 63 (Rev. 8-81)	
U.S. G.P.O. 1990-461-274/429		Prescribed by GSA FPMR (41 CFR) 101-11.6	

Figure 1-16.—Memorandum of Call.

The answering machine offers many benefits. During nonworking hours or when training is in progress, the answering machine can be activated and you will not miss a call. Some state-of-the-art models can even give you the date and time of the incoming call.

Fax machines allow you to send or receive a document from an office across the street or across an ocean. If your office has more than one telephone line, you can connect the answering machine to one and the fax machine to the other, providing total office coverage after hours. Fax machines come in handy when disseminating a short fuse news release to the media or when sending releases and correspondence to other public affairs offices.

BUDGETING TIME

There are some days when the telephone will seemingly “ring off the hook” and you spend half a day taking care of business on the telephone. This is permissible if your projects do not suffer in the process.

Do not be a slave to your telephone. If you have several projects on the front burner and the telephone continually rings, the priority rests with your office work. Make sure messages are taken and calls are returned at the earliest possible moment.

SHIPBOARD PUBLIC AFFAIRS OFFICE MANAGEMENT

Learning Objective: Outline the proper arrangement of a shipboard public affairs office in terms of office arrangement, manning, facilitating special projects and financial planning.

Managing a shipboard public affairs office incorporates all of the topics you have read about so far in this chapter, but it also includes a few other unique aspects you should realize. Manning concerns and special projects will be discussed in this section.

TYPICAL OFFICE ARRANGEMENT

A large public affairs office afloat normally includes a full-time (1650) or collateral duty PAO, a senior journalist (JO1, JOC, JOCS or JOCM) and a staff comprised of a mixture of JO2s, JO3s and JOSNs. Manning configurations vary from ship to ship.

The staff handles more than just public affairs work. As the senior journalist and overall manager, you must make assignments to cover the closed circuit television

and radio stations, ship's newspaper, tours program, and so forth.

Having a collateral duty PAO as your boss means you most likely will be in charge of the day-to-day responsibilities of the office. This situation will vary, depending on how much time the PAO can devote to the office.

In some instances, you will receive requests from individuals outside of the division to volunteer their time to write stories or help with television or radio production. There is nothing wrong with this practice, provided you carefully screen each volunteer. Additionally, do not assign volunteers work that would normally be handled by your staff. Volunteers are just that—they tend to come and go at will and are not always reliable.

MANNING

Adequate manning is a constant public affairs office concern aboard ship. The old Defense Information School (DINFOS) adage, "You're a sailor first and a journalist second," holds true today. Fire party, special sea and anchor, DC/3M and general quarters assignments will drain you of personnel at the most inopportune moments, as will working parties, compartment/head cleaning duties and other tasks affiliated with life aboard a ship.

A vigorous cross-training program will help offset this problem. As discussed earlier, **versatility**, not specialization, is your staff goal, especially at sea. If JO2 Renalin, the X-1 division damage control petty officer and the current evening news anchor, is called away on a priority assignment, you can use JO3 O'Forth or JO2 Katt, the former news anchors, to fill in.

SPECIAL PROJECTS

There are several projects that a public affairs office manager at sea will tackle, including, but not limited to, the following: ship commissioning, homecomings, decommissioning, handling civilian embarks, the SECNAV Guest Cruise Program and tours.

Commissionings

The commissioning ceremony is one of the most time honored ceremonies in the U.S. Navy. It is the ceremonial transition of a ship from its building and outfitting stage to becoming an operational Navy unit.

If you are assigned to a ship's precommissioning unit, you and the PAO will work closely with the prospective CO of the ship and possibly regional PAOs in preparing the commissioning plan, with CHINFO acting as the overall coordinator. A sample ship's commissioning plan is shown in Appendix V of this manual.

Remember that at least six weeks before the ceremony, you and/or the PAO must keep CHINFO and the Commander, Naval Sea Systems Command (COMNAVSEASYS COM) informed of the status of the ceremony. This is done by completing CHINFO Report 5720-3 (Special Ceremonies Report). The following pieces of information must be included in the report:

- Date of the ceremony
 - Location of the ceremony
 - Name and telephone number of the project officer
 - Estimated local starting time of the ceremony
 - Estimated local completion time of the ceremony
 - Name, rank and/or title of the principal speaker
 - Nearest air facility
 - Indication as to whether the list of military and civilian dignitaries who have accepted invitations to attend the ceremony has been forwarded to CHINFO (if not, provide the estimated submission date)
 - Indication of whether a copy of the complete program has been forwarded to CHINFO (if not, provide the estimated submission date)
 - Indication of whether the remarks of the principal speaker have been forwarded to CHINFO (if not, provide the estimated submission date)
 - Indication of whether press kits have been forwarded to CHINFO (if not, provide the estimated submission date)
 - Names of congressional members and/or delegations which have been invited
 - Name of sponsor
- Heavy media attention should be expected at the commissioning ceremony. Your press kits should include the following information:
- Commissioning press release

- CO's biography
- XO's biography
- C/MC's biography
- Color and black-and-white photos (8 by 10 and 5 by 7) of the CO, XO and C/MC
- Line art of ship's seal/logo
- Color photo of the ship's seal/logo
- Welcome aboard booklet
- Fact sheet
- Description of the ship's coat of arms
- Background information on the ship's name (for example: USS *Benjamin Stoddert* is named after the first Secretary of the Navy. . .)
- Arranging for balloon release, if allowed
- Providing a canopy/awning for the homecoming area
- Providing refreshments for homecoming day
- Making arrangements for a pierside performance of a Navy Band, if desired
- Reserving parking spaces for the homecoming ship with the appropriate base parking coordinator
- Making arrangements for "welcome home" messages on marquees on and off base
- Assigning experienced linehandlers
- Making sure the pier senior officer present afloat (SOPA) is notified of the arrival time and berth of the homecoming ship at least one week in advance
- Contacting the base Public Works Center (PWC) to pickup vehicles requested by the homecoming ship the day before arrival
- Contacting the local Navy Morale, Welfare and Recreation (MWR) office to line up special deals for crew members

Additional instructions for completing the report can be found in *PA Regs*, Chapter 4. Consult the SECNAVINST 5030.1 series (Classification of Naval Ships and Craft) for further information regarding ship commissioning and other special ceremonies.

Homecomings

Ship homecomings are a major event for units returning from deployments and overhauls (when the overhaul was conducted outside of the ship's normal operating area). Newly commissioned ships going "home" for the first time and ships that change home ports are also welcomed with colorful homecoming ceremonies.

To plan the homecoming ceremony efficiently, a "sister ship" is usually assigned by the type commander to the returning unit. The sister ship is identified approximately three months (four to five months for aircraft carriers) before the projected arrival date.

The sister ship will name a homecoming coordinator, who will work with you, the PAO and command ombudsmen to make the arrangements for the homecoming ceremony. Some of the responsibilities of the sister ship and its homecoming coordinator include the following:

- Meeting with the homecoming ship's spouse support group to discuss desired services and details
- Making sure safety concerns are addressed, for example, crowd control during mooring and crane operation

Remember that the previous list is not all inclusive. Use your imagination when planning the ceremony with the homecoming coordinator and ombudsmen. Document your efforts every step of the way when you use memoranda for the record, and put together a planning directive that will solidify the arrangements.

Decommissioning

The organizational aspects of a decommissioning ceremony mirror those of a commissioning ceremony. You must complete CHINFO Form 5720-3 and develop the appropriate directives detailing the ceremony to include a CIB plan, if needed.

Consult the OPNAVINST 4770.5 series, General Instructions for Inactive Ships and Craft, regarding the disposition of items of historical or sentimental interest. Some of these items include the following:

- Builder's plaque
- Service record plaque
- CO's plaque
- Any other plaques bearing the ship's name

- Ship's insignia plaque
- Last flying commissioning pennant, jack and ensign
- All loaned or donated paintings, historical photographs and documents of historical interest
- All sponsor gifts
- Other paintings belonging to the ship
- Ship's bell
- Any other items of historical or sentimental interest

PRINTED INVITATIONS AND PROGRAMS.—

Printed invitations should be mailed four to eight weeks before to the actual ceremony date. Specifications are included in the SECNAVINST 5603.2 series, Printed Matter for Official Ceremonies. The preprinted invitations contain the appropriate insignia and standard invitation language. Additional wording to complete these standard invitations may be entered by hand.

Programs are also covered in this instruction, and the arrangements to have programs designed and printed should be made well in advance of the actual ceremony. Programs can be printed aboard tenders or at shore-based printing facilities.

PUBLICITY.— The responsibility for publicizing a decommissioning ceremony is delegated to the decommissioning ship's CO, who should coordinate the arrangements with the station commander. Of course, the PAO/senior JO and the public affairs office staff will be responsible for writing the decommissioning press release, making arrangements for photographic coverage, assembling the press kits, media platforms, escorting media, and so forth. Careful coordination with the naval base or station PAO where the ceremony will take place is crucial, as well as type commander.

CEREMONIAL MATERIALS.— Items, such as chairs, the speaker's platform, lectern, public address or sound system (mult-box for media) and similar objects, are needed for the decommissioning ceremony. Your local PWC will have a selection of ceremonial packages from which to choose. A fee will be imposed for the use of the materials and may be reduced if representatives of the ship pick up and return the materials. Packages may range from 100 chairs with four folding tables to one that offers a portable lectern with microphone, amplifiers with large speakers, canned music, 100 chairs, tables and a ceremonial platform. Reserve

these materials well in advance, preferably 30 days or more.

PRINCIPAL SPEAKER.—The principal speaker is generally nominated by the responsible naval base/station commander. *PA Regs* state that naval base/station commanders must forward nominations for prospective speakers to CHINFO for consideration.

Nominations must be submitted at least 90 days before the ceremony, preferably sooner, and should include a biography or background sketch of the nominee, a brief resume of his qualifications and the reason for the nomination. **Do not** inform a nominee that he is being "selected" as a principal speaker because the final selection is the prerogative of SECNAV.

A speaker should be nominated only after consideration of his speaking ability, importance as a public speaker, and most important, the support he can be expected to give to current Navy public affairs objectives. Nominations should include speakers from various occupational fields.

For further information, consult *PA Regs*, Chapter 4, the SECNAVINST 5030.1 series and the SECNAV-INST 5212.5 series regarding decommissioning. A sample decommissioning plan is included in Appendix VI of this manual.

Civilian Embarkation

Embarking civilians in Navy ships—be it a sailor's family on a one-day dependents' cruise or a community leader on a training exercise—is an excellent way to instill pride in sailors and further public awareness of the Navy and its mission.

Detailed information on civilian embarkation can be found in the OPNAVINST 5720.2 series, Embarkation in U.S. Naval Ships, and in *PA Regs*, Chapter 4. Each type of embark/guest cruise has a specific goal and requires different planning by the senior JO and the PAO to accomplish that goal. Some common rules include the following:

1. Guests must provide their own transportation to and from the ship, and they must reimburse the Navy for living and incidental expenses while embarked so the programs can be conducted at no cost to the government.
2. Guests must be informed of security restrictions. Unclassified photography should be allowed on board, because photographs renew feelings of identification with the ship. Guests must be advised of areas where photography is prohibited and security regulations will be courteously but firmly enforced.

3. Guests will be berthed with officers if staying overnight and normally will subsist in the wardroom (with the exception of Tiger Cruise guests). It is not necessary to assign guests individual rooms. They should be invited to dine at least once in each mess, if time allows. Guests should be encouraged to speak freely and to mingle with the crew. During Tiger Cruises, guests should be billeted and subsist with their sponsors, no matter what rank or grade.

4. Guests should be afforded the privileges of the ship's store and laundry. Ship's store privileges must be limited to purchasing items for immediate personal use (soap, shampoo, shaving cream, etc.).

5. Only emergency medical and dental care should be provided and only when civilian care is not conveniently available. When an injury occurs to a civilian aboard a Navy ship, the CO must notify CHINFO, the area coordinator and the operational commander(s) by message. The message must state what action has been taken. In case of an emergency not covered by Navy Regulations, facts and circumstances should be reported immediately to the SECNAV.

6. If funding allows, guests should be given a photograph of the ship as a souvenir. The CO may want to autograph the photo. A ship's ball cap makes a good lasting memento and makes guests feel like a member of the crew while they are aboard. The cost could be included in the fee charged for their staying aboard.

7. Publicity should be limited to that originated by the participant. Navy-sponsored publicity will be avoided unless requested by the guest. Media and public queries will be answered fully and should state the purpose of the cruise and the fact that it occurred at no cost to the government.

8. Helicopter transportation maybe authorized by numbered fleet commanders or type commanders for civilian guests and others whose embarkation is authorized. This authority must not be extended to include flights of convenience. Consideration should be given to age and physiological characteristics and special diet of the guests.

EMBARKING CIVILIAN WOMEN.— CO's must approve, must have appropriate berthing and must notify type commander or numbered fleet. Personal guests must be escorted by their sponsors.

Pregnant women up to 210 days gestation maybe embarked unless medically prohibited. A medical statement signed by a doctor stating the duration of the

pregnancy and fitness for embarkation must be submitted by the woman requesting the embarkation.

Women's organizations, including those whose memberships have a high percentage of persons with Navy affiliation, may be authorized for local daylight cruises or overnights by the appropriate fleet commander in chief.

Female entertainers may embark for local daylight cruises. Overnight embarkation requires the approval of the appropriate fleet commander in chief.

YOUTH GROUPS.— Some civilian youth groups, including NJROTC, Naval Sea Cadet Corps and national scouting program participants, are recognized by the CNO and may embark on Navy ships during underway periods as outlined in the OPNAVINST 5720.2 series. Requests for other youth groups to embark should be forwarded to the Commander, Navy Recruiting Command.

SECNAV Guest Cruise

A SECNAV Guest Cruise is a four-day program that allows top-level opinion leaders in business, industry, science, education and labor to see the Navy in action firsthand. It includes pierside or at-sea tours of surface ships, a pierside tour/embark on a nuclear submarine, observation of Marine and SEAL field activities and an underway, overnight visit to an aircraft carrier. These cruises are conducted at least three times a year, on alternate coasts. The ideal number of guests for each cruise is 12.

The intent of a SECNAV Guest Cruise is to increase the participant's level of understanding in the following areas:

- Navy operations
- Modern sea equipment
- High levels of responsibility and training required of Navy men and women

CHINFO is responsible for maintaining a list of probable guests, both male and female, nominated by area coordinators, high-level officials of the office of the SECNAV and others. To make the list, guests must not have any previous exposure to the Navy, defined as active or reserve service in the U.S. Navy or U.S. Marine Corps within the last 10 years or participation in a cruise on a U.S. Navy ship in the last 10 years.

If your ship is selected to host a SECNAV Guest Cruise, you and/or the PAO must forward a Guest Cruise

Itinerary Report, CHINFO Report 5723-1, as soon as possible to the appropriate fleet commander in chief (with copies to CHINFO, the area coordinator and the type commander). Note the following information in the report:

- Name of your ship
- Time and place the guests will embark, including specific information
- Estimated time of departure from port
- Destination and estimated time of arrival
- Ship's employment or other pertinent factors to include intermediate ports
- Number of billets available
- Name of CO, and flag or other officer senior to him, to be embarked
- PAO point of contact and ship telephone numbers
- Estimated cost to guest

Be sure to notify CHINFO when there is a change to the itinerary that would require the guests to remain aboard for longer periods than scheduled or involve an alternate port of debarkation. For further information, consult *PA Regs*, Chapter 4.

Tours

Tours of your ship go hand in hand with a sound community relations program. It is an opportunity for the ship to display Navy professionalism and for visitors to see what a U.S. Navy ship is like. Visiting a Navy ship is an enjoyable and educational experience and has great recruiting potential.

Barring extraordinary circumstances, your ship will be available for tours when it is in a foreign port of call or moored at its home port (usually on Saturdays, Sundays and holidays on a rotating basis as directed by the SOPA). Consequently, you have to provide the necessary tour guides to get the job done.

In some tour situations, for example, a VIP group with eight to 10 people, you can conduct the tour yourself or direct a member of your staff to conduct it. A staff member should be specially trained to do this. However, if your ship has been selected to provide tours for the civilian populace during an Armed Forces Day public visitation, the public affairs office staff cannot possibly handle the hundreds (possibly thousands) of

visitors that will come out to tour the ship. That is why you should develop a comprehensive visitation plan.

Visitation PLAN.— Input from all cognizant officers and special assistants to the CO should be sought before the visitation plan is devised. For example, obtain recommended traffic flow patterns from the security officer and ask the medical officer for recommended emergency medical procedures and services. The supply officer should be consulted regarding the availability of refreshments and the selection of authorized souvenirs for sale. Furthermore, you should liaison with the numerous other individuals responsible for making their equipment and spaces ready for public viewing.

The plan should also address the number of personnel each department provides for the tour(s), generally in proportion to the size of the department. Departments should provide knowledgeable, articulate tour guides who present an outstanding appearance and military bearing. Individuals who satisfy these prerequisites with public speaking experience should be specifically designated in the plan.

Include some provision for foul weather in the plan, including the number of indoor seats available (if applicable) and whether exhibits can be placed indoors.

It may take several planning sessions and many hours on the telephone to get your plan finalized, but the end result is well worth it: a notice (or instruction) that formally outlines the duties and responsibilities of all divisions/departments throughout the command on tour day.

WELCOME SIGN.— To minimize situations in which disruptions or civil rights violations may occur, post a sign at the head of the brow or on the quarterdeck, declaring the following:

“Welcome Aboard the USS *Sea Nettle*. As a guest of the commanding officer, you are encouraged to become familiar with your Navy, an indispensable component of the U.S. national defense team. While on board this installation, you are requested to observe the following rules:

(1) Political activities, such as pamphleteering, speeches, placard/banner displays, and so forth, are not appropriate and are not permitted. Demonstrations or protest activities are forbidden.

(2) Activities detrimental to loyalty, discipline, health, welfare, morale or readiness of the armed forces are not allowed. The commanding officer endeavors to be a gracious host. Your cooperation as

a guest is appreciated. Infraction of regulations may result in the withdrawal of the commanding officer's invitation and subsequent expulsion."

Notice that this sign referred to a visitor as "a guest of the commanding officer. . ." Be careful not to use the term "open house" in any of your signs or in press releases when describing public visitation. Open house implies unlimited public access and is no longer used.

TOUR ROUTE.— There are no specific guidelines or regulations regarding what you should show your visitors. Many ships will display the main deck, with a stop at the guns or missile launchers and then proceed to the bridge. Carriers normally feature a tour of the hangar bays, flight deck, forecastle and the navigational bridge. Regardless of the tour route agreed upon (and approved by the CO), be sure to keep security, safety and the crew's privacy in mind.

Warning signs should be erected to guard against unauthorized entry into certain areas or spaces, and arrows should be placed on the deck or in a conspicuous location on the bulkhead directing visitors along the tour route. Additionally, static displays and other items of interest along the tour route should be accompanied by a placard or a tour guide to explain its function.

TRAINING.— Once the directive is on the streets, it is time to train the tour guides. The method of training is entirely up to you, but consider using the following items to give your tour guide training program a boost:

- A video that shows the tour route, gives public speaking techniques, tour guide do's and don'ts, and so forth.
- A Personnel Qualification Standards (PQS) sign-off sheet that must be completed before becoming a "qualified" tour guide
- A short multiple choice exam covering the ship's history, equipment on the tour route, emergency procedures, what to do if a visitor becomes unruly, and so forth.

Do not forget to develop little "perks" that can be given to top performers, such as letters of appreciation, liberty passes, and the like.

Further information on conducting tours can be found in *PA Regs*, Chapter 4.

Financial Management

Cost consciousness and conservation are key factors in managing your public affairs office

operational target (OPTAR) funds. A sound financial management plan is necessary to ensure the achievement of the following objectives:

- Maximum benefit is derived from available funds.
- All unfunded requirements are of lesser urgency than requirements that have been funded.
- Funds are properly time-phased to meet operational schedule requirements.
- Prescribed stock levels are maintained.
- Funds are available to meet contingency requirements.
- Funds are programmed for routine replacement of equipage and consumable items.

As the manager of a shipboard public affairs office, you will be most concerned with consumable items (paper, pens, pencils, video tapes, and so forth). To determine your requirements, you should develop a good financial plan that will give you several distinct advantages:

- A system for reviewing all requirements, treating none as sacred and causing each to withstand close scrutiny
- A procedure for prioritizing all requirements and for assessing the impact of decrements (funding cuts) and increments (funding increases) as the expected funding limit is approached
- A formalized approach to the requirements review process, which helps ensure that truly essential needs are satisfied first
- A list of unfunded requirements from low priority items.

An annual financial plan is developed by first taking into consideration the principal evolutions scheduled for that year (CIBs, VIP tours, special events, etc.). Then first quarter requirements may receive a more detailed plan. The annual plan must be somewhat rigid, yet aggressive, if it is to meet its objectives. Requirements must be continually reviewed and the plan periodically updated to compensate for unforeseen or changing circumstances. As a minimum, the plan should receive a detailed review and update each quarter.

Once the plan has been formulated, a mechanism is needed for monitoring the execution of the plan. The departmental budget system provides this mechanism.

- I. Crew Communications
 - A. Credibility
 - 1. Essential to successful performance
 - 2. Gained by JOs fully integrating into ship's company; getting watch/warfare qualified, etc.
 - B. Bulletin Board
 - C. Ship's Newspaper
 - 1. Four printed pages; at least one "local" story per week
 - 2. No printed pages on Sunday
 - 3. Mostly international/national news from teletype; when teletype is taken over by operations, use short-wave radio to receive and transcribe news broadcasts from major networks
 - 4. Birth announcements
 - D. Radio/Television
 - 1. Enlist volunteers where appropriate
 - 2. Produce a live or taped 15-minute nightly news show
 - 3. Sell the CO on a televised Captain's Call
 - 4. Provide separate channels for movies and AFRTS programming (gives crew a choice)
- 11. Family Communications
 - A. Familygram
 - 1. Make sure it is the responsibility of the public affairs office, not the chaplain's office
 - 2. Delegate the writing of each divisional/departmental section (including photography) to the responsible department head
 - 3. Make sure plenty of fill names are in each input
 - 4. Avoid engagement announcements
 - 5. Use a program that prints next of kin labels for distribution
 - B. Ombudsman Program
 - 1. Interface before deploying
 - 2. Provide input for the wives support group newsletter and the telephone answering machine
 - 3. Arrange for ombudsmen to mail news clips from families
- III. Media Relations
 - A. Get ship's name before the public in as many media as often as possible
 - B. Use feature materials from ship's newspaper for release to external media (modify as necessary)
 - C. Make one release per week
- IV. Tours
 - A. Get everyone in the public affairs office "qualified" on how to conduct a tour
 - B. Fine-tune each presentation to the need, sophistication of the tour group; do not use the same statistics anecdoted for each group
 - C. Set tour route

Figure 1-17.—Shipboard public affairs office management outline.

- V. Media Visits/Pools
 - A. Know what reporters are looking for and make every effort to comply
 - B. Identify crew members who are articulate and enthusiastic about their jobs
 - C. Search constantly for new story angles and visual settings so stories do not get boring
 - D. Be a salesman and convince crew members to participate; once they see their picture or quote on television, they will be more willing to participate in the future; **get the story of the ship told**
 - E. Do not lock yourself into a plan; be willing to deviate from a plan no matter how good the plan is; remain flexible and you will get the best coverage
- VI. Other Publics
 - A. Memorabilia
 - 1. Send pictures, brochures, fact sheets and the like
 - 2. Avoid turning the public affairs office into a mail order house by handling ballcaps, cups and other cost items; the public affairs office is an information dissemination shop—no money should change hands
 - B. Cruisebook
 - 1. MWR should be in charge of sales; publisher in charge of distribution; public affairs office in charge of layout and design
 - 2. Cruisebook committees are too hard to formulate and run; do it yourself and retain control of the book
 - 3. Cruisebook is the **crew's book**— use plenty of large pictures with identifiable crew members
 - 4. Start a shipboard photo contest to get additional photos
 - C. Welcome Aboard Brochures
 - 1. Print in the foreign languages of the ports you are scheduled to visit
 - 2. Use metric measurements instead of U.S. measures
 - D. Port Guides
 - 1. Interview crew members with recent port experience to supplement regular sources of information (library, other ship's guides, etc.),
 - 2. Consult *Background Notes* for detailed information

Figure 1-17.—Shipboard public affairs office management outline—Continued.

In this regard, timely information from the supply officer is needed to permit proper monitoring. However, either you or the PAO must report and justify major deviations from the plan for it to remain a current practical management and control mechanism.

Additional tips in shipboard public affairs office management can be found in the outline in figure 1-17.

COMMUNICATING WITH THE CO

Learning Objective: *Identify the methods of advising the CO on public affairs matters.*

The importance of keeping the CO informed on public affairs matters is immeasurable. *PA Regs* specifies that COs will “ensure that the PAO has direct

access to the officer in command. . .” for this very reason.

Depending on the circumstances, the PAO may brief the CO several times daily, either through correspondence or verbally, so he is not caught off guard by significant public affairs developments, or routine matters that have the potential to become areas of concern.

When the PAO is unavailable for one reason or another, the senior JO must assume the role as the primary public affairs briefer. Feeling a bit intimidated and nervous about briefing the skipper is normal, but if your information is accurate and complete (also known as having your “ducks in a row”), these reactions can be overcome quickly. With this peace of mind, all you really need to do is focus on the method in which you deliver the information.

Each CO will have a preference for the way you communicate with him. Some will prefer face-to-face meetings, while others will accept a simple one page memorandum when the particular public affairs topic is not urgent in nature. With meetings, inspections and tours of spaces (among many other responsibilities) occupying the skipper’s precious time, addressing the topic in memorandum form will allow the CO to review it at his convenience. It will also provide you with a means of further documenting the topic.

If the memorandum system is used, be brief and to the point. However, as previously stated, make sure your information is thorough and precise. **Remember your credibility!** Structure the memorandum in an inverted pyramid format so the CO gets the “meat and potatoes” of the issue up front.

After the topic is addressed, give the CO at least three recommendations for courses of action (when applicable), and the pros and cons of each action. If all goes according to plan, the CO will circle his choice, add any additional comments and return the memorandum to you. The CO is now adequately apprised of the situation and you have his endorsement to take the appropriate action. **Be sure other staff members are also informed as appropriate.**

If the CO favors memoranda over direct briefings, a personal visit should be made only when you must brief him on urgent or time critical public affairs matters. The visit should follow the same format as the memorandum system previously discussed. Be aware that the CO may become distracted by telephone calls and incoming messages during your briefing, so be sure

your message is understood, even if you must repeat yourself.

MICROCOMPUTERS

Learning Objective: Recognize the importance of microcomputers in public affairs office management and identify the main computer components.

Typewriters, “white-out” and carbon paper are as out of place in a public affairs office as eight-track tapes and records are in a radio studio. The Navy is firmly entrenched in the microcomputer age, and as the public affairs office manager, you will be using this technology for everything from word processing to desktop publishing.

The intention of this section is to familiarize you with the main components of a microcomputer— not to make you a microcomputer expert overnight. For further information on microcomputers, refer to the Data Processing Technician Second Class training manual, Chapter 6.

HISTORY

Microcomputers designed for personal use arrived on the scene in the mid 1970s. The Altair 8800 was one of the first available models, but it was a kit designed mainly for electronics hobbyists. In a short time, models manufactured by Atari, Apple, Commodore and Tandy (Radio Shack) made computers available to the mainstream consumer, and the dawning of the microcomputer age was under way.

IBM was late in entering the computer race, introducing its first personal computer in the fall of 1981. However, in a short period of time, the company firmly established its leadership in the field, leading to a virtual explosion of IBM clones that now saturate the microcomputer market.

CENTRAL PROCESSING UNIT (CPU)

The CPU or system unit is the heart of the total microcomputer system. Inside this unit all data is processed, arithmetic and logic functions are performed and control is maintained for the system. If you were to remove the outer cover from this unit (fig. 1-18), you would see a power supply and as many as two floppy disk drives and two hard disk drives, or any combination thereof depending upon the particular configuration of the system. You would also see several boards, also referred to as cards. Some boards are used to control the peripheral devices of the system, while other boards

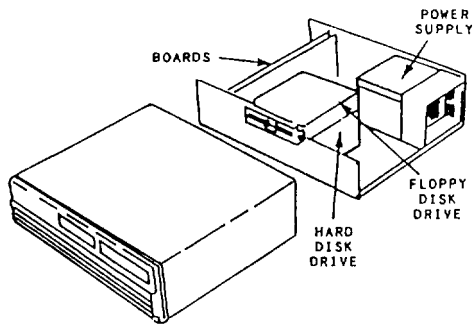

Figure 1-18.—Microcomputer's system unit with cover removed.

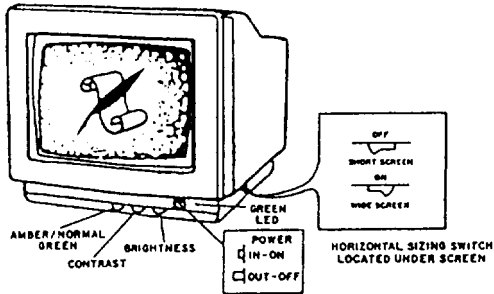

Figure 1-19.—Monitor controls, switches and indicators.

work in conjunction with the microprocessor located on the system or motherboard itself. These boards provide the flexibility to add a variety of capabilities to a basic system. Certain boards are required, such as the system board that contains the main microprocessor(s). Others you might add to control a light pen or a mouse device or to handle a communications interface.

MONITOR

The monitor, also known as the screen, display, display device and cathode-ray tube (CRT), is the principal link between you and the microcomputer

(fig. 1-19). Its sole purpose is to allow the microcomputer to communicate its actions to you, the user, so that you can act upon those actions to accomplish whatever job you are doing. Monitors can display information in either monochrome or color, depending on their design. Monochrome displays produce output images using a single foreground color, such as black, and a single background color, such as white. This provides you with black text on a white background. Monochrome displays also come in amber and green. Amber and green are considered more pleasing and less stressful to the eyes.

Most color monitors are of the red-green-blue (RGB) type. Depending upon the sophistication of the display device and the amount of RAM (random access memory) available with the microcomputer, you may be able to display from eight to 16,000,000 colors.

Brightness and contrast adjustment dials are usually located on the front of the monitor. Some monitors come with a sizing feature that allows you to increase or decrease the physical size (the height and width) of the displayed information. Monochrome monitors may be equipped with an amber/normal/green dial. With it, you may select any one of the three positions to give you that specific color.

KEYBOARD

Of all the components that make up a microcomputer, you will become most familiar with the keyboard (fig. 1-20). It will probably be your main means for inputting programs and data on microcomputers.

Keyboards come in many shapes and sizes, have different numbers and arrangements of keys, differ in respect to touch and have special keys to allow you to communicate specific software commands. Most manufacturers have designed their keyboards as

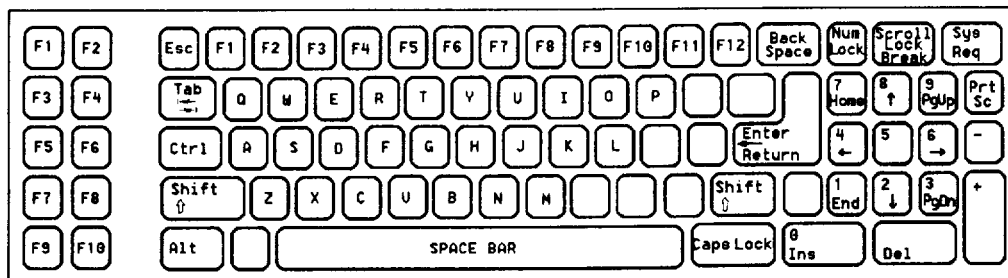

Figure 1-20.—Microcomputer keyboard.

separate devices so you can place them wherever it is convenient (even in your lap).

You will be most concerned with the types of keys on the keyboard and the function and placement of each. All keyboards have the alphabetic characters (upper and lower case), numbers and some special characters. In addition, keyboards have special function and control keys that are defined by the operating system or the program.

MAGNETIC DISKS

The two forms of magnetic disks typically used with microcomputers are the diskette and the hard disk. Magnetic disks, regardless of their type or size, are without a doubt the most important secondary storage medium used with microcomputers. Disks provide fast retrieval of information. The physical characteristics of the disk—flat and round—allow the disk drive direct access to data. Simply stated, the processing unit goes directly to a designated disk drive, seeks the specific location on the disk where the data is stored and immediately retrieves it. The disk drive does NOT have to read through a series of records before reaching the one desired, as with magnetic tape units.

Diskette

A diskette is also referred to as a floppy disk, or just plain floppy, because it is a round, flexible platter. At present, diskettes come in three sizes (diameters)—8 inches, 5 1/4 (5.25) inches and 3 1/2 (3.50) inches (fig. 1-21). The 8-inch variety is seldom used with microcomputers these days, but the 5 1/4 and 3 1/2-inch formats are common. The diskette is the media used to either store your data or to back up data on your hard drive.

The notch on the side of the 5 1/4-inch diskette is the write protect feature. Placing a label provided with

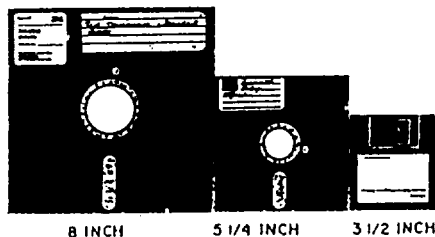

Figure 1-21.—Floppy disks/diskettes used on microcomputers.

the diskette over the notch can protect the data on a disk. On 3 1/2-inch diskettes, the write protect feature is in the form of a moveable tab at the bottom right side. Sliding this tab down will activate this feature.

Care of your diskettes is important because even the slightest bit of damage can cause a loss of your data. The following is a list of rules for taking care of your diskettes:

1. Do not bend or fold the diskette. The diskette drive only accepts a diskette that is absolutely flat.
2. Do not touch the exposed areas of the diskette.
3. Store all diskettes in their jackets to protect them from dust and dirt.
4. Diskettes are sensitive to pressure. When you label them, use a soft felt-tip marker to write on the label. Do not use a pen or pencil, as these can cause damage to the diskette and to the information contained on it. Do not put paper clips on the diskette.
5. Do not stack labels one on top of the other on a diskette. It may cause problems when you insert the diskette into the drive.
6. Do not leave your diskette on or near anything that generates a magnetic field, or a loss or scrambling of data will result. This includes magnets of any kind, such as those found in telephones, stereo speakers and paper clip dispensers, as well as magnets on copyholders and inside printers. Also avoid motors, such as those found in portable fans and floor buffers/polishers.
7. Keep diskettes away from extreme heat, cold and humidity, or they may warp. Diskettes are designed to withstand temperatures from 50 to 125 degrees Fahrenheit (10 to 52 degrees Celsius), and a relative humidity of eight to 80 percent. Temperatures and humidities in which you are comfortable will also be comfortable for diskettes.

Hard Disk

Although most microcomputer systems you will be working on use some type of floppy disk drive, you should also be aware that many microcomputers also contain a small sealed unit called a Winchester disk or hard disk drive (fig. 1-22). Unless the hard disk drive is an external type unit, you might never know it was there.

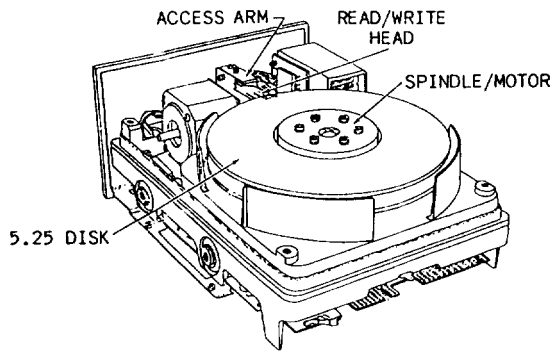

Figure 1-22.—Internal hard disk drive mounted on disk drive chassis.

Floppy disk drives are easy to spot because all you have to look for is the door of the drive—the open slot in which you insert the diskette. But hard disk drives are normally sealed units that can be tucked away inside the system unit.

Why are hard disks so popular? Hard disk drives provide you with many time-saving features not available or possible with the traditional floppy disk drives. These include increased access speeds, greater storage capacity (up to 500 megabytes [MB] of storage) and overall convenience. Regardless of whether your microcomputer has a hard disk drive housed within the system unit or external to it, you need not bother having to search through file boxes filled with diskettes. Working with a hard disk is much easier because you can quickly end one program and start another, all through the operating system. There is no need to manually open, close, file away or find anything. There is no more time-consuming initialization or rebooting (system restart) from the floppy disk drive, which involves finding and loading a program diskette, finding and loading the applications diskette and finally getting down to work.

Hard disk units consist of rigid metal platters that are tiered or stacked. In most cases, the disks themselves are not removable, and for this reason, they can be hermetically sealed in the storage unit along with the access mechanism that contains the read-write heads. Because this type of disk drive is completely sealed and free from air contamination, the read-write heads can be positioned to within 20 millionths of an inch from the surface of the disk. This also allows the disk to be rotated at a high rate of speed—typically, 3600 revolutions per minute. Hard disks come in the same sizes as floppy disks, with 3 1/2 inches being the most popular because

the read-write heads have shorter distances to move. Hard disk storage capacities range from five to 500 megabytes, with the majority in the 20 to 120 megabyte range.

PRINTERS

Most printers you are likely to use while working on microcomputers are the low-speed varieties. They are able to print text at rates of 200 to 800 characters per second and usually output this information one character at a time. After close examination, you will find that basically the only major difference between printers designed for microcomputers and those used on larger mainframe systems is their size and the speed at which they print. Other than that, they are much alike in terms of setup, operation and operational features.

Low-speed printers, like high-speed printers, are either impact or nonimpact. At least six printing technologies are used to produce hundreds of microcomputer printer models. These technologies include daisy-wheel (which prints solid characters), dot matrix (which forms characters using a series of dots), xerographic, electrostatic, electrosensitive, electrothermal, ink jet and laser.

Many low-speed printers can print subscripts and superscripts, print in several different colors, print graphic material and output text in several different fonts. Either a friction feed (for handling single sheets of paper) or an adjustable tractor feed (for handling continuous forms) are standard on these printers. Some even have both.

SOFTWARE

Depending on the needs of the users, the software will vary from command to command. Journalists will become most familiar with one of several word processing software packages available on the market.

Disk Operating System (DOS)

Regardless of your word processing software of choice, you will need a disk operating system (DOS) to make it work. DOS will be the first program you need to know and understand because you must install it before you install other programs. DOS manages the operation of the system.

If your system has a hard disk, you will install DOS onto it. The first step will be to partition the hard disk; that is, identify the hard disk to DOS and create a partition for DOS. Next, you will format the hard

disk—preparing it so it can be used. Then, copy the DOS files from the distribution disks onto the hard disk. You must follow the steps in the owner/user manual. It may tell you to use a setup command that leads through the process from the display screen. Once installed, DOS will load from this partition every time you turn on the system.

If the system has only floppy disk drives, you will make copies of the distribution disks onto new diskettes. If the new diskettes are not formatted, you can use a command (such as DISKCOPY) that will format and copy. Again, follow the instructions from the start-up or getting started section of the owner/user manual. If there is a setup command, use it to lead you through the process. Be sure to prepare external labels with the name of the DOS. Write the serial number if there is one, and write WORKING COPY. Be sure you use a felt-tip pen if you are writing on a label already attached to the diskette.

Once you have copied and installed DOS, put the original distribution disks in a safe place. Now you are ready to use the microcomputer, but you may need more than DOS. DOS has many useful commands like COPY, DELETE, UNDELETE, FORMAT, BACKUP, and so forth. It will even have an editor, usually a line editor, that allows you to create files and edit them line by line. However, its primary jobs are to manage the system and its resources (disks, printers, and so on) and to help you communicate with the computer to use other programs (application software).

User/Applications Software

When installing a user/application software package on a system, you need to provide the software with information about your microcomputer configuration. Because there are so many different software packages and programs available and each one has different requirements, there is no need to go into great detail here. Remember, refer to the documentation—it should provide what you need to know. Many of the manuals lead you through step by step.

Backing Up Distribution (Original/Master) Diskettes

The first thing you should do is copy the files from the distribution diskettes. Each software package may have several diskettes. If you have a hard drive system, you may copy the files from the distribution diskettes to the hard drive, using the copy command in the operating system. First, set up the name of the directory in which

you want to store the files. Then copy them to the hard disk. If your system has no hard drive, copy the files to other diskettes. Most operating systems have a copy command that allows you to copy all files on a diskette with a single command. This is called a wild card copy. The copies will become your working copies. Prepare external labels for the working copies. Store the distribution diskettes in a safe place away from the microcomputer in case you need them in the future.

BACKING UP TEXT/DATA FILES

In addition to making backup copies of your distribution diskettes, be sure to backup your text/data files (correspondence, releases, etc.) on diskettes as well. If you lose all or part of your data, the only person to blame is yourself.

Data can be lost or damaged in a number of ways. Common causes of data loss are power surges and drops, power failures, hard drive malfunctions and user errors. User errors top the list. Although less common, fire, theft, vandalism and natural disasters are potentially disastrous.

How often have you come close to erasing a file or formatting a floppy or hard disk by accident? Probably more times than you care to admit. No matter how many precautions you take, you cannot prevent all the potential ways data can be lost. You can certainly reduce their adverse effects by backing up your files on a regular basis.

When working with data files, at least back them up on a daily basis either to tape, diskette or to another hard disk.

No matter how many backups you make (two, three or one for every day of the week) or what method you use to make them, they are worthless if they are destroyed along with your microcomputer. You need to make multiple backups and store a set in a different area away from your working area or at a minimum in a data safe. This will require some extra effort, but it will more than pay for itself should you ever experience a data loss.

LOCAL-AREA NETWORKS (LANs)

The microcomputer has put the power of mainframe computing onto your desktop via local-area networks (LANs). LANs consist of nodes that are interconnected by links. These nodes and links usually cover a relatively small geographical area, ranging from a few feet to a mile. Nodes are the hardware, such as computers, terminals, hard disks, printers, and so on. Links are the

communications media, such as twisted-pair wire, coaxial cable or fiberoptic cable that connects the nodes.

A LAN gives you the capability of transferring data, files, programs, and so on, from one PC to another or even from one LAN to another. You can transfer a report or listing to any printer you desire on the network. By connecting your PC into a LAN system, you can execute application programs stored on the server's hard disk without having to worry about disk space or keeping track of diskettes. You can exchange files and programs with other users directly without copying them onto a diskette.

Further information regarding LANs can be found in the Data Processing Technician Second Class manual.

CONCLUSION

Managing a public affairs office is an undertaking that requires thorough planning, personnel training and an in-depth knowledge of the public affairs field.

Although there are many qualities a senior JO must have, self-reliance certainly ranks as one of the most important if he is to be the office manager and trusted assistant to the PAO. Why place so much emphasis on self-reliance? There are numerous situations in which you will find yourself on your own. When a problem

arises, you have to solve it by yourself. You will not have the time to seek the advise or approval of the PAO or some other officer. You will have to make your own decisions, relying entirely on your own judgment. A self-reliant JO is one who can adapt himself to any situation. If unforeseen circumstances develop, you must use your own initiative and imagination to get the job done.

Armed with a knowledge of the tools of communication and of the public affairs problems of the command, and using a large measure of common sense in concert with the management techniques discussed in this chapter, you should be able to administer a public affairs office in a professional manner. Insist that every project and piece of correspondence that leaves the office be professional in content and appearance. That means letter-perfect copy, professionally assembled project folders, news clips that are professionally mounted and identified and, of course, high-quality news releases and photographs. Output is judged by the media, by the officer in command and his staff and by other professionals on the quality of what public affairs personnel produce and not on what they say they can produce. Professional standards are hard to maintain, but they are essential in maintaining the professional integrity of an office.

CHAPTER 2

PUBLIC AFFAIRS IN ADVERSE NEWS SITUATIONS

The Navy is without a doubt a news maker, and with little question the news it makes is sometimes adverse in nature. When a fire rages aboard an aircraft carrier and there are mounting casualties or when a recruit dies of injuries received during training, the PAO and senior journalist find themselves in the middle of a news story. These news incidents contain the elements of a good news story—immediacy, consequence, drama, conflict and emotion. People are interested in these stories and may often be directly affected by them.

The events that affect the Navy and its personnel are generally matters the public has an inherent right to know, whether the news is good or bad. Principally, this right can be abridged in very few cases if security is involved. The fact that bad news is embarrassing does not mean we should not release it, because this fact does not curtail the public's right to know. The stories concerning this nation's military establishment and the lives and welfare of U.S. fighting forces must be told.

Another reason to tell these stories is a purely practical one in that bad news cannot be suppressed. Attempts to hide bad news make the Navy look dishonest because guesswork is stimulated. This is often worse than the truth and the agony is prolonged. Any refusal by the Navy to cooperate with the news media, for whatever reason, causes speculation, rumor and conjecture to replace the truth and facts of a situation. This is especially true in an emergency where things are confusing anyway.

Even though there are effective methods of coping with the public affairs problems that accompany nearly every accident, public affairs personnel often make mistakes in handling the news aspects of disasters.

Naturally, no two bad news situations are identical, but public affairs practitioners can apply certain principles in releasing information to the public. Therefore, this chapter provides guidance to the senior journalist to successfully handle public affairs in major peacetime naval (and increasingly joint) disaster situations.

POLICY GUIDANCE FOR DISASTERS

Learning Objective: Detail the basic disaster policy guidance of the DoD and Navy.

The DoD formulates all basic policy regarding the release of disaster information by the armed services. The individual services, in turn, disseminate their own policy instructions according to the basic DoD directives. Neither the DoD nor any of the other armed services issues a master disaster plan. Since the military services, individually and collectively, are subject to the many types of natural and man-made disasters, the lack of a master plan is understandable. The Atomic Energy Commission and NASA, for instance, operate in limited areas of specialized activities with predictable accident situations. The Navy can, by the same token, anticipate certain disasters peculiar to specialized operations. Individual naval commands, bases, installations, fleets, and so forth, reissue policy guidance best suited to their individual needs and circumstances based on these basic service guides.

Several basic DoD directives exist on individual service guidance in the area of disaster information. Implementation instructions are contained in *PA Regs.*

DEFINITION OF DISASTERS

Learning Objective: Identify and define the different types of disasters.

The concept of disaster varies with the kind and degree of involvement of the persons or groups concerned. The word *disaster* signifies one thing to the family or community involved, another to disaster research science and still something else to the governmental agency or voluntary relief organization charged with relief and rehabilitation measures. Webster defines disaster as "a sudden and extraordinary misfortune; a calamity." One sophisticated definition states that disaster is "a disruption in the normal flow of energy that is uncontrolled."

Disasters, regardless of how or by whom defined, have certain common attributes. They include injury, suffering or death for several people and damage or destruction to possessions and property. According to

their origins, peacetime disasters are of two main types: natural and man-made.

There is no official military definition for military or naval disasters. However, any definition of peacetime naval disasters would only differ from those previously listed in the application of terms to naval personnel, equipment or installations. In terms of this chapter, remember that naval disasters differ in the scope of public interest and concern. A naval disaster in any locale provokes the interest of the entire country since Navy personnel come from all corners of the United States. A Navy ship involved in a collision, for instance, may very well have representatives from all 50 states in its crew.

DESCRIPTIVE DIFFERENCES

In addition to the two general classes of disasters, natural and man-made, there are other descriptive differences that are helpful to consider.

Disasters differ in the following ways:

- Degree of predictability
- Degree of probability
- Degree of controllability
- Nature of the precipitating agent
- Origin
- Speed of onset
- Scope
- Destructive effects on people and physical objects

CATEGORIZING DISASTERS

There is no commonly accepted way of categorizing disasters beyond the two previously mentioned divisions. For operational purposes, however, the Red Cross recognizes the following types:

- Hurricanes
- Tornadoes
- Other windstorms
- Floods
- All other storms (hailstorms, snowstorms, etc.)

- Explosions
- Fires
- Wrecks (train, ship, airplane, etc.)

LESSONS LEARNED FROM PAST DISASTERS

Learning Objective: Analyze the public affairs lessons learned from specific past naval/natural disasters.

It is helpful to detail successes in the handling of public affairs in past naval/natural disasters. It is probably more important, however, to scrutinize the things that could have been done better. This section does both.

The gauge of success or failure is difficult to measure. In the Navy, success is competence in carrying out the assigned mission, performing according to rank or rate and responsibility, reflecting one's own personal experience and upholding and maintaining the traditions of the naval service.

Contemplating a major disaster is not a pleasant task. The Navy's operational forces have learned that constant training to meet a national emergency, peace-keeping action or disaster situation have paid handsome dividends when the real event occurred. The public affairs staff must be ready when a disaster strikes. A disaster plan is meaningless if the public affairs staff is unfamiliar with it or cannot put it into operation. All concerned should have a thorough knowledge of the disaster plan and be able to put it into effect. Each individual should know his duties and responsibilities, such as where he goes, what he may be expected to do, and his own particular part in the overall public affairs operation. It would be useful for the public affairs staff to run drills during off-duty hours to determine how long it would take to man the office fully in a disaster situation. You should periodically put the disaster plan in full operation to find out how long it takes to get out a news release, radio tape or videotape.

The following disaster cases were originally published in the *Public Affairs Communicator*. More detailed case studies on these and other disasters are available from the CHINFO Plans and Policy Division.

USS IOWA

Lt. Russ Greer (CINCLANTFLT PAO) details the public affairs response to the USS *Iowa* tragedy in 1989 as follows:

The explosion and fire that killed 47 sailors aboard the USS *Iowa* (BB 61) (fig. 2-1) on the morning of April 19, 1989, produced a classic crisis for Navy public affairs.

In the confusion of the first reports, there was immense pressure from the media, the public and Congress to learn the names of the dead and injured. Next came the return of the ship itself. A memorial service followed, attended by President Bush, and then the investigation began with extensive speculation

in the media about the cause of the tragedy.

For public affairs professionals, the pattern of the crisis has become all too familiar in recent years with the USS *Stark*, USS *Samuel B. Roberts*, USS *Bonefish* and USS *Vincennes* incidents providing textbook paradigms.

The lessons learned from the USS *Iowa* disaster include the following:

- Have a **written public affairs emergency reaction plan** and practice it. The plan should deal chiefly with the physical tools you need to handle a crisis, such as telephones, extra personnel, transportation, communications, and so forth.

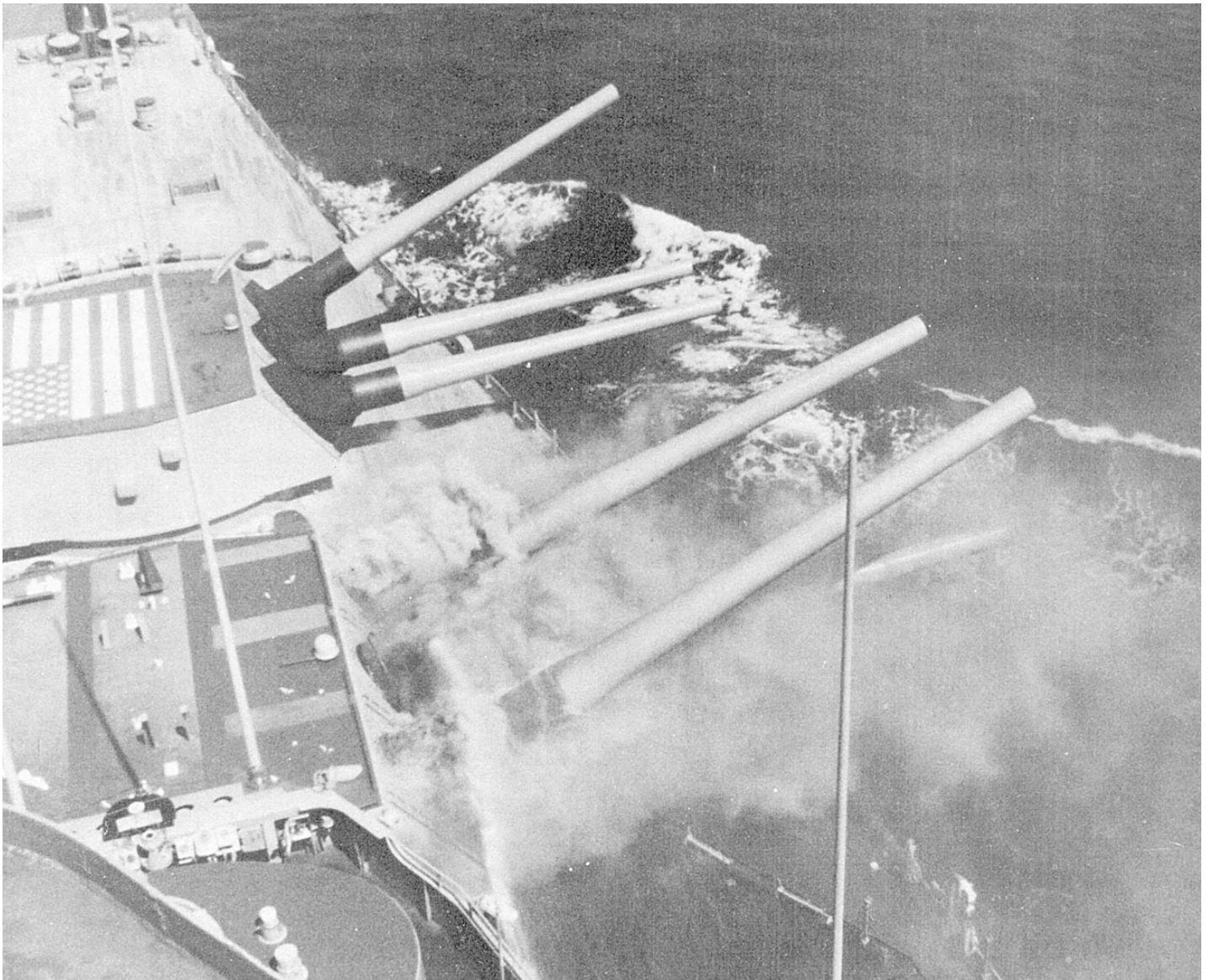

174.131
Figure 2-1.—USS *Iowa* (BB 61) explosion and fire, April 19, 1989. (Official U.S. Navy photograph by Lt. Thomas Jarrell)

Identify a command information bureau (CIB) site ahead of time. More than 600 media, including the White House press corps, gathered in Norfolk to cover the *Iowa's* story on short notice. The logistics alone of transporting that many people is staggering, even with time for planning.

- Early in the crisis, **identify a clear chain of command**, make specific personal assignments (media officer, administration officer, drivers, etc.) and create planning groups for specific events, such as *Iowa's* return and the memorial service. Let these groups focus ahead on the details for the events while the key decision makers remain free.

- **Identify goals immediately.** In Norfolk, *Iowa's* home port, there were two key Atlantic Fleet public affairs goals: to inform the families and protect them from unwanted media intrusion and to accommodate the overwhelming media interest in the explosion, the ship and the families.

- **Know how to communicate with the Navy families.** The Norfolk Family Services Center and Commander, Naval Base Norfolk, activated their crisis response plan immediately after the explosion and offered a central gathering place for families at the Norfolk Naval Base gymnasium for counseling and information. Unfortunately, the **mechanism for getting information to the families** before they see it in the media is weak. Family members who are confused or scattered away from fleet locations or perhaps do not trust or understand the Navy follow news reports for the latest information. Official information is filtered in the media and mixed with speculation, misinformation and inaccuracies.

There is no way to solve this problem completely. Improvements can be made in the flow of information between fleet commands and the ombudsman and family services center, but the media will always play a key internal information role. It becomes especially important in these crises to **get the most complete and accurate facts as quickly as possible to the news media** and to correct wrong stories as they appear. This implies continual monitoring of coverage.

Carefully plan the physical arrangements for the media at event sites and methods to keep the media informed. When you make an honest attempt to bring the story to the media, it reduces

speculation. **An official spokesman must be established as the best source of breaking news.** If the press has the available facts, they are less likely to speculate, to go to "think tank experts" and to hound the families. The first information about the explosion was released to the press almost immediately in Norfolk. The Atlantic Fleet sent a public affairs assistance team to the Roosevelt Roads Naval Base in Puerto Rico within six hours of the explosion and conducted a media availability with the 2nd Fleet Commander, Vice Adm. Jerry Johnson, in Puerto Rico less than 24 hours after the explosion. The draw of the press conference permitted the ship to remain relatively undisturbed off Roosevelt Roads while the remains were transferred ashore by helicopter. The media were then taken to the flight line to observe the flag-draped caskets being escorted aboard a C-5 by an honor guard.

It took *Iowa* five days to return to Norfolk after the explosion. The CIB arranged a media availability aboard *Iowa's* sister ship, the battleship USS *Wisconsin* (BB 64), to give reporters an opportunity to see the turret where the fire and explosion occurred. This also enabled the media to talk to battleship sailors about the routine operation of the gun for perspective and background.

On the day of the *Iowa's* return, approximately 500 media were roped into an area at the end of the pier, photographing the grim arrival from flatbed trucks without interfering with the homecoming.

At the memorial service the next day, the presence of the White House press corps swelled the total number of media attending to more than 600, in an aircraft hangar already crowded with more than 5,000 people. Bleachers in the hangar, careful selection of pool locations for cutaways and separation of the media from the crew and more than 100 family members helped give the crew members and families privacy, while giving the press as many opportunities as possible to cover the ceremony.

Most of the needs of the media and the needs of the families were met during the *Iowa* crisis, but there is always room for improvement. The reality of the *Iowa* crisis is that any command, anywhere in the world, can be forced to deal with a similar crisis without notice. The biggest lesson learned is that no one can plan or train enough for that day.

USS MIDWAY

Lt. j.g. Rich Chao, the PAO of the USS *Midway* (CV 41), chronicles the public affairs aspects of the ship's 1990 fire as follows:

June 20, 1990, was a day I had to juggle feathers in a sudden storm. Two explosions and a fire occurred while the USS *Midway* (fig. 2-2) conducted routine flight operations approximately 125 nautical miles northeast of Yokosuka, Japan. Three crew members died and eight others were seriously injured in the line of duty. All 11 crewmen belonged to an elite fire-fighting team known as the "Flying Squad."

It was not planned as a soporific day for the *Midway* public affairs staff anyway. After weeks of coordination, we spent the morning double-checking the details of an important VIP embark that included a senior Japanese Defense Agency official and a Japanese vice admiral. A 1MC announcement preceded by rapid bells broke my train of thought.

"Smoke, smoke, smoke. . . I have a report of white smoke in compartment . . . away the Flying Squad away," came across the 1MC. JO1 Brady Bautch began logging a sequence of events as we always do for all damage control announcements. A similar scenario happened during a previous media embark and we expected everything would



174.132

Figure 2-2.—USS *Midway* (CV 41). (Official U.S. Navy photograph by PH2 Rodney C. Orallo)

return to normal before the VIPs arrived, like the last time, The next series of 1MC announcements shattered that wish.

“All repair division and damage control personnel not on watch muster abreast elevator two,” announced the 1MC. Everyone in the public affairs office froze and strained to catch every word.

“Medical emergency, medical emergency in compartment. . . away the medical team away,” shouted the 1MC. “All engineering personnel not on watch muster abreast elevator two.”

Right away, the butterfly in my stomach stood up. My gut feeling told me something was wrong, very wrong or else damage control central would not muster all engineering personnel. JO3 Greg Traweek, who was working on the mess decks, burst into the office and reported an explosion. Bautch immediately called up the prepared adverse news release format in the computer.

I decided to gather first-hand information. Unable to reach the scene of the explosion because of fire boundaries, I went aft toward the medical department. Before reaching medical, I found the aft mess deck lined with burned crewmen and corpsmen racing to attend the injured.

I knew I had to take quick decisive action. Remembering my *PA Regs* training, I had one hour to send the initial press release. I realized the clock was ticking and the VIPs were still inbound.

The C-23 carrying the VIPs escorted by Cmdr. Mark Stun, the Commander Naval Forces Japan PAO, landed. Receiving the VIPs and improvising a new plan for them in flag country diverted my attention. The initial press release was still waiting for me.

The *Midway* public affairs staff pieced together the first press release from various sources. JOC Jim O’Leary phoned in after talking to damage control personnel near the scene. Traweek relayed the status of the injured from the aft mess deck. I located *Midway’s* position in relation to Yokosuka from the flag watch officer and Bautch strung all the pieces together.

The crisis management marathon was just beginning. As soon as the initial press release was out, Bautch and I began preparing for the follow-up releases. We wanted to determine the number of injured and the status of the fire. But again, the VIPs

onboard prevented me from concentrating on the press release.

While the office was buzzing with activity, O’Leary directed JO3 Kevin Stephens and JOSN Lee Gobin to videotape the mass casualties on the mess deck, the medical evacuation of injured crewmen and the transport of deceased crew members to a helicopter. The footage was used by *Navy News This Week* and will also be used as a training aid for Navy medical personnel.

Bautch and I continued to hunt down new information for follow-up releases. By this time, we learned to compare notes with the intelligence officers who were writing the OPREP-3s. Bautch also established direct contact with the chief engineer and damage control assistant to streamline information gathering. In between follow-up releases, we drafted the opening statement and composed a list of questions and answers for the media availability.

About 10:30 a.m. the second day, Cdr. Mark Newhart, the Seventh Fleet PAO, arrived by helicopter about four hours before the ship returned to Yokosuka. The task at hand was to organize the media availability.

When *Midway* entered Yokosuka Harbor, 12 Japanese media helicopters flew in circles and hovered about 150 feet above the flight deck. Three bus loads of reporters were waiting on the pier. About 30 minutes after *Midway* cast its first line, more than 100 international print and electronic journalists charged over the brow to cover the media availability of COMCARGRUFIVE and the CO.

A major challenge for the PAO handling an emergency is getting accurate information quickly. Rumors abound amid confusion. I always gathered or double-checked information with the experts. The PAO onboard an aircraft carrier is like a reporter in a city under an airport. The fire department and hospital will not call the reporter in an emergency. The reporter has to go to the fire department and hospital. While being the inquisitive reporter, I also thought about how to gather the facts without impeding the fire-fighting and lifesaving activities.

Another major challenge was running press releases up and down the chop chain in a timely fashion. The geographic separation between the bridge (CO and XO) and flag country (admiral and chief of staff) made this process time consuming. The highly perishable information quickly becomes

dated when events unfold quickly; as time went on, the chop chain grew longer as more people demanded to have a chop.

I strongly urge all PAOs to know your ship, the key players on your ship and other PAOs in the area. Most important, know how to optimize your staff or else no one will help you “juggle the feathers in a sudden storm.”

The things that went well included the following:

- We gained instant credibility by inviting the media on board for a highly effective media availability within 30 minutes of returning to Yokosuka.

- The prepared adverse news release format was entered in the computer before getting under way.

- An accurate sequence of events was kept and double-checked against the damage control central log before it was included in the press kit.

- We had enough command “welcome aboard” pamphlets, 5- by 7-inch black-and-white photos of the ship, biographies and pictures of the CO and embarked admiral for the press kits.

- After the initial confusion, we maintained a close, working relationship with the intelligence officers who wrote OPREP-3s.

- We recorded almost two hours of raw video footage. Video footage of the damaged spaces was used by two investigative boards and the Naval Investigative Service. The footage of the mass casualties and Medevac was used by “Navy News This Week” and will be used by medical personnel for training.

- Damage control diagrams that highlight the damaged spaces and their locations were reproduced for visual presentation. The large diagrams were displayed on an easel and copies were included in the press kits.

- A Japanese interpreter from COMNAV-FORJAPAN enhanced communications at the bilingual media availability.

- All casualties were flown off the ship before arrival in Yokosuka.

The lessons learned from the USS *Midway* disaster included the following:

- Make sure all press releases are sent via OP-Immediate.

- Make sure the XO, CO, chief of staff of the embarked flag staff and admiral approve the message.

- Make sure press releases are not sent before the OPREP-3s.

- Include only biographies of the speakers at the media availability in the press kits.

- Establish contacts and good relations with operations and intelligence personnel before an incident takes place.

HURRICANE HUGO

Lt. Cmdr. John Tull of the Navy Office of Information (NAVINFO) New England gives the following account of the public affairs actions taken after Hurricane Hugo:

“Hugo Who?” is a popular expression in Charleston, South Carolina, now that recovery and restoration efforts are gradually reestablishing normal lifestyles, but make no mistake about it: During the night of September 21, 1989, and extending into the early morning hours of September 22, Hurricane Hugo had the undivided attention a Category Five hurricane demands.

For the Navy in Charleston, Hugo's impact was described as “devastating,” which in terms of facilities, equipment and water damage—initially estimated at \$250 million—it was. However, it could have been far worse in terms of loss of life and injuries. Fortunately, no fatalities or serious injuries involving active-duty forces or their families occurred during the storm.

On the public affairs front, response to Hugo-related needs provided some valuable learning experiences for PAOs. From those experiences came various observations and lessons learned, including the following:

- Navy Family Information Center and Hot Line—Establishment of a Navy Family Information Center and Hot Line at the Charleston Naval Hospital on September 23 proved very useful in recovery efforts by providing information on services available, getting tiger teams to families in need, disseminating information on the return of

ships that sortied and often by having an understanding person available to talk to.

- The center was established with watchstanders from the submarine, surface and shore communities, who had direct access to the Naval Base Operations Center and to submarine group and destroyer squadron operations centers. The center was particularly important in relaying return data for ships that sortied, since some ombudsmen had to evacuate and others had their homes badly damaged, telephone lines knocked out, and so forth.

In this regard the briefing of ombudsmen at training academy sessions, predeployment briefings and other forums on leaving backup names and telephone numbers with the family service center or squadron is highly recommended. Public affairs offices and other organizations can then obtain an updated list just before the storm so that such information could be made readily available for information center use.

- The Military Affiliated Radio System (MARS)—In talking to ship COs who sortied to avoid the storm, several praised the usefulness of MARS in making telephone patches ashore to ombudsmen, CO and XO spouses to determine the status of crew members' families. Many said they knew the status of most families within 24 to 48 hours after the storm hit.

This was particularly significant because when ships were diverted to alternate ports (such as Mayport) pending inspection and opening of the channel, COs immediately dispatched the crewmen home who had their homes destroyed. The ships that fared the best had worked out many details before departure; many had not.

The role that MARS played in the information flow was significant and indirectly impacted the Hot Line call load. MARS and its role in such situations should be highlighted to sortied ships and their direct support network and be considered a definite factor in the information flow by local public affairs personnel. MARS was also used in a similar fashion for providing information to Charleston-based ships overseas that heard the reports of "total devastation, death and destruction." Later reports from overseas units indicated MARS connections were greatly appreciated and eased the minds of worried crewmen.

- Loss of local television and radio stations—As a result of the storm, all local media outlets eventually went off the air. Restoring communications with local media under these circumstances was a major task since telephone lines were lost and some stations moved to remote transmitter lines.

It is recommended that stations be contacted beforehand, perhaps during the same 72-hour time frame that ship sortie is normally addressed, and ask for transmitter site telephone numbers and secondary numbers. After the storm, several radio stations in less severely damaged areas in South Carolina, such as Port Royal, as well as in neighboring states (Jacksonville, Fla. and Raleigh, N.C.), voluntarily picked up the information load and relayed a great deal of South Carolina information.

Monitoring those stations and using them to provide emergency service information definitely helped in getting the word out. As a result, stations that participated were placed on local media lists or in contingency folders for easy reference if the need arose again. Also a battery-powered, black and white, dual-purpose television/radio maintained in the PAO emergency "fly-away" box provided the primary means of monitoring various broadcasts and is considered to be an essential piece of equipment in such situations.

These items represent only a sketch of what was gained in this most extraordinary circumstance. Other lessons learned will certainly be forthcoming as other ramifications of Hurricane Hugo are discovered.

DISASTER PREPAREDNESS

Learning Objective: Outline the planning and administrative procedures to follow to ensure naval disaster preparedness.

When faced with an adverse news situation, the first questions you must ask yourself are, What is my mission? and What am I trying to accomplish? What is really going on? Generally, the first word passed is usually wrong. A good relationship among the public affairs, intelligence and operations staffs should be in place before any disaster occurs, or the PAO folks will be uninformed of crucial information.

One of the first steps you should take to help answer these questions is to establish objectives. As elementary

or as obvious as this action may be, it is one of the first things frequently forgotten in a disaster situation. For this reason, it is important that you know in advance what your command's public affairs objectives are in the face of bad news.

OBJECTIVES

The following is a list of specific public affairs objectives when dealing with an adverse news situation:

- **Retain public confidence in the Navy.** When something goes wrong in the Navy, the competence of naval personnel or the value of naval equipment may be called into question. It is your job to minimize doubts by telling the truth, give full and accurate information and report what corrective actions, if any, are being taken. You may be able to neutralize an adverse story with this strategy, and increased public confidence may result if you do your job well.
- **Preserve good media and community relations.** Treat media representatives as you would like to be treated: honestly and fairly. Release all information that can be released. If you cover up certain facts related to an adverse news story, you can be sure the ill will that arises when the cover-up is discovered will follow you. Frankness and honesty are always respected. The results may be seen in the unbiased reporting of adverse news stories.
- **Protect and promote the welfare of military personnel and their families.** While you have an obligation to respond to the public's right to know, you must also remember that naval personnel and their families have a right to privacy that must be respected. This becomes most apparent when you deal with fatalities and notification of next of kin.

In addition to these objectives, the public affairs office has certain immediate and continuing responsibilities in a disaster situation. They are listed as follows:

- To safeguard classified information and material
- To provide the news media with maximum possible access to the accident scene and a continuous flow of information regarding the disaster
- To release the names of casualties as soon as current policy permits

PUBLIC AFFAIRS PLANS

To best meet the daily commitments and fulfill the public affairs responsibilities in a disaster situation, you must prepare two disaster plans. The **command plan** is issued by the command in the form of an official directive or appended to any master disaster plan as a public affairs annex. It promulgates broad information policies and designates overall responsibilities to staff departments or individual staff billets relative to the handling of public affairs in a disaster.

In addition, write an **office plan** outlining the detailed actions to be taken by the PAO and his staff to fulfill their designated responsibilities.

Command Plan

The command plan shown in figure 2-3 provides a solid base for the public affairs staff in a disaster. By being promulgated as a directive, the plan is officially sanctioned by the officer in command. It assures everybody's cooperation in the command and specifically outlines the command's objectives and the responsibilities of the public affairs staff and other departments in the command. In the absence of the PAO, it also serves as a general guide to the officer appointed to take his place.

The command plan shown might contain other details according to the specific requirements of the individual command. In the case of a ship, for instance, specific responsibilities might be delegated to the gunnery officer, nuclear weapons officer, engineering officer, and so forth. Naval bases and installations may be engaged in specialized activities, such as the testing of new equipment, training of fleet personnel or support of fleet units. In each case, alter the command plan to encompass the disaster contingencies anticipated as a result of the specialized activities of the individual commands. Another example of a disaster public affairs plan (called an adverse incident plan) appears in Appendix IV of this manual.

Office Plan

For a public affairs staff to meet and fulfill its responsibilities in a disaster situation successfully, you must prepare an office plan that outlines the specific actions for the PAO and his staff to take. To this plan, the specialized information, checkoff lists, telephone lists and the like are to be appended, which will help the public affairs staff respond quickly and efficiently should a disaster strike.

The office plan can be less formal than the command plan. It might be promulgated as an interoffice memorandum, such as the one shown in figure 2-4.

BASE DIRECTIVE 5700.1

From: Commanding Officer
To: Distribution List

Subj: PUBLIC AFFAIRS DISASTER PLAN

Ref: (a) Department of the Navy Public Affairs Policy and Regulations
(b) Bureau of Naval Personnel Manual

1. Purpose. To promulgate policy and establish responsibilities for the efficient handling and release of information concerning base personnel and units involved in a disaster.

2. Policy.

a. The basic public affairs policy of the Navy as promulgated by reference (a) is to keep the public informed of the activities of the Navy as compatible with military security. Officers in command are responsible for the implementation of the public affairs policies and programs of the Department of the Navy and for the conduct of public affairs within their commands.

b. The timely release of unclassified information and other actions necessary to keep the public informed are mandatory in the event of any naval disaster occurring on this base.

3. Definition. Disaster in the context of this directive is considered to be any naturally caused or man-made incident which:

a. Causes personnel casualties, whether to military or civilian personnel, which results in death, being placed in a "missing" status or injuries serious enough to require hospitalization.

b. Causes major damage or destruction to material.

c. Could become the subject of news media interest.

4. Responsibilities. In support of the information policies of this command, the following specific responsibilities are delegated and assigned in the event of a disaster:

Figure 2-3.—Sample command public affairs disaster plan.

a. Public Affairs Officer. The public affairs officer (PAO) is responsible to the commanding officer for all public affairs aspects of the disaster, including the release of pertinent information, liaison with news media representatives and liaison with civilian and military families who approach the base in search of information. He will take the necessary actions to keep the commanding officer and higher authorities continually informed concerning the informational aspects of the disaster. In the event that civilian relief organizations are needed to assist in relief operations, he will establish and maintain liaison with the public affairs representatives of those organizations.

The PAO will be the sole releasing authority for all information and as such will coordinate all public affairs inputs to reports relative to the disaster. Time and physical circumstances permitting, he will clear all major announcements or releases of information before public dissemination with the commanding officer.

b. Security Officer. The base security officer will ascertain at the earliest possible moment the security implications of the disaster relative to the release of information and access of reporters to the scene and communicate his findings to the PAO. He will maintain constant liaison with the PAO to provide continuous security guidance. He will, if possible, accompany the PAO, his staff, and news media representatives to the scene of the disaster and be present at all news briefings or conferences. If the security officer cannot be present, he will send a suitable representative.

c. Disaster Officer. The officer designated as the disaster officer in charge of relief operations at the disaster scene will provide the PAO with assistance in obtaining information for release and in providing access to the disaster scene for media representatives and release at the first opportunity. It is important that this officer provide a continuous flow of pertinent information to the public affairs staff for subsequent release. The containment of a fire, rescue of trapped personnel, removal of all the dead and injured, and so forth are the types of information which must be immediately communicated to the PAO or his representative.

d. Personnel Officer. The base personnel officer will maintain close liaison with the PAO to facilitate the release of casualty lists according to reference (b). He will immediately inform the PAO when receipts from next of kin notifications have been received. In addition, the personnel officer will provide such personnel services as may be required by the PAO to augment his staff properly with clerical help, escorts, messengers, food handlers, drivers, photographers and personnel to render general assistance. He will also provide officer personnel to act as assistants to the PAO in capacities, such as next of kin information and liaison officer,

Figure 2-3.—Sample command public affairs disaster plan—Continued.

communications liaison officer, administrative assistant and technical information officer.

e. Communications Officer. The base communications officer will supply the necessary assistance needed to augment the telephone and intercommunications systems in the public affairs office, next of kin hotline or lounge, media information center and at other appropriate locations. Where necessary he will assist the PAO in obtaining additional assistance from commercial communications organizations, such as the telephone company, and so forth. He will assist the PAO in establishing prompt and continuous communication with higher naval authority.

f. Supply Officer. The base supply officer will assist the PAO with the facilities available to his department. As specified by the PAO, he will supply tables, chairs, typewriters, clerical incidentals, cots, coffee urns and coffee, food as necessary, dishes and implements and other items in the supply inventory which will assist the PAO in fulfilling his responsibilities in the best possible manner.

g. Transportation Officer. Will provide vehicles necessary to meet the transportation requirements of the PAO in meeting his responsibilities.

h. All Base Personnel. Other personnel who may be directly or indirectly involved in the disaster are reminded that the PAO is the designated releasing authority for all information concerning the disaster. They should not engage in interviews, volunteer information or otherwise communicate with media representatives except to provide normal courtesies, such as directions or general instructions. If an individual feels he is the holder of information pertinent to the disaster, he should convey that information to the public affairs office or security office for coordination and release. All personnel are further directed to cooperate in any way possible with the PAO to assist him in fulfilling his responsibilities.

5. Action. This directive applies to all personnel, military and civilian, attached to this command. Department heads are directed to bring the contents of the directive to the attention of all their personnel and to make it a permanent part of department operational disaster plans. They are further directed to effect immediate and continuing liaison with the PAO in order to prepare detailed lists of requirements commensurate with his responsibilities as specified by this directive.

T. E. HAWK
RADM USN

Figure 2-3.—Sample command public affairs disaster plan—Continued.

MEMORANDUM

From: Public Affairs Officer
To: Public Affairs Staff

Subj: PUBLIC AFFAIRS IN THE EVENT OF A NAVAL DISASTER

Ref: (a) Base Directive 5700.1 (Public Affairs Disaster Plan)

1. Background. In accordance with the responsibilities assigned this office by reference (a), the actions outlined in this memorandum will be taken by staff personnel in the event of a naval disaster.

2. General Action to be Taken. When disaster as defined by reference (a) occurs on this base, the public affairs staff must immediately report to their assigned posts. If it is not possible to do so at a reasonable time, you are requested to contact the PAO at your earliest opportunity to report your status (unless you are on authorized leave many miles distant). In the event of a disaster, the public affairs staff may be required to remain close to the office for several days. It is recommended that when you report you bring one change of clothing and basic toilet articles.

3. Specific Assignments.

a. Duty Journalist. This individual stands his watch in the public affairs office and will be notified by the command duty officer of any disaster. He will immediately notify all public affairs staff personnel of the disaster and direct them to report to their posts. After the arrival of the PAO, he will proceed to his assigned post.

b. Public Affairs Officer. Will proceed to the public affairs office or designated disaster post, and he will then designate a Command Information Bureau (CIB). He will take necessary action to prepare the initial statement reporting the disaster to the media. The first announcement should be cleared by the commanding officer if at all possible. The PAO will be in charge of the CIB for the duration of the disaster period.

c. Assistant Public Affairs Officer. Will proceed immediately to his/her designated disaster post to ascertain the situation, which he will report to the PAO as soon as possible. Unless otherwise notified by the PAO, he will act as the media liaison officer for the duration of the disaster operation.

Figure 2-4.—Sample public affairs office disaster plan.

d. Chief Journalist. Will report immediately to the CIB to act as the PAO's administrative assistant. He will take the necessary steps to establish a news media information center in room 794, adjacent to the CIB. This will be for the use of media representatives for the duration of the disaster operation.

e. First/Second Class Journalist. Report immediately to the CIB. Prepare office equipment (photo lab, typewriters, duplicating machines, etc.) and have other public affairs staff personnel stand by for processing the initial statement. At first opportunity, take necessary steps to establish a next of kin lounge in the Family Service Center for use by next of kin, relatives, fiances, etc., of the personnel involved in the disaster. He will act as the coordinator for the processing and dissemination of the subsequent news releases.

f. Civilian Secretary. Will report immediately to the CIB and report to the PAO. Primary duties, at least in the initial phases, will consist of establishing telephone contacts with the news media, other base departments and officers and higher authorities—the PAO at Atlantic Fleet Headquarters and the CHINFO duty officer—immediately, and others as directed by the PAO.

g. Director, Family Service Center. Report immediately to the PAO by telephone. Prepare FSC for continuous information support to military/civilian families. Prepare to operate public hotline for general inquiries concerning the disaster.

h. Other Personnel. Report immediately to the PAO in the CIB for further assignment.

4. In a disaster occurring on this base, the commanding officer and the media will be depending on this office to assume responsibility immediately for the prompt and continuous flow of information. This is an important job, and a big one. Your individual duties are most important to the success of the entire operation.

R. H. MANATEE
LCDR USN

Figure 2-4.—Sample public affairs office disaster plan—Continued.

The plan described in figure 2-4 cannot completely detail all the actions to be taken by individual personnel throughout the duration of a disaster. However, it does outline the immediate actions for each member of the staff to take and it assigns general responsibilities to each for the duration of the progression of the disaster. It serves to get everyone started; then it is up to the senior JO and the PAO to adjust their resources and make specific assignments based on the specialized requirements of the disaster.

The checklists, telephone lists and other various informational materials appended to the office plan are the most important to its success. The specific information and manner of presentation will, of course, differ with individual public affairs staffs and commands. The type of data will, however, be much the same anywhere and would include many or all of the following items.

POLICY MATERIALS.— The public affairs staff must have selected policy materials close at hand to facilitate the release of information. Of course, the command plan will be a big help, but the officer in command and other staff officers may want to see specific references authorizing action. These include, but are not limited to, the following items:

- *PA Regs, Bureau of Naval Personnel Manual Department of the Navy Information and Personnel Security Program Regulation (OPNAVINST 5510.1 series), The Navy and Marine Corps Disaster Preparedness Manual (OPNAVINST 3440.16 series), Navy Visual Information Management and Operations Manual (OPNAVINST 5290.1 series) and the Manual of the Judge Advocate General. Chapter 8 of PA Regs lists several other references that you should also review.*
- Sample releases made in other disasters to illustrate what has been done in the past. Statements made by the Chief of Naval Operations in regard to the *Iowa* tragedy or *Midway* fire, for instance, might prove useful.
- Case studies of past disasters containing recommendations for handling disasters. The CHINFO Plans and Policy Division keeps on file copies of several excellent case studies made on the public affairs aspects of past naval disasters.

BACKGROUND MATERIALS.— The bulk of the material appended to the office plan will probably be background information. If it is not possible for you to append all such material physically, a notation should

be made stating where the material is available. Background materials might include the following items:

- Command history.
- Fact sheets on the command and the various ships, aircraft, missiles, and so forth, which might be assigned.
- Biographies and photographs of the CO, XO and C/MC.
- Background information on units likely to be involved in disaster relief activities, such as the fire station and hospital.
- Definitions of naval terms and nomenclature peculiar to your unit or operation.
- Lists of all material in the command of a sensitive nature or which may require special security treatment.
- Biographies of all test pilots (if applicable).
- Fact sheets concerning normal naval activities performed by units which could be involved in a disaster.
- Histories or fact sheets of previous disasters in the command.
- General hometown information on all military personnel.
- One-minute video clips of equipment, aircraft and ships assigned to the command. These are available to commands on request from the Naval Imaging Command in Washington, D.C.
- A current listing of Navy enlisted classifications (NECs) that explains the duties of each Navy enlisted rating.
- Up-to-date statistics concerning personnel, production, and so forth, concerning the command.
- Information on any local materials which might cause anxiety in a disaster, for example, explosives and nuclear materials.
- A list of relief facilities immediately available to next of kin (survivors benefits, death gratuity payment, etc.).

GENERAL ADMINISTRATION

Several administrative considerations should be addressed when planning the public affairs response to an adverse news situation. These considerations include the formulation of a recall bill, checkoff lists, a comprehensive telephone number listing, the stocking of prepared forms and samples and personnel augmentation.

Recall Bill

Maintaining an up-to-date recall bill with current addresses and telephone numbers of your staff members is critical to your overall chaster preparedness. Update this list at least once per quarter. Additionally, make sure the correct office and home telephone numbers of key PAO staff members are included in the command duty officer notebook or pass-down log.

Checkoff Lists

Checkoff lists can be extremely helpful in a disaster situation. It is impossible to remember every detail when things get confusing. These lists supplement the public affairs staff's memory and should be as detailed as possible. No item is too small to include. They should not, however, be prepared for every conceivable activity. This can lead to further work and confusion for the staff. Checkoff lists might be prepared for the following areas:

- Physical necessities for the CIB and next of kin lounge
- Ground-rule items to be discussed with media representatives
- Experts in various activities of the command
- Official reports that must be filed by the public affairs office

Work sheets are also valuable in the handling of public affairs in a disaster situation. A sample format for a disaster work sheet appears in figure 2-5.

Telephone Numbers

In a disaster situation, the telephone is a major tool for the public affairs staff. Develop a compact but comprehensive list of the people and places you will most certainly contact; include home and business numbers.

Give careful attention to this list to make sure it does not become too cumbersome to be useful. Listing all the contacts alphabetically, for instance, may prove frustrating when a number is needed quickly and the name is forgotten. It is better to first divide the list into meaningful categories, which might include the following:

- Personnel assigned to the public affairs office
- News media representatives and stringers
- Strategic base personnel, such as department heads, fire chief, duty officer, officer in charge of the guard posts, and so forth
- Current *Directory of Public Affairs Officers*, NAVSO P-3068
- Strategic civilian agencies, such as the fire and police departments, Red Cross and civil defense
- Strategic personnel in the chain of command between your command and the highest authority
- Special local individuals, such as telephone company representatives, who can assign radio trucks or assist in obtaining open telephone lines

Prepared Forms and Samples

In all Navy commands there are a number of prescribed forms necessary to obtain certain materials or to accomplish certain tasks. In addition, you may wish to design a number of specialized forms to facilitate speedy action (i.e., format these documents to fill-in-the-blanks on a word processor rather than paper rough drafts). These might include the following:

- Long distance telephone authorizations.
- Blank Joint Message Forms (DD 173/2).
- Query sheets for incoming queries with space for name of caller, return number, organization represented, specific question, time of call, and so forth.
- A fact sheet for outgoing query calls basically designed with Who, What, When, Where, Why and How in mind.
- A sample outgoing message showing its proper routing.
- A sample request for helicopter services.
- Request forms for base transportation.

**SERIOUS ACCIDENT OR EMERGENCY
WORK SHEET**
(name of command)

1. Date _____ Time _____
2. Nature of accident _____

Fire involved? _____
How serious? _____
Explosion involved? _____
Expected? _____
Nuclear material involved? _____
Continuing danger? _____
Need for evacuation? _____
Should spectators be kept away? _____
3. Location _____
On base/off base? _____
4. Officer in command and/or chief of staff/executive officer notified? _____
By whom? _____ Time _____
5. Public Affairs Officer notified? _____
By whom? _____ Time _____
6. Public Affairs Officer of _____
(next senior authority in chain of command) informed? _____
If done, by whom? _____ Time _____
If not considered necessary, why? _____

Figure 2-5.—Sample public affairs office disaster action work sheet.

7. Other commands which may receive media queries on accident

Name _____ Informed? _____

By whom? _____ Time _____

Name _____ Informed? _____

By whom? _____ Time _____

Name _____ Informed? _____

By whom? _____ Time _____

8. PAO representative at scene of accident? _____

Name _____ Time of arrival _____

9. Casualties (if more space needed, attach roster)

a. Killed

No. 1

No. 2

(1) Name _____

(2) Rank _____

(3) Service _____

(4) Home _____

(5) NOK _____

(6) Notified _____

b. Injured

No. 1

No. 2

(1) Name _____

(2) Rank _____

Figure 2-5.—Sample public affairs office disaster action work sheet—Continued.

(3) Service _____

(4) Home _____

(5) NOK _____

(6) Notified _____

(7) Extent of injuries _____

c. Where have injured been taken? _____

10. Major property involved:

a. Government _____

(1) Damage _____

(2) Identification numbers of aircraft or vehicles involved: _____

b. Private _____

(1) Distance to nearest civilian property? _____

(2) Damage _____

(3) Owner _____

(Attach additional list if necessary.)

11. Alert news media of accident. (Attach message.)

Media

Person Contacted

Time/Date

Figure 2-5.—Sample public affairs office disaster action work sheet—Continued.

12. Media representative(s) at scene:

Media

Name

13. Interim release #1 (attached) furnished _____
(time/date)

Media

Name

14. Interim release #2 (attached) furnished _____
(time/date)

Media

Name

15. Final release (attached) furnished _____
(time/date)

Media

Name

16. Unusual occurrences:

17. File made of this checklist, notes of pertinent comments made, any clippings or correspondence of importance and any other material of value for permanent record and/or guidance in conduct of future similar situations.

18. Action completed (time/date) _____

(signed) _____

Figure 2-5.—Sample public affairs office disaster action work sheet—Continued.

- Forms on which the PAO may make periodic reports to the officer in command regarding the informational aspects of the disaster, such as total queries received, reporters on the base, releases made, cumulative statistics of public affairs activities and significant events since the last report. These forms permit brief reports to be made as often as necessary.
- Forms on which a chronological listing of events may be kept.
- Sample official letters authorizing media representatives to travel in naval ships and aircraft.
- Blank waiver forms to be signed by media representatives before embarking in Navy ships or aircraft.
- Sample naval messages to ships or remote units requesting disaster information.
- Sample reports to higher authority.
- Forms to facilitate maintaining a log or running description of the public affairs activities to be used later in writing a comprehensive report.
- Media access badges (blank).
- Media parking passed (blank).

Personnel Augmentation

In the event of a major prolonged disaster, the public affairs staff will need additional personnel, perhaps some from outside the command. There must be pertinent information concerning the augmentation of this staff. This list might include the following:

- Reserve public affairs personnel (PAOs, JOs, etc.) in the immediate area who could come on active duty at short notice
- Active-duty public affairs personnel within a certain radius who might supply personnel assistance
- Names of enlisted personnel from other departments in the command particularly well suited to function as messengers, escorts, typists, and so forth
- Names of officers from other departments who might serve in specialized capacities, such as a

next of kin information officer or an administrative assistant

- Names of photographic personnel with the demonstrated ability to obtain good news photo coverage
- Experts in various specialties who would be called upon to provide technical background information or could be interviewed by media representatives

THE COMMAND INFORMATION BUREAU

The PAO and senior JO should establish a CIB to provide a **single source of information** to reporters. News briefings and releases made from the CIB will reduce inaccuracies and restrict the flow of media to less reliable sources of information. Additionally, security violations can be avoided in having a single source of information that works in concert with Navy officials on scene. Although some CIB provisions are mentioned in this chapter, more detailed information is contained in *The Command Information Bureau*, Chapter 3.

PUBLIC AFFAIRS PROCEDURES IN NAVAL DISASTERS

Learning Objective: Identify the public affairs procedures taken during a naval disaster.

The most exacting measure of any PAO and senior journalist is likely to center on his handling of an accident story. Your success or failure in such a situation will depend upon your personal ability and competence as well as the competence of your staff, your past record of success or failure in similar situations and the rapport you have with the media. Your credibility and integrity are on the line. Your handling of an adverse news situation reflects on you, the command and the DoD.

RELEASING AUTHORITY

Under any circumstances there is usually a designated authority or specified coordinator for the release of information. Amid disaster, such an authority is mandatory if satisfactory relations are to be maintained with the media and the public. When no one person is recognized as the official spokesman, there is confusion among the press, the relief workers, officials in charge and indeed among the public affairs staff. This should be agreed to and specified in your disaster plan wherever possible.

The reporter without an official, authoritative point of contact has no ready way to distinguish truth from rumor or speculation. In addition, those people involved in the disaster and the personnel taking part in the relief efforts do not know who is receiving and coordinating disaster information for subsequent dissemination. The result is that current and meaningful information which should be continually passed to the press may never be released at all.

The individuals in charge of the relief efforts do not have the time or training to cope with the specialized requirements of the media. When contacted by media representatives, they may become uncooperative or even abusive. This can only make a bad situation that much worse.

A Navy PAO (a captain with more than 20 years of public affairs experience) had vivid memories concerning the crash of a Navy airplane. In regard to a specified releasing authority, he said the following:

“There was a plane crash in a civilian housing area near Philadelphia several years ago. Many civilians were killed in their homes. With the Navy rescue and salvage personnel on the scene were members of the civilian fire department and local police. No one had the authority to release information, assist photographers, and so forth. With no such authority established, the naval officer in charge of the relief efforts prohibited photographers from taking pictures, expelled reporters from the scene and ordered no one to answer questions, thus making the worst possible out of a **bad situation.**”

Incidents on federal property, but outside the fence, pose other unique problems. Your plan should include how the base police/security handle the media if they arrive before the public affairs team.

Normally, the director of the CIB that is established to cope with a particular incident is appointed official spokesman or releasing authority; or, it may be the PAO on the staff of the officer in charge of search, rescue/relief or disaster control operations. In some instances, it will be the PAO on the staff of the naval district commandant within whose jurisdiction the disaster occurs. Release authority can be spelled out in the command disaster plan.

INITIAL ACTIONS

Immediately following an accident or disaster, operational personnel are involved in containment and

control-survivor rescue and treatment, damage control, protection of classified information, and so on. Meanwhile, public affairs staff members obtain the facts to release information as well as consider the establishment of the CIB.

To gather information successfully for release, position members of your staff in the following locations:

- At the command post or emergency crisis control center/CIB of the installation
- At or near the accident scene
- At the public affairs office

In the public affairs office disaster plan shown in figure 2-4, specify that at the first word of a major accident, office staff members report to the assignments made in the Watch, Quarter and Station Bill. Then take five or 10 minutes to locate all of your forms and samples for disaster use and get the office ready. This time will prove to be well spent during the high intensity of answering telephones and writing initial and ensuing reports or statements for the disaster situation. After this is done, instruct them to establish communications with the command post or emergency crisis control center or CIB. Regardless of the location of the accident, communications must be established rapidly between the public affairs representative at the scene of the accident and at the command. This provides the coordination necessary to release information on a timely basis.

Appoint one of your staff members to keep a running log of the following information:

- The time of the accident and a basic description of the occurrence
- Important developments
- The times news releases are issued
- Policy as it was passed to you and how and when you implemented it
- Copies of OPREP-3s, unit SITREPs and other pertinent messages
- Query log that includes Time/Date/Reporter/Media outlet (see the sample query sheet in Chapter 4)
- Other important information

This will assist you in giving timely and accurate information to the news media and for writing

immediate external releases. Some of this information can also be included in press kits (as in the *Midway* fire) or used in briefings.

THE INITIAL NEWS RELEASE

The initial news release on an accident should give as much information as possible unless the disaster is of such magnitude that information about it is to be released from the seat of government. Remember, after you first receive notification of the accident or incident, you have **one hour** to disseminate the initial news release to the media. **DO NOT** delay the release until more information becomes available or while awaiting the results of an investigation.

The following information, if available, should be contained in the initial news release of an accident:

- The specific type of accident that has occurred
- The location and time of the accident
- The persons involved (subject to requirements on notification of next of kin)
- The places of departure or destination of any vehicles involved (including vessels, aircraft, missiles, etc.)
- The type of equipment involved, unless classified
- The unclassified, pertinent facts about the mission at the time of the accident
- A statement regarding whether a board of inquiry is investigating or will investigate the accident

A release of this kind follows the standard Navy policy of releasing as much information as security considerations permit. Additionally, it provides the news media with information to convey to the general public and discourages rumors.

Never speculate about the cause of an accident or responsibility for the mishap. The standard statement is, "An investigation is being conducted to determine the cause of the accident."

COOPERATING WITH THE NEWS MEDIA

Learning Objective: *Recognize the Navy's public affairs role in cooperating with news media representatives during a disaster.*

The first hours of a disaster are hectic and tiring. The public affairs staff cannot afford to take a break in the critical hours following the initial release. You must gather more information to answer the inevitable questions which will follow. The direct responsibility of the PAO and his staff continues until the interest of the press and public is satisfied.

Mere cooperation by the Navy with the news media will not guarantee sympathetic handling of the facts in an unfortunate situation. News people have a job to do and will do it whether the Navy cooperates or not. While putting the initial release together, let media know you are doing so and find out their deadlines. Try to get the reporters something within their time lines. Being proactive, initiating media contact versus "responding to query," establishes a more credible relationship with the media—especially under negative circumstances.

Cooperation, however, will often result in a more accurate and undistorted picture of the situation. If the facts are presented carefully and candidly as they become available, reporters are more likely to report them objectively. There is also less margin for error and less chance for misinterpretation.

If the Navy refuses to cooperate, reporters have no alternative but to start looking elsewhere for information. In an accident or disaster situation, a reporter will not hesitate to interview any bystander in an effort to get information. But if the reporter knows that the public affairs representative is doing all in his power to cooperate and obtain up-to-the-minute information, he will prefer to wait for authenticated facts. He will prefer to hear the facts presented by an official spokesman or the officer in command.

At the scene of a disaster, reporters are the representatives of the public. Through their eyes, the public learns what has happened, how it happened and the other details that are available. The public's first impression of the situation and the Navy will be made by what they see in print, hear on the radio or watch on television. It is important that these impressions be unbiased and undistorted from the beginning.

Attributes for Dealing with the Media in a Disaster

There are five attributes that contribute to the success of media relations in a disaster situation: accuracy, initiative, honesty, impartiality and good taste.

ACCURACY.— In the turmoil of disaster, there may be many temptations for you to rely on memory or to make educated estimates in answering seemingly inconsequential questions. Reporters may be pressing from all sides for bits of information which must be laboriously checked for accuracy.

An offhand answer to a question, such as, “How many crew members does an airplane like the one that crashed usually carry?” may haunt you for weeks or months. A low estimate might imply the aircraft was permitted to fly with an incomplete crew. An overestimate might excite speculation about a special mission or an overloaded airplane.

No detail is too small to confirm. Checking and rechecking facts in a disaster situation should be standard operating procedure. It could very well spell the difference between success or failure of your whole effort.

In this regard you must resist efforts by the media to force the answer to a question before it has been authenticated. This is particularly difficult when deadlines approach or there is pressure from a reporter who is personally known and trusted. Being stampeded into an answer at a time like this can only result in additional problems. Say you will check and get back to them by a specific time. Whether you have the answer or not, at least give them a status report.

One important aspect of accuracy is the release of the names of disaster victims. A misspelled name, wrong initials, incorrect grade or rate can mean unwarranted anxiety or suffering to the next of kin. An example of this was the crash of a military transport plane several years ago. The public affairs office, in its haste to oblige reporters, released the flight manifest from another aircraft of the same type which was flying a similar mission on the same day. The identification numbers of the aircraft were similar and were not double-checked before they were released. In an attempt to provide quick assistance, a tragic mistake was made.

INITIATIVE.— A good JO anticipates the needs of the news media. Get them the facts, figures and other information they will need before they get a chance to ask for it. When you take this initiative, the following advantages will result:

- It shows you are interested in their problems and want to cooperate.
- It indicates the public affairs staff is ready for such situations when they arise. Reporters appreciate enterprise and resourcefulness

because these qualities are required of them in their own professions.

- It establishes an air of honesty and frankness. They know you are not trying to hide anything.
- It saves time—both yours and theirs. If you provide information as soon as it becomes available, reporters do not have to go out and dig it up themselves. Releasing news promptly also saves you from repeated queries on the same subject.
- It enables the Navy to state its position along with the facts it releases. You have to be careful, however, to avoid the appearance of trying to whitewash the facts.
- It provides alibi copy for the public affairs files.

This is an area where you, as a senior JO, are certain to be of value to your command. Most of the decisions concerning media relations and public affairs policy will be made by the officer in command or PAO—although you may get deeply involved in this if there is no full-time PAO in the command.

But whatever the situation, digging up facts and figures is the JO's job, a job you can embark upon as soon as you get the word that an accident has occurred. Almost any fact your research brings out will help the PAO and the news media.

If you follow the preceding releasing procedure, the job of reading bulletins over the telephone to the media will probably rest on you also. You will do this while the PAO (or director of the CIB) talks to other officers and gets new information and guidance. You can take down any questions you are asked, and either get the answers yourself or refer them to your boss. However, you should never assume the role as spokesman unless specifically designated by the officer-in-charge.

HONESTY.— Honesty in dealing with the media is always of prime importance. The circumstances surrounding a disaster are often negative in connotation and sometimes painful to admit. The only solution, however, is complete honesty and candor.

Overt dishonesty is generally not the problem. Many of the facts are readily available or discernible to the press. The problem of indirect dishonesty is most often encountered. Neglecting to tell the whole story or glossing over certain unsavory facts is dishonest. Failing to tell the news media that the CO of a ship was previously involved in a similar disaster is a form of dishonesty.

Apart from the moral implications of indirect dishonesty is the problem of being caught. Should the media discover dishonesty in a Navy news release, the facts withheld assume new importance. Since they are discovered after the basic stories have been written, they are singled out for individual attention.

IMPARTIALITY.— The Navy cannot expect fair treatment from the news media unless it treats all media equally. Never give information or any advantage to one news medium and withhold it from another. If you allow one reporter access to the scene of a disaster, you must allow similar access to all. This includes newspapers, wire services, radio and television stations and magazines.

Occasionally, when there are too many reporters at the scene of a big story, the Navy must ask them to pool certain information. For example, suppose a dozen reporters request permission to board a ship involved in a major disaster. Although the dead and injured have been evacuated, damage control measures are still in progress. The ship's CO or damage control officer may say that 12 reporters cannot be controlled and might interfere with operations, but he agrees to allow one or two aboard. In this situation, the 12 reporters will be asked to select one or two members of their group to go aboard and pass out the information on a pool basis. If one were a photographer, any photos he took would be distributed to all. Once the pool agreement is made, the reporters concerned are morally bound to share everything they saw, photographed or recorded with all members of the pool.

GOOD TASTE.— News reporters are generally careful about violating the principle of good taste. The news media has its own unwritten standards that are usually adequate to protect the disaster victims or their next of kin. There are no laws against the publication of "horror" photographs or news stories, but each newspaper or television station has its own code of ethics. You cannot take "censorship" actions to keep such information from being taken from the scene of the disaster. You must rely on the usual good taste of the individual media representative.

From the Navy's standpoint, however, you can take action to preserve good taste. This is certainly true in the case of Navy photographers whose pictures will be released to the news media. A few of the things to watch for that would violate good taste include the following:

- Photographs of casualties or their next of kin when they are in a state of shock

- Details of personal conduct of a scandalous nature
- Information that might prejudice the rights of an accused or a party to an investigation before these facts are brought out in open court

While you cannot stop a news reporter from using a story, videotape or photograph you would consider to be in bad taste, you can provide guidance and make sure that he adheres to the ground rules previously agreed upon.

Additional information on media relations can be found in Chapter 4 (*Media Relations*).

Briefing Reporters

Before briefing reporters at the CIB, you or the PAO should prepare a list of contingency questions and answers to be used to respond to probable news media inquiries. Once the questions and answers (or statements) are approved, the senior public affairs representative at the scene should be given clearance to release it. As stated earlier, release authority can be identified in the command disaster plan.

Media Identification

Include special news media identification badges available for immediate issue in your CIB planning. They may consist of inexpensive plastic badges, arm bands or other similar devices that conform to your command's security badging system. Badges can be prepared in advance, with one or more badges marked and set aside for local newspapers, television and radio stations, and so forth.

Under normal circumstances, base police will call the CIB to request an escort for media representatives at the gate. When they arrive at the CIB, log in the media members and carefully verify their news organization credentials (press cards). Previously prepared lists of local media members are essential during the verification process. As time permits, make random telephone credential checks to non-local news agencies for verification. When issuing the badges, explain that they must carry them at all times while on base and must surrender them before leaving.

Media Ground Rules

When news reporters are permitted access to an accident scene, they and the command should first agree to certain ground rules which must be based on common

sense relative to the special circumstances of the situation. To avoid conflict, you should define the rules before the media is escorted to the accident scene. Although not an all-inclusive list, reporters should be asked to refrain from the following actions:

- Seeking interviews with injured personnel or their distraught next of kin
- Divulging the names of victims until next of kin have been notified regardless of the fact that they obtain the information by their own resources
- Entering restricted areas or areas that contain classified equipment
- Physically disturbing parts of the accident scene before investigators arrive
- Bringing heavy equipment or otherwise cumbersome paraphernalia that might interfere with rescue operations or require additional personnel to carry it
- Seeking interviews with individual rescue workers or the personnel in charge of the operation
- Wandering from the designated access area in search of additional information or photographs

Explain the ground rules to the media members when the media identification badges are issued. The ground rules briefing may also indicate when news briefings are scheduled, how the CIB is configured, how and when they will be brought to the accident site and other information pertinent to the situation.

Admitting Reporters to the Accident Scene

News media always want to send reporters and photographers to the scene of a disaster. To ensure complete and fair coverage, allow access to the scene whenever possible. They cannot, however, be given access when their presence would do the following:

- Interfere with damage control, rescue or evacuation measures
- Jeopardize their own safety
- Violate security

There are no regulations that prohibit reporters from visiting the scene of an accident or disaster simply because it takes place on a military installation. Unless one of the foregoing objections exists, action should be

taken to permit entry to the base or installation and to allow them to visit the scene.

Once the reporters are escorted to the scene, they should be given all practicable freedom to move about, take photographs and gather information, as long as they observe the previously set ground rules.

If an accident occurs in the public domain (outside the confines of a military installation), the Navy has no right to prevent reporters or other civilians from going to the scene. This is true even if the area is federal property outside the fence. They may be kept away—that is, kept at a distance—only when their presence may interfere with operations, jeopardize their own safety or possibly violate security. If there is exposed classified information or equipment, the public affairs official at the scene should explain the situation and ask reporters to stay back until the material or equipment can be covered or removed.

The Navy has no right to prohibit the media, or any civilian, for that matter, from taking photographs of an unclassified accident scene in the public domain. There have been several unfortunate situations in the past where cameras and film were forcibly taken from civilians, sometimes at gunpoint. In the public domain, only civilian police have authority. Use them rather than military police or security.

Reporters and photographers must be escorted at all times at the accident or incident scene. They must be controlled to make sure they do not interfere with the efforts of the crisis management team or compromise operational security.

Photography Control at the Accident Site-On Base

As noted earlier, news photographers should be allowed maximum access to an accident scene when all classified material is either covered or removed. But when a member of the media photographs or videotapes classified material on base, either intentionally or by mistake, he must be escorted to the PAO at the scene at once. The PAO must inform the media member of Title 18 U.S. Code 793 (d), 795 and 797, which makes the photography of classified material a violation of federal law.

Following the Title 18 notification, the media member should be asked to surrender the film or videotape voluntarily. If he refuses, the on-scene PAO must escort the individual to the CIB. Either the PAO or the senior journalist at the CIB will then contact the

sponsoring media organization to request the voluntary surrender of the film or videotape. If the news organization refuses, the PAO has no alternative but to confiscate the film or videotape. The photographer should be given a receipt for all items taken. **The photographer must not be detained because of the exposed film or videotape.**

After the film or videotape is reviewed and all classified portions are removed, the edited film or videotape should be returned to the photographer without delay. Any instance of confiscation of film or videotape from a news media representative must be reported by telephone to CHINFO with a follow-up message.

Photography Control at the Accident Site-Off Base

If the adverse news situation occurs off base, there is a limit as to when film or videotape can be confiscated. Media members must be informed of Title 18 when classified material is present and asked to refrain from photographing or videotaping it. If the media members refuse to observe the ground rules, request the help of civilian law enforcement personnel.

The senior Navy official at the scene must determine whether there is any classified information present. If none is found or if it has been removed or covered, the senior Navy official and the PAO should assist the news media in covering the scene. If it cannot be determined whether classified information is exposed, the senior official or PAO should explain these concerns and tell them photography cannot begin until a preliminary investigation is conducted.

Chapter 8 of *PA Regs* contains detailed information on the control of photography at accident sites both on and off base.

Releasing the Names of Casualties

Learning Objective: Identify the proper release procedures for the names of disaster casualties.

The Navy realizes that the greatest shock a family can receive is to hear on the radio or read in a newspaper that a son, daughter, husband or wife has been killed without first having received official notification from the Navy. Whenever possible, the Navy protects the welfare of Navy families by withholding the names of casualties from news media until official notification is made.

Once the next of kin have been notified, however, the Navy attempts to expedite the release of the names to the news media. This relieves the anxiety of the families of Navy men and women who were not involved in the accident.

For example, assume that there are 100 aviators attached to a naval air station. If one is killed in a local crash and the facts are released without mentioning the pilot's name, the families of **all** the aviators in the area suffer until they learn the name of the victim. After his next of kin are notified, the anxiety of the other families is relieved when the name is released.

To protect the well-being and welfare of families, the Navy adheres to the following policies in releasing the names of casualties to the news media.

MILITARY INSTALLATION - CONUS.— Public release of names of Navy personnel killed or injured may be withheld until the next of kin can reasonably be expected to have received notification. Every effort will be made, however, to release the names concurrently with the announcement of the accident, or as soon afterwards as possible, in order to alleviate undue suspense or anxiety for relatives of other personnel of the unit involved in the accident.

PUBLIC DOMAIN - CONUS.— If an accident occurs off Navy property and Navy personnel are involved, every effort should be made to notify the next of kin before releasing the names of those killed or injured. Reporters at the scene may be able to obtain identification through other means (police reports are publicly available and many coroner's offices reveal names readily), but humanitarian considerations dictate that the next of kin should be notified of the situation before being confronted by the news through the general media. Similar considerations hold true for notifying the next of kin of Navy civilian personnel involved in accidents.

If reporters know the identities of military accident victims and the next of kin have not been notified, the PAO or senior journalist should make a professional appeal to the reporters that they withhold the names until the next of kin have been notified.

OUTSIDE CONUS.— In a unified command area the release of names will be directed by the unified commander. In other overseas areas, the next of kin will be notified before names or photos of casualties are released. In cases of multiple casualties, where the notification of the next of kin must be delayed because of incomplete information or lack of positive identification, the approval of the Chief of Naval

Personnel may be sought for release of a partial list. Accidents occurring outside the United States may require additional coordination with the U.S. embassy or consulate to make sure the host government is properly notified.

MULTISERVICE.— In all joint operations, the joint command PAO is responsible for all public affairs actions regardless if he is of the service that had the accident. Otherwise, if circumstances permit, the parent service of the affected aircraft, vessel or vehicle should make the initial public release. If a Navy representative is not immediately available for comment and certain facts about the accident are obvious, any other service involved may assist reporters who request information. An indication should be made that the information is interim in nature, that the information is confined to the basic known facts, and that an investigation is being made or will be made.

NON-NAVY CIVILIANS.— In a unified command area, action will be directed by the unified commander. In other areas, notification will be made by message or telephone to the authority responsible for coordination of public affairs. If national interest is anticipated, CHINFO will be informed. Appropriate civil authorities also will be informed. Public release of the names of non-Navy civilian casualties is at the discretion of the command concerned. If it is considered advisable to release this information before the next of kin have been notified, a statement on the status of this notification should be included in the release.

AUTHORITATIVE BACKGROUND INFORMATION

The equipment involved in naval disasters is often highly technical. The circumstances surrounding a collision at sea or aircraft accident are usually unfamiliar to the layman.

To report the facts in context, it is important that the media fully understand what has happened. Such understanding may also help them to be sympathetic in their reporting of why it happened.

Technical manuals usually seem confusing and unnecessarily detailed to the uninitiated. The public affairs staff, in many cases, cannot explain technicalities or specialized operations. An attempt to do so, without thorough knowledge, can only lead to additional confusion.

Soon after the initial announcement concerning the loss of a nuclear submarine, the Navy made certain

technical experts available to answer specialized questions concerning submarine operations. One of these was the former CO of a nuclear submarine. This officer, who himself had taken a nuclear submarine under the arctic ice fields, spent several hours providing background information to the Pentagon press corps. He also appeared in a number of televised interviews. While being careful to avoid speculation as to the cause of the disaster, he did provide enough technical data to enable stories to be written accurately. He was also able to dispel a number of unfounded stories and rumors which circulated soon after the sinking. One Pentagon news reporter remarked that these briefings contributed greatly to the excellent public relations associated with the disaster.

Background information which may seem to be remote or “too much trouble” in the hectic hours following a disaster may be the most important in the long run.

DEBRIEFING SURVIVORS

On several occasions, it has been noted that disaster survivors were interviewed by the news media without having been debriefed by the PAO or an assistant from his staff. Debriefing is a private meeting at which the survivors are interviewed to determine their experiences and counsel them about their upcoming meeting with reporters. Other cognizant personnel must also be present to offer specific guidance. Debriefing may not be possible when reporters are taken to the disaster scene, but a knowledgeable escort can help the reporter to keep information obtained from interviews in context. Individuals in the midst of a disaster often do not know the full story of what has happened. They sometimes tend to generalize statements based on their own experiences in isolated areas of the disaster.

In an operational disaster the survivors may not know exactly what can be said about the work in which they were engaged. One result is that they refuse to answer any questions and therefore become “uncooperative,” calling unnecessary attention to the classified circumstances surrounding the accident. There is also the possibility of a survivor performing his own security review based on an incomplete knowledge of the disaster or operation.

Certain survivors may be disgruntled about the operation or the ship and attempt to place blame on faulty equipment, poor leadership, long hours, and so forth. The reporters, who have no way of knowing the reliability of the person, use exactly what they are told.

Other survivors may deeply resent prying eyes and vent their feelings on the media representatives.

In one notable incident, the crew of a Navy airplane that had been attacked over international waters was made available before they could be debriefed by the PAO. Unfortunately, many officials at the news conference did not know the specific details concerning the mission of the aircraft or the type of equipment it carried. Rather than disclose that the aircraft carried special equipment in the spaces normally accommodating weapons, a crewman stated that the weapons had been removed because “spree parts” were not available. This was a cover statement that backfired all the way to the U.S. Congress. To the crewman questioned, this seemed the best thing to say at the time. Navy officials agreed afterwards that a few minutes to debrief the crew privately would have been time well spent.

THE PAO AND NAVY INVESTIGATIONS

Learning Objective: *Identify the role of the PAO and senior journalist in Navy investigations.*

The Navy uses different types of investigations for different circumstances. The most common is the Judge Advocate General (JAG) Manual investigation. These are administrative, fact-finding investigations to search out, assemble, analyze and record all available information about a particular matter. Their primary purpose is to give convening and reviewing authorities adequate information on which to base decisions. “JAGMans” are purely advisory in nature and are often convened in cases of vehicle accidents, loss of government property, or in cases of injury or death to service members.

Accuracy is an important reason to withhold information about an investigation until it is complete. At any point as the investigation proceeds up the chain, it can be sent back for further work. This could change earlier decisions if new information is found.

Investigation information may also be used in legal proceedings. Therefore, it is important to protect the rights of individuals and not to prejudice the outcome of the case in court.

While PAOs and senior JOs are constrained from releasing information on an investigation before its completion and review, they should be notified when an investigation is ordered. Do not assume this will happen. You must check and double check for such information. Every person involved in the incident is interviewed, and this increases the likelihood of leaks to the media.

PUBLIC AFFAIRS ACTIONS

Public affairs, legal and investigative officers must work closely to assemble an extensive public affairs package addressing the investigation findings before they are released.

In many cases, there has already been media coverage of the event before an investigation is under way. Media may try to get information beyond what is available from your office.

Families have become a leading source of information for the media, especially if they think the Navy has done something wrong or is hiding something. An example is an incident involving a young petty officer who was mysteriously lost at sea during a supply audit. The CO telephoned the parents from overseas, trying to be as candid and conciliatory as possible. Unfortunately, his call was made before the investigation into the incident was complete. Virtually every word he spoke made the evening news, and later when the family received the final investigative results, every piece of information that appeared to contradict his early statements was highlighted by the media.

In most cases, media must file a Freedom of Information Act (FOIA) request to get a copy of investigative results. Even then, they will get an edited version because personal information on witnesses is protected under the Privacy Act. In stories with significant public interest, a cleared edited copy of the investigative results is made ready and released upon request when the findings are announced. This was the case in the release of the investigative results of the fire on the USS *Bonfish* (SS 582) and the USS *Iowa* explosion.

DIFFERENCES IN REPORTS

The investigative report provided to the families normally contains more information, such as autopsy reports, than that released to the media. The report is given to them before any public release is made and you should know exactly when the families get their copies. You should also make them aware of the differences between reports released to families and those released to reporters. Families are also unofficial and often uncontrollable “releasing authorities.”

There are exceptions to the rule. Sometimes when extremely damaging and inaccurate information is leaked to the media, it becomes necessary to release a small portion of an investigation to calm public fears. During the *Iowa* investigation, a leak alleged that many

of the sailors killed were using drugs. Autopsies revealed no trace of drugs in any of the sailors, and a decision was made to release that information.

As the senior journalist, you must be an active participant in the entire investigative process, from the initial press release to the final release of the investigative report. Building a solid working relationship with legal officers and investigators before a crisis means better planning, fewer surprises and accurate information for the public.

NEXT OF KIN

Learning Objective: *Recognize the procedures for dealing with next of kin during a disaster.*

The Navy is just as interested in the welfare of the families of Navy men and women as it is in the welfare of Navy personnel. When a disaster occurs, the next of kin suffer emotional anguish and pain almost equal to the physical suffering of those in the disaster. These people must be protected.

There are a number of ways the public affairs office can help ease the suffering of the next of kin. One way is to handle the release of news competently. This includes the prompt release of information as it becomes available, particularly the names of casualties, to ease the anxiety of families whose loved ones were not involved.

Many of the next of kin live near the base or the home port of a ship involved in the disaster. When the first news of the disaster reaches them, they converge on the base to be near the source of information. Provisions must be made for them. They should never be left to their own resources or permitted to wait outside the gate for second-hand information.

Guidelines for handling the next of kin should be specified in the disaster plan.

PAO/CACO RELATIONSHIP

Whenever possible, the PAO and senior journalist should coordinate the release of information on injured and killed Navy personnel with the casualty assistance calls officer (CACO). The CACO works under the direction of the Navy Casualty Assistance Calls Program (CACP), NAVMILPERSCOMINST 1770 series. The broad purpose of the program is to assure the next of kin of the following:

- The Navy's interest in their well-being.

- The Navy's concern in the case of members reported missing while the search for him/her is under way.
- The Navy's sympathy in their loss in the case of a death.
- The Navy's efforts to help the survivors adjust to the new conditions the tragic circumstances have imposed upon them.

As the senior journalist assisting the PAO, you can do a great deal to support the CACO assigned to a casualty that has drawn media attention. By establishing a practical CACO/PAO relationship and incorporating advance planning, media coverage can be handled in a manner that preserves the dignity of the event.

Let us say, for example, that a BM2 is killed at sea and is credited with saving the lives of several of his shipmates. The sailor's remains are scheduled to arrive at the local civilian airport.

One of the first events that will require on-scene support will be the arrival of the remains at the airport. If media coverage is anticipated, family desires regarding media interaction and presence as well as the PAO's recommendations for media interaction should be addressed early through the CACO.

Once family desires are known, planning should begin immediately and the PAO should contact airport public relations or associated officials. If standard procedures are not in place, they should be discussed well before an actual event. Learning about the organization of the airport and developing contacts will help when a high-media interest event is imminent.

Other items that should be discussed with the CACO include, but are not limited to, the following:

- **Presence of a media coverage plan.** Is there a media coverage plan designed for the arrival of the remains? If a family requests no media presence, what procedures are followed? If a coverage plan is not in place, what must be done and who should be contacted to workout a plan?
- **Coverage location, timing and logistics.** Where and when should the media meet the Navy or airport public affairs escorts? How will the media get to the coverage site? Can the airport provide transportation? Can an adjacent arrival gate or cargo area be cleared during the arrival and transfer of the remains?

- **Casket preparation before family, media or public viewing.** Caskets being moved by commercial aircraft are normally placed in a protective shipping container made of heavy cardboard or similar material (with a wood or particleboard bottom) by the Navy-contracted mortuary. This outer protective material **must** be removed before family, media or public viewing. Not doing so will result in media photos of a crated casket being taken out of an airplane, creating an image of a fallen shipmate coming home in a “cardboard box.” With the assistance of the CACO, determine who is removing the outer material and when, who is draping the casket, and so forth.
- **Family member presence at the arrival of the remains.** If family members are going to be present when the remains arrive, what is the procedure to escort them to the arrival site?
- **Support personnel.** Where will the honor guard be positioned before and after arrival? Is there a special provision to expedite getting the escort off the arriving aircraft and down to the honors site?

Be ready to give recommendations to the CACO on anticipated media interest and interaction and the church and graveside services so the family can be briefed, consulted and appropriate actions taken. One of the first steps is making an advance visit to the church, funeral home and cemetery. Some items to ask about during the advance visit include the following:

- **Inside.** What is the church’s policy on media coverage of services and the recommended media location?
- **Outside.** Where can the media be positioned to get arrival and departure photos of the remains, family and mourners with minimum disruption? What time will the remains arrive at the church? What is the route to the cemetery and how long will it take? What is the approximate start and end time of the graveside service?
- Where is the burial site? Once the site is identified, select an adjacent location relative to the sun at a distance favorable for media coverage. Rope off the area in advance. Consider parking areas and entrance/exit locations for the media and PAO escorts.

Although these guidelines are based on a specific scenario, they can be easily modified to fit your

individual needs. For more detailed information, consult NAVMILPERSCOMINST 1770 (series).

NAVY FAMILY SUPPORT

Before a disaster strikes, the PAO should meet with all command family groups to be sure they understand the organization of the command and the ways they can obtain information in a crisis. Commands may use “telephone trees” and liaison with the ombudsman to ensure a timely and accurate internal information flow. It will also assist Navy families in dealing with the intrusions into their privacy by the news media. The ombudsman network should include the following:

- Sponsor’s unit
- Family Service Center
- Unit’s type commander
- Local PAO

During a disaster, the PAO or senior journalist channels accurate information through the chain of command to the families as quickly as possible, using the ombudsman network previously described. It is a race to inform the families before the media does. The media may report highly inaccurate information in a crisis, so it is better that the families learn about it through their telephone network or even in specially called meetings.

You and the PAO may also use the external media to inform your internal audience during a crisis. For example, the establishment of a special information “hot line” at the CIB or Family Service Center can be reported by the news media to assure wide distribution to dependents and other family members. When there is an accident involving casualties, the Bureau of Naval Personnel Emergency Communications Center (ECC) at the Navy Annex in Arlington, Virginia, contacts news networks to request they publicize their emergency hot line numbers. Obtain these numbers from BUPERS and release them to the local media as well.

NAVY FAMILIES AND THE MEDIA

The Navy’s policy is to protect the privacy of its personnel and family members, especially in times of crisis. While it is the right of every American to talk to the news media if they desire, Navy family members should never feel pressured into giving an interview. If a Navy family member is contemplating a media interview, the PAO and senior journalist should offer advice and help before a final decision is made.

Convey the following points to the family member:

- **It is ok to say no.** The family member is not required to grant a news media interview request. When an interview request is granted, the right to privacy is relinquished and the individual may be harassed by other reporters or the general public.
- **Be mindful of the situation.** Care must be taken if the family member decides to talk to a reporter. Topics, such as personal experiences (emotions, reactions, etc.), are permissible, but internal privileged command information (such as the ship's scheduled port visits), command policy, hypothetical situations or speculation on the cause of the accident or incident must be avoided. The individual must avoid repeating stories or rumors and refrain from offering an opinion on how something could have been done differently.
- **Do not reveal the surname.** Tell the family member that he or she may grant the interview only if the reporter agrees to omit the surname. This can prevent crank calls and maintain family security.
- **The family member's safety and security comes first.** The individual does not owe the news media any details about his or her life.

THE MEMORIAL SERVICE

Learning Objective: *Recognize the planning aspects with regard to a memorial service.*

A memorial service involves military participation but not full military honors. It is generally held for deceased members whose remains are not recoverable. However, when a command suffers a tragedy and the remains are recoverable, it may elect to conduct a memorial service so family, shipmates and friends can pay their respects. This is primarily done to preserve the privacy of the funeral. The memorial service can be as modest as a gathering on a destroyer's fantail or occupy a large aircraft hangar at a naval air station.

For example, a main space fire claimed the lives of six sailors aboard the USS *White Plains* (AFS 4) several years ago while the ship was conducting operations in the South China Sea. A memorial service was held at Naval Air Station Alameda to coincide with the arrival of the members' remains in the United States (the ship was home ported in Guam at the time of the fire). To accommodate the many family, friends and service

members attending, the ceremony was held inside an aircraft hangar specially converted for the occasion.

WRITTEN PLAN

Every good plan must be committed to paper, and the memorial service plan is no exception. Following one or two meetings with the organizers and participants of the service, the finished plan should detail the responsibilities of those involved and include the schedule of events and a diagram of the area. For maximum effectiveness, the plan should be distributed commandwide as a notice.

RESPONSIBILITIES

Responsibilities of those involved might look something like the following:

- **Officer-in-charge:** The overall coordinator for the memorial service plan and the schedule of events. This individual is usually a senior officer in the command, but the CO may designate the PAO to be the officer-in-charge, regardless of rank. Ensures color guard, honor guard, escorts and pall bearers (if applicable) are properly briefed, trained and inspected before the ceremony. Arranges separate waiting/assembly areas for military officials and family members; provides podium, public address system and chairs; ensures medical personnel are on standby at the ceremony; briefs security personnel on the time, date and location of the ceremony and requests "free" entry for personnel attending.
- **Senior Chaplain:** Provides details for the memorial service schedule; coordinates the preparation and distribution of programs with the PAO; assigns one chaplain to each family (in the event of more than one death); meets and escorts family members to the waiting area and ceremony.
- **PAO or Senior Journalist:** Provides media advisory and naval message announcing the ceremony; produces the media coverage plan (similar to the one described in the "PAO/CACO Relationship" section); provides press assistance to families as required; briefs courtesy CACOs; produces the press release and disseminates it to the media; arranges video recordings and still photos of the ceremony; coordinates musical selections with the Navy Band (if applicable); prepares the ceremony program and ensures the

escort officers have an adequate amount for distribution.

- **CACO**: Assigns courtesy CACOs and escorts by message; coordinates all necessary arrangements for hearses, gurneys, coffin flags, and so forth (if applicable).

- **Personnel/Legal Officers**: Assists the officer-in-charge as needed.

Further information on memorial services/funerals may be obtained in Module I of the *Religious Program Specialist 3 & 2* training manual and in *Navy Military Funerals*, NAVPERS 15555B.

CHAPTER 3

THE COMMAND INFORMATION BUREAU

The assignment to a command information bureau (CIB) is one of the most difficult and demanding jobs the senior journalist encounters.

A CIB is the focal point of news media activities when there is great public interest in an event and many media representatives are expected to cover it. These events may be actual combat (Operation DESERT STORM), training exercises (REFORGER, BIG PINE) or serious incidents (Beirut bombing, Titan II and USS *Iowa* explosions). The CIB aids in creating a communication network that provides news media with easy access to the broadest possible spectrum of information about the role of the command in an event.

The CIB title is used when the event is Navy exclusive. However, when an exercise or incident involves two or more services, the CIB moniker is replaced with that of the joint information bureau (JIB). The topics discussed within this chapter apply to both CIBs and JIBs. However, for clarity, only the CIB name is used.

CIB PLANNING

Learning Objective: Identify the advance steps in planning to establish a CIB.

As a senior journalist, you must recognize as soon as possible when to set up a CIB for a particular event. The degree and quality of planning directly affect the success of the CIB operation. Planning is a critical first step that covers a wide array of areas, from a news briefing/conference time table to media credentialing, and establishing sub-CIBs when needed. When the PAO briefs the CO on the need for a CIB (and his approval is given), begin advance CIB planning immediately.

PA Regs lists six planning steps you should take to make sure the CIB serves the CO's information goals. These steps are as follows:

1. Develop a basic CIB establishment plan.

When a disaster or emergency situation hits your command, the time needed to organize a practical contingency response is at a premium. A solid CIB plan helps reduce the public affairs office response time while optimizing the use of personnel and resources.

This is especially important during the first hectic and confusing minutes of a disaster or emergency.

A special event (such as the commissioning or decommissioning of a ship or museum dedication) requires a CIB establishment plan that delineates the CIB arrangements and the methods of passing timely and complete information to the media.

2. Consider CIB establishment in all contingencies. A decision point on whether to start a CIB should be a part of your command's overall emergency action or contingency response plans. Regardless of the contingency at hand, the benchmarks you use to determine the CIB establishment are (1) the likelihood of many correspondents covering an event and (2) the chance of many correspondents crowding the public affairs office and interfering with normal business.

3. Start the CIB in advance. As the senior journalist, you have to manage personnel and equipment in an efficient manner to make sure the CIB plan is properly executed. One way to take the guesswork out of this is by establishing the CIB in advance of the operation, exercise or other high-interest event (save accidents and incidents). The CIB can be mobilized as much as 30 days in advance, giving you plenty of time to work out any glitches.

4. Provide standard operating procedures (SOPs). The CIB establishment plan should list SOPs understood by all members of the CIB team. The plan should cover the CIB configuration (and site selection, if known), location of news conferences, methods of serving media needs, ground rules, policies for receiving and answering press inquiries, and so forth. Specify CIB personnel assignments in a memorandum and distribute it to all public affairs staff members and other participants within the command. You may also post these assignments on the office Watch, Quarter and Station Bill.

5. Specify the CIB release authority. The commander who orders the establishment of the CIB must determine the individual authorized to release information to the news media and the public. The PAO is normally the officer in charge of the CIB and receives

this authorization. Specify release authority in the public affairs plan or other guidance directives.

6. Rehearse CIB activation and operation. Test the CIB plan periodically to determine its overall worth. You can check its effectiveness as part of your command's routine administrative inspection, using a developing scenario that simulates an accident or incident.

CIB ESTABLISHMENT PLAN

After advance CIB plans are in place, commit them to paper in the form of a directive. This is called the CIB establishment plan. The plan can be an appendix to the larger public affairs annex to the operations order. Appendices III and VI of this manual show examples of CIB establishment plans. (The CIB plan in Appendix VI is part of the decommissioning plan.)

The public affairs annex to the operations order is the mission task statement used to plan operations during an exercise or contingency operation. It outlines goals, attempts to solve (in advance) any public affairs problems that may arise and assigns definite responsibilities for accomplishing the work with detailed instructions for carrying it out. It follows the format used in the operation order and is signed by, and carries the authority of, the commander.

The CIB establishment plan outlines the purpose of the CIB—when and where it will be established and under what authority, its organization, commands to furnish personnel, planned movement of media representatives and observers (in general terms), communications, news conferences, briefings and news releases. It also specifies support requirements placed on other commands.

A good CIB establishment plan provides information needed for the mission without including material covered in regulations and manuals. It enables your office to be proactive rather than reactive and helps you control events, rather than have events control your operation.

Follow Guidance

Normally, the overall goal of the CIB is to fulfill the public affairs mission requirements already specified by the commander and higher authority. You can find this guidance in the following sources:

- *PA Regs*
- DoD directives

- Unified command (CINC) guidance
- Country team or embassy or host nation public affairs coordination
- Local command operations plan or order
- Public affairs annex of the next higher headquarters in the operational chain
- Commander's guidance

Determine Public Affairs Objectives

Once you determine the mission of the command, you must determine the public affairs objectives. You should find out what constraints will be imposed by higher headquarters, the embassy or the host government. Public affairs goals for a contingency plan or deployment of forces are often established at the national command authority level. Each intermediate level could amplify the goals as they filter down to your level.

Determine Procedures

You must decide what procedures you will use to operate the CIB. To do this, you should review what public affairs resources are available, determine if you need more, and if so, where and how you can get them. As stated before, determine who will have release authority and make it a matter of record in the command public affairs plan or other directive. You must determine the location of the CIB and what its responsibilities will be. You will need to decide how the media members will receive their information, and how often. You should also determine what internal information requirements exist.

TYPICAL CIB ORGANIZATION

Learning Objective: *Identify the organization of a typical CIB.*

No two Navy commands are the same with regard to structure, SOPs, personnel, and so forth. The same holds true for CIBs. Every CIB has its own unique organization and personnel mix, depending on the size, duration and news media interest in the exercise, operation or major event.

PA Regs offers a standard CIB organization from which to base your own. It is often formed under a senior PAO and includes three divisions: media relations, administrative support and liaison.

Media Relations Division

Headed by the media officer/chief, the media relations division accommodates both external and internal media representatives covering an event. This normally includes internal combat or audiovisual teams whose products are released to external or internal audiences. A media escort/briefing section, comprised of officers and senior petty officers with knowledge of the operation or the event and the needs of the various media representatives, is a key part of this division. Personnel assigned to the media relations division must be aware of the different coverage needs of each news medium in attendance. (Not recommended for nonrates; use public affairs-trained personnel only.)

Administrative Support Division

The administrative support division is headed by a local officer or senior petty officer who is familiar with the host base and local commands. This person is responsible for administrative and logistics support for the news media, including billeting, messing, transportation and communications arrangements.

Liaison Division

The liaison division provides direct liaison or briefing support when an operation or event involves more than one service (joint), an allied nation (combined), or when special expertise is required. For example, during an amphibious operation, CIB liaison officers may serve with the staff of Commander Amphibious Task Force when there is no full-time PAO available. The CIB liaison officer, in this case, would arrange for ship embarks, media tours of amphibious task force units, and so forth.

SUB-CIBs

A consideration during the planning period is the need and location of sub-CIBs. Normally, these will be in the major media outlet centers. For example, if an exercise is in the Caribbean, San Juan, Puerto Rico, and Santo Domingo, Dominican Republic, would be logical sub-CIB locations. If the operation is afloat, the CIB may be with one task group and a sub-CIB with another. Sub-CIBs ashore handle the distribution of news received from the CIB in the operational area and help with local arrangements for reporters and observers.

CIB STANDARD OPERATING PROCEDURES

Learning Objective: Identify the developmental procedures and related concerns in operating a CIB.

As discussed earlier, the extent of planning directly relates to the success of the CIB. Consider every detail and note each one in the CIB establishment plan as SOPs. Although not all-inclusive, some areas to give serious consideration to include the following:

- Personnel requirements
- CIB site selection and configuration
- Media needs
- Media pooling
- Media ground rules

Personnel Requirements

When planning your CIB manning requirements, select the most professional public affairs staff members available. Request augmenters from neighboring commands or from reserve components to support your mission. During exercises, task subject matter experts from training units to brief media members about the weapons systems or equipment in use. Make plans to get drivers (be sure they can read maps), typing clerks and interpreters (if needed).

Your CIB staff members must be tactful when dealing with others, be capable of interpreting operational guidelines, be fluent in written and oral communication, be dedicated to getting information to news media in a timely manner and be willing to make an extra effort to complete sensitive tasks under pressure. Although you may not be fortunate enough to have people of this caliber, you want people who have initiative and can work with the reporters to help them get the unclassified information they need.

Some duties required of CIB personnel include the following:

- Providing news media with copies of stories, reports, fact sheets and photographs from the PAO
- Giving assistance in setting up news conferences and interviews
- Escorting news media to the event sites or related areas

- Maintaining the CIB for safety, health and comfort
- Getting additional information about the event that may or may not have news potential
- Assisting the news media as directed by the officer in charge of the CIB

CIB Site Selection and Configuration

Consider the following when selecting the location of the CIB:

- **Security and defense.** With the aid of the security officer, secure the facility so access is limited to media members and authorized military personnel. As appropriate, consider whether the facility can be adequately defended against enemy attack
- **Exterior.** Plan for a driver or escort outside the CIB assembly area. Be sure there is enough space for parking, to include any vehicles the civilian media may bring. If the CIB is inaccessible to vehicles driven by the civilian media, you may need to setup a staging area where the media can park and be picked up by military vehicles.

Select possible CIB sites early, preferably during the initial drafting of the CIB establishment plan. Identify several locations for contingency purposes and make sure they are dispersed throughout the command. When you are identifying prospective sites, remember that the CIB could be in operation 24 hours a day for several days, depending on the severity of the event.

During exercises, consider locating your CIB away from tall buildings and radio or microwaves so the media can set up satellite dishes. (Avoid direct satellite transmission in wartime situations. The direct transmission of information without the PAO screening it could compromise operational security. Additionally, aircraft carriers and SSBNs can play havoc with commercial media transmissions.)

ACCESS TO SERVICES.— Take a look at billeting, messing, equipment and communications needs when selecting a facility. Plan your CIB so it is accessible to the media. The CIB could be in a hotel, motel, club, recreation center or even a Quonset hut, as long as it provides room for the following:

- Separate work areas for public affairs personnel and media members

- Briefing area large enough for briefers to be seen and heard
- Power sources for electronic news media
- Separate rooms for private interviews
- Adequate work space away from classified areas
- Adequate power supply to handle electronic news gathering equipment
- Public address system
- Public affairs staff telephones

CIVILIAN WORK SPACE.— Plan to separate the public affairs work area from the civilian media work area. Except when on official business, CIB prsonnel should stay out of the media work area to maintain privacy. Conversely, media members should understand that the pubic affairs office areas are open only to command personnel.

Coordinate the installation of pay or charge telephones with the command and the local telephone company if they are not already on location. Make sure there is electricity to run media equipment. Provide a light-tight room with running water for them to use as a darkroom. Plan for a briefing room that includes a map of the exercise or incident area and update the map at least daily. Include space for a common area and a lounge, and locate a bulletin board for messages near the lounge.

PUBLIC AFFAIRS WORK SPACE.— Within the public affairs work space of the CIB, plan areas for administrative support, public information and command information. Include a supply closet that can be secured and a darkroom for PAO use. Figure 3-1 is a diagram of a CIB layout.

MEDIA EQUIPMENT REQUIREMENTS.— In a wartime situation, the amount of public affairs equipment available is limited by vehicle assets. Therefore, when searching for a CIB location, make sure the following equipment is available at the site:

- Desks or tables
- Chairs
- Trash cans
- Ash trays
- Adequate lighting
- Adequate heating or cooling, as required

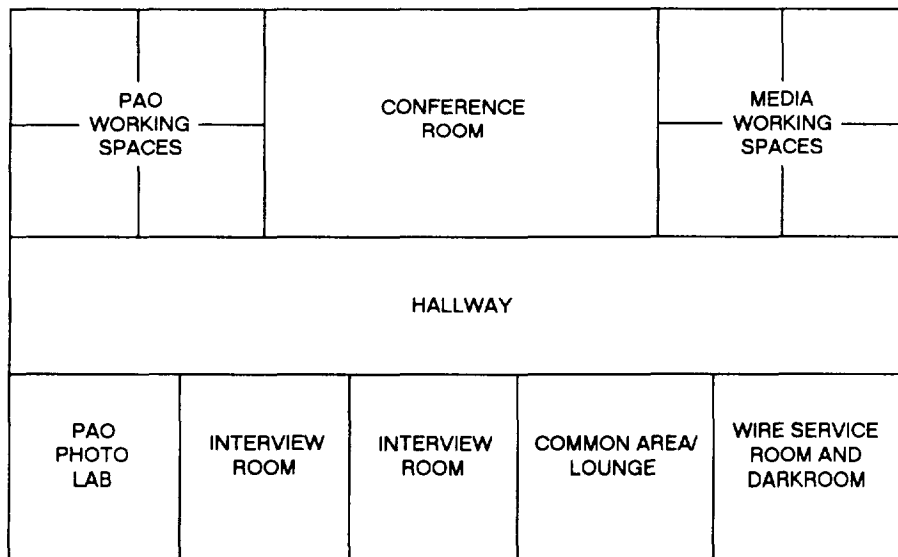

Figure 3-1.—CIB layout.

- Accurate clock with a sweep second-hand
- Telephones
- Electric power

During peacetime exercises you can provide typewriters and word processing equipment for the media. However, do not feel this is a requirement because most reporters will bring their own, probably portable laptop computers with built-in modems. You should not need to provide cameras or ENG equipment to the media.

COMMAND INFORMATION REQUIREMENTS.— You also must consider what equipment you need to support your command information mission.

Every minute counts during CIB operations (especially during an accident or incident), so you must have the needed tools on hand to operate the CIB effectively.

In Chapter 2, Lt. Cmdr. Tull referred to the PAO emergency “fly-away” box, also known as “go” or “crash” kits. Regardless of the name, they amount to the same thing—prepackaged, always-at-the-ready supplies and equipment that can be taken to the CIB at a moment’s notice. Several items are too large or cumbersome to keep physically, but you must know how and where to get them on short notice.

Consider the following items for inclusion in your crash kit:

- **Facsimile machine.** You use this vital machine every day and so does the media. Battery powered facsimile machines (ones that work with cellular telephones) are available.
- **Copier.** A high-speed duplicator with a stapler and sorter is a good choice for sustained operations with extensive media interest.
- **Portable generator.** If nobody else can give you power, you can produce it yourself. If your budget will not allow you to purchase a generator, determine who already has one and who will bring it when you need it.
- **Computer and associated equipment.** Invaluable for preparing releases and for handling a myriad of administrative tasks.
- **Cellular telephones.** Do not count on them following a major disaster (overloaded or down telephone lines due to the disaster) or in rural areas. Otherwise, when conditions are right, cellular telephones are indispensable. (Cellulars cannot be used for classified or sensitive information.)
- **Battery operated portable radio/television.** Both are indispensable for monitoring radio and television broadcasts on the event.

Remember that “no-tech” items are as important as “high-tech” items! Electronic equipment will eventually fail—it is just a matter of when and where. You can cover yourself by stocking the following “no-tech” items in your crash kit:

- Manual impact key typewriter
- Carbon paper
- Paper
- Pens
- Pencils
- Chalk
- Felt marking pens
- Staplers
- Masking tape
- Other basic office supplies
- Power cords
- Batteries
- Post-It notes
- Video and audio tape cassettes (all formats)

Other useful crash kit elements include the following:

- Large maps of the base or command area for posting in the media working spaces
- Small maps for handouts to the media
- Large blank poster boards or prepared signs to identify spaces, automobiles, and so forth
- A small functional library containing useful books, such as the various applicable Navy annuals, *Jane's Fighting Ships* and a current world almanac
- Arm-bands or large identification tags for public affairs staff personnel
- Detailed floor plans or ship's blueprints to be used in media briefing sessions

Media Needs

Detail the methods in which you will help the media in your CIB establishment plan. There are several media concerns you should address, including, but not limited

to the following: military transportation support, communications, messing, billeting, medical care and amenities.

MILITARY TRANSPORTATION SUPPORT.—

While you decide what equipment you must bring to accomplish the mission of the CIB, you must also plan on how to transport it. Vehicles used must meet the requirements of the local roads and field terrain and be able to transport heavy, bulky equipment. Additionally, operations may require the transfer of media equipment to a tactical vehicle for transport to the field, further increasing the need to make intelligent decisions on your transportation resources.

Military ground and air transportation may be required to take media members to areas where the terrain is too rough for their own vehicles. Some incidents, such as an airplane crash, might occur in areas far from the headquarters of the command.

Military transportation support cannot compete with available commercial transportation. For example, when units are deploying from CONUS to overseas exercises or operations, military transportation cannot be provided when commercial transportation is available. The exception to this is when the deployment itself is an essential element in the reporters' coverage of the exercise.

Free transportation from the CIB to military units is authorized while military transportation is available. Avoid authorizing casual, unofficial (personal) use of military transportation.

COMMUNICATIONS.— You can meet the communications needs of news media aboard ship with the use of the ship's communications system. Coordination with the communications officer is essential. You and the PAO must plan for reviewing reporters' stories to make sure there is no adverse impact on operations, security or safety of the unit. After your review, the CO or his specially appointed representative (usually the communications officer or security officer) will review the stories and approve them for transmission.

Reporters may be hesitant to submit their stories for review. However, you must reassure them that the reviews are strictly for security reasons and not censorship. If a story contains classified information, politely ask the reporter to remove it. If the reporter refuses to edit out the classified or sensitive portions, send the story as a classified message to the proper fleet commander in chief (with an information copy to CHINFO) for a ruling. *PA Regs*, Chapter 3, and the *Navy Communications Manual*, NTP-9, provide further

information about the use of Navy communications facilities by the media.

Telephones are essential for most news media ashore. Pay telephones are ideal for the CIB, or you may plan to set up special or credit card telephones. (The business office of the local telephone company will usually do this for free.)

Other communications needs may include duplicating services, the installation of wire service (AP, UPI) and photo lab services. If authorized, the cost of chemicals and operator time may be reimbursable.

MESSING.— Media members should get their food from civilian sources, such as restaurants and grocery stores. If it is more advantageous for the Navy to provide messing facilities at the CIB or to allow access to messing facilities near the CIB, reimbursement may be required. Consult the supply officer for guidance in this matter.

When reporters are escorted from the CIB to ships or units in the field, especially on one-day trips, MREs (meals ready to eat) should be issued at the CIB before departure. The unit hosting the media is not required to provide meals, although it may do so. Individual reporters who stay with a Navy unit may receive messing support from the unit as long as it does not place an unacceptable burden on the unit. Meals received in such instances may or may not be reimbursable, depending on unified command guidelines.

BILLETING.— When civilian berthing is available, media members are **not** authorized the use of military billeting (except for DoD media pool members, who are billeted with U.S. forces). Sometimes, reporters are billeted with U.S. forces when it is clearly in the best interest of the U.S. government.

When civilian billeting is not available and billeting is provided in facilities owned or operated by U.S. forces (to include “tent cities”), reimbursement may be required as directed by the unified command. If media members accompany military personnel in field locations and civilian billeting is unavailable (or not advantageous to the military), news media may be invited to use the same shelter as provided to the personnel of the unit. Reimbursement in this case is not required.

MEDICAL CARE.— Media members will receive care from military medical personnel and facilities when civilian medical care is nonexistent or inadequate. Reimbursement is not required for sick call care.

Report serious injury or illness requiring major medical care to the officer in charge of the CIB. Report the treatment through command channels to the reporter’s sponsoring news organization. Unified command PAOs will decide on reimbursement after consulting with medical personnel and judge advocate general (JAG).

If the reporter must be evacuated from the theater of operations, let the sponsoring news organization know through command channels. The sponsoring news organization, not the DoD or Navy, is responsible for notifying next of kin and releasing the names of reporters who are seriously ill, wounded or killed.

AMENITIES.— Among the amenities normally provided to news media are those that contribute to their health and welfare. To accommodate individual needs and lessen personal discomfort, put together CIB media information packets that contain the following items:

- Diagram and complete description of the CIB, including operating rules
- Important telephone numbers
- Living or working conditions
- Availability and location of housing and meals
- Important places in the area, installation or ship in map or diagram form
- Command mission and policy statements (ground rules)
- Off-limits areas
- Rights and privileges of civilians in a military environment

The CIB may provide coffee, tea and food to reporters on a reimbursable basis. If exchange facilities are available, reporters may be granted access if the exchange can provide enough supplies for military personnel first.

Media Pooling

Make plans for establishing a media pool. A media pool should be formed when many media members are at the CIB and cannot be transported to the event site because of limited transportation, space or equipment. You and the PAO must keep the reporters aware of any limitations so they may decide among themselves who should go and who should stay behind. The media pool should be bound by professional ethics to share information with the reporters who stayed behind.

The following media pool representation provides the best coverage for an event:

- A photographer from either AP or UPI and one reporter from each (top priority)
- At least two television representatives (one correspondent, one camera or audio technician)
- A reporter and a color photographer from the news magazines
- At least one reporter from the daily newspapers
- A radio representative

Representatives from other press associations, radio and television networks and newspapers also could be included if there is room. Keep out of the decisions of who goes and who stays and avoid challenges of favoritism.

Media Ground Rules

Media members must be given written policy statements that spell out the ground rules concerning their activities, their rights and privileges and items of local interest. You may want to incorporate the following ground rules:

- Media may be authorized to sit in on press briefings, travel in military vehicles, use communications, messing facilities, billeting and medical facilities and to be brought in close to sites for photographs or interviews that would otherwise be denied.
- Media must stay with their escorts when it is required, obey security restrictions (describe what might happen if they include sensitive material in their reports) and follow established ground rules. You must tell the media that they will lose all access to information from public affairs official sources if violations occur.

CREDENTIALING

Learning Objective: *Outline the procedures for credentialing members of the media at the CIB.*

Part of your overall CIB organization should include a credentialing process for the media. Credentialing allows you to keep track of the reporters at the CIB and the area of operation. You also can use information obtained from the credentialing process to brief the CO and include in your after-action report.

IDENTIFICATION VERIFICATION

When reporters are escorted from the front gate to the CIB, ask them for some type of identification. This includes press cards, introduction letters signed by the editor on letterhead stationery, or in the case of free-lance reporters, letters of agreement with an established news organization. You can also check their passports, visas or shot records.

Issue credentials only to bona fide news correspondents. Randomly contact the news organization the reporter says he works for to verify his employment. Sometimes, a news organization will say it has never heard of the person whose identification you hold in your hand. You can be quite certain this person is not a true member of the media. They may be spies or nosy locals wanting to know what is going on. Whatever the circumstance, people pretending to be reporters should **not** get the same access to information as reporters with credentials. When verification uncovers fraudulent or expired credentials or letters of agreement, revoke the credentials (if they have already been issued) and contact security personnel immediately.

REGISTRATION

Register the media members by recording their names, telephone numbers of where they work or are billeted and the address and telephone number of their news organization. The reporters must also complete three forms dealing with ground rules, a waiver agreement and a statement of charges.

- **Ground rules.** The ground rules form is just that—a statement that they have read the ground rules of the CIB. Reporters who desire credentials will sign the form as an agreement to follow these rules.
- **Waiver agreement.** This is a form you should prepare with the help of the legal office. It states that they, and their survivors, will hold the U.S. government harmless if they are injured or die as a result of covering military action.
- **Statement of charges.** The statement of charges (also called a letter of credit) lists the reimbursable services they may use.

BADGE ISSUANCE

Issue each reporter a badge or card and identification tag. The badges are a controlled item. The reporters must agree to keep them in their possession as

long as they are in the theater of operations and to return them when they leave. The badges must contain a statement that they are the property of the U.S. government and that the holder will turn in the badge and identification tags if ordered to do so by public affairs personnel. Normally, only the issuing CIB will revoke badges and identification tags for cause. Make sure base security personnel know what the badges look like. In some situations, provide the credentials at an off-base location.

FOLLOW-UP ACTIONS

Periodically credentials should be reviewed, revalidated or withdrawn. Credentials should only be withdrawn following a change in the reporter's status, upon request by the sponsoring news organization, or for cause when ground rules have been violated. Commanders should report violations of ground rules or any action that threatens operational security through command channels to the credentialing PAO for appropriate action.

DISSEMINATING NEWS

Learning Objective: *Identify the methods used in disseminating news to the media.*

The CIB establishment plan will not be complete without a section on how you will disseminate news to the media. No matter how simple or elaborate your plans may be, the key to success in this area is remaining flexible, especially when plans go awry.

Certain actions help provide the news media with the best information in the shortest time. This is the very heart of a CIB and close attention should be paid to the following activities: news briefings and conferences, interviews, news releases, background information, bulletin boards, photo boards and audiovisual equipment and materials.

NEWS BRIEFINGS AND CONFERENCES

Media members must be informed of the time and location of news briefings, usually held twice daily for update briefings. News briefings are used to update reporters on the situation, to announce the availability of escorted transportation and to answer or take news media queries. Daily briefings may be held in the morning and evening. Briefers are normally PAOs, but you may be tasked to conduct one.

Special news briefings may be held whenever news interest is so great on a single action or activity that a

briefing becomes the most efficient means of handling media members. For instance, if a helicopter crashes in isolated terrain during an exercise, a special briefing can be held to inform the media of the accident, to organize a media pool to fly to the accident site or to release information as it becomes available.

A news conference is a type of news briefing irregularly held. It is characterized by the attendance of the CO or other military experts who will issue a statement and provide answers to news media queries. Usually, such conferences are centered on a specific topic, although the media may (and probably will) ask questions on unrelated material. Make every effort to inform media members of upcoming news conferences, and they should be given adequate time to arrive for the briefing.

Under extraordinary circumstances the CO and the PAO may choose to brief participating reporters about future operations. Such background briefings are conducted with the agreement that information will not be reported until no harm could come from its public release. Background briefings are risky. Do not give background briefings unless a high degree of mutual trust and respect exist between the Navy and the reporters involved. Violation of such trust is grounds for immediate withdrawal of accreditation.

INTERVIEWS

Reporters sometimes have specific requirements for information that is best collected through personal, one-on-one interviews. Such interviews should be scheduled as often as possible when requested by news media and when the interviewee agrees. The CIB concentrates many news media in a small area with all working from the same information. Interviews allow different, more complete and more credible reporting opportunities for news media.

When possible, especially when requested by the interviewee, you should record these interviews.

NEWS RELEASES

Military journalists and photographers have story and photo opportunities their civilian peers do not have. Accordingly, the CIB prepares releases when something newsworthy occurs. These releases should only complement the stories being released by the media. Avoid duplicating or competing with the efforts of the news media and releasing hard-sell pitches about the military. Let military actions speak for themselves.

However, do not lose sight of the need to tell the story from the military perspective.

BACKGROUND INFORMATION

Make available fact sheets and verbal statements to help news media understand equipment, personnel and actions of the command. Unit histories and biographies of key commanders should also be available.

BULLETIN BOARDS

Copies of news and feature stories released by the CIB should be posted on bulletin boards in either the conference room or the media working spaces. Devote one section to recent releases and another to all previous releases. If the number of releases exceeds available bulletin board space, place the oldest releases in a three-ring binder and keep it near the bulletin board. Make at least one copy of each release available to each news person present at the time of release. Maintain extra copies of all releases for use when requested. Number written releases and maintain them in a news release file.

PHOTO BOARDS

Photo boards contain pictures taken by command photographers and include captions. Copies of the prints posted are available to news media at no cost and are standard 5- by 7-inch or 4- by 5-inch formats. As with written releases, number each photo and keep complete documentation in the CIB photo release files.

AUDIOVISUAL EQUIPMENT AND MATERIALS

The CIB normally has suitable audiovisual equipment and materials, preferably in the conference room, so documentation of news conferences and interviews may be obtained. Video and audio recording systems are essential. Additionally, backup units in all tape formats should be available. Where necessary, platforms may be built to accommodate motion picture, videotape recording equipment or an overhead projector

and a slide projector, preferably in the rear of the room. These platforms should be large enough to allow mutual use by CIB personnel and the media photographers.

The following are other audiovisual considerations:

- Is the power source to the CIB sufficient to handle the load required? If central power is disrupted, is there a backup system available to run cameras and other power equipment?
- Is the area provided for briefers and interviewees aesthetically pleasing and neat in appearance? Are colors compatible? Are "busy" backgrounds eliminated? Is lighting adequate? How will the interviewee appear on film or videotape and is this image compatible with the news event itself and the military part in the event?
- Is audiovisual equipment mobile enough to permit command coverage of events outside the CIB?

AFTER-ACTION REPORT

Learning Objective: *Recognize the items included in a CIB after-action report.*

Complete an after-action report once the CIB has ceased operations. Note the problem areas you encountered during the incident or exercise and make recommendations for improvements. You can include an overall view of operations, specific areas of interest, a sequence of events and a list of the media representatives who called or visited the media center.

Use careful analysis and complete objectivity when you sit down and write the CIB after-action report. There is no doubt you noted obvious problem areas almost immediately. What about the areas that worked as advertised, but need the rough edges smoothed? You can draft a comprehensive after-action report by going back to the CIB establishment plan and evaluating it one section at a time. You will have to put some time into writing it, but your efforts will provide you with the feedback required to improve future CIBs.

CHAPTER 4

MEDIA RELATIONS

Media relations is an important facet of your public affairs office operation, yet it is often underemphasized or taken for granted. Depending on the events at your command, media relations can be your number one priority and easily consume most, if not all, of your public affairs workday. Whether it be a colorful change of command ceremony or a plane crash with several fatalities, you can count on interaction with the media. Therefore, you must understand the complex media machine—its parts, strategies and concerns. This understanding will help you recognize the elements that form the foundation of good media relations.

Also, you must know how to establish credibility for yourself, office and command, and recognize the strategies you can use to release information to the media. This chapter covers these areas and more.

IMPORTANCE OF SOUND MILITARY/MEDIA RELATIONS

Learning Objective: Recognize the importance of sound military/media relations.

Americans deal with large amounts of information every day. The Navy and the American people are now being led by a television generation of workers and young leaders. To reach the public in this age of instant television, you must understand the strengths and weaknesses of the mass news media and know how to use them most effectively, particularly the television medium.

TRENDS

Two trends in American society make the task of communicating the Navy's message more demanding. First, since the military draft ended in 1973, fewer and fewer Americans have had firsthand military experience. This group cannot adequately judge the fairness of military information in news reports. The public must rely on the reporter to balance his story, which may or may not apply, depending on the reporter and the editors or producers.

Second, a generation changing of the guard has come to the journalism industry. When the draft ended, the news reporters who usually showed up at military

events were most likely high school teenagers or college students. Reporters who are now in their late 20s or early 30s (as of this writing) were in journalism schools in the late 1970s when the military image was shaped by anti-Vietnam and post-Vietnam trends on the campuses of America. Therefore, these reporters are skeptical at best, and hostile at worst.

With this in mind, you and the PAO must reach out and educate the new generation of reporters and the public. The best way to do this is to open a dialogue with the news media by learning to communicate better.

PUBLIC OPINION

We are now in the post-cold war period experiencing a major change in how American society deals with domestic and international relations. There is a new world order with more multipolar power dispersal. Worldwide economic competition and domestic concerns, such as the war on drugs, AIDS, the federal deficit and environmental problems are at the forefront of the American agenda.

As American priorities change, it is important to talk to Americans in a manner that relates to these changes. We must note that, regardless of the American public's mood of the moment, its confidence in their military is strong. This is reflected in the Gallup public opinion poll in figure 4-1.

News Media Role

One characteristic most Americans have in common is that we begin our day watching, listening or reading the news. What the public thinks depends largely on what the public hears. The American news media are the American citizen's "intelligence network." The headlines of the evening newscast tell us what is important in society.

In the past 10 years, the worldwide Cable News Network (CNN) has become the electronic "plug-in" news source of choice for military command centers, newspaper editorial offices and business travelers around the world.

Institution	1991	1990	1989	1988	1975
Military	85%	68%	63%	58%	58%
Church	62	56	52	59	68
Supreme Court	48	47	46	56	49
Public Schools	40	45	43	49	NA
Newspapers	29	39	NA	36	NA
Banks	41	36	42	49	NA
Organized Labor	24	27	NA	26	38
Big Business	24	25	NA	25	34
Television	33	25	NA	27	NA
Congress	28	24	32	35	40
Categories "A Great Deal" and "Quite a Lot" Lumped Together in Percentages					

Figure 4-1.—Gallup public opinion poll reflecting strong public confidence in the military.

War of Words

It was clear in the 1990-1991 Operation DESERT SHIELD/STORM that political and military leaders must be involved with the news media to communicate their views to the American and international publics. In fact, *Fortune* magazine reported that President Bush included the use of the news media as one of his main "tools of crisis management." Leaders know that to gain public support and trust, they must reach out through the news media. It is also true that our enemies and military critics are "media street smart."

MEDIA TYPES

Learning Objective: *Identify and analyze the various types of media.*

To be successful in disseminating information through mass media, you must analyze all available media. You must determine the requirements of each medium and then, within the limits of security, accuracy, propriety, policy and resources, fulfill these requirements. By serving each medium's particular

requirements, you prove a principle of communication (know your audience) and a principle of the public affairs profession (give the media what they need in a way they can use it).

Your public affairs office should serve (at least) the following media and be familiar with their requirements:

- Newspaper
- Radio
- Television
- News services
- Syndicates
- Magazines
- News magazines
- Consumer magazines
- Internal or promotional publications
- Books

You must not favor one medium over another; however, you must take advantage of the potential and recognize the limitations of each for circulation, selectivity of publics, influence or prestige, appearance and flexibility in the timing of news releases. One common limitation is that coverage does not guarantee public knowledge or understanding of an issue. You cannot expect radio to do a job that is better suited for a newspaper, or for a newspaper to do the entire job of communicating in an era when the electronic media have access to virtually all American homes.

NEWSPAPER

The newspaper is the oldest medium of mass communication and the backbone of public information. While the number of newspapers published in America has declined with the ascendancy of television, total circulation is increasing.

Characteristics of newspapers include the following:

- Attraction of habitual readers and a tendency to build confidence among them
- Coverage in greater depth than broadcast or pictorial media
- Style of presentation and organization that permits gaining superficial knowledge of readers
- Timely coverage when compared to magazines or books
- Provide information and entertainment that help shape public opinion
- More permanence than messages from electronic media or oral communication

There are differences between the metropolitan daily, the suburban or neighborhood daily and the weekly newspaper. Where a metropolitan daily focuses on international, national and top-level local news and features, a suburban daily (or weekly) may limit itself to local and regional news with only brief summaries of national and international news. Suburban newspapers have grown in popularity recently because of their comprehensive coverage of local news.

RADIO

Radio became a medium of mass communication in the 1930s. Its advantages are immediacy, variety, mobility and aural appeal. Because of the recent

resurrection of the AM news/talk format, the radio listening audience may include nearly every individual in the country.

Radio is conversational, informal, intimate and timely. It has an almost instantaneous reaction time to fast-breaking news but is limited to headlines and high points.

TELEVISION

Television is the newest and most potent of mass communications media. It combines the impact of sight and sound with the immediacy of radio. Communication satellites and roving news teams can relay live telecasts from almost anywhere in the world or even outer space. Television has extended the eyes and ears of Americans to the point where they are participants in the "global village."

Television news programs are network (60 Minutes, 20/20, etc.) or local in origin. Most local stations do live coverage and welcome the opportunity to consider videotapes of significant military news or feature events, including sports.

In many areas, television stations are owned by or closely allied with newspapers. Most use both The Associated Press and United Press International wire services.

Your office may be called upon by radio and television broadcasters to help produce news programs about military topics. When requests come from local television or radio stations, you should provide help as long as you do not violate the basic considerations of security, accuracy, propriety and policy or interfere with the military mission. Providing technical help to broadcasters is routine at military bases.

There is no common standard for preparing news feature material used by all broadcasting stations. You should determine each station's requirements for format and length of news items and features, size of still news photos and preferences for slides, photos or videotape footage.

NEWS SERVICES

News services, often called wire services, exist to provide the mass media with coverage they cannot afford to get by any other means. Mark Twain once said, "There are only two forces that carry light to all concerns of the globe, the sun in the heavens and The Associated Press down here."

Wire service representatives are important media contacts. Consider them in all public information activities and invite them to participate in military news or news-related events within their areas. They are seldom available for extended press trips or maneuvers at a distant location, since their responsibility is normally only for news in their general area.

Members of other news media are often employed by wire services as stringers for a news service, feature service or news magazine and should not be overlooked in any public information program.

Currently, there are two predominant wire services in the United States: The Associated Press and United Press International. You should be aware that there are also several foreign wire services.

The Associated Press

The Associated Press (AP) is a nonprofit service owned by its members. Members take news items from the AP teletype and feed local items into the system. Consequently, a story of broad human interest from your command may be relayed around the world in a few hours. AP serves overseas publications and broadcasting organizations that have the status of "subscriber" rather than "member," but they still share in its costs. AP also offers photo service and technical advice to its members and subscribers.

United Press International

United Press International (UPI) is a profit-making service that sells news and feature material to mass media. It offers virtually the same services as AP, including a wire-photo service, features, news film and audio service. UPI evolved from the former United Press and International News Service.

World News Services

News services from other nations, such as Reuters (England), Agence France Press (France) and Xin Hua (Peoples Republic of China) also supply news to their national media. These services generally report significant U.S. news. In 1967, Reuters entered the American news distribution market after the end of a 50-year business agreement with AP in which British and American news was exchanged. Reuters began to distribute American news to subscribers within the United States and those in the United Kingdom. It also established a U.S. financial news service for American clients.

SYNDICATES

Syndicates are either owned by a large newspaper or chain of papers, or they are the result of cooperative agreements among noncompeting papers. They often provide in-depth stories of what the wire services report as spot news. Examples are as follows: NANA (North American Newspaper Alliance), NEA (Newspaper Enterprises Association), *New York Times*, *Chicago Tribune*, *Los Angeles Times* and the Hearst Headline Service.

MAGAZINES

Magazines may be grouped as news, consumer or internal/promotional publications. Magazines have wide circulation, though they are published less frequently than newspapers.

Few magazine editors want news releases except as possible leads for staff-written stories. An editor provided with feature material and good pictures of interest to his readership may either follow through with a staff-written article or at least adapt the material as a filler.

Requests for help on Navy features made by a national magazine must be approved by CHINFO before information is released or support is given.

NEWS MAGAZINES

News magazines (*Time*, *Newsweek* U.S. *News and World Report*) are national weekly newspapers covering the major news of the week in greater depth than daily newspapers or the electronic media. They have the following characteristics:

- **Interpretation.** A clearer meaning is given to items reported in small amounts during the week.
- **Background.** With time to dig more deeply, more information can be developed to place a story in perspective.
- **Review.** A reader can catch up on news he may have missed in the daily newspaper.
- **Selectivity.** Material printed is selected carefully for national or international significance.
- **Performance.** Printed on good stock, it stays in the home or the office for longer periods.

CONSUMER MAGAZINES

Consumer magazines appeal to various special interests of the public. Technology, business, sports, hobbies, theater, gossip and humor are among the major subjects reported. These provide an opportunity to tell a story in greater detail or from a particular point of view. Stories need not be as timely as in a news magazine.

INTERNAL OR PROMOTIONAL PUBLICATIONS

Internal or promotional publications reach the internal and external audiences of companies, agencies, professions or vocations. They are also called trade journals and house organs. *Public Affairs Communicator* is an example of a trade journal.

BOOKS

Many PAOs and senior journalists are asked to assist authors of books dealing with military subjects. More than 30,000 books are published in this country annually. Because of the continuing importance of the Navy and the armed services as a whole to our society, authors of virtually all classes of books (nonfiction, adult, juvenile, general, text and pictorial) rely on the public affairs office for help in gathering material.

You may assist book authors by making available unclassified research or background materials. Contact CHINFO when an author's request involves more than locally available materials.

MEDIA ACTIONS

Learning Objective: *Identify the various types of media actions that lead to distorted messages.*

Pure media consumers do not have a difficult time understanding the news media. However, when a media consumer is faced with actually using news media channels, that person must have a more detailed awareness of how the media operates.

The following is a list of the general news media "sins" that lead to distorted messages:

1. **Short deadlines.** Reporters are always under tight deadlines, which means you must be prepared to react, on short notice, if it is in the best interest of the command.

2. **Time or space limitations.** Print, radio and television have very small spaces (such as a paragraph)

and short periods (such as a minute, 30 seconds) to tell your story.

3. **Inexperienced reporters.** Most reporters do not know the difference between a rear admiral and a chief petty officer. Military reporters relate to the word *Tomahawk* as an American Indian weapon, not a U.S. Navy cruise missile. Translate military terminology into civilian terms, if possible. Educating the reporter before an interview helps.

4. **Nonattributed news.** Be careful when using sources without clearly identifying them, such as "a naval officer said. . . ." Establish interview ground rules *before* the interview and how you will respond to unknown sources or critics. Ground rules will be discussed later in this chapter.

5. **Editor negligence.** Information suspected of being wrong or misleading is not always checked out by senior editors. The PAO should always challenge data or facts that he believes to be wrong and go directly to the reporter's boss if necessary.

6. **Competition.** Too often, a sloppy job is done by news reporters because of news media competing to get the news first. However, competition can be positive. For example, editors and news directors know that if reporters are abusive to sources, access will eventually become more difficult and the competition will have an edge.

7. **Prize journalism.** Some reporters are looking for the big story of waste, fraud and abuse to win professional acclaim and praise.

8. **Mob journalism.** In a crisis, many news reporters arrive on-scene and demand access to crisis events and interviews. You must be cool and stay in control if this situation occurs.

9. **Pack (trend) journalism.** Once a single exclusive story hits the wire services, a whole pack of stories on the same subject appears. For instance, if the Navy experiences a series of aircraft accidents over a short period, the media pack will focus its stories on naval aviation safety and training.

10. **Checkbook journalism.** News media "buy" a story or source. For example, a television station may pay air fare, meals and lodging to bring a family (next of kin) to the crisis.

11. **Hitchhiker journalism.** A reporter, who thinks something important has or is about to happen (at a base or ship), stations himself outside the gate and picks up

a sailor. A social conversation soon centers on the reporter's area of military interest.

12. **Mismatched headlines.** A copy editor puts headlines on a story, **not** the reporter who wrote it. With time and space constraints, catchy headlines are vulnerable to error. **Do not blame the reporter for a bad headline.**

ROLE OF THE PAO/SENIOR JO IN MEDIA RELATIONS

Learning Objective: *Recognize the role of the PAO/senior JO in media relations, and develop an awareness of news media communications strategies.*

In most cases, the CO readily consults the PAO and senior journalist for sound guidance about news media encounters. Remember, the CO is not the public affairs specialist of the command—you and the PAO have earned that title. If you cannot provide the answers for the CO, assure him that you will get them. Do not expect the CO and XO to take up the slack and deal with media concerns directly.

The CO relies on the PAO and senior journalist to perform the following media-related functions:

- Advise if a media interview is a good idea, is authorized and within policy to do.
- Research the interview issues.
- Research background on the reporter and news organization working the request.
- Act as the interviewer in rehearsing the possible questions and answers likely to be asked during the interview.
- Arrange the interview, including the establishment of ground rules and location.
- Monitor the interview and tape-record to make an in-house record, and follow up on any promised items to be provided later.
- Act as liaison with the news organization, and provide video copies or news clippings of the interview to the interviewee.
- Provide after-action feedback to determine if the desired message was delivered.

In the previous chapter segments, we covered the strengths and weaknesses of the news media. Now we will cover ways the Navy uses to **educate** the news

people who have the tendency to be skeptical of the military.

The three communications strategy options are as follows:

- Reactive
- Proactive
- Winging it

Obviously, the Navy will use the reactive strategy in unanticipated events, such as an accident or incident. However, the best option is to be proactive and plan public communications as carefully as military leaders plan an operation.

Avoid the “winging it” communications strategy. Why? Because you run the risk of backing down to critics in the communications “war of words” battle. If this is done, the critics will educate the news media, our families and the public while we remain silent.

The proactive strategy provides the following benefits:

- The ability to see media regularly by allowing access.
- The ability to recognize that each reporter is different by getting to know each one respectively.
- The ability to recognize that each news organization has different needs by knowing that particular organization. (For example, television needs action video while print media need words and photos.)
- The ability to receive unforeseen benefits by providing a candid and honest approach to news people. (For example, if a reporter respects you, he may call you before running a negative story to get your side of it.)

The proactive strategy also offers an opportunity to gain new insights from news persons. Reporters often provide valuable insight into issues and events of vital interest to military people. By casually interviewing the interviewer, you can get an entirely new perspective to an existing issue.

RELEASE OF NEWS TO THE MEDIA

Learning Objective: *Identify the various methods used to release news to the media and any specific associated characteristics.*

Acting for the CO, the command PAO has the authority to release routine Navy information to the media and public. Releasing news can be a tricky matter for the PAO. He must balance each release between the principle of “maximum disclosure with minimum delay” and the constraints that come with security, accuracy, propriety and policy considerations.

Whether the information is volunteered or demanded by a media query, the PAO, with your assistance, must answer yes to the following questions before it is offered to the public:

- Is the information unclassified?
- Is it accurate?
- Is the information free of privacy act violations?
- Does the command have the authority to release the information?

If you and the PAO cannot give a firm “yes” to each of these questions, seek the advice of the PAO in the next highest command in the chain.

After you have checked the information for classification, accuracy, and so forth, the next step is releasing it to the media. There are several commonly used methods you should consider, including the following: news release, news advisory, oral release, interviews, news conference, media embark, visual release and marketing.

NEWS RELEASE

The news release is the most common method of distributing news to the media. It is an economical, but not the most reliable method. Its role in getting an organization into print for a low cost of production and distribution makes the news release a borderline nuisance to editors. Usually referred to by editors as a “handout,” it clogs the editor’s in-basket and is often resented, though the mass media save millions of dollars in reporting expenses through this distribution method.

A news release must be worthy of an editor’s attention, space and time. Accuracy, professional preparation and timely delivery are essentials. Releases should be identified clearly with the source, subject and what the originator wants the editor to do with it (immediate release, hold for release, and so on).

The name, address and telephone number of the organization’s PAO should appear on the news release in case the editor wants to verify or get additional facts. Most public affairs offices use preprinted release forms.

Editors most often complain that news releases are like meals served by indifferent housewives—merely dishing out the canned goods. Therefore, you must avoid the following common pitfalls of news releases:

- Mentioning the name of the CO in every news release no matter how insignificant his involvement.
- Using cryptic military terminology or acronyms when it is not essential to the story or even understandable to a civilian audience.
- Using subjects that only interest the military—for example, sending an internally oriented story to a city editor.
- Sending exactly the same release to all types of media regardless of their unique requirements.
- Writing news releases in a magazine style or using too much space for what needs to be said. Releases more than one page in length frequently end up in the wastebasket.

Despite its shortcomings, the news release does find its way into print. It can be mailed, hand-carried or telephoned, depending on the circumstances.

The following comments of one city editor emphasize the importance of letting the news release speak for itself once you have sent it to the editor:

“Please, if that is a handout, just give it to me. If we can use it, I will ask a reporter to rewrite it. If we cannot, I will throw it away. Do not hold it under my nose and read it to me with your finger tracing every line. I can read. And do not suggest that we have a little talk about it. I do not have the time for conferences. No use standing there. There are 17 more ‘press agents’ waiting to see me.”

Most editors and news directors prefer a simple fact sheet to an artfully contrived news release.

NEWS ADVISORY

A news advisory is an abbreviated form of a news release that is intended to get the news media to cover an event themselves. The news advisory is usually a page in length and includes the following information:

- A compact description of the event the command wants the news media to cover.
- The date, time and place of the event.

- The significance of the event in capsule form and its relevancy to the editor's reading, listening or viewing audience.
- The details of the event, including any attractive features that would give it more appeal to the editor (for instance, the arrival of a ship at its home port following a seven-month overhaul).
- The unique "opportunities" that will be afforded to the news media, such as interviews and photography.
- The command point of contact who can answer questions.

ORAL RELEASE

Oral release of information maybe made in person or by telephone. When telephoning information to the media, read the release from a prepared text.

Another oral method of releasing news occurs when you reply to queries from media representatives. In this situation, a "query sheet" should be used. The query sheet should contain the following items of information:

- Date and time
- Name and organization of the caller
- Telephone number of the caller
- Question(s) asked
- Reply given
- Source of information and coordination
- Person handling the query (especially in a large office)

Use the query sheet to reply to all questions, but its use is especially crucial when you make oral releases of sensitive news, such as crimes, accidents or incidents. A sample query sheet is shown in figure 4-2.

INTERVIEWS

Interviews with the PAO by a reporter on subjects that cannot be covered readily by fact sheets are common. Unless a PAO has full information on a subject or if the PAO is inexperienced, he should use extreme caution in participating in such interviews since normally any comments will be considered official statements.

Interviews with subject matter experts or newsworthy individuals are usually arranged by the PAO at the request of a news person. Briefing interviewees before the interview is highly recommended to cover ground rules, the anticipated interview type or technique and any media training required.

Reporters often feel the need to interview the CO on newsworthy or important events or circumstances. You and the PAO can enhance the outcome of the interview if it is first discussed with the reporter and then with the CO before it takes place.

Ground Rules

Each time the PAO and a reporter meet, whether it be at a news conference, briefing or interview, the ground rules must be stated clearly, understood and mutually agreed to by both parties before the interview begins. These ground rules include the following: on-the-record, off-the-record, background/not for attribution and deep background.

ON-THE-RECORD.— Remarks can be quoted word for word and attributed directly to the person being interviewed. The interviewee is identified by name and title. Here is an example: "Captain Alexander Gordian, USN, Commanding Officer, USS *Blue Blazer*, said the injured crewman was taken to Portsmouth Naval Hospital and could not be identified until next of kin were notified." To avoid embarrassment, the best rule of thumb is to grant interviews using only this ground rule.

OFF-THE-RECORD.— Information that is to be held incomplete confidence. It is not to be printed under any circumstances or in any form, nor is the information to be the subject of conversation except among those who were privileged to receive it. Off-the-record information is used to give trusted reporters special information they need to grasp the significance of complicated news events. It is also used to orient correspondents about important future events that will require special handling by a thoroughly informed press. It is an effective means of calming undue media alarm over particular developments.

A word of caution: Off-the record statements can be dangerous. Avoid them as much as possible

BACKGROUND/NOT FOR ATTRIBUTION.— Information that may be used by correspondents, provided the remarks are not attributed to a specific source, for example, a source identified by name or

QUERY SHEET

Taken by _____ Time _____ Date _____

From _____ Of _____

Telephone _____ Deadline _____

Question: _____

=====

Date and time of response: _____

Response: _____

Query referred to: _____ Date _____ Time _____

Source of information/coordination: _____

Approved by: _____

Given to: _____ Time _____ Date _____

Method of release: Telephone _____ Orally _____ Printed _____ Other _____

Given by: _____

Figure 4-2.—Query sheet.

exact title. The source can be identified in general terms, such as a “Pentagon spokesman,” “government official,” “qualified authority,” and so forth.

DEEP BACKGROUND.— The source is completely omitted but the reporter can use the information. Example: “It has been learned that Admiral Little resigned because he was forced out by. . . .”

Types of Interviews and Techniques

There are several types of news media interviews, ranging from impromptu ones in a crisis to long-planned, easy going talk-show type of interviews. The senior journalist must know the types of interviews and the techniques involved for two reasons. First, there may come a time when you will be the subject of a media interview if the PAO is unavailable (or if you are serving as a PAO in a smaller command). Second, you are frequently called upon to conduct media training for those individuals scheduled for a media interview.

ACCIDENT OR INCIDENT.— In the highly-charged emotional atmosphere of an accident or incident where news media may be denied access due to ongoing investigations, recommend to the CO that he make a brief statement to the news media and take a few questions. With the help of the news media, the CO may do the following:

- Reach out to crew families and assure them that the CO is in charge, all that can be done is being done, and so forth.
- Tell the public of heroic acts.
- Express thanks to those individuals or organizations involved in rescue, firefighting, and so on.

Any questions about accident details may be answered with the following statement: “I’m sorry, I cannot discuss details that will be part of the ongoing Navy investigation.” In a tragic accident or incident, senior fleet PAOs will be involved and will provide your office with advice and guidance.

GENERAL.— This is a one-on-one interview involving a reporter and an individual involved in a specific event or issue. You and the PAO may grant this type of interview on a case-by-case basis, depending on the sensitivity of the issue and if the subject matter is not beyond the responsibility of the person to be interviewed. The PAO should monitor the interview and tape-record it in case questions arise later on the context of the answers or if the interviewee is misquoted.

TALK SHOW.— Many local television and cable stations have interview shows where “people in the news” are interviewed. These are referred to as “soft” interviews that usually focus on the personality of the person or command, rather than on hard news issues. Nevertheless, prior preparation is important even for a soft interview. Be sure you know if there will be another speaker on the show who will be asked their opinions of the issues the interviewee will address.

Since the talk show interview is usually scheduled in advance and topics may be agreed upon in advance, the interviewee must be aware that new questions may arise tied to current events in the news. For example, if the CO is scheduled for a 0900 interview on the heels of a major naval incident nine hours earlier, he can expect some questions on it.

AMBUSH.— This type of “on-the-run,” unanticipated interview usually is related to some major issue or controversial event. The person leaves his home, a congressional hearing or a courtroom, and is suddenly faced with television cameras, microphones and shouted questions. The main rule here is to keep cool, smile and move as soon as possible. It is acceptable to say “I am sorry, I do not have the time to talk to you.” Once the subject stops to answer one question, it is harder to move on.

REMOTE.— This is similar to the general interview but involves the interviewee in one location (such as on the ship’s bridge or pier) and the interviewer in a television studio asking questions. There may also be a third party linked by another remote location or in the television studio. The interviewee has an earplug to hear the questions.

The main drawback to this interview is the distraction and confusion the audio feedback makes in the earplug. This technical problem makes the interviewee more nervous and thus interferes with the ability to do the best interview possible. Practice with the remote will help, but such interviews are always difficult.

EDITED.— As you already know, any interview, whether it be print, radio or television, may be edited if it is not done live. The problem with the edited interview is that an answer may be edited **out of context**. One answer to this problem is to have command personnel only appear on live radio or television shows. However, even alive interview can be stage-managed by the host.

The best advice about this interview is that you know the people you are dealing with. For example, the Navy has had very bad experiences with some so-called

“investigative” reporters and programs and will decline to accept interview invitations from those sources. On the other hand, there are some media (mainly trade publications) which will present a copy of the draft interview article for correction by the interviewee. Unfortunately, this practice is rare.

Television Interview Tips

As covered before, the senior journalist is called upon to provide media training to individuals scheduled to represent the command in a television interview. Media training simply means conveying certain interview tips to the interviewee to make sure the interview is a success. This section covers the following television interview tips: appearance, eye wear, eye contact and the use of the interviewer’s first name.

APPEARANCE.– If the interview is in a television studio, have the interviewee wear either the service dress blue or summer white uniform. These are the most recognizable Navy uniforms and look best on television. If the interviewee is wearing summer whites, make sure he takes a fresh shirt to the studio and changes just before the interview to avoid a wrinkled look. Have the interviewee remove his name tag because they glare or shine under television lighting.

After the lavalier microphone is placed on the tie or shirt, make sure the tie or shirt is straight. The microphone should be inside the coat or blouse so it does not show. The interviewee should not wear a large blouse or too many rings, which also shine under the lights and distract the television audience. The uniform of the day is acceptable if the interview is held aboard a naval unit or facility.

Be sure the interviewee uses makeup to help control perspiration and glare. A small amount of makeup is normally applied by television station personnel.

Of course, make sure the interviewee has a fresh haircut and is clean shaven (if male).

EYEWEAR.– If the interviewee normally wears glasses but chooses not to wear them during the interview, make sure he takes them off about 20 minutes before the interview. This allows the eyes to adjust to the set and lights. Makeup may be needed on the nose where glasses sit.

EYE CONTACT.– Most of the time the interviewee looks directly into the camera when answering a question. Tell him to look at the **interviewer**, not the camera, during the interview. The obvious exception is the remote interview.

USE OF FIRST NAME.– If the interviewee knows the interviewer and feels natural using his first name, it is perfectly acceptable. If the interviewee feels a need to be more formal, then he should use the host’s last name.

General Interview Tips

Include the following interview tips in your media training regimen to get the most out of every interview:

- Relax and be yourself.
- Tell the truth, even if it is painful.
- Never say “no comment.” If you cannot discuss something because of an ongoing investigation or because it is classified, explain as much as you can. If additional information is requested, make an effort to get back to the reporter.
- If you do not know the answer to a question, say so. Offer to get back later with the answer, if possible.
- As in news releases, avoid military or technical jargon. **Always remember the target audience—the American public.**
- Answer questions directly and give the bottom line up front. Amplification, if needed, may be given later.
- Correct the record. If a reporter makes an error or has wrong information, politely correct him during the interview.
- Listen carefully to the reporter. Ask for repetition or clarification if necessary.
- Maintain eye contact. Make sure the reporter knows you are interested and paying attention.
- Be expressive and try to be interesting.
- Be humorous, if appropriate. Humor is one of the best forms of communication.
- Maintain a positive attitude.
- Be prepared to answer the five W’s: Who, What, Where, When, Why and How.
- Always assume that you are on the air, even if you are told that you are off. Technical crews make mistakes.
- Be modest and confident. You are the expert, but do not be condescending.

- Use the studio monitor to check your appearance before air time, then maintain eye contact with the reporter and ignore the monitor.
- Never lose your temper, even if provoked.
- Do not drum your fingers, twiddle your thumbs, tap your feet or act nervously.
- Do not look around the room for the answer. It gives the impression of discomfort, bluffing or desperation.
- Never speculate or comment on matters beyond your cognizance or responsibility.

NEWS CONFERENCE

The news conference was briefly covered in Chapter 3. It is held only when a command has something specific to announce to the media that cannot be handled in a news release or by a telephone call. Another criterion for scheduling a news conference is if it is requested by the news media. Under normal conditions, the news conference should last no more than 30 minutes.

Command Participants

The CO is normally the focal point in most news conferences. However, if highly technical information in several different fields are involved, the appropriate subject matter expert should be on hand to answer questions the CO directs to them. Regardless of the news conference participants, the senior journalist and PAO must thoroughly brief these individuals on the procedures and limitations of the news conference.

The news conference should not be attended by senior command personnel who do not have an active role in the issue or the news conference. Their presence can cause considerable embarrassment to everyone involved. Reporters will direct most of their questions to the subject matter experts by way of the CO.

Preparing Participants

A news conference can mark the first time an individual in the command meets many reporters. A good way to acclimate participants beforehand is by conducting a mock news conference (commonly called a “murder board”) with public affairs staff personnel acting as news people. Your developing tougher than normal questions will help you get the most out of the session.

Inviting News Media

Invitations to the media must be made well in advance and timed with media deadlines in mind. When possible, hold the conference on a day or at an hour when coverage chances are most favorable. Initially, invitations should go out by telephone, then followed up in writing when possible. Let the reporters know what will be covered during the news conference, but do not disclose specific details. The day before the news conference, appoint a staff member to call and remind all the invited reporters. Make the written invitations friendly and informal.

Appoint a point of contact in the public affairs office to receive the media RSVP calls. This person must be fully briefed on what information to get from the respondents and what information must be given to the caller. A media RSVP sheet (fig. 4-3) can speed up the conversation.

Site Requirements

The first consideration in choosing a press conference site is accessibility. No matter where you intend to hold a news conference, the media must be able to get to the site. Operational security is another major consideration when choosing a site.

The site should be attractive, large enough to seat the media comfortably and have the following features:

- **Electrical power for running equipment.** Television lighting sets have a 600-to 1,000 watt bulb in each light. There are at least two and probably three needed, depending on the site you choose.
- **Facilities for filing stories.** Have on hand an adequate number of telephones, typewriters, writing papers and pencils.
- **Enough parking.** Electronic equipment is heavy. The closer to the news conference area, the better. If this is not possible, arrange for some mode of transportation to move reporters to the area or to allow them to unload their equipment at the door and then park.
- **Adequate visual background.** The visual background behind the podium should be suitable for video and still photography. Avoid reflective surfaces, geometric patterns or distracting backgrounds. Use background colors that contrast favorably with Navy uniforms.

Media RSVP Sheet

A. INFORMATION NEEDED FROM THE CALLER:

Name of reporter: _____

Organization he represents: _____

Other members of the crew: _____

Time and date of arrival: _____

Method of arrival: _____

Any special requirements/arrangements needed: _____

B: INFORMATION TO PROVIDE TO THE CALLER:

Date/Time of the news conference: _____

Location and directions to the news conference: _____

POC: _____

Parking arrangements: _____

Special instructions: _____

Figure 4-3.—Media RSVP sheet.

- **Public address system.** A good PA system may be needed if the room is large.

Conducting the News Conference

After the site has been selected, concentrate on conducting the news conference.

Put together a press information kit for the news conference. Each media representative should receive a kit (for television teams, one press information kit per crew is enough) either as they enter the room or when the news conference is completed. The kit consists of biographies, photographs, unclassified fact sheets, advance copies of speeches and any other pertinent information. The purpose of the press information kit is to provide accurate background information about the event in a convenient form. Be cautious not to flood reporters with a lot of unnecessary material.

The next step is selecting a moderator. Usually, the PAO assumes this role. The moderator is that all-important individual who must conduct the news conference. He is responsible for performing the following tasks:

- Making the introductory remarks, including a statement of the purpose of the news conference, a brief outline and duration of each segment, introduction of any distinguished visitors in attendance, statement of procedures to be followed during the question and answer segment and ground rules in effect (ground rules should be **on the record** and **for attribution by name and title**).
- Moderating the overall media briefing.
- Introducing the CO once the media has been seated.
- Conducting the question and answer period.
- Closing the news conference by saying, for example, "We have time for one more question."
- Thanking the media for their attendance and making additional administrative announcements.

After the moderator makes the introductory remarks, a principal statement is made. This is normally done by the CO and may include a further introduction of distinguished visitors or the introduction of subject matter experts as necessary.

Tape-record the news conference and transcribe the tape. This gives you a hard copy from which to answer resulting questions as they arise. In addition, you should prepare a news release on the conference and distribute it to news media who could not attend, but were interested in the subject. If possible, telephone the release to the media.

MEDIA EMBARK

Whether it be routine operations or large-scale exercises, the media embark is an excellent way to release news to the media. The media embark is designed to let the actions and words of the men and women in the fleet tell the Navy's story. You and the PAO should make sure the embark is approved by the proper authority and that the reporters are adequately briefed before embarking. In addition, you and the PAO should prepare the command for the embark and identify and train escorts.

Approval Authority

The approval authority for media embarks depends largely on the impact of the news medium and the nature of the embarkation. All embarks involving national media must be approved by CHINFO, who coordinates with ASD(PA) as needed. Submarine media embarks are approved by the Assistant Chief of Naval Operations (Undersea Warfare) after a recommendation from CHINFO. Other media embarks may be approved by the proper fleet commanders in chief, provided the following information is included with the media embark request:

- The names of the reporters
- The reporters' positions, affiliations and any other appropriate identifying information
- The ship or unit to be embarked, dates, points of embarkation and debarkation and any intermediate stops
- The reasons for the requested embarkation and description of how embarkation is an essential part of the proposed story
- A statement that the embark will be on a space available, not-to-interfere basis at no cost to the government
- The name, command and telephone number of the project officer who will be directly

responsible for coordinating all aspects of the embarkation

A well-orchestrated embark involving national media begins at the local command level, then ultimately reaches CHINFO for final approval. Planning and coordination is the responsibility of the on-scene PAO, because he is more familiar with the subject matter, issues and facilities where the embark will take place.

Pre-Departure Briefing

Hold a pre-departure briefing as soon as possible so reporters can meet the CO and other key individuals, and get answers to preliminary questions. If correspondents join your unit while it is deployed, make sure they are briefed soon after arriving.

Cover the following subjects in the pre-departure briefing:

- Ground rules
- Basic shipboard safety
- Emergency procedures
- Off-limit areas
- Photography restrictions
- Procedures to take during a security alert
- Wardroom and berthing accommodations

Note: Embarked news media representatives will receive the same wardroom and berthing privileges as a lieutenant commander or senior, if available, **regardless** of any prior military rank held.

Preparing the Command

Inform the crew about the media embark through the Plan of the Day, ship's newspaper, bulletin boards and SITE system. Give the reporter's names, affiliations and the length of their visits. Be ready to provide the reporters with crew members of certain geographical locations for interviews. For instance, if an ENG team from a San Antonio television station embarks aboard the USS *Forrestal* (AVT 59) in Pensacola to do a story on naval aviation training, they will request interviews with Texans involved in the actual training, especially those from San Antonio. The personnel office can help you with hometown information.

Escorts

If the number of embarking correspondents outnumbers your public affairs office escorts, you have to get more. These escorts are usually senior enlisted members or officers identified by the command during pre-embark planning sessions. Regardless of who is chosen, you must adequately train these escorts and make sure they attend the pre-departure briefing.

VISUAL RELEASE

A picture is worth a thousand words, and one good still photo can often do a better job of conveying an idea than a month's worth of news releases. You should develop an eye for photo-worthy situations and either release them yourself or invite news photographers to cover the event.

Film clips or videotapes are also in demand if they are not obvious setups or posed situations. In general, news editors and news directors are very distrustful of government audiovisual products. However, if you have established credibility and deal only in "honest images," you can achieve greater acceptance of visual releases.

MARKETING

Your JO2 has written a feature story about two pilots assigned to a squadron at your air station. She interviewed the pilot and co-pilot after a flight to an interesting destination. The story, written primarily for your base newspaper, is aimed at your internal audience that already knows something about your base and its mission. A picture of the two of them in the cockpit illustrates the story.

What can you do to get more media mileage from this story? **Market it.** Your taking the time to adapt this story to a different audience will enable you to tap into thousands of new readers.

In the preceding scenario, you can easily modify the story into a hometown feature. By having the two pilots fill out a Fleet Home Town News release form, you get both personal data and release permission. With minimal rewrite time, you can take the original story and turn it into two separate stories-with each pilot getting star billing for his hometown markets. When doing this, you will need to add such information as hometowns, where they attended school and the names of their parents. You also must identify the location of the air station and its mission.

Navy Office of Information

Before marketing your stories to any non-Navy produced publication (such as *Navy Times*), you must coordinate your efforts with the nearest Navy Office of Information (NAVINFO). There are six NAVINFOS, listed as follows:

- Southeast (Atlanta)
- New England (Boston)
- Midwest (Chicago)
- Southwest (Dallas)
- West (Los Angeles)
- East (New York City)

NAVINFOS are field activities of CHINFO that provide a communications link between senior Navy leadership and media in their respective regions. Some of the media-related functions NAVINFOS perform include the following:

- Verifying news stories
- Answering queries
- Providing information on news and feature opportunities
- Arranging interviews
- Providing assistance in contacting Navy experts
- Providing photos, videotapes and graphics
- Supplying print and broadcast features
- Providing audio feeds and actualities
- Arranging visits to ships and stations
- Furnishing background material and research assistance
- Providing editorial background
- Supplying regular print feature packages of general interest

Hometown features may be marketed by sending six copies and six photos (with cutlines) to the nearest NAVINFO. Cutlines should include enough information so the photo can stand alone without the story. Be sure to credit your photographer and include a map that shows where your base is located.

Navy Public Affairs Centers

The Secretary of the Navy established two Navy Public Affairs Centers (PACENs) in 1975. The PACENs in Norfolk and San Diego serve as CHINFO field activities and produce feature materials (written, audio and visual) for civilian newspapers, magazines and radio markets. Special emphasis is placed on marketing expanded photo features to hometown newspapers. PACENs once marketed stories through the NAVINFOS, but in recent years PACEN direct marketing has streamlined the process and led to greater publication rates.

With direction from CHINFO and close coordination with fleet units, PACENs can target personnel participating in important operations or events, giving local editors a hometown tie to major stories.

Magazine Marketing

Your finding magazines to run your story, such as *All Hands*, *Navy Editor Service*, *Naval Aviation News* and *Surface Warfare*, may require some market research. *All Hands*, for example, wants unusual features that appeal to a broad range of Navy men and women. It will not run the following stories: change of command, poems, milestones, reenlistments, fiction and homeowners. Newsstand magazines, like *Sea Classics*, *Air Combat* and *Military Airpower*, want interesting stories about the Navy and our people. A story about helicopter pilots could run in *Rotary Wing International* or *Defense Helicopter World*. There is also a magazine about women in the military, called *Minerva*. It is up to you to get on the telephone and find out what the magazine editors are looking for.

Remember, if the publication is not Navy-produced, you must contact the nearest NAVINFO before marketing it.

Log Book

Keep a log book to track the stories you have marketed. This way, you know where you sent the story and which pictures you enclosed. If a story does not get published, you can identify other markets to try.

Success Rate

You will not always be successful in your marketing efforts, so be ready to accept rejection. Often, you will not hear from a publication, even if they decide to print

your story. Other editors acknowledge receipt of the story, tell you when it will run and send you courtesy copies after publication.

Some editors will not accept unsolicited manuscripts and prefer to get a query letter first. Facsimile machines can deliver queries quickly and cut waiting time. Other publications may want an exclusive (such as *All Hands*). When in doubt, send the story.

MILITARY/MEDIA RELATIONS DURING HOSTILITIES

Learning Objective: *Identify the relationship between the military and the media during hostilities.*

When the military shifts gears from peacetime operations to that of a conflict or war, the rules regarding the media also change. In peacetime, there is greater media access to the military and a more open and candid dialogue. However, as tensions increase and the military moves toward crisis and finally hostile action (conflict or war), the news interest or value of covering the military increases dramatically.

Also, the military becomes more “closed-mouthed” because of operational security considerations. This normally leads to a certain amount of friction in the military/media relationship during crisis and conflict.

The basic principle governing the release of information in hostilities is this: released information must be consistent with operational security and not compromise the safety of United States or friendly nation (allied) personnel. Security at the source must apply.

Figures 4-4 and 4-5 show the general ground rules and guidelines used during Operation DESERT SHIELD/STORM in 1991.

MEDIA POOL

You were briefly introduced to media pools in Chapters 2 and 3. During hostilities, a news media pool is usually sized to the number of seats and baggage capacity of ground or air transportation and host unit billeting. Using the amphibious exercise *Imminent Thunder* as an example, Navy and Marine Corps units were able to accommodate four media pools. Each pool had six people and was deployed as follows:

***Imminent Thunder* Media Pool:**

1. Television reporter
2. Television photographer

3. Television sound man
4. Radio reporter
5. Print reporter
6. Still photographer

Pool 1- Embarked aboard USS *Guam* and flown ashore by helicopter

Pool 2- Embarked aboard USS *Gunston Hall* and transported ashore by LCAC (landing craft, air cushion)

Pool 3- Covers the assault from ashore and remained overnight with maneuver units

Pool 4- Same as pool 3

An important point to remember about media pools is that they are not tour groups that must be tightly banded together. Television reporters need video and print reporters need interviews. It is up to you to make sure individual media needs are met.

FAMILIES

During crisis and hostilities, news media seek Navy families to discuss their personal reactions to the deployment of their service member. As discussed in Chapter 2 of this manual, family rights in dealing with the news media should be clearly understood and passed along to military families as soon as possible.

CREDIBILITY

Learning Objective: *Detail the concept of credibility when dealing with the media.*

In Chapter 1, you were introduced to the concept of credibility in your day-to-day job activities. This encompasses the credibility you must obtain when working with the news media.

While the media can, at times, be difficult to deal with, they can also be the fun part of Navy public affairs. Fun, that is, if your credibility rating is where it should be.

How is credibility with the media established? By being knowledgeable about Navy public affairs, the command to which you are attached and the willingness to go that extra mile for a reporter.

The following are some tips that will help you establish and maintain media credibility:

- Do not be obscure. Reporters can spot a con artist at 50 paces, so do not assume a snow job will be

OPERATION DESERT SHIELD/STORM GROUND RULES

The following information should not be reported because its publication or broadcast could jeopardize operations and endanger lives:

1. For U.S. or coalition units, specific numerical information on troop strength, aircraft, weapons systems, on-hand equipment or supplies (e.g., artillery, tanks, radars, missiles, trucks, water), including amounts of ammunition or fuel moved by or on hand in support and combat units. Unit size may be described in general terms, such as "company-size," "multibattalion," "multidivision," "naval task force" and "carrier battle group." Number or amount of equipment and supplies may be described in general terms, such as "large," "small" or "many."

2. Any information that reveals details of future plans, operations or strikes, including postponed or cancelled operations.

3. Information, photography and imagery that would reveal the specific location of military forces or show the level of security at military installations or encampments. Locations maybe described as follows: all Navy embark stories can identify the ship upon which embarked as a dateline and will state that the report is coming from the "Persian Gulf," "Red Sea" or "North Arabian Sea." Stories written in Saudi Arabia maybe datelined "Eastern Saudi Arabia," "Near the Kuwaiti border," etc. For specific countries outside Saudi Arabia, stories will state that the report is coming from the Persian Gulf region unless that country has acknowledged its participation.

4. Rules of engagement details.

5. Infomation on intelligence collection activities, including targets, methods and results.

6. During an operation, specific information on friendly force troop movements, tactical deployments and dispositions that would jeopardize operational security or lives. This would include designations, names of operations and size of friendly forces involved, until released by CENTCOM.

7. Identification of mission aircraft points of origin, other than as land- or carrier-based.

8. Information on the effectiveness or ineffectiveness of enemy camouflage, cover, deception, targeting, direct and indirect fire, intelligence collection or security measures.

9. Specific identifying information on missing or downed aircraft or ships while search and rescue operations are planned or under way.

10. Special operations forces' methods, unique equipment or tactics.

11. Specific operating methods and tactics, (e.g., air angles of attack or speeds, or naval tactics and evasive maneuvers). General terms, such as "low" or "fast," may be used.

12. Information on operational or support vulnerabilities that could be used against U.S. forces, such as details of major battle damage or major personnel losses of specific U.S. or coalition units, until that information no longer provides tactical advantage to the enemy and is, therefore, released by CENTCOM. Damage and casualties may be described as "light," "moderate" or "heavy."

Figure 4-4.—Media ground rules during Operation DESERT SHIELD/STORM.

GUIDELINES FOR NEWS MEDIA

News media personnel must carry and support any personal and professional gear they take with them, including protective cases for professional equipment, batteries, cables, converters, etc.

Night Operations—Light discipline restrictions will be followed. The only approved light source is a flashlight with a red lens. No visible light source, including flash or television lights, will be used when operating with forces at night unless specifically approved by the on-scene commander.

Because of host-nation requirements, you must stay with your public affairs escort while on Saudi bases. At other U.S. tactical or field locations and encampments, a public affairs escort may be required because of security, safety and mission requirements as determined by the host commander.

Casualty information, because of concern of the notification of the next of kin, is extremely sensitive. By executive directive, next of kin of all military fatalities must be notified in person by a uniformed member of the appropriate service. There have been instances in which the next of kin have first learned of the death or wounding of a loved one through the news media. The problem is particularly difficult for visual media. Casualty photographs showing a recognizable face, name tag or other identifying feature or item should not be used before the next of kin have been notified. The anguish that sudden recognition at home can cause far outweighs the news value of the photograph, film or videotape. News coverage of casualties in medical centers will be in strict compliance with the instructions of doctors and medical officers.

To the extent that individuals in the news media seek access to the U.S. area of operation, the following rule applies: Prior to or upon commencement of hostilities, media pools will be established to provide initial combat coverage of U.S. forces. U.S. news media personnel present in Saudi Arabia will be given the opportunity to join CENTCOM media pools, providing they agree to pool their products. News media personnel who are not members of the official CENTCOM media pools will not be permitted into forward areas. Reporters are strongly discouraged from attempting to link up on their own with combat units. U.S. commanders will maintain extremely tight security throughout the operational area and will exclude from the area of operation all unauthorized individuals.

For news media personnel participating in designated CENTVOM media pools:

1. Upon registering with the JIB, news media should contact their respective pool coordinator for an explanation of pool operations.

2. In the event of hostilities, pool products will be subject to review before release to determine if they contain sensitive information about military plans, capabilities, operation or vulnerabilities (see attached ground rules) that would jeopardize the outcome of an operation or the safety of U.S. or coalition forces. Material will be examined solely for its conformance to the attached ground rules, not for its potential to express criticism or cause embarrassment. The public affairs escort officer on scene will review pool reports, discuss ground rule problems with the reporter, and in the limited circumstances when no agreement can be reached with a reporter about disputed materials, immediately send the disputed materials to JIB Dhahran for review by the JIB Director and the appropriate news media representative. If no agreement can be reached, the issue will be immediately forwarded to OASD(PA) for review with the appropriate bureau chief. The ultimate decision on publication will be made by the originating reporter's news organization.

3. Correspondents may not carry a personnel weapon.

Figure 4-5.—Guidelines for news media during Operation DESERT SHIELD/STORM.

effective. If you cannot provide the reporter with an answer, say so and offer to find it. If you cannot discuss a matter because of sensitivities within your organization, do not discuss it.

- If you must refer a reporter to another office or command, provide the telephone number and any additional data that might be helpful. There are few things more frustrating than wading through the DoD bureaucracy.
- Provide background briefings and printed data. Many Navy projects and programs are complicated and explaining them to a novice in simple terms is almost impossible. Background briefings conducted by subject matter experts (with public affairs personnel monitoring the briefings) will be appreciated by a struggling reporter.
- Say “thank you” if a reporter treats you and the subject fairly. Public affairs people frequently forget this common courtesy.
- Treat reporters as you would like to be treated. They are under pressure to get a job done quickly and accurately—a situation the senior JO can easily understand.

MEDIA RELATIONS DO'S AND DON'TS

Learning Objective: *Identify the do's and don'ts of media relations.*

How should you, the senior journalist, deal with members of the media? As in any area of human relations, there is no simple formula. News people, like public affairs personnel, vary in height, weight, intelligence, tact, level of knowledge and motivation. Common traits might include these: they have a job to do, they want to do it and they know how to do it.

Remembering a few simple do's and don'ts will help guide you down the path of successful media relations and set an example for your junior public affairs staff members.

Do's

- Be available at all hours.
- Tell the truth.
- Tell reporters **up front** if you cannot comment on a particular subject or if the answer is classified
- Get the facts, get them right and get them out.
- Be aware of the medium's time or space limitations, deadlines or other special requirements.
- Know the audience of each medium.
- Know the people who work in the media.

DON'TS

- Lie.
- Speculate.
- Beg for coverage.
- Ask a reporter to kill a story.
- Be partial in dealing with media representatives for any reason.
- Release information to other newsmen which has been given to you by a newsmen.
- Be a publicity hound.
- Ask news people to slant their copy, withhold information or do favors.

CHAPTER 5

COMMUNITY RELATIONS AND SPECIAL EVENTS

A community relations (COMREL) program is defined as a planned series of events and activities that fosters understanding between military and civilian communities. It encompasses all official or private contact between the command and all of its personnel and local communities.

While the Navy may concern itself with national policy and public affairs on a national level, real public relations takes place in the community. People live, work form opinions on issues that concern them and vote in local communities. Thus, national opinions and the ground swells that eventually become the policies and actions of national government are formed at the local level.

The civilian populace surrounding a Navy installation is not as affected or concerned by national Navy news as they are by Navy news items affecting them directly or more personally. Because of this, the news element of proximity has a special value in community relations. A scheduled base closure or an employee force reduction will have a much more profound impact than something happening in Washington that may have little local influence.

The Navy depends on the public understanding of sea power. This is both an important concept and national issue, and Navy news often takes the form of "national" publicity. However, any story is national only in that it appears in newspapers and on radio and television newscasts all over the country. To the extent that it informs people, every story, every contact with the Navy, is a local one. Public opinion is the opinion of people—the opinion of private individuals. National public opinion is nothing but the sum of these local opinions. And while public opinion can be tallied and measured on the national level, it is made in local communities by the people.

A command has to be "good" before it can have good public relations. In planning community relations, good behavior includes establishing a policy in which the command will not do anything harmful to its neighbors and will go out of its way to build good relations with them.

Establishing such a policy, of course, is the skipper's job. Unless you are a public affairs assistant acting as

the command PAO, you will not formulate community relations policy. However, it is essential that you understand the importance of this type of policy and that you emphasize the importance of community relations every chance you get. Everything about the base, from the driving habits of official and unofficial Navy drivers and the liberty habits of the crew to the appearance of the gate sentries, pollution control and the flight patterns of low-flying aircraft, has a direct bearing on community relations. These areas probably are more important than news releases and the parade unit your command may furnish on the Fourth of July.

Every officer in command is responsible for integrating his command into the civic activity of the neighboring community. The days when military and civilian communities were insulated, if not isolated, from each other by a distance of several miles are past. Each can no longer afford to operate as a "closed community" without considering mutual effects. Normally, the military officer in command delegates the authority for planning and maintaining an effective community relations program to his PAO, but he cannot delegate his responsibility for assuring that the program is sound and effective. The CO must exert personal interest and participation in community relations matters.

Community relations, internal relations and media relations are all inextricably intertwined. Each of these segments supports each other. For example, good community relations are very important to the morale of our naval personnel (internal relations). A hostile community, or one where liaison is not very good, can make it hard for Navy people to get off-base housing, local credit and other amenities that are important morale considerations.

The first part of this chapter is devoted to a survey of some techniques that can be used to develop a positive, planned community relations program for a ship or station. The second part discusses the duties of the senior journalist regarding special events.

IMPORTANCE OF AN EFFECTIVE COMMUNITY RELATIONS PROGRAM

Learning Objective: *Identify the purpose of an effective community relations program and recognize its benefits.*

It is stated often that community relations are “public relations at the local level” or that it is “living right and telling about it.” It has also been explained as “having and keeping friends in the community.”

These statements get to the heart of community relations, but they are oversimplified definitions when the vital mission of community relations is analyzed clearly.

DEFINITION

To paraphrase the *Public Relations News* definition of public relations:

“Community relations is the command function that evaluates public attitudes, identifies the mission of a military organization with the public interest and executes a program of action to earn public understanding and acceptance.”

Like public relations, community relations is something an organization has whether this fact is recognized or not. Unlike public relations, community relations is usually limited to the local area.

Business organizations give attention to their community relations for good reason. Organizations can exist and make a profit only as long as the public allows them to exist. The concept that American free enterprise exists only to make a profit and is responsible only to its official family has diminished to a great degree. It has fast given way to the realization that there is also a responsibility to the community in which the organization is located and that it is advisable for the organization to meet this responsibility of its own free will.

While there is not universal agreement on the specific benefits gained, organizations conducting planned programs cite many tangible and intangible benefits from their community relations efforts. A Bureau of National Affairs survey found that the benefits mentioned most often were better recruiting, improved employee relations, increased sales and community goodwill.

Community relations literature reflects general agreement that effective community relations programs make it easier to hire the better workers in a community, help to get more confidence in local plant management from communities and provide better understanding between the organization and local officials.

Benefits from good community relations do not come automatically. In fact, many organizations that are fine employers and outstanding corporate citizens fail to realize the rewards to which their virtues entitle them. They miss the payoff because they fail to tell about it.

Communicating to key publics the benefits derived from sound community relations further enhances an organization’s overall program. Attitude surveys reveal that community neighbors traditionally know little about companies in their towns and the important part each plays in the civic programs of their towns. Surveys also reveal that civilian companies rated favorably in their communities are generally guided by the following three-point formula for effective community relations:

- Live right.
- Have a planned community relations program.
- Tell employees about the program and tell the community about the company.

BENEFITS

Many of the benefits civilian enterprise derives from planned community relations programs are equally desirable for military organizations. Military commands also need to enjoy a favorable position in the local community, strive for good employee relations and seek cooperation and high esteem from the local population.

Military organizations should be concerned with community relations because the business of the military is the people’s business. Military organizations **have a responsibility** to report to the public on the conduct of military business. In a democratic nation, the individual citizen has a right to know how efficiently, and to what purpose his armed forces are using his sons and daughters and his tax money plus what the returns on his investment are in personal and national security. The effectiveness of military operations depends upon public understanding, support and cooperation.

Like business organizations, military establishments have a moral debt to take their place in the community as “corporate citizens,” be good neighbors and to show an awareness of community problems and a willingness to help out. Community relations

programs are a proven means of developing “grass roots” understanding and support for our defense force.

AUTHORITY

Community relations are authorized and encouraged within the DoD for the following purposes (subject to operational requirements, the significance of the event or program in relation to other DoD programs and cost considerations):

- Informing the public on the state of preparedness of the DoD and to show United States partnership with allies
- Developing public understanding of and cooperation with the DoD in its community relations programs
- Promoting national security and stimulating patriotic spirit
- Helping recruiting and personnel procurement programs of the armed forces

Within the DoD, ASD(PA) is appointed to act for the SECDEF in planning and implementing the DoD community relations program. Secretaries of the military departments, commanders of unified and specified commands and the directors of the defense agencies are responsible for effective community relations. Officers in command at all levels are responsible for giving positive emphasis to the importance of good community relations in the execution of their mission.

Within the office of ASD(PA), the directorate of community relations is responsible for the overall planning, implementation and coordination of community relations within the DoD. For Navy implementation of this program and current CHINFO policy guidance, refer to *PA Regs*, Chapter 4.

PARTS OF A COMMUNITY RELATIONS PROGRAM

Learning Objective: *Identify the key parts of a community relations program.*

Among the main parts of a community relations program are publics, communication channels and community relations projects designed to accomplish an organization’s goals in the community.

PUBLICS

Collectively, a Navy command’s public consists of many groups. Among the principal local publics that a command should be concerned with are both internal and external publics.

Internal

You were introduced to the Navy internal audience in Chapter 1. These groups are also part of the Navy’s internal public. The following groups round out the Navy’s internal public:

- U.S. Naval Academy midshipmen
- NROTC midshipmen
- Military auxiliary organizations
- Career civilian employees
- Families of the above segments

External

External publics consist of the following groups:

- The general public
- Community organizations (civic, trade, industrial, veterans, fraternal, youth, women, religious, educational)
- Congress
- Members of committees involved in armed services matters
- Alumni of the armed forces
- Key governmental officials
- Local government officials
- News media
- Professional organizations
- Well-known local businesses
- Professional people
- Elder statesmen

COMMUNICATIONS CHANNELS

The tools and techniques of public affairs offer almost as many ways of reaching community publics as there are publics. The “how-to-do-it” instructions for

using the various media and techniques are taught in the various departments at DINFOS and are discussed in other chapters of this manual and *PA Regs*. Many service and civilian publications are available in public affairs offices and public libraries that give guidance in the use of communication tools.

You must use the right channels of communication to accomplish specific tasks or to reach specific publics; otherwise, much of what a public affairs office does is wheel-spinning and unnecessary busywork. An individual can be reached by mail, telephone or personal visit; members of an organization can be reached by letter to the head of the organization, an article in its publication or a talk at a group meeting. To reach every key individual in an organization or public, it is sometimes advisable to plan a campaign with special events, publicity through newspapers, radio and television announcements, bulletin boards, mailed announcements to key individuals and groups and personal contact with community leaders.

PROJECTS AND ACTIVITIES

Community relations projects and activities provide occasions for or a means of informing community publics about an organization and for demonstrating that an organization is a good neighbor.

Projects should not be selected just because they sound good or because other organizations have had success with them. Key considerations should be whether they seem suited to the particular organization and its community and whether it appears that benefits will justify the efforts and resources involved. Some may be incorporated into a command's program, while others may serve to stimulate ideas for fresh and worthwhile projects. Projects and events sponsored cooperatively by two or more organizations in a community can make a greater impact on community opinion and serve a very useful purpose in a community relations program.

Namesake Ship Program

The launching and commissioning of U.S. Navy ships with state and city names is an excellent way to generate positive community relations at the local or state level. The key to success in building a namesake relationship lies in mustering the cooperation of state, city, Navy Reserve units, local Navy League and other civic-minded groups, as well as recruiters and the ship itself. Additionally, NAVINFOs play an important role

in establishing, and in some cases, re-establishing ship namesake ties.

Base-Community Council

Many military installations have a formal community organization that coordinates community relations on a year-round basis and gives the officer in command a tool with which to coordinate community relations on a year-round basis. These organizations are called military advisory committees, coordinating councils or community relations councils. The Navy calls it the base-community council.

The base-community council embraces every area of common interest between the two populations, such as public safety, health, environmental issues (such as hazardous waste), housing and hospitality, personal welfare, citizenship and commerce. A command can use this type of organization as a principal tool with which to fulfill its responsibilities for favorable public relations.

To be effective, the base-community council must include in its membership key military, governmental and civic leaders and meet regularly to resolve or plan for the prevention of local problems. The PAO and his staff must be thoroughly familiar with the command or unit as well as the local civilian community to provide sound recommendations to the officer in command.

Additional information on the base-community council can be found in *PA Regs*, Chapter 4.

TYPES OF COMMUNITY RELATIONS PROGRAMS

Learning Objective: *Specify the types of community relations programs.*

Community relations programs can be placed into the two general groups of remedial and preventive.

The remedial program is focused toward trying to restore sound community relations after a military neighbor arouses public antagonism and adverse public opinion. It is usually born in crisis and often costly in resources. Remedial measures necessary to restore a balance in relations can often hamper mission accomplishment. An example of this might be the burdensome task of changing the aircraft traffic pattern for a naval air station after irate citizens vehemently complained about the noise. If the citizens of the local community had been informed that the aircraft noise was related to the unit's mission of defending the community and nation against its enemies, the

mission-hampering change of the traffic pattern might have been avoided.

The preventive program is a planned effort to develop a continuing program of improved conduct and two-way communication with the community. It furnishes a blueprint to build an effective program of cooperation between the naval installation and its nearby communities. The plan is usually based on the concept that the community **must** be informed about the naval installation, its mission and its needs from the local community. It is also dependent upon what the naval installation-and particularly the public affairs staff-knows about the community. You learn the essential facts about the community through surveys, interviews with leaders and research of existing publications.

The remedial program is often called the “fire-fighting” type, while the preventive program is referred to as the “fire prevention” variety.

DoD/NAVY COMMUNITY RELATIONS POLICY

Learning Objective: *Interpret the community relations policy of the DoD and Navy.*

The basic community relations policy of the DoD was established in DoD Instruction 5410.18 of July 3, 1974 (Community Relations). This directive has been tailored for Navy use and is the basis of *PA Regs*, Chapter 4 (Community Relations).

OBJECTIVES

The goals of the DoD community relations program are stated in DoD Instruction 5410.18 as follows:

- To increase public awareness and understanding of the armed forces and of the mission, policies and programs of the DoD
- To inspire patriotism and encourage young men and women to serve in the Defense Establishment
- To foster good relations on mutually acceptable terms with all of the various publics with which elements of the DoD come into contact at home and abroad
- To maintain a reputation as a good neighbor as well as a respected professional organization charged with a responsibility for national security

- To support the Human Goals Program of the DoD, with its emphasis on the infinite dignity and worth of the individual and the concept of equal opportunity
- To support the recruiting and personnel procurement missions of the DoD

LIMITATIONS

The DoD puts certain limitations on community relations programs in DoD Instruction 5410.18. Policies for planning and conducting Navy community relations programs and rating participation in public events are based on public law, executive order, Navy regulations and practical experience. To make sure a proposed community relations program conforms to proper policies, you must consider the following criteria:

- Objectives and purpose of the program
- Nature and character of the location of the program
- Full particulars of Navy support

RESTRICTIONS

Primarily, the following restrictions apply to participation in community relations programs:

- Support of commercial promotional activities
- Support of racially segregated events
- Endorsing partisan political activities
- Endorsing sectarian, religious and fraternal groups
- Competition with or selective endorsement of civilian businesses
- Use of military personnel in demeaning or menial tasks for nonmilitary guests at unofficial events, such as social functions

FISCAL CONSIDERATIONS

Funding for your command community relations program is limited to the minimum amount needed to accomplish official goals. Additional costs may be approved if it is determined that the community relations event is in the best interest of the Navy. *PA Regs*, Chapter 4, provides in-depth information on the funding of community relations programs.

PLANNED COMMUNITY RELATIONS PROGRAM

Learning Objective: *Recognize the stages of a planned community relations program.*

Developing a planned community relations program is a problem that the public affairs staff must solve. There are four basic stages to developing a community relations program for a typical Navy command:

- Fact-finding
- Planning
- Communicating
- Evaluating

FACT FINDING

To maintain an effective community relations program, you must identify the community needs and command abilities. If the interests of the command do not coincide with the interests of the community, all your activities will be in vain. You must identify areas in which the command can make a positive contribution to the community within its abilities and assets. Ideally, your community relations program should fulfill a common interest. Thus these common interests must be identified through fact-finding.

A good many “common interests” exist at most installations. Your most valuable assets—people—are already making such contributions. People of all ranks, ages and education levels bring their own unique interests and activities with them when they arrive at your command. These are the Little League baseball coaches, the Scout masters, the scuba divers, the karate enthusiasts, the members of the local PTA, the performers in church choirs—those who participate in all manners of community activities.

A practical way of finding these people is to do a feature story for your base newspaper. You will likely discover that one contact leads to another. One person active in some community endeavor almost always knows someone else in another. It makes great feature copy and might even be suitable for a local media release. People, and the interests and activities they bring with them, are a valuable part of your “positive contribution” to the community. If both you and your community are aware of it, so much the better.

You can use your knowledge of these people and their activities to improve your overall community

relations program. You also can use knowledge of the local power structure. The local power structure and organization must be determined. It is essential that these areas be considered; otherwise, you move into your community relations program blind. The community power structure is discussed later in this chapter.

Community Relations Requirements

Community relations requirements can only be determined after you know and become familiar with the mission and organization of your command. If these requirements do not exist, it is your responsibility to determine them. If they do exist, it is equally important that they reflect current requirements. Staff meetings, histories, permanent records and files (particularly those in the public affairs office) and interviews with key military officers are prime sources for this information.

Full public understanding and cooperation are essential to mission accomplishment. You should identify possible sources of problems or obstructions to effective community relations and gather the essential facts related to preventing these situations from becoming community relations problems.

Aircraft noise, reckless driving, misunderstandings in labor relations, pollution of civilian communities, disorderly behavior and apparent disregard for the health and welfare of local citizens are recurring problems in naval community relations. To overlook these and other potential community relations problems is to risk unfavorable publicity, possible congressional action, antimilitary demonstrations and strikes and a hostile relationship with the community.

Command Interest and Support

Command interest and support for community relations should be sought early in the relationship between an officer in command and his public affairs staff. If the officer in command does not voluntarily reveal his philosophy and willingness to commit resources, the public affairs office should, on its own initiative, survey the needs of the command and prepare recommendations for a community relations program. Ideally, there should be a policy statement and an outline of general objectives signed by the officer in command and addressed to key staff members and COs of subordinate units.

Community Needs of the Navy

In addition to broad public understanding and cooperation essential to mission accomplishment, there are specific needs of the Navy that are affected by community relations. Housing, religious activities, educational and cultural activities, recreational and entertainment activities and the community hospitality program are some specific needs of individuals of a naval command. Each of the specific needs should be surveyed and analyzed in planning the community relations program.

Adequate and sensibly priced housing for naval personnel and their dependents is the most important need in a normal Navy community relationship because of its importance to high morale among both naval and civilian personnel.

Community Power Structure

Every community has leaders who play a dominant role in shaping community opinions and determining what community activities take place. Those leaders make up the power structure. The public affairs office must identify this power structure and consider these individuals in planning and implementing the community relations program.

The formal political power structure is easily determined. It is made up of elected or appointed officials, the men and women who supervise and execute the will of the community through the official machinery of government.

The informal power structure, however, is another matter. It consists of those who wield influence in an informal or social realm.

There are three types of leaders in the social, or informal, power structure:

- Decision makers
- Influential
- Opinion leaders

The decision makers and influential include a minute portion of the public, perhaps as little as one percent, but the success of any community endeavor depends on the general approval and cooperation of these two groups. They come from the business and political spheres of the community.

DECISION MAKERS.— Decision makers exert their influence and determine community policies in

many ways. Whether the decision making is done through formal political or civic organizations, or in a more subtle manner, members of the same small group often emerge in positions of influence in most or all of the important publics within the community. Personal observation at community meetings plus careful analysis of local news stories and background information from trusted, well-informed individuals, such as reporters, are sources for facts to identify decision makers.

INFLUENTIALS.— Influentials exert their influence secretly rather than at public gatherings and give advice to decision makers. They make few actual decisions themselves. The power of influential is subtle, but they may be identified by reputation. Their identity can best be learned from personal observation and trusted sources in the community.

OPINION LEADERS.— Opinion leaders may be members of any economic or social class. There are many theories as to who is or who is not an opinion leader. It can be stated, however, that they are found throughout all levels of the community and exert less influence and power than members of the first two groups. They operate in two directions. First, they provide a means for the decision makers to convey their policies and decisions to each economic and social class and second, they serve as a source of information for the influential and decision makers. Often they are ministers, heads of youth agencies, officials of parent-teacher associations, teachers, barbers, lawyers, doctors and bankers.

A good place to begin identifying the community power structure is by researching the local newspaper morgue, county, city or state official records, community history, leadership listings of local fraternal and civic groups and the local library.

The status of development or economic conditions of a community help to determine who occupies the power structure positions at a given time. A community with a growing industrial base and a large flow of money might be dominated by bankers who can extend or refuse credit. A poorer community, dependent on state or federal aid to support its activities, might be dominated by politicians or persons with influence in the state or national capital. In certain areas, particularly New England and areas of the South, the power structure is determined largely through the “first families” who have inherited positions of power because of tradition.

Community's Opinion of the Military

In developing a planned community relations program, it is imperative for you to find out what the community knows and thinks about the organization, how its information is received and how public opinion about the command and its personnel is formed

Since military installations seldom can conduct or contract for public opinion or attitude surveys, they may have to rely on other means to appraise community attitudes and knowledge. While there is no fully satisfactory substitute for the professionally constructed and conducted attitude survey, there are other economical but less effective means of getting much of the desired information. A variety of sources are available and include the following:

- Records
- Reference books
- Bibliographies
- Syndicated research data published in newspapers and magazines
- Current periodicals
- Reports
- Publications of individual companies and of other federal agencies
- Directories
- Newsletters
- Catalogs

Periodic reviews of incoming and outgoing correspondence can identify community relations problems, as can spot checks on telephone courtesy of personnel who are in frequent contact with the public. Formal and informal contacts by key officers and individuals on and off the job also can be used to gauge public opinion, knowledge and attitudes.

Staff meetings and the inevitable grapevine can also be important internal sounding boards. Special attention should be given to an appraisal of internal public attitudes toward the organization.

Community Survey File

You must gather considerable information about a community to be certain you are using the right channels to get your message across to a particular community.

Since facts about the community are required on a day-to-day basis in public affairs activities, it is advisable for you to collect the facts gathered in a survey into a community survey file. This file should be kept up to date by the public affairs staff. It should contain detailed facts on the following:

- Local channels of communication
- Civic, economic, social, educational and religious organizations
- Local customs
- Traditions and mores
- Geography, manpower, industrial capacity, housing facilities and services existing in the community
- Names and biographies of local elected, civic and business leaders

In an overseas area, this survey should be developed in close consultation with representatives of the Department of State, the U.S. Information Service (the overseas name for the U.S. Information Agency) and other members of the U.S. Country Team.

The actual geographic area to be included in a community survey file will vary significantly from base to base. In general, the community relations area of an installation is the area where the base has an economic or social impact.

INFORMATION TO SEEK.— Your community survey file should include the following information:

1. **Area.** Include a geographical description with population, historical and economic data, and cost-of-living index.

2. **Recreation and entertainment.** List recreation and entertainment available, including museums, parks, commercial facilities, theaters, cultural attractions, and so forth.

3. **Civil government and officials.** List key personnel in the local government with as much background information as needed (within the bounds of the Privacy Act). Include their specific duties, titles, office addresses and telephone numbers. Avoid detailed files of personal data.

4. **Organizations.** Describe organizations within the area, including civic, fraternal, women's groups, youth activities, business groups, labor organizations and particularly veterans' organizations. Include names of contacts within these groups, such as president,

program chair and others. Former members of your service are good contacts. Also include a brief statement of each organization's goals, programs, meeting time and place.

5. **Housing.** List available housing, to include housing regulations, housing units, apartments, cost and adequacy.

6. **Other facilities.** Describe other community facilities and services, such as utilities, transportation, schools, hospitals, churches, doctors and dentists, fire and police protection.

7. **Communications media.** List all communications media in the area, with names of military editors or those with a specific interest in your command. It also should include deadlines and any peculiar style or policy requirements of the media.

A sample outline for making a community survey is shown in figure 5-1.

WHERE TO LOOK FOR INFORMATION.-

There are several places in which to gather information for your community survey file. These include the following sources:

1. **Chamber of commerce.** The local chamber of commerce may normally furnish invaluable information for such a survey and practical guidance and assistance in setting up a community relations program. The primary functions of the chamber of commerce are to promote the growth and foster the prosperity of the community. The chamber is also an excellent source of brochures, maps, fact sheets and other material needed for a community relations program.

2. **Unofficial base directory.** The unofficial base directory is another source of information. Advertisers in the directory have a message they are trying to give the personnel of your command. Often there is much good information contained in those messages.

3. **Local library.** The local library is also a good source of information. There is usually a section devoted to local information, and librarians are usually willing to give you a hand in finding what you need.

4. **Installation master plan.** The installation master plan or comprehensive plan includes an environmental assessment of the existing mission and facilities. Assessments generally include community environmental settings, such as historical, cultural, climatological and socioeconomic factors.

5. **Local media.** Following local news is essential. Equally helpful is researching back issues of

newspapers and magazines to gain historical perspective. Reporters and editors are also willing sources of information.

6. **City public affairs office.** The city PAO is the command PAO's local counterpart and will usually help in familiarizing military public affairs personnel with the community.

ANALYSIS.- After you have collected all essential information about the community, then and only then is it practical to make an analysis of the community. At first the community survey may seem to be just a set of facts, but through analysis, these facts come to life and fit together like a jigsaw puzzle. Each piece fits into the whole to make a complete picture.

In analyzing these facts, your public affairs staff will develop more and more insight into the needs, mutual interests and opportunities for favorable community relationships.

A thorough community analysis is the backbone of a sound community relations program. It is a continuing effort, but once assembled the community survey file provides a continuing ready source of information for speeches, news stories, special projects, exhibits, special events and special projects.

Community Organizations

The community relations planner should gather facts about the voluntary organizations in the community, including their continuing goals, leaders, membership, current projects and areas of mutual interest. These facts will help determine a basis for a tie-in arrangement and cooperative projects with these organizations. The importance of group membership on individual attitudes and behavior should be weighed carefully in planning efforts to reach key publics through their voluntary organizations.

Local organizations are a major outlet for the speakers bureau (see Chapter 6 of this manual). Most groups meet at least monthly, some as often as every week. Most offer opportunities for speakers and some for showing of motion pictures or other kinds of visual presentations.

Customs, Traditions and Cultures

The communities of naval installations vary significantly in local customs, traditions and culture. You must be aware of local differences before you plan any activity involving the community. Sometimes this variance causes the failure of a military community

- I. The Area
 - A. Geographical Description
 - 1. Size of area
 - 2. Population
 - 3. Climate, topography, annual and seasonal temperatures, rainfall, etc.
 - 4. Attach a map of the area
 - B. Historical Data
 - C. Economic Data
 - 1. Types of industry
 - 2. Unemployment rate
 - 3. Cost-of-living index
- II. Recreation and Entertainment
 - A. Cultural attractions
 - B. Commercial facilities
 - C. Parks
 - D. Spectator sports
 - E. Amateur sports
- III. Civil Government
 - A. Key personnel in local government
 - B. Home congressional offices
- IV. Organizations
 - A. Civic
 - B. Fraternal
 - C. Women's groups
 - D. Youth groups
 - E. Business groups
 - F. Labor organizations
 - G. Veteran's organizations
- V. Housing
 - A. Housing units available
 - B. Housing regulations/zoning laws
 - C. Cost and adequacy
- VI. Other Community Facilities and Services
 - A. Utilities
 - B. Transportation
 - 1. Highways
 - 2. Buses
 - 3. Taxi services
 - 4. Rail
 - 5. Air

Figure 5-1.-Sample outline for a community' survey file.

- C. Education
 - 1. Public
 - 2. Private
 - 3. Higher
- D. Health care
- E. Fire protection
- F. Police protection
- G. Churches
- H. Sanitation service
- I. Hotels and motels
- VII. Communications Media
 - A. Newspapers
 - 1. Military writers/contacts
 - 2. Key personnel
 - 3. Deadlines
 - 4. Policy considerations
 - B. Broadcast Media
 - 1. Radio
 - a. Type format
 - b. Key personnel/contacts
 - c. Deadlines
 - 2. Television
 - a. Network affiliation
 - b. Key personnel/contacts
 - c. Deadlines
 - d. Policy considerations
- VIII. Public Relations
(Contacts listed by company)
- IX. Community Leaders
(List those in community power structure and types of issues they influence.)

Figure 5-1.—Sample outline for a community survey file—Continued.

relations program or special event. Acceptance of the Navy and of newcomers, information on local holidays, taboos, peculiarities of local dress and social activity-particularly the various levels of society and public interest in education, libraries, museums, art and music-should be determined. While a Sunday public visitation of your command may be completely acceptable in the southwestern United States, it might antagonize relations in certain small communities in the East and South. But customs, traditions and culture are equally important as opportunities and channels of communication to reach key publics in the community. Individuals are usually tuned to the frequencies transmitting messages related to their personal mental set or awareness of the world around them.

Mutual Problems and Interests

Before the opinion leaders or the community at large can be motivated to act, there must be an understanding of mutual interests. Every community knows what it wants for its well-being, what it expects each organization to give and how it measures contributions.

The following are opportunities for mutual interest between the Navy and the community:

- Commercial property
- Support of religion
- Full employment
- Adequate schools
- Law and order
- Area growth and development
- Adequate and low cost housing and utilities
- Varied recreational and cultural opportunities
- Individual and public welfare
- Health and sanitation

As a starting point, it is worthwhile for the public affairs staff and the base-community council to consider each of these areas of mutual problems and interest as posed by the following questions:

- What is the economic impact of the Navy on the local community? Is the public aware of this?
- Have plans and agreements been worked out between the Navy and local officials on mutual

aid in the event of a natural disaster, accidents, epidemics of sickness or disease?

- How much cooperation is there between local civilian law enforcement agencies and Navy law enforcement and security organizations?
- Does the community provide adequate schools and cultural activities? Is the community aware of the educational and cultural needs of the Navy?
- Does the community know how much the Navy spends in the local area for services and supplies? Are items purchased elsewhere that might be obtained locally?
- Is the public aware of the contributions by naval personnel of funds and services to local charities and service organizations? Do command personnel know what services are provided to them?
- Does the command contribute to local health and sanitation problems?
- Do the local citizens know how much effort is made by the Navy to strengthen local health and sanitation?

Past and Present Community Relations Activities

It is rare for a public affairs staff to have the opportunity to start fresh and build a command community relations program from the ground up. Like our personal heritage, most PAOs and officers in command inherit a community relations program from their predecessors, in both their own installation and other service organizations in the community. The local stereotype of the Navy can be greatly affected by the previous community relations programs or by a complete lack of contact between the Navy and the local community.

If the organization and the Navy are not new to a community, the public affairs staff must determine the status of community relations programs and try to evaluate community relations efforts. One of the first steps is for the staff to become acquainted with the public affairs staffs of other military and federal organizations in the area. An analysis of the data collected in the community survey can reveal considerable information about previous community relations programs. Informal discussions with appropriate local reporters and chamber of commerce

officials can reveal a great deal about previous programs and the lessons learned from them. If a base-community council exists, the members and records of the council will offer valuable information.

Defining the Problem

Once the fact finding and analysis are completed, you are prepared to determine the key community relations problems of the command. When the problems have been defined, the solutions must be provided and decisions made to prevent or correct them. After the problems have been clearly stated, you are ready to develop a plan of action. Some of the problems can be remedied without conducting a full-blown community relations effort. This is done by referring obvious and easily correctable problems to the proper representatives or by setting up committees to cope with each area of interest. Their recommendations maybe carried out directly by the base-community council or through the organizations concerned. Some problems caused by a considerable lack of understanding in the community of the mission and contributions of the military to the local community may require special plans of action. These plans are integrated into the overall community relations program. A community relations program requires long-range or strategic planning that, in turn, will require short-range or tactical plans to accomplish the goals of the long-term plans. All must be interrelated.

PLANNING

Planning begins with a draft of the proposed community relations program, including a statement of objectives and a tentative schedule of projects and activities. It should contain a statement of policy and general philosophy, using such guidelines as the PAO, CO and higher authority may provide. The basic statement also should spell out specific delegations of authority for community relations activities. This will provide a frame of reference for the listing of objectives-long-range and short-range-and a blueprint for operations. (A sample community relations plan can be found in *PA Regs*, Chapter 4.)

Working from the general proposal and considering the program objectives with the facts gathered in the survey and analysis, you should plot ways and means of attaining community relations goals.

Consider the following questions with respect to each community relations objective:

- Which publics are involved?

- What guidelines and directives must be followed?
- What projects or activities can contribute to the attainment of the goal?

The authors of *Effective Public Relations*, Scott M. Cutlip, Allen H. Center and Glen M. Broom, believe that every community relations project or activity must be measured against its contributions to organizational goals. For instance, the DuPont Company follows a checklist that measures each project with an "analysis" formula:

- What is the objective this project is designed to gain or approach?
- Is the objective sound and desirable?
- Are there collateral advantages?
- Is the project possible?
- Can it be done with existing personnel?
- Does it involve cooperation outside the department?
- Is it counter to sound public relations policy?
- Is it counter to company policy?
- Is the expense too high in relation to possible gain?
- Can it embarrass sales, production or research?
- Where is the money coming from?
- What are the penalties of failure?
- Why do it now?
- Why do it that way?
- Who approved the project?
- Who must be informed?

Obviously, every command cannot afford a full-blown community relations program. Others may find it necessary to develop a phased program, beginning with a few key program elements and adding others regularly. Experts believe that the basic elements that a command begin with are the following:

- An effective ship or station newspaper
- A speakers bureau
- Correspondence with opinion leaders and decision makers

- Personal contact and social activity between the officer in command, the PAO and his staff, the key opinion leaders and decision makers of the community

The integration of news releases and military-produced radio and television programs within the community relations program is also worthy of consideration. Oftentimes, proper use of these tools can help to bring knowledge of a military command, its activities and its personalities to the attention of the local populations of neighboring communities.

COMMUNICATING

Communicating requires the public affairs staff to explain and dramatize the chosen course for a community relations program to all those who may be affected and whose support is essential.

Once the proposed plan has been drafted, it should be coordinated within the originating organization and given a preliminary review by the chief of staff or XO of the organization. Key staff officers should be made aware of the proposal and have an opportunity to express their views. For this reason, the PAO makes certain that the basic plan is sound from both a public relations point of view and as completed staff work; otherwise, the plan that requires expenditure of resources that might be put to other use by other staff agencies may never get off the ground.

A conference or series of conferences attended by key staff representatives sometimes helps to develop understanding and acceptance of a program, identify problems and omissions and give people in the chain of command a sense of satisfaction in having helped to develop the program. The proposal, as modified by staff contributions, then should be presented to the commander for approval.

The plan should provide that, once it is officially adopted, all members of the organization be made aware of it. Community relations are a team effort in which many individuals must play a part. Basic information given should include why the officer in command is concerned about community relations, what policy has been adopted, what projects are planned, what participation is desired and why and how members of the command can benefit. Some commands have used a theme, such as "Partners in Progress," to convey to all members of the organization their relationship to the program and the community.

Individuals and agencies responsible for specific projects and activities must be informed of their responsibility. Information also must be sent concerning

deadlines, counseling and assistance for those participating in the program, the system for review and evaluation of the projects and program and how recommendations for changes in objectives, new projects, and so forth, may be made.

The amount and kinds of information an organization should disseminate to its publics will vary. In a community relations program, there should be provisions to inform everyone in the community about the mission and achievements of the organization, its personnel needs, career opportunities, notable individual achievements, significant changes of key personnel and safety and economy achievements.

If the survey and analysis of the community has been adequate, the public affairs staff should be aware of the right channels of communication to accomplish specific tasks or reach specific publics.

The average naval activity has many chances for interesting news stories that would contribute to improved community relations. Here are just a few possible community relations subjects for timely local communication with the public:

- Changes in mission or program.
- Attainment of significant goals.
- Decreases or increases in work load.
- Introduction of new methods or devices to increase productivity or effect economy. (Zero defects is an example.)
- Plans to hire more people or need to reduce force.
- Important changes in organization.
- Appointments to key positions.
- Retirements.
- Speeches or other public statements by people.
- Plans for new facilities or closing of existing facilities.
- Achievements of military personnel and civilian employees.
- Results of incentive awards program.
- Special events, such as awards ceremonies, public visitation, dedications, launchings, christenings, commissioning, anniversaries, tours, guest cruises, exhibits, demonstrations, and so forth.

When you prepare news releases, speeches, special events, displays or other vehicles to be used to

communicate with the internal and external publics on behalf of a command's community relations program, use the communication skills discussed in Chapter 6 of this manual and the "Special Events" section of this chapter. If you disregard or improperly use the facts gathered in the community survey when designing community relations communications, the efforts may result in mere publicity and no significant contribution to the program.

EVALUATING

The final step of the community relations program is the evaluation of results and the effectiveness of techniques used. Use this step to answer these questions: How did it go? Would it have been better if something else was tried? This step leads back to the first step, since it is rare that a community relations program ends abruptly once it has been set in motion.

In addition to measuring the bits and pieces of the community relations program, the overall program should be reviewed and results measured against the objectives determined in the planning segment. The end of a calendar year is often a significant opportunity for a public affairs staff to prepare an evaluation of its mission accomplishment. Some organizations publish a narrative history, documented with examples of significant public affairs activity. This type of analysis serves at least two purposes. First, it provides the public affairs office the opportunity to analyze public affairs efforts and determine the lessons learned for future reference. Second, it serves as a vehicle to inform the key staff agencies, subordinate units and commander of the significant accomplishments of the public affairs office during the previous year. If the analysis is to be used for critical evaluation of lessons learned, the sensitive elements of the study should be maintained for office use only, since their release could seriously impede the organization's relations with the public.

SPECIAL EVENTS

Learning Objective: Identify the types of special events and the importance of audience targeting and public factors.

A special event is an event that is staged or conducted to dramatize a factor convey a message to a public. These events include news of a special type. A special event is not just a fact. It is a definite event that is planned and controlled. Special events, then, are **planned news**— news that is planned to achieve

increased public understanding and support for a command, the Navy and the DoD.

For example, consider the launching of a new class of submarine using a revolutionary weapons system. This can be done with utmost secrecy to hide the Navy's new capability from a potential enemy. Or it can be done in a matter-of-fact manner at the appropriate time during the construction process. Either method would be efficient.

Why, then, was this ship launched with waving flags, television cameras and a band playing traditional Navy songs? Why didn't the DoD assume complete secrecy or merely ignore the event? Why bother with that type of event at all?

The obvious reason is that the advantages of worldwide news media and the pageantry of the event outweigh any disadvantages. The launching of the submarine clearly shows the world that the United States had added a lethal weapon to its defense force. And since the weapon, once operational, would have to be concealed to be effective, the special event served the essential purpose of proving that the weapon did exist. As a side effect, the launching also gives recognition to the men and women in the Navy, to industrial specialists who designed and engineered the submarine and to the management and workers of the shipyard as well as all the associated contractors. It vividly dramatized the importance of sea power and improved the morale of Navy men and women ashore and afloat. However, its chief purpose was to make the deterrent effect of the new weapons system a reality.

On a smaller scale, it is a special event when the captain awards a Letter of Commendation, presents a Good Conduct Medal to a BM2 or when a 20-year chief is piped over the side to join the Fleet Reserve. The BM2's multiple would be just as high on the next advancement examination if the medal were sent to him by guard mail, as long as the proper entry was made in his service record. And the chief's retainer will not go any further at the commissary just because all hands turned out to see him off. In both cases, the event is staged for its morale effect to reward good men and women for faithful service and to encourage others to serve as well.

TYPES

Special events in which Navy participation is authorized and sanctioned include a multitude of happenings, all of which are described in detail in *PA Regs* and include the following:

- Parades

- Fairs
- Band concerts
- Celebration of Navy anniversaries, national holidays and military observances
- Fund-raising events
- Meetings, conferences and public appearances of naval personnel
- Aircraft and parachutists flyovers, displays and demonstrations
- Public visitation (tours, ship visits)
- Participation by athletes, teams, bands, color guards and other Navy units in sports events
- Navy speakers (see Chapter 6)
- Orientation and guest cruises in ships and aircraft
- Exhibits
- Navy art shows
- Official honors and ceremonies, such as VIP arrivals, ship launchings, commissionings and decommissioning, changes of command, award presentations, retirements and dedications
- Staging of Navy demonstrations
- Official civil ceremonies, such as inaugural parades for U.S. presidents and state governors
- Ship visits to foreign ports

The planning and execution of most of the above events are governed by complicated, technical DoD and Department of the Navy policy guidance. This policy is constantly changing. Make sure you have at your disposal and are familiar with all current guidelines referred to in the references cited above when you are engaged in special events activity. There are also many varied administrative procedures involved, such as reports, records and detailed request forms for armed forces participation in public events.

For example, flyovers by military aircraft at civilian public events may appear to be simple events to arrange. Your first thought might be that it is just a few planes buzzing a field.

The reality is that civilian sponsors for military flyovers of off-base civic events must forward their request to ASD(PA) for consideration. While the various military services may approve flyovers on military installations, ASD(PA) is the only authority for

approving flyovers in the public domain. (CHINFO can authorize flyovers of off-base civic-sponsored observances of Armed Forces Day, Memorial Day, Independence Day and Veterans Day. Consult *PA Regs*, Chapter 4, for further information regarding flyovers.) Use DD form 2535, "Request for Military Aerial Support; in planning a flyover.

Public affairs people must be thoroughly familiar with all regulations before even discussing participation with a sponsor. The sponsor must not be left with the impression that the flyover is committed before he receives official approval from the military department or DoD level.

To prevent misunderstandings, you can provide civilian sponsors with a copy of the format for requesting armed forces flight and parachute teams when they request a flyover. The PAO can then forward the checklist through proper channels to CHINFO, or the sponsor may submit the request directly to OASD(PA).

TARGETING THE AUDIENCE

Special events inform or educate the publics at which they are aimed, and they help to cement community relationships. They call attention to new developments and new programs—anything that is new and significant in the Navy. Most important, special events should be used to emphasize themes in support of community relations objectives.

A special event should be aimed at one or more specific audiences or publics. These may include the internal public, the community, regional, national or international audiences or special publics.

Internal

Special events aimed at internal audiences include family cruises, ceremonies opening new facilities on base (Navy Exchange, recreation buildings, barracks, and so on), athletic events and most award ceremonies.

Community

Participation in local celebrations, assignments of speakers and marching units near the installation, public visitation, most air shows, local exhibits and similar events are aimed at a community audience.

Regional, National and International

A Navy exhibit at a state fair, well-publicized launching and commissioning ceremonies, unveiling of

new weapons, special demonstrations, Allied exercises and operations and other major events carry the Navy's message to audiences far removed from the event itself. In this sense Navy special events often play a part in demonstrating our capabilities and the firmness of our country's policies to our friends, potential enemies and neutral nations.

Special

Navy participation in professional or technical meetings, assistance to youth groups, such as Boy Scouts or Sea Cadets and programs conducted for specific organizations, such as the Navy League or veterans groups, reach people with special interests regardless of geographical distribution.

Practically every event affects more than one of these publics. It is a basic principle of public relations, however, that everything you do should be done for a specific purpose and with a specific audience in mind. For this reason and because the rifle approach is frequently better than the shotgun, it is good to have specific publics in mind when you are planning a special event.

SPECIAL EVENTS POLICY

Learning Objective: *Outline the special events policy of the Navy.*

The Navy's policy on participation in special events is clearly stated in *PA Regs*. Broadly speaking, the Navy may participate in events sponsored by the local community or by national organizations when participation accomplishes the following goals:

- It is mutually beneficial to the Navy and the public.
- It can be arranged without interfering with operations or training.
- Support is available within the command requesting it.
- Support will not directly benefit an individual or commercial concern and can be provided at no additional expense to the government.

Most local organizations are under the misunderstanding that, if the military provides support, it is free. However, all expenses above the regular cost to the government must be met by the requesting sponsor. *PA Regs* gives complete details of the conditions under which participation will be authorized and the level of

command at which such participation authorization may be granted.

SPECIAL EVENTS PLANNING

Learning Objective: *Recognize the considerations involved in planning a special event.*

There are specific techniques that apply to each type of special event, and it would be impossible in a manual of this kind to say everything about all of them. There are, however, certain basic steps in planning and carrying out such events. The senior journalist should know these basic procedures, as there are many tasks in virtually all phases of special events work that the PAO may delegate to you.

At a command where there is no full-time PAO, the senior journalist may be the only person with the knowledge and skills required to plan and execute successful special events. In this case you will be an important adviser to the project officer, the XO or the skipper.

OBJECTIVES

The first step in planning a special event is clarifying the objectives of the event. Our definition states that special events are events staged to dramatize a fact or convey a message. If the event is actually staged primarily for this purpose (public visitation, an exhibit, a parade or an award ceremony), the objectives of the event dictate the details of planning. Within reasonable limits, items that conflict with these objectives can be changed or dropped. If the event has been scheduled for some other purpose—as when a guest cruise is arranged to take advantage of a regularly scheduled training exercise or routine ship movement—operational considerations normally take precedence, and public affairs plans must be built around them.

Only when public affairs aspects are of major importance—as when a fleet exercise is being combined with a demonstration for high ranking officers or VIP civilians or when an exercise overseas is planned partly as a demonstration for people of allied nations—are such operational plans likely to be modified in favor of public affairs objectives.

Such decisions, of course, are made at the highest levels, often by the staff of the fleet commander in chief. The senior JO is rarely concerned with them. On the more immediate level where the event is carried out, however, you will often find yourself involved in the detailed planning of a special event. When this happens, you should ask “Just what are we trying to

accomplish?" Even small special events require detailed planning and time-consuming, hard work on the part of many members of the staff. Clarifying objectives early in the planning process ensures that this work is not wasted.

PLANNING

There is no single formula you can use to plan all special events. Certain guidelines can be followed, however, and the process is not too different from the planning process an operational commander goes through in analyzing his mission, estimating his tactical situation, making a command decision and drawing up the directive to be sure his forces carry out the mission.

The process starts by your stating in broad terms what you are going to do and why. Consider the following examples:

- This ship will conduct a dependents' cruise on 4 July to increase dependents' understanding of our duties and thereby enhance morale.
- This station will hold public visitation on Armed Forces Day to increase public awareness of the importance of sea power and to further our community relations objectives.
- The CO will present Good Conduct Medals and advancement certificates after inspection Friday morning to reward recipients and encourage others to achieve similar recognition.
- This ship will embark 12 Secretary of the Navy guests while en route from San Francisco to Pearl Harbor to further the objectives of the Secretary of the Navy Guest Cruise Program.
- A group of community leaders will be flown to the U.S. Naval Academy for an orientation visit to induce outstanding young men and women of the community to apply for academy admission.

Statements such as those above will help you keep your eye on the target in later phases of planning. It will probably appear in an early paragraph of your planning directive, if the event is big enough to require one.

FACILITIES

Next, consider the facilities you have at your disposal. These may include ships, planes and lesser hardware at a major event, portable items used in exhibits and such live participants as speakers, marching units, bands and color guards. With these "attractions,"

consider the working facilities you have at your disposal: the size and capacity of your own office, logistic support (guides, transportation, bleachers, brochures and other printed matter, etc.) and the countless minor items that take time, talent and usually money to produce, but are indispensable in a major special event.

It is only after you examine your event and its objectives considering these available facilities that you are ready to decide just how much can be done and who will carry out what tasks.

At this point nothing is more important than attention to detail. An event of major proportions may be a miserable flop if only one detail is omitted from the basic plan. The results of a poorly staged public event might include adverse publicity on a local, national or international scale.

Consider, for example, the embarrassment of Olympic Games officials in the following incident recounted from *Coronet Magazine* in November 1956:

"The officials were embarrassed because in making plans, someone had overlooked the details involving the entrance of the traditional torch bearer. When the famous Finnish miler, Paavo Nurmi, appeared at the gates of the Olympic Stadium in Helsinki, he was denied entrance. His torch had been lit in Athens and passed by 15,000 other runners and finally to Nurmi at the stadium. At the end of the colorful pageantry and fanfare, Nurmi was scheduled to appear, but the police kept him standing in his track suit before the stadium gates. At last one of the dignitaries recognized the famous runner with the torch and gave him entrance."

It is equally embarrassing when plans fail to provide for clearance of visiting dignitaries into the VIP area, for delivery of brochures to the distribution point, for media parking, for properly briefed escorts, for advance clearance for media representatives to board boats or helicopters, or for any other essential details. These areas can be planned far more readily when the directive is being written than when left until the last minute. When a planning directive clearly outlines what is to be done and who is to do it, execution becomes easier.

EXECUTION OF THE PLAN

The next step is executing the plan. Operations personnel call this step "supervising the planned action," and the operational planning manuals say that the best way to do this is to start with a good plan.

In a major event, you must designate someone to coordinate public affairs matters. This person should be relatively free of other duties. If the event involves operations, operational and public affairs planning should be carried on together, with the public affairs aspects covered in an annex to the operation order. If the event is a major one ashore, one command directive probably will include all details, including public affairs, security and logistics.

EVALUATION

The fifth major step is to evaluate the event. This step is as important in public affairs as an exercise critique is in operations. The JO, with his media skills and public information know-how, is an ideal person to help the command and the PAO evaluate special events. After each such event, before you get deeply involved in the next event, try to answer the following questions:

- Did this event accomplish its objectives? If so, why? If not, why not?
- Did everyone know just what his duties were and carry them out properly?
- What, if anything, could have been done that was not done?
- What kind of media coverage did we get? Did this event help or hurt media relations, community relations or internal relations?
- How can we do it better next year?

In a major event, it is appropriate for the coordinating command to request formal or informal reports from subordinate commands. It is always a good idea to check with participants, the photo lab, media people who covered the event and anyone else who was concerned to find out what was done well and how certain areas can be made to run more smoothly.

REPORTS

Evaluation is useless unless it is committed to paper. Therefore, the final step is to prepare the report(s). This should always be done unless it is obviously unnecessary. Your report can be a memo to the CO attaching a clipping from the local paper, or it can be a letter to higher authority enclosing copies of your plans, clippings and photographs. In either case, the primary purpose of such reports is to show what has been accomplished and to submit recommendations for future similar events. Reports that do nothing but pat you

on the back and tell your superiors what a wonderful job you did are worthless.

SPECIAL EVENTS CHECKLIST

Appendix VII of this manual contains a general special events checklist. Study the entire checklist before you use it for specific occasions. After study, you may prepare your own checklist, using pertinent items and adding others of your own choosing.

CEREMONIES

Learning Objective: *Identify the special events planning guidelines for military ceremonies.*

Let us go back a few pages to that awards ceremony where the skipper is going to pin a Good Conduct Medal on that BM2's chest. We will assume there are five petty officers receiving various awards: two Good Conduct Medals, one advancement to first class petty officer, one appointment to chief petty officer and one Letter of Appreciation to a chief transferring to the Fleet Reserve. The CO wants to present these awards and promotion certificates Friday morning after inspection. The PAO is TAD and you are responsible for coverage, plus any "arranging" the event requires.

This is a very simple event. The crew will be paraded at quarters. If you are ashore and have a bit of room, all hands may pass in review as part of the ceremony. You probably have a small platform and you will need a public address system.

What are your objectives? The CO wants to praise these individuals publicly by rewarding them for good service and to encourage the nonrated men in the crew to work for advancement. This means your plans should ensure the following:

- The skipper makes each award individually and speaks to each man.
- The crew can hear, and if possible, see what is going on.
- The event is covered by the ship or station newspaper.
- The releases are mailed to hometown media (via the Fleet Home Town News Center or the proper NAVINFO).

This is easy. You send one of your junior JOs to the personnel office for the names and locations of the individuals concerned. He then gets basic hometown data on each, supplementing this with an interview to make sure he does not miss any good feature material.

if you get this information beforehand, there is nothing to prevent you from preparing your story material Thursday afternoon. Then, if all goes according to schedule, you can distribute the release by Friday noon instead of working on it over the weekend or leaving it until Monday morning.

Go over the plans for the event with the XO or the personnel officer or perhaps the skipper himself. Make sure the people to be honored have a place to stand during the first part of the ceremony and they arrive front and center in the same order as the awards will be handed to the CO. Additionally, make sure the entire ceremony takes place in front of the microphone and that your photographer will be able to get a shot of each person with the skipper, with the award recipient's face clearly identifiable.

One way to slow the captain down a bit is to furnish him a bit of background information on each individual. Then he will pause and say a few words to each man, giving the photographer enough time to get the shot. If the CO has a citation to read, the photographer can use this time to get ready for the next picture.

If experience with this particular skipper or location has already proven that it is impossible to get good pictures at the actual event, arrange to shoot an individual photo of the awardee. The individual picture can range from an informal portrait of the recipient in his working environment to a standard head and shoulder shot. Then you can settle for one overall shot during the ceremony.

MAJOR EVENTS

If the event is more complicated, of course, so is your job. At a major event you have to consider many more problems than just hometown coverage. These may include some of the following:

- Deciding what the program will be and establishing an order of events
- Drawing up a guest list and preparing written invitations or the form for a printed invitation
- Making a seating plan for participants, VIP guests and the general public, and possibly providing transportation or parking, or both
- Arranging Navy photo, press and radio or television coverage
- Distributing advance news releases and news advisories

- Escorting reporters and providing them vantage points from which to do their jobs

Obviously, you cannot do all of this yourself. The best plan is to draw up a command directive appointing a coordinator or project officer and assigning tasks to appropriate subordinate commands or members of the staff. This does not relieve the PAO or senior journalist of any of the work but it gives you all the authority you need to do your job. Your command planning directive might look something like the command planning directive in figure 5-2.

If you use the command planning directive as your working document, the special event should go off without a hitch. There is no reason you should worry about a VIP's lunch, parking arrangements or the other details that are properly the concern of others in the command. The Navy way is to give these problems to the appropriate department heads—as an OPORD gives tasks to a task unit.

ARRANGING NEWS COVERAGE

In arranging news coverage for a special event, you must prepare advance releases and a news advisory, informing the media that they are welcome to cover the event.

In the hypothetical case used in figure 5-2, your news advisory results in responses from two local morning papers and one evening paper. One of the morning papers is also covering for UPI. AP is sending its own reporter. Two television stations are sending photographers and three radio stations are also going to record the entire event, later editing their tape down to short sound bites for news broadcasts.

Your office staff consists of the PAO, yourself, a J03, two JOSNs and a PH2. The boss has a civilian secretary who does not like to work on holidays.

While the PAO is busy working on guest lists and seating arrangements with the XO, you start laying out your requirements for space, furniture and power. You will have four video photographers, two from each television station. Each station will use a photographer with a Betacam on a tripod. They will need fixed positions in front of the reviewing stand where they can get a good view of the SECDEF and pan around to the troops on the field. The stands have to be as solid as possible to cut down on movement and obviously to support the photographers and their equipment. Also, you do not want the photographers right in front of the reviewing stand where they will obscure the SECDEF's view of the field.

From: Commanding Officer

To: Distribution List

Subj: VISIT OF THE SECRETARY OF DEFENSE ON 4 JULY 19__

Encl: (1) Schedule of events

(2) Seating chart for reviewing stand

(3) Parade diagram

1. Purpose. his notice outlines ceremonies to be held on 4 July 19_ in connection with the visit of the Secretary of Defense.

2. Background. Here, stated briefly, are the reasons for the Secretary's visit and a list of the important members of his party. Here, or in a separate paragraph, reference is made to the schedule, seating chart and parade diagram, which are attached as enclosures to avoid making the basic notice too long and involved.

3. Responsibility. The executive officer will coordinate all arrangements for this event. Other officers are assigned responsibilities as follows.

a. First Lieutenant. Rig reviewing stand as shown in enclosure (2), providing charts, bunting, a speaker's stand and public address system as required. Police area immediately before ceremony.

b. Security Officer. Establish traffic control to ensure speedy clearance through main gate and clear passage to headquarters building. Provide escort vehicle. Control visitor traffic and parking as required.

c. Public Works Officer. Provide photographers' platforms as shown in enclosure (2) and as specified by the public affairs officer. Provide adequate electrical power for operation of recorders as requested by the public affairs officer.

d. Medical Officer. Provide ambulance and appropriate personnel on standby basis.

e. Senior Watch Officer. Act as regimental commander at inspection. Make sure that all departments are paraded in position by 0830. Schedule rehearsal as required.

Figure 5-2.—Command planning directive for a major event.

f. Commissary Officer. Provide luncheon for SECDEF party, commanding officer and guests, a total of 25 persons, in Wing 3 of the main galley. Party will proceed through mess line and use standard mess gear. Following luncheon, the SECDEF may inspect the galley.

g. Public Affairs Officer. Arrange publicity as appropriate, including such live coverage of the event as is desired by media. Keep other concerned department heads informed of requirements for gate clearance, parking, special power connections, furniture, and so forth. Assist executive officer in whatever coordination is required.

4. Cancellation. This notice is canceled 6 July.

Figure 5-2.—Command planning directive for a major event—Continued.

Platforms/Fixed Positions

Public works should build solid platforms about 8 feet by 8 feet and about as high as the floor of the reviewing stand. Place the platforms at 45-degree angles from the center of the stand, far enough back so they are not too obtrusive and where they will not interfere with troop movements. At an even bigger event, the platforms might be made of piping or lumber and be two or three stories high with at least two camera levels. Additionally, find out from the stations just what power they need to operate their equipment and see that public works gets the requirements.

The radio reporters also will want fixed positions, preferably a table for each station with two or three chairs, enough for an announcer, an engineer and perhaps a director, assistant engineer or second announcer. These should be far enough apart so one station will not pick up another announcer's voice. Again, check with the station to make sure of power requirements. Try to have the television and radio reporters or photographers come early enough to test microphone placements in advance of the event.

Mobile Media

Newspaper and television photographers will want freedom to move around. You also will have a Navy still photographer on the field. You do not want to impede their movements unnecessarily; also, be aware that too many photographers can mar what is planned as a dignified military ceremony.

Pools

Depending on the nature of the ceremony, the space available and the number of media involved, you may want to set up specific ground rules for mobile photographers. These rules may include establishing a pool arrangement where each organization works from a fixed position and all products are available to all participants. Pods are not particularly popular with photographers, who are in a competitive business and do not want to end up with the same pictures the competition has. However, pools are better than no coverage at all, and they are almost always acceptable in a pinch.

The ground rules for all phases of special event coverage should be drawn up well in advance. Photographers who come to cover a major event expecting complete freedom and ideal facilities will not be anxious to come to your next show if you impose restrictions and unwanted pool arrangements on them

without warning. They will be especially upset if they feel the restrictions were unnecessary.

Reporters, of course, pose less of a problem because they want to see the entire event. They will want advance copies of speeches, and if none are available in advance, they will want copies immediately afterward. They may want to interview important personalities (such as VIPs). Also, count on reporters requesting access to telephones immediately after the event.

Staff Assignments

Detail the J03 to work with the television photographers, whose requirements are greatest, and let one JOSN stand by to help the radio crews. The other JOSN will have to miss the show. Someone has to stand by the office telephone. The PH is out there with photographic equipment and you and the PAO are available to solve any problems that come up.

Miscellaneous Items

Media should be provided with car passes or parking stickers in advance, and you should make sure the gate and traffic control personnel have been sufficiently briefed so they will recognize and honor those items.

Results

Because this event was planned to permit maximum and efficient coverage, everything ran smoothly. The radio reporters got their tapes. The television reporters got their videotape. The newspaper reporters talked to SECDEF, then phoned their stories from the public affairs office. The PAO furnished a few cups of coffee and provided some last minute background material. The evening paper and both morning papers carried pictures and stories. Each wire service moved a couple of hundred words. The radio stations ran tapes on their evening news programs. Both television stations aired good-sized stories and one fed it into a network newscast. The skipper told the project officer he did a fine job of coordinating and the word was passed down the line.

IMPORTANCE OF DETAILS

Whatever the event, there is no substitute for attention to every detail, no matter how insignificant some details may seem. A visitor to an exhibit or open house, the guests at a commissioning ceremony or guests on an orientation cruise should never catch the

Navy unprepared. Just as when a ship is replenishing at sea or an amphibious force is assaulting a beach, every detail should be thought of and every contingency provided for in advance.

When you have effectively planned and organized your special event well, it will easily match the definition described at the beginning of this section. In special events, special arrangements will help you drive home your message.

Devices are especially important on guest cruises and similar orientation visits. They include such particulars as special name tags, place cards, identifying caps or pins, booklets, wallet cards, humorous awards and other souvenirs. Their value is threefold:

- They represent that added touch that shows the Navy wants to be more than a good host.
- They often contain, in capsule form, the message the event is designed to get across.
- They serve to remind the Navy guest of his pleasant and usually very educational experience with the Navy.

Identification Tags

When guests come aboard a ship or station, it is always a problem to identify individuals and to make sure that people, baggage and transportation are routed to the right places at the right time. This problem can be overcome if a guest list is compiled well in advance and if billeting and transportation arrangements are made before the guests arrive.

A color scheme can be followed in making out lapel identification tags, place cards, identification signs for buses, boats and aircraft or any other types of identification or direction devices you may use.

Encourage guests to wear lapel tags. These should be large enough so they can be read at a distance of about 10 feet. Include each guest's profession or business and hometown as well as his name on these tags. Suggest that the guests wear them on their right lapel. This way the tags can be read easily when the guests are shaking hands. Tags on the left lapel are nearly invisible in this position.

Billeting

If the group is small and will not be broken into other groups, billeting is less of a problem. Be sure a list of names or room numbers is furnished to the quarterdeck wardroom attendant, CO, XO and others who should have the information. If guests will be billeted with the

ship's officers, try to get some information on each guest to the officers concerned. A guest will feel more welcome if his roommate knows he is coming.

Baggage

If guests' baggage will be moved any distance by a working party, have baggage tags already made out with each individual's name and billet number. Anyone who has traveled any distance will appreciate having his baggage delivered to his room promptly so he can clean up before beginning the strenuous orientation program the command may have laid out for him.

If your group is large and you want to break the guests into several subgroups, use different colors for each group's baggage tags.

Pamphlets and Programs

People coming aboard ship for a guest cruise or even for a simple public visitation like to know what is happening and to have something to take away with them. For this reason, no event of this type is complete without a pamphlet.

The easiest type of program to prepare for public visitation is a special edition of the ship or station newspaper. Devote most of the front page to the event and print a program there or on the back page. If appropriate, print a map on the back page showing the location of major points of interest and routes to follow. The remainder of the issue can be devoted to the usual content of the paper.

For small groups, one simple program should contain only the information a guest needs without snowing him under a mountain of superfluous information. By printing successive sections on different size pages and indexing each section at the bottom of its first page, the command has prepared an attractive book with a lot of useful information arranged for ready reference.

Photo Brochures

Some commands compile attractive photo brochures for VIP groups that serve both to emphasize the objectives of the cruise or orientation visit and as a souvenir of the event. Photographic coverage is carefully planned and the best shots are selected and printed in the finished book. Sufficient margin should be left on the left side of the photos for binding. Captions emphasizing the message the command wants to plug are prepared to accompany the photos.

The next step is to dry-mount the pictures and captions so when the booklet is assembled, the caption will appear facing the appropriate photograph. If the job has been done correctly, each page is trimmed individually. This is done with the photo side up, since its dimensions are more critical than those of the caption. The first cut is made on the right side, making sure it is exactly parallel to the left margin. Then trim the top and bottom, and the pages are now ready for binding.

Covers for the book can be made of commercial display board that can then be covered with felt paper if desired. Your covers should be cut larger than the inside pages of the book to protect the pages.

The booklet is then bound with commercial punching and plastic binding equipment available at many commands. The finished book is mailed to the guest a week or two after he leaves the command. The CO-or perhaps a flag officer-signs the forwarding letter which tells him it has been a pleasure having him aboard and expresses the Navy's hope for his continued interest in naval affairs.

Souvenirs

There is virtually no limit to the types of souvenirs that can be used in special events, many at little or even no real cost. Some commands add the cost of such mementos to the guests' mess and entertainment bills, with the knowledge of the guests, who usually are pleased to know that neither the taxpayers nor the ship's crew are digging into their pockets for these costs.

A common souvenir is a ship or station photograph inscribed by the CO. Other popular items include baseball caps with the command's name or emblem embroidered paperweights or desk ornaments made from scrap materials, such as flight deck planking or aircraft metal.

Many commands make up wallet-size cards identifying the guest as an honorary submariner, plankowner or a veteran of a particular operation (see fig. 5-3). One command awards a "lavender heart" medal to any guest who suffers an injury, such as a bruised forehead or shin suffered in passing through a hatchway.

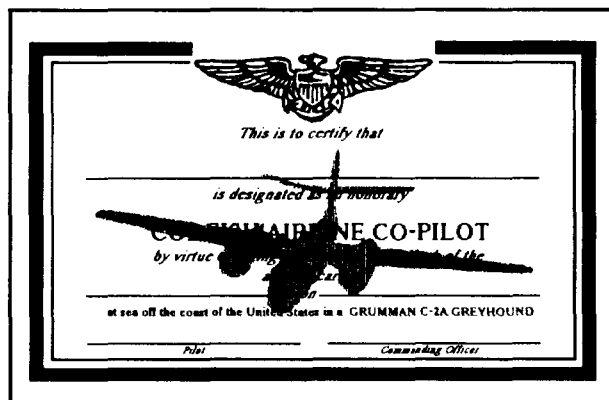
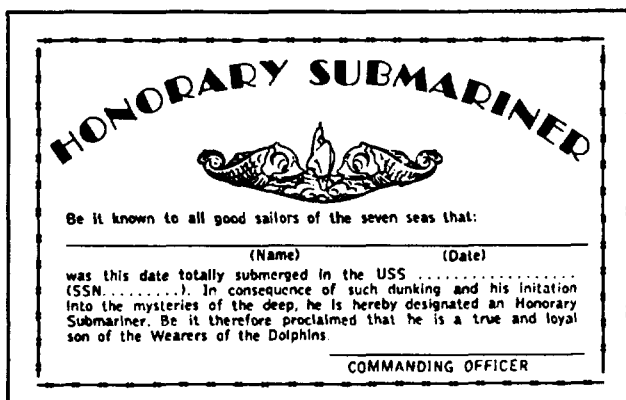

Figure 5-3.—Wallet-sized souvenir cards.

CHAPTER 6

SPEECHES

Americans must be aware of the Navy's role in national defense, forward presence, aiding allies and protecting national interests. Logistically, however, it is not possible for most Americans to observe the Navy in action at sea firsthand.

The Navy can clearly and convincingly communicate to the American people its important role by getting Navy people to tell the Navy's story at the grass roots level. Speeches are an easy, inexpensive way to do this.

From the Navy's point of view, a speech is made only for the purpose of transiting a Navy message effectively to the largest number of influential people in the community. The impact of a good speech has far-reaching significance, primarily because the audience will not only discuss the speech among themselves, but pass the message to colleagues, friends, family members and other contacts—virtually ensuring continuous circulation.

Every time a Navy representative talks to an American Legion post or a chapter of the Jaycees, he carries a message—the Navy's story. For 10, 15 or 20 minutes, he has the audience's undivided attention. When a speaker delivers a good speech, he makes a worthwhile impression upon the audience which causes it to act upon the message received. Even with relatively small groups, personal presentation of the Navy's case is still the most effective means of gaining community cooperation.

As a senior journalist, your role is to communicate the Navy's story in one or all of four capacities: (1) as a ghost writer, (2) as the coordinator of a speaking engagement, (3) as the speaker on certain occasions and (4) as the organizer of a command speakers bureau.

SPEECH PREPARATION

Learning Objective: *Recognize the importance of effective speech planning and the steps in preparing a speech.*

Speech preparation or planning is defined as the process of planning a talk before, during and after the actual researching. These steps save speech planners,

writers and presenters much time and anxiety in the preparation of oral and visual presentations.

The following are the four basic steps in planning an effective speech: (1) accepting the right speaking engagement, (2) choosing and researching your topic, (3) assessing the occasion and (4) assessing the location.

ACCEPTING THE RIGHT SPEAKING ENGAGEMENT

The DoD encourages Navy military and civilian personnel to serve as speakers in both public and private forums. These forums are considered appropriate when the following conditions exist:

- The views expressed are according to national policy.
- The topics discussed are within the cognizance of the DoD.
- Participation does not interfere with assigned duties of personnel.
- The speaking engagement would not take on the appearance of a conflict of interest, commercial endorsement or benefit, and so forth.

There are unsuitable speaking forums to avoid, such as addressing a partisan political group or any organization that could be considered extremist. DoD policy prohibits Navy speakers from appearing at an event where the attendance is barred to anyone because of race, creed, color or national origin or if the group sponsoring the event is discriminatory in a similar fashion.

Speaking at fund-raising events is also prohibited, except for certain designated causes, such as the Combined Federal Campaign, USO and Navy Relief. For further guidance, consult *PA Regs*, Chapter 3.

CHOOSING AND RESEARCHING YOUR TOPIC

The speech topic you choose should reflect your command's direct area of responsibility and be of significance to the audience. Thorough research

prepares the speaker to answer an occasional critical question.

When you research your topic, keep in mind that all speeches must receive, at minimum, a command security and policy review. The review procedures will vary from command to command and normally involve a “chop” of the text by the PAO, XO and CO. Speeches made by senior Navy officials must receive a security and policy review by the ASD(PA).

ASSESSING THE OCCASION

You should thoroughly check the physical setup in which the speech will be delivered. What is the reason for the talk? Is it a commemoration of a national holiday? Can you use a pertinent opening to take advantage of a specific event? Who will speak before your presentation is scheduled? Will the talk be delivered before or after a meal? Answers to these questions can greatly influence audience interest in a speech and should not be taken lightly.

ASSESSING THE LOCATION

A final speech preparation step is thoroughly checking the physical setup in which the speech will be delivered. Will a public address system be necessary? Is there ample lighting? Are there facilities for visual aids? Are there enough seats? Solving such potential problems is a vital part of preparing for a successful speech.

SPEECH CLASSIFICATIONS

Learning Objective: *Differentiate between each speech classification.*

Each time a speaker faces a group of people, he must have a purpose in mind. This purpose is directly related to the response the speaker wants from his audience. Speeches are classified into several different types according to their general purposes and the desired audience response. The different types of speeches are discussed in the following text.

SPEECHES TO SECURE GOODWILL

The goodwill speech is the backbone of public affairs work and it is a valuable tool for gaining public support. The opportunity to present a goodwill speech

usually occurs when a club or group asks a Navy representative to tell them about the command or its activities. Many goodwill speeches are made in foreign as well as stateside ports of call by senior officers.

The following are the three basic approaches used to develop a goodwill speech: (1) historic, (2) organization and operation and (3) service to the community. These approaches are discussed in the following text. Also, a list of development suggestions for these approaches is presented.

Historic

A goodwill speech highlights significant events in your command's history. These may include humanitarian accomplishments (various military work in disaster relief), examples illustrating the reliability of the command (how it responded to a call during war) or incidents stressing the importance of the unit to the community, such as historical events that illustrate how the command has played an important role in the growth of the community.

Organization and Operation

The speaker may explain the mission, organization or operations of your command. In this case, you may want to emphasize, without being obvious, how you do your job. You can do this by stressing the size of the organization, the magnitude of the job, the effort required and the efficiency of the organization in performing its tasks. Procedures or methods borrowed from civilian industry should be noted and credited. Techniques used by your command that audience members might apply in their own business activities should also be singled out.

Service to the Community

You may also develop the goodwill speech to emphasize exactly what your unit or activity does for the community. You may choose to emphasize how your unit protects the community's property and way of life. While emphasis on the part your unit plays in national defense can be effective, it is usually better to relate directly to the needs of the local audience.

Goodwill Speech Suggestions

When you develop any of these approaches or help a member of your speakers bureau prepare a

presentation, the following six tips will help you improve the goodwill speech:

1. Present new information. Your audience, especially in areas where military installations have existed for some time, may be familiar with general information concerning your command. Develop material that has inherent interest; make your audience feel they are getting firsthand information.

2. Show the relationship between your command and the audience. To achieve strong audience interest, you must try to relate the goals, aspirations and objectives of your command to those of your audience. Seek to illustrate that what your command does is important to the lives of the individuals in your audience.

3. Avoid definite requests for approval. You must remember your objective is to “soft sell” the command. You should avoid appearing as a “barnstorming” salesman trying to pressure your audience into appreciating your command. The approval you seek must come from the audience’s recognition of the value of your command based on the material you present.

4. Offer some type of service. Whenever possible, try to offer a service to your audience as a means of reinforcing the bonds between your command and the civilian community. Types of services you might offer include the following:

- Visits to the command
- Informal brochures
- Offers to join in a civic campaign or endeavor
- Offers to provide additional speakers for future programs

5. Be informal and sincere. In presenting a goodwill speech, the speaker must project sincerity and enthusiasm while displaying modesty and tolerance. He must avoid giving the impression that he is preaching or lecturing to the audience. The speaker must seek to establish a slightly informal air without suggesting a disorganized presentation. He should always use an extemporaneous delivery in the goodwill speech, since this type of delivery permits the speaker to establish the best rapport. The extemporaneous delivery method will be explained later in this chapter.

6. Reinforce goodwill. Very frequently, a speaker will be invited to follow his presentation with a question and answer period or a social hour. It is important in these after-speech contacts that the speaker reinforces

the goodwill he has developed by continuing to display good humor, tolerance, sincerity, controlled enthusiasm and modesty.

SPEECHES TO STIMULATE

When a speech is given to stimulate, you want your audience to be inspired to the point of enthusiasm, or to feel awe, respect or devotion. Speeches commemorating events, such as Independence Day, Memorial Day or Armed Forces Day, usually have stimulation as their general purpose.

SPEECHES TO CONVINC

When the general purpose of a talk is to convince, you attempt to influence the beliefs or intellectual attitudes of your audience with evidence. Political speakers urge belief in their party’s policies, philosophers attempt to convince people of the validity of their ideas and advertisers strive to convince their listeners of the superiority of certain products.

SPEECHES TO ACTUATE

The purpose of a talk designed to actuate is to solicit some definite, observable action by your audience at a specific time. The fine line between a talk to convince and a talk to actuate stems from the fact that the talk to convince only attempts to change the mental processes of the audience, while the talk to actuate requires some definite action above these mental processes. A politician who asks you to go out and vote “yes” or “no” on a certain issue is an example of a speaker who is speaking to actuate. Navy recruiters, for example, attempt to actuate people to join the Navy.

SPEECHES TO ENTERTAIN

A speech to entertain merely requires that the audience enjoy themselves. The purpose most after-dinner speakers have is to entertain with the use of colorful and interesting anecdotes.

SPEECHES TO INFORM

The object of a talk designated to inform is to teach and provide your audience with an understanding of your subject by increasing or widening their knowledge of the subject. Teachers lecture primarily to inform, plant supervisors show their workers how a certain piece of equipment operates by informing, and, most important to you, officers in command keep their men

and women up-to-date on the latest command evolutions, events and policy changes by informing.

SPEECHES TO INTRODUCE

There are many occasions that will require you to introduce a speaker, such as the following: guest speakers at command briefings, training sessions, news conferences or briefings and public meetings. In addition, you will often have to write a speech of introduction to be given by another person. It is always wise for you to anticipate the need to prepare an introduction as an aid to the program chairman, to introduce your officer in command, or some other naval representative at public speaking engagements.

Your main objective is to stimulate the listeners' desire to hear the speaker; everything else is subordinated to this aim. The duty of the person who introduces the speaker is to introduce, not to make the presentation or air his views on the subject. He is only the foregoing agent for the speaker whose job is to sell the speaker to the audience.

SPEECH DELIVERY METHODS

Learning Objective: *Identify the various speech delivery methods.*

Now that you have studied the speech preparation steps and the various classifications of speeches, it is time to select a speech delivery method. Why decide this first? Simply because the degree and type of preparation vary with each different method of delivery. Four principal methods of presenting a speech are as follows:

- Impromptu
- Memorization
- Manuscript
- Extemporaneous

IMPROMPTU

The impromptu method is completely unplanned. You are at a meeting of the Second Class Petty Officers Association Advisory Board and someone says something with which you disagree. So you get up and make an impromptu speech. Perhaps you are on leave in your hometown and stop by to see your former high school principal. He invites you to tell the senior class a little bit about your Navy travels and experiences, and thus you deliver an impromptu speech.

Unless you are one of those rare people who can talk on any subject at any time, impromptu speaking will probably be difficult for you. You may find yourself nervous, tongue-tied and unable to think of anything to say, much less express yourself clearly. This is a perfectly normal reaction to an unfamiliar situation, and it should not disturb you. The nervousness generated in this setting is both physical and psychological, and you should attack it on both levels. The following sections address these concerns.

Physical Considerations

On the physical level, start by making yourself comfortable. Stand naturally on both feet with your knees relaxed and take several deep breaths. Regulate your breathing and talk slowly so that you never run out of air. As you get into the subject, you will begin to feel better, and the pounding in your chest and wobbling about the knees—neither of which is apparent to your audience no matter how obvious they may be to you—will gradually subside. At the end of three minutes, you probably will not notice these symptoms any more.

Psychological Considerations

Psychologically you should realize that your fear is most likely based on the unfamiliarity of the situation, and not the fact that you have to talk. Obviously, you know something about the subject (probably more than anybody else in the room does), or you would not have been asked to speak in the first place. You could say the same thing to three sailors on the mess decks with no strain. It is really the situation, not the task at hand, that has got you nervous.

Situational Concerns

It is a pretty safe inference that the audience is reasonably well disposed to you personally and to what you are about to say. If they were not, you would not have been invited to speak. You can remember that your nervousness is NEVER as apparent to the audience as it is to you. If you have ever detected that a speaker felt bad, rest assured that he really felt a lot worse.

Additionally, the reaction of an audience toward a nervous speaker is rarely ever contempt. They almost always feel sympathetic toward the speaker. So tell yourself that you know considerably more about the subject than anybody else there, that the audience is friendly, and that all you are doing is talking to them—and you talk to people every day without getting nervous.

You will be surprised how much this approach will do for your self-confidence.

Impromptu speeches are not completely without preparation. When you are in a situation where you might be called on to speak, it is a good idea to think over what you might say if you were called on. Nevertheless, even when you have not done this, you always have a minute or so between the moment you learn you are to be called on and the time you have to start talking. Use this time to pin down the major points to get across. Why are you talking? What is the objective you want to accomplish? If you could say one sentence, what would it be?

Try to form a mental outline of four or five points supporting your main theme, plus an opening sentence. If you have time, decide exactly where you want to end. If you do this, you will make the best of the most difficult of all speaking situations.

MEMORIZATION

Memorizing a talk word for word is at the opposite extreme of the impromptu method. Some speakers can use this method effectively, but too often it results in a stilted, inflexible presentation, simply because the speaker is more concerned with his material than he is with his audience.

Unless you are an experienced actor, memorization is absolutely the worst way to present a speech. When you memorize, usually you are committing **words and sentences** to memory rather than a **sequence of ideas**. The result is scanned routine that would not sell vacuum cleaners, much less the Navy. It is an expressionless, boring presentation that leaves your audience in doubt as to your sincerity and even your knowledge of the subject.

Another major weakness of this approach is the fact that if you forget a word or a sentence, you may omit important portions of your talk without knowing it, or even worse, find that you do not know where you are, what you have said, or what comes next. In recovering you may omit or even repeat parts of the talk.

MANUSCRIPT

A great many Navy speakers read speeches that have been written out word for word. This manuscript method is almost as inflexible as memorization. Again, it sets up a barrier between the speaker and his audience because the speaker must pay close attention to what he is reading and cannot react to the responses of the

audience. Occasionally, talks are read effectively when the speaker is particularly gifted and practiced at reading, but for the most part, the manuscript method should be left to special circumstances, such as the following:

- When the verbatim text has been or will be released to the news media and it is probable that the speaker will be quoted extensively.
- When the subject matter involves security or policy considerations so sensitive that the exact wording is essential.
- When the talk is being broadcast and timing is critical.

A speaker must have a lot of experience and usually a bit of training to read a speech effectively, since a speech is read effectively only when it sounds as though it were not being read. This method is not recommended for your own use; and if you are called onto help any officer or petty officer prepare a speech, you should do what you can to discourage him from reading from a completely prepared text.

EXTEMPORANEOUS

The extemporaneous method is usually used by most good speakers. To a speechwriting newcomer, “extemporaneous” sounds synonymous with “impromptu” or “extempore,” but in the language of public speakers, it means something quite different.

The delivery seems to be off the cuff, while actually the material has been well prepared and rehearsed. An extemporaneous delivery is a happy medium between the overly casual impromptu and the stiff memorization or manuscript. The talk is very carefully planned and outlined in detail. Sometimes a complete draft of it is written out, but this draft is only used in rehearsal. The talk is delivered from an outline with the speaker memorizing the sequences on the outline, but never the exact wording.

What makes the extemporaneous method so effective is that it borrows the good qualities from the other three methods of speaking without incorporating their bad qualities. A thorough and careful use of the extemporaneous method results in a talk as polished as a memorized one, and certainly more vigorous, flexible and spontaneous.

There are other advantages of the extemporaneous method. With an outline, you can adapt your talk to the situation, spending more time than originally planned

I. INTRODUCTION

- A. Attention Step (method used in gaining initial attention)
- B. Limited Objective (statement of exactly what you are to talk about)
- C. Motivation
 - 1. Appeal (statement of how the audience will benefit)
 - 2. Support (an example making the appeal sound realistic)

II. EXPLANATION

- A. First Main Point (sentence of fact or idea to be covered)
 - 1. Support (fact, example, analogy, etc., clarifying first point)
 - 2. support
 - 3. support
- B. Second Main Point (sentence of fact or idea to be covered)
 - 1. Support (fact, example, analogy, etc., clarifying first point)
 - 2. support
 - 3. support

III. SUMMARY

- A. Recap the Main Points (restatement of what you have said)
- B. Reemphasize motivation (why the audience should remember what you said)
- C. Forceful Conclusion (method used in ending the talk)

Figure 6-1.—Key word outline.

on points that seem to need more explanation or emphasis and shortening or even skipping some areas entirely. This is next to impossible with several pages of fully worded text.

Also, the outline takes up less space than a full text. The outline of a five-page speech might fit on one or two 5-by 7-inch index cards, or at the most, one typewritten page. The fewer pages you have to rustle around the lectern, the better off you are (particularly if there is not a lectern).

Remember that speaking extemporaneously requires the speaker to memorize the sequences in his talk, but not the exact words. The easiest method of doing this is by preparing and using a key word outline. This outline is a skeleton of the talk, a sort of structural blueprint from which you speak. You condense what you intend to say into “key words” that serve to remind you

of your ideas and the order in which to present them. Regardless of where you speak, the key word outline is an invaluable friend when it is used properly. A diagram of this outline appears in figure 6-1.

The “explanation” (Part II of the outline) is geared for a talk with two main points. If you had three main points, “C” would appear after “B.” If you had only one main point, you would not need A or B because the main point would follow directly after “explanation.” The remainder of this section will concentrate on developing the key word outline. Explanations and examples will be given on all three major steps: the introduction, the explanation and the summary. Also, the number of supports under any main point is flexible, depending upon the main point and the supporting material available.

SPEECH INTRODUCTION

Learning Objective: *Recognize the elements specific to the introductory part of a speech.*

An effective speech introduction should arouse the interest of the audience (attention step), summarize in one simple sentence what will be covered in the talk (limited objective) and give the audience a good reason to listen to that limited objective (motivation). Strive to keep this part of the talk short, meaningful and interesting.

ATTENTION STEP

The speaker who believes that he will not have difficulties maintaining the audience's interest is relying on the hope that he is a novelty and that people are breathlessly awaiting his words. It is true that, for the first few seconds, the speaker is a novelty, and the audience will be interested in looking him over. However, it is the next few seconds that count, since within this time the first words are spoken and they must really capture the audience's attention. The two criteria for selecting material for your attention step are as follows:

- Make sure your attention step is directly related to your subject.
- Make sure your attention step is not so bizarre that it detracts from the rest of your talk.

Outside of these considerations, the only limiting factor for an attention step is the imagination of the speaker. The following techniques should give you an idea of the many ways to begin a talk.

Interesting Illustration

Actual incidents from real life, stories from literature and hypothetical illustrations may be used as attention steps. When used effectively, the story opening has great appeal and is almost guaranteed to arouse and maintain the audience's attention. For example:

"During the Second World War, Fleet Admiral Ernest J. King was asked by a group of newsmen just what the U.S. Navy's public relations policy was. Admiral King replied: 'Do not tell them anything. When it is over, tell them who won.' (He had a point and I wonder what Ernie King would say had he heard Secretary _____ this morning. I am sure many of us might sigh with relief if this policy were current. But as you know it is not. Even

in the framework of war, such a negative policy is not in tune with today's climate. . . .)"

Quotation

A quotation that leads directly to the subject frequently can establish immediate attention. An excerpt from a speech made by Rear Adm. Brent Baker, the former Chief of Information, is used here as an example:

"Recently, I received and read the 1990 Navy women's study group report. Rear Admiral Bobby Hazard, in her forwarding letter to me, said: 'I hope this report will enable greater understanding of the perceptions of Navy women and men and stimulate even more specific actions to improve the assimilation of women at every level of commands.' (Let me underscore the word *perceptions*, because the world of public opinion or perceptions is one I work for every day. . . .)"

Humor

All of us like to laugh at a colorful anecdote. If you can relate a humorous story, do so, but make sure you choose it wisely for its relation to the presentation. A funny story may be hilarious in itself; but unless it focuses attention on the subject, it is of little value. Make your humor relate to your subject. For example:

"The title of this speech, 'Public Affairs and Command,' reminds me of what happened to a rear admiral years ago when his flag was aboard the USS *Long Beach*, which was finishing a tour on-the-line off Vietnam. *Long Beach* was ordered to Sydney, Australia, for four days of R&R. You may recall the incident as *Long Beach* was about to depart Sydney, when a good-looking blonde got aboard, spent the night and apparently was about to stowaway when she was discovered hiding under a bunk in the admiral's quarters. This incident made headlines in Australia. And the next day, a similar story made the front pages of the Los Angeles newspapers with the caption reading: 'BLONDE FOUND UNDER ADMIRAL'S BED ABOARD USS *LONG BEACH*.' Since the admiral's family lived in nearby Long Beach, he tells me the event caused quite an eye-opener that morning at his house. Especially since his wife and daughters did not know the admiral had unexpectedly transferred his flag from *Long Beach* before its arrival in Australia. Imagine being suspect of such a happening and receiving no benefit because one was not even there. He has since told me, 'I am not sure whether I was lucky on that

one or not.' (I guess the moral of the story is: 'Keep a sharp watch on your public affairs!' Shifting now to public affairs activities. . . .)

Here is one other important guideline regarding humor: If you cannot tell an anecdote in mixed company, do not tell it at all.

Rhetorical Questions

A rhetorical question is one that does not require a verbal response from the audience. It is asked merely to get the audience to think. This method, when properly used, should make your audience want to hear the answers to these questions. For greatest effect, rhetorical questions should be used in groups of three or more. For example:

"How many of you here today truly understand the meaning of the term *sea power*?"

"How many of you are familiar with the tremendous role that the sea has played in our nation's growth and development?"

"How important is sea power to us in the 1990s?"

"(Never in our history has sea power been so vital to our security as it is today, This importance will increase and the term sea power will take on new meanings. . . .)"

Striking Facts or Statistics

Using a startling fact or statistic is a good way to "jar" your audience into wanting to hear you clarify it. The unexpected always arouses attention. For example:

"Four hundred and fifty aircraft from six carriers churned out 140 sorties of combat capability each day during DESERT STORM, one-third of all the air missions flown during the war. Add to that more than 280 precision Tomahawk cruise missile launches and you just begin to see the complexity of applying Navy-Marine Corps air power in DESERT STORM. Combine that with Air Force and allied air, and you have 3,000 pounds of bombs falling on the enemy every minute through the 42-day war. Now, that will rattle any army. (What about the Iraqi army? What was the war like from its perspective? Tonight we will take a look at the Iraqi army during DESERT STORM—specifically, the many logistical problems they encountered.)"

Visual Device

A visual aid that arouses curiosity and is colorful and interesting can be another effective way to open a talk. For example:

The speaker places an alarm clock on the lectern. It quickly goes off. Shutting it off, the speaker states, "Now is the time to do something about pollution. (The threat to our natural environment is growing every day. It is about time we woke up to this fact and started taking a few corrective measures. For the next few minutes, I would like to discuss certain aspects of environmental pollution in the United States. . . .)"

The following is another example of relating a visual device to a more abstract and complex organization:

The speaker holds up a bottle of pills and says, "I have in my hand a bottle of pills. They are aspirin for headaches, ibuprofen for inflammation and assorted aches and pains and various other kinds of pain relievers. However, they all have one thing in common: regardless of the claims, they are all designed to relieve pain. (I would like to speak to you for a few minutes about another pain reliever, WHO, the World Health Organization, a specialty agency of the United Nations. Specifically, I will explain how two functions of WHO, fieldwork and technical assistance, contribute to the cause of worldwide health.)"

Remember, the first portion of the introduction is the attention step. It should be related to the subject and should be geared to arouse audience interest. When condensing the above attention step concerning the United Nations into "key words," the attention steps would appear on your key word outline described in figure 6-1 as follows:

For the subject: THE UNITED NATIONS

A. Attention Step-analogy-pills and WHO-both cure pain.

LIMITED OBJECTIVE

Since the attention step is the first part of the introduction, the limited objective is usually determined before any work is started on your keyword outline. The reason is that the limited objective is, very simply, a one sentence statement of what you are going to cover in your presentation. Before you can come up with an attention step that leads into the limited objective, you

have to determine just what the limited objective will be.

One of the keys to success in any talk is knowing exactly what you are going to cover in the time allotted. Notice that after the preceding examples of attention steps there appeared in parentheses a transition and a statement of exactly what the speaker was going to cover. These sentences are the result of a broad, general subject, such as “The North Atlantic Treaty Organization (NATO)” being cut to a specific portion of that subject. Moving from the general subject to a limited portion of it is called “limiting the objective.”

Since most subjects are much too broad to be covered completely in the time allocated, let us take a broad subject, NATO, and see how you, the speaker or speech writer, can select a limited objective from it.

One of the easiest ways for you to start is to conduct a question and answer period with yourself. The major consideration in cutting the subject is the time you have in which to speak. For example, if you had only 10 minutes to talk about some aspect of NATO, the cutting process might look like this:

- Can I tell everything about NATO in 10 minutes? Of course not. It will have to be cut down.
- How about explaining the organizations of NATO: the civil organizations and the military organization with its four major commands? Too broad—more cutting needed.
- How about one, two or three things about each various organization within NATO? The one, two or three idea is fine, but I cannot adequately cover one, two or three areas of each and every organization in just 10 minutes.
- How about briefly tracing the history and overall mission of NATO, and then explain the importance of just one command within NATO's military structure? Process completed.

Remember, the second part of an introduction is called the limited objective. It is simply a one-sentence statement of what you are going to talk about in the time allotted. When condensing the above limited objective concerning NATO into key words, it might appear on your key word outline described in figure 6-1 as follows:

For the subject: THE NORTH ATLANTIC TREATY ORGANIZATION

B. Limited Objective—NATO's history or mission and importance of Allied Command Atlantic.

MOTIVATION

A fine imaginative attention step is a sure way to begin your talk. Follow this with a simple statement of what you are going to cover by stating your limited objective, and the audience becomes aware of what you are going to say. If you proceed directly to the explanation or body of your talk, you stand a good chance of losing the attention of half the group. Why? Because, in most cases, that audience does not care about what your limited objective might be. If you assume they will be polite and listen to you, you are undoubtedly ignoring the many times you have “tuned a speaker out” because you did not think what he would say would benefit you.

To prevent this, it is necessary to make sure that your objective appeals to your audience. Therefore, the third portion of an introduction is called motivation and is simply calculated to show your audience how they will benefit should they spend the next 10 minutes listening to you talk about your limited objective.

Very few individuals are moved to action without first being motivated to some extent. The wish to impress someone important to you motivates you to be sure you look your best when meeting that person; the desire to qualify for advancement is motivating you at this moment to read this sentence. Advertisers use the process of “motivating” continuously, and whether you buy one product or another usually depends upon the skill of the advertiser in convincing you that his product is more suitable **for you**.

Those last two words, “for you,” are essential. The underlying theory behind all these examples is the same: “Take this action or buy this product and you will be better off.” Getting that audience to sit up and say, “That is for me!” will result in an attentive group throughout your talk. There are many different and varied approaches for motivating audiences. For example, you might appeal to the audience's pride, loyalty, fear, acquisition and independence.

How do you know what will get your particular audience to listen? How do you know what appeal to use? For the answer to these questions, you will have to analyze your audience (explained later). With the aid of this information, you should be able to predict some general similarities in your audience. Use these similarities for your appeal.

Once you make the initial appeal, it is necessary for you to include an example of that appeal to add reality. Simply saying, “Listen to me talk because what I have

to say will save your lives," is only a good start. To make that statement convincing, follow it with an example that ensures that what you have to say really might save the lives of those in the audience.

Remember, the third and last portion of the introduction is called motivation. It contains two parts. First, an appeal to show the audience how it will benefit from listening, and second, an example adding color, reality and personalization to the appeal.

SPEECH EXPLANATION

Learning Objective: *Recognize the elements specific to the explanation part of a speech.*

The speech explanation is the major part of any speech. It is often referred to as the body." The three major portions that make up any successful explanation are the main points, supporting material and phrasing.

MAIN POINTS

A main point is a concise, one-sentence statement of a fact or idea that you want your audience to remember. The main points in your talk should be expressed clearly and emphatically. Two ways to select main points are by means of self interview and by audience analysis, a discussion of which follows.

Self Interview

The purpose of the self interview is to find out all you know about your limited objective before doing any formal research. If your limited objective is "The Importance of the Allied Command Atlantic," jot down all you know concerning this subject. The more you know about your limited objective, the less you will have to research later.

Audience

The second way to select main points is to estimate what your audience might want to know concerning your limited objective. Many times the limited objective you have chosen will be completely foreign to you and the self interview will be fruitless. If this is the case,

simply choose tentative main points based on what you think your audience might want to know about your limited objective. For this, consult your audience analysis.

From these two lists—first, what you know about your limited objective, and second, what your audience might want to know about your limited objective—select one, two, or three areas that you feel you can cover adequately in the time allotted. When you have made this selection, condense the ideas into simple sentences without losing the meaning of the points. This will make them easier to remember when you present them.

Now that you have decided on your limited area and the number of main points, you must consider the most effective way to handle the main points. How, in a single sentence, is it possible to tell your audience exactly what you are going to talk about? There are four possible approaches in wording your limited objective and main points: What, Why, How and How to.

THE "WHAT" APPROACH.— Your purpose is to **identify**. What you identify can be a term, method, type, place, person and so forth. In any case, your aim is to tell what something is, and no more. You are dealing with facts. You must support these facts using material that is meaningful and interesting. Analogies explaining the unknown by comparing it to the known are particularly effective when using the "What" approach, as in the following example:

"Today I would like to **identify** the three main buildings of the United Nations."

1st Main Point —One main building of the United Nations is the Assembly Building.

2nd Main Point —Another main building of the United Nations is the Secretariat Building.

3rd Main Point —The third main building of the United Nations is the Conference Building.

THE "WHY" APPROACH.— Your purpose is to state the characteristics or qualities of your objective, and then, as main points, tell why the characteristic or quality is true. To do this, state your limited objective and main points in simple, declarative sentences. Note the following example:

“Today I will discuss two reasons **why** the Navy of the future will need a force of 450 active and reserve ships.”

1st Main Point –We have the responsibility to retain the military strength necessary for guaranteeing our nation’s security.

2nd Main Point –We must help solve the domestic financial problem by maintaining only those forces essential to our national security goals.

THE “HOW” APPROACH.— Your purpose is to explain how something works, is to be done, can be avoided, improves a situation, and so forth. To do this, state in your limited objective what your main points concern and how they will accomplish something. Then state each main point in a simple, declarative sentence that will specifically explain the “how,” as in the following example:

“Today I will discuss **how** NATO stopped Communist aggression in the North Atlantic area.”

1st Main Point –Since its formation, not one square foot of NATO territory fell to communism.

2nd Main Point –The member nations, by heritage, by economic necessity, by common interests and principles, have formed a closely knit, interdependent union for mutual defense.

THE “HOW TO” APPROACH.— Your purpose is to tell your audience actually **how** to do something. If you do not have time to explain a complete process, then tell as much of the “how to” as time permits. (For example, talk only of the first step of a five-step process.) Phrase your limited objective so that you state what it is you want your audience to know how to do. Your main points will be statements of the steps involved such as in the following example:

“Let us discuss the first two steps in obtaining (**how** to obtain) an absentee ballot.”

1st Main Point –The first step in obtaining an absentee ballot is to see your voting officer.

2nd Main Point –The second step in obtaining an absentee ballot is to write to your election district for an application form.

PHRASING

You probably noted a distinct pattern in the phrasing of the main points. Good speakers go to great lengths to phrase their main points in such a way that the meaning will be clear and easily remembered by the audience. To achieve this result, you should keep in mind the following three characteristics of good phrasing:

- Conciseness
- Motivation
- Parallelism

Conciseness

State your points as briefly as possible without sacrificing meaning. A simple declarative sentence is better than a complex one. Therefore, “Marksmanship develops your reflex instinct” is better than “One of the ways through which your marksmanship can be improved is the use of correct techniques to better reflex your instincts.”

Motivation

Whenever possible, word your main points to appeal to the interests and desires of the audience. True, in the introduction, you may include an entire step devoted to motivating the audience to listen, but the more personal the entire talk, the more interesting it will be. The more the words “you” and “your” can be used, the more personal the main point will be.

Parallelism

Try to use the same sentence structure and similar phrasing for each of your main points. Wherever possible, start each main point with the same phrase. Word a series of main points like this:

1. Nuclear-powered ships we more flexible than conventional ones.
2. Nuclear-powered ships have a longer cruising range than conventional ones.
3. Nuclear-powered ships require less engineering personnel than conventional ones.

SUPPORTING MATERIAL

Supporting material will constitute the bulk of your talk. Any means a speaker uses to clarify and to make his main points meaningful make up the supporting material. Supporting material should accomplish the following in developing main points:

- Clarify—Clear up doubts; eliminate confusion.
- Amplify—Expand, develop a complete discussion; include all essential elements.
- Verify—Give factual support to prove contentions; provide evidence for statements.
- Emphasize—Make prominent; underscore.

There are many types of supporting material, some of which are discussed below.

Personal Experiences

Your experiences, past and present, are an excellent source of supporting material. Relating actual experiences that you may have had concerning the main point will often result in a sharp increase in interest. A word of caution: Too many personal experiences in one presentation may make you sound self-centered. Do not overuse this type of supporting material to build yourself up or to avoid research. Also, avoid using naval jargon, especially Navy acronyms. It is a surefire way to lose an audience in a hurry.

Illustrations

Illustrations are detailed stories of examples of the idea to be supported. Illustrations are either factual or hypothetical. Factual illustrations relate what actually happened; they describe a situation that has actually occurred. Hypothetical illustrations tell what could have happened or probably will happen; they describe a situation that only has the appearance of an actual situation. Factual illustrations can carry conviction, whereas hypothetical illustrations are used principally to make abstractions more vivid and concrete.

Factual Examples

Factual examples are usually from qualified sources found in libraries. They give added weight to the main point they are supporting.

Analogies

In an analogy, similarities are pointed out between that which is already known or believed by the audience, and that which is not. In a talk to inform, this is probably the most effective way to get your audience to remember the main point in question.

Other Supporting Materials

The previous sections highlighted the three most common and effective forms of supporting materials. Other excellent supporting materials include the experiences of others, anecdotes, testimony, quotations and current news events.

Again, keep in mind, the explanation of your talk consists of two parts-main points and supporting material. The main points are concise, one-sentence statements of facts or ideas that you want your audience to remember. Supporting material is any means you use to clarify, amplify, verify or emphasize the main points.

SPEECH SUMMARY

Learning Objective: *Recognize the elements specific to the summary part of a speech.*

Just as the introduction consisted of three parts, so does the summary. The three segments of the summary are as follows:

- Recap the main points
- Re-emphasize motivation
- Present a forceful conclusion

RECAP THE MAIN POINTS

To make sure your audience remembers your first, second and third main points, it is always wise to repeat them. A summary should be brief, but accurate. Note the following example:

“Well, I have been talking for 20 minutes and in this time I have said three things: (1) Preserving our environment is a priority issue for the American people and for the American sailor; (2) The U.S. Navy is committed to operating its ships and shore facilities in a manner compatible with environmental goals; (3) We are obligated—and dedicated—to help our commands at sea and ashore around the globe continue these efforts, large and small, to preserve the environment for our own well-being and for future generations.”

RE-EMPHASIZE MOTIVATION

Again, to reassure the audience that what they now know will benefit them in some way, it is necessary to remind them of how they will benefit if they remember what you have said. Consider the following example:

‘You now have a working knowledge of two combat developments in marksmanship. If you ever come to grips with the enemy, what you have learned in the past 20 minutes could mean the difference between life and death.’

FORCEFUL CONCLUSION

The forceful conclusion is the end of your talk and should be as dramatic and interesting as the attention step. A weak ending diminishes the effect of the points. The statement, ‘Well, I guess I am done’ or ‘That is all I have now’ greatly reduces the impact of any presentation. The same techniques that were suggested to open a talk can be used to close one.

Illustrations, quotations, jokes and questions are all good ways of closing a talk. A strong, positive statement is one of the best. Nobody seems to have improved on ‘I know not what course others may take, but as for me, give me liberty or give me death.’ One thing is vital, however. Your closing should tie the entire talk together in one cohesive unit.

SPEECH WRITING

Learning Objective: *Recognize the basic speech writing techniques.*

The public affairs office is usually the public speech writing department for the officer in command. As the senior journalist in this public affairs position, you may be the speech writer for the command. At the very least, you can expect to be called on some time during your career to write an occasional speech for the skipper and perhaps for other senior members of his staff. If your command is large enough to have a formal speakers bureau in operation (discussed later in this chapter), you will be required to maintain several ‘canned’ speeches and slide presentations for various occasions.

Speaking engagements in nearby communities are an integral part of the public affairs plan for gaining public support and understanding. Opportunities to speak are being sought more and more by all commands within the Navy. Therefore, the skipper and the PAO

will expect you to assist them in researching and preparing, or in writing, the manuscripts of talks given by them or a representative of the command.

This job rests with the public affairs office not only because the officer in command does not have the time to prepare a different speech for each occasion but also because your office should be in an excellent position to (1) assess an audience’s needs, desires and interests in asking for a speaker; and (2) determine the gaps in public understanding concerning activities, policies and missions of your organization or installation.

The following is a list of the advantages of a written speech:

- It provides an opportunity for the writer to revise, edit and polish the speech until it is literally a gem.
- It can be submitted for clearance and checked closely for security or policy violations.
- It reduces the possibility of a serious misquotation on critical matters.
- It assures the speaker of meeting the time limitations on radio, television or at a civic club function.
- It allows the dissemination of an advance release to assure more complete and accurate coverage.

AUDIENCE ANALYSIS

An extemporaneous speaker can adjust his material as he is presenting it. The feedback he receives from his audience dictates certain changes and sometimes elaboration of a part or two.

However, the speech **writer** has no such opportunity. If he errs, even in the slightest detail in his analysis, the speaker has no other recourse but to wade through an ill-adapted manuscript. Therefore, prior analysis of the audience, situation and occasion takes on increased importance and must be considered in greater detail.

In analyzing the audience as to age, sex, background, size, socioeconomic status, and so forth, you should talk with members of the club or group as part of your research before you start to write the speech. If possible, attend one of their meetings. This will aid you in your analysis of the audience and enable you to examine the physical setting where your speaker will make his delivery. The size of the room, customary

seating arrangement and the facilities for using aids might present a problem or might need greater attention in some circumstances. The outline in figure 6-2 will prove helpful in analyzing an audience.

Sometimes the reason for an invitation to speak may not always be apparent on the surface. A commander of a fleet ballistic missile submarine squadron, who receives an invitation to speak to a chamber of commerce on future ASW applications, should not always jump to the conclusion that they are interested because the SUBRON itself is very shortly going to be homeported in their community. The audience may have read that this squadron of six or eight ships will soon be their neighbors, will be nuclear-powered, and will carry nuclear weapons. Their hidden motive for inviting him might conceivably be a fear of possible harm from the nuclear armament.

On the other hand, a request for a speaker may reflect the audience's desire to know the impact on the community of an incoming unit. The speech writer must know this and adapt his speech accordingly. He must supply the speaker with the necessary facts to answer the questions they might pose.

SPEAKER ANALYSIS

Previously, we have been concerned with adjustments to the audience, the situation and the occasion. As the speaker, it was necessary to analyze the audience you hoped to influence, to know their wants and to adapt your material to their needs. But now, as the speech writer for another speaker, you have an additional adjustment to make—the analysis of the speaker.

To write a speech for another person, you must put yourself in his place, understand his aims and try to think the way he does. In a manner of speaking, the idea is to get inside the person and learn what makes him tick. If you succeed, your words will sound natural coming from the man who delivers them. Make certain the speech reflects the speaker's personality.

As a beginning, get to know the man. Where has he been? What has he done? Check the personal history file and you will find some answers. Read his previous speeches and the comments on them to get his ideas and his use of words. Listen to him talk and know how he expresses himself. Pick up his pet phrases and anecdotes. Find out if there are some words or sounds he cannot pronounce easily. Develop a writing style and vocabulary suited to his speaking personality, verbal mannerisms and capability. If this is not possible, write the speech in a straight journalism style that will permit the speaker to personalize it himself.

PREPARATION STEPS

Let us assume your office receives a request for the CO (or his representative) to speak to a civic group. What do you do to assure a successful talk and to make it worth the time of the audience and the skipper? You should analyze, recommend, outline and polish the speech.

Analyze the Speech

Initially you must analyze your audience, occasion and location and determine the purpose best served in the talk. Asking and seeking to answer the following types of questions will aid you in this process:

1. Is it merely to inform?
2. Is it to convince (or to actuate) the audience?
3. Is it to secure their goodwill toward the command and its activities?
4. Is **any** Navy topic acceptable, or do they want something specific?
5. Is there anything that could offend them?
6. Will they be a friendly audience?

Consider the speaker and his relationship to members of the group, his prestige within the group and his previous contacts with them. Consider the aspect of the subject that would best suit the above factors.

Recommend the Speech

Now go in to see your commander (or the speaker) to determine his wishes and ideas for the particular speech. Be prepared to recommend a limited objective that most fits the requirements you determine from your analysis. If this objective is accepted, you should also prepare to discuss the tentative outline points to be covered. Be alert to references he makes to personal experiences, that may be used as examples.

If your speaker proposes a different topic, jot down the tentative outline points as you discuss them and check them with him before you leave. This one step will save considerable rewriting time.

Outline the Speech

At this point, prepare a complete, detailed outline of the entire speech, citing types of example material for each point to be made.

Plan the type of audiovisual aids to be used and indicate on the outline where they are to appear during

AUDIENCE AND OCCASION
Simplified Analysis Outline

1. Age range _____
2. Average age _____
3. Intelligence (average, above, below) _____
4. sex _____
5. Education _____
6. Occupations _____
7. Knowledge of topic _____
8. Knowledge of speaker _____
9. Attitude toward topic _____
10. Attitude toward speaker _____
11. Religious groups represented _____
12. Dominant interests _____
13. Economic level _____
14. Community urbanization _____
15. Community industrialization _____
16. Any unusual community project _____
17. Any unusual community event _____
18. Time of day of speech _____
19. Place of speech _____
20. Size of room _____
21. Probable size of audience _____
22. Type of decoration _____
23. Will audience sit close together? _____
24. Other _____
25. _____
26. _____

Figure 6-2.—Audience analysis outline.

the speech. Most large commands have access to a graphics or training aids section which can prepare almost any type of visual aid you may need, as long as you can supply them with a rough idea of what you want. Most speeches are supported or illustrated with overhead transparencies, 35mm color slides or video presentation.

Remember to discuss the entire outline with the speaker to be sure it is evolving as he visualized it.

Polish the Speech

You should start to **word** the speech only after the entire outline and plan for the presentation is agreed on.

Put yourself in the speaker's shoes and mentally place yourself in the physical setting before the specific audience as you write.

Check out the aids, preferably in the setting where the speech will be given. If requested, listen to your speaker rehearse the speech and suggest improvements.

If you are concerned about the length of the speech, keep in mind that the optimum speech length is 20 minutes. Figure on one minute per page of double-spaced text.

SPEECH WORDING

A speech is meant to be heard, not read. This means that you must write the speech in words that the speaker would use in conversation with a representative member of the group to which he is speaking. As a speech writer, your job will be easier if you imagine your speaker talking to this representative member and telling him the information he has planned to communicate (the points in the prepared outline).

Pick out a member of the group, imagine him sitting across the desk from you asking a question now and then, putting in an argument occasionally. Write your speech to him, interjecting questions and answering arguments in words that the speaker would really use in everyday conversation. Start the speech from the listener's point of view.

Use spoken, not written, language. Some words cannot be heard and understood as quickly as you say them. If the audience does not catch the meaning of a word, their minds are held up at a mental stoplight while the speaker goes on alone. Avoid pretentious language such as "fatuous" and "it behooves." Use the simplest words to help the audience to understand.

Use examples for every point, preferably the personal experiences of the speaker. Be sure the example really supports the point you are making. There is a surefire formula for getting the point across: (1) state

your point, (2) use an example and (3) restate your point. Check your script. Be sure that statements important to your objective do not stand nude, so to speak, without an example or a "for instance" to clothe them.

The following is a list of a variety of "talk traps" that you should avoid when wording a speech:

- Do not get crushed by the weight of your own over-detailed and over-illustrated speech.
- Beware of falling into the void between two points in a bad transition.
- Do not find yourself out on a limb with no place to go after a big introduction.
- Do not become the prisoner of too many main points.
- Do not get trapped in a jungle of abstractions.

DELIVERY TECHNIQUES

Perhaps the most common dilemma faced by every speaker is that of nervousness. However, what most speakers forget is that this condition can be positive as well as negative. Of course, should you lose consciousness upon reaching the podium, your nerves are working against you! On the other hand, if you feel anxious and "keyed up," your nerves are doing just what they are supposed to do. The race horse that is alert and spirited before a me is often the favorite; the one that is calm and somewhat sluggish is almost always counted on to lose.

The same applies to speaking. Nerves can be an asset to a speaker by mentally preparing him for his presentation. Only when extreme nervousness or extreme nonchalance exists does the speaker need to concern himself with the natural phenomenon of nervousness.

Nervousness is a natural and healthy thing. For most people, speaking before a group for the first time is not easy. By understanding the techniques necessary for building self-confidence, however, you will be well on your way to becoming a more effective speaker.

The first thing you must do is develop a positive attitude-convince yourself that you have the ability to improve. No one is a born speaker or instructor. Speaking well is a skill that is developed as a result of training and practice. Once you have convinced yourself you can improve, you are ready to begin.

The fastest method of developing self-confidence is to be thoroughly prepared. If you have carefully followed the steps in preparation described in this chapter, you should be confident that the material you have prepared is adapted to the needs and interests of your audience. You will have the points that you wish to make organized in

logical sequence, and you will be able to mull the key word outline from quick references to your notes. This is the most comforting feeling a speaker can have.

Once you are secure in your knowledge, you will almost want to get up and share it. This impulse to get your ideas across must be encouraged; you will find that it will increase your interest and fun in all speaking situations. Wanting to say something so that your audience gets the point is one of the impromptu secrets of delivery.

Because of the personality y differences of individual speakers and audiences, there are no ironclad rules or principles that can be given regarding the delivery of your speech. The interest and understanding demonstrated by an audience influences a speaker in both what he says and how he says it. Each speaker must adjust to suit his personality. Only general suggestions can be made at this point. What follows are some pointers that will enhance your knowledge of speech delivery techniques.

Speaker to Audience Contact

Look at your audience. Good eye contact lets you know the reaction (feedback) of the audience, and it

creates the impression that you are talking personally to each member of the audience.

Deliver your talk as if it were the most important event in your life. Make everyone within the audience understand exactly what you are trying to say. Talk to your listeners as if you expect them to stand up and talk right back to you. Vitality will produce effective delivery. There is nothing quite so dull as watching a speaker who is lethargic and seems to be on the border line of sleep while he is delivering his talk. It is much easier to deliver your points effectively if you are enthusiastically concerned in getting ideas across.

Establish a sense of communication with your audience. Think of the members of your audience, not yourself, as you talk to them. Make every effort to express yourself with enthusiasm. Sincerity and interest in your audience warms the reamer of delivery.

Lectern Appearance

When a speaker moves unnecessarily, it tends to divert the audience's attention. If the movement is natural and easy, it is valuable. Do not distract your audience by too much movement, but do not remain glued to one spot (fig. 6-3).

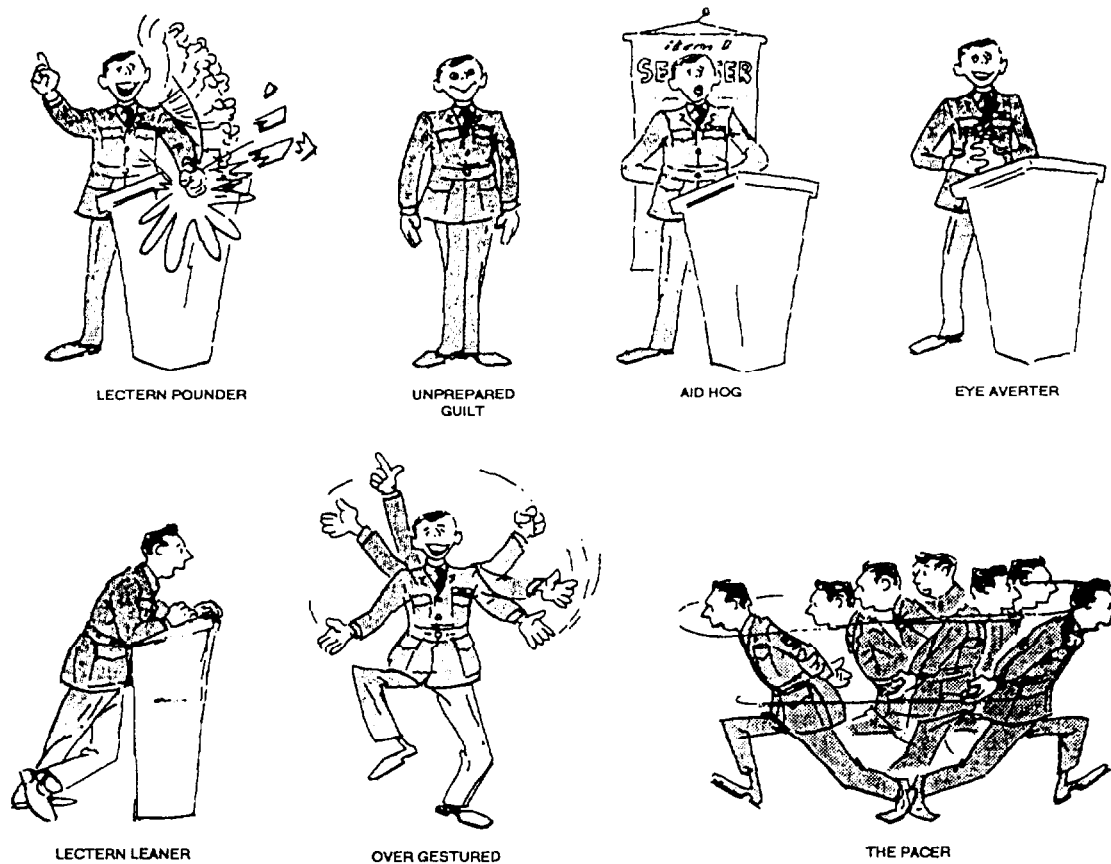

Figure 6-3.-Unnatural or exaggerated lectern or platform behavior by a speaker creates a major distraction.

A gesture is the movement of any part of the body to convey some thought or emotion. Gestures should always be purposeful. They must be natural and seem to grow out of what you are saying. Avoid artificial gestures and mannerisms that do not help to express an idea.

Whenever you speak, you and the Navy will be judged by your appearance. Immaculate grooming will give you added confidence in facing your audience and will add emphasis to what you say.

Voice Control

The quality of your voice has a direct bearing on the effect you will create. Make sure you are loud enough to be heard. Nothing is quite so exasperating as trying to read a speaker's lips to find out what he is saying. Volume should be increased so the person in the last row can hear every word you articulate. Expressiveness is important too. An expressive voice varies the rate of speaking and appears to be conversational in tone.

Delivery Rate

Some thoughts should be spoken slowly, some with feeling and some with excitement. Above all, the rate should be natural for the idea expressed and should serve to emphasize important ideas. Of course, the words selected to convey your ideas must not be overlooked. No speaker will ever have to contend with the criticism that he has a dull or faltering voice if he earnestly strives to get his point across and avoids sounding wooden and mechanical in delivery.

AUDIOVISUAL AIDS

Learning Objective: *Identify the audiovisual aids used to support speeches.*

There are several types of audio and visual aids that a speaker can use to support his oral presentation. The materials and equipment we will discuss now are available at the visual information or graphics divisions of most commands, or they may be borrowed from nearby training aids centers or video libraries. They can also be procured through normal supply channels by the speech writer or by the speaker himself.

Most large public affairs offices, as part of their standard office equipment, maintain such items as 35mm Carousel and overhead projectors, screens, audio cassette recorders, stock video footage, a 35mm slide file, videocassette players, television monitors, and so

forth. For the actual operation of this equipment, refer to the various manufacture' guide books.

Audiovisual aids (equipment and materials) fall into the following four general categories:

- Directly shown devices
- Optically projected aids
- Actual objects and models
- Audio or sound effects

In your speaking situation, you must decide what category (or combination) will best serve you in increasing your ability to communicate your information to a particular audience.

DIRECTLY SHOWN DEVICES

Directly shown presentation devices are reliable and relatively inexpensive. This category consists of charts, graphs, posters, maps, dry marker or chalkboards, slap-ons and handouts.

Charts

A chart may range from a simple list to a complex portrayal of the function and structure of an organization. A well-made chart is simple and uncluttered and adds immeasurably to the interest and clarity of your presentation.

A chart frequently used is the strip-tease outline chart. This chart contains a brief outline covered with strips of paper. The strips are removed when the right word, symbol or phrase is needed to reinforce the oral presentation. Of course, the words or phrases should be arranged in logical sequence, corresponding to your key word outline or prepared manuscript.

The following is a list of rules you should keep in mind when you use a chart:

- Use short phrases and words and illustrate their meaning, inapplicable.
- Use type and lettering large enough to be seen easily.
- Use highly visible colors.
- Do not use too many colors.
- Keep it simple.

Graphs

You can make the presentation of statistical material clearer, more vivid and interesting by the use of well-planned graphs. Subjects, such as the growth of manufacturing in the United States, the breakdown of our budget dollar or comparisons of living standards, are best presented with graphs. They require very little special skill in presentation.

Most graphs fall into one of the four categories, as shown in figure 6-4. These categories are as follows:

The line graph is used to demonstrate trends and changes that take place in such items as income and population.

The bar graph is another type used to show information of a comparative nature. The major difference between the bar graph and the line graph is that the former need not show any passage of time.

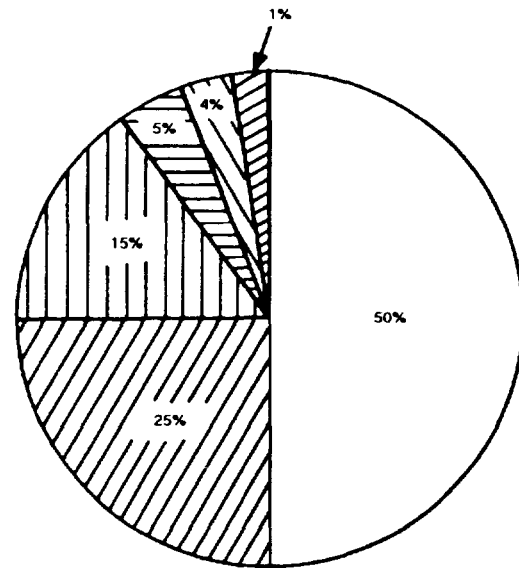
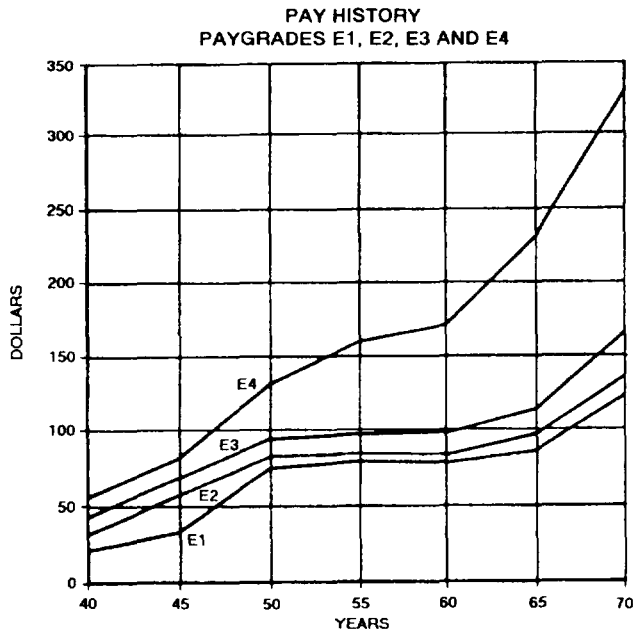

**POPULATION FORECAST OF U.S. FOR YEAR 2050
BY AGE AND SEX**

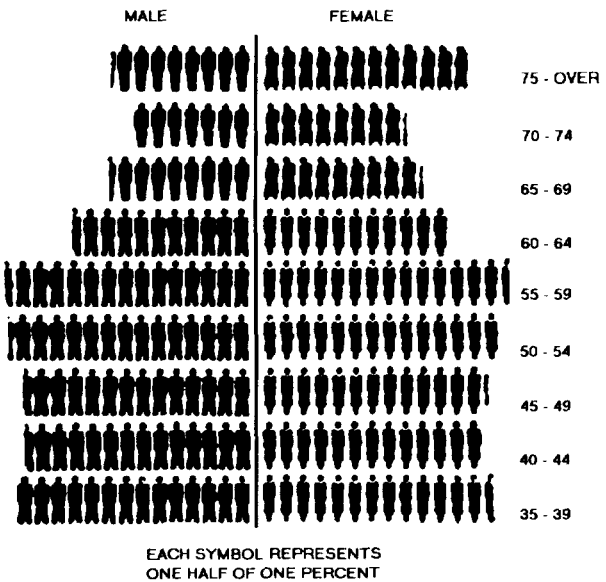
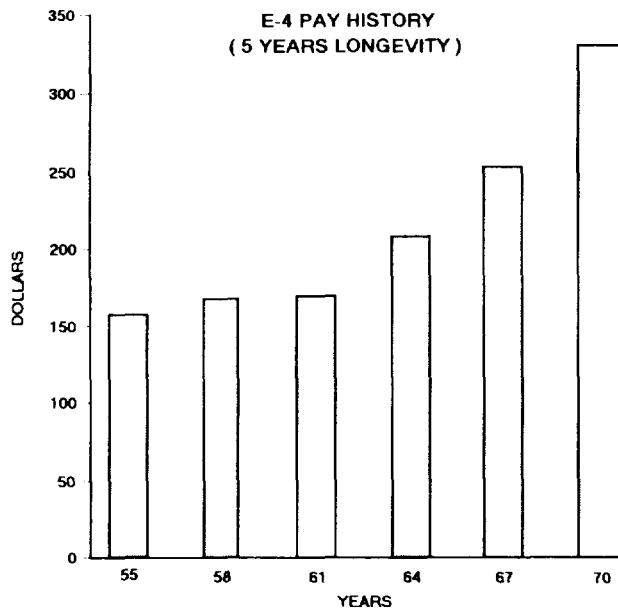

Figure 6-4.-Line, pie, bar and picture graphs (GRAPHS FOR DISPLAY ONLY).

The pie graph is often used to present a percentage breakdown. The complete pie or circle represents 100 percent. The pieces represent proportional percentages.

Although more difficult to prepare, the picture graph is often the most interesting and striking of the four types. Picture graphs are used to show trends, comparisons or combinations of the two. They are prepared in a manner similar to the bar graph. By substituting whole and part symbols for the bar, percentages or quantities can be indicated accurately.

Posters

Posters are used to symbolize ideas. Usually they do not contain text. Sometimes a short statement or word can be used to help the audience grasp the idea more quickly. An illustration that clarifies your point can convey a message with great impact.

When you prepare a poster (or work with the graphics division on its preparation), eliminate all unnecessary words. Keep the message simple and direct and make sure your picture illustrates what you are trying to get across.

There are several methods by which you can produce a poster. Using an opaque projector (explained later), you can enlarge a picture that can be traced and colored as desired. You can also use carbon paper and a stylus for tracing, either directly or with a sheet of tracing paper in between. For some, using a T square and pantograph will work fine, while others will opt for the freehand method.

Maps

A map should be large enough to be seen easily; it is preferable to draw in or emphasize by color the areas you are discussing. Maps can be reproduced in the same fashion as posters.

The following list presents a few suggestions to help you develop your technique for using a map effectively as an aid in speaking:

- Colored overlays may be used to outline specific areas.
- Colored ribbons may be stretched between points to show relationships and distances.
- Cutouts, such as arrows, circles and rings, may be prepared in advance and taped to the map in the course of the presentation.

- Acquaint yourself with the map so that you do not have to hunt for the country, state, city or area you are trying to point out.

Dry Marker or Chalkboards

The main advantage of using the dry marker or chalkboard is that an idea can be placed on the board bit by bit or strip-teased as it is developed orally. Consider the following rules for using these boards:

- Plan your illustrations in advance.
- Keep the board simple and uncluttered.
- Make sure everyone can see the board.
- Avoid obstructing the view of the board.
- Do not keep your back to the audience for prolonged periods.
- Use a pointer when you point to something on the board.
- Do not allow yourself to get trapped by substituting the board for visual aids that you did not get a chance to prepare in advance.
- Make sure your handwriting is legible.
- Use color for emphasis—not mere decoration.
- You can sketch diagrams in advance with a pencil to quicken the drawing process while you are speaking.
- You can prepare and strip-tease art in advance.

Slap-Ons

Slap-ons are cardboard signs that are usually four inches wide with various lengths. They contain key words or ideas the speaker wants to emphasize. Magnets are glued to the back side and placed on a magnetic chalkboard. Slap-ons placed on felt-covered boards require small pieces of Velcro tape glued to the back.

Handouts

You may use photo copies of a chart, drawing, fact or data sheet, welcome aboard brochure, and so on, as an aid to your talk. You must carefully plan the time of the distribution. Beware of the temptation to pass out handouts, outlines, or any printed matter during the presentation. Doing this will divert attention from what

you are saying and can result in a loss of continuity. The following principles are involved:

- Motivate the audience to want to read the material.
- Have a system for smooth distribution.
- Maintain contact and continuity.

The best time to distribute handouts is at the end of the presentation, during which time you may ask for questions. An alternate time for distribution is before you begin your talk, provided the audience has been previously motivated to recognize the value of the material.

OPTICALLY PROJECTED AIDS

Optically projected aids include the opaque projector, overhead transparency projector, videotapes (and associated equipment) and the Carousel slide projector.

Opaque Projector

The opaque projector (fig. 6-5) has two basic applications. First, it can be used to project graphs, photographs and other aids that are too small to be seen but should be shown in their actual form to your audience.

It may also be used for enlarging clippings, maps, photographs and other items so they can be traced proportionally correct and in complete detail. The projector permits you to project an illustration or other material out of a book without damaging the publication,

The "opaque" uses a 1,000-watt projection lamp and is equipped with a 4 1/2-inch diameter, 22-inch focal length lens. The projector comes with an opaque object-holding device and a conveyor belt loading mechanism that permits uninterrupted projection. It also has an optical pointer that permits details anywhere on the screen to be pointed out by a projected light spot.

The roll feed assembly provides a means for handling opaque objects of any length up to 10 inches wide. The thickness of the object should not exceed 1/32 of an inch.

To operate the roll feed assembly, stand behind the projector and hold the crank knob in your right hand. Hold the copy in the left hand, faceup, bottom edge toward the screen and feed it into the left side of the projector. When the material is inserted approximately 1 1/2 inches, turn the crank clockwise. The pressure created by the impelled air holds the opaque object flat on the feed belt. When the crank is turned, the opaque object is carried into position. When the next opaque object is to be inserted, repeat the operation. The insertion of one opaque object automatically removes the previous one.

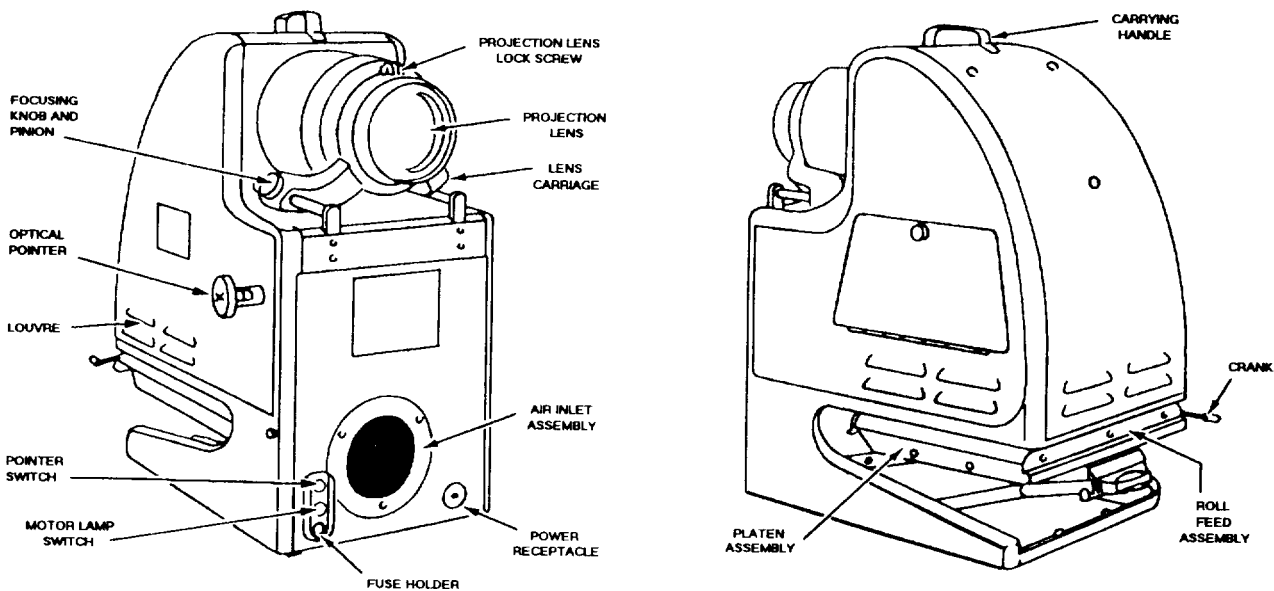

Figure 6-5.-The opaque projector.

To project thicker objects (up to 1 1/2 inches thick), lower the platen assembly to the locked position and remove the roll feed assembly by lifting it off. Place the opaque object upon the platen assembly, and let it rise slowly as far as it will go. Apply a continuous pressure downward on the platen handle with your hand to prevent the platen assembly from snapping upward when you release the lock.

Although thick objects can be projected, only one plane of the object can be brought into focus at a time. Other planes can be brought into focus when you rotate the focusing knob. However, when an object is not too thick, good definition can be obtained over its entire thickness.

When you use this projector, place it on a table high enough to project the image over the heads of the audience. Do not use a low table that requires the excessive extension of the elevating legs. This produces

a distorted screen image that is impossible to focus sharply.

There are several disadvantages of using the opaque projector. It is expensive, relatively heavy (you usually need more than one person to carry it) and the fan blower can be noisy when the unit is in operation. Additionally, the opaque projector does not illuminate the screen as brightly as other types of projectors. For satisfactory projection, use a darkened room.

Overhead Transparency Projector

This projector (fig. 6-6) is popular with both speakers and audiences. You can draw your audience into your presentation by underlining or writing on the transparency film as you speak. When you note audience comments or opinions on the transparency, they become part of your presentation.

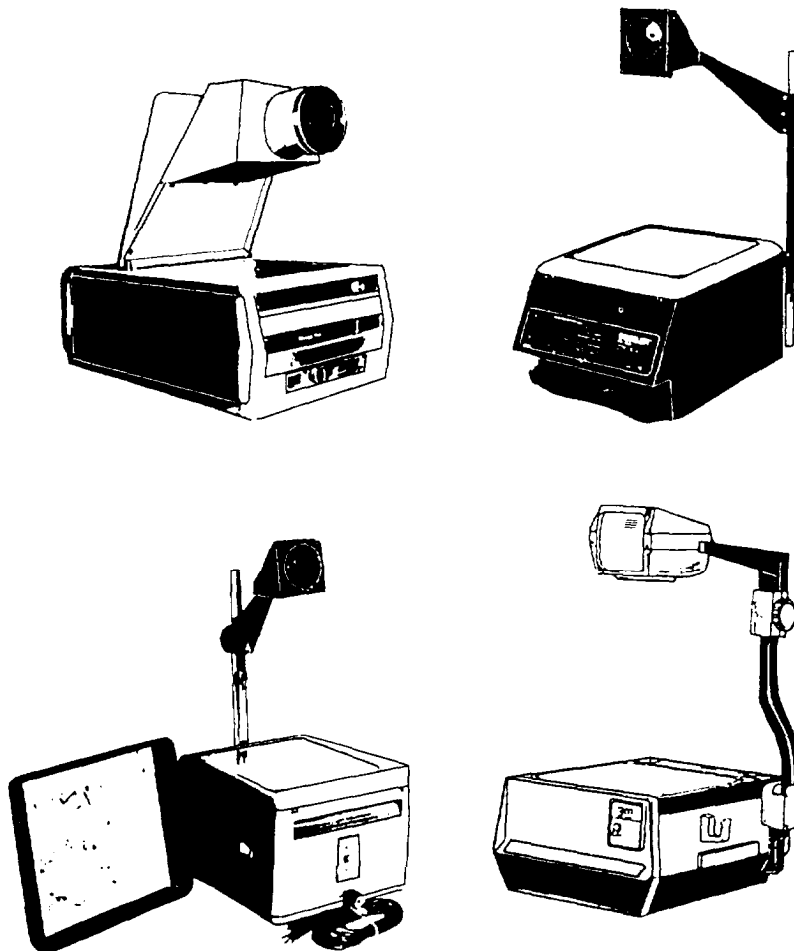

Figure 6-6.-Various types of overhead transparency projectors.

With the proper overhead projector setup, you can face your audience, point to the items on the transparency rather than a screen, uncover one point at a time, and highlight information with colored transparency markers. Also, by writing notes on the overhead transparency frame, the speaker is not tied to a script or index cards. All transparencies must be mounted on cardboard frames to make sure they lie flat on the projector stage and block out excess light.

The overhead transparency projector, like the opaque projector, is noisy when the fan blower is on. Remember to increase your speaking volume when you are operating the projector.

Types of transparency slides that may be used include cellophane or plastic sheets, overlays, cutouts, bar graphs and animated devices that are constructed transparent models with movable parts.

Although many different models of overhead projectors are in use today, the operation of these devices is simple and generally the same. It involves nothing more than turning on the projection lamp, focusing the image and positioning the image on the screen.

Proper placement of the projector requires the operator to consider the best possible arrangement for each situation. Several points to keep in mind are listed below.

- Place the projector on a table or stand at such an angle that the projected image is a nearly perfect rectangle. Projectors not properly placed result in a keystone image (discussed later).
- Make every effort to ensure that each member of the audience can see the image. Also, keep in mind, the farther you move the projector from the screen, the less intense the projected image is.
- Projected images should be viewed without having to shift the eyes over too wide an area. Seating the audience at a distance no closer than twice the width of the image takes care of this requirement.

Videotapes

Careful selection of videotapes is necessary if they are to complement your speaking situation. Make sure the video will help clarify and add to your presentation.

Preview the video. If it is right, select the important points that you want to highlight and emphasize when you introduce it.

Plan the introduction of the video and the discussion following the video around key points.

Make a final check of the videotape and your tape deck before the presentation. To assure proper tension while playing, fast forward and rewind the tape. Properly adjust the monitor to suit your needs (color, hue, volume, etc.). A videotape can be shown on a large screen, using a television projector. Television projectors are costly, but the quality of the projected picture is constantly improving.

Introduce the tape by telling the audience what they can learn from watching it and suggest the important points to look for during the showing.

Carousel Slide Projector

The 35mm Carousel slide projector (fig. 6-7) is by far the most preferred visual aid of Navy speakers. Its

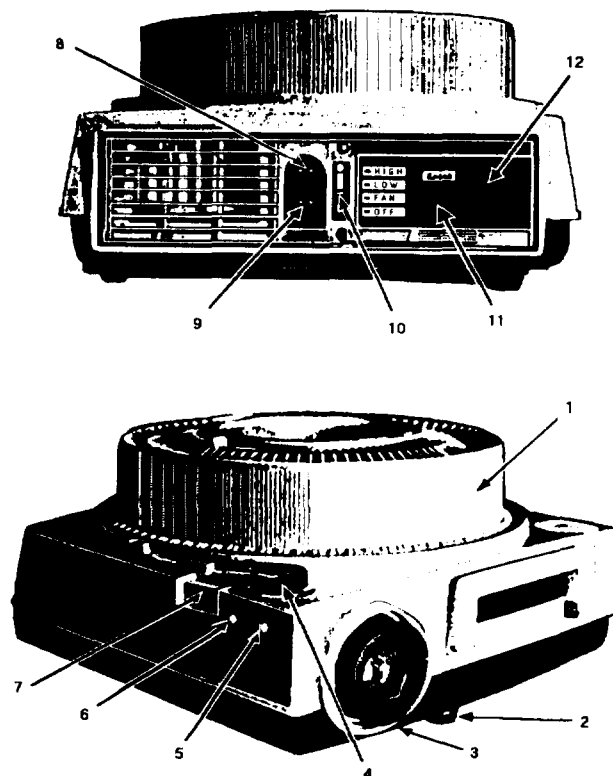

1. SLIDE TRAY
2. ELEVATING WHEEL
3. LENS
4. FOCUS KNOB
5. FORWARD BUTTON
6. REVERSE BUTTON
7. SELECT BUTTON
8. REMOTE CONTROL RECEPTACLE
9. DISSOLVE CONTROL RECEPTACLE
10. SELECTOR SWITCH
11. AUTOMATIC TIMER
12. ILLUMINATED CONTROL PANEL

Figure 6-7.-The Carousel slide projector.

associated equipment is portable, generally inexpensive and very versatile, making it an excellent device for public speaking use. Most public affairs offices, especially if they operate speakers bureaus, have a good 35mm Carousel slide projector system.

Slides are fed to the projector from a top-mounted tray designed to accommodate up to 140 slides. The slide tray accepts film sizes 126 (28 by 28mm), 135 (24 by 40mm) and 127(1 5/8 by 1 5/8 in.). Slides mounted in cardboard, glass, metal or plastic 2- by 2-inch frames up to 1/10 inch thick can be used. Slide identification numbers are molded onto the tray. As the tray revolves, the number of the slide being shown is opposite the gate index on the projector.

The forward and reverse buttons located on the side of the projector control the direction of the movement of the slide tray. When you momentarily depress the forward or reverse button, the slides change in either direction at any desired time interval. A wired remote control has similar buttons and, in most cases, a focusing lever for power focusing the lens.

Some units are equipped with an automatic timer feature. When the timer is set at one of three settings (5, 8 or 15 seconds), the slide-changing mechanism is actuated automatically and the slides are viewed for the number of seconds indicated. The timer feature may be interrupted at any time by using the forward and reverse buttons on the remote control or on the projects.

Another feature of the Carousel projector is a choice of high or low illumination. In the high position, the entire 500-watt illumination of the projection lamp is selected. In the low position, the illumination is decreased to 425 watts for longer projection lamp life.

A dissolve unit incorporating more than one projector may be used to create a motion-picture effect.

ACTUAL OBJECTS AND MODELS

At times objects can be used to support your main points. They can be the actual objects you are speaking about or objects that can symbolize your idea; for example, a mechanic's hammer and a sickle can represent communism.

You must remember two things when using actual objects as visual aids. First, the objects must be large enough so that all important details are visible, yet small enough to be handled by the speaker. Second, the object should not be displayed by holding it in your hands; set it on a table or use it on a hook and loop board.

You can make models representing tangible objects to symbolize an intangible idea, and use them to support your point: for example, a scale to represent justice, a small Statue of Liberty to represent freedom, and so forth.

You can make models easily from cardboard, wood and string. Often with models, action can be built in to further enhance the impact of the aid. The same rules that apply to objects apply to models displayed in the speaking area.

AUDIO OR SOUND EFFECTS

Audio devices, when used in conjunction with visual aids, can further the impact of your presentation and increase the audience's retention of your subject matter. In supporting your point, your audience must be able to understand clearly the audio and visual aids. If they are not clear, they only confuse. The two main types of audio equipment systems are audio tape (cassettes and reel-to-reel) and compact disc systems. Records are nearing obsolete status.

STAGING A PRESENTATION

Learning Objective: Identify the methods of staging a speech presentation.

The use of audiovisual equipment and materials to support a speech greatly increases our ability to communicate the Navy's message. When audiovisual equipment is used in a presentation, however, the speaking situation must be well-staged. Giving a speech involves more than well-organized subject matter, proper equipment and complementary audio and visual segments.

Proper staging of a presentation depends on controlling the environment to the greatest possible extent, including the proper selection of the screen and establishing a clear line of vision for the audience.

THE SCREEN

The screen is often the weakest link in a projection chain. A projection screen interrupts the light falling on it from the projector (or other sources) and diverts it to the viewer's eyes. The efficiency with which it does this affects image brightness, evenness of image brightness, color saturation and contrast of image.

The screen should be high enough so that the audience has an unobstructed view. From the persons in

the front to those in the rear, there should not be any obstructions.

In most situations, particularly in rooms where the floor does not slope and there is no platform, the bottom edge of the screen should be at least 4 1/2 feet from the floor. With the screen at this height, most people will have an unobstructed view. On the other hand, the screen should not be too high for viewing comfort.

The screen should be tilted as necessary to eliminate "keystoning" (a distortion of the image in which the top of the picture is enlarged out of proportion). The principle involved is that the plane of the screen should be at a right angle to the center line of projection; otherwise, the image will be distorted as shown in figure 6-8.

Wide horizontal angles of vision should also be avoided. Preferably, in an oblong room, the screen should be parallel to the shorter dimension. If the screen

is set parallel to the longer dimension, the angle of vision at either side becomes too great for easy viewing.

Types of Screens

In general, there are five types of screens used in presentations today: high-gain aluminum, matte, lenticular, beaded and rear-projection.

HIGH-GAIN ALUMINUM SCREENS.- High-gain aluminum screens have thin sheets of specially grained aluminum foil laminated to a slightly concave, noncollapsible lightweight frame. The screen reflects the projected light onto an area approximately 60 degrees wide by 30 degrees high. The reflected image is about six times brighter than that of other screens. Because of the special surface characteristics, this type of screen can be used in a normally lighted room. When properly positioned, the screen rejects room light by reflecting it away from the viewers,

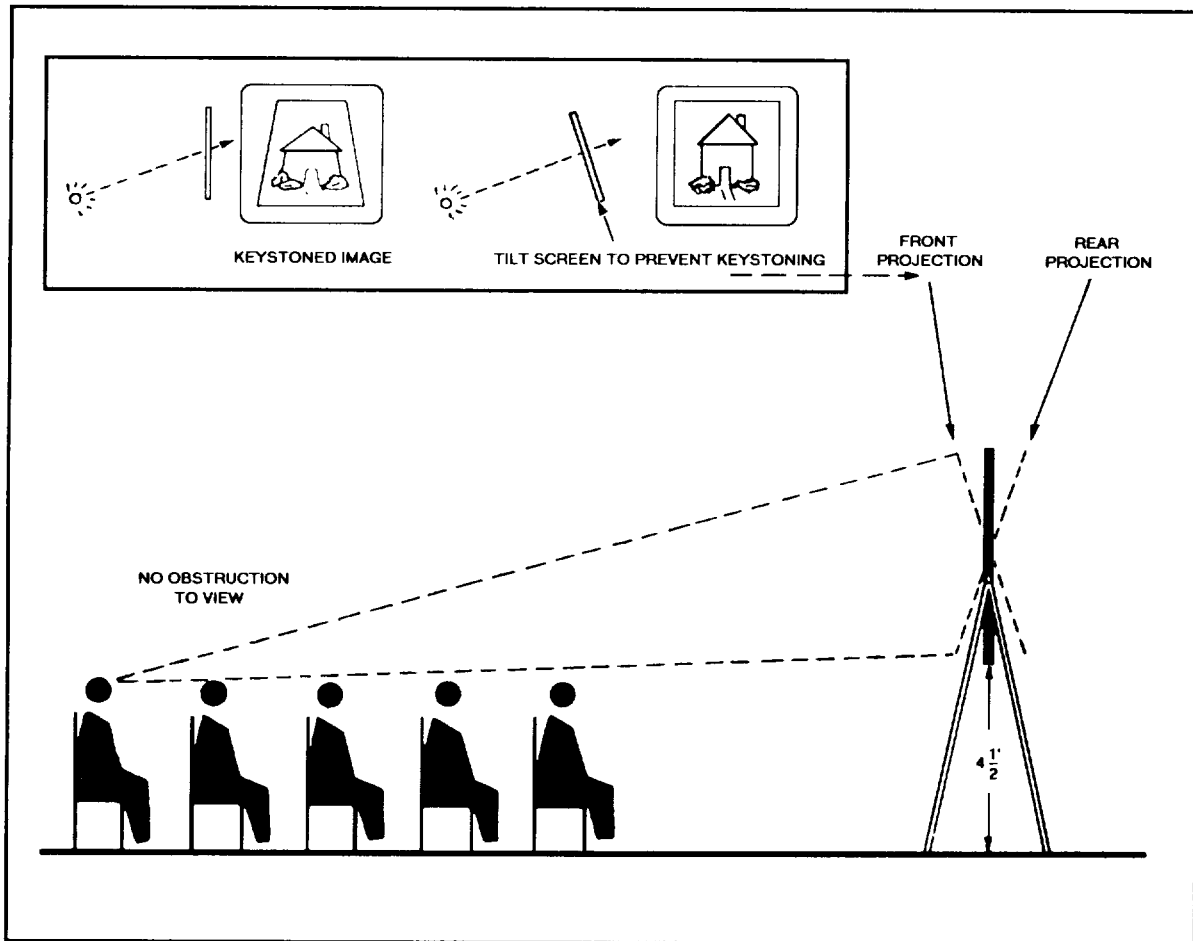

Figure 6-8. Proper screen positioning.

thereby retaining full contrast and color saturation in the viewing area.

MATTE SCREENS.– Matte screens diffuse light evenly in all directions. Images on matte screens appear almost equally bright at any viewing angle. To avoid distortion caused by the viewing angle, the viewers should be no more than about 30 degrees from the center line of the projection axis; they should be no closer than two times the image height (2H) from the screen.

LENTICULAR SCREENS.– Lenticular screens have a regular pattern of stripes, ribs, rectangles or diamond-shaped areas. The pattern is too small to be seen at viewing distances for which the screen is designated. The screen surface may appear to be enameled, pearlescent, granular metal or smooth metal, and it may or may not have a coating over the reflective surface.

By controlling the shape of the reflecting surfaces, lenticular screens can reflect nearly all the light from the projector evenly over a fan-shaped area about 70 degrees wide and 20 degrees high. People seated farther to the sides of the screen than the 70-degree angle or above or below the 20-degree angle may not see an image; no image-forming light is wasted outside the viewing area. Many lenticular screens provide an image three or four times as bright as a matte screen.

BEADED SCREENS.– Beaded screens are useful in long, narrow rooms. They have white surfaces with embedded or attached small, clear glass beads. Most of the light reaching the beads is reflected toward its source. Thus a beaded screen provides a very bright image for viewers seated near the projector beam. As a viewer moves away from the beam, the image brightness decreases. At about 22 degrees from the center line of projection, the image brightness on a beaded screen is about the same as that on a matte screen. Beyond this angle it is less bright than on the matte screen.

Since nonimage, or stray light, is also reflected in the general direction from which it comes, stray light falling on a beaded screen from a viewer's position at the side of a room can be a major problem.

REAR-PROJECTION SCREENS.– Rear-projected images have the same requirements for image brightness, size and contrast as front-projected images. Rear projection has advantages in some situations and disadvantages in others.

A person or object in front (on the viewer side) of a rear-projection screen does not interfere with the

projection beam. This makes rear projection useful when the projector must be concealed, as in displays. It permits close examination of the screen image. Rear projection may provide advantages in image contrast and color saturation in a lighted room.

Rear projection also has its disadvantages. With conventional projection, the space over the heads of viewers is usually used for the projector beam. With rear projection, the projection beam is on the opposite side of the screen from the viewers. Consequently, space for the beam must be provided outside the viewing room behind the screen. To reduce space requirements in rear projection, you should use short focal length lenses. More commonly, mirrors are used to “fold” the projection beam. Both methods are likely to reduce image brightness and quality.

Another important consideration in rear-projection screens is the darkness of the screen as seen by reflected light. As with front projection, the highlight brightness of the image should be as bright or brighter than other areas within the viewer's peripheral vision.

If the image is to be viewed in a well-darkened room, there is no advantage in a dark-toned screen. If the image is to be large, a light-toned screen is usually preferable since it absorbs less image light than a dark-toned screen.

You can achieve optimum viewing by using the following accepted standards for audience placement in relation to the screen, as shown in figure 6-9.

Line of Vision

In planning the space arrangement, the speaker should not stand in the line of vision. The lectern should be located to one side of the screen, leaving a clear view of two thirds of the stage area and only partially blocking the remaining third. On the opposite side of the screen from the lectern, A-frames, flipcharts, dry marker or chalkboards, and so forth, can be set up for optimum visibility.

LIGHTING

Proper lighting is important to relaxed viewing. Without question, the less the room light, the more brilliant the image on the screen and the greater the contrast. On the other hand, brilliance and glare can be annoying and cause eyestrain. A proper level of room light reduces the contrast and permits viewing with a minimum of strain.

The light source in the room should be behind, or at least toward, the rear of the audience. This will reduce the occurrence of glare spots and extraneous light, which reduces contrast.

Front lights produce too much light on the screen, and their glare is distracting. You should never schedule an overhead projector presentation in the morning in a room that has windows on the east side that cannot be draped. Conversely, presentations should not be scheduled in the afternoon in a room with windows on the west side that cannot be draped.

Light sources that provide some illumination during projection, but not directly on the screen, help maintain a social atmosphere and permit taking notes. During projection, the screen image highlights should be brighter than any other surface within the viewer's field of view. "Hot spots" caused by reflections from shiny surfaces or gaps in window covering should be eliminated.

The projector should never be focused on the screen without a slide! The absence of a slide on the

overhead projector while changing transparencies results in an annoying glare. The darker the room, the greater the glare and the greater the distraction to the flow of the presentation.

None of the usual solutions to this problem are satisfactory. When the projector bulb is switched on and off, there is a risk of bulb failure, which can be an awkward distraction. The shutter that fits just under the lens can be used, but manipulation calls for a third hand if transparencies are to be shifted quickly. Furthermore, the shutter does not cut off the light from either the ceiling or the operator's eyes. The operator may be temporarily blinded and possibly lose his place in the script.

To solve this problem, you can use a simple device that cuts off light at the aperture as well as pre-positions the slides. This device, designed to work with any overhead projector, is attached to the light table with masking tape. A transparency is fed into the charnels and centered over the aperture. While this transparency is being shown, the next transparency is fed into the

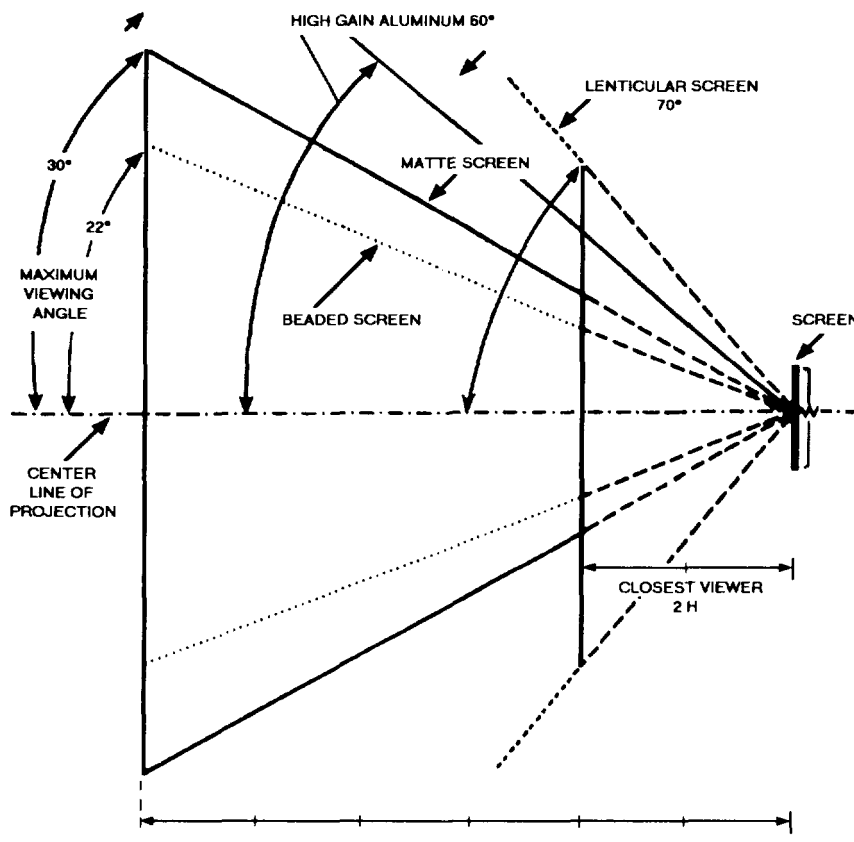

Figure 6-9.-Screen relationships for audience seating.

holding area. To change transparencies, all you need to do is push the new transparency into position, thus forcing the first one out. This device permits very rapid changes, permits the use of single cue words with no pause for changing the slide and ensures that there is always a slide over the light source, as shown in figure 6-10.

AUDIOVISUAL MECHANICS

A well-planned presentation area with smoothly working equipment can add immeasurably to the speaker's confidence and poise. At the same time, nothing can ruin a presentation more quickly than equipment that functions incorrectly or audiovisual devices that cannot be seen or heard.

Set up the projector with the lens at an exact right angle to the screen to prevent any sideways keystoneing. Allow sufficient distance from the screen so the image fills as much of the screen as possible while retaining sharp focus.

Whenever possible, the mechanics of a presentation should be kept in the background—either behind the screen, to the rear of the audience or in an enclosed projection booth.

The rear-projection arrangement not only hides the machine and its operator, but it also reduces the noise and interference of the projector fans. Just as important, rear projection separates the projector and the narrator, thus eliminating a potential source of distraction. The

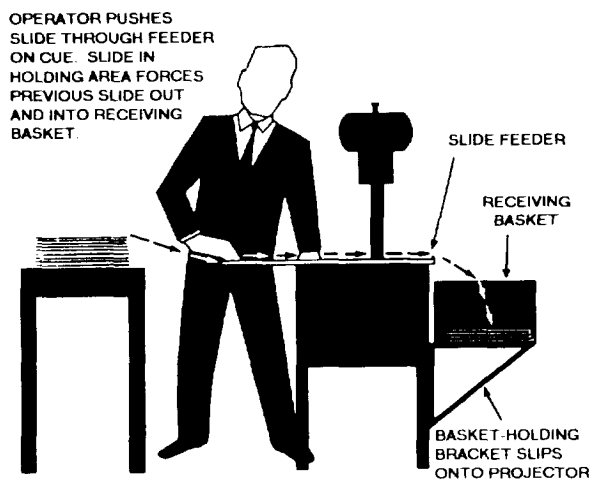

Figure 6-10. Slide-feeder method of operating an overhead transparency projector.

major problem in rear projection for you to be aware of is lack of room behind the screen.

For rear projection (using the overhead projector described earlier), you must use a translucent screen so that the image will go through the screen; also, the transparencies must be reverse-mounted. Portable translucent screens that can be carried in small convenient cases can be purchased in several sizes. The better types can be assembled in various ways to give different heights and to slant forward or backward to eliminate keystoneing.

In mounting transparencies for rear projection, you must reverse the transparencies (that is, turn them upside down) before binding them in the frame. Transparencies with overlays, when mounted for rear projection, cannot be used for front projection without remounting them in the frame.

When you use more than one type of projector for a presentation (using the rear-of-audience or projection-booth method), stagger the projector heights to avoid silhouetted images of the equipment.

After your projectors are in position, take the following steps:

1. Connect the power cords, and make sure all connections are firm and cables are placed so people will not trip over them.
2. Turn on the machines, check for proper operation and familiarize yourself with all controls. Keep a spare bulb by each machine.
3. Run through the material to be projected, checking for relevance of material, quality of projection and focus.
4. Set each machine for immediate cue-in.
5. Place speakers (amplifiers) as far from the lectern as possible while still remaining in front of the audience. This will avoid microphone squeal or feedback. Place them on opposite sides of the room, angled slightly toward the audience; set them to a height several feet above the audience to enable undistorted sound to reach the back of the audience.

COMMAND SPEAKERS BUREAU

Learning Objective: *Identify the guidelines for establishing and operating a command speakers bureau.*

A local speakers bureau is normally a part of the public affairs office. The bureau is responsible for

implementing, on a local level, the functions of the CHINFO Speakers Support Division which are as follows:

- To broaden the scope of platform appearances by Navy speakers to include all segments of American society
- To secure qualified Navy speakers for appropriate gatherings
- To provide (upon request) in-depth reference material and previously delivered speeches concerning primary naval subjects
- To provide guidance on speech security and policy reviews

Local speakers bureaus are usually part of the community relations section of a public affairs office. These bureaus offer one of the best and most direct means of reaching the public and keeping them informed of various Navy activities. All public affairs offices are encouraged to establish and maintain a speakers bureau. Other large commands, and some allied naval commands, such as SACLANT, operate some type of formal speakers program.

In its simplest form, a speakers bureau is nothing more than a list of speakers who talk on a variety of subjects. To be a truly effective tool in enhancing the goals of a well-planned community relations program, however, a speakers bureau demands much more. It demands, for example, detailed planning and organization. If you establish and operate a speakers bureau, you should follow certain guidelines, as listed below:

- Prepare a good speakers bureau planning directive.
- Develop and maintain a roster of volunteer speakers.
- Prepare speakers' folders.
- Develop a civic organization file.
- Develop a speakers bureau reference library file.
- Maintain an organized file on all incoming and outgoing correspondence relating to the bureau's operation.
- Advertise the bureau.
- Evaluate all speaker requests.

- Be prepared to assist the speaker(s) in any way possible.
- Evaluate the speaking engagement.

ESTABLISHING A DIRECTIVE

When preparing your planning directive to establish standing operating procedures for a speakers bureau, you should thoroughly investigate all policy, guidance and restrictions, if any, of higher authority. You must comply with the provisions of *PA Regs*.

You can get help regarding the writing, scheduling and handling of speaker requests from the CHINFO Speakers Support Division. Invaluable reference sources available from this division are the *Navy Fact File* (NAVSO P-3002), a collection of unclassified information on a variety of Navy subjects, and *Navy Talking Points*, a compilation of authoritative information on important Navy issues.

Other sources are as follows:

- *Annual Posture Statement* by the SECNAV and CNO (available in March annually, following congressional testimony)
- *The Almanac of Sea Power* (published annually in April by the Navy League of the United States)
- *National Security Strategy of the United States* (The White House, January 1988)
- *Bartlett's Familiar Quotations*, John Bartlett
- *Dictionary of Military and Naval Quotations*, Robert DebHeinl, Jr. (U.S. Naval Institute Press)
- *The Great Thoughts*, compiled by George Seldes

After a thorough study of the previously mentioned references, determine local command policy, guidance and restrictions, if any, for the speakers bureau. This support should be reflected in your planning directive in the paragraph on "policy." Other essentials that must be published in the bureau plan areas follows:

- Responsibilities (include what the public affairs office will do to assist speakers, what the speaker must do, and what other agencies are responsible for).
- Restrictions, if applicable (may be included as part of the "command policy" paragraph).
- Specific details on the operation of the bureau (explain clearly the sequence of events in an

PUBLIC AFFAIRS OFFICE
NAVAL EDUCATION AND TRAINING
PROGRAM MANAGEMENT SUPPORT ACTIVITY
SAUFLEY FIELD
PENSACOLA, FLORIDA 32509-5000

21 July 1992

ATC Gerald P. Holstein
NETPMSA Code 315
Pensacola, FL 32509-5000

Dear Chief Holstein,

I have been informed that you are interested in participating in the NETPMSA Speaker's Program at Saufley Field.

Much understanding and goodwill are built for the Navy and Saufley Field by this program of speaking engagements with organizations in the civilian community. Last year many NETPMSA speakers participated in programs sponsored by civilian organizations.

Our Speakers Bureau maintains the speaker's file, that includes a biography on the speaker, a record of previous speaking engagements and a copy of the speech that has been reviewed and cleared.

When a request for a speaker is received, this file is used to assist in obtaining the right speaker and the subject for the job, and assists in proper publicity as required.

Speaker nominees are contacted directly by the Speakers Bureau since the speaking engagement is voluntary; however, all commitments are subject to approval by commanders concerned. I request that you make a brief outline of your subject topic, complete the biographical data sheet enclosed and return both to this office.

After these are received, you will be contacted, and I would like to speak to you personally about the program.

Sincerely yours,

URSULA R. MAJOR
Public Affairs Officer

Figure 6-11.-Follow-up letter.

assigned speaking engagement, including any reports that must be submitted by speaker).

- Administration (if not included under the above paragraph, state clearly any financial responsibilities, who publishes applicable orders, etc.)

In preparing your planning directive, completeness and word choice will have a strong influence on the ease with which you obtain qualified speakers. Give the speaker as much assistance as possible. Reflect those items in your directive.

DEVELOP A SPEAKER FILE

After defining the bureau guidelines, develop a roster of speakers who are qualified and express a desire to speak on Navy associated subjects. Consider everyone in the command—officers, enlisted personnel, Navy civilians, retired and Reserve personnel. A public affairs representative can find capable speakers through the use of questionnaires, personal interviews and staff and command assistance.

Many of our younger petty officers and nonrated men and women are extremely articulate, and more important, they have a rapport and voice among high school and college students which older officers and petty officers seldom match. Such young men and women should be sought out and used in speakers bureaus, and opportunities for them to speak should be solicited vigorously, particularly among younger audiences.

Another group of “natural” speakers are the instructors in the various Navy training programs. These men and women have an authority and a ring of authenticity that officers cannot duplicate; they were selected for their ability to speak

Naval personnel of any minority race are frequently the most effective speakers to send to groups composed chiefly of their own race.

Recruiting speakers requires a determined effort. There are a variety of methods through which you can seek volunteers. Some of these methods are discussed in the following text.

Command Assistance

Informing incoming personnel of the command’s speakers program can be accomplished during initial interviews with the officer in command or the person designated to give indoctrination briefings. The

command public affairs office is normally included on the individual’s check-in sheet. This is a perfect time to sell the bureau to prospective speakers. If incoming personnel express a desire to participate, follow up with a personal letter such as the example in figure 6-11, Enclose a speaker biographic data form, such as the one contained in figure 6-12. You can make your own modification of this form as well as the others discussed in this chapter.

Review Personnel Data

To gain more insight about potential speakers, request a continuing list of incoming personnel be sent to the public affairs office with key items of data (department or division assigned, previous assignments, unusual duty, etc.). Send a letter requesting participation when the name of a potential speaker crosses your desk.

Advertise

You can advertise your speech program by doing the following: (1) sending letters to neighboring subordinate commands requesting they assist you by inviting qualified members of their organization to participate (fig. 6-13); (2) sending form letters to all personnel urging participation (including the biographic data sheet, as shown in fig. 6-12); and (3) publishing information in the command newspaper, newsletter, Plan of the Day, SITE system, and so forth.

Toastmasters International

Toastmasters is an international organization that gives its members training and experience in public speaking. Local clubs exist in most cities where naval activities are located. Many Navy personnel participate in these clubs, and such participants are often excellent candidates for the speakers bureau. Contact the club chairman and ask for the names of qualified naval participants.

Incentives

Speakers often need incentives to participate. Publicize the bureau and what it is accomplishing. Give recognition to speakers and give certificates; publicize awards and commendations for speakers in newspapers, bulletins, and so forth. Such recognition can often make the task of recruiting much easier.

NAME _____ DATE _____
Last First Middle Initial

GRADE _____ ORGANIZATION AND DUTY ASSIGNMENT _____

1. HAVE YOU EVER HAD FORMAL TRAINING IN PUBLIC SPEAKING? YES NO

WHERE? _____

2. HAVE YOU EVER HAD PUBLIC SPEAKING EXPERIENCE? YES NO

NUMBER OF YEARS _____

3. SUBJECTS YOU ARE QUALIFIED TO DISCUSS (IN ORDER OF PREFERENCE):

A. _____

B. _____

C. _____

D. _____

4. CIVIL AND/OR FRATERNAL ORGANIZATIONS IN WHICH YOU HAVE HELD MEMBERSHIP:

A. _____

B. _____

C. _____

D. _____

5. PLEASE WRITE A BRIEF BIOGRAPHICAL SKETCH ON THE BACK OF THIS FORM.

Signature

Figure 6-12.-Biographical data form.

**PUBLIC AFFAIRS OFFICE
NAVAL EDUCATION AND TRAINING
PROGRAM MANAGEMENT SUPPORT ACTIVITY
SAUFLEY FIELD
PENSACOLA, FLORIDA 32509-5000**

5721
Code 00Z

From: Public Affairs Officer, NETPMSA
To: All Area Public Affairs Officers

Subj: ESTABLISHMENT OF SPEAKERS BUREAU; REQUEST FOR ASSISTANCE

1. A major concern of the Navy's public affairs program is in the area of fostering good community relations. One of the most effective methods of accomplishing this is through a Speakers Bureau. The NETPMSA Public Affairs Office is in the process of expanding and improving the present system and is requesting your assistance.

2. This office receives requests from civilian organizations to supply speakers for business or social gatherings. The requester may have a specific topic in mind, or he may ask us to suggest one. To obtain a wide variety of qualified speakers from which to select, we are attempting to organize our bureau with officer, enlisted and civilian personnel of all ranks, rates, grades, jobs and experience.

3. We need your assistance in canvassing your command and publicizing our recruiting program to encourage those interested to contact us. We are desirous of establishing this program with personnel interested in speaking on a variety of topics.

4. This office will provide or arrange transportation for all speaking engagements. We have videos and slides available for use as supporting material, and we will provide the equipment and an assistant if needed. We will also be happy to render assistance in preparing the speech.

5. For us to select the speaker best qualified for a particular engagement, we maintain a file on the background of each speaker herein our office.

6. We appreciate your assistance in this matter. Please direct your personnel to contact me at 452-9999.

U. R. MAJOR

Figure 6-13.-Letter to neighboring commands inviting speakers bureau participation.

SPEAKERS FOLDERS

The next step is to prepare a folder on each recruited speaker. The folder will provide the best method of being sure that you select the right speaker for the right occasion and special audience.

The following information should be included in this folder:

- Previous speaking experience or training
- Special qualifications to speak on certain subjects
- Previous speaking engagements and evaluations
- Biographic data sheet
- Photographs and news releases for advance publicity, a proposed introduction for the program chairmen and any additional elements that might be of interest in fitting a speaker to a subject

If your speakers bureau is fortunate and has a large number of speakers, it may be advantageous to use a cross-reference system to identify speakers and subjects easily. Prepare cards that can be filed alphabetically according to topic (fig. 6-14).

CIVIC ORGANIZATION FILE

In addition to information concerning the speakers, it is equally important to develop an extensive file on community organizations that includes detailed

information on various civic groups, veterans' organizations and other types of forums before which Navy speakers might appear. Such information provides data for audience analysis, which is essential if the speech is to achieve its objectives.

SPEECH RESEARCH LIBRARY

The fifth step in the organization of a speakers bureau is the development of a reference library. This file should include reference material on most Navy or military oriented topics. The more complete the reference library, the greater the assistance to the speaker. Such assistance may be a determining factor in the speaker's willingness to accept speaking engagements.

The following is a list of functions of the reference library file:

- To assist the speaker in selecting a topic of current interest that is appropriate to the mission of the command.
- To provide easy access to factual information on current topics.
- To provide easy access to policy statements and speeches on current themes.
- To provide guidelines and models for the preparation of speeches.
- To provide appropriate data concerning the availability of audiovisual aids.

SPEAKERS BUREAU CARD		
<i>(PRINT ALL ENTRIES - USE SEPARATE CARD FOR EACH SPEECH)</i>		
LAST NAME - FIRST NAME - MIDDLE NAME	ORGANIZATION	PHONE
SPEECH TITLE		
TYPE OF AUDIENCE		
SECURITY CLASSIFICATION	TIME REQUIRED FOR DELIVERY	
BRIEF RESUME		

Figure 6-14.-Cross-reference card.

Consider maintaining the following materials in your reference library:

- Fact sheets
- Press clips or broadcast summaries
- Newsletters
- Copies of speeches previously given
- Specially prepared speech materials that may be obtained from the CHINFO Speakers Support Division
- Selected periodicals and Navy magazines publishing key Navy speech themes
- Command information materials

LETTER FILE

A letter file has two major purposes: (1) to provide a complete record of the operations of the speakers bureau and (2) to provide a reference for new personnel in operating the bureau and continuing established procedures without loss of efficiency.

Your correspondence file should contain the following:

- Letters from organizations that request speakers (fig. 6-15)
- Replies to organizations, accepting or rejecting requests, as well as follow-up letters with additional details (fig. 6-16)
- Notification to the speaker nominee confirming the speaking engagement (fig. 6-17)
- Reports of speaking engagements made by speakers following their presentations (fig. 6-18)
- “Thank you” letters from sponsoring organizations to speakers of the bureau
- Official commendations or letters of appreciation to speakers (fig. 6-19)
- Special forms used in operating the bureau, such as work sheets (fig. 6-20) and speaker request forms (fig. 6-21)

ADVERTISING THE BUREAU

After you establish a speakers bureau, you need to develop appropriate speaking platforms-groups before whom your speakers can deliver the Navy’s message. Use the following methods to advertise your bureau and encourage worthy speaking requests.

Brochures

Distribute brochures to present information on the availability of speakers, topics that can be requested and the method of requesting.

Letters

Send letters to various organizations telling them about your speakers bureau (fig. 6-22). Enclose copies of your speaker request form.

Publicity

Advertise in various publications (command newspapers, radio and television spot announcements, etc.). Speakers can advertise the bureau when addressing various groups (for example, as an offer of service to the community to provide speakers for programs). Issue news releases advertising the bureau.

Chamber of Commerce

Inform the local chamber of commerce about your speakers bureau. They often receive requests for speakers and may refer them to you.

Toastmasters International

Inform your local Toastmasters club of the speakers bureau. As in the case of the local chamber of commerce, they can refer speaking requests to you.

Retired or Reserve Personnel

Ask these groups to advertise among their many civilian contacts the availability of military speakers.

Neighbor Commands

Inform adjacent military commands of your bureau. They will frequently receive requests they cannot fill and will refer them to you.

EVALUATION OF REQUESTS

With the speakers bureau effectively organized and properly publicized, numerous speaking requests can be anticipated. It is now the task of the public affairs office (or head of the speakers bureau) to evaluate requests for speakers to ensure that providing a speaker is in the best interests of the service and make sure the command will get all the possible benefits from the speaking

**ROBERT NARCISSUS
STRUCTURAL ENGINEER
6916 Corrydale Drive
Pensacola, Florida 32506**

May 1, 1992

Ms. Ursula R. Major
Public Affairs Officer
NETPMSA
Saufley Field
Pensacola, FL 32509-5000

Dear Ms. Major,

I am the downtown Pensacola Rotary Club program chairman for the month of June. In the past, we have had a number of very informative and pleasurable speakers for our programs from the U.S. Navy.

I wonder if it would be possible to arrange for a speaker for our club either June 9 or June 25, to speak to us on "Computer Forecasts for the Future." This is only a suggested subject, as I am open to any others concerning computers.

Our meetings are held on Fridays at the Gadfly Hotel at approximately 12:15 p.m. I would appreciate knowing when the best date would be so another program could be arranged for the remaining date.

Yours very truly,

ROBERT NARCISSUS

Figure 6-15.-Incoming letter.

**PUBLIC AFFAIRS OFFICE
NAVAL EDUCATION AND TRAINING
PROGRAM MANAGEMENT SUPPORT ACTIVITY
SAUFLEY FIELD
PENSACOLA, FLORIDA 32509-5000**

4 May 1992

Robert Narcissus
Structural Engineer
6916 Corrydale Drive
Pensacola, FL 32506

Dear Mr. Narcissus,

Thank you for your letter of 1 May 1992. We will be pleased to furnish you with a speaker for the June 9 meeting of the Pensacola downtown Rotary Club.

Mrs. Myra Ganset, a NETPMSA computer programmer, has graciously agreed to speak to your group on the subject, "Computer Forecasts for the Future." She will plan to meet with you at the Gadfly Hotel at 12:15 p.m. on the 9th. I have enclosed a biographical sketch on Mrs. Ganset for your use as an introduction and for any pre-publicity you may want to make.

Thank you for your interest in NETPMSA. If you need any further assistance, please feel free to call me at 452-9999 or write me at the above address.

Sincerely yours,

URSULA R. MAJOR
Public Affairs Officer

Figure 6-16.-Acceptance letter.

Date: _____

From: Public Affairs Officer, NETPMSA

To:

Subj: CONFIRMATION OF SPEAKING ENGAGEMENT

1. Confirming our recent telephone conversation, you are scheduled to address the members of _____

in _____ on _____ at _____

There will be approximately _____ in the group. _____

_____ is your point of contact and will meet you

2. Transportation arrangements for this engagement are: _____

Directions for travel to the place of presentation: _____

3. Please complete the attached form after your presentation and forward it to this office as soon as possible. Your participation in the NETPMSA speaking program is appreciated.

U. R. MAJOR

Figure 6-17.-Confirmation letter.

From:

To: Speakers Bureau, NETPMSA

Subj: REPORT ON SPEAKING ENGAGEMENT

Report on speaking engagement to _____
(Organization) (City or Town)

Date of presentation: _____

Subject of speech: _____

Number in audience: _____

Type and description of audience: _____

Manner in which speech was received: _____

Comments following speech: _____

Brief estimate of value to Navy-civilian community relations: _____

Should speakers be furnished to this group in the future? _____

Was the engagement worth the time and effort expended? _____

Any other pertinent remarks: _____

Figure 6-18.-Speaking engagement report.

From: Chief of Naval Education and Training
To: ATC Gerald P. Holstein, USN, 123-45-6789

Subj: LETTER OF APPRECIATION

1. Your voluntary participation in the NETPMSA Speakers Bureau has been brought to my attention. The four speeches on the future of U.S. Naval Aviation which you presented to civilian groups in the past three months have been informative and well received.
2. The speeches, given on your own time after normal working hours, have provided excellent support for the overall Navy Community Relations Program in the Pensacola area. Your actions have reflected credit upon the naval service and particularly commands within the Pensacola naval complex, and have been in the spirit of the President's program for provision of services and communications to the public.
3. Your extra effort on behalf of the NETPMSA Speakers Bureau and the Community Relations Program is appreciated.

ALVIN R. K. GECKO
Rear Admiral, U.S. Navy

Figure 6-19.-Letter of appreciation.

Date _____

Requester: _____ Phone: _____

Address: _____

Organization: _____ No. to attend: _____

Location of meeting: _____

Date: _____ Hour: _____ Length of speech: _____

Subject: _____

Speaker: _____ Phone: _____

Equipment: _____

Slide Proj. Overhead Proj. VCR/Monitor

Screen Operator Other

Transportation arrangements desired by speaker:

Will use privately owned vehicle: _____

Military vehicle (self-driven): _____

Military vehicle (w/driver): _____

Other (air travel, etc.): _____

Transportation request prepared: _____

Forwarded to transportation section: _____

Confirmation notice to speaker: _____ Letter to requester: _____

Photo, biog. & intro. forwarded: _____ Handled by phone: _____

MISCELLANEOUS REMARKS (TAD orders cut, etc.): _____

Figure 6-20. Speakers bureau work sheet.

Return to:
NETPMSA Public Affairs Office
ATTN: Speakers Bureau
Pensacola, Florida 32509-5000

Requesting organization and point of contact: _____

Date of request: _____

Date and time presentation is desired: _____

Place _____

City _____ State _____

Luncheon _____ Dinner _____ Other (Specify) _____

Subject desired: _____

Length of presentation: _____

Type of audience (technical, general public, male, female, mixed, private group): _____

Are the facilities to be used during this meeting open to all, regardless of race? _____

Will any racial group be excluded from or segregated within your meeting? _____

Is any racial group excluded from membership in your organization? _____

Will transportation be available at the arrival point (airport, rail terminal, etc.)? _____

Will the following equipment be available for the speaker:

1. Public address system _____
2. Lectern _____
3. Videotape player and monitor _____
4. A lavalier or lapel microphone _____
5. Slide projector _____
6. Light pointer _____

Are suitable hotel or motel accommodations available?

1. Name _____
2. Address _____

Expected attendance _____

Name and signature of person completing this form: _____

Organization title or affiliation: _____

Telephone number: _____

Figure 6-21.-Speaker request form.

**PUBLIC AFFAIRS OFFICE
NAVAL EDUCATION AND TRAINING
PROGRAM MANAGEMENT SUPPORT ACTIVITY
SAUFLEY FIELD
PENSACOLA, FLORIDA 32509-5000**

21 July 1992

Ms. Sally O'Forth
2336B Risher Court
Pensacola, Florida 32507

Dear Ms. O'Forth,

Did you know that NETPMSA Saufley Field maintains a Speakers Bureau listing capable public speakers who are knowledgeable on many academic, business and military subjects?

If you have had difficulty finding a qualified speaker to address a meeting of your organization, we maybe able to help.

As sailors, we can speak best about our mission of training young people in the U.S. Navy. However, we are also engineers, law enforcement experts, dentists, lawyers and similarly qualified professionals.

Our people work daily with modern methods of instruction, medicine, food preparation, vehicle utilization, maintenance, personnel management and budget planning.

Our speakers run the gamut of being young men and women fresh out of school to mature chief petty officers and staff officers who have served many years in war and peacetime assignments.

If our Speakers Bureau is of interest to you, please contact us at 452-9999, or write us a letter outlining your requirements on the enclosed form.

Sincerely,

URSULA R. MAJOR
Public Affairs Officer

Figure 6-22.-Letter soliciting speaking platforms.

engagement. Recommended procedures are discussed in the following text.

Policy Guidance

Check the speaking request against policy as stated in *PA Regs*. Your planning directive should reflect the guidance found in the *Regs* and provide an adequate measuring device to determine if a request is within the scope of the speakers bureau objectives.

Investigate the Group

If a request is received by telephone, always ask for a follow-up letter. Ask for information concerning the organization (if the data in your civic organizations files is incomplete) and the speaking engagement. Check out the organization to be sure it is not one before which military speakers are restricted from appearing.

Judge Worthiness

Based on the information obtained, determine if accepting the speaking engagement will be in the best interest of the Navy and afford benefits for the command.

Estimate the Speaking Situation

If a request is deemed worthy and within established policy and guidance, proceed with a detailed analysis of the audience, occasion and location. The civic organization files should be used, and any gaps filled in by the requesting organization.

Select and Clear the Speaker

Having estimated the speaking situation, select the speaker best qualified and make sure he will be able to accept the engagement. Have an alternate speaker prepared just in case. Notify the speaker in writing after checking his availability by telephone.

Accept the Request

When you have completed the previous analysis and assured yourself that the speaker can accept the engagement, notify the organization in writing. You may initially accept the request by telephone and follow with a letter. Provide the organization program chairman with a photograph and either a biographical information sketch (fig. 6-23) or a proposed introduction for the speaker.

BIOGRAPHICAL INFORMATION MYRA GANSET

Myra Ganset was born in Bronx, New York, where she received her high school education from Harry Vetch High School and her bachelor of science degree in computer science from Bronx Lebanon College. She received her master's degree in computer science from Norman's Kill University in Delmar, New York.

Mrs. Ganset taught high school in Queens, New York, before serving in her first government service assignment at the U.S. Coast Guard Station on Governors Island in New York Harbor. During her five-year tenure there, she earned three service excellence awards and garnered Civilian of the Year honors in 1977 for her innovative computer programming methods.

Following several government service assignments in the New York City area, Mrs. Ganset hosted the first syndicated radio talk show in New England dealing exclusively with computers. "Bits and Bytes" was in its eighth year when Mrs. Ganset assumed her computer programming duties at NETPMSA in June.

Mrs. Ganset and her husband live in Gulf Breeze with their nine children.

Figure 6-23.-Speaker's biographical information.

ASSISTING THE SPEAKER

The public affairs office that desires a truly effective speakers bureau must provide capable assistance to a speaker who has accepted an engagement. The following is a list of things for you to consider:

- Brief the speaker on the purpose of the speech, the importance of the engagement to the command, the value that can be derived and the benefit expected. Be sure he understands any special guidelines that apply to the speaking engagement.
- Help the speaker analyze the audience, occasion and location.
- Assist in selecting an appropriate topic and in narrowing the topic for the particular audience.
- Advise the speaker, if he so desires, on format, organization, sequence of ideas, support material, and so forth.
- Make sure the speech receives a security and policy review. Edit the speech as necessary for propriety.
- Provide an opportunity to critique the presentation in rehearsal.

- Provide assistance obtaining audiovisual devices and aids. It is sometimes necessary to train the speaker on setting up and operating the equipment. Assign an assistant if the speaker feels he will encounter difficulties operating the equipment and making the speech simultaneously.
- Provide the speaker with material that will prepare him to answer special questions not directly relevant to his subjects that maybe asked at the conclusion of his talk.

EVALUATION OF THE SPEAKING ENGAGEMENT

After the speech, attempt to determine the effectiveness of the presentation. Ask the speaker to submit a speaking engagement evaluation report (fig. 6-18) that should be sent with the speaking confirmation letter; request comment from the organization; request comment from military personnel who may have attended the presentation; and seek to attend various presentations yourself from time to time to make personal evaluations.

The public affairs office that is willing to expend the considerable effort required will reap immeasurable success from realizing the full potential of Navy speakers.

CHAPTER 7

NEWSPAPER STAFF SUPERVISION

Although most senior journalists are assigned to Navy Broadcasting Service (NBS) detachments or public affairs offices ashore or afloat, your career path may include a stint as a newspaper staff supervisor.

Navy newspapers are authorized publications that support command information goals. Usually, they are published weekly or monthly and contain most of the following elements: news, features, editorials, sports, announcements, entertainment items, commander's comments, letters to the editor, photographs and artwork.

As the editor or associate editor of a command newspaper, you will be responsible for providing an uncensored flow of news and information to—and among—sailors and civilian employees, their commanders and the five-part Navy internal audience described in Chapter 1. You will do this important task by supervising the entire operation of the newspaper—from making story and photography assignments to formulating a stylebook and making sure your staff follows it.

NEWSPAPER TYPES

Learning Objective: Recognize the types of Navy newspapers and identify the contracting concerns of a civilian enterprise (CE) newspaper selection committee.

Depending upon the arrangements in place at your command, your newspaper will be either **funded** or **civilian enterprise (CE)**. Several differences exist between the two newspapers that you must understand to become a successful newspaper staff supervisor.

FUNDED

A funded newspaper is published by a Navy command using appropriated funds, normally the public affairs allocation of a unit's operating fund. Installations and activities with at least 500 personnel, which can include the combined military and civilian work force (including tenant commands or embarked detachments), may produce a funded newspaper. Free from commercial advertising, the layout, design and editorial content of the funded newspaper are the responsibility

of the base newspaper staff (which is normally apart of the public affairs office).

The funded newspaper may be printed by a Navy Publications and Printing Service branch office, Stars and Stripes printing plant or a commercial publisher under contract by the Navy. You cannot use nonappropriated funds for any costs incurred in publishing an appropriated fund newspaper.

CIVILIAN ENTERPRISE

A CE newspaper is printed by a commercial publisher under contract with Navy commands. Unlike the funded newspaper, however, the CE newspaper contains advertising sold by the commercial publisher. The news and editorial content, as in the funded newspaper, are provided by the base newspaper staff. The CE newspaper is the property of the command, installation or intended recipient upon delivery. Commands cannot use appropriated or nonappropriated funds to pay for any part of the production costs incurred by the CE publisher.

Advantage

The main attraction of the CE newspaper is that it is published **at no cost** to the Department of the Navy. The publisher assumes all financial responsibility for the newspaper and offsets expenses by selling advertising space. All Navy commands are encouraged to establish CE newspapers whenever possible.

Contracting

The underlying reason for having a CE newspaper is it saves the Navy money by transferring certain publishing and distribution burdens to a civilian publisher selected by competitive bid. The PAO and senior journalist must have a basic understanding of how to setup a newspaper contract and must know the provisions of the contract.

In contract law, both parties to a contract must provide consideration as a part of the contract. The consideration is often the money and the product offered. Instead of money, the right and authorization to publish the unit newspaper are the legal contractual

considerations for CE newspapers delivered to the command, installation or its readership.

CE publishers get their financial earnings from the contract by selling and circulating advertising to the CE readership. Navy commanders with CE publications guarantee in the contract the rights to first publication and distribution of the editorial content.

While contracts should place as much of the publishing and distribution functions on the publisher as possible, command information needs and requirements are the primary factors in the contractual relationship.

The contract should be written to include the guidance contained in *PA Regs* and NAVPUBINST 5600.4 series (Ship or Station Newspaper/Civilian Enterprise (CE) Publications). It should spell out all of the local requirements and specifications of the publication. Contracts should only be established with reputable firms. Disreputable business activities involving a CE publication can damage community relations.

CE publishers must abide by the Department of the Navy's nondiscrimination advertising policy. The following statement must be used in CE publications:

"Everything advertised in this publication shall be made available for purchase, use or patronage without regard to race, color, religion, sex, national origin, age, marital status, physical handicap, political affiliation or any other nonmerit factor of the purchaser, user or patron."

If a violation or rejection of this equal opportunity policy by an advertiser is confirmed, the publisher must refuse to print advertising from that source until the violation is corrected.

SELECTION COMMITTEE.— *PA Regs* and NAVPUBINST 5600.4 series states that a selection committee must choose a publisher for Navy CE newspapers. The committee chair must be a senior member of the command, but may not be the PAO. The PAO and the senior journalist should serve as nonvoting committee members to provide technical advice on publishing needs and contract stipulations. Other committee members include the staff or command judge advocate, contracting officer, printing representative and other specialists with skills appropriate to the selection and contracting process.

The selection committee hears presentations and reviews written data from prospective commercial publishers, gathers independent data and makes on-site inspections. The committee may award a one-year contract with annual options for renewal for up to four years, for a total of five years. Contracts must be rebid after this time frame. Contracts should contain provisions for termination.

INCLUSIVE ITEMS.— At a minimum, the following points should be included in a CE newspaper contract:

1. **Frequency of publication.** Determine whether the command will be best served by a weekly, biweekly or monthly publication.

2. **Number of copies.** Determine how many copies will be needed to serve the intended audience. Normally, at least one copy per five readers (1:5 ratio) is the minimum. If your audience (including civilian employees and family members) numbers 8,000, the minimum number of copies required would be 1,600. The ideal is 1:1, but costs may dictate a 1:2, 1:3 or higher ratio. Make sure the contract calls for the printing of more or fewer copies whenever the commander determines a need based on gains or losses of personnel. If gains or losses are expected—due to an influx of reservists for training or departure of a major unit for an exercise, for example—determine when the press run must be increased or decreased, and by how much.

3. **Number of pages per issue.** A minimum and maximum number should be set. The maximum will depend on advertising and the availability of editorial copy. However, the amount of advertising should not force the public affairs staff to produce more editorial copy than needed to meet the command information mission.

4. **Publication day or dates.** Determine what day of the week or month the paper should be published. Make sure that provisions are made for distribution when a publication day falls on a holiday.

5. **Restrictions on the use of the publication's name.** Make sure the publication's name remains the property of the command and is not copyrighted or registered as a trade name by the publisher.

6. **Editorial sources.** Make sure the contract clearly states that all news stories, photographs, features, headlines and all other editorial matter are to be provided by the newspaper staff (public affairs office) and are subject to the PAO's approval.

7. Production responsibilities. Establish it as the publisher's responsibility to paste-up the newspaper, subject to the supervision or direction of the newspaper or public affairs staff. In some cases, the publisher may provide the capability for electronic data transfer via floppy disk or via a telephone modem, and perhaps provide the equipment to lay out and design the newspapers using an electronic, computerized page maker system.

8. Advertising-editorial ratio. Make sure the contract sets a maximum and minimum ratio of advertising-to-editorial space. *PA Regs* stipulates the amount of advertising content (in column inches) will not exceed 60 percent of the total newspaper. Provisions may be included to increase the ratio for heavy advertising seasons, such as Christmas or Easter. Also, make sure the contract includes a provision to leave several pages free of ads. Normally, page one, the editorial page, the double truck, the lead sports page and at least one additional news page are left ad-free. If the paper is published in sections, the front page of each section is normally ad-free.

9. Advertising placement. Determine whether "blocked" or "pyramided" ads best suit your needs, and make sure the contract stipulates how ads will be displayed. Also, spell out minimum column widths acceptable for editorial use. This will prevent being left with narrow (fewer than 12 picas, for example) columns created by odd-sized ads. Stipulate that filling such odd-sized columns will be the responsibility of the publisher.

10. Advertising policy. Make sure the contract guarantees the publisher will accept no advertising that is discriminatory, in poor taste, is untruthful or otherwise in violation of *PA Regs*. Be sure that the contract provides for PAO approval of questionable ads.

11. Deadlines. The contract should list the deadlines for the delivery of dummies to the PAO, for the submission of editorial matter and for distribution. Additionally, make sure the contract spells out how deadlines will be adjusted when they fall on a holiday.

12. Distribution. Make sure the contract clearly defines it as the publisher's responsibility to distribute the publication. The contract should identify where copies are to be delivered and in what quantities; for example, the public affairs office, commissary, bowling alley, Navy Exchange, cafeterias and housing areas. The contract should also stipulate where the publication is not to be distributed. Usually, CE publications are not

distributed outside the intended audience or outside the installation.

13. Disclaimers. Include a section on the wording, location and the point size of the masthead and disclaimers required by *PA Regs*.

14. Special editions. If special editions are expected, their specifications should be defined in the contract. If none are expected, it is a good idea to include a clause that makes special editions an option.

15. Color. Minimum color requirements-spot or processed-should be set in the contract. The publisher should be obligated to let the public affairs staff know when color ads make additional color available for editorial use.

16. Typeface selection. The contract should guarantee the public affairs staff a choice of the publisher's selection of typefaces and point sizes. Minimum and maximum point sizes should be established in the contract.

17. Special devices or services. Make sure the contract states that it is the publisher's responsibility to provide materials or services for such devices as boxes, column rules, screens, initial letters, and so forth.

18. Termination for cause. Make sure the contract also provides for termination for cause whenever the products or services to be provided are not satisfactory or when contract provisions are not met.

PUBLISHERS' VISITS.— Conduct a site visit to all publishers being considered before making a final selection recommendation. Examine the facilities and equipment at the sites and talk to the people with whom the public affairs staff will work. Look, too, for general cleanliness and a safe work environment.

GATHER DATA.— Gather independent data to determine whether the publishers are reputable, reliable and competent. The Better Business Bureau, chamber of commerce and current or former clients of the publisher can provide valuable information.

SPECIAL SERVICES.— Consider any special services the potential publisher may offer, such as on-line text editing systems, pagination or computer facilities. These are allowed to be placed in the newspaper staff or public affairs office if all costs are absorbed by the publisher. (Floppy disks, printer ribbons, paper and other associated consumables are normally the responsibility of the newspaper staff.) The publisher may also assign a writer or two to your editorial staff. Be sure to check on this.

NEWSPAPER ESTABLISHMENT

Learning Objective: *Recognize the rules governing the establishment of CE and funded newspapers.*

Commanders are encouraged to establish Navy newspapers when the following two conditions exist: (1) they have a valid need to disseminate information and (2) a newspaper is the most cost-effective means of fulfilling the command's communications need.

Normally, only one Navy newspaper is permitted at a location where more than one command or headquarters is co-located. This rule does not apply to ships, as each ship may have its own newspaper. When more than one command or headquarters is at an installation (for example, a naval air station with several tenant commands), the host commander will publish one newspaper to cover all assigned units and activities. In this instance, the following requirements must be met:

- The host commander gives balanced coverage to other commands, their people and activities.
- Commands supported by the host newspaper provide the newspaper staff with coverage of their units. These units should assign its public affairs representatives to act as stringers to the newspaper. The stringer method of news gathering will be explained later in this chapter.

In some cases, the host commander appoints another command to publish the single authorized newspaper when the majority of resident organizations agree. Commanders (other than the installation commander) who want to establish their own newspapers must first request authority from their major commands as an exception to policy. Requests must be submitted through the installation commander and approved in writing before publication can begin. Forward copies of approved exceptions to CHINFO.

JOURNALISM EXCELLENCE

Learning Objective: *Identify the elements needed to maintain the degree of journalism excellence required in CE and funded newspapers.*

Navy newspapers are expected to display the highest standards, of journalistic techniques and ideals. Navy newspapers should provide their readerships with a quality product. Excellence should be the goal of every phase of newspaper production—content, design, organization, photography, reporting, writing and editing.

Content should be relevant, factual, objective, frank and timely. Content and graphics must avoid morbid, sensational or alarming details not appropriate to factual reporting. As the newspaper staff supervisor, you must make sure the highest regard for decorum, propriety and good taste is followed.

STYLEBOOKS

A newspaper's style should be consistent. To accomplish this, you should adopt the latest edition of *The Associated Press Stylebook and Libel Manual* as your primary stylebook. The stylebook may be purchased through a local bookstore or directly from The Associated Press.

Some newspaper editors find it necessary to supplement the "AP Styleguide" with a locally produced stylebook. This stylebook may include some of the following items that are unique to the newspaper:

- Phrases
- Word division
- Capitalization and punctuation rules
- Copy format
- Acronym usage
- Headline styles
- Outline and caption styles
- Datelines styles
- By-lines and photo credits
- Ship or aircraft squadron designations
- Computer usage procedures

Be sure to ask for staff input before settling on the content and format of your stylebook.

DICTIONARY

Webster 3 New World Dictionary of the American Language (Third College Edition) should serve as the newspaper staff's dictionary of first reference, as indicated by The Associated Press. Be sure to address this area in your stylebook.

COLOR PHOTOGRAPHY

All photos could be in color, but the cost for a four-color press run is often prohibitive on a routine basis. The use of spot color and four-color processes in

funded publications must be functional, making a valuable contribution to the publication. You should be sensitive to the price involved and make sure color contributes to the communication process.

Color usage in CE publications is limited only by contract and the CE printer's ability to make color available.

EDITORIAL COMMENT

Editorial opinion must be confined to clearly identified editorial columns. Encourage opinions, editorials and commentaries. Editors should welcome letters to the editor, guest commentaries, man-on-the-street interviews and columns on editorial pages.

When statements of opinion (other than letters to the editor or man-on-the-street interviews) present material in conflict with Navy or command policy, the following editor's note should be used at the end of the article:

“Opinions expressed herein are those of the writers and not an official expression of the Department of the Navy or of this command.”

CREDIBILITY

Remember reading about credibility in Chapter 1? These principles also apply to the newspaper business. Every aspect of Navy journalism must lend itself to gaining and maintaining credibility. Attribution is essential to credibility. Opinion and information sources must be attributed.

NEWSPAPER STAFF ORGANIZATION

Learning Objective: Identify the staff organization of a Navy newspaper, how assignments are made, the training scheduled by the supervisor, the use of credentials and the content and frequency of readership surveys.

A prototypical Navy newspaper staff organization does not exist because manning situations vary among Navy public affairs offices. For instance, a large funded newspaper ashore may have a JO1 or JOC serving as the editor, with a JO2 assuming the responsibilities of associate editor or managing editor. The staff may include two or three JO3s or JOSNs and a PH3.

Conversely, a similar newspaper on a different coast may have a JO1 and a JOSN or PHAN tackling the many responsibilities of newspaper production.

The organization of a large Navy CE newspaper staff further illustrates this diversity. The senior journalist rarely serves as the editor. A government service employee or a civilian employed by the publisher fills this slot, while the JO1 or JOC assumes the role of associate editor. Two or three additional government service employees may serve as writers or photographers; another civilian, provided by the publisher, may supplement the staff. A JO3 and JOSN usually rounds out the staff.

A smaller CE newspaper staff may have a civilian editor, a JO1 or JOC as associate editor and only one or two additional military or civilian writers.

Regardless of your particular manning situation, you can use the chart in figure 7-1 to guide you in structuring your CE or funded newspaper organization.

What are the different positions within a CE or funded newspaper staff? Figuring in a degree of variation, the staff organization can include the following positions and components: (1) editor, (2) associate editor, (3) sports editor, (4) leisure editor, (5) general assignment writers, (6) classified ads and (7) cartoonist.

EDITOR

The editor is responsible for the entire editorial content of the newspaper and its inherent administrative concerns. Some of the duties handled by the editor include the following:

- Working closely with the publisher to set up a schedule of delivering layouts, copy, photographs and art for printing
- Making sure the quality of the paper is consistent from issue to issue
- Coordinating the distribution of the newspaper with the publisher
- Answering inquiries from individuals requesting coverage of events
- Reviewing stories, headlines, captions and cutlines for adherence to *The Associated Press Stylebook and Libel Manual* and the locally produced stylebook, and for completeness and accuracy
- Making story and photograph assignments (in consultation with the associate editor)
- Proofreading the blue line (explained later)

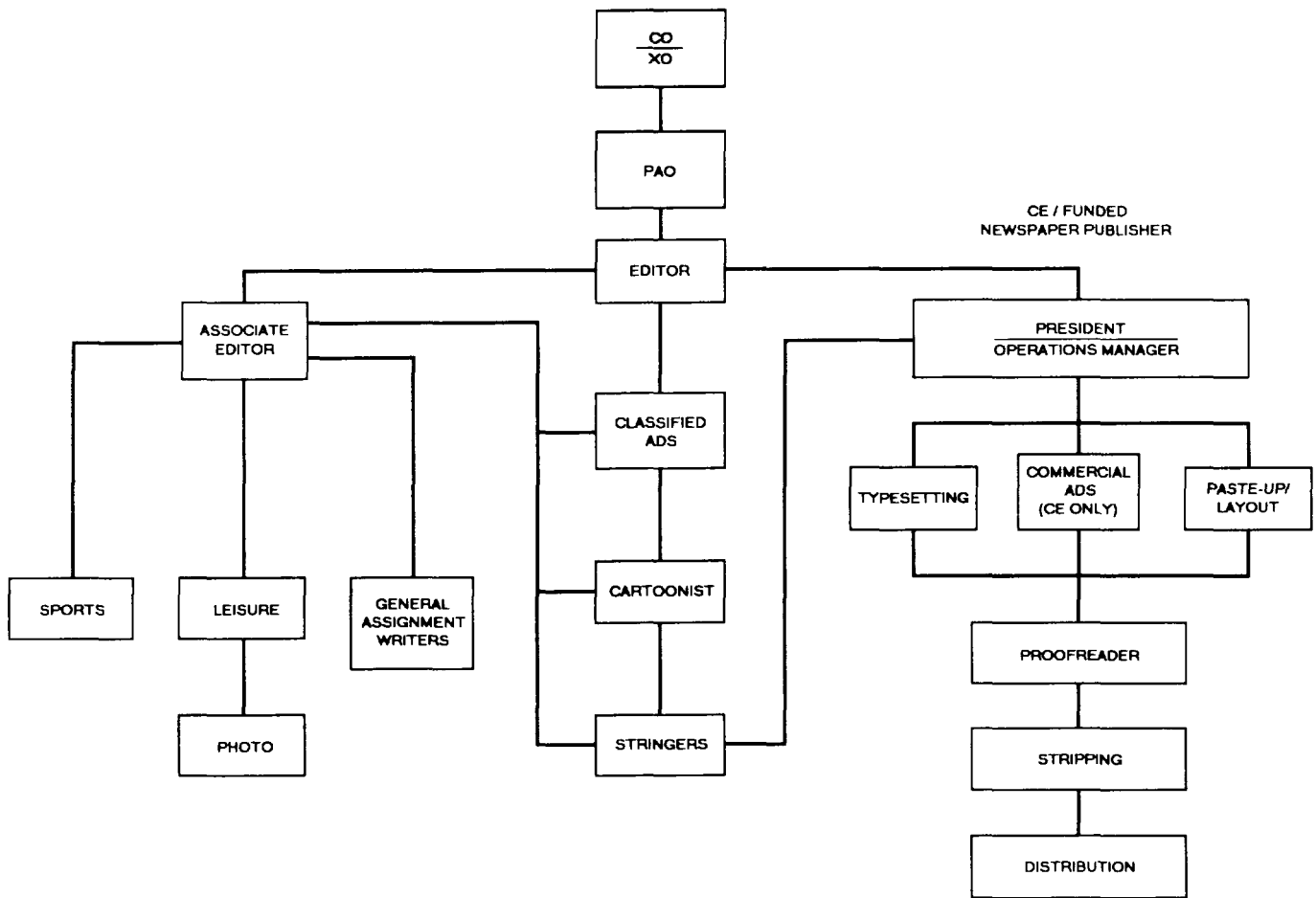

Figure 7-1. Possible organization of a CE or funded newspaper.

- Developing and implementing a professional training program
- Maintaining staff administrative records (training, evaluations, etc.)
- Serving as a reporter and photographer, as necessary

The editor must know the entire operation of the newspaper, including the key functions of the publisher (typesetting, commercial ads, paste-up, layout, proofreading, stripping, etc.). If the editor of a CE newspaper cannot field a simple telephone question about distribution locations or basic advertising rates, the caller will probably hang up with the perception that “the editor does not even know what is going on with his paper.”

Editors of CE and funded newspapers must maintain a good relationship with their counterparts at the publisher. This pays big dividends, especially when late-breaking stories (such as an accident or incident) warrant last-minute changes.

ASSOCIATE EDITOR

The associate editor (also called the managing editor) is the editor’s number one assistant. He handles the day-to-day operations of the newspaper that includes the following functions:

- Making story and photographic assignments
- Assigning pages for layout
- Supervising other editors (sports, leisure, etc.) and staff writers
- Accepting or rejecting story ideas or assignments
- Reviewing stories, headlines, captions and cutlines for adherence to *The Associated Press Stylebook and Libel Manual* and the locally produced stylebook, and for completeness and accuracy
- Serving as writer and photographer
- Making page layouts

- Cropping photographs

In following the cross-training philosophy in Chapter 1, the associate editor must be able to handle his duties and those of the editor, in case the editor is unavailable because of leave, training, TAD, sickness or other circumstances.

Note in the previous lists that, in addition to regular duties, the associate editor makes page layouts, crops photographs and serves as a writer and photographer, while the editor writes and takes photographs as needed. This should be a staff requirement for two reasons. First, it would be inappropriate for the editor and associate editor to isolate themselves from the command and community by just administering the newspaper staff. Subordinate editors and the regularly assigned staff writers need a certain amount of “face time” to establish their contacts and credibility. This is also true with the editor and associate editor.

Second, the editor and associate editor must continuously strive to improve their layout, cropping, writing and photography skills. Nothing is more of an injustice to the newspaper staff than an editor or associate editor who becomes complacent because of his position of authority. Direct involvement in the aforementioned areas will improve the overall quality of the newspaper and serve as a secondary staff training method.

SPORTS EDITOR

As the name implies, the sports editor is responsible for all facets of the sports pages—gathering and editing news, taking photographs, making page layouts, writing headlines, cutlines and captions and cropping photographs. Most sports editors set up a system of gathering base sports news (scores, statistics, game highlights, names of key players, and so on) with the Morale, Welfare and Recreation (MWR) manager. This is a necessity in most Navy newspaper staffs because the sports editor normally does not have regularly assigned sports writers working for him.

Typically, the sports editor is a civilian employee or a JO2. This one-person operation, in addition to regular responsibilities, stays busy writing news and feature stories, designing page layouts and taking photographs for other newspaper sections as directed by the associate editor.

LEISURE EDITOR

The leisure editor follows virtually the same guidelines as the sports editor. Again, a good contact at the MWR office is needed to maintain a good flow of leisure-related information.

GENERAL ASSIGNMENT WRITERS

The general assignment writers are your junior staff members (JOSNs and JO3s) who are honing their news writing, reporting, photography, layout and cropping skills. Remember, the publisher of a CE newspaper may assign a civilian or two to the staff. They may serve the staff as general assignment writers. General assignment writers are detailed by the associate editor as needed.

CLASSIFIED ADS

Classified ads are listings of personal items and services for sale by members of the command. The associate editor may assign the duty of gathering and editing classified ads to general assignment writers on a rotating basis.

Large CE newspapers may contain between 200 and 250 classified ads per issue (depending on the frequency of publication), while funded newspapers may run between 100 and 150 per issue.

Although classified ads are normally offered free of charge, one innovative CE newspaper staff ran a survey to see if its readership would favor a one-dollar charge for each classified ad, with all proceeds going to the local MWR fund. The response was positive, and the MWR fund, besieged by a series of budgetary cuts, collected more than \$12,000 in the first year of the new system. A by-product of this partnership was the assistance MWR provided in gathering and organizing the classified ads before they were sent to the newspaper staff for final review. This allowed the associate editor more latitude in making staff assignments.

CARTOONIST

It is rare for an illustrator draftsman to be a member of a CE or funded newspaper. To compensate, editors and associate editors may run Plan of the Day or Week notes or short articles requesting assistance from volunteer cartoonists. More often than not, several responses will come in from cartoonists of different skill levels.

In Chapter 1, you were cautioned about the use of volunteers in managing a public affairs office. This rule also applies in newspaper staff supervision. Carefully screen each volunteer and do not count on consistent contributions.

If you cannot enlist the services of a part-time cartoonist, the monthly Navy Editor Service (NES) contains a wide variety of line art you can use. Order NES from the Navy Internal Relations Activity (NIRA) in Washington, DC. It is not provided unless requested.

PHOTOGRAPHY

Most CE or funded newspaper staffs can get limited photographic support from the base imaging facility. However, the availability of funds and personnel will dictate just how much support you can receive. With this in mind, it is absolutely imperative that every newspaper staff member use and practice basic photography skills.

Even if the imaging facility can provide limited support to your staff, you must make sure your staffers are given the opportunity to supplement their stories with their own photographs. Above all, do not subscribe to the theory that the imaging facility is your catch-all "safety net." Make sure your newspaper is as self-sufficient as possible in photography.

Depending on the available public affairs funds, you can take this a step further by setting up a small photo lab right in your office.

MAKING ASSIGNMENTS

Because the associate editor is responsible for the day-to-day operations of the newspaper, the task of making story and photographic assignments also falls on his shoulders.

After identifying an assignment with the editor, the associate editor should consider the jobs in progress (stories, layouts, photography, etc.) and any additional factors (leave, TAD, sickness, training, and so on) before assigning a job to an individual. The goal here is to spread the newspaper workload as evenly as possible so no one is backed up to a point of stagnation.

Some associate editors verbally inform each staff member of a new assignment. You can improve upon this method by using the staff assignment sheet shown in figure 7-2. You can continue to give your verbal instructions to the writer or photographer, but now he has a tangible record to fall back on if a question comes up. This will eliminate repeating the assignment instructions several times, which can lead to misinterpretation.

ASSIGNMENT SHEET	
REPORTER:	
PHOTOGRAPHER:	
DATE:	TIME:
ASSIGNMENT:	
CONTACT:	
BLDG. NO.:	TELEPHONE:

Figure 7-2. Reporter assignment sheet.

After making the assignment, the associate editor writes it on the master assignment sheet, which should be placed in a central location in the editor's office. The master assignment sheet can be designed like the one shown in figure 7-3. If you prefer a larger format, you can convert the sheet to a master assignment board using a chalkboard, dry marker board or a large piece of plastic or plexiglass. In offices with LAN word processing computer systems, assignments can be listed (without paper) in a master document via electronic mail.

COPY LOG

The associate editor should maintain a copy log, similar in format to the master assignment sheet. The copy log, however, is a list of stories already done and ready for layout in the paper.

TRAINING

The training (and cross-training) considerations discussed in Chapter 1 apply to your newspaper staff as well. Cross-train your editors (sports, leisure, classified ads, and soon) about once a year. Make sure the sports editor, in addition to writing sports stories, is given several opportunities to write straight news stories during his tour in the department. Similarly, the leisure editor should be competent in news and sports writing. It is important that you make cross-training a habit.

NEWSPAPER STAFF CREDENTIALS

Issue credentials to all newspaper staff members. A typical credential consists of a black-and-white photograph with the individual's name, organization

 ASSIGNMENTS			
<i>ASSIGNMENT</i>	<i>REPORTER</i>	<i>ASSIGNMENT DATE</i>	<i>PUBLICATION DATE</i>

Figure 7-3. Master assignment sheet.

and expiration date. The credential should be signed by the PAO or CO. Like their civilian counterparts, your staff members need credentials for identification purposes when covering events on and off base.

READERSHIP SURVEYS

CE and funded newspaper staffs must conduct a readership survey at least once every two years. If the newspaper has undergone recent major editorial or style changes, then a survey must be conducted within two to four months of the changes. The survey should provide data on distribution effectiveness, readership awareness and acceptance, and readership opinion of the value and effectiveness of the publication. Also, the survey should provide trend data. *PA Regs* specifies that you must report the results of the survey to the readers, which may be done in summary form. Further information on surveys can be found in Chapter 9.

NEWS GATHERING METHODS

Learning Objective: Identify the methods of gathering news for a CE or funded newspaper.

When gathering news, most CE or funded newspaper staffs are stretched to the limit. You can only interview a certain number of people and write a certain amount of stories between copy deadlines. Figure in the newspaper staff duties previously described, and you will quickly realize that you and your subordinates must optimize your time and enlist the help of others in gathering news. You can do both by using the beat and stringer systems and by maintaining a morgue.

BEAT SYSTEM

Consider establishing a beat system if you determine your news coverage can be improved. If one is already in place, look at changing it. Beats are divided into two sections: geographical area and functional area.

Geographical Area

Each staff writer is assigned a section of the command (northeast sector, southeast sector, northeast sector, southwest sector, for example). He is then responsible for all the news in his area, whatever the subject.

Functional Area

A reporter is assigned a subject (sports, leisure, health, pay and benefits, youth activities, training, etc.) and is responsible for stories about that subject, no matter where they are found. This system also can be used to assign reporters to cover specific units or agencies.

Select a beat system by considering the size of the command or installation and the size of the staff. You can figure in the interests and abilities of your writers; however, sound cross-training practices dictate that you do not allow them to specialize for the duration of their tours. A cross-trained staff gives your newspaper more depth and expertise.

Brief your staff members on their responsibilities. Make sure they know their beats, the importance of establishing and maintaining contacts, the need to check with contacts regularly and the importance of being polite, punctual and professional.

STRINGER SYSTEM

Consider using the stringer system if your newspaper staff is undermanned or if you must cover remote areas or detached units. If a stringer system is already in place, determine whether production is adequate and if the stringers are properly trained.

If you want to use a stringer system, you should solicit potential stringers through ads in your newspaper, through unit commanders or any other suitable method. Start a training program for new or existing stringers in need of training, using the *Handbook for Stringers in the Armed Forces*.

Stringers may be enlisted members, officers or civilian employees willing to work without pay for the newspaper. Stringers, at minimum, should be trained to call in news tips. To do this, they must know what types of stories are sought, understand deadlines and know how to gather the basic Who, What, When, Where, Why and How. If they provide written copy, they should know, at a minimum, the following items:

- The importance of double checking name spellings and other factual information
- The structure and organization of a news story
- The technique of writing clearly and concisely
- The requirements of attribution

Once a stringer system is in place, provide feedback to the stringers in the form of recognition for good work and constructive criticism that will help them improve. A by-line in the paper is the best payment a stringer can receive.

MORGUE

The morgue, at a minimum, should be a file of back issues of your newspaper for the past year. The morgue serves as a collection of back stories that a staff writer can refer to when doing similar stories for upcoming issues. It also can provide background and depth for upcoming stories. A good morgue can often save a writer hours or days of research.

PRINT SELECTION

Learning Objective: *Outline the procedures for selecting prints for publication.*

There is more to selecting prints for publication than simply picking the pictures that communicate best. Many an editor has found himself in hot water because he did not look at a picture long enough or close enough to see a hidden “land mine.”

INITIAL STEP

When selecting prints for publication, you should first narrow down the field. Identify and eliminate what are considered unusable prints; out-of-focus, over- or underexposed and poor composition photographs are among the obvious eliminators.

Base your photograph selections on print quality and cutline information. When feasible, check both the contact sheets and the prints made from them when selecting photographs.

CONTACT SHEET SELECTION

Using a magnifying glass, look for the best negative to support the story on the contact sheet. Keep these rules in mind when you examine the contact sheet:

- The photograph should be composed to follow the “rule of thirds.” In the rule of thirds, the intersection of lines that divide the picture area into thirds (fig. 7-4) are good locations for the center of interest in most photographs. (Make sure there is only one center of interest to a picture. Keep it simple.)

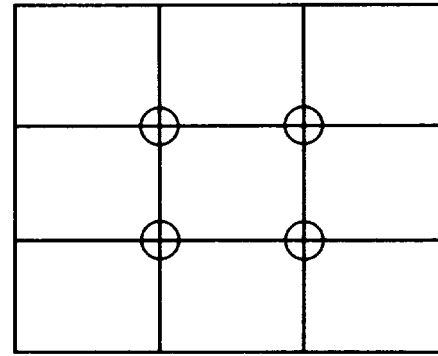

Figure 7-4.-Rule of thirds.

- Analyze the lines of force, directions toward which the subject is moving or looking and the points of interest.
- Make sure the subject is identifiable in at least a three-quarter frontal view. Eyes should be open and looking at the point of interest.

Do not select photographs that show sailors out of uniform, not neatly groomed, drinking alcoholic beverages, in classified areas or settings and in poses that make the sailor appear less than professional. Also, avoid using pictures of handicapped people or hospital patients without their consent (a signed patient release form).

READ THE STORY

If you are selecting one photograph to accompany a story, read the story and select a photograph that can stand alone and tell as much of the story as possible. The picture should capture the essence of that story. If you are selecting several photographs, again read the story for content, thrust and emphasis. All photographs should complement the story and entice someone to read it. The photographs must directly relate to the story.

SELECT THE PRINT

The final photograph selection stage is a good opportunity to catch deficiencies not noticed when reviewing the contact sheet. For example, the following background problems may surface:

- Obscene gestures, people in embarrassing situations, safety violations and security, policy and propriety violations
- Sailors sleeping in, under or on a piece of equipment

Family, friends, squadron mates mourn loss of VT-4 instructor

A memorial service was held earlier this week at the Naval Aviation Memorial Chapel for Lt. Thomas Douglas Waterbury. The VT-4 flight instructor was killed April 15, during carrier operations in the Gulf of Mexico, approximately 70 miles south of Pensacola.

The 28-year-old naval officer was a resident of Little Silver, N.J., and a 1985 graduate of the U.S. Merchant Marine Academy at Kings Point, N.Y.

According to Navy officials, Waterbury and another pilot from VT-19, NAS Meridian, Miss., crashed after their T-2C Buckeye jet trainer was launched from the USS Forrestal.

Both aviators ejected, but rescuers were only able to find one pilot.

Several hundred people, including Lt. Waterbury's family, Vice Adm. Jack Fetterman and former Pensacola Mayor Vince Whibbs, were on hand to pay their final respects to the man VT-4 Commanding Officer Cmdr. Pat Tilley described as "full of compassion and a love for life." Following the ceremony, a flight of four T-2s passed overhead in a "missing man" formation.

Prior to reporting to VT-4 in May 1991, Lt. Waterbury had served as an E-2 pilot with VAW-117 at NAS Miramar, Calif.

LL Thomas D. Waterbury
1963-1992

Gosport

Vol. 56, No. 16

Serving the Cradle of Naval Aviation Pensacola, Florida

April 24, 1992

Corry Station instructor picked as CNET SoY

By Ens. Eric R. Dolan
CNET Public Affairs

CTT1 James H. Henderson Jr., an instructor assigned to NTTC Corry Station, was recently selected as the CNET Sailor of the Year.

In presenting the master training specialist with the CNET Sailor of the Year plaque, Vice Adm. Jack Fetterman, Chief of Naval Education and Training said, "Collectively, all our candidates have gone above and beyond. They are Sailor of the Year nominees because they simply enjoy what they are doing."

One of five finalists competing for the prestigious title, Petty Officer Henderson credited his winning philosophy to his father. "Winners make it happen. Losers watch it happen," he told those present for the Sailor of the Year banquet.

A native of Covington, Ky., Petty Officer Henderson is an assistant company commander and instructor in the Cryptologic Training Department's Basic School. As an instructor in the school he was instrumental in 14 students winning the prestigious Samuel F.B. Morse Award prior to his selection

CTT1 James H. Henderson is presented with a plaque naming him CNET Sailor of the Year by Chief of Naval Education and Training, Vice Adm. Jack Fetterman.

as the CNET Sailor of the Year, Petty Officer Henderson was selected as the Chief of

Naval Technical Training Command's Sailor of the Year.

Henderson will now go on to compete for the title of Chief of Naval Operations Sailor of the Year. The CNO Sailor of the Year competition will be held in Washington, D.C., next month.

Other nominees for CNET Sailor of the Year were:

DS1 Joseph F. McClelland Jr., representing the Commander, Training Command, U.S. Atlantic Fleet. McClelland is an instructor at the Fleet and Mine Warfare Training Center, Charleston, S.C.

OS1 David A. Pearson, representing the Commander, Training Command, U.S. Pacific Fleet. Pearson is a master training specialist for the Air Control Division, San Diego.

L11 David P. Nesbitt, representing the Chief of Naval Air Training Command, NAS Meridian, Miss. Nesbitt is assigned to the NAS Meridian Legal Office.

HM1 Lynn C. Martin, representing Naval Education and Training Direct Reporters, Pensacola Naval Hospital. Martin is leading petty officer of the Branch Medical Clinic

Orange Park school captures NJROTC Field Day crown

By Gregory P. Stallworth
CNET Public Affairs

Approximately 360 high school students participated in the second annual Navy League National NJROTC Field Day Championship held last weekend aboard NAS. Participating cadets represented nine of the top NJROTC drill teams from New Jersey, New York, Virginia, North Carolina, Georgia, Florida, Mississippi and Texas. The event, sponsored by the Pensacola Chapter of the Navy League of the United States, encompassed two days of rigorous military drill, athletic and academic competition.

Activities came to a dramatic ending with an awards ceremony held at the Naval Aviation Schools Command parade grounds, presided over by Rear Adm. Louise C. Wilmot, Vice Chief of Naval Education and Training. Parents stood on the side lines wearing proud smiles as the cadets stood in rigid formation anx-

iously waiting for the announcement of winners. Loud cheers greeted the announcement awarding the overall championship to the unit from Orange Park High School, Orange Park, Fla.

"We're extremely proud to have won," said Cmdr. Charles Lusk, Naval Science Instructor at Orange Park High School. "Our success can be attributed to the dedication and hard work that all of our students put forth. The competition was tough, but our team effort put us over the edge."

Recognizing the NJROTC program as a means to starting a successful career, one Orange Park High School student said being a part of NJROTC is one of the most rewarding things he has ever done. It's an organization that his parents fully support.

"NJROTC has opened a lot of doors for me that I probably would have never been able to open by myself," Cadet Michael Klappmeyer

said. "Since the very start, my dad loved the idea of my being a part of the program, but my mother was a little skeptical at first. Now that she has seen what the program is really about, she likes it and is really getting into it." He added that through NJROTC he has been awarded a four-year NROTC college scholar-

ship which he plans to use at Auburn University, Jacksonville University or the Illinois Institute of Technology.

The unit from Middleburg High School, Middleburg, Fla., placed second, while the cadets from George Washington High School, Danville, Va., placed third.

Rear Adm. Louise Wilmot, Vice Chief of Naval Education and Training, congratulates NJROTC cadets on their winning performance during last week's Field Day Championships.

Published by Pensacola Engraving Company, a private firm in no way connected with the Department of the Navy. Opinions contained herein are not official expressions of the Department of the Navy nor do the advertisements constitute Department of the Navy or NAS Pensacola endorsement of products or services advertised.

Figure 7-5. Sample CE newspaper galley proof.

Do not select a photograph for publication that might cause embarrassment to the subject or command. Depending on the nature of the event, use extreme caution when selecting photographs for publication.

CUTLINE INFORMATION

Check the cutline information with the photograph. Each of the five W's and H that can be answered must be answered. Check the spelling of names, position titles, nomenclature of equipment and other facts. Make sure individuals are clearly and consistently identified and that the cutlines are formatted according to the rules outlined in your local stylebook.

PROOFREADING GALLEY PROOFS AND BLUELINES

Learning Objective: *Recognize the importance of proofreading galley proofs and bluelines as a staff function.*

As you read in *JO3 & 2*, proofreading is one of the final steps in the printing process of the newspaper.

After the publisher typesets your copy, he will return it to you with a set of galley proofs. Galley proofs, for the purpose of this chapter, are photocopies of the actual pages of the newspaper, including headlines, copy, cutlines, captions and artwork. Photographs and ads (in CE newspapers) will not appear on the galley proofs, but the publisher will indicate their positions. In the CE and funded newspaper business, these first copies are called "whites" (fig. 7-5). Your particular deadline structure will determine the days in which you will receive the galley proofs.

Regardless of the deadlines in place, make sure the galley proofs are thoroughly proofread by all staff members. Granted, proofreading is a tedious facet of newspaper production, but it is well worth it when you catch a typographical error, misaligned column or other mistake (no matter if your staff or the publisher is to blame) before it ends up in print.

Have your staff members initial each galley proof after proofreading. When all the pages have been reviewed, go through them yourself one more time, then call or visit the publisher and give him the changes.

The final proofreading step involves the "blues," or blueline (fig. 7-6). The blueline is a replica of the newspaper in reverse and is similar in appearance to a blueprint. The size of the publisher's press determines whether the blueline is in eight or 16-page signatures.

This is your last chance to make corrections before the plates are made and the newspaper is printed and distributed. Most publishers will not mind a small amount of blueline corrections. However, this is not the time to make wholesale changes. The bulk of the corrections should have already been made on the galley proofs. If an accident or incident requires a sizeable change of the blueline, the publisher will normally accommodate the necessary changes. Remember, the amount of cooperation you receive depends largely on the relationship you have fostered with the publisher.

Closely scrutinize the blueline. It is a good idea to bounce the blueline against the galley proofs for the most comprehensive check possible. Make sure folio lines, by-lines, cutlines, tag lines and page numbers are on the pages and are correct. Look for the following errors:

- Reversed or upside-down photographs and art
- Photographs and cutlines or captions that do not match
- Headlines that do not match stories
- Smudges or stray markings that might reproduce

Because of time constraints, the publisher may ask you to proof the blueline at the printing plant.

DESKTOP PUBLISHING

Learning Objective: *Define desktop publishing and identify its hardware and software requirements.*

There is a technological innovation in newspaper production that is changing the way words are put on paper. This innovation is called desktop publishing.

Desktop publishing (also known as electronic publishing and electronic makeup) refers to the use of a microcomputer (personal computer) to compose and print newspapers, documents and other publications. It is a process that encompasses design, composition, page makeup and document reproduction. By combining the microcomputer with desktop publishing software, you

Family, friends, squadron mates mourn loss of VT-4 instructor

A memorial service was held earlier this week at the Naval Aviation Memorial Chapel for Lt. Thomas Douglas Waterbury. The VT-4 flight instructor was killed April 15, during carrier operations in the Gulf of Mexico, approximately 70 miles south of Pensacola.

The 28-year-old naval officer was a resident of Little Silver, N.J., and a 1985 graduate of the U.S. Merchant Marine Academy at Kings Point, N.Y.

According to Navy officials, Waterbury and another pilot from VT-19, NAS Meridian, Miss., crashed after their T-2C Buckeye jet trainer was launched from the USS Forrestal.

Both aviators ejected, but rescuers were only able to find one pilot.

Several hundred people, including Lt. Waterbury's family, Vice Adm. Jack Fetterman and former Pensacola Mayor Vince Whibbs, were on hand to pay their final respects to the man VT-4 Commanding Officer Cmdr. Pat Tilley described as "full of compassion and a love for life." Following the ceremony, a flight of four T-2s passed overhead in a "missing man" formation.

Prior to reporting to VT-4 in May 1991, Lt. Waterbury had served as an E-2 pilot with VAW-117 at NAS Miramar, Calif.



Lt. Thomas D. Waterbury
1963-1992



Vol. 56, No. 16

Serving the Cradle of Naval Aviation Pensacola, Florida

April 24, 1992

Corry Station instructor picked as CNET SoY

By **Ens. Eric R. Dolan**
CNET Public Affairs

CTT1 James H. Henderson Jr., an instructor assigned to NTTC Corry Station, was recently selected as the CNET Sailor of the Year.

In presenting the master training specialist with the CNET Sailor of the Year plaque, Vice Adm. Jack Fetterman, Chief of Naval Education and Training said, "Collectively, all our candidates have gone above and beyond. They are Sailor of the Year nominees because they simply enjoy what they are doing."

One of five finalists competing for the prestigious title, Petty Officer Henderson credited his winning philosophy to his father. "Winners make it happen. Losers watch it happen," he told those present for the Sailor of the Year banquet.

A native of Covington, Ky., Petty Officer Henderson is an assistant company commander, and instructor in the Cryptologic Training Department's Basic School. As an instructor in the school he was instrumental in 14 students winning the prestigious Samuel F.B. Morse Award.



CTT1 James H. Henderson is presented with a plaque naming him CNET Sailor of the Year by Chief of Naval Education and Training, Vice Adm. Jack Fetterman.

Prior to his selection as CNET Sailor of the Year, Petty Officer Henderson was selected as the Chief of Naval Tech-

nic Training Command's Sailor of the Year.

Henderson will now go on to compete for the title of Chief of Naval Operations Sailor of the Year. The CNO Sailor of the Year competition will be held in Washington, D.C., next month.

Other nominees for CNET Sailor of the Year were:

DS1 Joseph F. McClelland Jr., representing the Commander, Training Command, U.S. Atlantic Fleet. McClelland is an instructor at the Fleet and Mine Warfare Training Center, Charleston, S.C.

OS1 David A. Pearson, representing the Commander, Training Command, U.S. Pacific Fleet. Pearson is a master training specialist for the Air Control Division, San Diego.

L1 David P. Nesbitt, representing the Chief of Naval Air Training Command, NAS Meridian, Miss. Nesbitt is assigned to the NAS Meridian Legal Office.

HM1 Lynn C. Martin, representing Naval Education and Training Direct Reporters, Pensacola Naval Hospital. Martin is leading petty officer of the Branch Medical Clinic.

Orange Park school captures NJROTC Field Day crown

By **Gregory P. Stallworth**
CNET Public Affairs

Approximately 360 high school students participated in the second annual Navy League National NJROTC Field Day Championship held last weekend aboard NAS. Participating cadets represented nine of the top NJROTC drill teams from New Jersey, New York, Virginia, North Carolina, Georgia, Florida, Mississippi and Texas. The event, sponsored by the Pensacola Chapter of the Navy League of the United States, encompassed two days of rigorous military drill, athletic and academic competition.

Activities came to a dramatic ending with an awards ceremony held at the Naval Aviation Schools Command parade grounds, presided over by Rear Adm. Louise C. Wilmot, Vice Chief of Naval Education and Training. Parents stood on the side lines wearing proud smiles as the cadets stood in rigid formation anx-

iously waiting for the announcement of winners. Loud cheers greeted the announcement awarding the overall championship to the unit from Orange Park High School, Orange Park, Fla.

"We're extremely proud to have won," said Cmdr. Charles Lusk, Naval Science Instructor at Orange Park High School. "Our success can be attributed to the dedication and hard work that all of our students put forth. The competition was tough, but our team effort put us over the edge."

Recognizing the NJROTC program as a means to starting a successful career, one Orange Park High School student said being a part of NJROTC is one of the most rewarding things he has ever done. It's an organization that his parents fully support.

"NJROTC has opened a lot of doors for me that I probably would have never been able to open by myself," Cadet Michael Klapmeyer

said. "Since the very start, my dad loved the idea of my being a part of the program, but my mother was a little skeptical at first. Now that she has seen what the program is really about, she likes it and is really getting into it." He added that through NJROTC he has been awarded a four-year NROTC college scholar-

ship which he plans to use at Auburn University, Jacksonville University or the Illinois Institute of Technology.

The unit from Middleburg High School, Middleburg, Fla., placed second, while the cadets from George Washington High School, Danville, Va., placed third.



Rear Adm. Louise Wilmot, Vice Chief of Naval Education and Training, congratulates NJROTC cadets on their winning performance during last week's Field Day Championships.

Published by Pensacola Engraving Company, a private firm in no way connected with the Department of the Navy. Opinions contained herein are not official expressions of the Department of the Navy nor do the advertisements constitute Department of the Navy or NAS Pensacola endorsement of products or services advertised.

174.3

Figure 7-6.—Sample CE newspaper blueline.

can produce a very professional-looking ship's newspaper. The basic elements of desktop publishing are shown in figure 7-7.

HARDWARE

You will obviously need a microcomputer, keyboard, monitor and printer to form the nucleus of your desktop publishing system.

Microcomputers used for desktop publishing need at least 512K of memory. Large jobs, such as designing a ship's newspaper, require at least one megabyte of memory. The memory capacity of the microcomputer dictates the size of the pages you can design. Memory is also a factor in the overall speed of operation.

A good high-resolution monitor and video card are system necessities. Your first choice should be a VGA (video graphics array) monitor. When paired with a VGA card, the VGA monitor can display up to 256 colors simultaneously. If your budget permits, get a full-page VGA monitor. This will allow you to look at

an entire page at one time instead of continuously scrolling a page on a smaller monitor. You should also think about cheaper alternatives, such as a monochrome or enhanced color display monitor with a HGC (Hercules graphics card) or EGA (enhanced graphics adapter) card

The printer is probably the most important element of your system. A laser printer should be your first choice for creating finished products. This compact machine produces near-typeset-quality print (usually at resolutions of 300 or 400 dots per inch) at a cost between \$1,500 and \$3,000. You should still consider getting a 24-pin dot-matrix printer, however. This printer is inexpensive and can be used to check fonts or create first drafts of pages.

Think about adding a mouse to your system. A mouse is an input device that attaches to a serial port of the computer. Most mice come with two buttons. The left button performs primary commands, including highlighting and picking items off the screen. The right

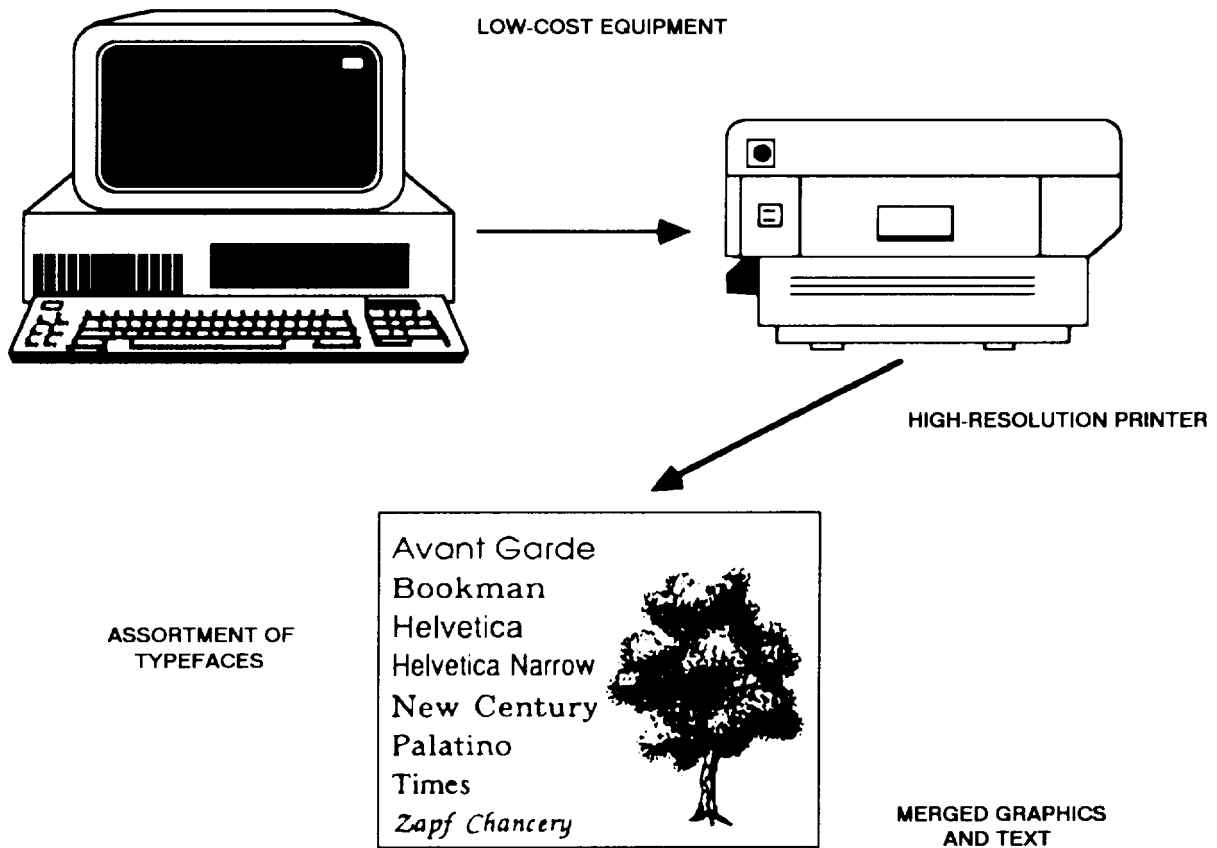

Courtesy of the Que Corporation, a division of Prentice Hall Computer Publishing

174.2X

Figure 7-7. Basic elements of desktop publishing.

button performs secondary functions, such as changing views and page sizes on the monitor.

The mouse fits neatly in the palm of your hand. A small ball at the bottom of the mouse helps it glide across a smooth surface (such as a foam rubber pad). As you move the mouse, its built-in circuitry creates a pointer that lets you navigate the screen. By “pointing and clicking,” you can move text, work on-screen menus and perform a myriad of other functions.

Other useful peripherals to consider include the stylus (similar to a mouse, but more precise), seamer (converts printed text to computer text) and digitizer (converts photographs, line art and other graphics into forms that are readable by the computer).

SOFTWARE

The desktop publishing programs available on the market today are similar in performance. Each program can create everything from a four-page ship’s newspaper to a single sheet, trifold welcome aboard pamphlet.

Some of the functions of desktop publishing software include the following:

- **Multiple page layout**, including page numbering, columns per page, margin adjusting for folds and staples and quick access to each page.
- **Typesetting**, including different type styles, fonts and sizes ranging from four point to 127 point.
- **Graphics**, including boxes, lines, circles and shading that can be made to various sizes, widths and lengths. Some programs have a built-in clip art file.

Look at the “big picture” before you purchase desktop publishing software. It should be compatible with your computer and be able to convert files from your current word processing program. The software should also have a good graphics file and a large selection of type fonts from which to choose from. Additionally, you should make sure classes are available to train you and your staff about the program and its inner workings.

This section has barely scratched the surface of desktop publishing. You can get additional information from the Navy Publishing and Printing Service, Building 176-2, Washington Navy Yard, Washington, DC 20374-1762.

CHAPTER 8

BROADCAST MANAGEMENT

More than half of all Navy journalists are assigned broadcasting duties. Now, it is almost impossible to finish a career in the Navy as a journalist without being assigned to a billet that requires you to understand the basics of broadcasting. Earlier in your career, you were taught how to speak and write correctly for broadcast productions. Having already been trained at DINFOS or at your first broadcast assignment, now you will gain a deeper understanding of what you were taught and how to use that knowledge. You must now be the teacher. This chapter enables you to be an effective broadcast manager by providing information on how to lead and train a broadcast news, production and programming department.

NBS DETACHMENT ADMINISTRATION

Learning Objective: *Identify the elements of administering and managing a Navy Broadcasting Service (NBS) detachment.*

This chapter is not a compilation of Navy Broadcasting Service (NBS) administration policies. This information is covered in SECNAVINST 1700.10D series (including DoD Instruction 5120.20-R and the annexes). So that you keep a current and reliable source in the hands of your sailors, periodic changes will be issued and you should pay close attention to including these updates within the instruction.

Areas of concern to station managers that are included in DoD 5120.20-R are as follows:

- Station establishment (ashore and afloat)
- Program material policies and procedures
- Cable and satellite service
- Supply
- Station security
- Support agreements
- Logistics
- Personnel

The previous list is by no means complete in terms of everything DoD 5120.20-R and its appendices and

annexes cover, but it does give you some idea of how important it is to have an updated copy. DoD 5120.20-R is the source of information on the rules and regulations of broadcasting in the Navy. It is the bible of NBS detachment operations. Every JO2 and JO1 should be familiar with this document. You may order DoD 5120.20-R by ordering the accompanying SECNAVINST 1700.10D. Every SECNAV/OPNAV instruction has a stock number, and you may order an instruction through normal supply channels.

STATION ORGANIZATION

The station organization of each NBS detachment depends upon how many people you have to accomplish the particular mission your detachment is assigned to do. Therefore, it is unwise to try to describe the “typical” NBS detachment organization. Some NBS detachments are large and include a dozen journalists and half a dozen interior communications electrician (IC) technicians. Others might only have a half dozen sailors with mission requirements that are the same as the larger manned stations. The key here is flexibility. If the station yeoman and supply clerk must be assigned to television board shifts to free up an IC technician for repair work then so be it. The important thing is to foster an idea of team effort. Once a sailor is assigned to an NBS detachment, nothing more should be made of his particular rating other than it being a specialty needed for the successful operation of the station. If there is a shortage of technicians, then PMS checks that can be done safely by nontechnicians should be completed by those trained to do so. The scenarios are endless. Cross-training will be looked at in more detail later in this chapter, but do not overlook involving everyone in the operations of the NBS detachment by exposing them to other aspects of station business. This will help beat down the irritating habit of outlet segregation by job description. As stated above, team effort is a goal in itself. It is a goal that, when met, may produce extraordinary results.

DEPARTMENTS

In general, an NBS detachment that has radio and television stations will be broken into the three main categories of engineering, radio and television. The

radio and television departments will be broken into three divisions called news, production and programming. Again, these divisions are just common examples. Many NBS detachments have a storekeeper and a yeoman assigned to help with supply and administration. If they are not assigned, it is a good idea for you to detail an engineer to supply and a JO to administration to keep responsibility for station supply and administration tight. A long break-in period is usually in order in these situations. For an example of what a station organization might look like ideally, see figure 8-1. You may have the people to slot into each position, but most likely, many of your people will be falling more than one of these positions.

In figure 8-1, note the broken lines connecting the chief engineer to supply and the operations department head to administration. They denote a special relationship between these positions. The supply and administration sections work directly for the officer in charge, but the unique and helpful work affiliation between engineering and supply must be maintained. This broken line shows engineering has access to supply's manpower and resources. The same goes for the operations department and the station

yeoman. As an OIC, you can organize your particular station any way you see fit, but remember to keep the channels of communication open to allow your staff to do the job at hand.

OPERATIONS

The operations department in NBS detachment management is the overall section that contains the news, production and programming functions for both television and radio. As such, it is the center of activity and the focal point for most contacts with the public. Whether or not the operations department head position is filled, is as always, a question of manpower. Even if it is not filled there are some operational functions which include both television and radio that must be done.

STANDARD OPERATING PROCEDURES (SOPs)

What happens if there is an enemy attack? What do your people do if there is an earthquake? Who can call up and get something on the air immediately? What is the procedure for placing community notes in a disc

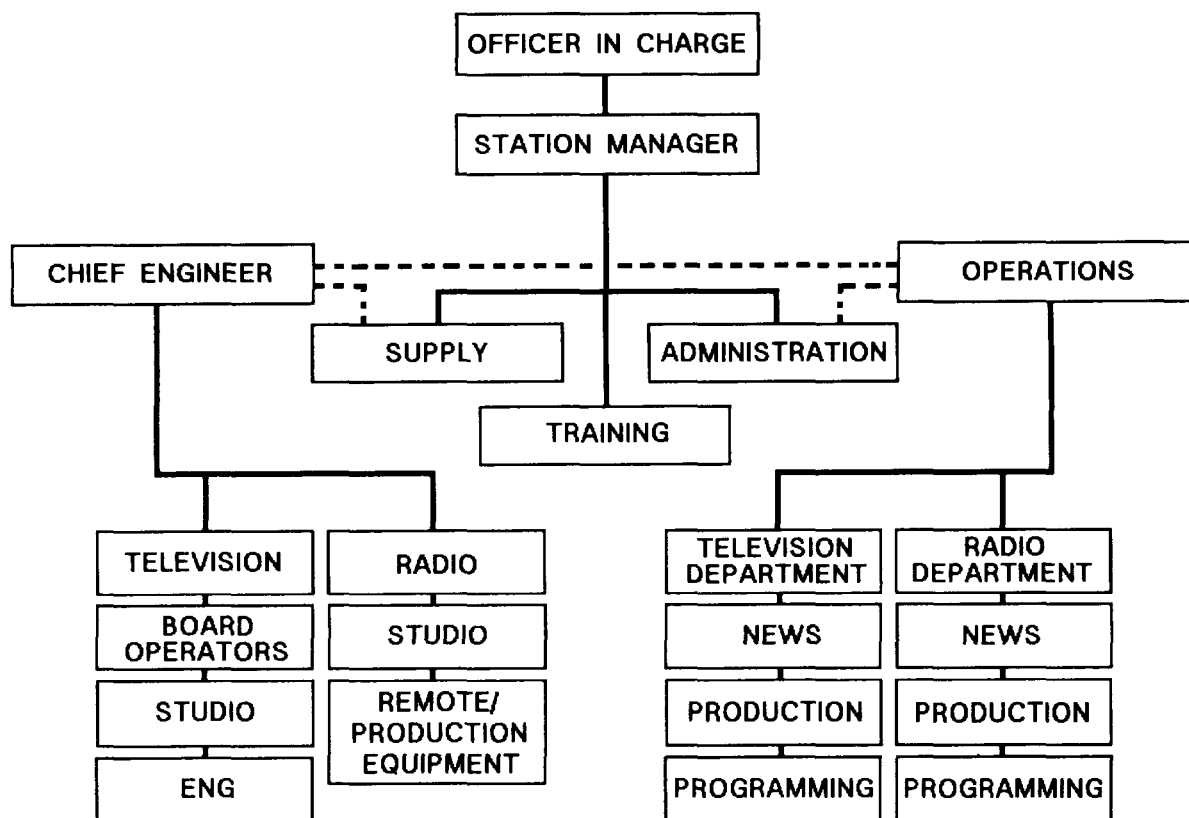

Figure 8-1.-Possible NBS detachment organization.

jockey's (DJ's) show? These types of questions and many more are to be answered within the station SOP book. Recall rosters for the command should also be placed in the SOP. All emergency action plans should be placed in the book and exact copies should be distributed to each board operations site. (More than likely, emergencies will occur after normal working hours are over.) DoD 5120.20-R contains information on station identifications and emergency announcements and that will help you when writing an SOP for your station. A periodic review of the SOP by all hands is a must.

CONTINUITY

The continuity department writes, receives and checks all spot announcement copy before it is aired. The continuity department makes sure the copy is according to station SOP to include format, time and good taste, and so forth. The copy is usually kept in a continuity book used for on-air purposes and an alibi file is maintained that will hold the announcements for one year. (It is a good idea to keep all news copy in an alibi file for one year also.) The continuity department interacts with virtually everyone in the station. It must interact with the operations manager and program manager concerning station policies, procedures and spot programming, and with production personnel about any equipment, props or graphics that might be needed. It must also interact with the on-air talent to make sure that intended messages or objectives of locally produced spots are met.

Continuity could be a single department at very large stations, but within NBS detachments, it is more than likely one of the functions of the radio department. Again, this organizational decision is made by the station OIC based on available resources. However, there should always be someone specifically accountable for continuity at the station. Always remember: the primary objective of the Armed Forces Radio and Television Service (and thus NBS detachments) is the timely dissemination of command information to military, DoD personnel and their family members. One of the most effective methods of fulfilling this mission is by radio and television spot announcements.

TRAINING

Most often a senior petty officer is appointed as the training PO for the detachment, and it is that PO's job to make sure each person filling a position at the station

is adequately prepared for the job. Every journalist at the station should be trained as a basic broadcaster. As stated earlier, knowing how to teach the fundamentals is the underlying mission of this chapter. Later in this chapter, we explore what the senior JO should know before attempting to teach the two most basic tasks of broadcast journalism: announcing and interviewing.

CROSS-TRAINING

You read about the importance of cross-training in Chapter 1. Cross-training at an NBS detachment, as in a public affairs office, is extremely important for a number of reasons. First, you want all your people to have the benefit of experience at every position in the detachment. This will produce well-rounded leadership in the future Navy. Second, no one should ever be indispensable. You never know when tragedy, emergency transfers, TADs or combat casualties might occur. Third, cross-training for most sailors is fun. There are countless business school text books crying for management to keep employees interested in the job by letting them see the big picture and accomplish different tasks. In Navy broadcasting, keeping young sailors away from the equipment on their days off is often a problem.

TELEVISION PROGRAMMING

Learning Objective: Recognize the principles, capabilities and requirements of television programming.

Preparing a master television schedule is a lot more than just taking available program material and falling in the blanks on a schedule. For the military programmer, it is a complex blend of what the audience wants and when, fulfilling command information requirements and adhering to policies laid down by everyone from AFRTS to your local station manager. Your primary objective is to pass command information onto the viewer. The trick to doing this effectively is for you to program your station in a way that attracts the viewer and keeps him watching. In other words, hook 'em, keep 'em and inform 'em. You are simply responding to and meeting the needs of the audience and that makes for effective programming.

In this section, we will cover the primary considerations in making programming decisions. We will also cover the mechanics of preparing the master television schedule and how to promote it once the schedule is complete. The examples given in this section

are based on hypothetical survey results obtained using the proper techniques you will learn in Chapter 9.

PROGRAMMING STRATEGIES

As you get ready to map out the program schedule for your station, strategy is one of the first things you will want to consider. Basically, it is the planning and direction of your programming schedule; the overall picture. At this point, you consider all of the variables involved including such things as the audience survey, selection of programming materials, putting the programs in an appropriate time slot for a particular target audience, and so on. Two of the most important strategies in programming are compatibility and audience flow.

Compatibility

One of your goals in programming is to schedule your material to coincide with what people do throughout their day. Your schedule should be compatible with the cyclic nature of people's daily activities. At the beginning of the day, most working people do not have time for entertainment programs but are interested in what happened overnight in the news. An example of how the networks meet this need are the morning programs like *Today* and *Good Morning America*. Throughout the day, as people's activities change, so should your programming.

An example of this is the early afternoon lull when shows with adult female appeal, such as soap operas, are popular. Later in the afternoon, when children are out of school, programs with youth appeal, like cartoons, are popular. Another consideration for you to keep in mind is that television is a leisure time activity and your program schedule should reflect this fact. It would not be good programming for you to schedule your most popular programs when everyone is at work or asleep. Air the shows people want to see at times when they can see them. Programming your schedule to be compatible with this cycle is known as **dayparting**. We will examine dayparting later in this section.

To make the compatibility principle work, you have to consider who the available audience is and what they are doing. You have to study how the audience lives to determine not only scheduling, but also what type of program to use, thereby creating a flow to your programming that meets the needs of the various audience types throughout the day. An audience

survey is the best way for you to accomplish this (see Chapter 9).

Audience Flow

In commercial broadcasting, the programmer tries to keep the audience flowing from one program to the next. His job is to maximize the number that flows from one program to the next and the number that flows in from other stations while minimizing the number that flows out. As a military programmer, you are concerned with audience flow but only in the sense that you are trying to create a flow to programming that keeps the audience tuned in. This is developed from the compatibility principle and is adapted to the unique needs of programming for an NBS detachment. As your audience changes throughout the day, your programming should coherently flow with that change. Again we will use the afternoon hours as an example. You have programmed soap operas in the early afternoon for a predominantly adult female audience. Your decision to do that is based on survey information providing program preferences for adult women. Later, as children come home from school, activity around the house begins to increase and the adult female audience significantly declines. School-aged children increase their viewing during these hours and your programming should reflect this with children's programming. Later after dinner, family viewing rises and programming is adjusted accordingly.

Program material available from AFRTS is considered to be the best of current commercial programming. The AFRTS Broadcast Center (AFRTS-BC) offers the military programmer more than 90 percent of the entire prime time schedule of the major U.S. television networks, nearly all of the A.C. Nielsen top-rated programs.

With this amount of popular programming, the development of a flow to your schedule becomes a lot easier. The important thing for you to remember is that your programming should be scheduled to flow with target audience availability. It does not do any good for you to schedule prime time shows at a time when most people are not able to watch. For example, if a survey indicates the majority of crew members on your ship are off work by 1600 and finished eating and showering by 1800, it would be good for you to start your prime time programming then. Programming your station with audience flow in mind ensures that your schedule has structure and is not just a haphazard mix.

PROGRAMMING DEVELOPMENT

Before you can put your strategies to work carefully consider the following areas:

- Defining the target audience
- Determining prime time
- Other dayparts
- Available programming

Another consideration will be that you are working with a schedule already in place. You will have to evaluate its strengths and weaknesses to see what you will incorporate into your schedule.

DEFINING THE TARGET AUDIENCE

The nature of programming for the military audience is such that there can be few absolutes. You may be programming for an area with a significant number of family members or an area with a highly transient military population. The bottom line, however, is that your audience is made up of people who consider

television an integral part of their lives. Your obligation is to gear programming to fit their mode of living. A current audience survey is the tool you will use to accomplish this.

Survey analysis reveals the who, what, when and where of television programming. Using the results from a local audience survey, you can tell who is watching, what they like to watch, when they like to watch and where they watch. The sample survey results in figures 8-2 and 8-3 show audience program preference. Feature films are an audience favorite, so that would be an important feature in your program schedule. However, the survey also shows a variety of other program types are also popular, so it now becomes a matter of balance according to the degree of popularity.

DETERMINING PRIME TIME

Once you know what the audience likes and dislikes, when they like to see it becomes a factor. Taking the type of programming the audience prefers, you can now proceed to make it available to the audience when they want to see it, if it is available. For example,

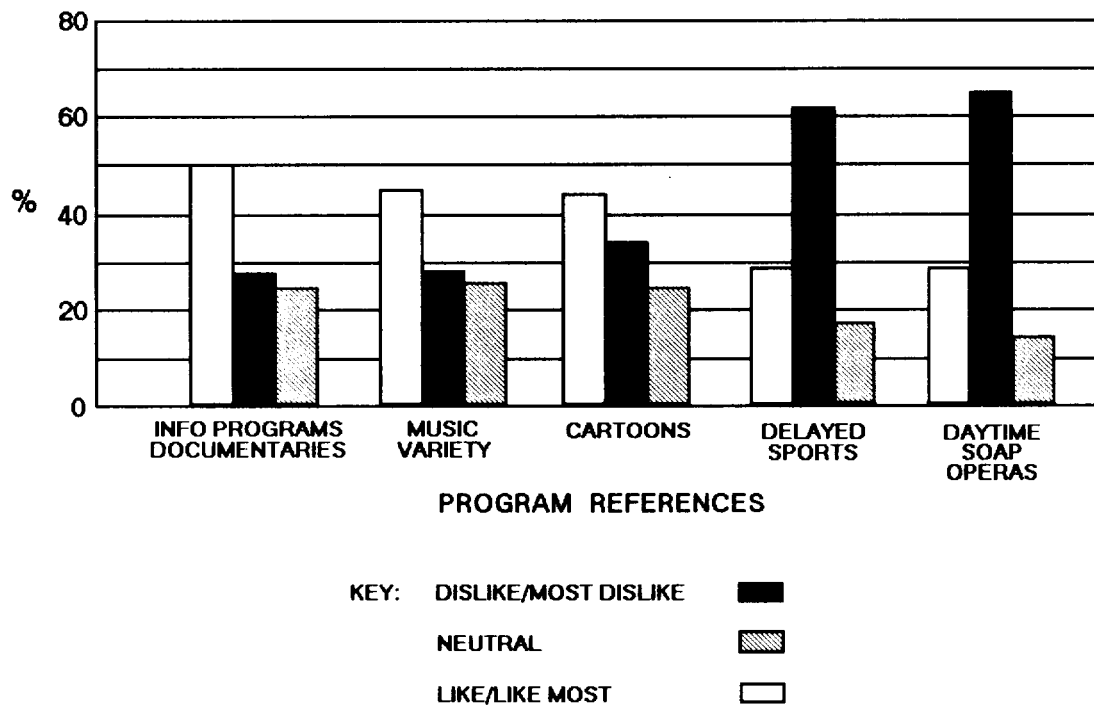

Figure 8-2.-Sample survey results.

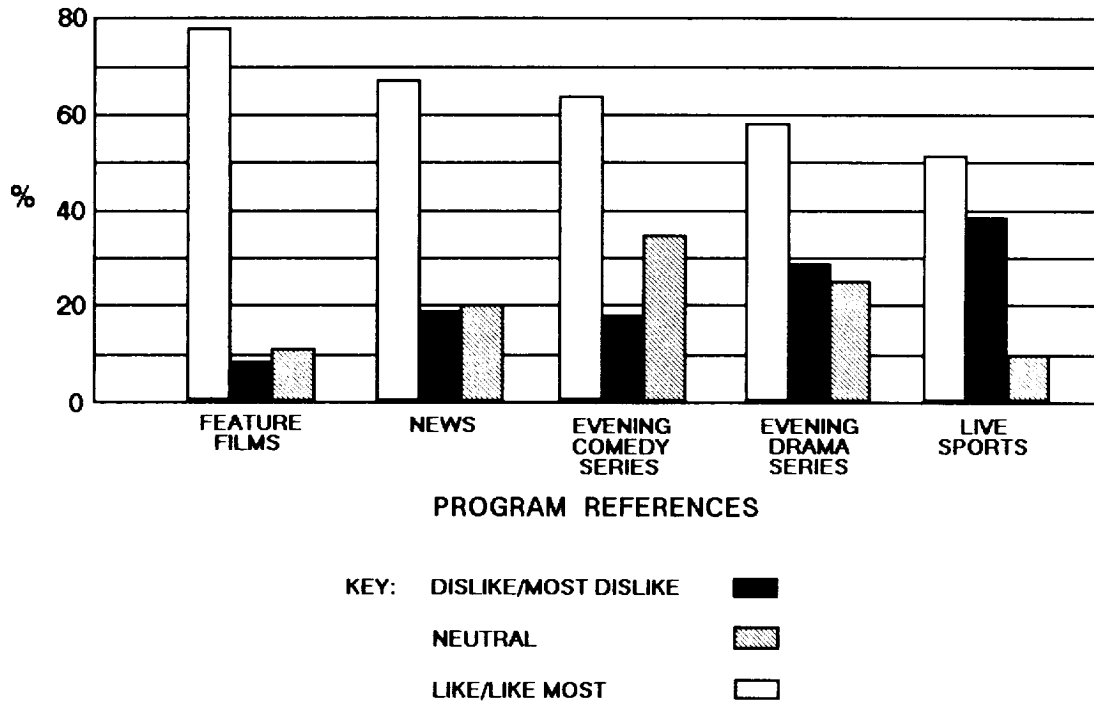

Figure 8-3.-Sample survey results.

we know feature films are a big audience draw. Figure 8-4 shows the majority of the audience views between 1800 and 2100 on weekdays. That is where you will want to schedule feature films.

Figure 8-4 shows the survey results for audience viewing on an average weekday. Peak viewing runs from 1800 to approximately 2100. This is total audience viewing. For a breakdown of audience types throughout

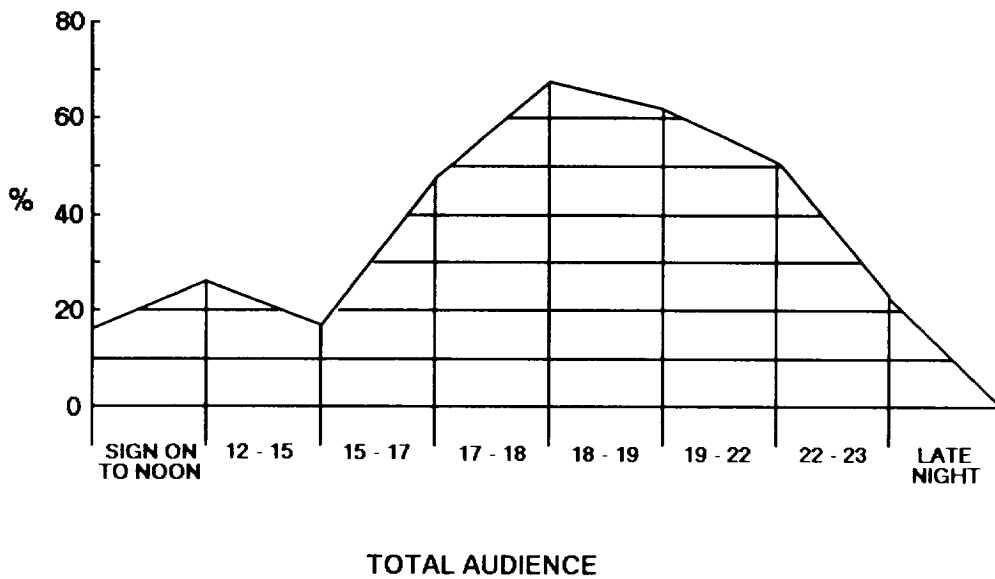
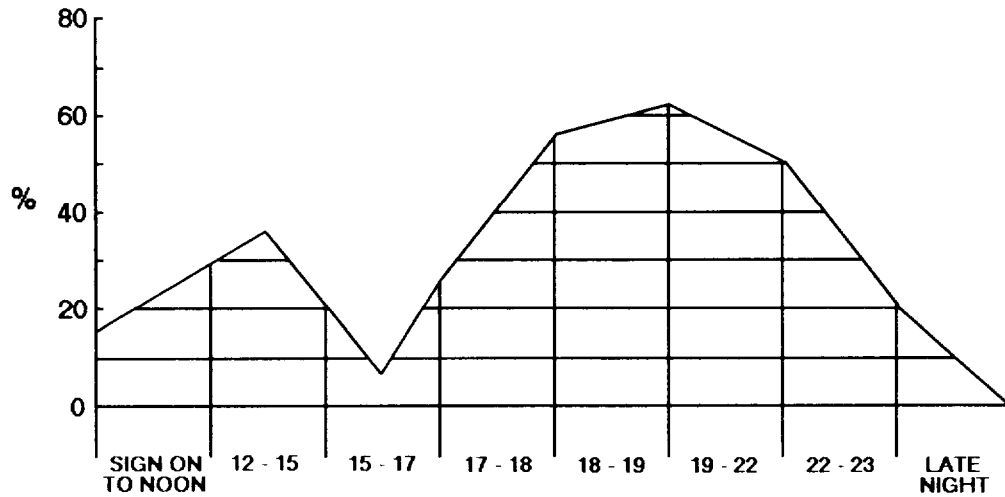

Figure 8-4.-Audience availability.



ADULT FAMILY MEMBERS

Figure 8-5.-Adult viewing habits by daypart.

different dayparts, see figures 8-5 and 8-6. Since we are working with total audience figures, we have determined that prime time is from 1800 to 2100; during this part of the day, an NBS detachment can reach the greatest number of people. Prime time for the overseas military audience is similar to that of the stateside audience. Figure 8-6 also reveals two fringe times, 1700-1800 and 2100-2300. Fringe times are time blocks adjacent to prime time and can be useful in making programming decisions. According to this sample,

fringe time programming could be a late evening newscast or talk show.

OTHER DAYPARTS

Morning, mid-day, late afternoon and late nighttime slots are significant because during those times you can reach very narrowly focused audience segments. (For the purpose of this section, morning hours are 0600-1100, mid-day is 1100-1600, late afternoon is

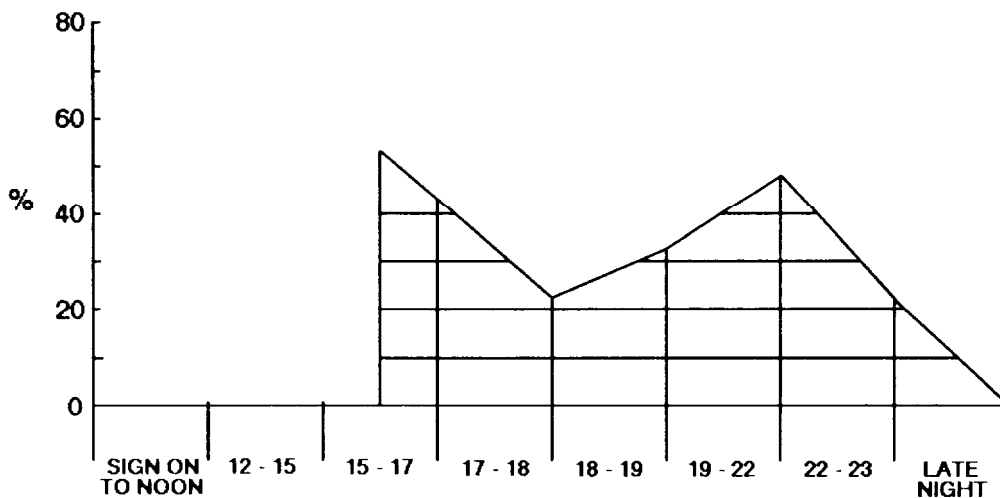

AGE 15 AND UNDER

Figure 8-6.-Juvenile viewing habits by daypart.

ITEM	TITLE	PRODCTN#	REEL	TIME	MSTR	EDITOR	BOX
		FLD ID#				EDIT DATE	
1.01	CHEERS Achilles Hill REMARKS: FILLERS FOLLOW SQ. MASTER TIME 28:30.	91220	209 1of1	00:25:35	5085	ACOSTA 01/15/92	1
1.02	COACH Puppy Love REMARKS: FILLERS FOLLOW SQ. MASTER TIME 28:30.	91154	66617 1of1	00:24:51	7474	ACOSTA 01/15/92	1
1.03	LIFE GOES ON Sweet Sixteen REMARKS: FILLER FOLLOWS SQ. MASTER TIME 58:30.	91242	187265 1of1	00:52:37	0865	ACOSTA 01/15/92	1
2.01	FULL HOUSE Stephanie Plays The Field REMARKS: FILLER FOLLOWS SQ. MASTER TIME 28:30.	91095	446422 1of1	00:24:15	2117	ACOSTA 01/15/92	1
2.02	DESIGNING WOMEN I'll See You In Court REMARKS: FILLER FOLLOWS SQ. MASTER TIME 28:30.	90278	520 1of1	00:24:44	7342	BISETTI 01/13/92	1
2.03	INSPECTOR MORSE (YR 2) Ghost In The Machine (Part 1 Of 2) REMARKS: FILLER FOLLOWS SQ. MASTER TIME 58:30.	91122	1 1of1	00:50:54	5582	BISETTI 01/14/92	1
3.01	EVENING SHADE Something To Hold On To REMARKS: FILLER FOLLOWS SQ. MASTER TIME 28:30.	91897	605 1of1	00:25:05	6516	BISETTI 01/13/92	1
3.02	COSBY SHOW, THE REMARKS: Filler follow SQ. Master time 28:30.	91244	911017 1of1	00:25:00	0159	UZOFF 01/18/92	1
3.03	NORTHERN EXPOSURE All Is Vanity REMARKS: FILLER FOLLOWS SQ. MASTER TIME 58:30.	91229	77404 1of1	00:49:40	5117	ACOSTA 01/15/92	1
4.01	MAJOR DAD The Shutdown REMARKS: FILLER FOLLOWS SQ. MASTER TIME 28:30.	91153	67101 1of1	00:25:15	5319	BISETTI 01/14/92	1

Figure 8-7.--Sample AFRTS-BC Tele-Tips sheet.

1600-1800 and late night is 2300 to sign-off.) For example, figure 8-5 indicates that adult family members increase their viewing time during the early afternoon hours. Further research indicates the majority of the viewers at that time are female. Therefore, you should program shows with adult female appeal at that time, such as soap operas, to meet the needs of the audience. Your making the assumption that an increase in viewing during this time slot is attributable to adult women is poor programming. Only research for you to determine the demographics of the audience during all dayparts is justification for your programming to a particular audience type.

Another important consideration is the shift worker audience. The size of that audience will vary from location to location, so it is up to you to determine the size and viewing habits of that audience in your area. The audience survey will aid in the determination. This will play into your programming decisions to the degree that you may want to repeat prime time and other popular programs to meet the needs of the shift worker audience. This is especially true on large afloat commands.

AVAILABLE PROGRAMMING

Most radio stations at NBS detachments are on the air 24 hours a day and provided 80 hours of programming from AFRTS-BC per week. The remainder of the week, 78 hours, is filled out with live programming or repeats. Television stations, meanwhile, are provided 92 hours of programming per week. The advantage for television is that in most places it is not on 24 hours a day (certain AFRTS networks are 24 hours a day on the weekend). It signs on and off each day at prescribed times according to local audience and command needs and requirements, so there is not a need to fill the remaining hours each week. The 92 hours of programming provided to television stations comes in the form of shipments from AFRTS-BC and SATNET feeds.

AFRTS-BC Shipments

AFRTS-BC shipments are comprised of prime time programs, movies, mini-series and specials. Short fillers and children's programming are also included. As shows are dropped by commercial networks, AFRTS-BC makes an effort to replace them in kind, drama for drama, sitcom for sitcom, and so forth. AFRTS-BC shipments come with Tele-Tips (fig. 8-7) describing programming and other pertinent

information. Tele-Tips can be used for previewing programming to check for sensitivities. It also gives you information concerning program changes in each shipment, show length and natural break times for inserting local spot announcements. Tele-Tips are also available on 5-inch floppy disk for use in the AFRTS Operations Network (ONET) computer system.

SATNET

SATNET is the worldwide AFRTS 24-hour satellite network. It is designed to provide overseas outlets with time-sensitive programming, such as major network evening newscasts, information programs like *Meet the Press*, specials like the *Grammy Awards* and sporting events. It also provides breaking news coverage. AFRTS-BC provides SATNET program schedules to all SATNET users (fig. 8-8). This schedule provides overseas outlets with the feed times for regularly scheduled program material and is updated on an as-needed basis. SATNET provides a closed circuit feed twice a day that includes the daily broadcast schedule, program advisories, the weekly sports schedule and other information.

One other source of material is locally produced shows. These include local news, community interest programs and feedback type programs that can give station management an unscientific, but important gauge of what the audience is currently thinking. Command information programs are also included. An important note on these types of programs is that they should generally be included in your prime time programming.

Restricted Programming

In certain areas of the world, programming provided by AFRTS-BC may be partially restricted because it constitutes competition with, or is detrimental to the commercial artist, copyright owners or other private interest determined to be competitive (see DoD 5120.20-R). Examples of this are NBS detachments in Iceland and Puerto Rico. Remember, AFRTS-BC is able to acquire the use of programs at a substantially lower cost than commercial networks. Because some current programs are sold to the television networks in these countries, the producers of the programs restrict AFRTS from airing them, thereby giving the copyright owner opportunity for greater profit. In areas where certain programs are restricted from use, the military programmer has to depend on the station film and video library.

SATNET TV MASTER SCHEDULE Armed Forces Radio and Television Service STANDARD TIME

UTC	L.A.	MONDAY	TUESDAY	WEDNESDAY	THURSDAY	FRIDAY	SATURDAY	SUNDAY	L.A. UTC
08:00	00:00	CNN	Ar-senio Hall (T)	Ar-senio Hall (T)	Ar-senio Hall (T)	Ar-senio Hall (T)	Ar-senio Hall (T)	Entertainment Tonight	00:00 08:00
08:30	00:30	Headline News	NBC Tonight Show (T)	NBC Tonight Show (T)	NBC Tonight Show (T)	NBC Tonight Show (T)	NBC Tonight Show (T)	WEEKEND EDITION (T)	00:30 08:30
09:00	01:00	CNN World Report (T)	NBC David Letterman (T)	NBC David Letterman (T)	NBC David Letterman (T)	NBC David Letterman (T)	NBC David Letterman (T)	NBC Saturday Night Live (T)	01:00 09:00
10:00	02:00		Headline News	Headline News	Headline News	Headline News	Headline News	Headline News	01:30 09:30
11:00	03:00	Headline News	Headline News	Headline News	Headline News	Headline News	Headline News	Headline News	02:00 10:00
11:30	03:30	AFRTS Advisory Block	AFRTS Advisory Block	AFRTS Advisory Block	AFRTS Advisory Block	AFRTS Advisory Block	AFRTS Advisory Block	AFRTS Advisory Block	02:30 10:30
12:00	04:00	ABC Good Morning America (EAST COAST EDITION)	ABC Good Morning America (EAST COAST EDITION)	ABC Good Morning America (EAST COAST EDITION)	ABC Good Morning America (EAST COAST EDITION)	ABC Good Morning America (EAST COAST EDITION)	ABC Good Morning America (EAST COAST EDITION)	NBC Pro Bowlers Tour (T) OR SPORTS/SPECIALS/CNN	03:00 11:00
12:30	04:30								04:00 12:00
13:00	05:00								04:30 12:30
13:30	05:30								05:00 13:00
14:00	06:00	Headline News	Headline News	Headline News	Headline News	Headline News	Headline News	Headline News	05:30 13:30
14:30	06:30	NBC News At Sunrise	NBC News At Sunrise	NBC News At Sunrise	NBC News At Sunrise	NBC News At Sunrise	NBC News At Sunrise	CBS Sunday Morning (T)	06:00 14:00
15:00	07:00	NBC Today (WEST COAST EDITION)	NBC Today (WEST COAST EDITION)	NBC Today (WEST COAST EDITION)	NBC Today (WEST COAST EDITION)	NBC Today (WEST COAST EDITION)	NBC Today (WEST COAST EDITION)	CBS Face The Nation	06:30 14:30
16:00	08:00							ABC Meet The Press (T)	07:30 15:30
16:30	08:30							ABC This Week With Brinkley	08:00 16:00
17:00	09:00	Headline News	Headline News	Headline News	Headline News	Headline News	Headline News	Headline News	08:30 16:30
18:00	10:00	CBS This Morning (T)	CBS This Morning (T)	CBS This Morning (T)	Inside The NFL (T)	ABC Primetime Live(T) OR Headline News	SPORTS/SPECIALS OR CNN	SPORTS/SPECIALS OR CNN	09:00 17:00
18:30	10:30	(WEST COAST EDITION)	(WEST COAST EDITION)	(WEST COAST EDITION)	CNN Newswatch	CNN Newswatch			10:00 18:00
19:00	11:00				CNN 48 Hours (T)	CNN 48 Hours (T)			10:30 18:30
19:30	11:30	CNN International Hour	CNN International Hour	CNN International Hour	CNN International Hour	CNN International Hour	CNN International Hour	CNN International Hour	11:00 19:00
20:00	12:00								12:00 20:00
20:30	12:30								12:30 20:30
21:00	13:00	Headline News	Headline News	Headline News	Headline News	Headline News	Headline News	Headline News	13:00 21:00
21:30	13:30	Entertainment Tonight (T)	Entertainment Tonight (T)	Entertainment Tonight (T)	Entertainment Tonight (T)	Entertainment Tonight (T)	Entertainment Tonight (T)	Entertainment Tonight (T)	13:30 21:30
22:00	14:00	Headline News	Headline News	Headline News	Headline News	Headline News	Headline News	Headline News	14:00 22:00
22:30	14:30	CNN Showbiz Today	CNN Showbiz Today	CNN Showbiz Today	CNN Showbiz Today	CNN Showbiz Today	CNN Showbiz Today	CNN Showbiz Today	14:30 22:30
23:00	15:00	AFRTS Advisory Block	AFRTS Advisory Block	AFRTS Advisory Block	AFRTS Advisory Block	AFRTS Advisory Block	AFRTS Advisory Block	AFRTS Advisory Block	15:00 23:00
23:30	15:30	ABC World News Tonight	ABC World News Tonight	ABC World News Tonight	ABC World News Tonight	ABC World News Tonight	ABC World News Tonight	ABC World News Tonight	15:30 23:30
00:00	16:00	NBC Nightly News	NBC Nightly News	NBC Nightly News	NBC Nightly News	NBC Nightly News	NBC Nightly News	NBC Nightly News	16:00 00:00
00:30	16:30	CBS Evening News (T)	CBS Evening News (T)	CBS Evening News (T)	CBS Evening News (T)	CBS Evening News (T)	CBS Evening News (T)	CBS Evening News (T)	16:00 00:30
01:00	17:00	CNN Moneyline (T)	CNN Moneyline (T)	CNN Moneyline (T)	CNN Moneyline (T)	CNN Moneyline (T)	CNN Moneyline (T)	CNN Moneyline (T)	16:30 01:00
01:30	17:30	SPORTS/SPECIALS OR CNN	SPORTS/SPECIALS OR CNN	SPORTS/SPECIALS OR CNN	SPORTS/SPECIALS OR CNN	SPORTS/SPECIALS OR CNN	SPORTS/SPECIALS OR CNN	SPORTS/SPECIALS OR CNN	17:00 01:30
02:00	18:00	Headline News	Headline News	Headline News	Headline News	Headline News	Headline News	Headline News	17:30 01:30
02:30	18:30	ABC Monday Night Football							18:00 02:00
03:00	19:00								18:30 02:30
03:30	19:30								19:00 03:00
04:00	20:00	Headline News	Headline News	Headline News	Headline News	Headline News	Headline News	Headline News	19:30 03:30
04:30	20:30	CNN Sports Tonight (T)	CNN Sports Tonight (T)	CNN Sports Tonight (T)	CNN Sports Tonight (T)	CNN Sports Tonight (T)	CNN Sports Tonight (T)	CNN Sports Tonight (T)	20:00 04:00
05:00	21:00								20:30 04:30
05:30	21:30	Headline News	Headline News	Headline News	Headline News	Headline News	Headline News	Headline News	21:00 05:00
06:00	22:00	ABC Nightline (T)	ABC Nightline (T)	ABC Nightline (T)	ABC Nightline (T)	ABC Nightline (T)	ABC Nightline (T)	ABC Nightline (T)	21:30 05:30
06:30	22:30	CNN Moneyline (T)	CNN Moneyline (T)	CNN Moneyline (T)	CNN Moneyline (T)	CNN Moneyline (T)	CNN Moneyline (T)	CNN Moneyline (T)	22:00 06:00
07:00	23:00	Headline News	Headline News	Headline News	Headline News	Headline News	Headline News	Headline News	22:30 06:30
07:30	23:30	CNN Worldwide Update	CNN Worldwide Update	CNN Worldwide Update	CNN Worldwide Update	CNN Worldwide Update	CNN Worldwide Update	CNN Worldwide Update	23:00 07:00
		CNN Sports Latentight	CNN Sports Latentight	CNN Sports Latentight	CNN Sports Latentight	CNN Sports Latentight	CNN Sports Latentight	CNN Sports Latentight	23:30 07:30

SHADED AREAS INDICATE SPORTS/SPECIALS AND PROTECTED HEADLINE NEWS

STD_MAST UPDATED 11/06/1

Figure 8-8--Sample AFRTS-BC SATNET schedule.

PROGRAMMING TACTICS

Arranging the programming according to all the variables we have discussed so far is known as blocking. The following is a list of several different types of blocking:

- Horizontal blocking
- Vertical blocking
- Free form blocking

Horizontal Blocking

Horizontal blocking is arranging your programming for two or more consecutive days so that repeat programs form horizontal, or left to right lines (fig. 8-9). Programming *TV2 News Watch* weekday evenings at 1830 is an example of horizontal programming.

Vertical Blocking

Vertical blocking is arranging your program segments for a one-day period in a vertical, or up and down fashion (fig. 8-10). Scheduling a sports event for two and a half hours Monday at 1900 is an example of vertical blocking.

Free Form Blocking

Free form blocking is a combination of horizontal and vertical blocking (fig. 8-11). This style of programming is the one used to make a complete television schedule. For example, as figure 8-11 shows, you can horizontally block your newscasts for the same segment of prime time every evening and vertically block the rest of your popular programming to fill out prime time according to audience tastes.

SATNET will occasionally cause disruptions to your schedule due to breaking news, presidential press conferences and other similar events. This will mean shifting some shows from their regularly scheduled slot to someplace else, but by promoting the change on the air and rescheduling the show in a similar time slot, there should be a minimum of negative audience response.

When you prepare your schedule, it is important for you to remember that it should be balanced. For example, you should try to simulate stateside prime time blocking with your schedule. Grouping all the sitcoms on one night and all the dramas on another would quickly lead to boredom.

TIME TECHNIQUES

The American audience has been conditioned to expect television programs to begin on the hour and half-hour. However, this is one of the most difficult areas to overcome in NBS detachment television scheduling. Television programs shipped from AFRTS-BC do not contain commercials. When AFRTS-BC master control is not manned, the SATNET feeds are sent with the commercials included and it is up to the user to remove them. The net result is that the half-hour show has now become 26:00 and the hour program is now 56:00. There are only two choices: time blocking or off-time blocking.

Time Blocking

Time blocking is starting your programming on the hour or the half-hour (fig. 8-11). To do this, you must depend on filler material. AFRTS-BC does not include much filler material in its weekly shipment, and most filler material in station libraries is outdated. There are always music videos, but be wary of what songs or pictures you are presenting to your audience. You do not want a high-power sexual tension video coming on the air during *Scoobie Doo*.

Another option is filling the natural breaks with spots. This requires a large and frequently updated spot inventory to reduce audience boredom.

Off-Time Blocking

Off-time blocking is scheduling your programs back to back with programs starting at odd times, as shown in figure 8-12. This type of blocking is often used by NBS detachments. It makes the job easier because you are not trying to find fillers to match the amount of time you need to fill, as you would if you were time blocking. One drawback is that it makes meeting live satellite programs more difficult. These programs usually begin on the hour or half hour. This is also a problem you will encounter with your evening newscast. If there is to be one constant in your schedule, it should be the start time of your main newscast. That will require fillers at various points during the day to make sure your newscast starts at the right time.

Another important note about off-time blocking is that publicizing the program schedule is a must; otherwise your audience will have only an approximation of the time their favorite programs

TELEVISION MASTER SCHEDULE WORK SHEET

	MON	TUES	WED	THUR	FRI
1500	General Hospital TW 30-6	General Hospital TW 30-6	General Hospital TW 30-6	General Hospital TW 30-6	General Hospital TW 30-6
1530					
1600					
1630					
1700	Donahue TW 30-6	Donahue TW 30-6	Donahue TW 30-6	Donahue TW 30-6	Donahue TW 30-6
1730					
1800	ABC World News Tonight SATNET	ABC World News Tonight SATNET	ABC World News Tonight SATNET	ABC World News Tonight SATNET	ABC World News Tonight SATNET
1830	TV2 News Watch	TV2 News Watch	TV2 News Watch	TV2 News Watch	TV2 News Watch
1900	Jeopardy TW 30-6	Jeopardy TW 30-6	Jeopardy TW 30-6	Jeopardy TW 30-6	Jeopardy TW 30-6
1930					
2000					
2030					
2100					
2130					
2200	TV2 News Wrap	TV2 News Wrap	TV2 News Wrap	TV2 News Wrap	TV2 News Wrap
2230	Tonight Show SATNET	Tonight Show SATNET	Tonight Show SATNET	Tonight Show SATNET	Tonight Show SATNET
2300					
2330					

Figure 8-9.-Horizontal blocking on a schedule work sheet

TELEVISION MASTER SCHEDULE WORK SHEET

	MON	TUES	WED	THUR	FRI
1500					
1530				Nichelodeon Sinbad and the	
1600				Eye of the Tiger TW 30-6	
1630				↓	
1700					
1730					
1800					
1830					
1900	Sports Angels vs Blue Jays				
1930	↓				
2000		Fame TW 30-6		Airwolf TW 30-6	The A-Team TW 30-6
2030		↓		↓	↓
2100		Hill Street Blues TW 30-6	Hunter TW 30-6	Dallas TW 30-6	
2130		↓	↓	↓	

Figure 8-10. Vertical blocking on a schedule work sheet.

TELEVISION MASTER SCHEDULE WORK SHEET

	MON	TUES	WED	THUR	FRI
1500	General Hospital TW 30-6	General Hospital TW 30-6	General Hospital TW 30-6	General Hospital TW 30-6	General Hospital TW 30-6
1530	↓	↓	↓	↓	↓
1600	Sesame Street TW 30-6	Sesame Street TW 30-6	Sesame Street TW 30-6	Sesame Street TW 30-6	Sesame Street TW 30-6
1630	↓	↓	↓	↓	↓
1700	Donahue TW 30-6	Donahue TW 30-6	Donahue TW 30-6	Donahue TW 30-6	Donahue TW 30-6
1730	↓	↓	↓	↓	↓
1800	ABC World News Tonight SATNET	ABC World News Tonight SATNET	ABC World News Tonight SATNET	ABC World News Tonight SATNET	ABC World News Tonight SATNET
1830	TV2 News Watch	TV2 News Watch	TV2 News Watch	TV2 News Watch	TV2 News Watch
1900	Jeopardy TW 30-6	Jeopardy TW 30-6	Jeopardy TW 30-6	Jeopardy TW 30-6	Jeopardy TW 30-6
1930	Sports Angels vs Blue Jays	Growing Pains TW 30-6	Facts of Life TW 30-6	Newhart TW 30-6	Silver Spoons TW 30-6
2000	↓	Fame TW 30-6	Highway to Heaven TW 30-6	Highway to Heaven TW 30-6	Highway to Heaven TW 30-6
2030	↓	↓	↓	↓	↓
2100	↓	Hill Street Blues TW 30-6	Hunter TW 30-6	Dallas TW 30-6	Falcon Crest TW 30-6
2130	↓	↓	↓	↓	↓
2200	TV2 News Wrap	TV2 News Wrap	TV2 News Wrap	TV2 News Wrap	TV2 News Wrap
2230	Tonight Show SATNET	Tonight Show SATNET	Tonight Show SATNET	Tonight Show SATNET	Tonight Show SATNET
2300	↓	↓	↓	↓	↓
2330	↓	↓	↓	↓	↓

Figure 8-11.—Free form blocking on a schedule work sheet.

TELEVISION MASTER SCHEDULE WORK SHEET

	MON	TUES	WED	THUR	FRI
1500	General Hospital TW 30-6	General Hospital TW 30-6	General Hospital TW 30-6	General Hospital TW 30-6	General Hospital TW 30-6
1545	Sesame Street TW 30-6	Sesame Street TW 30-6	Sesame Street TW 30-6	Nickelodeon Sinbad and the	Tarzan TW 30-6
1645	Cartoons	Cartoons	Cartoons	Eye of the Tiger TW 30-6 ↓	Cartoons
1715	Donahue TW 30-6	Donahue TW 30-6	Donahue TW 30-6	Donahue TW 30-6	Donahue TW 30-6
1800	ABC World News Tonight SATNET	ABC World News Tonight SATNET	ABC World News Tonight SATNET	ABC World News Tonight SATNET	ABC World News Tonight SATNET
1830	TV2 News Watch	TV2 News Watch	TV2 News Watch	TV2 News Watch	TV2 News Watch
1900	Jeopardy TW 30-6	Jeopardy TW 30-6	Jeopardy TW 30-6	Jeopardy TW 30-6	Jeopardy TW 30-6
1922	Sports Angels vs Blue Jays	Growing Pains TW 30-6	Facts of Life TW 30-6	Newhart TW 30-6	Silver Spoons TW 30-6
1946	↓	Kate & Allie TW 30-6	Mary TW 30-6	Benson TW 30-6	Charlie & Co. TW 30-6
2011		Fame TW 30-6	Highway to Heaven TW 30-6	Airwolf TW 30-6	The A-Team TW 30-6
2101		Hill Street Blues TW 30-6	Hunter TW 30-6	Dallas TW 30-6	Falcon Crest TW 30-6
2151	TV2 News Wrap	TV2 News Wrap	TV2 News Wrap	TV2 News Wrap	TV2 News Wrap
2221	Tonight Show SATNET	Tonight Show SATNET	Tonight Show SATNET	Tonight Show SATNET	Tonight Show SATNET

Figure 8-12.-Off-time blocking on a schedule work sheet.

TELEVISION MASTER SCHEDULE WORK SHEET

	MON	TUES	WED	THUR	FRI

Figure 8-13. Sample program schedule work sheet.

start. This is an inconvenience the audience does not deserve.

Many NBS detachments and stations afloat will back time their programming (starting from the nightly newscast), and time block the programming from the beginning of the news until the prime time is over. This gives the largest segment of your audience what appears to be stateside style television programming and is not such a drain on your spot and filler library. Usually the prime time ends with a nightly movie, and this will segue nicely back into off-time blocking.

MASTER PROGRAM SCHEDULE LAYOUT

To layout your master schedule, it is best for you to work in rough draft form. This way you can make changes as you go along, and once it is complete, you can transfer the finished product over to a more formal master program schedule sheet.

A program schedule worksheet should be similar to figure 8-13 with the day blocks listed horizontally and the time blocks listed vertically.

At stations where the AFRTS ONET computer system is in use and once the work sheet is completed, you can build and complete the schedule on the computer.

To fill in the work sheet, just write the program name in the appropriate day or time block and then draw an arrow to the end of the run time of the program as shown in figures 8-10 and 8-11.

Each master schedule should contain the following:

- Name of programs
- Length of programs
- Type of programs
- Source of programs
- Day and time of programs

WEEKLY SCHEDULE

The weekly schedule is the publicity aspect of your master program schedule (fig. 8-14). It is one way you get the schedule distributed to the audience. Copies are distributed to local military publications. On most bases overseas, the NBS detachment runs the weekly schedule in the local base newspaper and also places copies in high traffic areas, like the local exchange, commissary or recreation center.

The weekly schedule should include the following:

- Day and time of broadcast
- Program title
- Program type and a brief synopsis of the show (optional)

The layout of the weekly schedule will be different from the master program schedule, but as shown in figure 8-14, the information is usually listed first by day and then by time.

All the different sources available to you as an AFRTS television programmer provide a potent pool of programming material that any commercial station would envy. Combined with careful audience research and an understanding of what those figures mean, the military programmer has all the necessary tools to program an effective command information vehicle—a vehicle that gives those serving overseas or onboard ship a quality taste of home.

RADIO PROGRAMMING

Learning Objective: Recognize the principles capabilities and requirements of radio programming.

As with television broadcast programming, radio programming begins with **knowing your audience**. Also, an audience survey is essential in evaluating the effectiveness of your station. In programming for the radio, you must satisfy the individual tastes and preferences of the listening audience, just as you would with television. Armed with the results of your survey, you are better able to decide what programs should be broadcast at what time.

You must also understand the audience appeal of the available programs. Begin by reviewing the list of programs available to your station. AFRTS-BC publishes (quarterly) a program ratings form (fig. 8-15) that lists programs issued to AFRTS outlets. This form can tell you the program type, length and programming priority.

If you are not familiar with a particular program, be sure you listen to it. As you familiarize yourself with a program, keep in mind the audience segment to which it might appeal. Because of the uniqueness of local live time shows, it is important to your programming decisions that you become familiar with these products.

MON	TUES	WED	THURS	FRI
1500 General Hospital 1600 Sesame Street 1700 Donahue 1800 ABC News 1830 TV2 News Watch 1900 Jeopardy 1930 Baseball: Blue Jays vs Angels 2200 TV2 New Watch 2230 Tonight Show 2400 Sign Off	1500 General Hospital 1600 Sesame Street 1700 Donahue 1800 ABC News 1830 TV2 News Watch 1900 Jeopardy 1930 Growing Pains 2000 Fame 2100 Hill Street Blues 2200 TV2 News Watch 2230 Tonight Show 2400 Sign Off	1500 General Hospital 1600 Sesame Street 1700 Donahue 1800 ABC News 1830 TV2 News Watch 1900 Jeopardy 1930 Facts of Life 2000 Highway to Heaven 2100 Hunter 2200 TV2 News Watch 2230 Tonight Show 2400 Sign Off	1500 General Hospital 1600 Nickelodeon 1700 Donahue 1800 ABC News 1830 TV2 News Watch 1900 Jeopardy 1930 Newhart 2000 Airwolf 2100 Dallas 2200 TV2 News Watch 2230 Tonight Show 2400 Sign Off	1500 General Hospital 1600 Tarzan 1630 Cartoons 1700 Donahue 1800 ABC News 1830 TV2 News Watch 1900 Jeopardy 1930 Silver Spoons 2000 The A-Team 2100 Falcon Crest 2200 TV2 News Watch 2230 Tonight Show 2400 Sign Off

Figure 8-14.-Sample weekly schedule as published.

AFRTS RADIO WINTER 1992 PROGRAM RATINGS FORM

Attention Station Manager/Program Director:

1. Use one copy of this ratings form to provide quarterly program evaluation to AFRTS Radio.
2. Line out programs not broadcast at all. Indicate if programs are used only on FM (or other secondary service) by writing "FM" next to the program.
3. A "1" rating is the lowest score. A "5" rating is the highest score.
4. Sign the form. Return it to AFRTS Radio, 10888 La Tuna Canyon, Sun Valley, CA 91352-2098 before 15 April along with a copy of your radio schedule.

25 MINUTES FIVE TIMES A WEEK

JIM PEWTER (MU) 1 2 3 4 5
RETROTRAXX (MU) 1 2 3 4 5

30 MINUTES FIVE TIMES A WEEK

JAZZ BEAT (MU) 1 2 3 4 5
RADIO THEATRE (D) 1 2 3 4 5

25 MINUTES ONCE A WEEK

CROSSCURRENTS (R) 1 2 3 4 5
IN THE 1 GOSPEL (R) 1 2 3 4 5
LET GOD LOVE YOU (R) 1 2 3 4 5
LIFT YOUR HEART (R) 1 2 3 4 5

55 MINUTES ONCE A WEEK

*OFF THE RECORD (MU) 1 2 3 4 5
*HEADBANGERS (MU) 1 2 3 4 5
DOUG ORDUNIO (MU) 1 2 3 4 5
GOLDEN DAYS (V) 1 2 3 4 5
KING BISCUIT (MU) 1 2 3 4 5
IN THE STUDIO (MU) 1 2 3 4 5

55 MINUTES FIVE TIMES A WEEK

*CHARLIE TUNA (MU) 1 2 3 4 5
*DON TRACY (MU) 1 2 3 4 5
*GENE PRICE (MU) 1 2 3 4 5
*HARRY NEWMAN (MU) 1 2 3 4 5
*LARITA SHELBY (MU) 1 2 3 4 5
*MARY TURNER (MU) 1 2 3 4 5
*JOE REILING (MU) 1 2 3 4 5
LAURIE ALLEN (MU) 1 2 3 4 5

30 MINUTES ONCE A WEEK

BAPTIST HOUR (R) 1 2 3 4 5
HERALD OF CHRIST. SCI. (R) 1 2 3 4 5
LOVE ON THE ROCK (R/MU) 1 2 3 4 5
ROLLER COASTER (R) 1 2 3 4 5

110-220 MINUTES ONCE A WEEK

*DR DEMENTO (V) 1 2 3 4 5
*THE COUNTDOWN (MU) 1 2 3 4 5
*DAVID SANBORN (MU) 1 2 3 4 5
*AM DANCE TRAXX (MU) 1 2 3 4 5
*DICK CLARK (MU) 1 2 3 4 5
*AMERICAN TOP 40 (MU) 1 2 3 4 5
*AM COUNTRY COUNTDOWN 1 2 3 4 5

STATION MANAGER COMMENTS: _____

STATION MANAGER'S PRINTED NAME Outlet/Location

- * = PRIORITY PROGRAMS
- D = DRAMA
- MU = MUSIC
- R = RELIGIOUS
- V = VARIETY

Figure 8-15.-AFRTS radio program ratings form.

PEAK PERIODS

The time blocks may vary from location to location, but these peak listening periods generally occur Monday through Friday during three dayparts:

- **Morning drive time.** People are waking up, planning for the day and driving to work or school. Programming should be up-tempo. This is when they want news and information concerning the weather and the activities of the day.
- **Midday drive time.** Fewer sailors and marines listen. However, news is once again highlighted at noon. This period falls during the lunch break, and many people tune in for both information and entertainment.
- **Afternoon drive time.** Finds people driving home from work and tends to attract younger audiences out of school. The music generally increases in tempo while the emphasis shifts back to news, time and updates on the happenings of the day.

Nonprime-time and “fringe” time dayparts may also be identified as useful in making programming decisions.

OTHER SIGNIFICANT DAYPARTS

Now that the common prime-time periods have been identified, it will be helpful to consider other periods of the broadcast day with regard to audience activity.

- **Time segments after morning drive and midday drive.** These periods often represent the times when the majority of the audience is occupied (working or at school). Other audiences that can be served during this period include family members, hospital patients, mess personnel, and so forth. Onboard ship and in many workshops ashore, the radio will still be on. But in general, there will be a smaller number of listeners so AFRTS-BC programs could be scheduled in this period instead of the live shows of your station.
- **Time segments after afternoon drive.** Audience listening habits will become more static. Listeners who are going to be away from their radios during the evening will have completed their preparations and have already left or they

may be watching television. Normally, those listeners who remain will continue to be attentive for at least part of the evening.

SCHEDULING PROGRAM MATERIAL

It is generally accepted, both in commercial and military broadcasting, that prime-time programming should be directed to the target audience, regardless of how diverse the audience makeup. Because music is the most important type of radio program and music “sells” the information, a DJ show is the best vehicle for that information. This idea can be fine-tuned to consider the needs of a station’s immediate audience. As a result of geographic separation, NBS detachments must respond to different audience needs than the network or key station. The best way to meet these local needs is with a locally produced DJ show.

Local Live Music Shows

The local live DJ show should include information of immediate interest to the local community. This reinforces the purpose of scheduling local live time in prime-time. An AFRTS-Arbitron survey concluded that the best way to meet the varied tastes of the military audience was with a “mixed music” format—a skillful blend of top-40, country, urban and adult contemporary music. If your survey indicates audience interest and your station has the capability to counter program (explained later), there might be a situation calling for programming other than mixed music in local time. The AFRTS-Arbitron survey concluded that country was also a significant format, and considering programming strategies, might be a viable prime-time local show format.

Given sufficient manpower and audience interest, local live DJ shows can be slotted at times in the schedule other than prime time. However, local live prime-time should be programmed first. The following are additional considerations when you program local live time:

- Audience survey results indicating local prime-time (when to schedule)
- Audience survey results showing music preference (what to schedule)
- Station manpower resources (how to work it)
- Requirement for percentage utilization of AFRTS-BC package that might limit local time

AFRTS “CANNED” Shows

The bulk of your radio programming is made up of syndicated shows furnished by AFRTS-BC. Refer to the quarterly AFRTS radio program ratings form for a list of available material. These materials are categorized according to the AFRTS distribution scheme (See DoD 5120.20-R for the procedures to manage AFRTS radio program materials).

This material should be programmed according to the needs of your audience and the capability of your station to provide locally produced shows. It should not be used in prime-time if a local show can substitute. This programming is primarily blocked horizontally, but a few shows are vertically blocked because of their length and frequency (see figure 8-15; The Countdown, 110-220 minutes once a week).

Each program shipment contains many types of programming to meet specific audience needs and to provide a variety of program sources. Some of these are as follows:

- **DJ shows of various music formats.** These are meant to afford listeners who like one particular type of music the opportunity to listen to a solid hour of top-40, album rock, country, urban or some other type of music. On the average, about 75 percent of the programs in the AFRTS-BC package are 55 minutes in length.
- **Special programming from the package that does not fit music or drama categories.** There are five-minute information shows that can be used to round out a half-hour or hour segment. Documentary material may occasionally appear in the weekly shipment.

This mixture of formats and show types allows us to successfully please the majority of our listeners at those times we have access to them.

The AFRTS-BC canned shows also solve a manpower problem by furnishing the majority of material for the programming day.

News and Sports

The AFRTS-BC audio line is the cornerstone of all field news and sports activities in AFRTS. It operates 24-hours a day, providing news and sportscasts and live coverage of events, as well as commentaries and analysis. This is supplemented by local live news and

sportscasts when manpower and news sources allow it. The most common news vehicles are as follows:

- The five-minute newscast scheduled on the hour which is designed to provide “headline” news to the audience
- Expanded radio newscasts scheduled in prime-time which are an in-depth treatment of news topics covered in a five-minute newscast

The short newscast is a scheduling constant at NBS detachments which provides information in a palatable form. However, depending on your survey results, the expanded news block may be more desirable. Expanded news might include a lengthened newscast, a sportscast, weather and in some cases, news commentary.

MASTER PROGRAM SCHEDULE LAYOUT

To lay out the master program schedule, the programmer should make up a schedule form to serve as a work sheet that can be duplicated for future use. Doing this will save the programmer time and effort when the schedule is changed. (This assumes that the programmer does not have access to a computer program set up for programming, such as ONET.)

The program schedule work sheet lists programming time blocks vertically, as in figure 8-16. Then, days of the week should then be listed horizontally. This layout enables you to horizontally and vertically block your program material in a manner that will be readily understood.

In filling in the work sheet, you need only to write the program name in the appropriate day/time block and then draw an arrow to the end of the program block. As figure 8-16 shows, this graphically indicates horizontal and vertical program blocks.

Before you schedule program material, you must know the length of the program and how many times a week it is to air. This will ensure that the schedule on paper works out in real-time programming.

Once you have completed the work sheet and checked to make sure the program times are correct, transfer the information to a more formal master program schedule sheet (see figure 8-17). Each master program schedule must contain the following:

- Day and time of broadcast
- Name and type of program
- Length of each broadcast

	MON	TUES	WED	THUR	FRI	SAT	SUN
2400	← 15 MINUTE NEWS →						
	← CBS MYSTERY THEATER →					LIVE LOCAL	SHOW
0100	PETE SMITH					AT 40	ACC
0200	MARY TURNER					AT 40	ACC
0300	DON TRACY					AT 40	ACC
0400	GENE PRICE					AT 40	TOM CAMPBELL
0500	THE MORNING SHOW					SWINGING YEARS	
0600	← 30 MIN NEWS (WITH PAUL HARVEY) →					NEWS, SPORTS, FEATURES	BLACK BEAT
	THE MORNING SHOW (live/local)					BAIT OF EDEN	SCAN
0700	THE MORNING SHOW (live/local)					SAT. MORNING SHOW (local)	COUNTRY CROSSROADS BANNERS. FAITH
0800	CHARLIE TUNA						AMEN CORNER
0900	CHARLIE TUNA					ALL THAT JAZZ	HISTORY R & ROLL
1000	PETE SMITH					KRIS E. STEVENS	SUNDAY MORNING SHOW (local)
1100	MARY TURNER						
1200	← 30 MIN NEWS, SPORTS, FEATURES →						NEWS HARVEY
	← JIM PEWTER →					FOCUS ON THE FAMILY	LOVE ON THE ROCK
1300	CHRIS LANE					DOUG ORDUINO	ACC
1400	DON TRACY					AT 40	ACC
1500	HARRY NEWMAN					AT 40	ACC
1600	THE AFTERNOON SHOW (live/local)					AT 40	HUMBLE HARVEY
1700	THE AFTERNOON SHOW (live/local)					AT 40	
1800	← 30 MIN NEWS, SPORTS, FEATURES →						TOM CAMPBELL
	← JAZZ BEAT →					LARRY SCOTT	
1900	WOLFMAN JACK					SOUL SURVEY	
2000	LOUISE FOSTER					DICK CLARK	LIVE FROM GILLEY'S
2100	GENE PRICE					KING BISCUIT	30 MIN NEWS
2200	← 15 MIN NEWS →					OFF THE RECORD	T. FIELDS
	← NIGHT MOVIES (live/local) →						SUNDAY NIGHT SHOW
2300	← NIGHT MOVIES (live/local) →					SAT. NIGHT SHOW (local)	(local)

Figure 8-16.-Program schedule work sheet (radio).

STATION WEEK AIRED _____ UNIT NUMBER _____		AFRT	MASTER SCHEDULE RADIO				(SAMPLE — PARTIALLY COMPLETED)	
LOCAL TIME	SUN	MON	TUES	WED	THUR	FRI	SAT	
0700	NEWS-S	NEWS	NEWS	NEWS	NEWS	NEWS	NEWS	
0705	OPEN DOOR RU	S	S	S	S	S	S	
0715		THE MORNING SHOW S-RL	THE MORNING SHOW S-RL	THE MORNING SHOW S-RL	THE MORNING SHOW S-RL	THE MORNING SHOW S-RL	THE MORNING SHOW S-RL	
0730	BANNERS OF FAITH RU							
0800	NEWS-S	NEWS-S	NEWS-S	NEWS-S	NEWS-S	NEWS-S	NEWS-S	
0805	CROSS CURRENT RU	CHARLIE TUNA RP	CHARLIE TUNA RP	CHARLIE TUNA RP	CHARLIE TUNA RP	CHARLIE TUNA RP	THE COUNTDOWN RP	
0830	LOVE ON THE ROCK RU							
0900	CHURCH SERVICES	NEWS-S	NEWS-S	NEWS-S	NEWS-S	NEWS-S	NEWS-S	
0905	R	HARRY NEWMAN RP	HARRY NEWMAN RP	HARRY NEWMAN RP	HARRY NEWMAN RP	HARRY NEWMAN RP	THE COUNTDOWN RP	
0930	SALT LAKE CHOIR RU							
1000	NEWS-S	NEWS-S	NEWS-S	NEWS-S	NEWS-S	NEWS-S	NEWS-S	

SOURCE: S - STUDIO
 RL - RADIO LIBRARY
 RU - RADIO UNIT
 RP - RADIO PRIORITY UNIT
 R - REMOTE

Figure 8-17.-Master program schedule sheet (radio).

- Number of times broadcast each week
- Source of program

WEEKLY SCHEDULE

The weekly schedule differs from the master program schedule in that operational information is left out while program highlights are included. These program notes must be brief, but if space permits, should be enough to attract the interest of the audience. This is basically the same as the weekly television schedule discussed earlier.

Audience surveys and their data are important considerations when you plan programming strategies. Your knowing how to produce and analyze survey data is obviously a major part of being a broadcast supervisor. However, for the print journalist and the public relations practitioner, understanding survey production and how it functions is also paramount. If the senior journalist and PAO are ever to achieve the “work smarter, not harder” catch phrase, each must understand and use the information in Chapter 9 on a regular basis.

TACTICS AND SCHEDULING

In the “Television Programming” section of this chapter, we covered the two techniques of program blocking: vertical and horizontal. For the full week of radio programming, using both vertical and horizontal blocking techniques is most often seen (fig. 8-16).

As with television programming, vertical blocking is arranging your program segments for a one-day period in a vertical, or up and down fashion. Scheduling two consecutive hours of *The Countdown* at 0805 on Saturday would be to vertically block the show.

Horizontal blocking is arranging your program segments for two or more consecutive days so that repeat programs form horizontal, or left to right lines. Scheduling the 55-minute *Charlie Tuna* program at 0805 for five consecutive days is an example of horizontal blocking.

On a master radio program schedule you will have both vertical and horizontal blocking, depending on the scope of your consideration. The program blocking for the day would be vertical, and two or more consecutive days would be horizontal.

NBS detachments are unique in that many military communities are often served by one radio station. The tastes and preferences within these communities are diverse. To better meet these needs, many NBS

detachments are equipped with both AM and FM stations. Considering your target audience is only available at certain times of the day and that there is a shortage of radio entertainment sources to suit their diverse tastes, counter programming (simultaneously scheduling programs with different appeal) the AM/FM schedule offers an innovative way to satisfy those special audience needs.

Traditionally, the AM service involved a program schedule of lead prime-time music shows and blocked AFRTS-BC produced programs during prime time. When the FM-stereo service was introduced, it featured only “beautiful music” and was usually completely automated. This type of counter programming allowed the station to serve the typical AM radio listener who enjoyed a contemporary sound while satisfying a special interest group who preferred a more sedate music sound. Since the AFRTS-Arbitron survey found that the bulk of the beautiful music format audience was over 35, it also made the job of communicating command information easier. The message could be aimed toward either the under-35 or over-35 segment and handled in a manner that best communicated to them.

The young adult in the military of today has grown up listening to rock and other contemporary music on FM-stereo. Advances in technology and lower prices have brought good quality FM-stereo receivers within the reach of most of the audience. Considering this audience expectation of how FM-stereo should sound, many NBS detachments counter program less traditionally.

To be responsive to the current audience preference for a contemporary-formatted FM service, some NBS detachments are programming local live contemporary music shows according to local audience tastes. Contemporary format AFRTS-BC canned shows, directed at special interest audience segments, are also scheduled on FM.

The contemporary sound of the FM service is counter programmed on AM with beautiful music and adult contemporary canned shows from AFRTS-BC. Local live shows continue with the mixed music format. This counter programming allows you to serve more special interest groups with programs tailored to their various tastes. Your station’s latest audience survey is invaluable in discerning special interest groups and their listening habits. This data can show you if there is a need to counter program, and if so, to what extent.

As a broadcast supervisor, you have to consider the additional manpower needed to perform more local live

programming or operate master controls for both AM and FM services.

If you decide to counter program your AM/FM services, first consider two points:

- Do not abandon the beautiful music format. It is an available source that satisfies a significant audience segment.
- Do not turn your FM facility into an album oriented rock (AOR) station. It is too valuable a medium to limit its appeal to only one audience segment.

PRODUCTION

Learning Objective: *Understand the principles, activities and personnel requirements of broadcast production.*

When people talk about broadcasting, they most often mean news programs or documentaries. These two formats of broadcast communication are in fact what we, as Navy broadcast journalists, primarily use to convey our messages. This section of the chapter details the procedures and techniques a supervisor must be skillful in to lead a broadcast production team.

BASICS OF BROADCAST LIGHTING

Just as in still photography, videography is the art of controlling light. Most of the basics of photography, such as composition, exposure and lighting, transfer to videography and should be followed where applicable. However, there are specifics of video production that must be addressed.

Currently, broadcast quality video cameras are set up to reproduce colors accurately at 3200 degrees Kelvin (3200°K). Color temperature is also measured in degrees Kelvin and 3200°K is the color temperature produced by tungsten halogen lights. (Tungsten halogen lights are the most widely used source of artificial light in the broadcast industry.) If the light entering the camera lens is less than 3200°K, then the video product will have a reddish hue, such as when you are shooting indoors under incandescent lighting (about 2800°K). If the light is more than 3200°K, such as when you are shooting outside in bright sunlight (about 5500°K), the video product will look green to blue in hue. Your understanding these changes in color temperatures from various light sources is of paramount importance because you cannot get a true “white balance” with your video camera unless your camera is “seeing” light at

3200°K. The white balance is defined as the absence of color at white, and in a sense, is used by the camera to set the standard of its color reproduction to match what the human eye perceives as color. To get this absence of color for white at different light levels, there must be some sort of color temperature compensation when you are not shooting at 3200°K. That compensation is done by the use of filters.

Filters

The filters on most video cameras currently being used by Navy journalists are placed just behind the lens of the camera and are there to control the color temperature of light entering the camera. These filters are held in place by a filter wheel and are usually numbered one through four. Sometimes a fifth position is used to totally eliminate light from entering the camera and is used the same as a lens cap would be used. The positions and numbering of the filters will vary from camera to camera; therefore, close scrutiny of the operator’s manual is advised to enable the correct choice of filter for a given lighting situation. The following list shows the filters most commonly found on broadcast quality cameras:

- **Fluorescent light filters.** Light source is approximately 4500°K. Shooting without the proper filter produces a greenish to bluish hue. (Many cameras have two fluorescent light filters. One for the 4500°K color temperature and one for daylight fluorescent tubes with a color temperature of approximately 6500°K)
- **Neutral-density filters.** This filter has no effect on the color temperature of the light entering the camera, but it does reduce the amount of light reaching the imaging sensors of the camera. This reduction in exposure maybe used to reduce the depth of field of your shot or to simply reduce the amount of light while you are shooting under very bright conditions.
- **Direct sunlight and dusk/dawn filters.** A direct sunlight source is approximately 5400°K. Shooting without the proper filter in such a situation produces a bluish hue. As a rule of thumb, use this filter an hour or so after sunrise and an hour or so before sunset. During the time periods just before sunset and just after sunrise, the natural light color temperature is usually very close to the camera’s optimum color setting of 3200°K and taping can proceed with a colorless

filter. Use a color temperature meter to determine the exact temperature.

NOTE: Always make a color temperature meter reading when in doubt of what filter to use and make sure the reading comes from the light falling on the subject. If the subject is someone's face, then take the reading within a foot or so of the subject's face. This enables the color temperature meter to read, accurately, the light falling on the subject.

Lighting for ENGs

Using ENG lighting for every stand-up is a rule often made by news directors. It assures proper and similar coloring of all talking head skin tones seen on the program and prevents the odd blue, green or red hued interviewee from appearing in reporter's stories. This is because all facial shots will be shot under a 3200°K tungsten halogen light source and will give the program a professional "downtown" look. This is not to say a naturally lighted interview or stand-up cannot be used, but such lighting should be used for an effect and not because the ENG team did not want to bother with lights.

For most indoor shoots, there will be a ceiling or an overhead within eight to 10 feet. This allows you to bounce light off the ceiling onto your subject, which produces a softer, more natural appearing light. It appears more natural because the human eye is used to having its light source come from above as it does in nature. If you cannot bounce the light, such as in a gymnasium or in a ship's compartment with all sorts of light catching pipes and wires in the overhead, you can still avoid the "news light glare" by using a screen or a scrim (diffuser) on the light.

Night ENG Lighting

The first impulse of shooting at night is to overlight the subject. Keep in mind that the more you light the subject, the more the contrast produced between the subject and the background. If you are shooting a stand-up in front of an evening ship arrival, overlighting will make the stand-up look as if it were taking place in a blacked out studio. A single diffused camera-mounted light is usually sufficient in such a situation.

MICROPHONE USAGE

There is one golden rule concerning the use of microphones in broadcasting: place the microphone where you will get good audio from the subject you are shooting. That seems obvious, but the experienced news

director knows how often the ENG team will come back with muffled sound. Most often the cause of this is the sound coming from a camera-mounted microphone when a lavalier microphone clearly should have been used. Or perhaps the lavalier microphone was hidden so well the speaker's voice could not penetrate the layers of clothing it was stuck to.

Placing the Microphone

Remembering what you just read in the preceding paragraph, the microphone should be kept from becoming too great a part of the video image in your stories. For the vast majority of ENG shoots, a lavalier microphone can be clipped on the reporter or the interviewee in such a way as to not distract the viewer's attention. Usually interviewees are more than willing to slip the lavalier up the front of their shirts and clip it on the neckline. When this is not possible, such as when shooting a busty woman in public, simply bring the microphone around to the front of the subject from their backside and clip it to a fold in the subject's clothes. You might have to make a wrinkle to have a fold, such as in the case of someone wearing a crew neck T-shirt, but this is certainly preferable to using the audio from a camera microphone. Camera-mounted microphones should be used for natural sound and not for picking up voices that will be used as sound bites. Also, be careful not to let clothing or chins slap against the microphone during the shoot. This will sound like thunder on the tape and ruin your efforts.

Conferences and Panels

As a Navy news supervisor, you will undoubtedly be called on to cover news conferences and other news events involving more than one speaker at a time. Obviously, if a panel discussion is taking place within your studio, each speaker should be fitted with a lavalier or a wireless microphone. However, on ENG shoots where this is not possible, the following are a few tips for you to ensure good quality audio:

- Know the distance from where your camera will be to the talking members of the conference and bring along enough microphone cord to go between your camera and the subjects. This is best accomplished by visiting the sight the day before (if possible) or by arriving as early as possible. (Arriving early will also get you the best spot to shoot from.)
- Arriving early will also let you establish a rapport with the speaker or speakers. This might make

them more likely to address you when they start speaking and that will give you the better looking sound bite.

- Most press conferences will have a microphone stand or a mult-box already setup for the public address system. **DO NOT SET YOUR MICROPHONE IN FRONT OF THE PUBLIC ADDRESS SPEAKERS!** This will produce over-modulated sound. If you do not have a place for your own microphone stand to be placed, clip your microphone onto a microphone already in place. Your lavalier clip should clamp nicely on the cord of someone else's microphone.
- **Avoid taping the microphone to the lectern that the speakers will use.** Most speakers will tap, grab or shuffle papers on the lectern surface, and if your microphone is taped to the same surface, you will get a lot of noise in your audio.
- **Always check your audio on the VU (volume-units) meter and confirm it with an earplug.** Never trust a dancing needle on the side of a camera. You may be just picking up the rustling of your own jacket from the camera microphone. Listening with an earplug will also let you check the quality of the sound and not just the volume.
- **Keep quiet during the shoot.** Nothing is more infuriating in the editing room than having a great sound bite ruined by the giggle or gabbing of the news team. You may think a soft whisper will not be picked up by the microphone or could not possibly make its way onto the finished product, but it will and can.

VIDEO EDITING

The basic editing techniques described in the *JO 3 & 2* training manual give you an idea of what the pieces of the editing puzzle look like. In the following section, you will get a working knowledge of how to use those skills learned earlier in your career and an understanding of the editing process that will make your job of training fledgling broadcast journalists easier.

Time

Editors must be aware of two "time" concerns. The first is the journalist's old nemesis, "The Deadline." Much of Navy video editing takes place within relatively leisure deadlines of days. These are feature

pieces that are timely within a few weeks of the event. However, when you are working at an NBS detachment or a large afloat command that produces a nightly news program, you will know what the word deadline means. Time is the demon on the shoulders of the video editor. If the photographer did not shoot in sequences or shot 20 minutes of tape for a 90-second story, the editor will have to search the entire tape for usable material.

The second time concern is called filmic time. This is the compression of hours, days or even years of real time into a minute or two-minute story. The passage of time in the movie *Gone With The Wind* spans the entire Civil War, but of course, the movie only takes three hours to view. Again, with the use of cutaways and cut-ins and correctly taken shot sequences, compressing real time to filmic time is an easy and natural process for the editor. For example, the building of a bridge on your base took eight months. During the construction phase you have done stories about the work and in the end you can do a final story showing the entire eight-month construction process within a minute or so of filmic time.

Time Savers

Most Navy broadcast journalists will act as reporter, editor and often even as camera operator during their own ENG shoots. This is also the norm for civilian news organizations that employ "one-man-band" news bureaus in various towns within their general area. When you are in such a situation and a deadline is to be met, the following story production process works best.

You already know the gist of the story and the angle you are going to take with it because you have been thinking about it since you received the assignment, did whatever background research possible and finished the last interview. Now it is time for you to sit down with your notes you took during the interviews and decide what sound bites will best enhance the story. Determine the exact time length of these sound bites as well as your stand-ups and proceed to write the rest of the story. If you are working for a newsroom that wants intros written by the reporter, then write the intro last. Intros are supposed to be the hook to keep the viewer interested in the upcoming story and are not to be used as a dumping ground for information the reporter could not figure out how to put into the story.

Once you have your narrative written, read it aloud and time it. This time amount, plus the lengths of your stand-ups and sound bites, will give you the length of your story minus any cold start video openings, the short

video ramp in the beginning and the video tail at the end. Both the ramp and tail of a news story should be only two or three seconds of video with natural sound. This is done to let the switcher in the control booth put the story on the air without airing black or missing the first words of your story.

Outs are written for the anchors to read as a way of easing the transition from story to story or as seques into another section of the news show. Like intros, outs are not to be written because the reporter could not condense his story to an acceptable length. Most often intros and outs are written (or at least rewritten) by the anchors so the voice is in the news anchor's own style.

SCRIPTWRITING

The basics of broadcast writing are known to all journalists through the efforts of DINFOS and the *JO 3 & 2* manual. The following guidance helps the experienced broadcast journalist train staff members in the peculiar world of television writing.

The scriptwriting process for news stories must always begin with pictures. (Remember, the previously mentioned **time saver** technique of story editing is to be used only when meeting crushing deadlines.) As stated earlier in this chapter, a story with pictures just flopped on top of it as "cover video" is radio news with pictures. This is a hard concept to understand for most journalists, so spend some time on this next paragraph and think about it over and over in your mind until every time you start the reporting process in television, you do not fall into the announcer mentality (that is, thinking of words before pictures).

Television news, unlike radio news, is not the simple transmission of facts to a listening audience. In radio news, the spoken word can be used as a one dimensional vehicle to relay information from point A to B (reporter to audience). Television has to be a reconstruction of the news event itself. You may have all the facts on hand, but it will not interest an audience, nor will the audience even possibly understand it if you use words (script) as your primary information transmission carrier. You must take the viewer to the scene and **show** him what is going on. People **watch** television news to see what is happening, not to hear what is happening. The video is the base from which the television journalist must work. Along with this basic video information channel, the journalist then uses narrative and sound effects to carry additional illuminating information and details.

An example of this would be an individual watching a story about the rising number of welfare recipients in the United States and then **seeing** some image that shows him that fact. In this scenario, the following depictions would be appropriate: pictures of recipients picking up their checks, shots of how life changes for a family when Dad loses his job or graphics (bar chart) that display the increase in welfare recipients compared to tax increases.

NEWS

Learning Objective: *Understand the principles, activities and personnel requirements of newsroom organization.*

What is or is not news is a discussion most journalists started having during "A" school and will continue to have until they die. In this section, we simply state that news at your station is going to be what you, as the supervisor, decide it to be. For example, the requirements for a news story to air on Navy News This Week will need to be of Navy-wide interest while the news peg for a local story will be very different most of the time. If you are working at an isolated duty station, such as Adak, Alaska, news is going to mean primarily sports and family oriented events (a typical small town news format). The reasons for that particular decision is based on the large family population and the large unmarried, predominately male, barracks population. The faces of children and sport activities were what the audience wanted to see (that information is based on, of course, various audience surveys). You have to know your audience and satisfy their needs to "sell" them command information. (World and national news is part of the command's information package in this discussion). Think of command information as the product that must be sold to keep the station open.

NEWSROOM ORGANIZATION

As always, the organization of any activity in broadcasting depends on the specific requirements and the available manpower. Therefore, for the purposes of training, we will discuss the positions needed to complete a nightly half-hour news requirement. Usually, such a demand is made when the manpower consists of the following: a PH2 or below to help fill the ENG shooting and editing roles, a JO1 or JO2 as news director/assignment editor and two JO2s or below as reporters. (Often an IC technician is added to the newsroom as the ENG gear caretaker or trouble shooter).

NEWS DIRECTOR/ASSIGNMENT EDITOR

As the station OIC or operations head, you will have to think of the news director/assignment editor as your right-hand man. This petty officer will be the eyes and ears of your station and the decisions he makes will make or break the image of your detachment. The news director/assignment editor of a nightly news program will always make assignments that day for that night's news. This is necessary for him to avoid a strictly happy talk format of canned ENC packages. However, the news director must also plan ahead to develop those stories that will require some research. The best way to keep assignments in everyone's mind and to enable such planning as, gathering background material and thinking about shot sequences, is to have an assignment status board. This may be a chalkboard or fancy plexiglass arrangement that is lined off to show days of the week reporters names and dates due for the story listed. This will also give the news staff quick and easy access to what is happening as well as when ENG shoots maybe scheduled.

Assignment editors are made for the grind of finding news. They must constantly think of how to till that nightly news hole. Some good places to look for stories are as follows:

- **Beat calls.** First and foremost, use the beat call system to keep in touch with your audience and news sources. Make a list of every important office or influential person that could possibly generate or inform you of news and call them once every week. All successful newsrooms will do beat calls to keep the channels of communications open between your newsroom and the public. (One harried and successful civilian journalist in North Dakota, of all places, made over 400 beat calls to various news sources every month. That is commitment!)
- **Calendars with historical notations.** A good newscast will have one or two things in history (Navy or otherwise) for each day of the year. Sure, some of the events are downright strange, such as the development of the Hula Hoop, but think back to television reports civilian professionals did on that day. You would have thought the Hula Hoop was a religious icon.
- **Print publications.** Read the paper and weekly news magazines. Localizing *Navy Times* stories should be a weekly effort of any NBS detachment. For example, the story about COLA

cuts in *Navy Times* will provide the background for a story featuring a young sailor and his family on your base to describe how the cuts will affect his family. Put a human face to every story.

How much of a news hole is there to fill? For most military stations, the news hole remains stable because the commercials are all command information spots. For a typical half-hour news show, a time sheet might look like those displayed in figure 8-18. The exact nightly format should be left open to the news director and should remain as flexible as possible so as not to bore the audience with the same, down to the second format each night.

REPORTERS AND PHOTOGRAPHERS

For the most part, reporters and photographers are interchangeable at military stations. After some basic training, there should be no reason why a PH3 cannot write the script for a news package or why a JO3 cannot shoot an evening basketball game for tomorrow night's sports.

BASIC VIDEO NEWS

Many news directors have found the PH rating, because of its more in-depth training in visual imagery, to be a better source of broadcast journalism stories than many DINFOS trained journalists. For most photographers there is no tendency to write the story and then go out and find the pictures. They correctly assume, by their nature, that it is the pictures that will tell the story in television. Remember, train your reporters and photographers to be photojournalists. That means they must tell the story visually first and then add the natural sound and sound bites to a script. You want neither talking books nor picture radios. You want a visual story with a beginning, middle and end that is backed up with sound and words. Remember to tell all your reporters to keep this in mind whenever they work in television news. A good training technique for you to develop this sense of visual story telling is to have each of your sailors shoot a feature story that will have no script or sound bites. This technique is used in just about every university that teaches movie making or photojournalism and is now becoming more accepted in the best broadcast journalism schools in America.

Sequence Your Shots

Researchers have shown that when you look at an object, you first see it in relation to its surroundings, then as a single object and then various parts of the single

**LOCAL NEWSCAST
TIME SHEET "A"**

<u>SOURCE/LENGTH</u>	<u>RUN TIME</u>
Video intro (:15)	18:00:00
World/national news (5:00)	18:00:15
Spots (2:30)	18:05:15
Local news (9:30)	18:07:45
Spots (2:30)	18:17:15
Weather (3:15)	18:19:45
Spots (2:00)	18:23:00
Sports (4:30)	18:25:00
Ending shot/credits (:30)	18:29:30
END OF SHOW:	18:30:00

Figure 8-18.-Local newscast time sheet.

**LOCAL NEWSCAST
TIME SHEET "B"**

<u>SOURCE/LENGTH</u>	<u>RUN TIME</u>
Video intro (:10)	18:00:00
Local news (6:20)*	18:00:10
Spots (1:00)	18:06:30
World/national news (4:00)	18:07:30
Spots (1:30)	18:11:30
Sports (4:00)	18:13:00
Spots (2:00)	18:17:00
Weather (2:00) (On-air segue)	18:19:00
News (3:00)** (On-air segue)	18:21:00
Ending shot/credits (1:00)	18:24:00
Pre-recorded community events (5:00) (chat show)	18:25:00
END OF SHOW:	18:30:00

* — Many overseas locations use local news as the primary hook to gain viewership. This is a proven technique practiced by many successful small and medium market news programs.

** — Very often this segment features news "on the lighter side."

(Note: An on-air segue consists of a very brief dialogue between anchors followed by a camera shot change.)

Figure 8-18.—Local newscast time sheet-Continued.

**LOCAL NEWSCAST
TIME SHEET "C"**

<u>SOURCE/LENGTH</u>	<u>RUN TIME</u>
Video intro (:10)	18:00:00
World/national news (4:00)	18:00:10
Spots (1:00)	18:04:10
Local news/weather (5:00)*	18:05:10
Spots (1:00)	18:10:10
Sports (3:30)	18:11:10
Ending shot/credits (:20)	18:14:40
END OF SHOW:	18:15:00

* — If desired, you can segue into a short weather segment (with CG graphics) toward the end of the local news segment.

Figure 8-18.-Local newscast time sheet-Continued.

object. That is exactly what you should do when you shoot your news stories. It does not mean you may not start a package with an extreme close-up of a sweaty and straining face and then slowly pull back to reveal a weight lifter training for the Olympics. Just remember, effective story development allows the mind to work while viewing your story the same way it does naturally every day. That way, your information will not be interrupted by the mind of the viewer trying to piece together several unrelated video cuts.

Show Your Point

Whatever the gist of your story the main point must somehow be shown to the audience. As an example, if the point of your story is that 400 would-be Navy recruits were turned down for naval service this year due to AIDS, you can do a stand-up in front of a mothballed destroyer and draw the following comparison: "It takes 400 sailors to man a ship of this size, and that is how many recruits were turned away from naval service due to AIDS this year."

FIELD SHOOTING TECHNIQUES

By the time a JO2 or JO1 starts to study for JO1 or JOC, he will already know the basics of photography. This section will relate some of the specific video shooting techniques that are proven over time and practiced by all professional news photographers.

Tripod

Use a tripod whenever possible. Nothing looks more amateurish than shaky hand-held video. There are very few situations that require a photographer to "John Wayne" a \$30,000 Betacam on his shoulder and shoot a stand-up. With that being said, when you are in a situation demanding that you handhold the camera, use your body as a tripod. Leaning against a wall while placing your weight on the outside foot will give you good stability.

Another technique is to kneel down with your buttocks resting on the heels of your feet. This will also give you a different angle for your viewers to see from, which is always a good idea to try during a shoot anyway. When there is no sturdy object to lean against, spread your legs to shoulder width and shoot at the shortest focal length (widest angle) possible. The more the picture shows, the less likely the viewer will notice that the scene is shaking from side to side. Again, if all else fails and you must shoot a close-up from an unassisted hand-held stance, then hold the camera as if

you are shooting a rifle. Hold your breath as you concentrate on keeping the camera as steady as possible until the shot is over.

Taking the Moving Shot

When you shoot a moving object, it is best to set the zoom at the shortest focal length possible (zoom out as far as you can) to minimize the appearance of camera movement. If your viewers notice obvious camera motions, they will be distracted from the information you are trying to show them. However, there are times when shooting action demands a hand-held camera to follow along. An example of this would be shooting a person walking. In this situation, shoot the walker with as wide an angle as possible without ruining the composition. This will let the viewer see more of the background and be less likely to notice erratic movements of the hand-held camera. However, such a shot is best achieved with the subject walking toward a tripod mounted camera that is slowly zooming out as the subject walks toward the camera. This gives the effect that the camera is keeping pace just in front of the walker. Whenever a subject gets closer to a camera lens, it will appear to get bigger. Practice it a few times and you will see how the effect can work. Also, do not forget to tilt the camera up or down as needed when you zoom.

Zooms and Pans

In general, zooming and panning are used only to reveal something new in the scene or perhaps as an effect as mentioned in the preceding paragraph. Nothing labels a work as amateurish more than the roller coaster and tilt-a-whirl effects caused by a heavy dose of zoom-panitis.

Move

Shoot whatever it was you set up your camera to shoot and then move the camera to the next scene. This sounds obvious, but one of the most common errors new reporters and photographers succumb to, is leaving the camera in one spot and shooting the whole story from that position. The camera might swivel from left to right but never move from that location. Shoot and move should be the motto of every photographer. This philosophy will also help when editing because there will be less chance of a jumpcut getting into the story.

Shooting Stand-Ups

First, let us accept the fact that stand-ups are necessary to a broadcast news show and must be shot. Many young military journalists are under the mistaken impression that stand-ups are done by civilian journalists only in an effort to reach stardom. It certainly is a factor in getting the civilian journalist noticed and known to the producers and public of the news show, but it still is not the only reason stand-ups are done. The stand-up will place the reporter as actually being there at the scene of the action. With a stand-up, the reporter can often convey vast amounts of information about the story with a few quick images. For example, a reporter wearing a Marine parka and shaking with cold as he seques into another wonderful sequence of shots, certainly does not have to spend anytime describing the terrain in which a particular Marine unit is working in. Likewise, the reporter sweltering in tropical dress whites does not have to mention the heat on Guam.

Many times stand-ups help create visuals for an otherwise dry story. An example of this would be a stand-up outside the local school introducing the agenda before the school board tonight. his “created” visual is often overused, however, by the lazy reporter, especially when most of the reporter’s sound bites are shot in the editing booth.

One-Man Band Shoots

Lugging around tens of thousands of dollars worth of video equipment by yourself is not only very tough, it is an unnecessary risk to the gear. You should always have two-man news crews on field shoots. However, if there are extenuating circumstances and a one-man shooting assignment has to be made, the following tips may help your people deliver a good product.

- Doing an interview while you are also shooting the interviewee is best achieved when you do the following: set up the camera shot of the subject and then tell the subject to look at a designated spot that you will then move to while conducting the interview. Tell the subject exactly what you are doing and let him in on the process. This will make it easier for him to play along and hopefully not shift his position.
- Shooting your own stand-up may sound silly, but it is possible. Take a light stand and place the white balance card on it at the same approximate height as your face. Do the white balance and also focus on the card, using the edge of it to exact the

focus. Then move the stand back a few feet and stand exactly in its place.

With practice, both of these tips can produce usable products. But remember, they are to be used in emergency situations only and not as a regular shooting technique.

TALENT

The on-air talent of any news production, whether that talent is the news anchor or the reporter doing the stand-up, is the final tool in the communication process. All the technical tools of the trade and all the good writing, editing and production will fail if the on-air talent is not creditable and understood.

THE ANCHOR

There have been countless articles written on the phenomena of the “news anchor” in the television medium. The debate on the pros and cons of media stars and the worth of an anchor will not be discussed here. It is accepted as a fact, backed by much communication research, that the public still demands to have a human face-to-face relationship of sorts with their news programs. As such, it is our duty as Navy broadcasters to supply such human contact to our audiences in order to better communicate our messages to them.

The news anchor of any program, first and foremost, must be a competent broadcaster with an appearance that will not distract the audience from the message he is transmitting. He must also be seen as the person in control of the news program. He must never seem lost or confined and must always appear to know how and where to go during a newscast. Examples of how to project such an image of the anchor follows.

- It would have to be a very unusual news day to prevent the anchor from opening “his” news program with his personal identification. Only a very unique story can start on-air without an anchor’s introduction, much less open the whole program. Such a story might be a “cold start” piece that begins with dramatic natural sound or the sound bite of enormous significance. The scene of President Reagan getting shot was a cold start on most television news programs. But even with such a major story, the news anchor came on shortly after the “cold start” natural sound scene of the Hinckley attack with the program’s identification and his own. Sometimes cold start

identifications take place while the video is still rolling full screen. This technique gives the impression that the anchor is on top of the story and that events are happening even as he speaks directly to us in our homes. With such a start, very few people will turn the channel to Batman. However, therein lies a danger. If the immediate upcoming story that has just been promoted by the cold start really did not deserve such treatment, you will have disappointed viewers who will soon be Batman watchers.

- Story intros and outs should be read by the anchor, again, to give the impression that the anchor is in control of the news program in general. This simply eliminates any viewer confusion on what is happening now and what is coming up. You want your viewers to be thinking about the news being presented and not about how that news is coming to them. This does not mean a story cannot be run visually right into a break without coming back to an anchor. Sometime, such an effect is required. An example of this would be a news segment ending with a story about the death of a national figure. A slow fade to black is followed by a short pause on black and then come back up full to the spot break. Although such endings can be overused, they do prevent the anchor from having to come back and say something trite like “He will be missed” or having to promote the next segment that might be an upbeat sports story.
- If a major story is to be stressed by having a reporter live on the set with the anchor, then make sure the anchor has some intelligent questions to ask that reporter before and after the reporter’s story is aired. Again, this gives the impression that the anchor is in control and will prevent the audience from thinking about why the anchor is even present in the first place. (He is there because if the reporters just appeared on the air themselves, the audience would be thinking about who all these strange people are instead of thinking about the information they are trying to present.)
- As with reporters coming onto the news set, the anchor also introduces the regular personalities on the show. This includes the weather and sports announcers (if available). (Often NBS detachments will give a short voice-over weather report with character generator graphics and the anchor as narrator.) Chats with both talents while

on the set is a given standard for news anchors in the television industry today and should be used on local news programs. This does not mean rampant silliness between news anchor and weather/sports people. It means a quick one-line introduction and perhaps a short, easily answered question to wrap up a segment. Much leeway may be given to an anchor, however, if the anchor is communicating effectively with the audience. Surveys will tell you this by simply asking the audience to rate your anchor’s performance.

- On-air mistakes will always happen and it is the news anchor’s job to ease the transition from a show in trouble back to a show on track. An example of this is when a story is aired out of turn. The anchor should come back on-air and simply say the correct story will be run next or later in the broadcast. The point here is that the anchor should look as if he is still in control, even if he is being told off camera exactly what to do. Remember, if the anchor is made to look stupid, even if it is his own fault, the whole news program will suffer.

NAVY NEWS THIS WEEK

The flagship internal communication device in the Navy, and arguably in the DoD, is Navy News This Week (NNTW). Every broadcast capable unit in the Navy should be aware of, and actively supporting, this program. In general, NNTW will always have space available for hard news stories. Natural disasters, major fleet exercises and accidents are just some examples of the types of stories NNTW seeks. These stories must focus on the Navy’s involvement in such incidents with emphasis on the positive effects made by the individual sailor. Often, Navy-wide policy decisions or equipment advancements are good fodder for NNTW and especially so when the local angle or human factor is prominent in the story. An increase in SRBs for a certain rate can have a human face put to it very easily if you add an interview of a new SRB recipient.

Current requirements for equipment and style formats should be attained from NBS headquarters. This can be done by simply calling NBS or writing them a letter. NNTW is your program and is successful because of input from the fleet.

SPORTS

Learning Objective: *Recognize the unique requirements of sports reporting.*

The sports segment of the nightly news is often the most anticipated segment. This has been proven by countless audience surveys and should be obvious after looking at the demographics of the average military installation. Most military audiences are made up of young men, who are traditionally sports minded. Therefore, it only makes sense to use that demographic fact to hook viewers into watching your internal communications program (the nightly news).

Since sports is so often the big draw for your nightly newscasts, assigning a reporter to do sports full time is the most effective way to organize the newsroom, if possible. Even if you only have a three-man news department, place one the three in charge of all sports stories. A reporter trying to do a sports story cannot possibly understand such things as standings, jargon and team nuances, if sports stories are simply fill-ins when news stories are in short supply. Yes, news will take precedence over sports as far as allotted time during an individual broadcast, but a news show that consistently covers local sports will attract more of the intended audience (young men and women) present at most NBS detachments. Never forget why you are at the NBS detachment in the first place—to disseminate command information to the audience and you cannot do that effectively without first having an audience. To gain and keep an audience, you must give them a reason to tune in and that usually happens by giving them what they want. As you will learn in the next chapter, it is very important for you to read carefully the most current audience surveys, especially since they almost always reveal requests for more coverage of local sporting events.

SHOOTING SPORTS

At first glance, shooting sports seems like an easy occupation. All of the action in an average sporting activity should make it easy to get a few good shots. However, it is not what you are trying to accomplish. When you shoot a game, you must keep in mind the story you are shooting will have a beginning, a middle and an ending just like any other story you shoot. Therefore, while you are shooting, think of the editing you will have to do, and shoot in sequences as always. Remember, sports must be more than just scores and standings. It must have broad appeal and to have such appeal, you must mention the human factor as the most important in

the sports stories. Individual people win the big game and the sportscaster should develop the personal angle to show the intensity and emotion of the wins and losses.

CATCHING THE PLAY

The two main ways to shoot a sporting event with one camera are from up high or down on the field. Shooting from up high makes it easier to follow the action because nothing is hidden from your view. However, down on the field is where the action close-ups come from and the intensity of the sport can be better felt.

Taping the big play is always the goal for the sports photographer and the following tips used by various videographers will help your troops accomplish that mission. (For the purposes of this chapter, we used football and baseball as examples, but the techniques are basic enough to conform to virtually any sport.)

- Zoom in on the key player, such as the quarterback or the batter, and as he makes his move, zoom back so you can follow the action through the lens. As the action develops, zoom back in either on the ball or the ball carrier and simply follow the action. If you try to “stay tight” and follow the ball, you will most likely lose the ball and miss the action. In baseball, it is almost impossible to see the ball after it has been hit. You have to zoom out so you can watch the reaction of the batter (notice the direction he is looking) and the other players. This will give you an idea of which way to pan your camera and of when to zoom in to get a better shot of the catch or dropped ball.
- Make sure you have a location that enables you to view all the action. Nothing is worse than coming back to the station without the winning home run or final field goal. To get cutaways and reaction shots, you have to make some good guesses on when a slack time of the game may occur. Perhaps when the poorest hitter comes to plate would be a good time for crowd shots or close-up cutaways of hands rubbing gloves.
- Good locations for baseball are up and behind home plate or just out of bounds by first base. Up and behind home plate will place the action either coming toward you or traveling away from you, instead of across your field of vision. This makes it easier to follow. You can get a lot of closeup infield action by being by first base, and still be relatively safe from most line drives since most

batters are right-handed and tend to pull the ball down the third base line (especially in softball).

- Be prepared! Know the names of the players and the significance of the game before the event starts. This will allow you to anticipate the big plays and to produce some sound bites with key players before, on the bench during and after the game.
- Some of the best stand-ups in sports stories are bridges at the midway point of the game. An example would be a stand-up describing the first five innings of a ball game that were disastrous for the favored team. The stand-up would then act as a bridge by stating what the favored team must do to win the game. The rest of the story can simply describe whether the favored team succeeded in their attempt or not. Again, a story is something with a beginning, middle and ending.

SPORTS ANNOUNCING

The writing and delivery of sports is different than news copy. For the most part, the delivery has to be upbeat and fast-paced. The upbeat approach is because sports is about a human victory within every game. Often, news is considerably less enjoyable to listen to and can be downright depressing at times. Sports must never be depressing. Even when the home team loses, the players probably played a great game. The delivery is fast paced to convey the feeling of action. Sports is action visualized and verbalized on the evening news program and all elements possible must be used to deliver that feeling to the audience. This does not mean the sports announcer must sound like he has been taking adrenalin pills, but he should appear to be excited about the games he is talking about.

INTERVIEWING

Learning Objective: *Recognize the proper techniques of interviewing.*

When you think of interviewing as a profession, you might think of Barbara Walters and her ilk. Think again! If you are in broadcasting you will be doing interviews whether it is for the nightly news, command information programming or special events, such as telethons and yes, even bingo night on the ship. The interviewing techniques discussed here are used by television, radio and even print journalists.

FRIENDLINESS

All of us have seen the television parody of the broadcast journalist sticking lights and a camera in someone's face and asking the obnoxious question, "How do you feel?" That is the image of the television reporter and, as public relations practitioners, we know how hard it is to change an image. That does not mean we have to act that way to seem "professional." Exactly the opposite is true.

You must let the interviewee know that you are on his side. You are a public relations person for the Navy and are here to help tell the Navy's story. Smile. Always be neat and professional in manner and let the interviewee know exactly why you want to do the interview. Let the interviewee get comfortable and relax in familiar surroundings, if possible. This does not mean letting the CO appear on the evening news with his shirt puffed out around his midsection and lunch crumbs sticking to his lips. It is just less traumatic for an interviewee if he thinks he has a little control of the situation. This will help ease those television camera jitters.

QUESTIONS

Before showing up for an interview, have a good idea what the subject of the interview is about. If you are going to talk with a P-3 pilot about carrier qualifications, you did not do your homework. P-3s do not land on carriers. That will be a tough interview! If it does happen that you are in a rushed situation, with an assignment to do an interview with a person that you have little background information on, stick to the five Ws. You cannot go wrong with them as a starting off point.

Ask a few warm-up questions to let the interviewee know how things will proceed during the interview and then let the person talk. The art of listening should not be forgotten. After all, the interviewee is the one you want to have produce a sound bite. Think how you felt when an authority figure asked you a question and did not say anything after your answer. You probably felt compelled to continue on with your explanation and talk more. Also, save the toughest and more controversial questions until the end. If the subject gets too uncomfortable to answer any more questions, you will at least have something on tape. Additionally, toward the end of an interview, the interviewee should be trusting you more than in the beginning and the answers should be easier for him to talk about.

Avoid the complex question that you often hear screamed at the president during national press conferences. Those questions are asked that way because the president is hard to get to and the reporters try to push as much information at him as possible. You do not have that problem. Good interviewers build each new question on the subject's last answer. This will produce a natural sounding flow, and if done skillfully enough, will make the subject believe he is leading the interview. Let the subject think that. But remember, you have questions that need to be asked and if they relate to an answer just given, you can segue into them in such a way as to make them sound like simple follow-up questions.

Finally, do not be afraid of asking the dumb questions. Many times interviewees will try to make the questions asked of them sound as if they are too dumb to even address. What they might be doing is covering up the fact that they do not know or want to give an answer. Persist a bit (if military protocol allows) and see if the person who would know the answer is available for an interview. Many times an interview will lead to other interviews with the result of some good follow-on stories or sidebars. Keep an open mind!

PHOTOGRAPHERS

Communicating during an interview with the camera operator can be disruptive. If you have a short sign language worked out in advance with the photographer, you can avoid the nerve wracking and irritating distraction of talking about the interviewee as if he were not there. For example, if you want an over-the-shoulder shot as the subject is telling about the flames from his plane searing his feet, stopping to tell the camera operator about a neat facial expression will probably ruin a nice sound bite. Some experienced news teams communicate very well with just eye movement, seat shifting, nose scratches, eyebrow movements, and so forth.

MEAT PUPPETS

Many news directors are upset about talking heads produced from an interview. The familiar cry is that the audience will be bored with a talking head, and they need a constant supply of pictures to keep their minds from wandering. Perhaps when the writing is poor to begin with, this might be true. The following thoughts are submitted for the newsroom supervisor to ponder about the usefulness of talking heads:

- They can show a lot of personality about an interviewee.
- Perhaps how the speaker looks is more important than what is being said. (Do we really care what Miss America says about world peace?)
- Some speakers are dramatic and very interesting to watch.
- The *McNeil-Lehrer News Hour* uses talking heads with great success!

BODY LANGUAGE

Watch what you do with that microphone. If you have to use a stick mike instead of a wireless or a clip-on, do not position yourself so you look as if you are jabbing the poor interviewee in the face (unless it is intended to appear that way). Also remember that you are communicating with your face just as much as you do with your voice. In television, the visuals tell the story with sound and words as supporting actors. If your facial expressions show boredom, the resulting cut-aways during the editing process could be comical or worthless at best. If the interview is with the admiral's wife talking about the Navy Officer's Wives Club 200th annual art sale, a bored face showing upon the air could get your neophyte reporter staring at mounds of dishes in the galley for three months.

KEEPING IT STRAIGHT

If you are working under a nightly deadline, take notes on possible sound bites for your story as you are doing the interview. If you let the video camera be your note pad, you will be in trouble when it is time to sit in front of the editing machines and put the package together. You will most probably have to listen to the whole interview again and then take down notes of where the possible sound bites are. Saving time is paramount for most broadcast journalists. Besides, people expect to be interviewed by someone who will be interested enough to write something down on paper.

INTERVIEWING TIPS

As with any skill, interviewing needs practice. The following drills have proven useful to a number of journalists in the past and hopefully they will help your staff as well.

- **Practice the art of listening.** Also, practice this time-honored way of showing friendship by not using any verbal sounds or obvious body

language. There is nothing worse than a ruined sound bite caused by a reporter's continual mumbling of "yups" and "ohs."

- Do some practice interviews with just a note pad and pencil. Then practice writing the story from total recall. This drill lessens the chance of becoming dependent on the videotape and will greatly speed your production time.
- Study the experts who make their living on network news. Observe where they cut sound bites and how they treated the interviewee (at least before the hard-to-answer questions near the end of the interviews).

ANNOUNCING

Learning Objective: *Identify the techniques and components of proper speech.*

The evaluation of someone's voice quality and speech characteristics is extremely subjective. We all have individual tastes that determine what we like or dislike. This section will help you correct some of the most common problems most beginning announcers have, and will show you a few methods to remedy those problems. There are a few fundamentals of announcing that we must understand before beginning. The basic sound of a person's voice cannot be altered. An individual who has a bass voice will probably remain a bass, and no amount of work will make that person have the voice of a tenor. A notably deep, resonant voice is not necessary to announce copy. However, the concept of communicating what you say, or more simply put, being understood, is essential.

BREATHING

When you breathe in, the diaphragm muscles become tense, compress, then move downward and flatten out slightly. This movement in normal breathing is less than an inch. The chest cavity is increased in all directions, top to bottom and front to back. As the lungs are enlarged in size, the pressure within the lungs is decreased, and a partial vacuum is created in the chest; air rushes in to equalize this pressure. The "diaphragmatic" breathing method is the best breathing technique because it allows you to acquire the proper degree of control. Normal breathing is automatic and unconscious. During the active process of speech, sound is made during this breathing out process. Breathing for speech requires that this procedure be controlled. An

easy and flexible control helps create the most effective delivery for voice production.

MAKING THE SOUND

Once the breath in your lungs is discharge, the air passes through the windpipe, or trachea. The air in our lungs is the source that causes the sounds we make in the throat. With the discharge of pressure, a sound is created. As the vocal folds (accordionlike muscles) of the vocal cords are separated by the buildup and release of air pressure again and again, they vibrate side to side. This fluctuating action makes sound waves. Each release of air causes the folds to vibrate. The amount of vibration is balanced to the degree of pressure built up behind the vocal folds. This, in turn, causes the breath of air, in the voice tract, to vibrate. This vibration is recognized as sound when heard. The faster the vocal bands vibrate, the higher the pitch. The slower the bands vibrate, the lower the pitch.

NOTE: All the voice exercises in this chapter need a before and after recording. First, record your trainee's voice normally. Second, record the trainee's voice using the directions given in the exercise. The student must be able to hear his own voice to duplicate the training exercise, as well as to hear the difference.

EXERCISES

The next two exercises will make you aware of some potential breathing problems and help improve breathing habits for announcing. First, have the trainees sit down in a comfortable position and say these sentences aloud in a normal speaking voice.

- God made the country, and man made the town.
- All hope abandon, you who enter here.
- The finger that turns the dial rules the air.
- A bad beginning makes a bad ending.
- A woman's work is never done.
- People who make no noise are dangerous.
- Life is made up of marble and mud.
- Let your speech be better than silence, or be silent.
- Nothing great was ever achieved without enthusiasm.

Now have them say the sentences again, but this time stand in a comfortable position. Also, have the

trainees exaggerate the speaking movements, making sure to use the jaw, mouth, lips and tongue to overarticulate each word in the same sentences. Play the tape back to let them hear the difference.

Here is another exercise for you to use for general voice training. First, while in a sitting position, have them say the sentences aloud in a normal speaking voice. Second, again stand comfortably erect and direct them to say the sentences aloud. As they breathe, have them try to keep most of the movement in the center of their bodies. Place the trainees' hands on their waistlines, with their fingers extending to the front and their thumbs to the rear. They should feel the expansion in this area. Third, have them place a book against their stomachs. Direct them to inhale. Notice how the expansion of their stomachs forces the book out from 1/4 to 3/4 inch. Exhale. The contraction in the trainees' stomachs permits the books to go back in. Let them get the feel of this action. Have them repeat the exercise while concentrating on their breathing.

VOCAL QUALITY

The announcer's voice is not the only part of the announcer. It implies the whole announcer and is a product of not only the physical self but also the emotional and mental being. The voice can be taught to be more effective through training of those muscles that cause it to be weak metallic, harsh, breathy or nasal in quality, and to those mental or emotional characteristics that provoke the voice to be grating, melancholy or cold in tone. The announcer's muscles and mental attitude must function collectively with precision, accuracy and ease. All of these elements are responsible for the fundamentals of speech.

RESONANCE

When you start to speak, the first vocal tones are dull and weak. The sounds must be enhanced and given color to be heard. The color or quality of the voice denotes richness and emotional meaning. The vocal loudness and changes that happen within the cavities of the human voice are known as resonance. The two types of resonance are sounding board and cavity.

A vibrating tuning fork held free cannot be heard by the ear with ease except at a short distance. However, when you hold its stem against a solid object, the tone will be heard throughout a room. This is because the tuning fork and the solid object vibrate in unison, or together, with the exact number of vibrations of the tuning fork. The tone increases because the size of the

vibrator, the solid object, has been increased. The sound quality of the louder tone changes from solid object to solid object, depending on the size and its composition. This is sounding board resonance. A musical instrument that uses the theory of sounding board resonance is the violin. If you were to hold a tuning fork inside an open pipe and cup your hand over that end, the tone is amplified and sent through the other end. The enclosed column of air is set to vibrating sympathetically and the focus resulting from the enclosure produces amplification. Again, the quality of sound varies with the composition of the pipe; that is, brass, copper, and so forth. The quality of sound depends on the size of the pipe, its length, diameter, shape, openings and internal makeup. This is an example of cavity resonance. The saxophone is another. The three main cavity resonators, or pipes, of the voice are the throat, mouth and nose.

All three are located above the main vibrators—the vocal cords. The mouth is the most variable of the three, while the nose and sinus cavity are the least variable of the cavity resonators. Beneath the vibrators are the invariable vibrators—the windpipe and bronchial tubes which, according to their size, openness and health, may emphasize certain overtones (see fig. 8-19). Because they are fixed and untrainable, you must keep them physically fit.

The bones, cartilage and muscles of the chest cavity, neck and head are the sounding boards of a person's voice. During speech, they vibrate in varying degrees and alter sound, loudness and selection of overtones. These, also, you must keep physically fit. Keep the throat open, detached of unnecessary tension and with enough flexibility to react to any type or subtlety of feeling. This means that your talking with a smile really

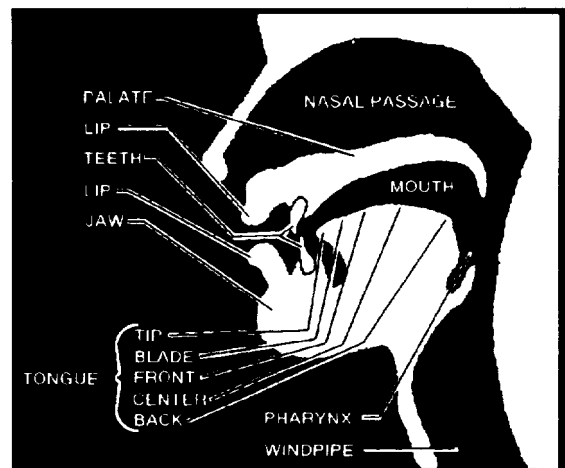

Figure 8-19.—Articulatory organs and resonance cavities.

does work for most copy. How many times have you had to have a person repeat what they said after they talked to you from the side of their mouth? When you are upset and tighten your lips, the sound does not have the same resonance it has when you are relaxed and in a pleasant mental disposition. You may feel foolish smiling in an empty room or a crowded television studio, but the end result is keeping your resonance boards in the proper shape and performing your duties as an announcer correctly. The throat that is capable of responding to any feeling the announcer senses or attitude he bears is healthy. The throat should not be closed at any time. Instead, it should be able to get longer, narrower and alter the texture of its muscle walls in response to emotion.

PITCH AND INFLECTION

There are three types of pitch and inflection:

- Upward
- Downward
- Circumflex

An upward pitch at the end of a sentence expresses uncertainty, questions or a halfway expression which indicates something more to follow. A downward inflection at the end of an idea reflects certainty, self-assurance or authority. (Be careful though because it can also reflect boredom.) The third type, a circumflex pitch, indicates an ironic, sarcastic, double or uncertain meaning. For example, the word “really” modulated upward asks a question, inflected downward denotes concern, and inflected with a curved circumflex (depending upon direction and tempo) implies any one of several ironic, sarcastic or double implication. A sudden change in pitch or inflection rate, either upward or downward, is a vocal step or leap. It is used to tell of a shift in subject or to make a single item or series of items stand out.

Example: “The girls were knocked off their bikes in all directions. You saw it, didn’t you, Jim? Oh man, it was a frightening sight !”

VOLUME

Distinctions in force or intensity of the voice provide a further spectrum for vocal emphasis. A statement that is made with an increase in amplitude or volume and a slowed delivery is more important than one made faster with a soft voice. Sometimes, for reasons of contrast, a subtle calm statement following a

longer, highly intense one, will be amplified in importance. Unchanging volume or intensity will cause monotony.

Volume joined with a time element (duration) produces another primary element: emphasis. The correct inflection of a word results from a combined emphasis on the proper syllable or syllables. The importance of a phrase or sentence is made clear by applying a longer time and force to a specific word or words. This type of focus is called “stressing” or “pointing.” For example, when a photographer is ready to snap the picture, he says, “Hooooold it.”

THE FUTURE

Learning Objective: *Recognize the fluidity of the broadcast medium.*

The broadcast medium is arguably the fastest changing form of mass communication today. Within a few years, the mechanics of gathering information and displaying it to the public has gone from bulky video cameras attached to a video tape player and slung over the back of a gaffer, to the grab and shoot smoothness of a Betacam. It has moved from reporters racing to get a tape back to the studio in time for the 1800 newscast to their doing live reports from the street via microwave linkups.

The Gulf War is the current standard that all press and public affairs practitioners must understand. Currently, the media is trying to redefine its role due to the advent of satellite “realtime” broadcasts. In the past, members of the media saw themselves as the interpreters of events. Satellite broadcasting, 24 hours a day in real time, lets the American people see all the press conferences themselves without the “aid” of the professional journalist. After the war, symposiums were held in most civilian journalism schools on how to redefine the relationship between news maker and news reporter, (or more to the point, the press and the military). The professional Navy journalist must stay in touch with his field by reading everything within reach about technology changes that affect news gathering and dissemination. Do not shy away from reading broadcast industry magazines. Periodic literature is the only medium that will allow you to stay abreast of a fast moving field. Think of reading broadcast specific periodicals as being similar to reading the *Public Affairs Communicator* or other public relations and print medium trade periodicals. It is something the complete senior journalist does.

One month after the Gulf War started, *Television Broadcast Magazine* featured an article on the network's use of Hi8 video cameras. The camera is used as a broadcast acquisition tool. That means the news team will shoot in Hi8 format and later dub the tape to studio quality material for easier editing. At the time of this writing, Hi8 cameras are being ordered throughout the fleet for PAO and SITE operations and are already onboard most major commands, ashore and afloat, in the photo labs.

Although the basics of broadcast journalism will always apply as described in this chapter, understanding the tools of the trade is important to the broadcast supervisor. The supervisor must know the capabilities of the equipment available and this is done only through self effort. When a new piece of equipment comes into your shop, read the owners manual and try the gear out yourself. You may not be the regular operator, but you must know what it takes to get the job done before you can critique the actions of your staff members.

CHAPTER 9

AUDIENCE SURVEYS

As journalists and public relations practitioners, we must not only understand how to produce factual statistical data for our own use, but we must also understand the attempts of others to statistically analyze various events, programs and activities. We, as professional consumers of press, private and government surveys and statistics, must have a deeper understanding of numerical analysis than the average sailor.

Being a senior journalist and perhaps the CO's only public affairs resource, you must be able to understand the information presented in graphs, surveys and the statistical jargon that is often thrust on a command and just as often used to beat or intimidate an activity into some form of action. For example, such a case might arise if a community group gathered statistics on the increase of crime in its area because your base opened up a back gate into its community.

On close examination of these statistics with an accompanying graph showing a dramatic upswing of a line graph, you see the data starts with the gate opening. However, the gate opening also coincides with the summer vacation period. You, understanding that statistical data from a short period of time may have many variables, look at past crime statistics from previous years and see that at the beginning of every summer vacation the area suffers a similar surge of crime. This information would be very useful to a CO planning to make a public apology for the problem and expend money and talent to better police the new back gate area.

Although this is a contrived scenario, the idea should be clear. Not only are we JOs required to be producers of statistical data through surveys, we must also be intelligent consumers of the same.

PURPOSE OF SURVEYS

Learning Objective: Identify the purpose of and the information generated by audience surveys.

A Navy station manager, newspaper editor or a command PAO has to know what is happening now. Your finding out what is happening at any given minute in any given situation is impossible. As journalists, we know it is often difficult to tell what has happened in a

simple car accident even days after the event. (Just look at how many disagreements on what happened ends up in court.). Nevertheless, your finding out useful information that is not unsubstantiated "scuttlebutt" is best accomplished by careful analysis of the facts on hand. Often, locating these facts is accomplished through survey research.

PROGRAM EFFECTIVENESS

By finding out how many people watch the nightly local news program, the broadcast station manager determines if it is being aired at the correct time. The newspaper editor must know how well read a particular section of the paper is if there are plans to reduce or enlarge a section. The PAO in the introduction to this chapter better know how creditable the recommendations are to the CO. Wrong decisions are usually based on wrong information input. Good information that will give a true picture is compiled with care and by using professional techniques.

Surveying for effectiveness is an integral part of your public affairs process or your ongoing estimate of product success. In the book *Effective Public Relations* by Scott M. Cutlip, Allen H. Center and Glen M. Broom, this process is broken down into the following steps:

- Defining the problem (research and fact finding)
- Planning and programming (decision making)
- Taking action and communicating
- Evaluating the program (research of results)

These four steps clearly show you how important information gathering is to any public affairs or media effort.

SURVEY EXPECTATIONS

Doing research (surveys) in the mass communication field is an inexact science. You can never say with 100-percent assurance that one television program is better liked than another. However, by following established procedures, you will know how well you are serving your total audience (the terms

audience, population, market, and so forth will be used interchangeably in this chapter). Questions that then arise as to why this radio show is slotted at midnight, or why this feature is being reproduced regularly in your paper, will have a strong answer. This might not seem like such an important question to worry about, but remember, whether we are managing an NBS outlet, a base or ship newspaper or a public affairs office, credibility is paramount. Answering a query on why the news hour is set at 5 p.m. instead of 6 p.m. may then be backed up with hard data. This will prevent the rumormongers of the world from supposing the earlier time slot is to let your news team off earlier in the day.

An audience survey can provide valuable information that fits into five categories. They are as follows:

- Determining the approximate size of the “potential” or “available” audience
- Defining the viewing/listening/reading/thinking habits of the audience
- Identifying possible program/personnel/policy changes
- Identifying the demographics of your “typical” audience member
- Demonstrating the public image of your shop as a provider of information/entertainment

TYPES OF SURVEYS

Learning Objective: *Recognize the various types of audience surveys.*

It is often assumed your base or station's audience is a typical group of military people. What is that? Is this base an OUTUS duty station and, therefore, home for a larger percentage of women because they are serving their sea time? What percentage of families on your base has children? Is there a limit to family size for this type of duty station? The list can truly be endless with these types of questions, but with basic knowledge of your particular situation, you will get a feel of what questions are pertinent for your area and which ones are not. The important thing is to **know your audience**. This section offers ways of gathering audience data that are often overlooked as well as more traditional collection techniques.

INFORMAL SURVEYS

Surveying for every piece of information is costly, time consuming and often unnecessary. It is unnecessary because the data may already be compiled for you. As an example, the question of how many children are there on your base and what are their ages is a legitimate question for a number of reasons. Suppose you want to invest the time to produce a children's show for Saturday mornings, or say you would like to know the possible crowd size for a children's event you are planning for the weekend of the military child. Your knowing how many likely participants or viewers is a must. This type of information is already available to you if you are dealing with military or DoD personnel.

Public opinion researchers call this information “aggregate data,” and it is defined as information already onhand about the individuals within the audience with which we are concerned. The alpha listing at your local administration section can be made available to you and will list all of the military members of your command along with their social security numbers and addresses. Depending on the relationship with your command data processing and administration offices, you might be able to further break the data on the individuals into various categories that are of interest to you, such as married, single, number of dependents, living location, rank, and soon. All of this type of data is “raw,” meaning you are simply finding out basic demographics about the population with which you are dealing. General demographics of ships and military installations are easy to obtain. **Demographics of foreign populations are questions you must clear with your chain of command before attempting to discern.** Realize, there are special concerns for the military person trying to do research on foreign populations.

Content Analysis

Content analysis has been defined as a technique for making inferences (educated guesses) by systematically and objectively identifying specified characteristics of messages. Press clippings and broadcast monitor reports, all available from commercial services, have long been used as the basis for content analysis within the journalist paradigm. Remember, content analysis only provides data on what is being said or printed. It does not provide any indication of what your audience is actually viewing, reading or thinking.

Content analysis has often been criticized as nothing more than research into what editors and publishers think. Jimmy Carter's election win in 1976 is a good

example. Only 12 percent of the nation's dailies endorsed him. Clearly, what is on the editorial page does not represent public opinion.

However, content analysis often shows trends in the media's agenda setting function. Most press researchers agree that mass media is not effective at changing opinions on any given topic, but deciding what will be discussed on a national scale (agenda setting) is most often accomplished by media coverage of a topic. Knowing what topic is coming to the forefront of media attention would be valuable information to public affairs practitioners, especially if such a topic were to be military drug use or shipboard safety. A good public affairs office can then be proactive and check into local procedures or problems and bring together a contingency plan or perhaps even point out trouble areas to those concerned.

Mail Analysis

In relation to mass media, content analysis is mail analysis. This form of research is economical and often overlooked. It is not to be used as hard scientific data, such as the formal surveys you will soon read how to do, but it may serve as early warnings on sources of ill will or problem relationships. For most military print, broadcast and public affairs activities, reading every letter received from the public is usually not a tough assignment, and it is strongly suggested that each letter be answered. Few stations or offices have ever been inundated with bags of mail that would require random selections of letters to be read. This type of data collection is mentioned here to make you aware that letters can be more than just communication between a listener and a disc jockey. They may be the tip of a controversial iceberg.

Call-in Telephone Lines

During Operation DESERT STORM, CHINFO operated a toll-free telephone line to answer questions from military family members. The line was a huge success and soon became the number to call even for the family members of other services. The reason for such a huge success was due, in part, to the analysis of the trends found in the calls. One such trend that the Navy exploited was the huge amount of calls from Spanish-speaking families. By chance, during the first few days of operation, a Spanish speaking person was available to answer questions. Since no other branch of service was able to handle non-English calls, the Navy was soon taking them all. Also, at the time, CHINFO

saw the trend in non-English calls and institutionalized having a Spanish-speaking staffer on hand to take such calls.

This is a good example of moving with a fluid situation and of the use call-in telephone lines may be put to in identifying areas of concern. Was the military family audience in this case known? Not well enough. Was everything that was being released about the Gulf War going to all of the internal audiences we thought they were? Evidently not. A good lesson was reiterated about knowing the intended audience. It was also a good example of using data that has already been collected, and in particular, using data collected from a call-in telephone line.

FORMAL SURVEYS

For those of you who have been wondering when this chapter on surveys was going to begin looking like a chapter on surveys, your wait is over. This next section will begin dealing with more traditional forms of survey research techniques.

Telephone Surveys

The telephone is arguably the cheapest way to do a survey. Most students of journalism know about the early telephone surveys that did not take into account "who" the owners of telephones were. In 1936 the *Literary Digest* mailed out 10 million surveys to discover who was going to win the presidential race between Franklin Delano Roosevelt and Alfred Landon. This was the largest sampling of a population ever attempted up to that time. The bias of the poll was later discovered to be how the "Digest" found the addresses of their would-be respondents. They used the telephone book.

At that time in America, rural areas, as well as many inner city areas, had substantial populations without telephone access. This affected the results by surveying more well-to-do people who could afford telephones. Franklin Delano Roosevelt was planning for a large vote from the urban and rural poor. You can see how the data gathered over the telephone would have favored the candidate trying to represent the wealthier telephone owners. The poll predicted Landon by a large margin. Just the opposite occurred with Roosevelt winning in a landslide, 62 percent to 38 percent. Telephone ownership is not much of a problem for most presidential pollsters these days. However, it is still a problem when you conduct a telephone survey and many members of your audience live in the

compartment of a ship or in a barracks where one line is often the only telephone connection to scores of people.

Another important factor is that many people will not feel free to make candid comments within earshot of their shipmates.

Personal Interview Surveys

There are many advantages of face-to-face interviewing, and it is still considered the most accurate form of gathering data for a survey. However, interviewers must be properly trained so as not to let their personal habits or motives influence the sample respondent. The interviewer is supposed to be like the ultimate statesman or the ideal father or mother figure. Interviewers must be understanding, patient, modest, well dressed (but not too well dressed), soft spoken and above all, good listeners. Do you know anybody like that? The point here is that whether doing a face-to-face interview or talking on the telephone, keeping the survey data free of any interviewer effect is important and difficult. For instance, if you are a chief petty officer doing an interview with a seaman and the question deals with the command's response to recent incidents on base vandalism, the outcome might be affected by the disparity of rank. For the most part, face-to-face interviewing will seldom be used because of the time needed to do it, the inherent difficulties of the technique and the labor cost of moving an interviewer from respondent to respondent.

Mail Surveys

The most widely used and traditional DoD survey is the mail survey. It has two very serious disadvantages though. The first and foremost disadvantage is that mail surveys most often only have a 10-to-15 percent rate of success in terms of surveys being returned. In most academic and professional polling circles, this is a useless effort. To base a decision on a mail survey with a response rate of only 15 percent is asking for a decision based on nothing better than hearsay. It is not "better than nothing" as is often heard in defense of such efforts. It is worse than nothing! The reason it is worse than nothing is because the hearsay data now has an air of fact about it that it does not deserve. It would be better not to conduct a survey at all, and base your programming or public affairs efforts on your observations of the informal survey methods mentioned above.

The second big disadvantage is that a mail survey can be filled out by anyone at the address to which it is mailed. This means if you are trying to find out what the working spouses in your audience would like the base to do about day care, you might get a large percentage of married military members simply answering for their spouses in the way they think the spouses would have, or should have answered. This will produce biased results, and again, decisions may be made that might exacerbate the problem.

Now that we have put mail surveys in their place, let us look at why we use them. One reason is because they are cheaper than personal interviews of each sample respondent. Also, the low response rate can successfully be attacked. If you can get the response rate into the 80-plus percentile range, you have a good audience representative survey on your hands.

The following is a list of proven ways to get into that response range:

1. Keep the questionnaires short. Ideally, this should mean one page with 20 or so questions. This is not a lot of questions, but remember, you are trying to get accurate information, not a bunch of responses from only those people who have the time to fill out a lengthy questionnaire. Also, keep in mind that much of your demographic information on military and DoD personnel can be gathered from existing personnel files. Gathering data from these files also eliminates a respondent's fear of being identified. With shorter questionnaires, the dreaded survey project will be easier to complete. This means you will probably do more of them as you become familiar with the methods. Shorter, more frequent surveying of your audience gives you a better picture of **what is happening** and that is what it is all about.

2. Put a stamped, self-addressed envelope inside the survey mailer. (One creative journalist let the survey questionnaire itself serve as the return envelope. All the respondent had to do was fold the questionnaire over, staple it shut and put it in the base guard mail system.)

3. After you make your random selections (this will be explained later), stick to them and get their response. Three or four follow-up mailings to nonrespondents are often needed to get an 80- or even a 90-percent return ratio. (See fig. 9-1.)

4. Do not continue to mail surveys to the general population until you get a magical number of responses. This will produce a survey that might have a disproportionate segment of your audience represented, and is considered to be a biased survey. An example of

	Time	Average Response Rate
1. First mailing	Week 1	23.8%
2. Post card follow-up	Week 2	42 %
3. First replacement questionnaire	Week 3	59 %
4. Second replacement sent by certified mail	Week 4	72.4%
American Sociological Review 39 (October 1974): "Increasing Mail Questionnaire Response: A Four-State Comparison"		

Figure 9-1.—Mail survey response rate progression.

this would be surveys mailed out to 400 members of your base with 59 of those surveys having been mailed, by chance, to the Marines. You do follow-up mailings to the original individuals selected that have not turned in their responses and still only the Marines remain in the category of those who have returned 100 percent of their surveys. If you have randomly selected your sample size, sending more surveys to the Marines might be appealing, but it will mean a disproportionate (biased) number of Marine opinions will then be in your survey. You should do one or more of the following: forward a follow-up notice; send second survey mailings to the chosen respondents; conduct telephone interviews; or in rare cases, conduct face-to-face interviews of those few random sample selectees who have not yet answered their questionnaires. Remember, keep your follow-up attempts based on your original randomly selected individuals.

5. Make sure the purpose of the survey is clearly stated and that each respondent has been selected by a random method and will not by any chance have his or her identity released. **Then make sure you follow through with that promise.** (Remember, credibility is paramount.)

6. Put some authority behind the cover letter to the survey. Getting the CO to sign it helps immensely.

DEVELOPMENT OF SURVEYS

Learning Objective: *Identify the concept of audience survey development.*

Now that you have an idea of what a survey can do for you and what types of surveys are available, the next step for you is to understand the components and

strategies involved with producing a valid and statistically reliable survey.

GETTING STARTED

Beginning a survey project is much like beginning a story. First you should know why you are doing it. Essentially, what information are you looking for that can only be found by doing a formal survey? After you have decided that the information cannot be attained through any previously collected data source, you should begin thinking about survey production. The following is a list of questions that must be answered before you start your survey research project:

- **Who are the people you are going to survey?** "Know your audience" is a phrase that keeps coming up. Will you try to survey all the people (called the population) in your audience?
- If you are going to use a sample of the general population, **how will this sample be chosen and how large will it be?**
- **What method of distribution will you use?** The four possibilities are mail, telephone, interview or a combination of the three.
- **What type of question format will you use?** Are open-ended, close-ended or a combination of both called for?
- **How will the data be tabulated?** If at all possible, place your survey responses on a computer. This might entail asking some local computer hackers for help if none of your staff has this talent, but seeking assistance will be worth it.

Number of cases tabulated	Percentage voting against reviving the NRA
500 ballots	54.9
1,000	53.9
5,000	55.4
10,000	55.4
30,000	55.5
Total population of sample = 30,000	

Figure 9-2.—Sample size increase vs. accuracy.

- **What are the time and cost constraints?** Do you have the time, manpower and money to accomplish whatever survey project you are attempting? This is important. Set deadlines and give specific job assignments or else piles of survey junk may end up stashed in someone's desk drawer.

SAMPLE SELECTION

How large should a sample be from any given population? This question takes us into the mathematics of probability. Do not worry, you will not have to understand the statistics behind national surveys produced by the likes of George Gallup. But perhaps a quote from Mr. Gallup might help put the question of sample size in perspective. "Both experience and statistical theory point to the conclusion that no major poll in the history of this country ever went wrong because too few persons were reached."

Gallup conducted a number of experiments on the effects of sample size. In 1936, he used 30,000 ballots to ask the question: "Would you like to see the National Recovery Act (NRA) revived?" The first 500 ballots showed a "no" vote of 54.9 percent. The complete sample of 30,000 ballots returned a "no" vote of 55.5 percent. In other words, the addition of 29,500 ballots to the first 500 ballots only made a difference of 0.6 percent. (See fig. 9-2.)

Through the mathematics of probability, we know there is a real but unknown distribution of all possible answers to a question. If we then know that our sample is random (meaning that every person in our audience is just as likely to get a survey as any other person) and that our techniques are capable of obtaining a reliable response (without bias) from each person, we will be able to tell how representative the responses are.

For the purposes of this chapter, the Sociology Department at the University of West Florida supplied a quick and easy formula often used in social science research. It is shown in figure 9-3.

$$\left(\frac{Z}{h}\right)^2 \cdot PQ$$

z = 1.96 (for ease of calculations use 2. This will not noticeably alter your final product.)

h = the margin of error you are willing to accept.
(2%, 3%, 4% or 5%)

P & Q = maximum expected percentages. (.50 x .50 = .25)

Figure 9-3.—Sample size formula.

With this formula, let us figure out what size sample we need to get a plus or minus error of two percent. Two divided by .02 (percents will appear in hundredths) equal 100. Square 100 and you get 10,000. You multiply this by .25 and your answer is 2,500. You need 2,500 survey responses to get a +/-2 percent margin of error. **Notice that you did not need to have information on the size of the total population in your audience.**

If you wanted to achieve a plus or minus margin of error of five percent, you would calculate as follows: Two divided by .05 equals 40. Square 40 and you get 1,600. You multiply this by .25 and your answer is 400.

For all practical purposes, a plus or minus error of five percent will be the lowest margin of error needed. For professional pollsters, a sample of 1,000 is capable, statistically, of reflecting the opinions of 250 million people. As George Gallup was quoted earlier in this chapter as saying, the size of the sample itself is not as large of a factor in determining the accuracy of a survey as conventional common sense would seem to indicate.

For the purposes of most surveys, you will develop and implement sample sizes from 100 to 400, which should be adequate. We mention 100 as the low end of sample size because our sample size determinate formula will work with total populations of 4,000 or more. For lower total populations, we suggest 10 percent of the total population until a minimum of 100 sample respondents has been reached. Additionally, below 400, categorizing by various demographics becomes less and less reliable. If you intend to break the survey results down by age or sex, you are also breaking the sample size down into smaller numbers.

For example, if the question was, "When do you watch television the most?" and the response scale covers five time blocks with 100 plus respondents, you can get a percentage that will show general population viewing trends. If you try to break those respondents out into categories based on rank sex or marital status, your sample size for those separate categories will no longer be 100 plus. You cannot say most women watch television from 3 to 4 p.m. because only 32 of your sample respondents were women and 32 is not a reliable sample size. With a small sample such as 100, the demographic analysis of survey results is likely not to have any usable degree of certainty. You would need a larger sample size in order to make each category separated out from the general sample to at least total 100. With a survey of 400 respondents, it is likely that breaking out various categories would be possible without producing noticeable bias.

With the above statistical jargon in mind, this rule of thumb makes sense: use a sample size of 400 for populations of 4,000 or more, and 10 percent to a minimum of 100 for populations under 4,000. Remember, if you choose to use a smaller sample size than 400, be careful of breaking your total sample into smaller categories of respondents. With the appropriate sample size and careful attention to the details of survey construction and implementation, you will have a low enough chance of error to make intelligent decisions based on facts.

Random Selection

Much more important than the size of the sample, beyond a reasonable minimum, is how that sample was selected. The only way you can be sure that bias has not occurred in the selection of a respondent is by random selection. This means everybody in your total possible audience has an equal chance at being selected to complete one of your surveys.

How often have you seen a survey printed on the back of a base newspaper? This type of survey is fine if you understand that the respondents are only people who read your product to begin with. These same respondents are also the only people who care enough about whatever the question was to bother answering it. If that small slice of your audience is that important to you, then by all means run the survey on the back page of the base paper.

However, let us say you were trying to find out how many people like the garden section in your weekend paper. You printed the survey in the weekend edition and the results show that your audience loves it. You might be getting responses only from weekend readers who, in fact, do enjoy the garden section. In reality, it could just as well be that they are the only ones reading the weekend edition because the garden section turns off the rest of your potential audience. If you want to know what all of your possible readership thinks on a certain topic, then you must select respondents by some method that enables a true cross section or representation of that audience.

Selection Hint

One possible random sampling method used in the military that is easy, effective and previously mentioned in this chapter is to select survey respondents from the base alpha lists or personnel rosters. Again, work with the administration section of your command to be sure personal privacy is not violated. Choose a randomly

selected number from 0 to 9. Use the last digit of the social security numbers listed on the roster that match that number, and you will have as random a selection as you most likely will need. If the sample size is too large (with 10 possible numbers your sample size will be roughly 10 percent of your total population), then randomly select another number and match it with social security numbers that have the same digit in the second from the end position. Never use the beginning digits of the social security number because you will end up with a bias in your survey of respondents who come from the same geographic area.

WRITING THE QUESTIONS

Social scientist Paul Lazarsfeld said, “People do not answer what you say (or write), but what they think you mean.” Without making the average respondent sound like the Gilligan’s Island routine of answering questions literally for laughs, when you write survey questions, remember—often times no one will be around to explain just what they mean.

Question Design

There are three standards for good survey question writing. The first is precision. Does the question ask exactly what you want it to ask? If you request information on activities and say “recently,” do you know what everybody’s definition of “recently” is? Can there be any other way to understand the question than the way you have intended the respondent to read it?

The second standard is relevance to the respondent. Does the survey ask for opinions on something that the respondent might have no possible thoughts on? An example of this would be asking Third Class Boatswain’s Mates about F-14 maneuvers. It obviously is not relevant to them.

The final standard involves personal assumptions. Do any of your questions assume the respondent will understand what is meant by a certain phrase or question? A classic example of this has been written in scores of research methods books. A British lady asks another British lady if she was alone last night. The second lady says with confidence, “yes.” However, the house was full of servants. The lady who answered the question was obviously assuming the questioner wanted to know if she was with anyone that counted in social circles. Assumptions are just as dangerous in surveys as they are in news stories.

Pretesting

A good method of ridding a survey of assumption problems and other unintended bias is to gather together some willing souls and have them complete the survey. Check the answers to the questions and ask the respondents if they had any problems understanding the questions. Then listen to their answers. Do not browbeat them, or call them idiots for not understanding what you wrote. If they did not get it, how many in the sample you take will misunderstand as well?

Format

Structurally, the following are the three primary types of survey questions:

- **The yes-no question** is simple and is used for data that is censuslike. Demographics is usually an either-or question. Yes-no categories include male-female, married-single, and so forth.
- **The multiple choice question** is by far the most common type of question format used. It gives the respondent some alternatives beyond the confining yes-no choice. It is as easy to tabulate as the yes-no question and provides insight into intensities of attitudes.
- **The open-ended question** is next to impossible to tabulate and for this reason, it should be used sparingly. However, if there is a topic that is suspected of harboring deep emotions, perhaps an open-ended question is best. This type of question lets the respondent express his exact thoughts. It is also a good indicator of potential trouble spots your office might not be aware of at all. There is nothing wrong with leaving a large blank space at the end of your survey (or the back side) to record any opinions the respondents would like to share. You will not be able to tabulate the responses for statistical reliability, but they will make excellent informal data.

Measuring Intensity

Another way of measuring the intensity of a particular belief or attitude, other than the open-ended question, involves using a scale. The scale most frequently used is the Likert scale, which is named after the researcher most associated with its development. The Likert scale will reveal your audience’s perception of various topics. Moreover, a Likert scale question makes a statement and categorizes the responses from

“most strongly agree to most strongly disagree” and places a scale of one through 10 in between. Figure 9-4 is an example of a Likert scale question.

Exclusion/Inclusion

When you write scaled questions and especially multiple choice questions, beware of overlapping categories. This usually entails questions asking for a numerical determination.

For example, suppose you want to determine how often the base ticket office is used by base civilians. Your survey question is multiple choice and asks the respondent to fill in a block that fits into the categories one to three times a month; three to five times a month; five to seven times a month, and so on. The respondent might have used the ticket office three times last month and now must make a choice to put his or her response in the first or second block.

When tabulating the responses, you will not be able to know accurately, in which block the person should really be. It would have been better to set up the choices as: never; one to two times a month; three to four times a month, and so on. Remember, the person who never uses the facility is also a part of your general audience and should have a place to put that information, as well as the person who might use the facility more than a set block might indicate.

RELIABILITY

The term reliability in survey research is a bit vague as compared to reliability of research in chemistry for instance. In chemistry, a quality control survey is reliable when the same results appear time after time.

You have to be doing the same steps in a methodical way to obtain similar results each time. To do the same survey a number of times when dealing with human respondents is certainly possible, but the material being surveyed, human respondents, change minute by minute. So checking for reliability becomes harder to measure in a social science setting. With that qualification being said, reliability still means having a legitimate survey process that, given all other human variables being the same, would produce similar results.

VALIDITY

The term *validity* deals with whether the respondent's real opinion is discovered or not. You may have a wonderful survey process that has the questions answered the same way on the pretest and the larger complete sample survey, but the validity of the responses comes into question when you realize that the respondents had ulterior motives for answering some of the questions the way they did. For example, what if you asked your audience if they felt the government should spend less money on defense. What if the vast majority answered “NO.” Do they really feel the government should not curtail defense spending, or are they afraid property values in the area will drop if word gets out that even the military people on base think less money should be spent? The doubt of how valid the response is to that question would certainly arise.

If all these potential problems in doing survey research have you muttering about how we can ever really know anything, welcome to the world of social science research. All we can do is get as close to the facts as we can through using as unbiased a process as possible. Margins of error till always be with us when

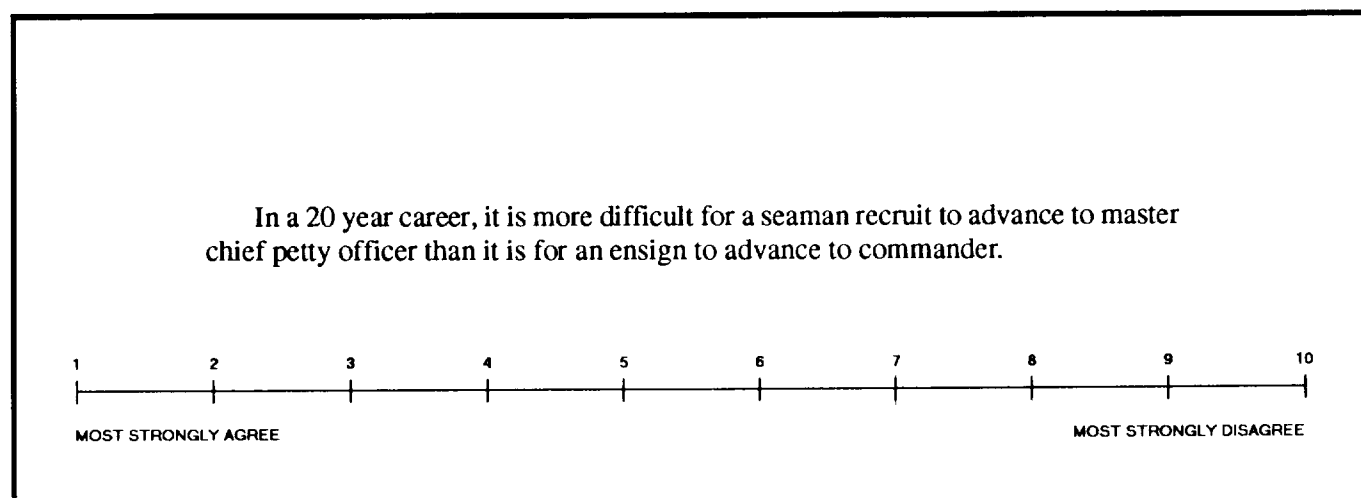

Figure 9-4.—Likert scale.

we try to measure the most fluid paradigm in the world—human thought.

ANALYSIS OF SURVEYS

Learning Objective: *Analyze and use the data generated by audience surveys.*

The simplest and easiest way to communicate a complicated list of data to an audience is with a picture. As journalists and as a result of your studying Chapter 6 of this training manual, you already know about the various types of visual communication possible for displaying data. The final section in this chapter covers understanding the survey data you have collected and how to correctly plug that data into visual representations, such as graphs and charts.

CORRELATIONS

As mentioned earlier in this chapter, making decisions, based on samples of under 400 from general populations of 4,000 or less, is possible and reliable if you are making simple comparisons. A simple comparison is what percentage of your sample watches television. Your results might look like the following: 34 percent—0600-0800, 10 percent—0801-1000, and so on. But if you wanted to know what percentage of those who watch from 0600-0800 are women or children, then remember, you must have a large enough sample to keep each category you want your survey broken into over 100. This will keep the relationship between viewers watching from 0600-0800 and the sex of those viewers reliable.

Correlating viewership with demographics is important, for example, when you plan to run information spots targeting women. Questions, such as, when do most spouses watch your television station, listen to your radio station or what editions of your paper are they more likely to read, are important to answer when you plan an information campaign. **Know Your Audience.** As Rear Adm. Baker, the former CHINFO once said: “Work smarter, not harder.”

GRAPHIC DISPLAY

The last section of this chapter ties back with the scenario used in the introduction. Putting your data into a picture to give it impact is absolutely necessary and also dangerous. It is necessary because few people will take the time to study raw print-out sheets of data, no matter what the claims of the surveyor are. It is also dangerous because a mistake in how you present your

survey findings can ruin the credibility of all your efforts.

How many times have you heard the saying, “Statistics lie”? You must display your survey findings in the most understandable way possible and still stay within the boundaries of fair representation. Perhaps the best way to understand how to present your data fairly is to see some examples of how to be unfair. These examples will also increase your ability to spot abuse of statistical data.

Let us say that as the command’s expert on survey techniques, you volunteered to supervise Morale, Welfare, and Recreation’s facility usage survey. You have followed the guidelines in this chapter and have collected reliable and valid data and are ready to present the results to the CO.

The CO’s pet project is the base racquetball courts, and he is interested to see how many sailors are using it since it was built last year. You are aware of his interest and decide to graph the informal aggregate data collected by reviewing the sign-up sheets in the racquetball court front office. You hope to show a steady increase in usage since your broadcasting outlet has been regularly producing information and selling spots on the new courts. Starting with January, you list each month on the bottom of your line graph. On the left, you place numbers of users in blocks of 20 and begin to place your data on the graph. An example of this is shown in figure 9-5.

The line chart does indeed show a steady progression of increased usage up the graph. However, because of the scale you used, the data does not really jump out at you. So you decide to display your information in a more effective manner. To be more pleasing to the eye, you cut off the upper and lower sections of the graph to end up with the display shown in figure 9-6.

The graph looks better to you now and it even shows the slight dip in the summer months when you were forced to go TAD causing, in your estimation, radio spot production to fall off. If only the data could illuminate that fact a bit more you might even get a letter of appreciation from the CO for doing such a good job of promoting his pet project. To highlight the summer dip, you decide to go with the graph in figure 9-7.

That does it. Who could deny that the base racquetball court, the CO’s pet enterprise and your personal advertising project, is not a big success? Was the data changed in the various graphs? Was there a lie in any of the charts? The answer is yes and no. There is

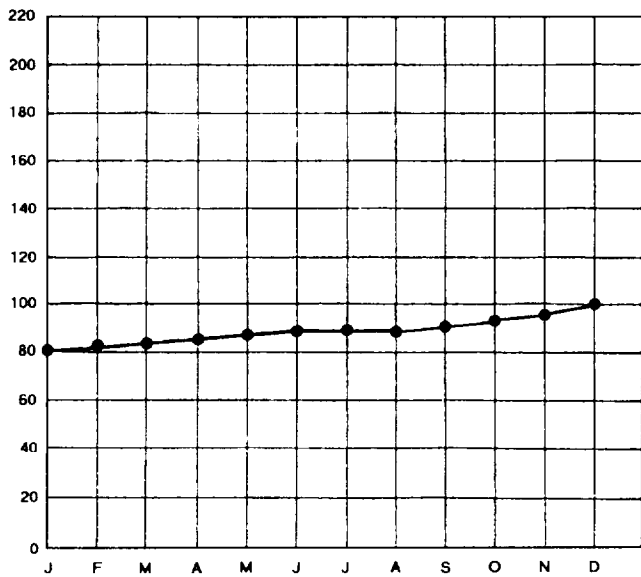

Figure 9-5.—Obscuring results.

no need to hide the data from anyone by making the scale too hard to see such as in the first graph produced. There also should not be any of the surveyor's personal interests involved in choosing the method of display. The data should be presented with only the communication of the facts as the goal.

Given that the CO was astute and, being an engineer, well aware of statistics and their uses, how credible would the JO sound when bragging about the advertising campaign for the racquetball courts and how the TAD upset that campaign? What if the CO was a racquetball player and knew how hot the courts were in the summer? Would the credibility of the JO then come into question? Of course it would!

The lesson on graphics is simple. Use whatever visual communication device you need to get your message to its intended audience. Nevertheless, beware of making the data look suspect by taking too many creative liberties. Remember, many in your audience will be as good of a statistics consumer as you now are

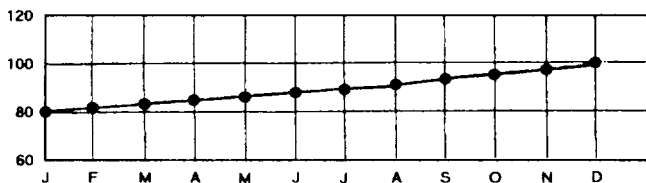

Figure 9-6.—Suitable display.

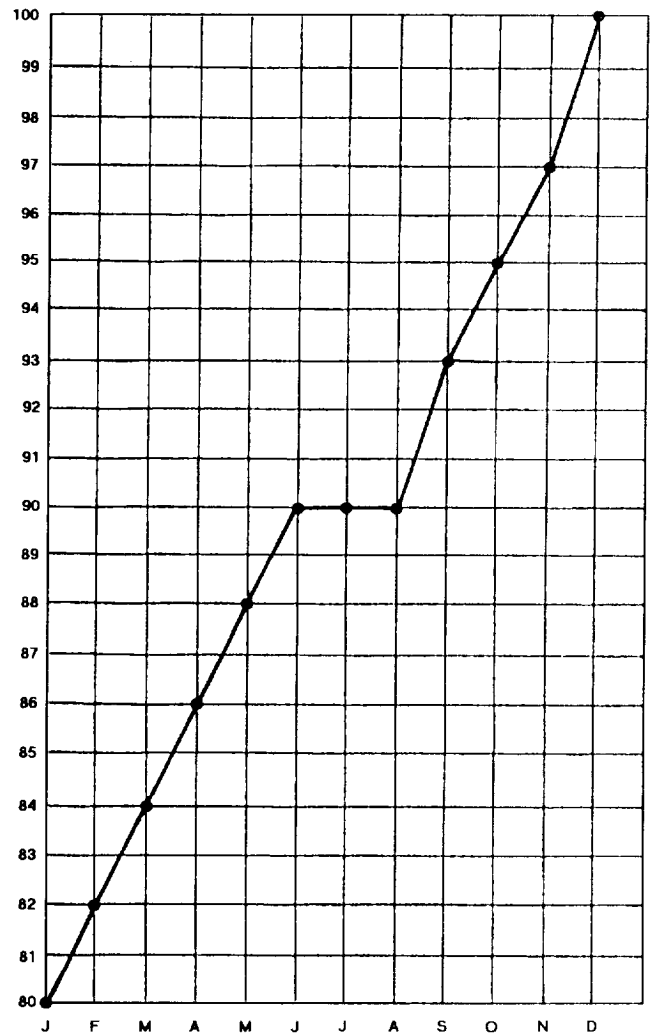

Figure 9-7.—Exaggerated results.

and once the data becomes suspect because of an obvious attempt to manipulate the figures, your credibility is gone and your efforts have been wasted.

SUMMARY

This chapter is part of the JO 1 & C training manual because of the growing demand from the public affairs community and the ongoing need of internal media relations to **know what is happening** and to **know their audience**. Survey production and analysis have only recently been included in the occupational standards for journalists, but it has long been a part of the rating. AFRTS and, since 1975, NBS, have always required an annual audience survey. More and more public relations practitioners in the civilian world are having to prove their worth on the bottom line to their chief executive officers (CEOs). Proving the money value, more often than not, entails sophisticated statistical analysis of program effect.

In the same light, no CO is going to give much support to a journalist or a PAO whose only measure of achievement is the number of press releases sent out or the number of tours given. For military journalists and PAOs, the mandate is clear.

We must be the eyes and ears of the Navy in the media paradigm. We must be the professional producers and consumers of statistical information in order to maintain our position in the Navy as media experts. It is our future.

APPENDIX I

SAMPLE FORMAT FOR A PUBLIC AFFAIRS PLAN

Public affairs plans vary among different commands and may differ according to their purposes. The paragraph headings, content and sequence can be changed, some paragraphs can be omitted or included in annexes or additional paragraphs can be added. The plans may be issued in a number of ways, such as instructions, SOPs, notices, memorandums and annexes to operation orders.

DEPARTMENT OF THE NAVY PUBLIC AFFAIRS PLAN FOR THE 50TH ANNIVERSARY OF WORLD WAR II

Reference: (a) DoD World War II Commemoration Plan

1. Purpose. To establish command and public affairs responsibilities and guidance in support of the Navy's presence and participation at national and regional ceremonies, events and observances in commemorating the 50th Anniversary of World War II, 1991-1995. All events will be accomplished in accordance with reference (a).
2. Scope. This plan provides suggested information and event management programs for both internal and external publics and involves media relations, community relations and internal relations. The plan outlines the general responsibilities of participating commands, lists recommended possible initiatives, highlights the DoD and Navy-Marine Corps approved activities (see Annex A) and provides for an after-action report.
3. Background. At a time when defense expenditures are decreasing and the public perception of the threat to our nation is lessening, maintaining a positive Navy profile is crucial. The Department of the Navy has a unique opportunity in commemorating the various events associated with this anniversary to reinforce to the American public and supportive groups the need for a strong and flexible Navy. It is an opportunity to explain the Navy's historic, current and future missions and its dependable support of this country's national policies, vital to our nation's role as a world power and a maritime nation dependent on free sea lanes.

4. Objectives. This plan is designed to accomplish the following five goals:

a. To remind the World War II generation of U.S. citizens, and to educate postwar generations, of the Navy's contributions during the war and the successful role it played in defending and protecting this nation's freedom.

b. To honor the veterans of World War II.

c. To inform the public about World War II as the dominant event of the 20th century, often forgotten or diminished in importance in the context of live media coverage of current events.

d. To highlight the advances in technology, science and medicine from military research during World War II.

e. To accommodate the desires of the Allies of the United States in World War II, as feasible, in allied/joint U.S. observances.

5. Policy Guidance and Planning Considerations.

a. Commands at all levels will cooperate with and support, as appropriate, World War II observances planned by individual military and civilian groups, veterans/patriotic organizations and observances sponsored by private and public sectors.

b. Events will be conducted as commemorations and observances, not celebrations. Every effort will be made to avoid commercialization or an atmosphere that detracts from the dignity and solemnity of events.

c. Events will seek to commemorate ideas, alliances and programs, as well as battles.

d. Events will involve the American public at every possible opportunity.

e. DoD/State will provide specific guidance on joint commemorations and those involved with United States Allies and former adversaries.

f. Proposals for joint commemorations with former wartime adversaries will be received politely and evaluated on an individual basis at the Navy and DoD level.

g. Commemorations will reflect a sensitivity and appreciation of the tragedy of war, and an understanding of the losses suffered by all nations during the war.

h. Joint commemorations will clarify the fact that America and its Allies fought a war against totalitarian regimes intent on regional hegemony and world domination that denied freedom and justice not only to others, but to their own peoples.

i . Competitive and comparative themes, with regard to the other U.S. Armed Forces, will be avoided.

j. Heroism and the participation of American minorities in World War II should be included.

6. DoD Commemorative Focus.

a. Role and relationship of the military in World War II's global coalition warfare.

b. Education and historical lessons for service members, their families and civilian employees.

c. The sense of commitment, sacrifice, leadership and values displayed by leaders and members of the armed forces and those serving on the home front during the war.

d. The following DoD year themes have been established:

- 1991- Preparation and Entry into War
- 1992- On Defense
- 1993- Transition to the Offensive
- 1994- The Tide Turns
- 1995- Peace

7. Responsibilities.

a. The Department of the Army, as the executive agent, will coordinate DoD activities to support the DoD Commemoration of the 50th Anniversary of World War II.

b. The Chief of Information (CHINFO) will do the following:

(1) Establish initial policy and guidance for Navy participation and provide follow-on guidance to all commands where participation criteria are in question.

(2) Act as a central clearinghouse for public information regarding Navy events/participation.

(3) Disseminate the appropriate Department of the Navy messages and materials urging the support of and participation in 50th Anniversary activities.

(4) Develop plans to accomplish the objectives described herein for implementation by local commanders.

(5) Coordinate with DoD, Unified Commands through DoD, service public affairs offices and national organizations to ensure the Navy's commemoration events are consistent with overall objectives and policy.

(6) Develop and conduct World War II awareness programs to provide military and civilian communities with an appreciation and clearer understanding of World War II observance activities throughout the commemorative period according to DoD World War II year themes.

(7) Coordinate with the Navy Internal Relations Activity (NIRA) and participating commands to develop material for Navywide and international internal and external release. Local releases can be made by appropriate local commands.

(8) Coordinate with the Navy Broadcasting Service and participating commands to incorporate significant 50th Anniversary events into "Navy News This Week."

(9) Coordinate with participating commands and civilian air show sponsors to include World War II commemorative themes in their programs. Make sure information on the 50th Anniversary of World War II is included in Blue Angels performances.

c. Fleet commanders in chief and major naval commands will do the following:

(1) Encourage naval bases and stations, ships, squadrons and other activities to participate in school programs such as Adopt-a-School or Partners in Education, emphasizing World War II themes.

(2) Make sure "campaign brochures" with historic episodes, developed by the Navy Historical Center and other appropriate Navy-related material on the 50th Anniversary, are distributed to units for further dissemination to local media, support groups and veterans organizations.

d. All Navy commands will do the following:

(1) Use DoD and Department of the Navy World War II public affairs internal and external programs to increase sailors' awareness and understanding of World War II.

(2) Identify local and regional historical "tie-ins" to World War II which may act as a basis for creating events and considering projects and participation.

(3) Make sure World War II brochures and other appropriate DoD/Navy materials are provided to units and local media.

(4) Make sure visitors are informed of the Navy's World War II contributions, as appropriate, during installation tours, emphasizing any exhibits, paintings, photographs, statues, memorials or other local memorabilia related to World War II.

(5) Provide CHINFO with names, addresses and telephone numbers of known World War II participants and educators, who might volunteer as speakers about their Navy experiences.

(6) Designate a World War II project officer to coordinate activities (or as a collateral duty) in support of this plan.

(7) Prepare after-action reports for significant events citing successes, examining any problems and making recommendations, submitting reports up the chain of command.

(8) Conduct band concerts, exhibitions, flag ceremonies and other commemorative activities.

(9) Encourage flag officers and senior civilian officials to include DoD and Navy World War II commemorative themes and plan objectives in their speeches and media interviews.

(10) Provide assistance to appropriate activities sponsored by organizations, such as veterans and patriotic groups, as they commemorate the 50th Anniversary of World War II events.

(11) Highlight the 50th Anniversary of World War II during annual program and activity planning to include Armed Forces Day, Memorial Day, Independence Day, Veterans Day, Navy Birthday, Public Service Recognition Week and other observances throughout the commemorative period.

e. The Naval Historical Center will do the following:

(1) Encourage commemorative efforts by other naval commands and activities by working through naval museum exhibits, historical and archival personnel at commands throughout the United States.

(2) Revise, reprint and distribute United States Naval Chronology, World War II.

(3) Prepare a student's guide to the World War II exhibit in the Navy Museum.

(4) Develop a traveling Navy Museum exhibit.

(5) Establish a traveling World War II art exhibit.

(6) Publish lithographs of World War II combat art.

(7) Sponsor World War II historical conferences.

(8) Prepare bibliographies of the most important books and articles of World War II.

(9) Include World War II topics in monthly Naval Historians' seminars.

(10) Prepare articles on World War II for publication in various Navy internal periodicals.

(11) Develop a World War II naval history speakers bureau.

(12) Plan for the collection of papers of World War II personnel.

(13) Contribute campaign monographs for the DoD World War II publication series.

(14) Establish a World War II visiting lecture series in the Navy Museum.

(15) Coordinate above activities with CHINFO for maximum visibility through internal and external communications.

8. Execution.

a. This plan will be implemented upon receipt, within existing DoD and Department of the Navy guidance (public affairs regulations, release of information, etc.).

b. This plan is unclassified, and all actions taken to implement it will be unclassified.

c. Direct communication among commands, public affairs offices and local civilian organizations is encouraged.

d. This program will terminate and the plan will be canceled upon the direction of the Secretary of the Navy.

**WORLD WAR II 50TH ANNIVERSARY
ANNEX A
NAVY COMMEMORATIVE EVENTS IN THE EUROPEAN THEATER**

1942

January	Transatlantic Convoys
November	Assault on Fedhala and Casablanca
November	Mehedia and Safi Assaulted
November	Capture of Oran and Algiers

1943

July	Operation Husky/Sicily Secured
September	operation Avalanche (Salerno)
September	Sardinia, Corsica and Elba
October	Naples and Anzio

1944

June	Landings, D-Day
June	Capture of Cherbourg
September	Invasion of Southern France
November 1944- May 1945	Defeat of U-Boats

1945

May	VE-Day
-----	--------

NAVY COMMEMORATIVE EVENTS IN THE PACIFIC THEATER

1941

December Attack on Pearl Harbor
December Defense of Wake Island

1942

March U.S. Forces land on New Caledonia
April Bataan Surrenders
April Doolittle bombs Tokyo
May - June U.S. Forces arrive in Fiji and Tonga
May Battle of Coral Sea
May Corregidor surrenders
June Battle of Midway
August U.S. Forces land on Guadalcanal
September Battle of Bloody Ridge, Guadalcanal

1943

March Battle of Bismark Sea
May U.S. Forces land on Attu Island
June U.S. Forces land in the Solomon Islands
August U.S. and Canadian Forces land on Kiska Island
November U.S. Forces land on Bougainvillea
November U.S. Forces take Tarawa and Makin Islands
December U.S. Forces land on New Britain

1944

January U.S. Forces land at Kwajalein and Majuro
February U.S. Forces attack and secure Enewetak Atoll
June U.S. Forces invade Saipan
June Battle of the Philippine Sea
June U.S. Forces land on Guam
June U.S. Forces land on Tinian
September U.S. Forces land on Peleliu
September U.S. Forces occupy Ulithi
October Battle of Leyte Gulf

1945

January U.S. Forces land on Luzon
February U.S. Forces land on Iwo Jima
April U.S. Forces land on Okinawa
June Liberation of the Philippines
August Japan surrenders
September MacArthur accepts surrender

APPENDIX II

SAMPLE PUBLIC AFFAIRS ANNEX TO AN OPERATION ORDER

(For Training Purposes **Only**)

UNCLASSIFIED

HEADQUARTERS, U.S. PACIFIC FLEET
PEARL HARBOR, HAWAII 96860-7000

ANNEX F TO CINCPACFLT OPORD 201 PUBLIC AFFAIRS

1. U.S. Pacific Fleet. The United States Pacific Fleet is the world's largest and most powerful naval command. Its area of responsibility stretches over more than 52 percent of the earth's surface and covers more than 102 million square miles of ocean, from the Arctic to the Antarctic in the Pacific and Indian Oceans. The fleet is an instrument of the foreign policy of the United States. In peacetime, its mission is to help maintain peace by serving as a deterrent to aggression against the United States and its Allies and to promote understanding, good will and respect overseas for the United States. In time of war, the fleet's mission is to apply force as directed in support of the United States objectives.

2. Mission. To succeed in fulfilling the fleet's missions, it is imperative that all Pacific Fleet officers in command develop and maintain an effective public affairs program, composed of an aggressive public information program, an effective community relations program and an informative and credible internal relations program.

3. Rationale. The importance of public affairs in today's high technology communications environment cannot be overemphasized. Geopolitical events and activities of our forces, often closely linked, are covered in detail by the news media and transmitted throughout the world within minutes of their occurrence. The political implications of military activities often impact heavily on international, regional and local affairs and can ultimately reflect on the acceptability of continuing or future military activities. The PACFLT public affairs program is intended to keep both domestic and foreign publics informed of the activities and capabilities of the Pacific Fleet as an instrument of U.S. national policy and security, as well as promote an atmosphere of friendship, mutual respect and understanding between the United States and the free nations of the Pacific region. It also aims to stimulate public interest in naval activities through liaison with both domestic and foreign civilian organizations and assure public awareness of the responsibilities, accomplishments and participation of naval personnel as both members of the military and as United States citizens. Public affairs programs should keep Navy personnel and their families informed, which is a significant factor in morale and retention.

4. Purpose. This Annex issues, in necessary detail, the public affairs policy of the CINCPACFLT and provides the necessary guidance to conduct effective public affairs programs that conform with direction from higher authority. Additionally, this Annex provides substantial background information on established public affairs practices and procedures to enable public affairs officers (PAOs), both collateral duty and full time, and officers in command to conduct public affairs programs in the most effective manner. It has been written to accommodate the experience levels of all public affairs officers, from newly-appointed collateral-duty PAOs serving in ships at sea, to senior public affairs specialists. It is not meant to be a "coverall," and no attempt has been made to address all possible or potential circumstances. PAOs at all echelons and experience levels are encouraged to consult with senior PAOs informally, attend training and skill seminars and officially request guidance on specific issues when in doubt.

5. Supporting Directives. PACFLT officers in command shall prepare and issue directives in support of this Annex as necessary to ensure the proper implementation. Authority is granted to make extracts from this Annex as necessary to prepare supporting directives.

6. Recommended Changes. All PACFLT commands are encouraged to submit to CINCPACFLT recommendations for changes which will improve this Annex.

7. Timeliness of Information. This Annex frequently directs that information be provided to CINCPACFLT (or other designated officers in command) through the chain of command. In cases where time is clearly of the essence and submitting such information through normal channels would render it useless or cause it to arrive too late to be of assistance, it is expected that the information in question will be provided by message directly to CINCPACFLT (or the appropriate officer in command) with others in the chain of command as information addressees. Information addressees in such messages are expected to comment in a timely fashion on the information just as they would if the information were sent through the chain of command. Again, in cases where time is of the essence but a message will not provide required information early enough to be of use, commands are strongly encouraged to use the telephone. CINCPACFLT Public Affairs is normally manned from 0700W to 1700W on weekdays, except Saturdays when it is manned from 0700W to 1200W. During working hours CINCPACFLT Public Affairs may be reached at DSN 430-0111, ext. 471-3769 or 474-4936/4938. During all other hours, the CINCPACFLT Operations Duty Officer should be contacted at DSN 430-0111, ext. 471-8745/8730. Public affairs telecopy is available 24 hours at (808) 422-0771.

8. Conflicting Information. Should guidance in this Annex conflict with guidance issued by higher authority than CINCPACFLT, the guidance issued by the higher authority will apply and the conflict will be reported to CINCPACFLT. Nothing in this Annex is meant to conflict with guidance issued by higher authority.

9. Tasks and Policies.

a. Policy. All officers in command of PACFLT units and their assigned PAOs are required to be familiar with public affairs policies outlined in this Annex and other public affairs policies affecting their units.

b. PA Program. PACFLT officers in command shall develop an aggressive but realistic public affairs program with attainable objectives. For echelon three commanders, this program should be published and issued to subordinates.

c. Authority. A forthright, cooperative and tactful policy of maximum candor, consistent with security, toward the general public and news media representatives shall be used in all matters. In accordance with appropriate guidance and existing policies, CINCPACFLT authorizes and encourages subordinate commands to do the following:

(1) Maintain close liaison with professional public affairs personnel, news media and other naval, military and governmental activities.

(2) Arrange for adequate Navy public information coverage, including official U.S. Navy photographic coverage, of noteworthy events and activities.

(3) Arrange press interviews and appearances of naval personnel on radio and television programs.

(4) Encourage production of radio and television within the Navy itself.

(5) Submit to the Fleet Home Town News Center, on significant and newsworthy occasions, appropriate news material and photographs concerning Navy personnel attached to the command. More individualized photo features should be marketed to the appropriate internal news media, or forwarded to appropriate Navy Offices of Information (NAVINFOs) for marketing to specific external (commercial) news media.

(6) Arrange for press, civic and other official tours of the command and conduct general visiting afloat/ashore for the public when appropriate.

(7) Initiate and assist in the implementation of plans for Navy and Marine Corps participation in national and local holidays, public ceremonies, parades and other special events, when appropriate. Advice should be sought from the appropriate U.S. agencies (including Navy regional coordinators, defense attaches, American consuls and local U.S. Information Service (USIS) posts) before committing participation.

(8) Encourage command personnel participation in activities of local schools, churches, fraternal, social, or civic organizations, sports and recreation programs and other aspects of community life to the extent feasible and appropriate.

(9) Stimulate public interest in the Navy through liaison with civilian organizations and with community business and civic leaders.

(10) Prepare public affairs annexes to all exercise and operation plans and orders to make sure public affairs aspects of all activities are considered in the early planning stages.

(11) Review public speeches, statements, correspondence, interviews and appearances of naval personnel on matters of public interest for military security, propriety and policy. When appropriate, forward such matters for review and clearance by higher authority. This is particularly important for public communications of senior officers (verbal or written) on subjects with policy ramifications, despite the intended audience or the absence of news media.

(12) PACFLT officers in command will conduct an effective program of communication with internal Navy audiences, particularly for active-duty personnel assigned to the command and for their dependents.

d. Basic Tenets. The following are basic public affairs tenets for all officers in command of PACFLT units and their PAOs.

(1) Confine all public discussion and releases to those areas over which the command or person concerned has direct responsibility and direct personal knowledge.

(2) At no time conduct public discussion of political or foreign policy matters unless specifically authorized to do so by higher authority.

(3) Do not divulge future plans or specific operational capabilities which could be of use to any enemy or potential enemy.

(4) If in doubt about what may be discussed or released, seek guidance from a senior command or a professional PAO.

(5) Do not speculate, answer speculative questions or render opinions on real or hypothetical situations when such information is intended for public release or publication.

(6) Maintain a current file of applicable public affairs guidance.

10. Referencing. When you are referencing this Annex in letter correspondence, all commands are expected to refer to the specific page number(s) containing the information (i.e., CINCPACFLT OPOD 201, Annex F, Appendix 2, Tab A, pg. 3). Tab C to Appendix 1 lists other directives containing information and guidance pertinent to the conduct of public affairs in the PACFLT.

11. Reports. Reports required by this Annex are assigned report control symbols as follows:

a. Subparagraph 5b of Appendix 2 and subparagraph 1b of Tab A to Appendix 2 are exempt from control by OPNAVINST 5200.19D.

b. Appendix 4, subparagraph 3i(3). Symbol CINCPACFLT 5773-2.

DAVID E. JEREMIAH
Admiral, U.S. Navy
Commander in Chief, U.S. Pacific Fleet

Appendix (for display purposes only):

- 1- Administration
- 2- Policy on Release of Information
- 3- Community Relations and Overseas COMREL Funding
- 4- Internal Relations Policies and Procedures
- 5- Exercises
- 6- Embarkation of Visitors
- 7- Special Guidance
- 8- Index/Cross-Reference Guide

OFFICIAL:

L. E. SHEEHAN
Commander, U.S. Navy
Flag Secretary

APPENDIX III

CIB PLAN (SPECIAL EVENT)

NAVAL AVIATION MUSEUM DEDICATION PUBLIC AFFAIRS PLAN

1. Purpose. The purpose of this plan is to provide guidance for the public affairs aspects of the Naval Aviation Museum dedication ceremonies, to facilitate media coverage, and to prescribe assistance for the news media in advance of, during and after the ceremonies.

2. Background. The dedication of the Naval Aviation Museum marks the culmination of efforts by naval aviation enthusiasts over the past 20 years to make such a museum a reality. The stage one building now completed (68,000 square feet of an eventual 260,000-square-foot facility) will be turned over to the U.S. Navy by the Naval Aviation Museum Association, Inc., in dedication ceremonies that will take place on 13 April.

3. Public Affairs Objectives. The public affairs objectives for the museum dedication include the following:

a. Satisfying the requirements of news organizations.

b. Emphasizing the importance of naval aviation in the progress and defense of our country.

c. Acquainting the public with the existence of the Naval Aviation Museum as an educational institution.

4. Policy. Public affairs policy, coordinated with the Chief of Information (CHINFO), and set forth by the Chief of Naval Education and Training (CNET), will be implemented by the Officer in Charge, Command Information Bureau, Naval Aviation Museum (OIC, CIBNAM). All participating commands and agencies will be given equitable and appropriate coverage. Cooperation will be extended to all reporters in accordance with existing directives from higher authority.

5. Organization. Under the direction of CNET, CIBNAM will be located in the Barrancas Beach House, across from the Naval Aviation Museum. A sub-CIBNAM will be located to the west and rear of the general audience at the dedication ceremony.

a. CNET will order activation of CIBNAM at 0800, 10 April, or earlier, depending on the extent of on-scene media interest.

b. On 12 April, CNET will order activation of the sub-CIBNAM.

c. CNET will order disestablishment of the CIBNAM and sub-CIBNAM on 14 April.

6. Responsibilities.

a. CHINFO, in accordance with the Naval Aviation Museum information plan, will do the following:

(1) Provide liaison with the appropriate members of the national news media and arrange transportation where possible, to NAS Pensacola.

(2) Provide such other assistance as maybe required including augmentation personnel for CIBNAM and sub-CIBNAM.

b. CNET will monitor public affairs activity for propriety, policy, efficiency and maximum effectiveness throughout the period of the dedication.

c. Commander Training Air Wing Six will provide personnel as indicated in Appendix I.

d. Commanding Officer, NAS Pensacola will provide messing for the news media and transportation as indicated in Appendix IV.

e. Commander, Public Works Center will do the following:

(1) Provide logistical support to the CIBNAM and sub-CIBNAM including the following: telephone, physical space and other support as deemed necessary according to Appendix II, and Tab B to Appendix II.

f. The Director, Naval Aviation Museum, will make sure the OIC, CIBNAM (CNET PAO) (until establishment of CIBNAM) is provided a continuous updating of invitation regrets and acceptances, and assign a technical advisor as specified in Tab A to Appendix I.

g. The Officer in Charge, CIBNAM will do the following:

(1) Promulgate and implement public affairs policy, consistent with this plan and directives of higher authority.

(2) Coordinate and control all public affairs activities of commands, units and organizations engaged in the dedication ceremony according to the provisions of this plan and as directed by CNET.

(3) Authorize and serve as the sole releasing authority for the release of news, photography, radio and television material. Coordinate the release of all news of national interest with CHINFO.

(4) Coordinate arrangements for on-scene coverage, briefings, transportation and messing of reporters. Prepare and distribute news media information kits.

7. Procedures.

a. Seating. Eighty seats will be reserved and appropriately marked for members of the news media in the first four rows of general seating in front of the main podium where the dedication ceremony will be held.

b. Coverage Areas. Two roped-off areas will be established as specified in Tab A, marked for use by press only, and be equipped for use by radio (press area two) and still/video photographers (press areas one and two). Each roped-off area will contain a tier for elevated angles of coverage, 100-amp electrical outlets for television camera use and hydraulic mechanic stands (press areas one and two) for elevation purposes. Press area two will have the capability to allow taping of the proceedings.

c. Pooling. In the event that certain functions planned in conjunction with the dedication cannot accommodate all reporters present (e.g., the memorial service or the luncheon at the Officers Club), a pool of representatives will be chosen by the news media or other appropriate authority.

d. Security. All reporters, except those specially designated, will be required to check into the CIBNAM where they will register and receive a press pass and automobile pass. Those holding specially designated cards will have access to all areas designated for press. Press passes will include the name, address and organization affiliation of reporters.

8. Services for Media

a. Press Kits. To provide members of the media at the dedication site with information pertinent to the dedication of the Naval Aviation Museum, a press kit published by CNET PAO will include the following:

- (1) Schedule of formal activities relating to the dedication.
- (2) Fact sheet on the museum, its background and plans for expansion.
- (3) Fact sheet on planes on exhibit at the museum.
- (4) Reproduction of the floor plan of the museum showing location of various planes.
- (5) Various feature stories.

b. Photo Library. A photo library will be established at CIBNAM pertaining to both the museum and the planes on exhibit. Copies of photos will be available to the media through an order blank made available to those wishing to use the library.

c. Briefing and Tour of Museum. The Naval Aviation Museum will make its auditorium available as a briefing center. The Director, Naval Aviation Museum or those designated by him to be knowledgeable in the area of naval aviation history and the development of the museum will be available to conduct tours of the facility upon request.

d. Messing. Food and beverages will be made available to members of the media at the CIBNAM.

e. Equipment and Supplies. Typewriters and telephones will be available at the CIBNAM and the sub-CIBNAM. Limited supplies—paper, pencils, and so forth—will be available at both locations.

f. Transportation. Bus service will be available from Sherman Field to CIBNAM to accommodate arriving news media, and be available after the dedication to return them to departing planes, and as specified in Appendix IV.

9. Communications.

a. Communication facilities at the CIBNAM will be sufficient to handle the foreseen demands and to provide an adequate flow of news, as specified in Appendix III.

b. Queries by telephone outside the Pensacola area will normally be answered on a collect call basis. Under no circumstances will news media be authorized to use government communication facilities for other than collect calls.

Appendices

- I - Personnel and Organization
- II - Facilities
- III - Communications
- IV - Transportation

APPENDIX I (EXAMPLE)
PERSONNEL AND ORGANIZATION

1. General. This section establishes the personnel requirements of CIBNAM established to support the dedication of the Naval Aviation Museum, assigns specific responsibilities and delineates the duties of the assigned personnel.

2. Organization. The organizational structure of CIBNAM and sub-CIBNAM is specified in this Appendix. Personnel requirements are listed in Tab A.

3. Responsibilities and Assignments. Specific responsibilities and duty assignments of personnel for CIBNAM and sub-CIBNAM are as follows:

a. Officer in Charge, CIBNAM. The CIBNAM officer in charge will report directly to CNET, coordinating CIBNAM activity with the dedication coordinating officer. His responsibilities for the public affairs aspects of the Naval Aviation Museum dedication are as follows:

(1) Establish a CIBNAM.

(2) Establish plans, policy and procedures for the CIBNAM and delegate authority for carrying out a public affairs program to include the following:

(a) Media security and credential arrangements.

(b) Facilities for news media.

(c) Production and release of material suitable for use by the media.

(d) Coordination, with CHINFO, of still and video coverage and release to appropriate national and local media outlets.

(e) Assignment of both active-duty and Reserve personnel to implement this plan.

(f) Coordination with CHINFO to ensure that the dedication of the Naval Aviation Museum receives adequate attention in appropriate areas of Navy internal relations programs, both before and following the event.

b. Assistant OIC, CIBNAM. The assistant OIC, CIBNAM serves as the executive officer and reports to the OIC, CIBNAM. His specific duties include the following:

(1) Controlling and monitoring news media transportation from Sherman Field to CIBNAM and sub-CIBNAM, as well as movement of the media during the dedication.

(2) Supervising the accreditation of news media, including implementation of procedures for accreditation and maintenance of accreditation records.

(3) Supervising the administrative work of the CIBNAM.

c. Photojournalist. The photojournalist will concentrate on the preparation and production of photographic features relating to the dedication ceremonies. He reports to the head, media relations.

d. Head, Administrative Section. The head, administrative section, is responsible for the general administration of the CIBNAM. He reports to the assistant OIC. Specific duties include the following:

(1) Maintenance of personnel records and assignments as included in this public affairs plan.

(2) Maintenance of official correspondence records.

(3) Clerical and administrative tasks, as directed.

(4) Supervision of two drivers assigned to CIB.

e. Head, Media Relations. The head, media relations, is responsible for the gathering and dissemination of information to news media concerning dedication ceremony activities. He reports to the OIC, CIBNAM. His specific duties include the following: implementing the public information program, coordinating the assembly and distribution of news media information kits and setting up briefing sessions and tours relating to the Naval Aviation Museum.

f. Press Officer, Media Relations. The press officer has the responsibility to disseminate information to members of the news media. He reports to the head, media relations with specific duties to include the following:

(1) Preparing event and post-event material for public release, including press kits, background information, biographies of personnel and other data.

(2) Coordinating requests for media interviews with project and museum personnel.

(3) Providing other assistance to news media representatives, including the handling of all written and verbal inquiries.

g. Magazine and Still Photo Officer. The magazine and still photo officer is responsible for providing assistance to members of the media requiring preparation of magazine material and the release of still photography. He reports to the head, media relations. Duties of this officer will include the following:

(1) Providing assistance to magazine and book media representatives as appropriate.

(2) Establishing and supervising procedures for release of still photography.

(3) Maintaining a master library of all photography for release, along with necessary forms for ordering particular photos.

(4) Distribution of still photography.

(5) Supervision of darkroom facilities for wire services at the NAS Pensacola photographic laboratory.

h. Television Officer. The television officer is responsible for all liaison and coordination with commercial and educational television covering the dedication ceremonies. He will report to the head, media relations.

i. Radio Officer. The radio officer is responsible for the production of radio material during the ceremonies. He will report to the head, media relations. Specific duties include the following:

(1) Effecting liaison with sub-CIBNAM personnel to provide on-site assistance to representatives of radio networks.

(2) Coordination of special telephone interviews between museum personnel, distinguished participants and radio representatives.

(3) Participating in, and supervising, the production of radio tape material for dissemination to regional or national radio outlets which have no representatives on hand for the dedication ceremonies.

(4) Supervising the establishment and maintenance of a master library for all released radio tapes.

(5) Distribution of released radio tape material.

(6) Coordinating all requests for assistance from radio media.

(7) Assisting in the preparation of material for release on radio tapes.

(8) Maintaining logs and library for all released radio tapes.

(9) Operating tape recording equipment to produce radio tape material for distribution, including beeper reports direct to radio audio outlets.

(10) Coordination of radio reports with the CHINFO automatic beeper system.

j. Technical Advisor. This official will be assigned by the museum to provide guidance to CIBNAM on the technical aspects of museum development and naval aviation history and exhibits on display. He will be available to answer questions of technical nature posed by the news media. He will report to OIC, CIBNAM.

k. Journalists. Journalists will be available to assist the news media, as directed by the head, media relations.

(1) Head, sub-CIBNAM. The head, sub-CIBNAM, located at the site of the dedication, coordinates on-scene public affairs activities and provides assistance to news media representatives at the dedication ceremony itself. His primary responsibilities are as follows:

(a) Serve as liaison for CIBNAM personnel.

(b) Coordinate media activities on site along with the assistant OIC, CIBNAM.

(c) Provide periodic situation reports to the OIC, CIBNAM.

(d) Arrange interviews for reporters with museum dignitaries and personnel.

m. Media Officer, sub-CIBNAM. The media officer, CIBNAM Annex will provide assistance to media representatives and is the CIBNAM representative in the press section of the area in which press seats are reserved during the ceremony. He reports to the head, sub-CIBNAM and is responsible for a continuous flow of information to the CIBNAM. He will make certain that only credentialed news people are allowed in the seating area for press.

n. Assistant Press Officers. There will be three assistant press officers, each assigned to monitor one of the three roped off areas marked "Press Only." Duties of the assistant press officers will include the following:

(1) Escorting media representatives who wish to move beyond the designated areas for press members.

(2) Making certain that members of the media display their press credentials before gaining access to the roped off areas.

(3) Carrying out related public affairs duties as required by the head, sub-CIBNAM.

TAB A TO APPENDIX I (EXAMPLE)
PERSONNEL REQUIREMENTS FOR CIBNAM AND
SUB-CIBNAM

1. Command Information Bureau, Naval Aviation Museum (CIBNAM). The following Navy and civilian personnel will staff the CIBNAM and will report at 0800, 7 April to CNET PAO, except those indicated by asterisks, who will report at 0800, 11 April.

a. Command

<u>Grade</u>	<u>Billet</u>	<u>Command Source</u>
CDR	OIC	CNET
LCDR	Assistant OIC	CNET
YN1	Head Administration	CNET
SN*	Driver	NASP
SN*	Driver	NASP
SN*	Driver	NASP
GS	Technical Adviser	Naval Aviation Museum

b. Media Relations

GS	Head, Media Relations	CNET
LTJG	Press Officer	CNET
LT	Television Officer	COMNAVRES
LT	Radio Officer	COMNAVRES
LCDR	Photo Officer	NASP
PH1	Photographer	CNET
PH2	Photographer	CNET
PH3	Photographer	NASP

2. Sub-Command Information Bureau, Naval Aviation Museum (sub-CIBNAM). The following Navy and civilian personnel will staff the sub-CIBNAM and will report at 0800, 11 April to CNET PAO, except those indicated by asterisks, who will report at 0800, 7 April.

<u>Grade</u>	<u>Billet</u>	<u>Command Source</u>
LCDR	Head, CIBNAM Annex	COMNAVRES
LTJG	Press Officer	CNET
GS-9*	Assistant Press Officer	NASP
ENS*	Assistant Press Officer	VT-10
ENS*	Assistant Press Officer	NASC
JO/PH1	Photojournalist	CNET
JO2	Journalist	CNET
JO3*	Journalist	CNET
JO3*	Journalist	CNET

APPENDIX II (EXAMPLE) FACILITIES

1. General. To facilitate news coverage of the dedication ceremonies, facilities appropriate to the occasion will be established. This will include a CIBNAM at the Barrancas Beach House located across the road from the Naval Aviation Museum, the sub-CIBNAM in a tented area to the west and rear of the general audience at the dedication ceremony, an alternate sub-CIBNAM set up inside the Naval Aviation Museum in the event of inclement weather and three roped off areas with necessary power and elevation equipment to accommodate still and video photographers, and so forth. (See figure A3-1.)

2. Procedures.

a. CIBNAM. The necessary tables, chairs and space are now available at the Barrancas Beach House. Installation of communication equipment in accordance with Appendix III of this public affairs plan can begin as the OIC, CIBNAM deems necessary. The main area of the CIBNAM will be designated for use by the media. Typewriters will be available for media use.

b. Sub-CIBNAM. This area to the west and rear of the general audience should accommodate one working table and two desks. Necessary chairs and supplies will be furnished by the CIBNAM. This area will serve as one of the filing areas for reporters and includes telephones.

c. Alternate Sub-CIBNAM. This area, to be outfitted in the same manner as the sub-CIBNAM, will be ready for use in the event of inclement weather and indoor ceremonies. An alternate sub-CIBNAM will be located on the mezzanine floor in a side cover area overlooking the main display area of the museum. Telephones for media use will be available inside the museum.

d. Roped-off Areas for Press Use. To accommodate still and video photographers and radio media, two roped-off areas are to be established, each within 50 feet of the main podium used for the dedication ceremony. Access to these mess during the dedication will be controlled by a press officer. Reporters will have free access to the sub-CIBNAM for filing purposes at all times.

(1) Press Area One. This area will be located to the west of the main podium and measures approximately 10 by 10 feet. Electrical power (100 amps) will be provided to accommodate necessary television needs (four outlets). Two hydraulic mechanical stands provide an 8-foot lift on an approximately 5 by 5 foot platform that will be provided.

(2) Press Area Two. This area will be located directly in front of the main podium and will consist of an area about 20 by 30 feet. A one-tiered platform (3 feet high by 5 feet deep by 20 feet long) for elevation purposes will be situated in this area. This tier will be equipped to handle 100 amps of power through 12 electrical outlets and radio needs.

TAB A TO APPENDIX II (EXAMPLE)
 NAVAL AVIATION MUSEUM
 DEDICATION DIAGRAM

Note: Press areas 1, 2 and 3 to be roped off, and marked Press Only. Controlled access.

40-50 feet distance between main podium and each press area.

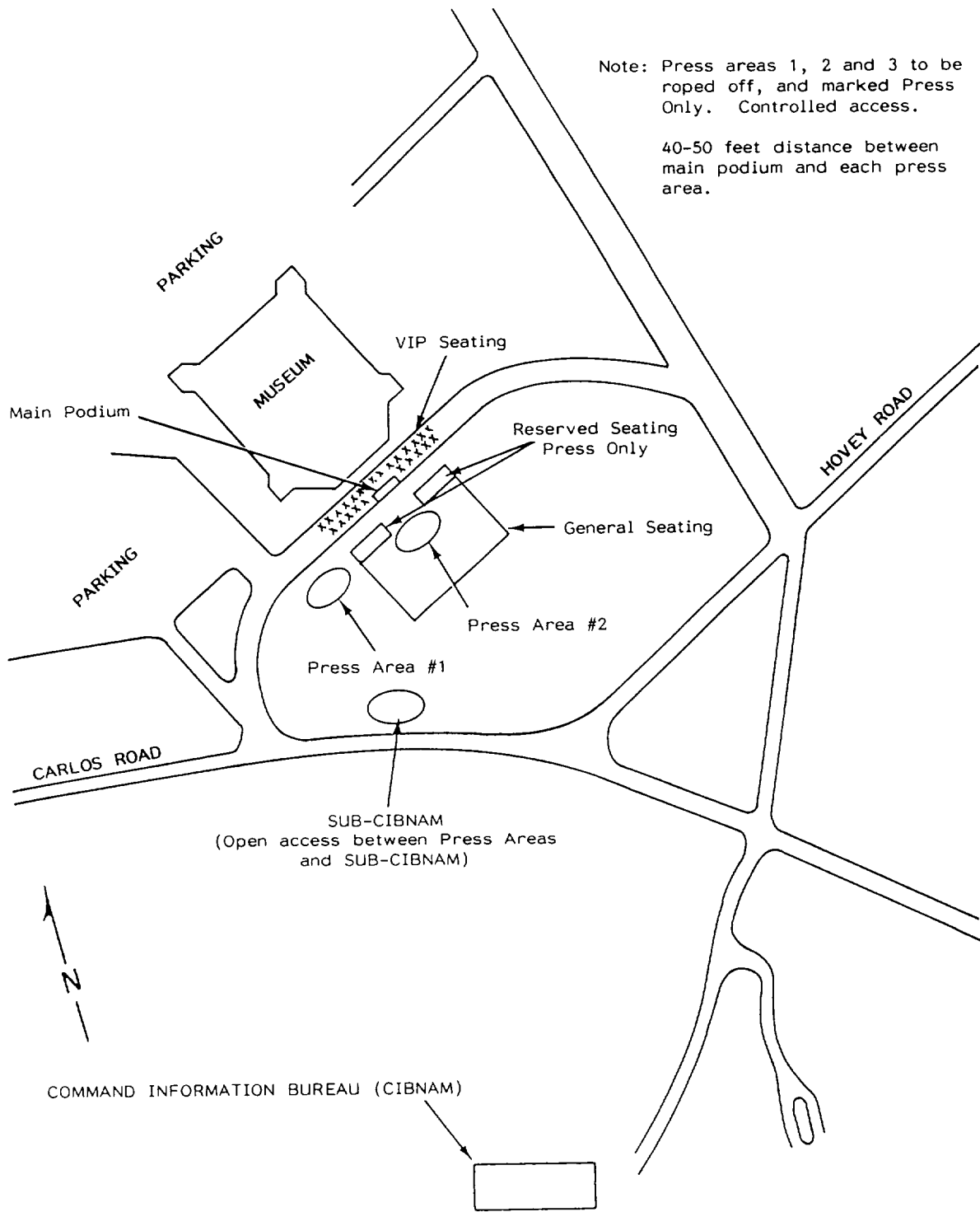

Figure A3-1.—Naval Aviation Museum dedication diagram.

e. Roped-off Areas Inside the Museum. Three areas similar to those described in subparagraphs 2d (1) and (2) of this Appendix will be established in the Naval Aviation Museum in the event that the dedication ceremony is held inside. These areas will be within 50 feet of the main podium from which the ceremony would be held. Low platforms may be used for elevation vice tiers specified for outdoors.

3. Specific Responsibilities.

a. The OIC, CIBNAM will coordinate the establishment of facilities as outlined in this section of the public affairs plan.

b. Commanding Officer, Public Works Center, will setup facilities according to this section of the public affairs plan including the following:

(1) One open-air tent, about 40 feet by 40 feet surface overhead, located in accordance with Tab A.

(2) Two roped-off areas located in accordance with Tab A for press areas one and two. A rear entrance control gate should be set up, along with a sign for each area indicating "Press Only."

(3) A sign indicating "Press Information Center" to be placed at the entrance of the driveway to the Barrancas Beach House.

(4) A sign indicating "Press Information Center Annex" to be located in a visible place at the tent site.

(5) Two hydraulic elevation platforms, about 5 feet by 5 feet, to be located in area marked press area one.

(6) Tiers of the dimensions outlined in subparagraph 2d (2) to be constructed in accordance with their proper locations as indicated. Flatbed trailers may be substituted for constructed tiers.

(7) Electrical outlets capable of handling 100 amps of power to be located in areas designated press areas one and two (total 16 outlets).

(8) Twelve electrical outlets capable of handling 200 amps of power to be located within the Naval Aviation Museum, in each of three designated areas as determined by OIC, CIBNAM and the Director, Naval Aviation Museum.

(9) Eighteen typewriters, 16 to be located in CIBNAM and two in the sub-CIBNAM.

(10) Three bulletin boards to be located in the CIBNAM for display of available photos relating to the museum dedication (about 4 feet by 4 feet each), and one board for posting messages for media representatives.

TAB B TO APPENDIX II (EXAMPLE)
EQUIPMENT AND CONSUMABLE SUPPLIES

<u>ITEM</u>	<u>QUANTITY</u>	<u>LOCATION</u>	<u>SOURCE</u>
Desk single/double pedestal	6	4 CIBNAM/2 Annex	2
Table, library	31	25 CIBNAM/6 Annex	3
Table, small eating	21	20 CIBNAM/1 Annex	3
Chairs, arm	7	5 CIBNAM/2 Annex	2
Chairs, card table	100	88 CIBNAM/12 Annex	3
Typewriter	18	16 CIBNAM/2 Annex	2
Wastebasket	23	20 CIBNAM/3 Annex	2
Bulletin board 4' x 4'	4	3 CIBNAM/1 Annex	2
Trash can, large	5	4 CIBNAM/1 Annex	2
Signs, wood	3	2 CIBNAM/1 Annex	2
Sedan/station wagon	3	CIBNAM	2
Van, 10 passenger	1	CIBNAM	2
Bus, 45 passenger	1	CIBNAM	2
Light, hanging, 100 watt	5	Annex	2
Tent, 40' x 40'	1	Annex	2
Outlet, electrical	1 double	Annex	2
Food, beverages	As required	CIBNAM/Annex	4
Telephone, incoming/tie line	6	4 CIBNAM/2 Annex	2
Head, portable	1	Annex	2
Hydraulic stands	2	Dedication Site (DS)	2
Outlets, electrical	48	36 DS/12 NAM	2
Photographic tiers	6	D S	2
Tape recorder	1	DS	1
Patch board/multiplex	1	D S	1
Ash trays	50	40 CIBNAM/10 Annex	1
Pencils, #2	20 boxes	15 CIBNAM/5 Annex	1
Pens, ball point	20 boxes	15 CIBNAM/5 Annex	1
Cellophane tape dispenser, large roll	7	5 CIBNAM/2 Annex	1
Paper clips	10 boxes	8 CIBNAM/2 Annex	1
Reporter's notebooks	100	85 CIBNAM/15 Annex	1
Cups, styrofoam	600	500 CIBNAM/100 Annex	1
Paper, typing	20 reams	18 CIBNAM/2 Annex	1
Cellophane tape	14 rolls	10 CIBNAM/4 Annex	1
Staples, standard	10 boxes	8 CIBNAM/2 Annex	1
Staplers, standard	20	14 CIBNAM/6 Annex	1
Spoons	600	500 CIBNAM/100 Annex	1

1 - CNET

2 - PWC

3 - Barrancas Beach House

4 - NASP

**APPENDIX III (EXAMPLE)
COMMUNICATIONS**

1. General.

Communication facilities will be provided to handle news situations appropriate to an event of national significance involving senior government officials. Communication facilities at CIBNAM and sub-CIBNAM will be limited and will include only such equipment as is necessary to provide official public affairs communications.

2. Procedures.

a. Queries by telephone outside the Pensacola area will normally be answered on a collect call basis.

b. Press copy may be filed from CIBNAM for transmittal collect to receiving organizations.

c. Under no circumstances will reporters be authorized to use government communication facilities for other than collect calls.

d. All queries from the media concerning the dedication will be channeled to CNET PAO or CIBNAM, when established.

3. Equipment.

a. CIBNAM. Four regular telephone instruments capable of handling three lines, plus a tie line between the CIBNAM and sub-CIBNAM, with hold and light capability, will be setup in the CIBNAM.

b. Sub-CIBNAM. Two regular telephone instruments capable of handling three lines, plus tie line, with hold and light capability, will be set up in the sub-CIBNAM tented area near the dedication site.

4. Specific Responsibility.

a. Commanding Officer, Public Works Center, will do the following:

(1) Provide communications support for CIBNAM and sub-CIBNAM before, during and after the dedication ceremony.

(2) Assure installation of the equipment required for the conduct of public affairs in the CIBNAM and sub-CIBNAM at the desired time. Regular telephones should be installed by 7 April, and direct long distance telephones by 11 April.

(3) Assure that upon disestablishment equipment is properly removed and returned.

(4) Coordinate installation of equipment, in accordance with paragraph three of this Appendix, with the assistant OIC, CIBNAM.

(5) Provide one tape recorder for setup in press area two.

b. The assistant PAO, CNET is designated to serve as coordinator for installation of communications equipment in the CIBNAM and sub-CIBNAM, and to serve as public affairs liaison with Southern Bell Telephone to effect arrangements for news media communication facilities, as desired by the CO, PWC.

**APPENDIX IV (EXAMPLE)
TRANSPORTATION**

1. General. It is anticipated that many incoming and departing reporters may use Sherman Field as their air transportation entry and exit facility. According to previous guidance, CHINFO will coordinate all air transportation for reporters representing national organizations.

2. Procedures. In accordance with the transportation provisions of this plan, government furnished ground transportation will be available to shuttle reporters from Sherman Field to the CIBNAM.

3. Specific Responsibilities.

a. CIBNAM will do the following:

(1) In conjunction with CNET (N-4), determine flight schedules for arriving news media; notify appropriate personnel of any change in schedules or originally planned arrival times.

(2) Coordinate arrangements for arrival and departure transportation.

(3) Provide on-base transportation for local and area news media.

b. Commanding Officer, NAS Pensacola, will do the following:

(1) Arrange for and provide necessary vehicles and drivers.

(2) Provide one 45-passenger bus to meet scheduled media flights.

(3) Provide three Navy sedans/station wagons and a 10-passenger van to the CIBNAM for the period 10 April through 14 April, along with drivers for vehicles.

(4) Direct all reporters arriving by vehicle at the front gate to the CIBNAM, where parking facilities are available.

APPENDIX IV

ADVERSE INCIDENT PLAN

COMTHIRDFLT
OPERATION ORDER
ROSE FESTIVAL VISIT

APPENDIX III TO ANNEX B ADVERSE INCIDENT PLAN

Reference: (a) SECNAVINST 5720.44A
(b) BUPERS MANUAL
(c) MARCORPERSMAN, Chapter 12
(d) PACFLT Regulations, Article 12104.1
(e) (All others as applicable)

1. Purpose. The purpose of this Appendix is to specify the procedure and format for the release of information concerning adverse incidents occurring during the Portland Rose Festival visit.

2. Definition. An “adverse incident” is considered to be as follows:

a. Any personal casualty, whether to military or civilian personnel, which results in death, being placed in a “missing” status or injury serious enough to require hospitalization.

b. Lesser injuries to a group of persons, resulting from a single incident.

c. A major accident or incident which could be or could become the subject of press interest, and particularly those incidents which are or could have been observed by civilian media representatives or guests.

3. Background. Although it is not likely, there is a possibility that adverse incidents will occur during the Rose Festival visit. The occurrence of adverse incidents is invariably of great interest to the media. Experience has shown that news coverage of such incidents can be limited to a relatively brief time period if essential information on the incident can be provided in the briefest possible period of time. Identification of persons involved in adverse incidents is of special interest to the media and is most often the item that extends news coverage into additional days.

4. Policy. It is the policy of the Secretary of the Navy that essential news of adverse incidents will be released when known, unless such release would compromise military security. To accomplish its mission, the Rose Festival CIB must be expeditiously informed of all particulars of adverse incidents, including full identification of persons involved. The decision as to what news is to be released to the press, and that of when such news is to be released, is the responsibility of the information coordination officer. In no case will individual commanders attempt to withhold such information from the CIB. Wording and timing of press releases pertaining to adverse incidents will be determined by the merits of individual cases; whenever possible, identification of casualties will be withheld until the next of kin may reasonably be expected to have been notified.

5. Action.

a. In accordance with reference (a), an OPREP-3 Navy Blue will be sent to the appropriate authorities.

b. COMTHIRDFLT and CO, USN & MCRTC, Portland, Oregon, will be made information addressees on all communications required by reference (a) or (b), whichever is appropriate.

c. The CIB will initiate any reports deemed necessary in accordance with reference (d).

d. Format for Notification of the CIB. Upon occurrence of an adverse incident, the commander concerned will notify the CIB by the most expeditious means possible, giving the following information:

(1) Summary description of incident.

(a) What happened

(b) When

(c) Where

(d) How

(e) Why

(2) Persons killed.

(a) Name

- (b) Rank/rate
- (c) Social Security number
- (d) Branch of service
- (e) Parent command
- (f) Name, address and relationship of next of kin
- (g) Status of notification of next of kin
- (h) Factors which may preclude public release, if any

(3) Persons missing.

- (a) Name
- (b) Rank/rate
- (c) Date of birth
- (d) Social Security number
- (e) Branch of service
- (f) Parent command
- (g) Name, address and relationship of next of kin
- (h) Status of notification of next of kin
- (i) Factors which may preclude public release, if any

(4) Persons injured.

- (a) Name
- (b) Rank/rate
- (c) Date of birth
- (d) Social Security number

- (e) Branch of service
- (f) Parent command
- (g) Name, address and relationship of next of kin
- (h) Status of notification of next of kin
- (i) Critical, serious, or minor injury, if determined
- (j) Description of injury, expressed in lay terminology
- (k) Treatment and evacuation sequence
- (l) Factors which may preclude public release, if any

(5) Persons involved but not injured.

- (a) Name
- (b) Rank/rate
- (c) Date of birth
- (d) Social Security number
- (e) Branch of service
- (f) Parent command
- (g) How involved

(6) Brief estimate of the extent of the damage to major equipment. This information is important to the CIB in determining the method of handling your particular incident. If the CO objects to releasing this item, so state, and give a brief reason for the objection.

(7) Does the commander desire the CIB to provide PAO assistance at the scene of the incident?

(8) In using this format, omit reference to those items that are not applicable. Indicate as unknown those pertinent items for which this word applies. A follow-up should be sent as soon as additional facts are known.

APPENDIX V

SHIP COMMISSIONING PLAN

PRECOMUNIT LEYTE GULF (CG 55) NOTICE 5060

Subj: COMMISSIONING PLAN

- Encl: (1) Commissioning Event Subcommittees
(2) Public Affairs/Media Liaison Plan
(3) Invitation Plan
(4) General Arrangements Plan
(5) Seating Plan
(6) Ship Visits/Post Ceremony Plan
(7) Preliminary Script for Commissioning
(8) Manning the Rail Procedures
(9) Proposed Commissioning Plan of Actions and Milestones

1. Purpose. To outline and assign responsibilities for the Commissioning Ceremony of LEYTE GULF (CG 55).

2. Information. LEYTE GULF will be commissioned on Saturday, 5 September 1987, in Fort Lauderdale, Florida.

3. Discussion.

a. The hallowed tradition of commissioning and breathing life into a great man-of-war is an occasion of special significance which generates great national pride and commitment. The commissioning of LEYTE GULF will be particularly significant because we will be sharing this precious experience in an intimate way with the citizens of Fort Lauderdale, Port Everglades and Hollywood, Florida. Moreover, we will be recognizing in our nation's most impressive way, the valor and sacrifice of the thousands of U.S. Navy men who fought and won at Leyte Gulf in 1944.

b. The historical significance of LEYTE GULF's commissioning dictates that we execute the ceremony and attendant activities flawlessly.

c. We can expect national press exposure and many distinguished guests to attend. We will clearly establish the tradition of excellence we are building as LEYTE GULF plankowners by the style with which we carry out this event. Detailed and imaginative planning is required in addition to complete coordination with other commands and agencies involved. We must execute every detail with pride, professionalism and perfection. Uniforms will be impeccable; evolutions executed with smartness and enthusiasm; concern for our guests, thorough and genuine.

d. Mr. R. James Dodge is the commissioning committee chairman and the prospective executive officer is the ship's commissioning coordinator.

4. Action. Ship's subcommittee chairmen will do the following:

- a. Carry out assigned tasks in enclosures (1) through (8).
- b. Coordinate all details closely with their commissioning committee counterparts.
- c. Keep the committee chairman and the ship's coordinator apprised of their progress.
- d. Refer all conflicts to the committee chairman or the ship's coordinator for resolution as early as discovered.
- e. Update plans under their cognizance when changes are required.

JETTE BROWN

Distribution List:

All Officers

CPO Mess (10)

PCO, SAN JACINTO (CG 56)

LEYTE GULF (CG 55) Commissioning Committee (10)

COMMISSIONING EVENT SUBCOMMITTEES

<u>TITLE</u>	<u>COMMITTEE MEMBERS</u>
COMMISSIONING COORDINATOR SHIP'S COMMISSIONING COORDINATOR COORDINATES ACTIVITIES OF SUBCOMMITTEES	LCDR ODEGAARD LCDR SMITH
LOGISTICS OBTAIN BAND GIFTS FOR SPONSOR AND CREW/SHIP FUNDS COORDINATOR FOUL WEATHER COORDINATOR DECORATIONS TENTS/PORTABLE LAVS SEATING/BLEACHERS	CHAIRMAN: LT HOLLOWAY MEMBERS: SKCS BELLARD
PUBLIC AFFAIRS/INVITATIONS MEDIA LIAISON HOMETOWN NEWS PHOTO REQUIREMENTS COMMISSIONING BOOK/PROGRAM WELCOME ABOARD PAMPHLET COORDINATE GUEST LISTS COORDINATE INVITATIONS (PRINTING AND DISTRIBUTION)	CHAIRMAN: LT BILLE MEMBERS: ENS KAUFMAN EMCS SPROUSE FCC DAVIDSON FC1 JONES FC1 DODD ET1 BARNER GMG1 AUTREY YN1 ROOD STG3 LIBERTO
TRANSPORTATION, PARKING AND ACCOMMODATIONS LODGING ASSISTANCE FOR VIPS AND CREW ARRANGE REQUIRED TRANSPORTATION ARRANGE RESERVED/GENERAL PARKING	CHAIRMAN: LT KAPLAN MEMBERS: LT LANGLEY LTJG SAMPLES
SHIP'S COLOR AND HONOR GUARDS	CHAIRMAN: LT KAPLAN MEMBERS: ENS CHRISTIAN BMCS EVERSON GMGC GREGORY

Enclosure (1)

SOCIAL EVENTS

CO'S RECEPTION
CO'S BRUNCH
COMMISSIONING RECEPTION
CREW RECEPTION
OTHER EVENTS

CHAIRMAN: LCDR SMITH
MEMBERS: ENS ROBERTS
MSC ABASTA

CEREMONY AND HONORS

COORDINATE HONORS PLAN
COME ALIVE CEREMONY
SHIP'S TOURS
ARRANGE PLATFORM GUESTS AND SPEAKERS PODIUM

CHAIRMAN: LCDR MAIORANO
MEMBERS: TBD

GENERAL SHIP AND PIER ARRANGEMENTS

PIER SELECTION
HARBOR SUPPORT
ARRANGEMENT OF:
GUEST SEATING
BAND STAND
OFFICIAL PLATFORM

CHAIRMAN: LCDR MAIORANO
MEMBERS: TBD

SAFETY, SECURITY AND USHERS

CROWD CONTROL
PIER AND HARBOR SAFETY
SHIP' S SECURITY
PLAN FOR USHERS AND ESCORTS

CHAIRMAN: LT FOLEY
MEMBERS: ENS TAN
GMMC HARRIS
GMG1 AUTREY

Enclosure (1)

PUBLIC AFFAIRS/MEDIA LIAISON PLAN

1. Purpose. To establish procedures and assign responsibilities for the coordination of all public affairs and media liaison matters in connection with the commissioning.

2. Responsibility. Public Affairs/Invitations Detail.

3. Schedule. The Public Affair/Media Liaison plan will be accomplished as follows:

<u>DATE</u>	<u>ITEMS FOR ACTION</u>
19 DEC 86	Welcome aboard pamphlet rough layout Establish committee members Submit waiver for multicolor printing Submit CHINFO request for commissioning speaker Coordinate with printing office for commissioning book requirements and recommendations
21 JAN 87	Commissioning book rough layout Official invitation letter draft
23 JAN 87	Welcome aboard pamphlet layout approved
3 APR 87	Organize photos of LEYTE GULF construction action shots Commissioning book rough layout with photos
22 MAY 87	Final commissioning book layout approved
29 MAY 87	Prepare CHINFO Report 5720-3
12 JUN 87	Send commissioning book to the printer
19 JUN 87	Order plankowner certificates for all hands
6 JUL 87	Detailed plan for CO's reception
22 JUL 87	Review CO's reception plans
31 JUL 87	Prepare VIP welcome packages: CO's welcome letter, 3 by 5 card with schedule of events, 3 by 5 card with VIPnames, map of Fort Lauderdale, Press kit

Enclosure (2)

DATE

ITEMS FOR ACTION

7 AUG 87	Assemble press kits: decorative folder, one-page photo and bio of CO, photo and bio of XO and C/MC on same page, ship's sponsor photo and bio, photo of LEYTE GULF under way, officer directory, commissioning book, CO's press release, Ingalls fliers, crest with description, history of namesake and ship photos
10 AUG 87	Prepare Fleet Home Town News release
14 AUG 87	Send prepared Fleet Home Town News releases
24 AUG 87	Distribute guest list of VIPs to all aids of flag officers attending commissioning
31 AUG 87	Volunteers for ushers and distributing commissioning books
4 SEP 87	Meeting with all involved public affairs personnel for final brief
5 SEP 87	LEYTE GULF COMMISSIONING

Enclosure (2)

INVITATION PLAN

1. Purpose. This plan provides for the issuance and control of invitations for the commissioning ceremony and the receptions following.
2. Responsibility. Public Affairs/Invitation Detail
3. Schedule. The invitation plan will be accomplished as follows:

<u>DATE</u>	<u>ITEMS FOR ACTION</u>
8 APR 87	Develop first invitation list from Fort Lauderdale military and local community
15 APR 87	Order invitation blanks
20 MAY 87	First run of ship's portion of invitation list submitted for review
20 MAY 87	Principal speakers/platform guests/distinguished guests identified
17 JUN 87	Deadline for submission of invitation requests
17 JUN 87	Invitations to printer for printing
30 JUN 87	Advanced invitation letters to VIPs
1 JUL 87	Establish RSVP tracking system
8 JUL 87	Final invitation list to computer for label printing
22 JUL 87	Have invitations ready to mail. Make final update to invitation list
31 JUL 87	Mail invitations
15 AUG 87	Acceptance review. Prepare final update to guest list. Confirm speakers
5 SEP 87	LEYTE GULF COMMISSIONING

Enclosure (3)

4. Invitations.

The following printed material will be required:

- a. Invitations to the commissioning ceremony.
- b. RSVP cards for the commissioning ceremony.
- c. Invitation envelopes with postage.
- d. RSVP card envelopes with postage.
- e. General information card and map of directions to commissioning site.
- f. Post-ceremony reception invitations.

5. Printing Procedures. The necessary printing will be procured through the Navy Publications and Printing Service Office in Pascagoula.

Enclosure (3)

GENERAL ARRANGEMENTS PLAN

1. This enclosure sets forth the physical arrangements of equipment, personnel and platforms and promulgates other miscellaneous procedures not covered in other enclosures.

2. Responsibility. Various.

3. Ceremony Details/Physical Arrangements.

a. Official Platform Guests and Speaker's Podium.

(1) LT Foley will act as the VIP coordinator.

(2) The platform guests of the official party will be seated in the area of the quarterdeck (Ceremony and Honors Detail).

(3) The speaker's platform will be attached to the ship immediately outboard of the quarterdeck with the speaker's podium placed on the platform (General Ship and Pier Arrangements Detail).

(4) The prospective executive officer will be provided a podium immediately aft of the platform guest seating area and near the ship's edge.

b. Guest Seating. Seating will be divided into three general categories: VIP, reserved and open. In view of the large crowd expected, an early assessment of the invitation response number will be required. It is expected that this particular concern will require flexibility and several last minute accommodations can be anticipated. A special section for handicapped guests will be designated. Special ushers will assist this group. Seating is discussed in further detail in enclosure (5) (Logistics Detail).

c. Band/Band Stand. A band stand will be set up in an area between the forward brow and the guest seating, facing the guests (General Ship and Pier Arrangements Detail).

d. Ship's Color Guard and Honor Guard. Members of the crew will be stationed on board to raise the ensign, jack and commissioning pennant which will be replaced by a second set after the ceremony. The originals will then be delivered immediately to the executive officer. The ship's honor guard will be presented to the principal speaker for inspection (Ceremony and Honors and Honor Guards Detail).

e. The Special Commissioning Watch is in addition to the "First Watch." Under the general direction of the operations officer, they shall coordinate the "come-alive" ceremonies and be prepared to respond to any contingency. The senior watch officer will promulgate a commissioning day watch bill not later than 15 August 1987.

Enclosure (4)

f. Uniform. The uniform prescribed for the commissioning ceremony shall be full-dress white for officers and chief petty officers and full-dress white jumper for first class petty officers and junior.

4. Honors Plan.

a. The weapons officer will make sure all preparations for the use of the ship's saluting battery are made not later than 1 June 1987. Backup saluting battery arrangements will be made.

b. Sequence of Events – Before the Commissioning Ceremony.

(1) Honors will be rendered for only the principal speaker. The Ceremony and Honors Detail will research the appropriateness of the honors afforded.

(2) The official party with platform guests will depart the staging location (TBD) in reverse order of seniority.

(3) Upon arrival at the commissioning berth, platform members of the official party will be met by the prospective commanding officer. Members of the official party will be escorted, as coordinated by the head usher and assisted by department heads, to the weather break where they will remain until individually introduced by the prospective executive officer. Chairs will be provided for the guests' comfort while awaiting their introduction. Names will be on the chairs identifying guests. Escorts will take VIP spouses to the appropriate seating area.

(4) Upon arrival, the principal speaker will be greeted by the prospective commanding officer. At this point, the ship's crew and honor guard will come to attention and appropriate honors will be rendered.

(5) The honor guard will then be reviewed by the principal speaker (escorted by the prospective commanding officer and the honor guard officer). The band will play appropriate music. Platform guests arriving with the principal speaker will wait at an appropriate spot until the inspection of the honor guard is complete. Upon completion of the review, the prospective commanding officer will escort the principal speaker to the weather break, where other platform guests will be waiting (seated). Each platform guest will proceed to prearranged seating as he or she is announced by the prospective executive officer.

Enclosure (4)

(6) The ceremony will proceed in accordance with the commissioning program.

c. Sequence of Events – After LEYTE GULF is commissioned: After reporting for duty to COMNAVSURFLANT, the commanding officer will request permission to break the flag of the principal speaker. The commissioning pennant will be hauled down as the other flag is hoisted and honors subsequently rendered.

d. Honors (sideboys and piping) will be rendered only to those guests in the official party upon their departure from the ship in accordance with *Navy Regulations*. Side honors will be rendered, the personal flag hauled down and the commissioning pennant will be broken.

e. Ceremonial officer of the deck will be assigned at a later date. Eight side boys will be assigned. They will form during the benediction and be in place for the official party after the ceremony and as the party departs. The BMOW will pipe the side as guests board.

Enclosure (4)

SEATING PLAN

1. Purpose. To assign responsibilities and establish procedures for handling chairs and determining the seating plan for the platform and the pier.
2. Responsibility. Logistics Detail. A seating plan will be developed by 30 April 1987.
3. Plan.
 - a. Procurement. Folding chairs will be used throughout the seating area. Platform armchairs will be the ship's Type II chairs with white slipcovers (RSVPs will determine the actual number).
 - b. Arrangement. The chairs will be arranged in accordance with the platform and pier arrangement plan. The number of chairs will be adjusted to correspond with the acceptances received as reported by the Invitation Detail.
4. Coordination. The Logistics Detail will coordinate:
 - a. With the department heads for the required working parties.
 - b. With the designated agent for the loading and unloading of chairs belonging to the civilian contractor.
 - c. With the Invitations Detail and head usher for seating in accordance with RSVPs.
5. A proposed seating arrangement of the guests on the platform and pier will be submitted to the prospective executive officer by 15 July 1987.
6. Seating Plan. Seating for VIPs, organization block seating and general guests will be provided in the areas facing the official platform.
 - a. VIPS are defined as follows:
 - (1) Relatives of platform speakers
 - (2) Selected LEYTE GULF relatives and guests
 - (3) Operational commander/military officers of flag rank and their civilian equivalents
 - (4) Select SUPSHIP representatives and guests
 - (5) Select PMS-400 representatives and guests

Enclosure (5)

(6) Select contractor (ISD, RCA, MMC, Raytheon, etc.) representatives and guests

(7) Commanding officers of ships present

(8) Retired flag officers

(9) Select commissioning committee members

(10) Leyte Gulf battle veterans

b. Crew guest seating is defined as follows:

(1) LEYTE GULF family members

(2) LEYTE GULF crew guests

c. General guests will be seated in designated areas based on time of arrival

Enclosure (5)

SHIP VISITS/POST CEREMONY PLAN

1. Purpose. To provide a plan for conducting ship visits during LEYTE GULFS visit to Fort Lauderdale and to provide a tour plan for guests after the commissioning ceremony.
2. Responsibility. Ceremony and Honors Detail.
3. A ship visit plan will be developed by 30 June 1987.
4. Tour. Guests will be invited aboard for a brief tour after the commissioning ceremony. The after brows will be used for the ship visit. The forward brow is reserved exclusively for the official party, emergencies and for crewmen to depart the ship during the 15 minutes immediately following the ceremony.
 - a. The Ceremony and Honors Detail is in charge of tour assignments.
 - b. Two crewmen will be assigned at both ends of the after brows to assist guests. Tour guides will be stationed at appropriate spots on the tour path to describe items of interest and to keep visitors moving.
 - c. One after brow will be used for offgoing traffic; one will be used for oncoming traffic.
 - d. A comprehensive tour plan will be developed by 30 June 1987. The tour will include equipment displays, as appropriate, and will be coordinated by the appropriate department head.

Enclosure (6)

PRELIMINARY SCRIPT FOR COMMISSIONING

<u>EVENT</u>	<u>TIME</u>	<u>SPEAKER/COG</u>	<u>DESCRIPTION</u>
1	0530	CDO	Reveille, Clamp Down
2	0530-0630	SUPPO	Breakfast
3	0630	XO	Officers' Call, Time Check (Note: morning colors not held)
4	0645	Department Heads	Quarters
5	0700-0800	CDO	Titivate ship
6	0715	EMO	Final test of the public address system
7	0800	CDO	Ship's company shift into the uniform of the day: full-dress white (possibly with rain gear)
8	0830	Department Heads	Muster ushers, bus escorts, pier hosts
9	0830	CDO	Set the Special Commissioning Watch
10	0830	Transportation Officer	Bus trips from parking lot begin; weather decks secured
11	0830	Bandmaster	Band arrives on pier and takes place on the stand
12	0945	Transportation Officer	VIP party departs site TBD
13	1000	SUPSHIP	Officer party, with guests, assemble at site TBD
14	1000	Bandmaster	Commence band selections
15	1000	XO	Ship's company fall in at commissioning quarters and other locations, as directed
16	1015	Honor Guard Officer	Honor Guard muster on pier in position
17	1045	Transportation Officer	Boat arrives at ship/ceremonial area
18	1045	Head Usher	Upon arrival, the official party (less platform guests) is escorted to the appropriate seats (reserved by name); non-VIP ushers join crew formation at this time.

Enclosure (7)

<u>EVENT</u>	<u>TIME</u>	<u>SPEAKER/COG</u>	<u>DESCRIPTION</u>
19	1050	XO	<p>“WILL THE GUESTS PLEASE BE SEATED. (PAUSE) GOOD MORNING LADIES AND GENTLEMEN AND WELCOME TO THE COMMISSIONING OF THE WORLD’S MOST SOPHISTICATED CRUISER—LEYTE GULF. THE CEREMONY YOU ARE ABOUT TO WITNESS IS A TIME-HONORED TRADITION OF THE UNITED STATES NAVY THAT STARTED WITH THE COMMISSIONING OF THE FIRST SHIP—THE CAPTURED BRITISH SCHOONER, MARGARETTA, IN 1775. SINCE THAT DATE THOUSANDS OF SHIPS HAVE UNDERGONE THE MAGICAL TRANSITION FROM THE SILENT AND UNMANNED VESSEL YOU NOW SEE BEFORE YOU, TO A WARSHIP FULLY MANNED AND FULLY ALIVE. THE WORLD’S FINEST COMMISSIONING CREW—HEREAFTER KNOWN AS PLANKOWNERS—IS IN FORMATION AND READY.</p> <p>IN A FEW MINUTES OUR PRINCIPAL SPEAKER WILL ARRIVE AND THE CEREMONY WILL BEGIN. PLEASE BE AWARE THAT THE GUN SALUTE TO (TBD) WHEN HE DEPARTS THE SHIP IS VERY LOUD. I TELL YOU THIS IN ADVANCE SO YOU WILL NOT BE UNNECESSARILY STARTLED.</p> <p>AN INFORMATION BOOTH IS SET UP TO MY (LEFT OR RIGHT) ON THE PIER TO ANSWER ANY QUESTIONS AND PROVIDE A LOST AND FOUND SERVICE.</p> <p>UPON COMPLETION OF THE COMMISSIONING CEREMONY, YOU ARE INVITED TO TOUR THE SHIP BY CROSSING THE BROW LOCATED ON THE FANTAIL.</p> <p>A SPECIAL WORD OF THANKS TO (THE BAND AND ANY OTHER GROUPS TO MENTION).</p> <p>WE HOPE YOU ENJOY THE CEREMONY. THANK YOU FOR JOINING US AS WE BRING LEYTE GULF TO LIFE.</p>
	1050		<p>Boat bearing platform guests (less principal speaker party) arrive at the designated location and are greeted by the prospective commanding officer. Ushers will escort guests from the head of the brow to the weather break where they remain until they are announced. Chairs are provided for guests while waiting. Nonplatform guests will be escorted and seated in the first row of the VIP section.</p>
	1056	XO	<p>“LADIES AND GENTLEMEN, THE PLATFORM GUESTS”:</p> <p>Introduce platform guests. As introduced, guests walk from break to platform.</p>

Enclosure (7)

<u>EVENT</u>	<u>TIME</u>	<u>SPEAKER/COG</u>	<u>DESCRIPTION</u>
	1059:30	XO	As guest speaker approaches, "SHIP'S COMPANY, COME TO ATTENTION. WILL THE GUESTS PLEASE RISE. (PAUSE) LADIES AND GENTLEMEN, (announce the speaker)"
		Department Head	About faces. "SHIP'S COMPANY, ATTEN - HUT!"
		XO	"SHIP'S COMPANY, PRESENT ARMS!"
		Department Head	"SHIP'S COMPANY, PRESENT - ARMS!" Ship's company and honor guard presents arms. Formation heads salute. Men in ranks stand at attention.
	1100	XO	"SHIP'S COMPANY, ORDER ARMS!" "WILL THE GUESTS PLEASE REMAIN STANDING." Principal speaker inspects honor guard. Prospective commanding officer and principal speaker proceed to the platform.
		Department Head	"SHIP'S COMPANY, ORDER - ARMS!"
		XO	"LADIES AND GENTLEMEN, (The principal speaker)"
	1105	PCO	"LCDR ODEGAARD, PROCEED WITH THE COMMISSIONING CEREMONY."
		XO	"AYE AYE, SIR." (Salute PCO)
		CO	(Returns XO's salute)
		XO	"PARADE THE COLORS. SHIP'S COMPANY, PRESENT ARMS!"
		Department Head	"SHIP'S COMPANY, PRESENT - ARMS!"
		BAND	Play national anthem
		XO	"SHIP'S COMPANY, ORDER ARMS!"
		Department Head	"SHIP'S COMPANY, ORDER - ARMS!"
INVOCATION		XO	"(Chaplain) WILL OFFER THE INVOCATION"
PRAYER			" AMEN."

Enclosure (7)

<u>EVENT</u>	<u>TIME</u>	<u>SPEAKER/COG</u>	<u>DESCRIPTION</u>
	1110	XO	"WILL THE GUESTS PLEASE BE SEATED. SHIP'S COMPANY, PARADE REST!"
		Department Head	"SHIP'S COMPANY, PARADE - REST!"
		XO	"LADIES AND GENTLEMEN, MR. JERRY ST. PE', PRESIDENT, INGALLS SHIPBUILDING."
REMARKS		Mr. St. Pe'	"(REMARKS) THANK YOU."
		XO	"LADIES AND GENTLEMEN, THE _____" (Introduces speakers in ascending order of seniority.)
REMARKS			"(principal speaker remarks) THANK YOU." At the end of the principal speaker's remarks, VADM Rowden and CAPT Browne approach the podium.
	1130	XO	"VADM WILLIAM H. ROWDEN WILL NOW READ THE COMMISSIONING DIRECTIVE."
REMARKS	1130		(VADM ROWDEN): "I HEREBY PLACE UNITED STATES SHIP LEYTE GULF IN COMMISSION. GOD BLESS AND GOD SPEED."
	1130	CO	Salutes.
COLORS		CO	"LCDR ODEGAARD, HOIST THE COLORS AND BREAK THE COMMISSIONING PENNANT."
		XO	"AYE AYE, SIR!" (Salute CO)
		CO	(Returns XO's salute)
		XO	"BREAK THE COLORS. SHIP'S COMPANY, ATTEN-HUT! WILL THE GUESTS PLEASE RISE."
		Department Head	"SHIP'S COMPANY, ATTEN - HUT!"
		XO	"SHIP'S COMPANY, PRESENT ARMS!"
		Department Head	"SHIP' S COMPANY, PRESENT - ARMS!"
NATIONAL ANTHEM		Band	(The band plays the national anthem. Colors will be hoisted at the mast and the commissioning pennant will be broken. Formation heads salute. Honor guard present arms. Men in ranks stand at attention.)

Enclosure (7)

<u>EVENT TIME</u>	<u>SPEAKER/COG</u>	<u>DESCRIPTION</u>
1135	XO	"SHIP'S COMPANY, ORDER ARMS! WILL THE GUESTS PLEASE BE SEATED."
	Department Head	"SHIP'S COMPANY, ORDER - ARMS!"
	XO	"SHIP'S COMPANY, PARADE REST! CAPTAIN, THE COLORS HAVE BEEN BROKEN."
	Department Head	"SHIP'S COMPANY, PARADE - REST!"
1136	XO	"LADIES AND GENTLEMEN, CAPTAIN JETTE BROWN, COMMANDING OFFICER, UNITED STATES SHIP LEYTE GULF."
1136	CO	"I WILL NOW READ MY ORDERS." (CO reads orders.)
1137	CO	"LCDR ODEGAARD, SET THE WATCH."
	XO	"AYE AYE, SIR." (Salute CO)
	CO	(Return XO's salute)
	XO	"SHIP'S COMPANY, ATTEN-HUT!"
	Department Head	"SHIP' S COMPANY, ATTEN - HUT!"
	XO	"NAVIGATOR, SET THE WATCH."
	NAV	LT Lakins, with the watch team assembled on the pier, says "AYE AYE, SIR," and salutes the XO. He then marches the watch team aboard through the forward brow.
	XO	(Return navigator's salute)
SET THE WATCH	BMOW	Pipes the watch, says over the 1MC: "SET THE WATCH; ON DECK, SECTION I."
WATCH IS SET	NAV	LT Lakins marches to the platform through the 01 level, salutes XO and reports: "SIR, THE WATCH IS SET." XO returns salute, presents long glass, LT Lakins salutes (XO returns salute), and marches to position on forward break
1142	XO	(XO salutes CO) "CAPTAIN, THE WATCH IS SET." (Hold salute)
CREW TO QUARTERS	CO	(Return XOs salute and holds it) "VERY WELL, CALL THE CREW TO QUARTERS."

Enclosure (7)

<u>EVENT</u>	<u>TIME</u>	<u>SPEAKER/COG</u>	<u>DESCRIPTION</u>
		XO	"AYE AYE, SIR." (CO drops salute, XO does same)
		XO	"BANDMASTER, SOUND OFF. LEYTE GULF CREWMEN, MAN YOUR SHIP." (<u>Loud</u> response from crew: Aye Aye, Sir!)
		Department Head	"SHIP'S COMPANY, RIGHT AND LEFT FACE! DOUBLE TIME, MARCH!"
		Band	Strike up "Anchors Aweigh" on Department Head's order to march
MAN THE SHIP		ALL	The crew will double time in two single columns as specified in the rail manning procedures.
	1145		Band stops on cue from walkie-talkie when last man is in place.
TIME 0+		XO	"CAPTAIN, THE WATCH IS SET, THE SHIP IS MANNED AND THE CREW IS AT QUARTERS. REQUEST PERMISSION TO BRING LEYTE GULF TO LIFE!"
		CO	"BRING LEYTE GULF TO LIFE!"
		XO	"SHIP'S COMPANY, BRING LEYTE GULF TO LIFE!"
		CREW	"AYE AYE, SIR!"
		Designated Personnel	On sound of collision alarm: Activate sonar Train and elevate MT 51 AND 52 Fire torpedo tubes Rotate AN/SPS-55 Break signal flags Full dress ship Rotate all four directors Train and elevate port CIWS mount Release balloons Start GTM # _____ (aft) (Continue for 30 seconds)

Enclosure (7)

<u>E V E N T T I M E</u>	<u>S P E A K E R / C O G</u>	<u>D E S C R I P T I O N</u>
	Designated Personnel	Sound ship whistle for 10 seconds.
	Crew/ Designated Personnel	Upon completion of whistle signal, crew salutes and saluting battery fires.
	XO	"LADIES AND GENTLEMEN, THE SHIP IS ALIVE. THE GALLANT MEN OF THIS MAGNIFICENT WARSHIP SALUTE YOU."
	XO	"SHIP'S COMPANY READY. . . TO!"
	XO	"CAPTAIN, THE SHIP IS MANNED AND READY."
1150	CO	"ADMIRAL MCCAULEY, THE SHIP IS MANNED AND READY AND REPORTS FOR DUTY TO THE ATLANTIC FLEET. REQUEST PERMISSION TO BREAK (principal speaker's) FLAG." Admiral McCauley stands, returns salute and grants permission.
	CO	"LCDR ODEGAARD, BREAK (principal speaker's) FLAG."
	CO	"THERE ARE REFRESHMENTS AND SHIP'S MEMORABILIA AVAILABLE ON THE PIER. WELCOME ABOARD AMERICA'S FINEST WARSHIP; A WARSHIP 'ARRAYED FOR VICTORY"
	BMOW	After platform guests are clear, (pipe) "SECURE FROM QUARTERS." Crew dismissed to join family and friends. Crew, on command from local petty officer, will right/left face and double time inside the ship through the outboard side. Crewmen depart the after brow to meet their guests. Crewmen must return onboard through the after brows.
	BAND	Band selections
		Ushers direct official party guests to forward brow and remainder of guests to after brow.
	OOD	Eight side boys muster at the forward brow. Pipe VIP guests aboard.

Enclosure (7)

MANNING THE RAIL PROCEDURES

1. The crew will be divided into two basic groups: one main group at the back of the general seating area and one group dispersed throughout the ship to facilitate manning the rail and the coming alive ceremony. Only an absolute minimum number will remain on the ship.

2. The ceremonial quarterdeck watch will be in the front of the seating section, facing the guests, and will board the ship through the forward brow when the watch is set.

3. After the boatswain's mate pipes the crew to the rail, the following actions will take place:

a. The band will commence playing "Anchors Aweigh" upon the order to march.

b. Immediately, those on the left (facing the ship) of the main group will double time, by column, onto the ship through the center aisle and forward brow. The first man in the group will proceed down the side until he reaches the speaker's area with the others following until the rail is manned. At this time, the next man will proceed forward to the bullnose and those following will man the rail aft to the quarterdeck (FR 120). Those personnel whose stations are within the MT 51 danger circle will form a second rank behind those outside the aft of the danger circle only during the come alive evolution. The officers and chief petty officers in the group will man the rail forward and aft of the speaker's platform.

c. Simultaneously, the group to the right (facing the ship) will proceed down the center aisle and cross in front of the audience. The group will proceed down the pier, cross the after brow and man the after part of the ship. Those personnel whose station is within the MT 52 danger circle will form a second rank behind those outside and forward of the danger circle only during the come alive ceremony. As with the other group, the officers and chief petty officers will man the rail forward and aft of the speakers platform.

d. Some men may be hidden inside the ship to man the rails. The senior man of each group will ensure that the group double times into place in synchronization.

e. The honor guard will remain on the pier.

f. When manning the rail, each crewman will stop in his appropriate position, do a sharp left or right face, as appropriate, then do a normal interval dress right or left to the crewman next to him, doing a "ready to" once in position.

The above procedures will be adopted/modified as necessary after initial rehearsals to ensure a smart evolution.

Enclosure (8)

**PROPOSED COMMISSIONING PLAN OF ACTIONS AND
MILESTONES**

<u>TASK</u>	<u>COMPLETION DATE</u>
DEFINE SCOPE AND CONCEPT OF COMMISSIONING CEREMONY AND RELATED EVENTS	DEC 86
DETERMINE PIER SELECTION	DEC 86
PUBLISH COMMISSIONING NOTICE (IDENTIFY CREW RESPONSIBILITIES)	DEC 86
FORM COMMISSIONING PLANNING COMMITTEE	DEC 86
REQUEST WAIVER FOR MULTICOLOR PRINTING	DEC 86
DEFINE EVENTS TO OCCUR AS PART OF THE COMMISSIONING AND RELATED ACTIVITIES DURING THE DAY	JAN 87
COMMENCE CREW PHOTOS	MAY 87
SEND OFFICIAL LETTER INVITING PRINCIPAL SPEAKER	FEB 87
PREPARE PRELIMINARY COST ESTIMATES FOR COMMISSIONING CEREMONY, VARIOUS PARTIES/RECEPTIONS, GIFTS, COMMEMORATIVE ITEMS, ETC.	FEB 87
SECOND COMMISSIONING COMMITTEE MEETING	FEB 87
IDENTIFY PUBLIC RELATIONS OBJECTIVES	FEB 87
REVIEW/MONITOR SUPSHIP'S COMMISSIONING SUPPORT CONTRACT (NAVSEA FUNDING)	FEB 87
REQUEST BANDS	FEB 87
ARRANGE FOR SALUTING BATTERY AND LOADS	FEB 87
SELECT RECEPTION SITES	FEB 87
REQUEST HONOR GUARD	FEB 87
DEFINE HOTEL/QUARTERS AVAILABLE IN FORT LAUDERDALE	FEB 87
THIRD COMMISSIONING COMMITTEE MEETING	MAR 87
DEVELOP INITIAL COMMISSIONING BOOKLET	MAR 87
REQUEST CONGRATULATORY LETTERS	APR 87

Enclosure (9)

<u>TASK</u>	<u>COMPLETION DATE</u>
DEVELOP FIRST INVITATION LIST	APR 87
DEFINE SEATING REQUIREMENTS	APR 87
FOURTH COMMISSIONING COMMITTEE MEETING	APR 87
ORDER VIP PHOTOS	APR 87
CONFIRM PRINCIPAL SPEAKER	APR 87
FIFTH COMMISSIONING COMMITTEE MEETING	MAY 87
SUBMIT FIRST RUN OF INVITATION LIST FOR REVIEW	MAY 87
DETERMINE CEREMONY EQUIPMENT REQUIREMENTS	MAY 87
ORDER INVITATIONS FROM NAVY	MAY 87
SIXTH COMMISSIONING COMMITTEE MEETING	JUN 87
INVITATIONS TO THE PRINTER FOR PRINTING	JUN 87
COMMISSIONING BOOKLET TO PRINTER	JUN 87
SEVENTH COMMISSIONING COMMITTEE MEETING	JUL 87
ESTABLISH RSVP TRACKING SYSTEM	JUL 87
FINAL INVITATION LIST TO THE COMPUTER FOR TYPING	JUL 87
SHIP'S CUSTODY TRANSFER	20 JUL 87
INVITATIONS MAILED	31 JUL 87
EIGHTH COMMISSIONING COMMITTEE MEETING	AUG 87
SHIP TRANSITS TO FORT LAUDERDALE	29 AUG 87
COMMISSION LEYTE GULF (CG 55)	5 SEP 87

Enclosure (9)

APPENDIX VI

DECOMMISSIONING PLAN

USS LEXINGTON (AVT 16) NOTICE 5060

Subj: PUBLIC AFFAIRS PLAN FOR DECOMMISSIONING OF
USS LEXINGTON (AVT 16)

Ref: (a) SECNAVINST 5720.44A (*U.S. Navy Public Affairs Regulations*)

Encl: (1) Command Information Bureau (CIB) Plan
(2) Press Kit Enclosures
(3) Media Credentials/Badges
(4) Media Badge Request
(5) Media Events Plan
(6) Proposed Initial News Release
(7) Media Advisory

1. Purpose. To establish the public affairs objectives for the decommissioning of USS LEXINGTON (AVT 16) and to ensure complete internal and external media coverage.

2. Public Affairs Objectives. Public affairs efforts and plan outlines in enclosure (1) will be in support of the following objectives:

a. To publicize LEXINGTON's decommissioning and promote understanding of LEXINGTON's contribution and role in naval seapower throughout its 49 year history.

b. To solicit interest in the decommissioning and respond to requests for information and services from the media, Congress, Navy internal and external audiences and the American public.

c. To support distinguished guests through liaison with dignitary staffs and documentation of guest participation in the decommissioning events.

d. To communicate at every opportunity the following themes:

(1) The LEXINGTON Contribution. In its 49 years of distinguished service, LEXINGTON has made numerous deployments and saw action in World War II. It destroyed more than a thousand enemy planes, sunk 300,000 tons of Japanese shipping and damaged another 600,000 tons. Despite repeated Japanese claims of its destruction, LEXINGTON continued to fight and was nicknamed "The Blue Ghost," the ship that could not be sunk. LEXINGTON was present for the Cuban Missile Crisis in late October 1962 before it was ordered to Pensacola, Florida, to become the Navy's training carrier for student naval aviators. As the nation's only training carrier, it has trained an average of 1,500 naval aviators per year. In February of 1991, LEXINGTON recorded her 493,248th arrested landing—a world record.

(2) LEXINGTON's decommissioning is a matter of budgetary considerations and operational ability. Throughout its career, LEXINGTON met or exceeded all operational commitments.

3. Background. USS LEXINGTON (AVT 16) will be decommissioned at 1000 on Friday, 8 November 1991, at the Pensacola Naval Air Station's Allegheny Pier in Pensacola, Florida. Other background information:

a. Speakers. Admiral Frank B. Kelso II Chief of Naval Operations, will be the principal speaker.

b. Decommissioning events.

(1) Thursday, 7 November 1991. Reception with past LEXINGTON commanding officers. Media availability with the commanding officer, executive officer, command master chief and crew members and tours (ENG opportunity) of hangar bay, flight deck and navigation bridge for media.

(2) Friday, 8 November 1991. Decommissioning ceremony at 1000, Allegheny Pier, Pensacola Naval Air Station. Media availability with the commanding officer, executive officer, command master chief and crew members.

4. Command and Coordination. The public affairs officer (PAO) for USS LEXINGTON is responsible for the overall coordination of decommissioning public affairs. Enclosures (1) through (7) contain the proposed Command Information Bureau (CIB) plan of action, media support and coordinating procedures, proposed press releases and media advisory. USS LEXINGTON public affairs will coordinate the preparation and dissemination of decommissioning

information to interested media. LEXINGTON will establish a decommissioning CIB at the NAS Pensacola Public Affairs Office, from Monday, 4 November through Saturday, 9 November. The LEXINGTON PAO will request the following support:

a. USS LEXINGTON (AVT 16):

(1) Request coordination of regional public affairs activities through the Navy Offices of Information (NAVINFOs) and the NAS Pensacola Public Affairs Office.

(2) Arrange Navywide coverage of decommissioning through assignment of Navy internal assets (Navy News This Week *All Hands*, etc.).

(3) Request CHINFO assistance with release of decommissioning information to national media.

(4) Develop contingency questions/answers for use during media availability.

(5) Prepare 30 press kits.

(6) Arrange for a reserved section with a raised platform for media to cover all decommissioning activities during the ceremony. Media will be allowed to leave the reserved section in a pool, under escort, to obtain shots during the ceremony on a not-to-interfere basis. A media availability will be arranged with Captain Kennedy, the command master chief and crew members immediately following the ceremony.

(7) Coordinate with CNET public affairs to assign a host command, if available and/or feasible, to provide public affairs assistance and to assign media escorts during all decommissioning events.

(8) Coordinate with the Office of the CNO to obtain copies of the speech for distribution to the media (if available).

(9) Arrange for 20 reserved parking spaces adjacent to the head of the pier for the media.

(10) Arrange for photographic support (still and video) services by NETPMSA.

(11) Arrange for Navy Band, New Orleans, to perform at the decommissioning ceremony.

b. Naval Education and Training Program Management Support Activity, Pensacola. To provide video and still photographic coverage (black and white, color) of the decommissioning ceremony for documentary and public affairs purposes.

c. Naval Air Station, Pensacola.

(1) Provide host command to assist in photographs, administrative and medical support of LEXINGTON's decommissioning ceremony.

(2) Request Commanding Officer, NAS Pensacola, arrange access to the naval base for the media during CIB operations, and for invited guests.

R. R. PENFOLD

Distribution:

LEXINGTON Department Heads

CNET

CO, NAS Pensacola

CO, PWC Pensacola

COMMAND INFORMATION BUREAU (CIB) PLAN

1. Background. The decommissioning Command Information Bureau (CIB) will be located at the NAS Pensacola Public Affairs Office. The CIB will have long distance telephone lines, one fax machine and a copy machine. The CIB will be activated on or about 0800, Monday, 4 November 1991. The CIB will close on approximately 1200, Saturday, 9 November 1991. No filing center has been established for the media, although on a case-by-case basis, reporters may use CIB telephones.

2. Responsibilities.

a. OIC. CIB. As the OIC, the LEXINGTON PAO will establish and coordinate public affairs policy, consistent with this plan and directives of higher authority.

b. Assistant OIC. CIB/Media Officer. The assistant OIC is JO1(SW) Gentry. His duties will include the coordination of media requests and events involved with the decommissioning ceremony.

c. Other responsibilities. Other duties of the CIB will be accomplished at the discretion of the OIC and assistant OIC, and will include the following: credentialing of media, coordination with electronic, print and still media, escorting media and video documentation by internal media.

3. Procedures.

a. Seating. Twenty chairs will be reserved near the media platform for members of the print media.

b. Coverage Areas.

(1) An elevated press platform will be located on Allegheny Pier. The platform will contain 100-amp electrical outlets for television camera use, a sound feed and a multi-box.

(2) Media will not be allowed to roam throughout guest seating, but a small roving pool (under escort) may be established to allow maximum coverage with minimum disturbance of the ceremony. Media will be allowed to move behind guest seating.

Enclosure (1)

(3) If sufficient interest exists, a radio coverage area near the main press platform will be established in support of radio coverage. It will have the capability to allow audio taping for the proceedings.

c. Camera Positions. No media will be allowed to secure camera positions on the press platform before 8 November when camera locations will be on a first-come, first-served basis beginning at approximately 0800.

d. Transportation. Except for satellite and microwave trucks, news media representatives will not be allowed to park on Allegheny Pier. Media will be greeted at the main gate entrance to NAS Pensacola. Media will not be able to enter NAS without an escort. Satellite and microwave trucks will be allowed to set up at the head of Allegheny Pier.

4. Services for the Media.

a. Media Kits. To provide members of the media with key background information.

b. Equipment and Supplies. NAS Pensacola public affairs office will provide a copying and fax machine to the CIB as well as needed administrative supplies supplemented by USS LEXINGTON supplies. USS LEXINGTON will provide media badges and media escort badges.

c. Transportation. The CIB will have available one 15-passenger van on 7 and 8 November.

d. Stock Photography and Video. The CIB will have stock still photography and video of LEXINGTON under way conducting flight operations (in color and black and white).

e. CIB Telephone Numbers. The CIB telephone numbers are (904) 452-2311 and fax 452-2760.

Enclosure (1)

PRESS KIT ENCLOSURES

1. The following will be included in the press kits:
 - a. Decommissioning press release
 - b. CO's biography
 - c. XO's biography
 - d. C/MC's biography
 - e. Line art of the ship's seal
 - f. Welcome Aboard booklet
 - g. Color and black-and-white photos of LEXINGTON under way
 - h. Biographies of all platform speakers and their speeches (if available)
 - i. Decommissioning program

2. In addition, the following information sheets and photos will be available in the CIB:
 - a. CINCLANTFLT fact sheet
 - b. CNET fact sheet
 - c. COMNAVAIRLANT fact sheet
 - d. Thirty 5 by 7 color photos of CO, 15 black-and-white
 - e. Thirty 5 by 7 color photos of XO, 15 black-and-white
 - f. Thirty 5 by 7 color photos of C/MC, 15 black-and-white
 - g. Videotape in Beta and VHS formats available for dubbing

Enclosure (2)

MEDIA CREDENTIALS/BADGES

1. All media will be issued credentials (which they must wear during official events) upon reporting to the CIB.
2. The CIB will issue vehicle passes for satellite and microwave vehicles and provide escort services to the pier area.
3. All persons requesting credentials and/or vehicle passes must fill out enclosure (4).
4. To obtain credentials, news media representatives must present at least one form of picture identification, preferably a press pass showing media affiliation. Any questions should be referred to the CIB OIC or assistant OIC.
5. CIB personnel will keep an accurate list of all news media representatives and media escort officers.

Enclosure (3)

MEDIA BADGE REQUEST

Name: _____
(Last) (First) (MI)

AFFILIATION: _____
(COMPANY NAME)

COMPANY ADDRESS: _____

(CITY) (STATE) (ZIP)

BUSINESS PHONE: _____

SPECIAL REQUESTS: _____

Enclosure (4)

MEDIA EVENTS PLAN

1. Purpose. This plan outlines opportunities offered to the media concerning the decommissioning.
2. Responsibilities. The CIB OIC (LEXINGTON PAO) and assistant OIC will coordinate media requests and transportation, including the following:
 - a. Security. Arranging access to NAS through the NAS Pensacola PAO.
 - b. Media Availability. The commanding officer will host a media availability, including one-on-one interviews immediately following the decommissioning ceremony, along with the command master chief and various crew members.
 - c. Tour. Media representatives will be offered a tour of the flight deck, hangar bay and various spaces on the ship, if available, for ENG opportunities on Thursday, 7 November only.
 - d. Escorts. All media groups will be escorted and assisted by CIB personnel.
 - e. Schedule. On the day of the decommissioning ceremony, members of the media will meet escort officers at the NAS Pensacola main gate parking lot area. Media will be credentialed and escorted to LEXINGTON to arrive and setup by 0915.
 - f. Seating. Twenty chairs will be roped off near the press platform (provided by PWC Pensacola) to provide sound for cameramen and radio media.
 - g. Press Platform. A multi-box will be available on the platform (provided by PWC Pensacola) to provide sound for cameramen and radio media.
 - h. Communications. Cellular telephones and hand-held radios will be available to media escorts.
 - i. Photo Documentation Plan. A photo documentation plan for the ceremony will be developed the week before decommissioning. Photographers will document all aspects of the ceremony in black and white, and color film and videotape-in particular, the speakers, awards presented, hauling down of the ship's commissioning pennant, aircraft flyover and group photo of decommissioning participants on the ceremony platform. Photos will be used for documentation and news releases.
 - j. Statement and Questions/Answers. The initial public affairs statement is included as enclosure (6) of this notice. Follow-on releases and contingency questions/answers will be developed by the assistant CIB OIC as required.

Enclosure (5)

PROPOSED INITIAL NEWS RELEASE

The USS LEXINGTON PAO will release the following memorandum for correspondents and media advisory on 20 September 1991, approximately six weeks before LEXINGTON's decommissioning, and to CHINFO for possible release in Washington, D.C.

PENSACOLA, Fla. — Thousands of guests and former crew members are expected to attend the decommissioning ceremony for the aircraft carrier USS LEXINGTON (AVT 16), which will be decommissioned at 10 a.m. Friday, November 8, 1991 at Allegheny Pier at the Pensacola Naval Air Station, Pensacola, Fla. The Chief of Naval Operations, Adm. Frank B. Kelso II, will be the principal speaker. The ship's commanding officer is Captain William H. Kennedy.

LEXINGTON was built at the Fore River Shipyard in Quincy, Massachusetts, and began its commissioned service on February 17, 1943. The ship was named after its predecessor, USS LEXINGTON (CV 2), which was sunk on May 8, 1942, at the Battle of Coral Sea.

LEXINGTON is a World War II veteran. During its many wartime exploits, it destroyed more than a thousand enemy planes, sunk 300,000 tons of Japanese shipping and damaged another 600,000 tons. Despite repeated claims of its destruction, LEXINGTON continued to fight and was nicknamed "The Blue Ghost," the ship that could not be sunk.

LEXINGTON is the oldest aircraft carrier in the U.S. Navy and the only active carrier of the Essex class. Its engineering plant is powerful enough to provide utility services for a small city. The ship's engines develop 150,000 horsepower feeding turbo and diesel generators producing 7,000 kilowatts of electrical power. The ship's boilers supply steam for the main engines, turbo generators, steam catapults and many other systems. Nearly 180,000 gallons of fresh and feed water for the boilers are produced daily by the evaporators. The size of LEXINGTON's food service facilities, laundry, barber shop, snack bar and retail stores are equal to the facilities of several major hotels. In 1979, women joined the crew and worked side by side with men, from the flight deck to the engineering spaces.

Because of seating restrictions at the decommissioning ceremony, attendance at the ceremony is by invitation only. Media representatives wishing to attend the ceremony should contact Lt. Maureen Ford at (904) 452-2401.

Enclosure (6)

MEDIA ADVISORY

Command Information Bureau

A decommissioning Command Information Bureau (CIB) will be established at the NAS Pensacola Public Affairs Office from November 4 – 8, 1991. Lt. Maureen Ford is the USS LEXINGTON (AVT 16) Public Affairs Officer and is the CIB director. Telephone numbers for the CIB are (904) 452-2311/2. The automatic telefax line is (904) 452-2760 (all day) or 452-2514 (after 4 p.m. only).

Tours

If there is enough interest, a media tour will be available on Thursday, November 7. The tour will include the flight deck hangar bay and bridge. Requests for tours earlier in the week will be handled on a case-by-case basis. No tours will be provided on Friday and Saturday, November 8 and 9. The ship will not be open to the general public.

Decommissioning Ceremony — Friday, 8 November 1991

News media representatives will be escorted to the USS LEXINGTON from the main gate parking lot at NAS Pensacola for coverage of the decommissioning ceremony. The ceremony will begin promptly at 10 a.m. Media will be escorted from the main gate as early as 0800 to set up pier side by 0915. The commanding officer, executive officer, command master chief and various crew members will be available following the ceremony for a media availability and interviews.

Satellite/Microwave Truck Parking

On November 8, only microwave and satellite trucks will be allowed to park near the pier. No media vehicles will be allowed to park on the pier. Television affiliates should bring about 1,000 feet of cable to connect between the media stand and the satellite/microwave truck parking area.

Camera Locations

A platform will be provided directly across from the ceremony site for photographers and cameramen. Photographers will be allowed to roam in back of the crowds on the pier. If sufficient interest exists, a small pool will be allowed to go in front of the audience under escort.

Special Request/Ceremony Speakers

Attempts will be made following the ceremony to allow interested media representatives to speak with selected ceremony participants. Anyone interested in speaking with a particular ceremony participant should make those desires known to Lt. Ford as soon as possible.

Enclosure (7)

APPENDIX VII

SPECIAL EVENTS CHECKLIST

OVERALL

- Suitable event
- Complies with regulations
- Cleared with higher headquarters
- Chairman appointed
- Committee assignments explicit and inclusive

DATE, TIME AND LOCATION

Date

- Date set far enough ahead?
- Date most suitable for community and installation?
- No conflict with other local events?
- Important guests available?
- Possible tie-in with historical event?

Time

- Time set for beginning and end of event
- All activities time-sequenced

Location

- Location selected for exhibits on installation and in town
- Few restricted areas
- Location well policed
- Size and accessibility appropriate
- Inclement weather

PUBLICITY

Press

- Personal invitations issued
- Special invitations to publishers and editors in addition to reporters
- "Teaser" releases for advance distribution
- Release dates determined
- Number of reporters attending determined
- Press center facilities prepared, including:
 - Typewriters
 - Paper, carbon paper and envelopes
 - Pencils, pencil sharpener and ink
 - Tables
 - Telephones and telephone books
 - Wastebaskets
 - Chairs
 - Dictionaries
 - Clothes
 - Maps
 - Clock
 - Weather map (if appropriate)
 - Name cards for reporter's desks, if appropriate
 - Blackboard
 - Telephone facilities
 - Water cooler and paper cups
 - Coffee urn and cups
 - Good lighting and extra bulbs
 - Adequate heating or cooling
 - Restrooms nearby
 - Electrical outlets
 - Extension cords
- Personnel to clean press center
- Personnel to assist reporters and photographers
- Schedule of meals and location of eating places prepared
- Communications advised: need for adequate telegraph facilities
- Special media box to observe feature events
- Transportation for correspondents
- Convenient parking spaces for media and equipment
- Passes and identification tags
- Material/personnel for news briefings
- Invitations to commander to attend news briefing
- Programs/itinerary to media before the day of event
- Additional programs and press kits available for distribution on arrival of reporters

Photography

- News photographers consulted to determine special needs
- Laboratory facilities available for visiting photographers
- Security escorts for photographers
- Special transportation for photographers and equipment
- Special briefing on pictorial possibilities for photographers
- Official photographers briefed and official coverage planned
- Requirements (to photo lab) for printing and developing official photographs
- Distribution list for official photographs

Radio and Television

- Requirements of stations
- Coverage desired
- Times for airing and/or recording
- Clearance for national broadcasts
- Radio-television booth prepared, plus:
 - Background interference minimized
 - Wiring checked by communications officer
 - Sufficient power outlets provided
 - Replacement parts for equipment on hand
 - Special room selected for broadcasting when crowd noise is undesirable
- Tape recorder and tapes available
- Command technicians assigned as assistants
- Advance radio-television announcements coordinated with news releases
- Spot announcements distributed to stations
- Radio-television editors of local newspapers informed of special broadcasts
- Arrangements made for:
 - On-the-spot broadcasts of main attractions
 - Interviews with VIPs
 - Working special event into some network show
- Filler material available
- Information briefing in radio-television room planned
- Announcer asked to check facilities beforehand
- Announcer briefed on procedure in event of accident
- Completed scripts approved
- Arrangements made for pool, if space so requires
- Broadcast media informed of band selections for clearance purposes

Advertising and Promotion

- Sufficient funds allocated for advertising purposes
- Announcements prepared for distribution to civic and fraternal groups
- Cooperation of local merchants enlisted, including:
 - Space for window advertisements
 - Placement of paid advertisements in newspapers
- Congratulatory messages obtained from manufacturers or interested civic organizations
- Editors of appropriate trade and business journals contacted
- Special devices prepared, including:
 - Posters and placards
 - Leaflets to be dropped by aircraft, if practicable
 - Banners for main streets
 - Car bumper signs
 - Decals
- Hotel lobby exhibits and window displays prepared
- Television advertising footage prepared
- Material prepared for continuous promotion in station newspaper and daily bulletins prior to and during event
- Thank you letters prepared for mailing to all who assisted

VIPs AND GUESTS

- Prospective guest list prepared well in advance, including the following as potentials:
 - Governor of state
 - Mayor of community
 - President of Chamber of Commerce, heads of other civic organizations, e.g., American Legion, VFW, service clubs (Rotary, Kiwanis, Lions)
 - Heads of fraternal organizations (Elks, Moose, Eagles)
 - Heads of women's organizations
 - Heads of other organizations, as appropriate to occasion
 - Executives of local newspapers and radio stations
 - Labor union officials
 - Leading industrialists and professional personnel, as appropriate to the occasion
 - Military officials
 - Distinguished retired or inactive military personnel

- Guest list checked with commander
- Invitations to guests mailed well in advance of event
- List of acceptances and regrets prepared
- Special boxes for viewing event planned
- Transportation arranged
- Messing and billeting facilities arranged
- Welcoming committee and escorts selected and briefed
- Plans made to have commander meet distinguished guests after arrival
- Material prepared for briefing of distinguished guests
- Advance publicity on distinguished guests prepared for distribution to local media
- Arrangements made for media interviews of distinguished guests
- Special refreshment facilities prepared for distinguished guests
- Inform visitors coming from a distance of probable weather, suitable dress

PROGRAM

Speeches

- Time available for speeches determined
- List of speakers prepared
- Length of individual speeches determined
- Proposed speakers contacted and briefed on event
- Alternate speakers selected
- Advance copies of speeches procured and checked for length and appropriateness to occasion
- Sufficient copies of each speech prepared to meet all needs, including:
 - Advance copies for distribution to news media
 - Copies for master of ceremony
 - Copies for other speakers to prevent duplication
- Appropriate persons selected to introduce speakers
- Arrangements made for broadcasting of speeches, if appropriate
- Speaker's stand erected, after consideration of the following:
 - Location adjacent to main attractions of event
 - Sufficient room provided for speakers and honored guests
 - Location does not force audience to stare into sun
- Arrangements made for installation of microphones and loudspeaker system
- Loudspeaker repairman provided
- Decoration of platform completed
- Special refreshment facilities prepared for VIPs

Parade or Review

- Number of participating units determined and individuals informed, including the following, as appropriate:
 - Heads of military units
 - Commanders of veteran's organizations
 - Chamber of Commerce (floats, etc.)
 - Schools (bands and drill teams)
 - Community organizations, such as Boy Scouts, Civil Air Patrol, Civil Defense, Fire Department

- Parade marshal selected
- Route selected and checked with city authorities, if necessary
- Appropriate assembly and dispersal points selected
- Location of reviewing stand determined
- Cooperation of local police obtained, if appropriate
- Arrangements made for medical team to be stationed along parade route
- Order of units in parade determined
- Schedule of parade prepared, including times for assembly and dispersal points selected

- Location of reviewing stand determined
- Cooperation of local police obtained, if appropriate
- Arrangements made for armed forces police to be posted at intersections and turns
- Arrangements made for medical team to be stationed along parade route
- Order of units in parade determined
- Schedule for parade prepared, including times for assembly, commencement and passing reviewing stand
- Determination made as to uniforms to be worn
- Officers familiar with marching ceremonies selected
- Practice schedule prepared
- Reviewing stand prepared, including:
 - Public address system
 - Decorations
 - Chairs

- Parade announcer selected and briefed
- Award ceremonies planned, as appropriate, including:
 - Selection of appropriate individuals to make awards
 - Special attention to families of recipients of awards

- Seniority of VIPs determined
- Area roped off
- Loudspeaker repairman on hand
- Grandstand or area for public to stand in

Band

- Availability of band determined
- Leader fully briefed
- Schedule prepared
- Music selected
- Uniforms determined
- Arrangements made for necessary props, such as music stands and lights
- Arrangements made for public address system, if necessary
- Transportation for members and instruments arranged
- Regulations on use of bands checked

Aircraft Participation

- Type of air show determined
- Determination made that minimum field requirements have been met and appropriate facilities are available, including:
 - Types of aviation fuel, oil, jet starters, oxygen
 - Refueling methods
 - Arresting gear/jet barriers
 - Weight-bearing capacity for single/dual wheel aircraft
- Agreement obtained from sponsor to cover TAD costs of armed forces participants and public liability and property damage insurance, if required.
- Permission obtained from appropriate authority
- Federal Aviation Administration waiver (if required) requested and approved
- Nonparticipating, qualified pilot designated as military controller of the event to ensure that all flight and safety regulations of the Service and Federal Aviation Administration are observed
- Aviation operations officer consulted concerning:
 - Program
 - Types and sources of aircraft to be used
 - Maneuvers to be performed and facilities for viewing by crowd, VIPs, media, etc.

- For static display aircraft:
 - Arrangements made with Services and major commands
 - Arrangements with flight crew to stand by aircraft
 - Special ramp provided for closeup inspection
 - Appropriate sign made, describing unclassified aircraft performance figures and missions
- Television and radio personal appearances of air show participants arranged
- Media interviews arranged
- Media flights requested from appropriate higher authority
- Media liaison booth setup to facilitate and coordinate information queries at the event
- Public address system arranged, with tie-into in-flight broadcast
- Separate telephone line available from control tower to contact near master of ceremonies

ENTERTAINMENT

- Funds available determined
- Type of entertainment determined
- Space selected and reserved
- Special services officer consulted
- For theatrical show, preparations completed, including:
 - Program determined
 - Master of ceremony and announcers selected
 - Passes for guests and/or entertainers prepared
 - Ticket arrangements made, if appropriate
 - Lighting facilities and acoustics checked
 - Seating arrangements made
 - Ushers selected and briefed
 - Signs installed for entrances, exits, restrooms, if appropriate
 - Public address system prepared
- If stage show:
 - Talent obtained (local and/or outside)
 - Facilities for entertainers arranged (transportation, messing and billeting)
 - Possibility of local broadcast checked

- If motion or still picture show:
 - Suitable films and/or slides selected
 - Projectors, screen and projectionists obtained
 - If silent films or slides, narrator obtained
 - Supplementary fact sheets or press kits prepared for use with special service films

- For reception, cocktail party, luncheon or dinner, preparations completed including:
 - Guest list prepared and approved
 - Invitations issued
 - Participants briefed on distinguished guests
 - Adequate food and beverages assured
 - Waiters provided
 - Seating arrangement determined, if appropriate
 - Entertainers and music obtained, if appropriate

Final Arrangements

- Schedule distributed to all interested and participating offices and units
- Dress rehearsal held sufficiently in advance, if appropriate
- News media invited to witness rehearsal, if practicable
- Measures taken to correct errors noted during rehearsal
- Printed programs and maps prepared for distribution to visitors at gate and/or parking lots, if appropriate

SUPPORTING SERVICES

Billeting and Messing

- Billeting and messing officers fully briefed on requirements
- Billeting and messing provisions included in advance information given to VIPs and news media
- Hotel reservations, if necessary, made well in advance
- Clothes pressing and shoe shine services provided, if appropriate
- Special food considerations (religious requirements)
- Preparations made for extra, unexpected guest

Transportation

- Transportation officers fully briefed as to requirements
- Capable drivers properly briefed and dressed
- Cars assigned to visitors clearly marked for identification
- Commercial train, bus and airline schedules available
- Military transportation schedules available
- Special buses provided for school children and other organized groups, where appropriate
- Information on transportation routes to station provided in releases to news media
- VIPs and special visitors assisted in obtaining return reservations
- Standby vehicles available to handle emergency transportation problems
- Commercial transportation agencies advised of need for extra facilities on day of event, if appropriate

Traffic and Parking

- Coordination with engineer/public works, city and state police, and station security detachment
- Routes well marked and arrangements made for direction of traffic
- Signs installed for direction of visitors to parking areas
- Adequate parking areas located conveniently as possible
- Area oiled to settle dust, and lanes marked to ensure uniform parking
- Special parking areas set aside for VIPs and the news media
- Telephone connections installed between parking lot and press center, major exhibits, PA system control point, etc.
- Parking area illuminated for nighttime use, if necessary
- Parking provisions included in information distributed to news media
- No Parking signs erected, where necessary

Public Works/Engineers

- Engineer officer briefed on requirements
- Station entrances checked for appearance
- Engineer officer consulted in regard to:
 - Special construction requirements
 - Electrical outlets for special equipment
 - Plumbing facilities for exhibits, where necessary
 - Restroom facilities for crowd
 - Adequate number of waste containers
 - Installation of additional power lines and radio cables, if necessary
 - Maintenance and repair requirements during event
 - Teardowns at end of event
 - Wrecker to standby for auto accidents
 - Signs

Fire and Safety

- Fire chief fully briefed as to scope of event
- Adequate fire alarms and boxes in working order and easily identified
- Platforms and bleachers constructed sturdily
- Proper precautions taken in case of special demonstrations, such as chemical
- Ground rules and safety precaution signs checked for location and appearance
- Local police (and state police if necessary) fully informed

Medical

- Senior medical officer informed of scope of event
- First aid tents erected for large crowds
- Senior medical officer consulted for precautions necessary if hospital is opened to visitors' inspection

Refreshment Stands and Concessions

- Decision made as to handling of refreshment stands and concessions
- Mobile canteens considered, if appropriate
- Location of stands and concessions determined
- List of items to be sold and price list checked
- Waste receptacles placed convenient to stands and concessions

POSTPONEMENT OR CANCELLATION PLAN

- Alternate date selected if event can be postponed
- Plans made for postponement or cancellation, including:
 - Notification of all VIPs and other participants
 - Arrangements with news media to inform public
 - Signs for posting at gate and other prominent spots
- Appropriate individual designated to make decision for postponement or cancellation
- Deadline set beyond which postponement or cancellation impracticable except in extreme emergency
- If weather interferes, substitutes for outdoor program prepared, such as videotapes, talks and indoor demonstrations

MISCELLANEOUS

- Appropriate individual selected and fully briefed to take over in event project officer unavailable
- Final review prepared after event, including:
 - Summary of media reaction
 - Comments by distinguished guests
 - Particularly successful ideas and/or devices worth repeating
 - Pitfalls and recommended corrections

APPENDIX VIII

REFERENCES USED TO DEVELOP THE TRAMAN

Chapter 1

Classification of Naval Ships and Craft, SECNAVINST 5030.1K, Office of the Secretary of the Navy, Washington, D.C., February 1986.

Cutlip, Scott M., Allen H. Center, and Glen M. Broom, *Effective Public Relations* (Sixth Edition), Prentice-Hall, Inc., Englewood Cliffs, N.J., 1985.

Data Processing Technician Second Class, NAVEDTRA 12511, Chapter 6, "Microcomputers," Naval Education and Training Program Management Support Activity, Pensacola, Fla., July 1991.

Department of the Navy Correspondence Manual, SECNAVINST 5216.5C, Office of the Secretary of the Navy, Washington, D.C., August 1983.

Embarkation in U.S. Naval Ships, OPNAVINST 5720.2L, Office of the Chief of Naval Operations, Washington, D.C., June 1989.

General Instruction for Inactive Ships and Craft, OPNAVINST 4770.5F, Office of the Chief of Naval Operations, Washington, D.C., May 1991.

Naval Telecommunications Procedures, Telecommunications Users Manual, NTP3(H), Commander, Naval Computer and Telecommunications Command, Washington, D.C., January 1990.

Navy Public Affairs Policy and Regulations, SECNAVINST 5720.44A, Chapter 4, "Community Relations," Office of the Secretary of the Navy, Washington, D.C., June 1987.

Pearson, Olen R., *Personal Computer Buying Guide*, Consumer Reports Books, Consumers Union, Yonkers, N.Y., 1990.

Printed Matter for Official Ceremonies, SECNAVINST 5603.2C, Office of the Secretary of the Navy, Washington, D.C., May 1986.

Special Incident Reporting, OPNAVINST 3100.6F, Office of the Chief of Naval Operations, Washington, D.C., July 1991.

Yeoman 3, NAVEDTRA 10298, Chapter 2, "The Office," Chapter 3, "Files and Records," Chapter 5,

"Preparation of Correspondence," Naval Education and Training Program Management Support Activity, Pensacola, Fla., February 1990.

Chapter 2

Navy Military Funerals, NAVPERS 15555B, Naval Military Personnel Command, Washington, D.C., 1986.

Navy Public Affairs Policy and Regulations, SECNAVINST 5720.44A, Chapter 8, "Contingencies," Office of the Secretary of the Navy, Washington, D.C., June 1987.

Nuclear Accident and Incident Public Affairs Guidance, Department of Defense Directive 5230.16D, Department of Defense, Washington, D.C., February 1983.

Religious Program Specialist 3 & 2, Module I, NAVEDTRA 287-01-45-82, Chapter 4, "Naval Funerals and Chapel Weddings," Naval Education and Training Program Development Center, Pensacola, Fla., 1982.

Senior Public Affairs, Subcourse DI0500 (Edition A), U.S. Army Public Affairs Proponent Activity, Fort Benjamin Harrison, Ind., September 1990.

The Navy Casualty Assistance Calls Program (CACP), NAVMILPERSCOMINST 1770.1, Naval Military Personnel Command, Washington, D.C., November 1982.

Chapter 3

Establish and Supervise a Field Media Center, TEC Lesson 570-214-1092-A, Office of the Chief of Public Affairs, Department of the Army, Washington, D.C., September 1988.

Navy Public Affairs Policy and Regulations, SECNAVINST 5720.44A, Chapter 3, "Public Information," Office of the Secretary of the Navy, Washington, D.C., June 1987.

Chapter 4

Budd, Richard W., and Brent D. Ruben, *Beyond Media: New Approaches To Mass Communication*, Transaction Publishers, Rutgers—The State University, New Brunswick, N.J., 1991.

Cutlip, Scott M., Allen H. Center, and Glen M. Broom, *Effective Public Relations* (Sixth Edition), Prentice-Hall, Inc., Englewood Cliffs, N.J., 1985.

Navy Public Affairs Policy and Regulations, SECNAVINST 5720.44A, Chapter 3, "Public Information," Office of the Secretary of the Navy, Washington, D.C., June 1987.

Plan Multi-Media Coverage of an Event, TEC Lesson 570-214-1045-A, Office of the Chief of Public Affairs, Department of the Army, Washington, D.C., May 1984.

Chapter 5

Community Relations, Department of Defense Directive 5410.18, Department of Defense, Washington, D.C., July 1974.

Community Relations for Public Affairs Officers, DI0730, U.S. Army Public Affairs Proponent Activity, Fort Benjamin Harrison, Ind., July 1988.

Cutlip, Scott M., Allen H. Center, and Glen M. Broom, *Effective Public Relations* (Sixth Edition), Prentice-Hall, Inc., Englewood Cliffs, N.J., 1985.

Navy Public Affairs Policy and Regulations, SECNAVINST 5720.44A, Chapter 4, "Community Relations," Office of the Secretary of the Navy, Washington, D.C., June 1987.

Chapter 6

Community Relations for Public Affairs Officers, Subcourse DI0730, U.S. Army Public Affairs Proponent Activity, Fort Benjamin Harrison, Ind., July 1988.

Illustrator Draftsman, NAVEDTRA 10472, Chapter 16, "Audiovisual Presentation Equipment," Naval Education and Training Program Development Center, Pensacola, Fla., 1985.

Navy Public Affairs Policy and Regulations, SECNAVINST 5720.44A, Chapter 3, "Public Information," Office of the Secretary of the Navy, Washington, D.C., 1987.

Chapter 7

Charnley, Mitchell V., *Reporting* (Second Edition), Holt, Rinehart and Winston, Inc., New York, N.Y., 1966.

Command Information, DI0710, U.S. Army Public Affairs Proponent Activity, Fort Benjamin Harrison, Ind., September 1988.

Handbook for Stringers in the Armed Forces, NAVMC 26-84, Defense Information School, Fort Benjamin Harrison, Ind., October 1981.

Localize News Service Material, TEC Lesson 570-214-1008-A, Office of the Chief of Public Affairs, Department of the Army, Washington, D.C., January 1984.

Navy Public Affairs Policy and Regulations, SECNAVINST 5720.44A, Chapter 2, "Internal Information," Office of the Secretary of the Navy, Washington, D.C., June 1987.

Newsgathering Systems and Print Selection for Publication, DI0405, U.S. Army Public Affairs Proponent Activity, Fort Benjamin Harrison, Ind., September 1989.

Que's Computer User's Dictionary (Second Edition), Que Corporation, Carmel, Ind., 1991.

Saris, John C., *Handbook of Desktop Publishing*, Wordware Publishing, Inc., Plano, Tex., 1988.

Ship or Station Newspaper/Civilian Enterprise (CE) Publications, NAVPUBINST 5600.42A, Navy Publications and Printing Service Management Office, Washington, D.C., May 1985.

Simply By Design: Desktop Publishing Guide, Navy Publishing and Printing Service, Washington, D.C., April 1990.

The Associated Press Stylebook and Libel Manual, Addison-Wesley Publishing Company, Inc., Reading, Mass., 1992.

Webster's New World Dictionary of American English, Third College Edition, Simon & Schuster, Inc., New York, N.Y., 1988.

Chapter 8

Administer Traffic and Continuity, TEC Lesson 570-214-1059-A, Office of the Chief of Public Affairs, Department of the Army, Washington, D.C., March 1987.

Armed Forces Radio and Television Service (AFRTS) Program Materials, DoD Directive 5120.20-R, Appendix F, Department of Defense, Washington, D.C., January 1991

Cutlip, Scott M., Allen H. Center, and Glen M. Broom, *Effective Public Relations* (Sixth Edition), Prentice-Hall, Inc., Englewood Cliffs, N.J., 1985.

Metzler, Ken, *Creative interviewing* (Second Edition), Prentice-Hall, Inc., Englewood Cliffs, N.J., 1989.

Navy Public Affairs Policy and Regulations, SECNAVINST 5720.44A, Chapter 2, "Internal Information," Office of the Secretary of the Navy, Washington, D.C., June 1987,

Prepare a Master Radio Program Schedule, TEC Lesson 570-214-1060-A, Office of the Chief of Public Affairs, Department of the Army, Washington, D.C., March 1987.

Prepare a Master Television Program Schedule, TEC Lesson 570-214-1061-A, Office of the Chief of Public Affairs, Department of the Army, Washington, D.C., March 1987.

Shook, Frederick, *Television Field Production and Reporting*, Long man, Inc., White Plains, N.Y., 1989.

Wurtzel, Alan, and Stephen R. Acker, *Television Production* (Third Edition), McGraw-Hill Publishing Company, New York N.Y., 1989.

Yoakam, Richard D., and Charles F. Cremer, *ENG: Television News and the New Technology* (Second Edition), Random House, Inc., New York, N.Y., 1985.

Chapter 9

Conduct an AFRTS Audience Survey, TEC Lesson 570-214-1064-A, Office of the Chief of Public Affairs, Department of the Army, Washington, D.C., June 1986.

Cutlip, Scott M., Allen H. Center, and Glen M. Broom, *Effective Public Relations* (Sixth Edition), Prentice-Hall, Inc., Englewood Cliffs, N.J., 1985.

Hennessy, Bernard, *Public Opinion* (Fourth Edition), Brooks/Cole Publishing Company, Monterey, Calif., 1981.

Zisk, Betty H., *Political Research, A Methodological Sampler*, D.C. Heath and Company, Lexington, Mass., 1981.

INDEX

A

Announcing, 8-39

breathing, 8-39

exercises, 8-39

pitch and inflection, 8-41

resonance, 8-40

sound, making the, 8-39

vocal quality, 8-40

volume, 8-41

Audiovisual aids, 6-18

actual objects and models, 6-24

audio or sound effects, 6-24

directly shown devices, 6-18

optically projected aids, 6-21

C

Carousel slide projector, 6-23

Ceremonies, 5-19

arranging news coverage, 5-20

importance of details, 5-23

major events, 5-20

CIB after-action report, 3-10

CIB credentialing, 3-8

badge issuance, 3-8

follow-up actions, 3-9

identification verification, 3-8

registration, 3-8

CIB establishment plan, 3-2

determining procedures, 3-2

determining public affairs objectives, 3-2

following guidance, 3-2

CIB media ground rules, 3-8

CIB media pooling, 3-7

CIB media requirements, 3-6

amenities, 3-7

billeting, 3-7

communications, 3-6

medical care, 3-7

messaging, 3-7

military transportation support, 3-6

CIB news dissemination, 3-9

audiovisual equipment and materials, 3-10

background information, 3-10

bulletin boards, 3-10

interviews, 3-9

news briefings and conferences, 3-9

news releases, 3-9

photo boards, 3-10

CIB organization, 3-2

administrative support division, 3-3

liaison division, 3-3

media relations division, 3-3

CIB planning, 2-21, 3-1

CIB standard operating procedures, 3-3

command information requirements, 3-5

personnel requirements, 3-3

site selection and configuration, 3-4

CIBs, sub, 3-3

Civilian enterprise newspaper, 7-1

advantage of, 7-1

Civilian enterprise newspaper contract, 7-1

gathering data, 7-3

inclusive items, 7-2

publishers' visits, 7-3

selection committee, 7-2

special services, 7-3

- Clipanalysis, 1-39
- Command speakers bureau, 6-28
 - advertising the bureau, 6-35
 - assisting the speaker, 6-45
 - civic organization file, 6-34
 - establishing the planning directive, 6-29
 - evaluation of requests, 6-35
 - evaluation of the speaking engagement, 6-45
 - letter file, 6-35
 - speaker file, 6-31
 - speakers' folders, 6-34
 - speech research library, 6-34
- Communicating with the CO on public affairs matters, 1-49
- Community customs, traditions and cultures, 5-9
- Community/military mutual interests and problems, 5-12
- Community organizations, 5-9
- Community power structure, 5-7
 - decision makers, 5-7
 - influential, 5-7
 - opinion leaders, 5-7
- Community relations activities, past and present, 5-12
- Community relations policy (DoD/Navy), 5-5
 - fiscal considerations, 5-5
 - limitations, 5-5
 - objectives, 5-5
 - restrictions, 5-5
- Community relations program, 5-2
 - authority, 5-3
 - benefits, 5-2
 - definition of, 5-2
 - importance of, 5-2
- Community relations program, parts of, 5-3
 - base-community council, 5-4
 - communications channels, 5-3
 - namesake ship program, 5-4
 - publics, 5-3
- Community relations program, planned, 5-6
 - communicating, 5-14
 - evaluating, 5-15
 - fact finding, 5-6
 - planning, 5-13
- Community relations programs, types of, 5-4
- Community survey file, 5-8
 - analysis, 5-9
 - information to seek 5-8
 - where to look for information, 5-9
- Community's opinion of the military, 5-8
- Credibility in media relations, 4-17
- Credibility in public affairs office management, 1-13
- Cross-training, 1-12
 - benefits, 1-13
 - implementation, 1-13
- D**
- Desktop publishing, 7-13
 - hardware, 7-15
 - software, 7-16
- Disaster preparedness, 2-8
 - background materials, 2-15
 - command public affairs plan, 2-9
 - general administration, 2-16
 - objectives, 2-9
 - policy materials, 2-15
 - public affairs office plan, 2-9
- Disasters, definition of, 2-1
 - categorizing, 2-2
 - descriptive differences, 2-2
- Disasters, lessons learned, 2-2
 - Hurricane Hugo, 2-7
 - USS *Iowa*, 2-3
 - USS *Midway*, 2-5
- Disasters, policy guidance for, 2-1

- Disasters, public affairs procedures in, 2-21
 - admitting reporters to the accident scene, 2-26
 - attributes for dealing with the media, 2-23
 - authoritative background information, 2-28
 - briefing reporters, 2-25
 - cooperating with the news media, 2-23
 - debriefing survivors, 2-28
 - initial actions, 2-22
 - initial news release, 2-23
 - media ground rules, 2-25
 - media identification, 2-25
 - photography control (off base), 2-27
 - photography control (on base), 2-26
 - releasing authority, 2-21
 - releasing names of casualties, 2-27
- F**
 - Filters, video camera, 8-25
 - Funded newspaper, 7-1
 - Future of broadcasting, 8-41
- I**
 - Internal communications, 1-9
 - All Hands*, 1-10
 - Captain's Call Kit, 1-10
 - Navy News Service, 1-9
 - Navy Family Lifeline*, 1-10
 - Navy Editor Service, 1-10
 - Navy News This Week (NNTW), 1-10,8-35
 - Navy Talking Points, 1-10
 - Public Affairs Comvnunicator*, 1-10
 - Public Affairs Planning Guide, 1-10
 - Interviews, 4-8
 - general tips, 4-11
 - ground rules, 4-8
 - Interview tips, television, 4-11
 - appearance, 4-11
 - eye contact, 4-11
 - eyewear, use of, 4-11
 - first name, use of, 4-11
 - Interviews, types and techniques, 4-10
 - accident or incident, 4-10
 - ambush, 4-10
 - edited, 4-10
 - general, 4-10
 - remote, 4-10
 - talk show, 4-10
 - Investigations, 2-29
 - differences in reports, 2-29
 - public affairs actions, 2-29
- J**
 - Journalism excellence in Navy newspapers, 7-4
 - color photography, 7-4
 - credibility, 7-5
 - dictionary, selection of, 7-4
 - editorial comment, 7-5
 - stylebook, formulation of, 7-4
- L**
 - Letter, for CO's signature, 1-19
 - Letter, official Navy, 1-14
 - organization, 1-15
 - paragraph organization, 1-16
 - purpose of, 1-15
 - word selection, 1-15
 - Letter, public affairs, 1-18
 - Likert scale (surveys), 9-9
- M**
 - Marketing stories, 4-15
 - log book, 4-16
 - magazines, 4-16
 - Navy Public Affairs Centers, role of, 4-16

Marketing stories—Continued

Navy Office of Information (NAVINFO), role of, 4-16

success rate, 4-16

Media actions, 4-5

Media communications strategies, 4-6

Media embark 4-14

approval authority, 4-14

escorts, 4-15

pre-departure briefing, 4-15

preparing the command, 4-15

Media/military relations during hostilities, 4-17

family considerations, 4-17

media prod, 4-17

Media/military relations, importance of, 4-1

public opinion, 4-1

trends, 4-1

Media relations, role of the PAO/senior JO in, 4-6

Media types, 4-2

books, 4-5

internal or promotional publications, 4-5

magazines, 4-4

magazines, news, 4-4

magazines, consumer, 4-5

newspaper, 4-3

radio, 4-3

syndicates, 4-4

television, 4-3

Memorandum for the record, 1-35

Memorial service, 2-32

responsibilities, 2-32

written plan, 2-32

Microcomputers, 1-50

backing up distribution diskettes, 1-54

backing up text/data files, 1-54

central processing unit (CPU), 1-50

Microcomputers—Continued

diskette, 1-52

disk operating system (DOS), 1-53

hard disk, 1-52

history, 1-50

keyboard, 1-51

local-area networks (LANS), 1-54

monitor, 1-51

printers, 1-53

user/applications software, 1-54

N

Naval messages, 1-25

parts of, 1-25

Navy staff organization, 1-1

command and staff action, 1-2

functions, 1-3

relationship with the flagship, 1-4

typical structure of, 1-2

NBS detachment administration, 8-1

continuity, 8-3

cross-training, 8-3

departments, 8-1

operations, 8-2

standard operating procedures, 8-2

station organization, 8-1

training, 8-3

News conference, 4-12

command participants, 4-12

conducting, 4-14

inviting news media, 4-12

preparing participants, 4-12

site requirements, 4-12

News release in message form, 1-29

- News services, 4-3
 - foreign, 4-4
 - The Associated Press, 4-4
 - United Press International, 4-4
- Newspaper establishment, 7-4
- Newspaper news gathering methods, 7-10
 - beat system, 7-10
 - morgue, 7-11
 - stringer system, 7-10
- Newspaper readership surveys, 7-10
- Newspaper staff credentials, 7-9
- Newspaper staff organization, 7-5
 - associate editor, 7-6
 - cartoonist, 7-7
 - classified ads, 7-7
 - copy log, 7-9
 - editor, 7-5
 - general assignment writers, 7-7
 - leisure editor, 7-7
 - making assignments, 7-8
 - photography, 7-8
 - sports editor, 7-7
 - training, 7-9
- Next of kin, 2-30
 - Navy families and the media, 2-31
 - Navy family support, 2-31
 - PAO/CACO relationship, 2-30
- O**
- Opaque projector, 6-21
- Overhead transparency projector, 6-22
- P**
- Point paper, 1-36
- Preparing directives, 1-20
 - adverse incident plan, 1-25
 - CIB plan, 1-25
- Preparing directives—Continued
 - public affairs annex, 1-20
 - public affairs plan, 1-20
- Prints, selecting for newspaper publication, 7-11
 - contact sheet selection, 7-11
 - cutline information, 7-13
 - fired photograph selection, 7-11
 - initial step, 7-11
- Proofreading galley proofs and bluelines, 7-13
- Public affairs guidance (PAG), 1-29
- Public affairs office administrative processes, 1-5
 - coordinating, 1-7
 - organizing, 1-6
 - planning, 1-6
 - supervising, 1-7
- Public affairs office files, 1-38
 - clip file, 1-38
 - file folders for, 1-38
 - hardware for, 1-38
 - organization of, 1-38
- Public affairs office location and appearance, 15
- Public affairs office management tools, 1-1
 - authority, 1-1
 - resources, 1-1
- Public affairs office telephone procedures, 1-40
 - answering/facsimile machines, 1-41
 - budgeting time, 1-41
 - etiquette, 1-40
 - taking messages, 1-41
- Public affairs programs and products, evaluation of, 1-8
- R**
- Radio programming, 8-17
 - AFRTS prerecorded shows, 8-21
 - local live music shows, 8-20
 - master program schedule layout, 8-21
 - news and sports, 8-21

- Radio programming—Continued
 - other significant dayparts, 8-20
 - peak periods, 8-20
 - scheduling program material, 8-20
 - tactics, 8-24
 - weekly schedule, 8-24
- Release of news to the media, 4-6
 - news advisory, 4-7
 - news release, 4-7
 - oral release, 4-8
 - visual release, 4-15
- S**
- SATNET, 8-9
- Screens, projection, 6-24
 - beaded, 6-26
 - high-gain aluminum, 6-25
 - lenticular, 6-26
 - matte, 6-26
 - rear-projection, 6-26
- Shipboard public affairs office management, 1-41
 - civilian embarkation, 1-44
 - commissioning, 142
 - decommissioning, 1-43
 - financial management, 1-47
 - homecomings, 1-43
 - manning, 1-42
 - SECNAV Guest Cruise, 1-45
 - tours, 1-46
 - typical office arrangement, 1-41
- Special events, 5-15
 - targeting the audience, 5-16
 - types, 5-15
- Special events planning, 5-17
 - checklist, 5-19
 - evaluation, 5-19
 - executing the plan, 5-18
- Special events plannings—Continued
 - facilities, 5-18
 - objectives, 5-17
 - procedures, 5-18
 - reports, 5-19
- Special events policy, 5-17
- Speech classifications, 6-2
 - to actuate, 6-3
 - to convince, 6-3
 - to entertain, 6-3
 - to inform, 6-3
 - to introduce, 6-4
 - to secure goodwill, 6-2
 - to stimulate, 6-3
- Speech delivery methods, 6-4
 - extemporaneous, 6-5
 - impromptu, 6-4
 - manuscript, 6-5
 - memorization, 6-5
- Speech explanation, 6-10
 - main points, 6-10
 - phrasing, 6-11
- Speech introduction, 6-7
 - attention step, 6-7
 - humor, 6-7
 - interesting illustration, 6-7
 - limited objective, 6-8
 - motivation, 6-9
 - quotation, 6-7
 - rhetorical questions, 6-8
 - striking facts or statistics, 6-8
 - visual device, 6-8
- Speech preparation, 6-1
 - accepting the right speaking engagement, 6-1
 - assessing the location, 6-2
 - assessing the occasion, 6-2
 - choosing and researching the topic, 6-1

- Speech presentation staging, 6-24
 - audiovisual mechanics, 6-28
 - lighting, 6-26
 - Speech summary, 6-12
 - forceful conclusion, 6-13
 - re-emphasize motivation, 6-13
 - recap the main points, 6-12
 - Speech supporting material, 6-12
 - analogies, 6-12
 - factual examples, 6-12
 - illustrations, 6-12
 - personal experiences, 6-12
 - Speech writing, 6-13
 - audience analysis, 6-13
 - delivery techniques, 6-16
 - preparation steps, 6-14
 - speaker analysis, 6-14
 - speech wording, 6-16
 - Speeches, directly shown devices used in, 6-18
 - charts, 6-18
 - dry marker/chalkboards, 6-20
 - graphs, 6-19
 - handouts, 6-20
 - maps, 6-20
 - posters, 6-20
 - slap-ons, 6-20
 - Sports, 8-36
 - amounting, 8-39
 - photographing the play, 8-36
 - Survey analysis, 9-10
 - correlations, 9-10
 - graphic display, 9-10
 - Survey development, 9-5
 - random selection, 9-5
 - sample selection, 9-6
 - Survey, formal, 9-3
 - mail, 9-4
 - personal interview, 9-4
 - telephone, 9-3
 - Survey, informal, 9-2
 - call-in telephone lines, 9-3
 - content analysis, 9-2
 - mail analysis, 9-3
 - Survey, purpose of, 9-1
 - program effectiveness, 9-1
 - survey expectations, 9-1
 - Survey question writing, 9-8
 - design, 9-8
 - format, 9-8
 - measuring intensity, 9-8
 - pretesting, 9-8
 - Survey reliability, 9-9
 - Survey validity, 9-9
- T**
- Television interviewing, 8-37
 - body language, 8-38
 - friendliness, 8-37
 - meat puppet shot, 8-38
 - photographers, 8-38
 - questions, 8-37
 - tips, 8-38
 - Television news, 8-28
 - anchor, the, 8-34
 - basic video news, 8-29
 - field shooting techniques, 8-33
 - Navy News This Week (NNTW), 8-35
 - news director/assignment editor, 8-29
 - newsroom organization, 8-28
 - reporters and photographers, 8-29
 - stand-ups, 8-34
 - talent, 8-34

- Television production, 8-25
 - broadcast lighting, 8-25
 - ENG lighting, 8-26
 - ENG lighting (night), 8-26
 - microphone usage, 8-26
 - microphone usage (conferences and panels), 8-26
 - scriptwriting, 8-28
 - video editing, 8-27
 - Television programming, 8-3
 - AFRTS-BC shipments, 8-9
 - available programming, 8-9
 - defining the target audience, 8-5
 - determining prime time, 8-5
 - development of, 8-5
 - free form blocking, 8-11
 - horizontal blocking, 8-11
 - master program schedule layout, 8-17
 - Television programming—Continued
 - other dayparts, 8-7
 - restricted programming, 8-9
 - strategies, 8-4
 - time techniques, 8-11
 - vertical blocking, 8-11
 - weekly schedule, 8-17
 - Training, 1-10
 - appropriation of time, 1-11
 - characteristics of proper location, 1-11
 - methods, 1-12
 - role of the senior JO in, 1-11
- U**
- Unit situation report (SITREP), 1-28
- V**
- Videotapes used in speeches, 6-23

Assignment Questions

Information: The text pages that you are to study are provided at the beginning of the assignment questions.

ASSIGNMENT 1

Textbook Assignment: "Public Affairs Officer Management." pages 1-1 through 1-20.

- 1-1. In the successful operation of a public affairs office, which of the following is NOT an essential ingredient?
1. The authority to do the job
 2. The presence of a full-time PAO
 3. The support of the officer in command and his staff
 4. The resources to do the job
- 1-2. Which of the following documents is the primary authority in the daily management of a public affairs office?
1. CHINFOINST 5720.44
 2. SECNAVINST 3712.55R
 3. SECNAVINST 5720.44A
 4. CHINFOINST 5712.36A
- 1-3. A typical Navy staff includes how many staff divisions?
1. Five
 2. Two
 3. Three
 4. Four
- 1-4. Which of the following staff divisions is NOT a part of a typical Navy staff organization?
1. Implementation
 2. Operations and Plans
 3. Logistics
 4. Administration
- 1-5. On a Navy staff, the PAO normally serves under whom?
1. The chief of staff
 2. The assistant chief of staff for administration
 3. The officer in command, as an aide
 4. The assistant chief of staff for communications
- 1-6. What purpose best describes the function of a military organization?
1. To be victorious in battle
 2. To support the policies of the Secretary of State
 3. To improve the economy
 4. To promote good will with foreign nations
- 1-7. The primary reason for the staff to exist is to accomplish which of the following goals?
1. Saving time
 2. Carrying out the mission of the security officer
 3. Decentralizing responsibility
 4. Assisting the commander in accomplishing his mission
- 1-8. Which of the following functions are performed by all divisions of the staff?
1. Preparing and transmitting directives
 2. Developing plans
 3. Providing input and making recommendations
 4. All of the above
- 1-9. Which of the following functions is NOT performed by a public affairs staff?
1. Judging the significance of information
 2. Preparing the facts as the commander would like to see them
 3. Making sure information is reliable
 4. Providing complete information

- 1-10. Which of the following planning responsibilities is usually designed to staffs?
1. Anticipating the needs of the commander
 2. Keeping alert to the need for new plans or directives
 3. Drafting amendments to plans in force
 4. All of the above
- 1-11. A public affairs office staff can achieve maximum resource efficiency by performing which of the following functions?
1. Planning for the best use of each individual's skills
 2. Insisting on the necessity of adequate materials and time
 3. Planning in terms of the command's total resources
 4. Organizing all staff personnel into JO/PH teams
- 1-12. What factor is the most important in achieving coordination of all staff activities?
1. A cooperative officer in command
 2. Good morale in the activity
 3. An adequate plan for the activity
 4. Free exchange of information among the staff divisions
- 1-13. Which of the following statements best describes the decision-making function of staff officers?
1. In many areas, the commander delegates the responsibility for action to staff members
 2. Only the PAO, as a staff member, may make all decisions in his area of authority
 3. Whenever the commander delegates authority for staff action, his assistant may make decisions in the name of the commander
 4. *PA Regs* and *Navy Regulations* should be consulted whenever a staff member makes a significant decision
- 1-14. What staff officer approves and issues routine news releases?
1. Commander
 2. Security officer
 3. PAO
 4. Operations officer
- 1-15. When a story that may be sensitive arises which of the following procedures should you follow?
1. Wait until the commander suggests a news release and then check the facts
 2. First check the facts, next prepare a news release, and then get the commander's approval
 3. First check the facts, get the commander's approval next, and then prepare a news release
 4. First seek the commander's approval, check the facts next, and then prepare a news release
- 1-16. The bulk of the directives in a typical staff are prepared (a) by whom, and signed (b) by whom?
1. (a) A staff section
(b) the assistant chief of staff for the section
 2. (a) A staff section
(b) the officer in command
 3. (a) The assistant chiefs of staff
(b) the chief of staff
 4. (a) The chief of staff
(b) the commander
- 1-17. Concerning directives that have been issued, staff officers have which of the following responsibilities?
1. To make certain the directives are understood and followed
 2. To recommend changes to the directives when appropriate
 3. To verify reports for completeness and relevance of the data
 4. All of the above

- 1-18. The relationship between a staff and the flagship is defined in which of the following publications?
1. Navy Regulations
 2. Navy Flagship Manual
 3. PA Regs
 4. Flag Officer's Handbook
- 1-19. To discharge his duties effectively, the flagship division officer maintains close liaison with what individual?
1. Personnel officer
 2. Commanding officer
 3. Legal officer
 4. Executive officer
- 1-20. A typical public affairs office should include work space for how many reporters?
1. 7 to 10
 2. 3to8
 3. 1or2
 4. 10 to 14
- 1-21. A public affairs office would have an unlisted telephone number for which of the following reasons?
1. Because it provides communication during a major disaster when all of the telephones are in use
 2. Because it allows the PAO to hold confidential conversations
 3. Because it holds down the number of crank calls the office often receives
 4. Because it provides reporters with immediate access to the PAO
- 1-22. Of the following factors, which one is NOT a consideration in office management planning?
1. Mission
 2. Work flow
 3. Use of personnel
 4. Seniority of personnel
- 1-23. The use of identification devices for key public affairs personnel to have access to disaster scenes and restricted events must be authorized by which of the following means?
1. Memo from the PAO
 2. Command directive
 3. Memo from the legal officer
 4. Letter from the security officer
- 1-24. Making decisions with respect to goals, policies, procedures and schedules is a part of what administrative process?
1. Coordinating
 2. Organizing
 3. Planning
 4. Supervising
- 1-25. Most large public affairs offices are organized into departments (a) by what factor and (b) for what purpose?
1. (a) Personnel skills
(b) to specialize
 2. (a) Personnel skills
(b) to cross train
 3. (a) Functions
(b) to specialize
 4. (a) Functions
(b) to cross-train
- 1-26. In organizing an office by functions, you should minimize the drawbacks of overspecialization by which of the following means?
1. Doing everything yourself
 2. Being available so you can step in to take a specialist's place
 3. Increase the manning level so you have two specialism on each job
 4. Encouraging cross-training
- 1-27. Which administrative function must be considered in every part of the public affairs job?
1. Planning
 2. Coordinating
 3. Organizing
 4. Supervising

- 1-28. Which of the following factors is an important part of good coordination?
1. Proper timing
 2. Managerial experience
 3. Rating knowledge
 4. Military bearing
- 1-29. What saying best describes the principles of good office management?
1. Strict discipline is essential to success
 2. Leadership is the keystone to good supervision
 3. Familiarity with the personal needs of staff members is vital to success
 4. Work hard, play hard
- 1-30. As the manager of a public affairs office, you must maintain the same level of supervision for both experienced and inexperienced staff members.
1. True
 2. False
- 1-31. One of your J03s gives you poorly written story for external release. Which of the following actions should you take?
1. Give it to the PAO for revision
 2. Assign the story to another staff member
 3. Review the story with the J03 and have him rewrite it
 4. Rewrite the story yourself and reprimand the J03
- 1-32. Excessively criticizing a staff member's work may lead to which of the following reactions?
1. Hostility
 2. Laziness
 3. Enthusiasm
 4. Ambivalence
- 1-33. A JOSN suggests an impractical change in office procedures. You should act or respond in which of the following ways?
1. Tell him he should conduct research before making a suggestion
 2. Tell him if there are any changes to be made, you will make them and he should keep his suggestions to himself
 3. Approve the change as a means of encouraging him to suggest other changes
 4. Disapprove the suggestion, but tell him you appreciate the thought behind it
- 1-34. Evaluating the effectiveness of public affairs programs and products can be done when you perform which of the following functions?
1. Motivate
 2. Train
 3. Counsel
 4. Supervise
- 1-35. Your command fact sheet has an awkward design and outdated statistics. Which of the following methods is the most practical way to evaluate the fact sheet before settling on the changes?
1. Review it in detail with the PAO and send your recommendations to CHINFO
 2. Request the input of the C/MC, XO and CO
 3. Review it with your staff in a planning session
 4. All of the above
- 1-36. Which of the following groups is NOT a part of the five-part Navy internal audience?
1. Navy retirees and families
 2. Navy civilian contract employees and families
 3. Family members of active-duty Navy personnel
 4. Naval Reserve personnel and families

- 1-37. The Navy Internal Relations Activity (NIRA) produces which of the following products?
1. Navy Editor Service
 2. Navy News This Week
 3. Navy Talking Points
 4. Navy Public Relations Quarterly
- 1-38. Which of the following products is the Navy's equivalent of a news wire?
1. Navy Editor Service
 2. Navy News This Week
 3. Navy News Service
 4. Public Affairs Communicator
- 1-39. The Public Affairs Planning Guide is in what format?
1. Calendar
 2. Computer software
 3. Index card file
 4. Notebook
- 1-40. Navy Talking Points provides information to assist the PAO and senior journalist in administering the internal communications program of a command.
1. True
 2. False
- 1-41. The responsibility of administering and monitoring the public affairs office training program falls upon which of the following individuals?
1. Training LPO
 2. PAO
 3. Senior JO
 4. Division officer
- 1-42. Professional training topics should be selected using which of the following resources?
1. Navy enlisted classifications (NECs)
 2. BUPERS Manual
 3. DINFOS Handbook
 4. Advancement Handbook for Petty Officers (Journalist)
- 1-43. You select J02 Annish to conduct a training session on releasing information. J02 Annish should be required to show you her lesson plan at least how many days before the training session?
1. Five
 2. Two
 3. Three
 4. Four
- 1-44. The scheduling of training is best described by what statement?
1. Training is least effective when it is held on the same day each week
 2. Training is most effective when the senior JO delivers every presentation
 3. Training is least effective when members of the staff are assigned as trainers on a rotating basis
 4. Training is most effective when it is held on the same day and at the same time each week
- 1-45. Which of the following actions will keep your trainees interested in your training program?
1. Conducting training sessions more than two hours long
 2. Scheduling training sessions after working hours
 3. Holding training sessions at different locations
 4. Timing the training sessions to coincide with the training programs of other divisions

- 1-46. To avoid distractions (such as telephone calls and visitors) during a training session, you should take which of the following actions?
1. Place a large sign outside the office that reads: "Training in progress: do not disturb"
 2. Assign one of your staff members to greet visitors and answer the telephones
 3. Both 1 and 2 above
 4. Take the telephones off their hooks and do not answer the door
- 1-47. A thorough, professional training program may be administered by using which of the following resources?
1. Plan of the Day
 2. *Direction* Magazine
 3. Training Program Management. SECNAVINST 5720.44C
 4. *Public Affairs Communicator*
- 1-48. What training method is best delivered during morning quarters?
1. Thought/teaching point of the day
 2. NRTC questions
 3. Presentations by guest speakers
 4. Handouts
- 1-49. Cross-training is constantly emphasized in the JO rating to increase which of the following individual characteristics?
1. Versatility
 2. Fidelity
 3. Individuality
 4. Integrity
- 1-50. Which of the following is a benefit derived from a strict cross-training program?
1. Higher self-esteem
 2. Better working hours
 3. Broader base of experience
 4. Improved working conditions
- 1-51. As the public affairs office manager, you should rotate your staff members into new jobs at which of the following time intervals?
1. Every 2 - 6 months
 2. Every 6 - 12 months
 3. Every 12 - 18 months
 4. Every 18 - 24 months
- 1-52. A fundamental guideline in establishing credibility is having a basic knowledge of public affairs regulations.
1. True
 2. False
- 1-53. Establishing credibility encompasses having a good working knowledge of the command. Basic command information may be obtained from which of the following individuals?
1. Senior managers
 2. Mid-level managers
 3. Low- and mid-level employees
 4. Upper-level employees
- 1-54. Establishing credibility in public affairs does NOT require which of the following actions?
1. Keeping the PAO informed
 2. Arriving to work early and leaving late
 3. Getting along with others
 4. Knowing the PAO's priorities and making them yours
- 1-55. What is the first step in preparing a Navy letter?
1. Word choice
 2. Planning
 3. Paragraph Organization
 4. Writing a topic sentence

- 1-56. Why is it a good practice for you to limit a letter to one topic?
1. To keep it short
 2. To save time
 3. To avoid confusion and delay in getting replies
 4. To simplify office filing requirements
- 1-57. The proper organization of a letter is done when the writer follows what rule?
1. Keeps the reader in mind
 2. Writes only brief paragraphs
 3. Writes only brief sentences
 4. Omits transitions from one unit to another
- 1-58. What is the best practice in choosing words for your letter?
1. To avoid using the same word frequently
 2. To be precise and simple
 3. To use words that are formal and dignified
 4. To use colorful words that give variety
- 1-59. All underlined words in the following sentences are spelled correctly. In which sentence is the underlined word used correctly?
1. He was appraised of the situation
 2. The principle of the school is absent today
 3. He lives according to his principals
 4. He was apprised of the situation
- 1-60. If you have trouble in deciding the exact meaning of a word in a sentence, you should take which of the following actions?
1. Ask the senior JO in the area for his opinion
 2. Change, the sentence to avoid using the troublesome word
 3. Consult the dictionary
 4. Use the word, then check with the PAO at a later time
- 1-61. Short paragraphs are desirable in modern letter writing for which of the following reasons?
1. Readability
 2. Aesthetic Acceptabilit
 3. Reliability
 4. Conformity
- 1-62. Which of the following sentences may serve as a topic sentence?
1. Did you secure the safe?
 2. War is expensive.
 3. Later we found them in the galley.
 4. It started to snow the next day.
- 1-63. Where is the topic sentence placed in the paragraph?
1. Usually at the beginning as an introductory sentence
 2. In a summary sentence at the end
 3. Midway through the paragraph
 4. Each of the above

IN ANSWERING QUESTIONS 1-64 THROUGH 1-68, SELECT FROM COLUMN B THE SENTENCE ORDER MOST APPROPRIATE FOR THE PURPOSE IN COLUMN A. RESPONSES IN COLUMN B MAY BE USED MORE THAN ONCE.

- | | A. PURPOSES | B. ORDER |
|-------|--|---|
| 1-64. | An explanation of title process used in cleaning a rifle | 1. Place order
2. Logical order |
| 1-65. | The presentation of facts to support a request for new equipment | 3. Chrono-logical order
4. Order of emphasis |
| 1-66. | A plea for the use of safety practices | |
| 1-67. | A description of the circumstances at the time of a collision between two Navy vessels | |
| 1-68. | A story on how to enter the all-Navy cartoon contest | |

-
- 1-69. What kind of order was used in the *All Hands* reply to the letter asking about the history of the USS *Bowditch*?
1. Place order
 2. Order of emphasis
 3. Chronological order
 4. Logical order

- 1-70. In writing public affairs correspondence, you should avoid which of the following habits?
1. Impersonal passive voice
 2. Unnecessary words and details
 3. Lengthy acknowledgements
 4. All of the above

- 1-71. Before drafting correspondence for the CO'S signature, you should perform which of the following tasks?
1. Review the YN3 and YN2 training manuals for more detailed information
 2. Determine the CO'S viewpoint on the topic
 3. Conduct a detailed interview with the CO and get to know him better
 4. Call CHINFO or DINFOS for assistance

- 1-72. Where drafting a letter for the CO, you should place the recommended action to be taken in what paragraph?
1. The first
 2. The second
 3. The third
 4. The fourth

- 1-73. Which of the following functions is NOT a part of the SOPs for operating a public affairs office?
1. Reducing the number and complexity of later directives
 2. Advising or guiding new personnel in routine matters
 3. Promoting proven office practices
 4. Establishing a standard format for Navy instructions and notices

- 1-74. Whatt kind of directive would normally be used to govern the release of information about a serious accident to Navy personnel at a specific command?
1. A directive written by the CO
 2. A local SOP
 3. A special directive from the PAO
 4. A special directive from CHINFO

1-75. Under what circumstance, if any, may a public affairs plan vary from the format in Appendix I?

1. Where the purpose of the plan will be better served by the changed format
2. Where the changes are approved by CHINFO
3. When the contents of the plan are modified
4. None of the above

ASSIGNMENT 2

Textbook Assignment: "Public Affairs Office Management," pages 1-25 through 1-55.

2-1. A typical public affairs annex to an operation order contains all except which of the following information?

1. Specific instructions on policy for information activities
2. The scope of picture and Story coverage desired
3. The staffing of the Command Information Bureau (CIB)
4. Plans for communication facilities for the fleet operation

2-2. Command information bureaus (CIBs) are normally established by a notice for which of the following events?

1. Adverse incidents
2. A major fleet exercise
3. An important news situation
4. All of the above

2-3. Information on the release of casualties is contained in which of the following public affairs plans?

1. CIB
2. Adverse incident
3. Special event
4. Command public affairs

2-4. Comprehensive information on how to properly format a naval message may be found in which of the following publications?

1. Navy Public Affairs Policy and Regulations, SECNAVINST 5720.44A
2. Special Incident Reporting, OPNAVINST 3100.6F
3. Naval Messaging, OPNAVINST 3100.6G
4. Telecommunications Users Manual, Naval Telecommunications Procedures (NTP) 3

2-5. Which of the following date-time groups is correct?

1. 091245Z 93 JUN
2. 2118025Z JUL 93
3. 0021445Z AUG 93
4. 041730Z SEP 93

- | |
|--------------|
| A. Routine |
| B. Priority |
| C. Immediate |
| D. Flash |

Figure 1

IN ANSWERING QUESTIONS 2-6 THROUGH 2-11, SELECT THE NAVAL MESSAGE PRECEDENCE THAT FITS THE DESCRIPTION USED AS THE QUESTION. RESPONSES IN FIGURE 1 MAY BE USED MORE THAN ONCE.

2-6. Most public affairs messages are sent using this precedence.

1. A
2. B
3. C
4. D

2-7. Speed of service objective is within '30 minutes.

1. A
2. B
3. C
4. D

2-8. The highest precedence normally authorized for administrative messages.

1. A
2. B
3. C
4. D

- 2-9. Contains the precedence prosign Z.
1. A
 2. B
 3. C
 4. D
- 2-10. Assigned when the message concerns the immediate movement of naval air or ground forces.
1. A
 2. B
 3. C
 4. D
- 2-11. Assigned when used to report a hurricane believed to be previously undetected.
1. A
 2. B
 3. C
 4. D
- 2-12. The "INFO" line in a naval message is located in which of the following areas?
1. Under the TO line
 2. Under the FROM line
 3. Before the DTG
 4. After the subject line
- 2-13. Which of the following punctuation marks/symbols may NOT be used in a naval message?
1. &
 2. \$
 3. @
 4. '
- 2-14. The preparation of a unit situation report (SITREP) is warranted in all except which of the following situations?
1. A naval base galley fire that results in \$1,000 in damages
 2. A Navy jet that blows two tires and runs off the runway at a naval air station
 3. A frigate that runs aground on the shores of a small Maryland city
 4. A flood at the base Navy Exchange that inconveniences patrons for two weeks
- 2-15. An event occurs that warrants the transmission of a unit SITREP. You should transmit the unit SITREP within what maximum amount of time?
1. 1 hour
 2. 2 hours
 3. 20 minutes
 4. 40 minutes
- 2-16. An initial unit SITREP may be delayed while the public affairs office gathers critical information for release.
1. True
 2. False
- 2-17. A news release in message form should be released at what point?
1. When 30 minutes have elapsed since the unit SITREP was sent
 2. When all details are gathered and verified
 3. When the CO decides that the information should be released
 4. Where the unit SITREP is sent, or immediately after

- 2-18. Which of the following Statements best describes the objective of public affairs guidance (PAG)?
1. PAG is written to support the training programs of public affairs office managers.
 2. PAG forms the foundation of what to say or what not to say on a particular issue
 3. PAG forms the foundation of Navy-wide training programs implemented by CHINFO
 4. pag is written to supplement policy in OPNAVINST 1330.2B
- 2-19. How should you write PAG on a single, but diverse, issue?
1. Cover the main issue and at least one additional prominent issue
 2. Cover the main issue and at least two additional prominent issues
 3. Cover the most important issue and make it the subject of the PAG
 4. Each of the above
- 2-20. The memorandum for the record allows you to perform which of the following functions?
1. Record important information that may not otherwise be documented
 2. Bypass the chain of command to take appropriate action
 3. Create a binding legal document to be used to establish policy
 4. All of the above
- 2-21. A point paper may be used in which of the following situations?
1. When requesting public affairs assistance from CHINFO
 2. When establishing a public affairs office training program
 3. Where a superior is preparing for a press conference
 4. All of the above
- 2-22. What is the standard size of Navy correspondence?
1. 8 by 11 inches
 2. 8 1/2 by 11 inches
 3. 8 1/2 by 13 inches
 4. 9 by 13 inches
- 2-23. The public affairs office manager should maintain files on which of the following items?
1. Memoranda
 2. News releases
 3. Command history
 4. All of the above
- 2-24. For you to produce a newspaper clipping for the clip file, what is the most preferred method?
1. To center mount the clip on an 11- by 14-inch sheet of plain bond paper, using cellophane tape
 2. To mount the clip flush left on an 8 1/2- by 13-inch sheet of plain bond paper, using rubber cement
 3. To center mount the clip on an 8 1/2- by 11-inch sheet of plain bond paper, using a paper adhesive
 4. To mount the clip flush right on an 8 1/2- by 13-inch sheet of colored bond paper, using a stapler
- 2-25. A package of the daily news clippings should be forwarded to which of the following individuals?
1. CO, XO and all division officers
 2. CO, XO, C/MC and all department heads
 3. CO, C/MC and all department heads and division officers
 4. CO, XO, all division officers and all LCPOs

- 2-26. Which of the following phrases is considered most appropriate when you answer the telephone?
1. "USS *Manatee* Public Affairs, Petty Officer Martin speaking, may I help you please?"
 2. "USS *Manatee* PAO, can I help you?"
 3. "This is Petty Officer Martin, USS *Manatee* PAO, can I assist you?"
 4. "*Manatee* PAO"
- 2-27. Before putting a telephone caller on hold, you should use which of the following phrases?
1. "Just a minute"
 2. "Wait one"
 3. "One minute"
 4. "One moment, please"
- 2-28. You receive five telephone calls in a 30-minute span while working on two very important projects. What action should you take?
1. Attend to the telephone calls first, then continue working on the projects
 2. Continue working on the projects, then return the telephone calls if you have time
 3. Attend to the telephone calls and ask the PAO for help on the projects
 4. Continue working on the projects, then return the telephone calls as soon as you can
- 2-29. Which of the following statements best describe(s) the situation you will encounter when working for a collateral duty PAO?
1. A collateral duty PAO will provide the office with better overall leadership than a 1650 PAO
 2. A collateral duty PAO will devote a limited amount of time to the office
 3. A collateral duty PAO will depend on the senior journalist to handle the daily office responsibilities
 4. Both 2 and 3 above
- 2-30. Who serves as the overall coordinator for the commissioning ceremony of a ship?
1. ASD(PA)
 2. The prospective CO of the ship
 3. CHINFO
 4. The PAO/senior journalist of the ship
- 2-31. A typical press kit for the commissioning of a ship contains which of the following items?
1. The name of the sponsor
 2. A coat of arms description
 3. The names of congressional members that are scheduled to attend the ceremony
 4. An official welcome and statement from SECNAV
- 2-32. Plans for the homecoming ceremony of a ship are executed with the help of what individual?
1. The "sister ship" homecoming coordinator
 2. The appropriate fleet CINC
 3. CHINFO
 4. The OIC of the appropriate NAVINFO

- 2-33. Printed invitations for a decommissioning ceremony should be mailed how many weeks before the actual ceremony date?
1. 1to2
 2. 3to6
 3. 4to8
 4. 5 to 10
- 2-34. Who is responsible for publicizing a decommissioning ceremony?
1. SECNAV
 2. CHINFO
 3. The Decommissioning ship's CO
 4. The station commander
- 2-35. The final selection of the principal speaker of a decommissioning ceremony is made by whom?
1. The CO of the decommissioning
 2. CHINFO
 3. SECNAV
 4. ASD(PA)
- 2-36. Detailed information regarding the embarkation of civilians in Navy ships is contained in which of the following publications?
1. OPNAVINST 5720.2 series
 2. SECNAVINST 5720.44A
 3. Both 1 and 2 Above
 4. SECNAVINST 5212.5 series
- 2-37. Where, if ever, are Tiger Cruise guests allowed to eat in the wardroom?
1. When the CO approves it
 2. Where officers sponsor the guests
 3. When scheduling and funding constraints allow
 4. Never
- 2-38. When funding permits, embarked civilians on a guest cruise should receive which of the following mementos?
1. A photograph of the ship signed by the CO
 2. A plaque of the ship
 3. A videotape of the visit
 4. A copy of the ship's latest cruisebook
- 2-39. Who, if anyone, is permitted to initiate guest cruise publicity?
1. The PAO of the ship
 2. The individual guest cruise participant
 3. The CO of the ship
 4. No one
- 2-40. When, if ever, may female entertainers stay overnight during an embark aboard a U.S. Navy ship?
1. When CHINFO approves it
 2. When the CO of the ship authorizes it
 3. When the appropriate fleet commander in chief approves it
 4. Never
- 2-41. Which of the following youth groups is authorized to embark aboard a U.S. Navy ship?
1. Quill and Scroll
 2. Boy Scouts of America
 3. Little League Baseball association of America
 4. National Junior Law Enforcement Club (NJLEC)
- 2-42. What is the duration (in days) of a SECNAV Guest Cruise?
1. 5
 2. 2
 3. 3
 4. 4

- 2-43. A SECNAV Guest Cruise includes all except which of the following activities?
1. An underway, overnight visit to an LPH or CGN
 2. A pier-side or at-sea tour of a surface ship
 3. A pierside tour or embark on a nuclear submarine
 4. Observation of Marine and SEAL field activities
- 2-44. Who is responsible for maintaining a list of probable SECNAV Guest Cruise guests?
1. ASD(PA)
 2. CNO
 3. SECNAV
 4. CHINFO
- 2-45. Guests eligible for a SECNAV Guest Cruise include those who have not participated in a cruise on a U.S. Navy ship in the last nine years.
1. True
 2. False
- 2-46. Public tours of a ship offer which of the following advantages?
1. Education
 2. Enjoyment
 3. Both 1 and 2 above
 4. Remedial public affairs
- 2-47. Before drafting a visitation plan, you should take which of the following actions?
1. Seek guidance from the next highest public affairs office in the chain of command
 2. Get input from those officers and special assistants who will be involved in the public visit(s)
 3. Draft a rough plan and mail it to CHINFO with a completed CHINFO Form 5723-1
 4. Formulate a visitation plan committee consisting of PAOs and senior journalists in the area
- 2-48. BM1 Whale is a top-notch sailor who presents an outstanding personal appearance. Through casual conversation, you discover that he is a former Toastmasters member and would enjoy conducting tours of the ship during Armed Forces Day this Saturday. What action should you take?
1. Discuss the situation with his division officer and department head, then ask him to put in a special request chit
 2. Request a command waiver to authorize a boatswain's mate to function in a public affairs role
 3. Specifically designate BM1 Whale as a tour guide in the public visitation plan
 4. Both 2 and 3 above
- 2-49. For which of the following reasons should you post a "welcome sign" at the guests' point of entry to the ship?
1. To reduce the chance of a commotion or civil rights breach
 2. To remind visitors that photography of any kind is strictly prohibited
 3. To chronicle the history and awards of the ship
 4. To list the legal rights of the visitors in case of severe injury or death
- 2-50. What statement best describes the tour route of a ship?
1. Tour routes must strictly follow the provisions of SECNAVINST 5720.44A
 2. Tour routes on aircraft carriers may not include a stop at the arresting wires, because of safety reasons
 3. Tour routes vary from ship to ship, but they all must take into consideration security, safety and the crew's privacy
 4. Tour routes on destroyers world frigates may include stops at the gun turrets, but not the missile launchers

- 2-51. What are the most significant factors in managing the operational target (OPTAR) funds of a public affairs office?
1. Convenience and adaptability
 2. Range and accessibility
 3. Reliability and conservation
 4. Conservation and cost consciousness
- 2-52. In the development of an annual financial plan, what is the first step?
1. Projecting the use of consumables during the year
 2. Identifying the primary evolutions scheduled for the year
 3. Making a "wish list" of office items available only through open purchase
 4. Establishing firm guidelines for implementing the plan
- 2-53. An annual financial plan should receive, at a minimum, a review and update how often?
1. Every quarter
 2. Every six months
 3. Every nine months
 4. Annually
- 2-54. The PAO is on TAD and you are tasked with briefing the CO on an important public affairs matter. Before selecting a method of delivering the information, you should concentrate on which of the following areas?
1. Formulating a point paper on the matter
 2. Interviewing the CO's secretary to get his personal views on the matter
 3. Having complete and accurate information on the matter
 4. Practicing your delivery method with a colleague or a member of the staff
- 2-55. The PAO has left instructions for you to brief the CO using the memorandum system. How should you structure the memorandum?
1. Summarize the topic in the first two paragraphs
 2. List at least three proposed courses of action in the third paragraph, then address the main points of the topic
 3. Both 1 and 2 above
 4. Explain the most important issues of the topic first, then list at least three proposed courses of action
- 2-56. What microcomputer unit processes the data, performs arithmetic and logic functions and maintains control of the system?
1. RAM
 2. System unit
 3. Display unit
 4. Hard disk drive
- 2-57. All of the following are other terms for monitors except which one?
1. Display
 2. System unit
 3. Display device
 4. Cathode-ray tube
- 2-58. In addition to brightness, contrast and sizing controls, which of the following controls may be found on a monochrome monitor?
1. Black/green
 2. Black/white
 3. Color/noncolor
 4. Amber/normal/green
- 2-59. Most color monitors are of the RGB type. What does RGB mean?
1. Red-green-blue
 2. Red-gold-blue
 3. Raster gauge beam
 4. Registered global beam

- 2-60. The keyboard is used for which of the following functions?
1. To receive output from the microcomputer
 2. To input data into the microcomputer
 3. To input programs into the microcomputer
 4. Both 2 and 3 above
- 2-61. In addition to alphabetic characters and numbers and special characters, keyboard have which of the following types of keys?
1. Control
 2. Function
 3. Both 1 and 2 above
 4. Operation
- 2-62. All of the following are physical characteristics of disks except which one?
1. Flat
 2. Round
 3. Direct access
 4. Sequential access
- 2-63. Diskettes are also referred to by what other terminology?
1. Floppy disk
 2. Read-only disk
 3. Write-only disk
 4. Hard disk
- 2-64. Diskettes come in which of the following sizes, in inches?
1. 3, 5 and 7 1/2
 2. 3 1/4, 5 and 8
 3. 3, 5 1/4 and 8
 4. 3 1/2, 5 1/4 and 8
- 2-65. Which of the following conditions can lead to lost or scrambled data on a diskette?
1. Placing a diskette near a telephone
 2. Storing a diskette in temperatures that exceed 72 degrees
 3. Both 1 and 2 above
 4. Labeling a disk with a felt-tipped marker
- 2-66. Rigid metal platters contained in a small sealed unit either within the system unit or external to it are which of the following types of disk drive?
1. Colt
 2. Winchester
 3. Hard disk
 4. Both 2 and 3 above
- 2-67. Speed, large storage capacities and convenience are all advantages of which of the following storage media?
1. Diskettes
 2. Hard disks
 3. Paper tape
 4. Magnetic tapes
- 2-68. Printers used with microcomputers usually have (a) what speed and (B) print characters in what manner?
1. (a) Low speed
(b) one character at a time
 2. (a) Low speed
(b) one line at a time
 3. (a) High speed
(b) one character at a time
 4. (a) High speed
(b) one line at a time
- 2-69. Which of the following printers, if any, produces characters by using a series of dots?
1. Ink jet
 2. Daisy-wheel
 3. Laser
 4. None of the above
- 2-70. All microcomputer systems will have at least what type of software?
1. A window program
 2. A disk operating system
 3. A word processing package
 4. A database management system

- 2-71. Which of the following types of information must you provide to an applications software package when you install it on a microcomputer system?
1. Microcomputer configuration information
 2. Examples of the work that will be performed
 3. Lists of outputs you want on a scheduled basis
 4. All of the above
- 2-72. You run the risk of losing data and programs stored on a disk if you do not take which of the following actions?
1. Make backup copies
 2. Enter security codes in the file name
 3. Assign a volume number and name to each disk
 4. Use subdirectories to store similar data and programs
- 2-73. What does the term nodes refer to in local-area networks (LANs)?
1. Communications media
 2. Diskettes
 3. Operators
 4. Hardware
- 2-74. A LAN may be used to run an application program stored on the server's disk.
1. True
 2. False

ASSIGNMENT 3

Textbook Assignment: "Public Affairs in Adverse News Situations," pages 2-1 through 2-33.

- 3-1. A Navy commander has been charged with using a military aircraft to import large amounts of duty-free liquor from Bermuda. The responsible PAO should take which of the following actions?
1. Release the information only if asked by a reporter
 2. Release the information
 3. Cover up the story
 4. Write a memorandum for the record and hope the story will not surface
- 3-2. The armed services' basic policy for the release of disaster information is formulated by which of the following organizations?
1. DoD
 2. U.S. State Department
 3. OASD(MRAL)
 4. USIA
- 3-3. Guidance on the dissemination of disaster information is contained in which of the following regulations?
1. DoD Regs
 2. AEC Regs
 3. CHINFO Regs
 4. PA Regs
- 3-4. Peacetime naval disasters are best categorized in what way?
1. As man-made or predictable
 2. As predictable or unpredictable
 3. As naturally occurring or man-made
 4. As naturally occurring or unpredictable
- 3-5. Within CHINFO, detailed case studies of naval disasters may be obtained from which of the following divisions?
1. Professional development
 2. Media operations
 3. Plans and policy
 4. Administration and resource management
- 3-6. All except which of the following lessons were learned from the USS Iowa disaster?
1. Identifying a CIB site as soon as a disaster strikes
 2. Having a written public affairs emergency reaction plan
 3. Knowing how to communicate with Navy families
 4. Getting the most accurate and complete facts to the news media as quickly as possible
- 3-7. Because of the magnitude of the USS *Midway* fire, the OPREP-3 reporting system was used instead of the unit SITREP format.
1. True
 2. False
- 3-8. Recovery efforts during Hurricane Hugo were strengthened by the establishment of which of the following organizations?
1. Navy Family Information Center
 2. Green Cross Disaster Relief Center
 3. CHINFO Field Activity Center
 4. Charleston Disaster Assistance Center

- 3-9. Which of the following public affairs objectives must be met during an adverse news situation?
1. Preserving good community and media relations
 2. Retaining public confidence in the Navy
 3. Both 1 and 2 above
 4. Protecting military equipment and supplies
- 3-10. During a disaster situation, the public affairs office performs which of the following tasks?
1. Providing the news media with immediate, unlimited access to the disaster scene
 2. Providing possible causes of the disaster
 3. Both 1 and 2 above
 4. Safeguarding classified information and material
- 3-11. A command disaster plan should be issued in which of the following forms?
1. An official directive
 2. A CHINFO instruction
 3. An informal letter
 4. A memorandum for the record
- 3-12. The general responsibilities for public affairs office personnel during a disaster should be specified in which of the following documents?
1. A command disaster plan
 2. A public affairs office plan
 3. A qualifications file
 4. A training record
- 3-13. During a disaster, the public affairs office staff should have which of the following materials readily available?
1. *Public Affairs Communicator*
 2. The Navy Disaster Preparedness Manual, SECNAVINST 5720.35F
 3. Department of the Navy Information and Personnel Security Program Regulation (OPNAVINST 5510.1 series)
 4. Both 2 and 3 above
- 3-14. In most cases, the majority of the information appended to a public affairs office disaster plan falls into which of the following categories?
1. Detailed case studies on past disasters
 2. Sample releases on past disaster
 3. Policy materials
 4. Background materials
- 3-15. In making a functional telephone number checklist for use in a disaster situation, you should use which of the following systems?
1. Establish an alphabetical list
 2. List people by rank and billet
 3. Divide the list into meaningful categories
 4. Set up a chronological list
- 3-16. To make sure the CO is kept fully informed during a disaster situation, the PAO should establish which of the following provisions?
1. Set up a direct telephone line to the operations office
 2. Assign a staff member to deliver messages every half hour
 3. Make up forms to record the public affairs activities so a brief report may be made as often as necessary or requested
 4. Assign a JO to stand by in the CO's office during a disaster
- 3-17. A major disaster strikes your command. In the ensuing 15 minutes, you discover that you are in need of additional personnel to handle messenger and typist duties. You should get temporary staff members from which of the following sources?
1. CHINFO
 2. Other departments within the command
 3. Area coordinator
 4. The appropriate NAVINFO

- 3-18. All except which of the following are advantages of a CIB?
1. Reduction of inaccurate news by providing a single source of information
 2. Reduction of security violations
 3. Restriction of news flow to the media
 4. Restriction of news media to less reliable sources of information
- 3-19. What practice is usually required before disaster information is released to reporters?
1. Naming several officers to answer reporters' questions
 2. Referring reporters to either the officer in charge or the PAO
 3. Naming one official spokesman for the Navy to handle contracts with the public
 4. Naming the PAO on the staff of the naval district commandant where the disaster occurred to be an official spokesman
- 3-20. The individual selected as the official spokesman/release authority for disaster information should be identified in what document?
1. Command disaster plan
 2. Public affairs office disaster plan
 3. Unit SITREP
 4. CHINFO Report 5720-3
- 3-21. You are the assistant PAO of Naval Air Station Stimpson. The air operations officer calls to let you know a Navy C-9B Skytrain II burst into flames and crashed on takeoff. To gather as much information on the crash as possible, you should position members of your staff in which of the following locations?
1. The CO's office
 2. The legal office
 3. The accident scene or near it
 4. The nearest Navy Public Affairs Center
- 3-22. In a crisis or disaster situation, public affairs staff members should man the positions specified in which of the following document?
1. Command disaster plan
 2. Watch, Quarter and Station Bill
 3. Disaster checkoff list
 4. Disaster POA&M
- 3-23. To facilitate the dissemination of timely and accurate information in a crisis, you should designate a staff member to keep a running account of what information?
1. Queries received
 2. News release issue times
 3. OPREP-3s and unit SITREPS sent
 4. All of the above
- 3-24. The initial news release on an accident should be sent to the news media within what maximum amount of time?
1. 30 minutes
 2. 1 hour
 3. 45 minutes
 4. 2 hours
- 3-25. Which of the following information should be included in an initial news release on an accident?
1. The type of equipment involved, regardless of classification
 2. The possible causes of the accident
 3. The unclassified pertinent facts about the mission when the accident occurred
 4. The names and telephone numbers of command personnel involved in past accidents

- 3-26. If the public affairs office fully cooperates with the news media during a disaster, what will be the most likely result?
1. Reporters will report the facts objectively
 2. Reporters will report the facts accurately
 3. Both 1 and 2 above
 4. Reporters will look for secondary sources of information
- 3-27. When releasing information to the news media during a disaster situation, a PAO should make it a standard operating practice to take which of the following actions?
1. Check and recheck the facts
 2. Help the news media meet deadlines by providing damage estimates based on conjecture
 3. Release the names of personnel assisting in disaster relief operations
 4. Clear all facts with CHINFO before releasing them
- 3-28. Anticipating the needs of the news media by getting them the facts is known by what term?
1. Venture
 2. Adulation
 3. Initiative
 4. Control
- 3-29. The circumstances surrounding a disaster are often negative in connotation and sometimes painful for a PAO to admit. How should the PAO solve this problem when dealing with the news media?
1. Release only the facts favorable to the Navy and command
 2. Maintain complete honesty and candor
 3. Avoid talking to the news media
 4. Refuse to assist the news media in discovering the facts
- 3-30. If a PAO allows a reporter access to a disaster scene, which of the following actions should he take to maintain impartiality?
1. Ask the reporter allowed access to make his report available to all reporters
 2. Issue a press release on the access
 3. Make sure the reporter allowed access gives the story to a major wire service
 4. Allow similar access to all reports
- 3-31. When there are too many reporters at the scene of a big story, which of the following procedures should be used to gather information?
1. Request the reporters to pool certain information
 2. Allow all the reporters access to the scene
 3. Have one of your JOs write a news release
 4. Allow only wire service reporters access to the scene
- 3-32. Good taste in the release of information or photographs of a disaster is based on which of the following standards?
1. Personal evaluation
 2. The Associated Press code of ethics
 3. CHINFO regulations
 4. BUPERS regulations
- 3-33. Before briefing reporters at the CIB, either the senior JO or the PAO should take which of the following actions?
1. Request the assistance of the most senior PAO in the region
 2. Fax the proposed brief to CHINFO
 3. Prepare a list of contingency questions and answers for probable news media inquiries
 4. ask reporters to submit their questions in advance

- 3-34. Which of the following documents should you use to verify media credentials at the CIB?
1. Public affairs office recall bill
 2. Public affairs office listing of local media members
 3. Command disaster plan
 4. Command contingency POA&M
- 3-35. All of the following are legitimate media ground rules except which one?
1. Not physically disturbing parts of the accident scene before the investigators arrive
 2. Not wearing short-sleeved shirts to the accident scene
 3. Not interviewing injured personnel or their next of kin
 4. Not wandering from the designated access area to get additional information or photographs
- 3-36. When, if ever, may a reporter be excluded from visiting the scene of an accident on base?
1. When the reporter's experience level is in question
 2. When the public affairs office has had problem with the reporter's news organization
 3. When the reporter's presence would interfere with rescue, damage control or evacuation measures
 4. Never
- 3-37. A magazine photographer takes a picture of an accident scene that has exposed classified equipment. Which of the following actions should you take?
1. Take his film by force, if necessary
 2. Escort him to the on-scene PAO, where he will notify the reporter of Title 18 U.S. Code 793 (d), 795 and 797
 3. Do not tell him about the classified equipment and hope the photographs will not be used
 4. Tell him he will go to jail if the magazine publishes the photograph
- 3-38. Two photographers refuse to obey the ground rules established at the site of a Navy helicopter crash off-base. Classified material is present at the crash site. What action should you take?
1. Physically restrain the photographers with the aid of public affairs staff members
 2. Request the assistance of armed DoD or Navy security personnel
 3. Request the assistance of civilian law enforcement personnel
 4. Physically disable the photographers' camera equipment, then give them written procedures for reimbursement

- 3-39. Every effort is made to release the names of accident victims at a military command within CONUS concurrently with the announcement of the accident. This is done for which of the following reasons?
1. To notify the next of kin via the news media
 2. To alleviate undue anxiety for the relatives of other personnel in the involved unit
 3. To maintain a "high profile" in the news media
 4. To shift public attention from the possible cause of the accident to the personnel involved
- 3-40. A Navy plane crashes overseas, killing all aboard. The bodies are impossible to identify promptly. What is the policy on releasing a casualty list?
1. Release the names at once
 2. Release no names for 24 hours
 3. Seek approval of the Chief of Naval Personnel for release of a partial list
 4. Release a list of the ship's pilots and aircrewmembers not involved in the accident
- 3-41. Which of the following procedures is recommended to provide reporters with information that concerns a disaster involving highly technical equipment?
1. Explain the equipment to them in layman's terms
 2. Make available pertinent technical manuals
 3. See that a specialist is available to answer their questions
 4. Suggest that they interview the company officials who manufactured the equipment
- 3-42. In debriefing the survivor of a disaster, the public affairs representative should tell him to avoid making general statements about the disaster based on his or her own isolated experiences.
1. True
 2. False
- 3-43. Which of the following characteristics is typical of a Judge Advocate General (JAG) investigation?
1. Administrative
 2. Fact-finding
 3. Both 1 and 2 above
 4. Binding
- 3-44. For which of the following reasons should a command withhold information about an investigation?
1. When it involves an accident with 20 or more casualties
 2. When it is in progress
 3. Both 1 and 2 above
 4. When it covers a wide geographical area
- 3-45. The media, in most cases, must obtain copies of investigation reports by which of the following methods?
1. Writing a letter to the CO
 2. Writing a letter to CHINFO
 3. Filing a FOIA request
 4. Filing a request with the Navy Judge Advocate General's Office

- 3-46. What statement best describes a significant difference between the investigative reports the media receives and those Navy families receive?
1. The media reports contain more information than the reports to families
 2. The media reports contain autopsy information, the reports to families do not
 3. The reports to families contain photographs, while those to the media do not
 4. The reports to families contain more information than those to the media
- 3-47. A public affairs office can ease the anxiety of Navy family members during a disaster by performing which of the following functions?
1. Providing command brochures and fact sheets
 2. Providing the names of casualties as quickly as possible
 3. Providing toll-free telephone numbers that family members can call for more information
 4. Providing temporary living quarters on base
- 3-48. Which of the following instructions outlines the duties and responsibilities of the casualty assistance calls officer (CACO)?
1. NAVMILPERSCOMINST 1770 series
 2. OPNAVINST 1770 series
 3. SECNAVINST 5720.44A
 4. CHINFOINST 5720.90D
- 3-49. What should be your primary concern when you arrange media coverage of a military funeral?
1. Providing reporters with unlimited access at the grave site
 2. Researching and implementing strict ground rules
 3. Preserving the dignity of the event
 4. Providing interviews with the bereaved
- 3-50. Whert discussing media coverage arrangements with the CACO, you should cover which of the following points?
1. Location, timing and logistics concerns
 2. Media coverage plan
 3. Casket preparation
 4. All of the above
- 3-51. In a conversation with the CACO, you discover that the family of a deceased Navy man does not object to media coverage at the church. Before contacting the media, what further action, if any, should you take ?
1. Consult *PA Regs* for additional guidance
 2. Talk with the next of kin and determine what type of media coverage they desire
 3. Talk with church officials to determine their policy on media coverage
 4. None of the above
- 3-52. Before a disaster strikes, the PAO should discuss the available information channels with which of the following command family groups?
1. Command ombudsmen
 2. Officer's wives club
 3. CPO spouse support group
 4. All command family groups
- 3-53. What is the most important reason the PAO and senior journalist should provide accurate disaster information to families as quickly as possible?
1. To guard against the receipt of inaccurate media reports
 2. To prevent family members from causing a civil disturbance
 3. To fulfil the provisions of the DoD Family Information Act of 1974
 4. To promote the professionalism of the PAO and his staff

- 3-54. With the help of the PAO, a family member should establish which of the following precondition rights before granting a media interview?
1. Reviewing the entire interview on video or audio tape and edit as necessary
 2. Excluding the surname
 3. Selecting the most favorable camera angles
 4. Choosing another interviewer, if necessary
- 3-55. An explosion aboard a naval base claims the lives of three sailors. You should consider arranging a memorial service on base for which of the following reasons?
1. To provide maximum media coverage
 2. To streamline the execution of full military honors
 3. To strengthen the bond between the leadership of the command and its internal audience
 4. To uphold the privacy of the subsequent funeral
- 3-56. The memorial service plan should be distributed command wide in what format?
1. Instruction
 2. POA&M
 3. Notice
 4. Point paper
- 3-57. Which of the following individuals is usually responsible for providing the details of the memorial service schedule?
1. Senior chaplain
 2. PAO or senior journalism
 3. Officer in charge
 4. CACO
- 3-58. Which of the following individuals normally coordinates hearse and coffin flag arrangements for a memorial service?
1. PAO or senior journalist
 2. CACO
 3. Personnel officer
 4. Senior chaplain

ASSIGNMENT 4

Textbook Assignment: "The Command Information Bureau" and "Media Relations," page 3-1 through 4-10.

- 4-1. A CIB may be formed during which of the following events?
1. Training exercises
 2. Actual combat
 3. Serious incidents
 4. All of the above
- 4-2. An event involving the Navy and Air Force warrants the forming of a CIB. When this happens the CIB name is changed in what way?
1. To AIB
 2. To JIB
 3. To C/AFIB
 4. To NJIB
- 4-3. Which of the following is an important advantage of a basic CIB establishment plan?
1. Optimizing the use of the media
 2. Serving the information goals of the area coordinator
 3. Reducing the public affairs office response time
 4. Augmenting the staff of the C/AFIB
- 4-4. To manage CIB personnel and equipment in the most competent manner, what action should the senior journalist take?
1. Start the CIB in advance of the event
 2. Execute the CIB plan simultaneously with the CHINFO CIB plan
 3. Call the closest NAVINFO and get the latest personnel and equipment management guidance
 4. Review the latest issue of *Public Affairs Communicator* to get the most current CIB information
- 4-5. Which of the following individuals is normally designated as the CIB releasing authority?
1. CO
 2. XO
 3. PAO
 4. Senior JO
- 4-6. The CIB establishment plan is usually a part of which of the following documents?
1. The public affairs office disaster plan
 2. The Watch, Quarter and Station Bill
 3. The public affairs annex to the operations order
 4. The media relations plan
- 4-7. A sound CIB plan allows the public affairs office to be reactive rather than proactive.
1. True
 2. False
- 4-8. When selecting CIB operating methods, you should consider which of the following areas?
1. Public affairs theories
 2. CIB case studies
 3. Both 1 and 2 above
 4. Available public affairs resources
- 4-9. What CIB division handles media communications and messaging concerns?
1. Administrative support
 2. Liaison
 3. Media relations
 4. Media escort/briefing

- 4-10. A land-based unit associated with a CIB and which handles the distribution of news received from the CIB in the operational area is known by which of the following titles?
1. CIB wing
 2. Secondary CIB
 3. Sub-CIB
 4. CIB-Ashore
- 4-11. Every CIB staff member should be able to perform which of the following tasks?
1. Read and interpret classified operational information
 2. Complete sensitive tasks under pressure
 3. Deal with others in a polite and thoughtful manner
 4. Both 2 and 3 above
- 4-12. Which of the following is NOT a CIB personnel responsibility?
1. Escorting next of kin to the event sites or related areas
 2. Assisting the news media as directed by the CIB OIC
 3. Assisting in setting up interviews
 4. Maintaining the CIB for comfort, health and safety
- 4-13. At what point should you identify possible CIB locations?
1. At least two days before the establishment of the CIB
 2. Before the initial drafting of the CIB establishment plan
 3. During the initial drafting of the CIB establishment plan
 4. After the initial drafting of the CIB establishment plan
- 4-14. Which of the following locations is considered suitable for a CIB?
1. Recreation center
 2. Civilian apartment building
 3. Navy communications center
 4. BEQ
- 4-15. For which of the following reasons should the public affairs staff and civilian media have separate CIB work areas?
1. To maintain mutual privacy
 2. To prevent confrontations
 3. Both 1 and 2 above
 4. To alleviate tension between the two groups
- 4-16. Which of the following items should be a part of the CIB civilian media work space?
1. Crawling message sign
 2. Televisions
 3. Lockers
 4. Bulletin board
- 4-17. During a peacetime CIB, the public affairs office must supply the media with which, if any, of the following items?
1. Modems
 2. ENG equipment
 3. Portable laptop computers
 4. None of the above
- 4-18. For which of the following reasons should you include carbon paper and a manual impact key typewriter in the CIB "crash kit"?
1. They are inexpensive, nice to have items
 2. They will be in constant use by the CIB staff and the media
 3. They are excellent backups to copiers and computers/printers
 4. They will be used by computer-illiterate members of your staff

- 4-19. What statement best describes an important guideline regarding CIB military transportation support?
1. It may be provided if similar commercial transportation is available
 2. Ground vehicles must not be used under any circumstances
 3. Aircraft must not include those driven by propellers
 4. Ground vehicles must be able to transport heavy, cumbersome equipment
- 4-20. You are the assistant PAO of the USS *Hawaii Kai* (DDG 92). A reporter refuses to submit her story to you for review before it is transmitted using the communications system of the ship. What action should you take?
1. Reassure the reporter that the review is solely for security reasons, not censorship
 2. Reprimand the reporter and have her removed from the ship immediately
 3. Explain to the reporter that it is the CO's rule and it must be followed
 4. Call the XO and have him explain the situation
- 4-21. When, if ever, may the Navy provide civilian reporters with meals at a CIB?
1. When the meals are of the MRE variety
 2. When 10 or more reporters request the service
 3. When it is more beneficial to the Navy
 4. Never
- 4-22. Which of the following media pools is authorized the use of military billeting when civilian berthing is available?
1. NATO
 2. DoD
 3. UN
 4. UNITAS
- 4-23. A reporter asks you about receiving routine sick call treatment during CIB operations. The nearest civilian hospital is five hours away by car. What should you tell the reporter?
1. Sick call treatment is not available under any circumstances
 2. Sick call treatment is available only on a reimbursable basis
 3. Written permission from the unified commander must be obtained before sick call treatment can be received
 4. Sick call treatment may be provided and reimbursement is not required
- 4-24. All of the following are items that are part of the CIB media packet except which one?
1. Information on off-limits areas
 2. Discount coupons for the Navy Exchange
 3. Command policy statements
 4. Important telephone numbers
- 4-25. Which of the following individuals should normally receive top priority in a media pool?
1. United Press International photographer
 2. Local television cameraman
 3. ABC Radio reporter
 4. Daily newspaper color photographer
- 4-26. Media ground rules are given to reporters and photographers in what form?
1. Command notice
 2. Command instruction
 3. Written policy statement
 4. Oral notification

- 4-27. Before issuing a CIB credential to a free-lance reporter, you may check which of the following pieces of identification?
1. Shot record
 2. Visa
 3. Both 1 and 2 above
 4. CPR certification
- 4-28. After calling a newspaper to verify the employment of a reporter, you discover that she is an imposter. What action, if any, should you take?
1. Inform her of Title 18 U.S. Code 793 (d), 795 and 797
 2. Revoke her CIB credentials if issued, then immediately contact security personnel
 3. Give her limited CIB access to avoid any community relations repercussions
 4. None
- 4-29. Which of the following CIB registration forms should you draft with the aid of the command legal office?
1. Statement of charges
 2. Ground rules
 3. Both 1 and 2 above
 4. Waiver agreement
- 4-30. The media identification badges issued at the CIB should contain which of the following features?
1. A statement of indemnity
 2. A double-laminated exterior
 3. A photo of the reporter or photographer
 4. A statement that they are the property of the U.S. government
- 4-31. What is the most crucial element in successfully disseminating news to the media?
1. Flexibility
 2. Politeness
 3. Circumlocution
 4. Ambivalence
- 4-32. News briefings are normally held (a) how often, and (b) during what parts of the day?
1. (a) Twice daily
(b) morning and afternoon
 2. (a) Twice daily
(b) morning and evening
 3. (a) Three times daily
(b) morning, afternoon and evening
 4. (a) Four times daily
(b) two in the morning, two in the evening
- 4-33. What statement best describes the main difference between a news briefing and news conference?
1. A news briefing is used to update reporters formally on a particular situation while a news conference is used only as a last resort
 2. A news briefing is used only during operations and exercises while a news conference is used only during adverse news situations
 3. A news briefing is used to periodically update reporters on a situation while a news conference is irregularly held
 4. A news briefing is used to update reporters periodically on a situation while a news conference is authorized and scheduled only by ASD(PA)
- 4-34. During a news conference, the CO elects to provide reporters with information that may be used only when no harm can result from its release. What type of briefing is this called?
1. Background
 2. Off-the-record
 3. Procedural
 4. Elective

- 4-35. Because reporters in the CIB share the same information, personal, one-on-one interviews should be arranged when requested to allow more complete, credible and varied reporting.
1. True
 2. False
- 4-36. What should be the main goal of news releases produced by CIB staff members?
1. To complement the stories produced by the news media
 2. To provide a hard-sell pitch for the Navy
 3. To compete directly with news media stories
 4. To tell the story from the media's point of view
- 4-37. Navy produced photographs available for media use should be in which of the following formats?
1. 5 by 7 and 8 by 10 inches
 2. 4 by 5 and 8 by 10 inches
 3. 8 by 10 and 11 by 14 inches
 4. 5 by 7 and 4 by 5 inches
- 4-38. What is the preferred location for the videotape platform in the CIB conference room?
1. The immediate left of the lectern
 2. The immediate right of the lectern
 3. At the rear of the conference room
 4. In the middle of the conference room
- 4-39. Which of the following methods is recommended when you write the CIB after-action report?
1. Conduct an in-depth interview with the CO and get his impressions
 2. Follow the guidance in *PA Regs*, appendix C
 3. Review and evaluate each section of the CIB establishment plan
 4. Schedule a training session and evaluate the CIB with your staff
- 4-40. The job of communicating the Navy's message to the public is demanding because of which of the following trends?
1. Fewer Americans have had firsthand military experience than in previous years
 2. More Americans are illiterate than ever before
 3. Fewer Americans are in tune with the mass media than in the 1960s
 4. More Americans harbor antimilitary sentiments than ever before
- 4-41. The senior journalist and PAO can educate the new generation of reporters and the public in which of the following ways?
1. By learning to communicate more effectively
 2. By opening a dialogue with the news media
 3. Both 1 and 2 above
 4. By communicating more effectively with the internal audience

4-42. Which of the following statements best describes the effect of the news media on the American public?

1. The news media "war of words" eventually leads to civil turmoil
2. The thought process of the public is influenced, in large part, by what is being said in the news media
3. The off-duty activities of media employees have a profound effect on the youth of America
4. The day-to-day actions of the news media are often viewed with contempt by the American public

- A. Magazine
- B. Newspaper
- C. Television
- D. News service
- E. Radio
- F. Syndicates

Figure 1

IN ANSWERING QUESTIONS 4-43 THROUGH 4-50, SELECT THE NEWS MEDIUM IN FIGURE 1 THAT FITS THE DESCRIPTION USED AS THE QUESTION. RESPONSES IN FIGURE 1 MAY BE USED MORE THAN ONCE.

4-43. The oldest form of mass communication

1. B
2. C
3. D
4. F

4-44. Among its advantages are variety, mobility and immediacy:

1. A
2. D
3. E
4. F

4-45. Provides in-depth stories that amplify wire service spot-news stories:

1. B
2. C
3. D
4. F

4-46. Usually grouped as consumer, news or internal/promotional:

1. A
2. B
3. C
4. F

4-47. Provides the mass media with coverage they cannot afford to get by any other means:

1. A
2. C
3. D
4. E

4-48. The newest and most powerful of the mass communications media:

1. C
2. D
3. E
4. F

4-49. Offers coverage in greater depth than broadcast or pictorial media:

1. A
2. B
3. D
4. E

4-50. An informal, intimate and timely medium:

1. A
2. B
3. E
4. F

- 4-51. You are tasked with assisting an author who is writing a book about your command. The author asks you for information and materials that go beyond the scope of your regular press kit information. What should you tell him?
1. You have to get further guidance from the PAO
 2. You will not be able to accommodate his request for further information
 3. You have to get further-guidance from CHINFO
 4. You have to call the area coordinator and get permission to provide more information
- 4-52. A reporter looks for a story that will help him earn professional acclaim and praise. This is known as what type of journalism?
1. Prize
 2. Pack
 3. Hitchhiker
 4. checkbook
- 4-53. What can the senior journalist and PAO do to help inexperienced reporters understand Navy phrases and terminology?
1. Review the phrases and terminology with the reporter's supervisor
 2. Translate the phrases and terminology into civilian terms, when possible
 3. Ask thee reporter to read *PA Regs* before seeking any information
 4. Both 2 and 3 above
- 4-54. In a "mob" journalism situation, the senior journalist should be pugnacious and defend the command and Navy at all costs.
1. True
 2. False
- 4-55. All except which of the following media-related functions are performed by the senior JO and PAO?
1. Arranging interviews
 2. Reviewing and editing all media products
 3. Researching the interview issues
 4. Researching the backgrounds of reporters and news organizations
- 4-56. Which of the following public communication strategies should be the goal of every public affairs office?
1. Reactive
 2. Winging it
 3. Both 1 and 2 above
 4. Proactive
- 4-57. Before releasing news to the media, the PAO must balance each release between (a) what principle and (b) what considerations?
1. (a) Limited disclosure
(b) accuracy, security and objectivity
 2. (a) Maximum disclosure with moderate delay
(b) security, accuracy, strategy and propriety
 3. (a) Maximum disclosure with minimum delay
(b) security, accuracy, propriety and policy
 4. (a) Restricted disclosure
(b) accuracy, brevity, clarity and propriety
- 4-58. Upon completing a news release, you realize your command may not have the authority to release the information. What should you do?
1. Seek the advice from the PAO in the next highest command in the chain
 2. Send the release with a cover letter to CHINFO
 3. Call the nearest NAVPACEN for advice
 4. Ask the CO for permission to release the information

- 4-59. What is the main advantage of the news release?
1. Reliability
 2. Low cost
 3. Acceptability
 4. High volume
- 4-60. When producing a news release, you should avoid which of the following practices?
1. Triple-spacing the copy
 2. Noting the preferred release method
 3. Using a preprinted form
 4. Writing more than one page
- 4-61. What is the main purpose of a news advisory?
1. To keep CHINFO informed of important newsworthy events
 2. To inform the appropriate NAVINFO about a possible marketing opportunity
 3. To inform the media about a particular event and invite coverage
 4. To provide the media with follow-up information on an accident or incident
- 4-62. The oral release of information to the media should be made in which of the following ways?
1. In person only, reading from a prepared text
 2. By telephone only, reading from a command directive
 3. In person or by telephone, reading from a prepared text
 4. By audio or video tape, reading from a command directive
- 4-63. A query sheet should include which of the following item of information?
1. The home address of the reporter
 2. The source of information and coordination
 3. The latest chain of command flow chart
 4. The home telephone number of the reporter

- 4-64. A reporter wants to interview the CO to get his views on preventing sexual harassment in the Navy. Before the interview takes place, what action should you and the PAO take?
1. Get the reporter's questions in advance and submit them to the CO for approval
 2. Set up a mock interview with the PAO acting as the reporter
 3. Give the reporter the CO's views in the form of a news release
 4. Discuss the interview with the CO and reporter before it takes place

- A. On-the-record
- B. Off-the-record
- C. Background/not for attribution
- D. Deep background

Figure 2

IN ANSWERING QUESTIONS 4-65 THROUGH 4-69, SELECT THE GROUND RULE IN FIGURE 2 THAT FITS THE DESCRIPTION USED AS THE QUESTION. RESPONSES IN FIGURE 2 MAY BE USED MORE THAN ONCE.

- 4-65. No source is revealed, but the reporter may use the information:
1. A
 2. B
 3. C
 4. D
- 4-66. Information that must not be printed under any circumstance or in any form:
1. A
 2. B
 3. C
 4. D

- 4-67. The source can be identified in general terms:
1. A
 2. B
 3. C
 4. D
- 4-68. The interviewee may be identified by name and title:
1. A
 2. B
 3. C
 4. D
- 4-69. The ground rule that should be avoided as often as possible:
1. A
 2. B
 3. C
 4. D
- 4-70. Following a serious accident aboard your naval station, you recommend to the CO that he make a short statement to the media and answer a few questions. The CO can take advantage of this opportunity to accomplish which of the following tasks?
1. Provide an educated guess on the cause of the accident
 2. Inform the next of kin of fatalities
 3. Reassure family members that the CO is in charge and he is doing all he can
 4. Tell the media and family members that the person(s) responsible for the accident will be dealt with accordingly
- 4-71. Which of the following rules must be followed before you or the PAO grant a general interview?
1. The interviewee must have had previous media exposure
 2. The CO or XO must monitor the interview for security and policy violations
 3. The PAO must screen the questions 24 hours before the interview
 4. The subject matter of the interview must correspond with the interviewee's position of responsibility
- 4-72. The talk show interview, in most cases, centers on what facet of the interviewee?
1. Professional experience
 2. Personality
 3. Personal views on hard news issues
 4. Management abilities
- 4-73. Your CO anticipates being the subject of an ambush style interview when he leaves his home this morning. What comment, if any, should the CO give to the waiting reporters?
1. "I am sorry, I do not have the time to talk to you"
 2. "You have no right to be here: please leave before I call the police"
 3. "My PAO can answer all of your questions"
 4. None
- 4-74. From the interviewee's perspective, what is the primary disadvantage of the remote interview?
1. The confusion caused by audio feedback in the earplug
 2. The distraction caused by the large bank of monitors needed to conduct the interview
 3. The confusion caused by the floor director's hand signals
 4. The distraction caused by the studio audience

ASSIGNMENT 5

Textbook Assignment: "Media Relations" and "Community Relations and Special Events," pages 4-11 through 5-17.

- 5-1. LCDR Excelsis is scheduled for an interview at a local television studio. Which of the following uniforms should she wear during the interview?
1. Full dress white
 2. Summer khaki
 3. Winter blue alpha
 4. Service dress blue
- 5-2. LCDR Excelsis's television interview site has been changed to her office space aboard ship. In this case, which of the following uniforms is considered appropriate?
1. Winter blue bravo
 2. Full dress white
 3. Winter working blue bravo
 4. Uniform of the day
- 5-3. When, if ever, should an interviewee maintain eye contact with the camera?
1. When the station uses the remote interview format
 2. When the interviewee is uncomfortable with the reporter
 3. When the station uses the ambush interview format
 4. Never
- 5-4. During a live television interview, the interviewer sets up a question by using grossly incorrect data about your command. What should the interviewee do?
1. Demand an immediate retraction
 2. Tactfully correct the interviewer
 3. Politely ask the interviewer to reveal the source of the data
 4. Politely ask the interviewer to go to the next question
- 5-5. Which of the following actions should you avoid during a television interview?
1. Engaging in foot tapping or finger drumming
 2. Assuming you are on the air at all times
 3. Maintaining a positive attitude
 4. Using humor when appropriate
- 5-6. Which of the following individuals is usually the center of attention at a news conference?
1. The senior JO
 2. The PAO
 3. The XO
 4. The CO
- 5-7. Preparing an individual for a news conference is best accomplished by using what method?
1. Holding a formal command meeting attended by senior personnel
 2. Conducting a "murder board"
 3. Holding training using *PA Regs* as the primary guide
 4. Conducting a mock news conference using easy-to-answer questions
- 5-8. When you select the location of a press conference, what are the two primary concerns?
1. Availability and accessibility
 2. Aesthetics and availability
 3. Operational security and availability
 4. Accessibility and operational security

- 5-9. When selecting the visual background for a news conference, you should follow which of the following rules?
1. Choose colors with geometric patterns for the best visual effect
 2. Choose materials that reflect light and are the same colors as Navy uniforms
 3. Choose colors that contrast favorably with Navy uniforms and avoid distracting backgrounds
 4. Choose materials that have been preapproved by CHINFO and avoid geometric patterns
- 5-10. Which of the following individuals usually assumes the role of news conference moderator?
1. The senior JO
 2. The PAO
 3. The CO
 4. The area coordinator
- 5-11. The news conference moderator is usually responsible for all except which of the following tasks?
1. Establishing ground rules
 2. Closing the news conference
 3. Making the principal statement
 4. Conducting the question and answer period
- 5-12. Embarks involving national media must be approved by what individual?
1. CHINFO
 2. SECNAV
 3. CNO
 4. ACNO (Undersea Warfare)
- 5-13. The purpose of the media embark predeparture briefing is to allow reporters to do which of the following things?
1. Meet the CO and other important people
 2. Get answers to preliminary questions
 3. Both 1 and 2 above
 4. Obtain basic knowledge of damage control equipment
- 5-14. Justin Case, a local newspaper reporter and a retired JO1, is embarked aboard your ship. If feasible, he should receive the same wardroom and berthing privileges given to what naval officer?
1. Lieutenant
 2. Lieutenant commander
 3. Commander
 4. Captain
- 5-15. What method is the most effective to inform the crew about a media embark?
1. Word-of-mouth
 2. IMC
 3. Quarters
 4. Plan of the Day
- 5-16. A JO1 decides to market a story to several publications not officially affiliated with the Navy. Before mailing the story, he should take what action, if any?
1. Chop the story through the most senior PAO in the region
 2. Coordinate the release with the nearest NAVINFO
 3. Call the CHINFO media relations division for detailed guidance
 4. None

- 5-17. Which of the following functions is NOT performed by the six NAVINFOS?
1. Supplying print and broadcast features to internal command media
 2. Providing videotapes and graphics to the media
 3. Arranging media visits to ships and stations
 4. Providing research assistance to the media
- 5-18. NAVPACENs in Norfolk and San Diego place special emphasis on marketing (a) what type of story to (b) what specific medium?
1. (a) Expanded hard news
(b) wire services
 2. (a) Extended human interest
(b) newspapers
 3. (a) Expanded photo features
(b) hometown newspapers
 4. (a) Extended sports
(b) television stations
- 5-19. Which, if any, of the following stories will *All Hands* accept from the fleet?
1. Reenlistment
 2. Homeowner
 3. Change of command
 4. None of the above
- 5-20. During a conflict or war, tension between the Navy and the media can result from the Navy's taking which of the following actions?
1. Restricting information because of security considerations
 2. Releasing too much information at one time because of propriety concerns
 3. Releasing too much follow-up information on generic topics
 4. Restricting informations because of policy restrictions
- 5-21. The size of a news media pool is normally determined by which of the following factors?
1. The size of the event and the availability of host unit billeting
 2. The accessibility of area coordinator funds and the availability of host unit billeting
 3. The number of available seats and baggage capacity of ground or air transportation, and the availability of host unit billeting
 4. The size of the event and the availability of the host unit ground or air transportation
- 5-22. The movements of all reporters and photographers in a media pool must be controlled tightly so that all information is accessed fairly.
1. True
 2. False
- 5-23. Establishing credibility with the media can be done in which of the following ways?
1. By getting to know the reporters personally and winning their confidence
 2. By attending the same social functions as reporters
 3. By knowing the command and Navy public affairs inside and out
 4. By being firm but fair in your news dissemination approach
- 5-24. In dealing with the media, the senior 30 should meet all except which of the following conditions?
1. Being available at all hours
 2. Answering a reporter's question with speculation
 3. Knowing the individuals who work in the media
 4. Telling the truth at all times

- 5-25. What is the basis of a good community relations (COMREL) program?
1. Frequent and interesting releases to the media
 2. A good CO and PAO
 3. Participation by Navy personnel in community affairs
 4. A good command with concern for community welfare and a program designed to earn public acceptance
- 5-26. Normally, a CO delegates the responsibility for planning and maintaining a community relations program to which of the following individuals?
1. The XO
 2. The operations officer
 3. The family services officer
 4. The PAO
- 5-27. Which of the following is NOT an objective of a community relations program?
1. To earn public acceptance and understanding
 2. To evaluate public attitudes
 3. To separate community relations from public affairs
 4. To identify the military mission with the public interest
- 5-28. Civilian companies which are understood and accepted by a community have identified practices that tend to assure effective community relations. Which of the following is NOT included among these practices?
1. Behaving like a good neighbor
 2. Telling the community about itself
 3. Maintaining a modest and reserved attitude about its value to the community
 4. Telling its employees about the planned community relations program it has
- 5-29. In what way can the Navy benefit from a good community relations program?
1. Better recruiting
 2. Higher esteem in the community where Navy personnel live and work
 3. Increased support for the Navy's mission
 4. All of the above
- 5-30. Planning and implementing the DoD community relations program are responsibilities delegated to which of the following individuals?
1. SECDEF
 2. ASD(PA)
 3. CHINFO
 4. DIRPA
- 5-31. The responsibility of putting positive emphasis on the importance of good community relations in the execution of his mission belongs to which of the following individuals?
1. PAO
 2. XO
 3. CO
 4. All of the above
- 5-32. Which of the following groups is an external public in a community relations program?
1. Families of U.S. Naval Academy midshipmen
 2. Retired Navy personnel
 3. Career civilian employees of the Navy
 4. Members of Congress
- 5-33. The namesake ship program is designed to generate positive community relations at which of the following levels?
1. State
 2. National
 3. Both 1 and 2 above
 4. International

- 5-34. The base-community council should include which of the following individuals in its membership?
1. Interested citizens
 2. Key civic leaders
 3. Senior command petty officers
 4. Public affairs office staff personnel
- 5-35. Which of the following complaints can be classed as requiring remedial action?
1. Navy personnel are unable to receive adequate services in the local community
 2. Prices of commodities in the local community are too high for Navy personnel
 3. Navy drivers fail to heed a special speed zone near an elementary school
 4. Housing for Navy personnel in the local community is inadequate
- 5-36. A remedial community relations program is often referred to as a "fire prevention" program.
1. True
 2. False
- 5-37. Basic DoD community relations policy is contained in which of the following DoD directives?
1. 5410.18
 2. 5320.44A
 3. 5400.19
 4. 5411.18
- 5-38. Policies for planning and conducting Navy community relations programs and rating participating in public events are based on which of the following factors?
1. Practical experience
 2. Executive order
 3. Public law
 4. Each of the above
- 5-39. Establishing policy on military participation in public events is determined by all except which of the following factors?
1. Practical experience
 2. Public law
 3. Educational level
 4. Navy regulations
- 5-40. When, if ever, may a Navy command endorse a specific religious group as part of a community relations program?
1. When the religious group is represented in the base-community council
 2. When key command personnel are affiliated with the religious group
 3. When an in-depth evaluation reveals that endorsement is in the best interest of the command
 4. Never
- 5-41. Which of the following is NOT one of the four basic stages. in developing a community relations program?
1. Funding
 2. Fact finding
 3. Communication
 4. Evaluation
- 5-42. Common interests between a command and the local community can be identified by using which of the following processes?
1. Communication
 2. Evaluation
 3. Fact finding
 4. Funding

- 5-43. The disorderly conduct of Naval Air Station Foley personnel while on liberty in town causes tension between the command and the local community. If the PAO ignores this problem, which of the following results is likely to occur?
1. Mass civil unrest
 2. Antimilitary demonstrations
 3. Congressional action
 4. Both 2 and 3 above
- 5-44. Which of the following community-provided amenities is/are most important to Navy personnel and their dependents?
1. Abundant goods and services
 2. Adequate, reasonably priced housing
 3. Low-cost public transportation
 4. Plentiful, reasonably priced restaurants and bars
- 5-45. Which of the following community power structures is the easiest to determine?
1. Formal political
 2. Economic
 3. Social
 4. Both 2 and 3 above
- 5-46. Which of the following groups is NOT considered a type of leader in the informal power structure of a local community?
1. Decision makers
 2. Influential
 3. Elected officials
 4. Opinion leaders
- 5-47. What will probably be your most feasible source of information about the attitudes of local citizens toward a naval air station and how these attitudes are formed?
1. An attitude survey constructed by the public affairs staff
 2. A professional survey constructed by CHINFO
 3. A detailed examination of a variety of published materials
 4. An interview with the opinion leaders for information
- 5-48. You should give special attention to spotting existing and potential problems in community relations by taking which of the following actions?
1. Reviewing correspondence from time to time
 2. Noting remarks made in formal and informal contacts with local civilians
 3. Noting remarks made in staff meetings
 4. All of the above
- 5-49. You should establish a community survey file in the COMREL section of the public affairs office for which of the following reasons?
1. To provide the CO with detailed community demographic information
 2. To provide community information used daily by the public affairs office staff
 3. To provide important community information to newly reporting officers and their families
 4. To provide community information needed by the media during visits and embarks
- 5-50. In an overseas location, the community survey file of a command should be developed with the assistance of which of the following organizations?
1. Department of Overseas affairs
 2. Department of Foreign Relations
 3. U.S. Information Service
 4. U.S. Government Information Agency
- 5-51. In reviewing your community survey file, you discover it is grossly out of date. You may update your file by conducting research in which of the following locations?
1. Local chamber of commerce
 2. City comptroller's office
 3. Both 1 and 2 above
 4. City tourism office

- 5-52. After the PAO and his staff have collected all the essential information about a community, what is the next step in developing a community relations program?
1. To analyze the data for meaning and relevance
 2. To make the data available for use in speeches and reports
 3. To formulate the objectives of the community relations program
 4. To formulate courses of action to take to carry out the program
- 5-53. Before you plan a special event in a very conservative South Florida community, you should examine which of the following community segments?
1. Peculiarities of local dress
 2. Level of public interest in education and the arts
 3. Acceptance of the Navy
 4. All of the above
- 5-54. What factor is recommended the most to motivate interaction between a Navy base and the community?
1. Declaration of the internal budgetary situation of the base
 2. Determination of the on-base jobs filled by local civilians
 3. Recognition of the mutual interests between the base and the community
 4. Recognition of those individuals involvd in past community relations programs
- 5-55. In evaluating your community relations efforts, you should take which of the following actions?
1. Get acquainted with the public affairs staffs of area military organizations
 2. Learn the chain of command of the local government
 3. Both 1 and 2 above
 4. Gain an understanding of tile departments and functions of the base-community council
- 5-56. The first draft of a proposed community relations program should cover all except which of the following areas?
1. Specific base-community council assignments made by the CO and PAO
 2. A statement of objectives with a tentative schedule of activities and projects
 3. A statement of policy based on guidelines from higher authority
 4. Specific delegations of authority for community relations activities
- 5-57. Assume you are working in a relatively small public affairs office with insufficient resources to conduct a full-scale community relations program. You should start with which of the following program elements?
1. A practical station newspaper and a speakers bureau
 2. An aggressive public visitation program
 3. A functional station library
 4. All of the above
- 5-58. What is the goal of the "communication" segment of community relations program development?
1. To reach as many publics as possible
 2. To give a complete picture of the Plan to all Navy personnel in the command
 3. To explain the plan to those who are affected and whose help is essential
 4. To get criticism and suggestions from all hands before a program is put into operation

- 5-59. Before the draft of a proposed community relations program is submitted to the commander or CO for approval, it should be reviewed by which of the following individuals?
1. Chief of staff or XO
 2. Operations or administrative officers
 3. Flag secretary or administrative officer
 4. Senior PAO in the area or his assistant
- 5-60. After a community relations program is officially adopted, you should make it a team effort by taking which of the following actions?
1. Giving the basic program information and the reasons behind it to all command members
 2. Asking the CO to explain the program to all command personnel assigned to the base-community council
 3. Both a 1 and 2 above
 4. Giving the basic program information and the reasons behind it to all department heads and division officers
- 5-61. You can select the proper communication channel to reach a specific public in your community by taking which of the following actions?
1. Asking the local newspaper publisher
 2. Asking the president of the local chamber of commerce
 3. Looking up the facts you collected and analyzed in your community survey
 4. Researching the available communication channels in the local press register
- 5-62. Evaluating, the final segment in community relations program development, ties back to what other segment, if any?
1. Planning
 2. Communicating
 3. Fact finding
 4. None
- 5-63. Evaluating should accomplish which of the following goals?
1. Measure results against objectives
 2. Measure results against the past histories of community relations programs
 3. Measure successes against failures
 4. Measure weak spots against strengths
- 5-64. A special event, from the public affairs point of view, may be characterized in which of the following ways?
1. As an official ceremony
 2. As planned news for a specific purpose
 3. As an adverse incident reported according to prescribed standards
 4. As an event conducted to benefit the community
- 5-65. Special events in which Navy participation is authorized are described in which of the following references?
1. *Navy Regulations*
 2. *PA Regs*
 3. *BUPERS Manual*
 4. *Special Event Manual*
- 5-66. A military flyover in the public domain must be approved by which of the following individuals?
1. CHINFO
 2. CNO
 3. SECNAV
 4. ASC(PA)

A.	Internal
B.	Community
C.	Regional, National and International
D.	Special

Figure 1

IN ANSWERING QUESTIONS 5-67 THROUGH 5-73, SELECT THE PUBLIC IN FIGURE 1 THAT FITS THE SPECIAL EVENT DESCRIPTION USED AS THE QUESTION. RESPONSES IN FIGURE 1 MAY BE USED MORE THAN ONCE.

5-67. An awards ceremony at the base:

- 1. A
- 2. B
- 3. C
- 4. D

5-68. A program conducted for the Navy League:

- 1. A
- 2. B
- 3. C
- 4. D

5-69. Navy participation in a parade:

- 1. A
- 2. B
- 3. C
- 4. D

5-70. A launching ceremony of a ship:

- 1. A
- 2. B
- 3. C
- 4. D

5-71. An allied exercise:

- 1. A
- 2. B
- 3. C
- 4. D

5-72. A demonstration at a conference of oceanographers:

- 1. A
- 2. B
- 3. C
- 4. D

5-73. A dedication of a new building on base:

- 1. A
- 2. B
- 3. C
- 4. D

5-74. Under which of the following circumstances would operational plans be modified in favor of public affairs objectives?

- 1. When a guest cruise is being combined with a training exercise
- 2. When a fleet exercise is being combined with a demonstration for VIP civilians
- 3. Where a U.S. Senator desires to attend an awards ceremony aboard a destroyer
- 4. When a U.S. Representative has asked for Navy participation in a Fourth of July parade

5-75. What is the first step in planning a special event?

- 1. Considering the facilities you have at your disposal
- 2. Deciding what you are going to do and why
- 3. Determining the logistic support available
- 4. Deciding how you will supervise the event

ASSIGNMENT 6

Textbook Assignment: "Community Relations and Special Events" and "Speeches," pages 5-18 through 6-21.

- 6-1. When you review your special event objectives and personnel requirements, what is the most important factor?
1. Attention to detail
 2. Impact of the event
 3. Military protocol
 4. Objectivity
- 6-2. When a major event is held ashore, how many command directives would probably be necessary to cover all the details, including public affairs, security and logistics?
1. One
 2. Two
 3. Three
 4. Four
- 6-3. A special event evaluation report is NOT required when which of the following conditions exist?
1. The special event involves 500 people or less
 2. The report is obviously unnecessary
 3. The report cannot be completed because of time and budgetary constraints
 4. The special events section of the base-community council does not require it
- 6-4. In planning for a major event, the PAO will have to make all except which of the following decisions?
1. Where the event will occur
 2. What the program will be
 3. The order of events
 4. The guest list
- 6-5. To make sure all necessary arrangements for a major special event are in place, you should take which of the following actions?
1. Draft a command directive that names a coordinator and assigns tasks to appropriate subordinate commands or staff members
 2. Request the commander to appoint suitable assistants for the event and make it a matter of record in the special events file
 3. Request that public affairs personnel from nearby commands be ordered TAD to your command
 4. Request that the commander make the major arrangements himself while you attend to the needs of the media and internal community
- 6-6. A special event is scheduled at your command in two weeks. What is the best way to tell media members they are welcome to cover the event?
1. Prepare and distribute an advance news release
 2. Prepare and distribute a news advisory
 3. Both 1 and 2 above
 4. Arrange an advance media availability
- 6-7. In planning a special event, you should coordinate the electronic media power requirements with which of the following officers?
1. Public works
 2. Operations
 3. Safety
 4. Security

- 6-8. The decision of whether to formulate a media pool during a special event depends upon which of the following factors?
1. The types of media covering the event
 2. The experience level of the reporters or photographers
 3. The length of the event
 4. The nature of the ceremony
- 6-9. Media members covering a special event will most likely require which of the following services?
1. Access to food and beverages
 2. Use of command audiovisual equipment
 3. Both 1 and 2 above
 4. Access to telephones
- 6-10. To prevent security violations, you should issue parking authorizations to media representatives as they file through the main gate.
1. True
 2. False
- 6-11. A group of guests is visiting your naval station. You should keep the group organized with regard to billeting and transportation arrangements by what means?
1. Using separate colors for identification on name tags, signs and baggage
 2. Assigning a trained guide to each guest
 3. Giving each guest a list of all members in the group
 4. Dividing the group into subgroups according to age, then assign alphanumeric identification tags to each member
- 6-12. Guests should wear identification tags on their right lapels for which of the following reasons?
1. It is a long-standing Navy tradition
 2. It allows the tags to be read easily when guests shake hands
 3. It is required by CHINFO
 4. It is required by PA Regs
- 6-13. What is the main purpose of a pamphlet designed for guests visiting your command?
1. Entertainment
 2. Information
 3. Identification
 4. Both 2 and 3 above
- 6-14. All of the following are considered appropriate ship/station guest souvenirs except which one?
1. Photograph signed by the CO
 2. Ball cap
 3. Paperweight made from scrap material
 4. Command plaque
- 6-15. From the Navy's point of view, what is the main purpose for naval personnel to give a speech?
1. To transmit a Navy message to a few influential people
 2. To transmit a Navy message to the largest number of influential people
 3. To promote a political viewpoint that will increase congressional support for additional Navy funds
 4. To earn money from speaking engagements for the recreation fund
- 6-16. Under DoD guidelines, a PAO would disapprove a request for a speaker for which of the following events?
1. A local Boy Scout jamboree
 2. A monthly chamber of commerce meeting
 3. A Republican state convention
 4. An American Legion convention

6-17. DoD policy prohibits Navy speakers from appearing at which if the following events?

1. A convention open to members of the press
2. A meeting where communists may be present
3. A religious assembly
4. A meeting barred to anyone because of race

6-18. Which of the following speech-related jobs would a senior journalist be required to do?

1. Write a speech for another person to deliver
2. Arrange a speaking engagement
3. Give an informal speech when necessary
4. All of the above

6-19. A speech to be delivered by a senior Navy official must receive a security and policy review by whom?

1. CHINFO
2. CNO
3. ASO(PA)
4. SECDEF

6-20. Which of the following approaches are NOT normally associated with a goodwill speech?

1. Service to the community
2. Historic
3. Assurance
4. Organization and operation

6-21. To reinforce the bonds between your command and the local community, you should offer which of the following services to the audience of a goodwill speech?

1. Money to assist the indigent
2. Personnel to assist in city approved public works projects
3. Speakers to make future presentations
4. Both 2 and 3 above

6-22. What is usually the purpose of a speech delivered by a Navy speaker during Armed Forces Day?

1. Stimulation
2. Actuation
3. Entertainment
4. Information

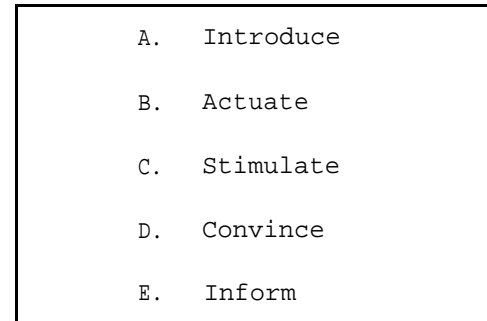

Figure 1

IN ANSWERING QUESTIONS 6-23 THROUGH 6-27, SELECT THE SPEECH CLASSIFICATION IN FIGURE 1 THAT FITS THE DESCRIPTION USED AS THE QUESTION.

6-23. Arouses interest in the speaker:

1. A
2. B
3. C
4. D

6-24. Uses evidence to sway the intellectual attitude of an audience:

1. A
2. B
3. C
4. E

6-25. Broadens knowledge in a particular subject:

1. B
2. C
3. D
4. E

6-26. Stimulates an observable action:

1. A
2. B
3. C
4. D

- 6-27. Arouses feelings of admiration or respect:
1. B
 2. C
 3. D
 4. E
- 6-28. Which of the following speech delivery methods is completely unplanned?
1. Extemporaneous
 2. Memorization
 3. Manuscript
 4. Impromptu
- 6-29. A speech incorporating the manuscript delivery method is considered appropriate in which of the following situations?
1. When the speech deals with the speaker's opinions and ideals
 2. When the speech involves sensitive security or policy issues
 3. When the person delivering the speech is a neophyte public speaker
 4. When it is determined by audience research
- 6-30. A speaker's credibility may be in question if he uses which of the following speech delivery methods?
1. Memorization
 2. Extemporaneous
 3. Manuscript
 4. Impromptu
- 6-31. The extemporaneous speech delivery method is most accurately described by what statement?
1. It is a stilted method that should be used only when the subject deals with sensitive naval issues
 2. It often results in an unnatural, inflexible presentation and should be avoided at all costs
 3. It is based on a key-word outline, allowing the speaker to adapt the talk to the situation
 4. It is an off the cuff method based on the memorization of a manuscript
- 6-32. which of the following techniques is the most desirable when you begin a speech?
1. Encouraging questions from the audience
 2. Telling the audience you are nervous and appreciate their compassion
 3. Posing one or two questions to the audience
 4. Using a quotation that directly relates to the subject of the speech
- 6-33. The entertainment value of a humorous anecdote in a speech is more important than its relation to the topic.
1. True
 2. False
- 6-34. Which of the following is NOT an example of a rhetorical question for a speech?
1. What can we do about inflation?
 2. Can you see the graph in the back of the room?
 3. Is the military-industrial complex really complex?
 4. Why is there air?

- 6-35. The use of striking facts or statistics at the start of a speech is designed to get the audience to do which of the following things?
1. Prepare for a set of rhetorical questions
 2. Anticipate elaboration by the speaker
 3. Experience a feeling of awe
 4. Each of the above

A.	What
B.	Why
C.	How
D.	How to

Figure 2

- 6-36. What is the limited objective step in the introductory portion of a Speech?

1. A one-sentence statement of what you will talk about
2. A general statement of the purpose of the speech
3. A short statement that describes the importance of your speech to the audience
4. A statement designed to hold the attention of the audience through the remainder of your speech

- 6-37. Which of the following skills is basic to motivating an audience to listen to a speech?

1. Convincing them that you are a good speaker
2. Selecting a good attention-getter
3. Persuading them that your message is beneficial to them
4. Having an appealing introduction to the speech

- 6-38. Which of the following techniques can help you select a good appeal to motivate an audience?

1. Analyzing your audience
2. Developing an innovative attention step
3. Combining an innovative attention step with the impromptu speech delivery method
4. All of the above

IN ANSWERING QUESTIONS 6-39 THROUGH 6-43, SELECT THE SPEECH EXPLANATION APPROACH IN FIGURE 2 THAT FITS THE DESCRIPTION USED AS THE QUESTION. RESPONSES IN FIGURE 2 MAY BE USED MORE THAN ONCE.

- 6-39. Used to state the way in which a main point will accomplish an objective:

1. A
2. B
3. C
4. D

- 6-40. Used to explain the unknown by the use of analogies:

1. A
2. B
3. C
4. D

- 6-41. Used to give reasons for a stated quality or characteristic of your objective:

1. A
2. B
3. C
4. D

- 6-42. Used to tell your audience the essential procedure to use in a specific process:

1. A
2. B
3. C
4. D

- 6-43. Used to support facts using material that is meaningful and interesting:
1. A
 2. B
 3. C
 4. D
- 6-44. Phrasing the main speech points as briefly as possible without sacrificing the meaning is known as what style technique?
1. Parallelism
 2. Conciseness
 3. Motivation
 4. Comparison
- 6-45. Establishing motivation in the main points of a speech can be done by using which of the following phrasing techniques?
1. By using a series of three or more rhetorical questions
 2. By using similar sentence structure for each main point
 3. By using the words "you" and "your"
 4. By using the words "them" and "they"
- 6-46. Parallelism, when applied to wording the main points of a speech is defined as using the same phrase at the end of each sentence.
1. True
 2. False
- 6-47. Which of the following are considered appropriate supporting materials for the main points of a speech?
1. Factual examples from qualified sources
 2. A few personal experiences
 3. Both 1 and 2 above
 4. One or two jokes
- 6-48. Recapping the main points of a speech in the summary serves what primary purpose?
1. To signal the next speaker that your speech is about to end
 2. To fill out your allotted time
 3. To make sure the audience remembers the points
 4. To include material you did not provide in the explanation part of the speech
- 6-49. What is considered the best way for you to end a speech?
1. State that you are finished and thank the audience for listening
 2. Close with a strong, positive statement
 3. State that you could have said much more about your subject, but you did not have the time
 4. Ask the audience if you missed or left out anything
- 6-50. Which of the following is NOT an advantage of a written speech?
1. It reduces the possibility of a serious misquotation on important matters
 2. It assures the speaker of meeting time limitations
 3. It provides an opportunity to edit the material
 4. It allows the speaker to interject humor and anecdotes as appropriate
- 6-51. Since the analysis of the audience, the situation and the occasion is important for a written speech, the speech writer should take which of the following actions?
1. Talk with members of the group as part of your research
 2. Attend a meeting of the group
 3. Either 1 or 2 above
 4. Check your files for information about the group

- 6-52. To meet the needs of a community organization, you should slant a speech by taking which of the following actions?
1. Ask the person who requested a Navy speaker the reason behind the subject choice
 2. Ask the PAO what the interests of the inviting organization are
 3. Search out the real concerns of the organization
 4. Write the speech using the colloquialisms of the organization
- 6-53. A speech writer should analyze the speaker for whom he is writing a speech for which of the following reasons?
1. To produce a speech he will like
 2. To produce a forceful speech
 3. To build a good working relationship
 4. To reflect the speaker's style
- The commanding officer of station, Captain McBeth, has been asked to speak to the local Rotary Club at its luncheon meeting on Veterans' Day. Items 6-54 through 6-62 pertain to what you should or should not do in preparing to write the speech. Mark each statement True or False.
- 6-54. Determine the purpose that can best be served in the talk:
1. True
 2. False
- 6-55. Analyze the audience and occasion for the speech:
1. True
 2. False
- 6-56. Determine what aspect of the general subject, Veterans' Day, would best suit the captain:
1. True
 2. False
- 6-57. Be ready to recommend to the captain a limited objective to fit the requirements determined by your analysis of the audience, occasion and location:
1. True
 2. False
- 6-58. Avoid references to Captain McBeth's personal experiences:
1. True
 2. False
- 6-59. If the captain prefers a different aspect of the subject than the one you recommend, be prepared to defend your choice.
1. True
 2. False
- 6-60. Prepare a complete, detailed outline for the speech with types of example material:
1. True
 2. False
- 6-61. Check out visual aids, if possible, in the Rotary club meeting room:
1. True
 2. False
- 6-62. Discuss the completed outline with Captain McBeth to be sure the plan is as he visualized it and wants it:
1. True
 2. False
- 6-63. The speech writer should use examples for every point in a speech. These examples should be based on which of the following areas?
1. The personal biases of the speaker
 2. The personal experiences of the speech writer
 3. The personal experiences of the speaker
 4. The academic knowledge of the speech writer

- 6-64. You can overcome nervousness in public speaking if you cultivate which of the following mental attitudes?
1. Although you may be nervous, you will get over it as soon as you face the audience
 2. Since everyone is nervous when giving a speech, it is nothing to worry about
 3. Nervousness can be an asset if you understand that it helps you to be alert and prepared
 4. After recognizing the problem of nervousness, make up your mind to simply ignore it
- 6-65. Good eye contact is recommended during a speech for which of the following reasons?
1. It produces the effect of poise
 2. It makes the audience feel Wanted
 3. It allows the speaker to get feedback from the audience
 4. Both 2 and 3 above
- 6-66. A speaker can gain added confidence during a speech by taking which of the following actions?
1. Memorizing the speech word for word
 2. Imagining that all audience members are naked
 3. Following rigid grooming Standards
 4. Maintaining eye contact with individuals in the front row
- 6-67. A brief outline covered with strips of paper is known by which of the following names?
1. Paper strip outline graph
 2. Flow chart outline graph
 3. Pie-graph outline chart
 4. Strip-tease outline chart
- 6-68. Proportional percentages may be displayed using which of the following graphs?
1. Line
 2. Bar
 3. Picture
 4. Pie
- 6-69. Which of the following types of graphs may be used to illustrate trends or changes over a period of time?
1. Line
 2. Bar
 3. Picture
 4. Pie
- 6-70. The picture graph is prepared in a fashion similar to that of which of the following graphs?
1. Pie
 2. Line
 3. Bar
 4. Both 2 and 3 above
- 6-71. What is the main difference between a bar graph and a line graph?
1. The line graph must be drawn in color for maximum effectiveness
 2. The line graph does not have to depict authenticated facts
 3. The bar graph does not have to indicate any passage of time
 4. The bar graph must be drawn carefully to avoid the misrepresentation of data
- 6-72. Which of the following directly shown devices can be produced using an opaque projector?
1. Slap-ons
 2. Posters
 3. Handouts
 4. All of the above

6-73. A speaker should use colored markers or chalk on a dry marker or chalkboard for which of the following reasons?

1. Variety
2. Decoration
3. Emphasis
4. Efficiency

6-74. You plan to distribute data sheets in connection with a speech. is the best time to distribute the sheets?

1. Before you are introduced
2. During the first one third of the presentation
3. During the final one third of the presentation
4. At the end of the presentation

6-75. The opaque projector is capable of projecting opaque objects of any length up to how many inches wide?

1. 7
2. 10
3. 13
4. 16

ASSIGNMENT 7

Textbook Assignment: "Speeches" and "Newspaper Staff Supervision." pages 6-22 through 7-13.

- 7-1. Which of the following is a disadvantage of the opaque projector?
1. It will not project graphs, clippings or maps
 2. It is a complex machine to operate
 3. It will not project thick objects.
 4. It does not illuminate the screen as brightly as other projectors
- 7-2. During a presentation, a Navy speaker jots down a few notes on an overhead transparency frame. what is the main advantage of this action?
1. The speaker is not restricted by index cards or a script
 2. The speaker can eliminate hand gestures completely
 3. The speaker is better equipped to answer any critical questions
 4. The speaker becomes preoccupied with the transparency, eliminating any inherent nervousness
- 7-3. You have found a videotape that will help clarify a speech you are planning. Before presenting it, you should take which of the following actions?
1. Determine where you want to stop the videotape to discuss key parts
 2. Emphasize the key points of the videotape in an introduction
 3. Plan a post-videotape discussion that begins with you posing several rhetorical questions
 4. Edit out any unnecessary parts of the videotape to save time
- 7-4. Navy speakers prefer what visual aid?
1. Opaque projector
 2. Overhead transparency projector
 3. Carousel slide projector
 4. Videotapes and associated equipment
- 7-5. When using an object during a speech, you should adhere to which of the following rules?
1. Mounting the object on the front of the lectern
 2. Placing the object on a table
 3. Holding the object in your hands
 4. Hooking the object on a day marker or chalkboard
- 7-6. You are setting up a screen for showing slides in a 20- by 35-foot room with a level floor and a three-foot-high stage across one short end of the room. Where should you place the screen?
1. In the middle of the stage and about 1/2 feet above the stage floor
 2. In the middle of the stage and about 4 1/2 feet above the stage floor
 3. At the opposite side from the lectern and about 1/2 feet above the floor
 4. As close as possible to the lectern and about 4 1/2 feet above the stage floor

7-7. Keystoning is most accurately defined by what statement?

1. It is a disruption of the image in which the entire image is significantly reduced
2. It is a distortion of the image in which the entire image is proportionally enlarged
3. It is a distortion of the image in which the top of the picture is enlarged out of proportion
4. It is a disruption of the image in which a portion of the image is obscured by a foreign object

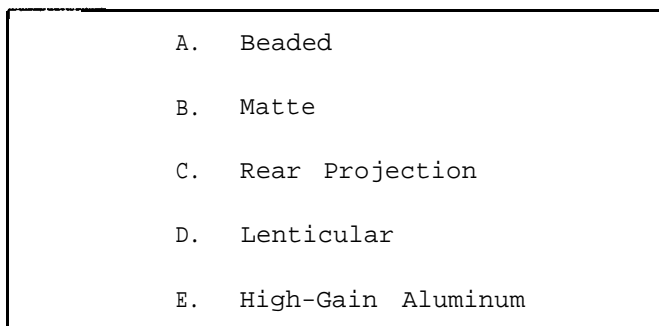

Figure 1

IN ANSWERING QUESTIONS 7-8 THROUGH 7-13, SELECT THE SCREEN TYPE IN FIGURE 1 THAT FITS THE DESCRIPTION USED AS THE QUESTION. RESPONSES IN FIGURE 1 MAY BE USED MORE THAN ONCE.

7-8. Capable of providing an image three or four times as bright as a matte screen:

1. B
2. C
3. D
4. E

7-9. Should be used in long, narrow rooms:

1. A
2. B
3. C
4. D

7-10. Capable of producing a reflected image approximately six times brighter than other screens:

1. B
2. C
3. D
4. E

7-11. Reflects images that are nearly equal in brightness at any viewing angle:

1. A
2. B
3. D
4. E

7-12. Permits close inspection of the screen image:

1. B
2. C
3. D
4. E

7-13. Has unique surface characteristics which allow it to be used in a normally lighted room:

1. B
2. C
3. D
4. E

7-14. You are giving a talk using a Carousel slide projector. To minimize eyestrain, you should use which of the following lighting approaches?

1. Use of the least possible light
2. Use of a small light at the front of the room
3. Use of some light behind or toward the rear of the audience
4. Use of some light on both sides of the audience

- 7-15. What is the purpose of using a feeding device when you are operating an overhead projector?
1. To prevent glare
 2. To prevent the risk of bulb failure from switching the light off and on too frequently
 3. To avoid the need for a helper
 4. To prevent damage to the transparencies
- 7-16. To keep the mechanics of a presentation in the background, you use a rear projection arrangement with an overhead projector. What type of screen is most desirable in this case?
1. A small, portable translucent screen
 2. A large, stationary translucent screen
 3. A beaded screen
 4. An opaque, lenticular screen
- 7-17. When giving a presentation that features the rear projection audiovisual arrangement, you encounter what main problem?
1. The extra work involved in reverse-mounting the transparencies
 2. The risk of tripping over the power cord
 3. The lack of room behind the screen
 4. The increased risk of bulb failure
- 7-18. Which of the following preparations for projection need NOT be/made before operation?
1. Checking the operation and controls of the machine(s)
 2. Running through the material for focus and quality of projection
 3. Situating the power cords so people will not trip over them
 4. Setting the machine(s) for long-range cue-in
- 7-19. To prevent feedback or squeal, you should place the sound system speakers in which of the following locations?
1. Directly in front of the lectern
 2. At the opposite side of the platform from the speaker's lectern and at the back
 3. As far as possible in front of the lectern but in front of the audience
 4. At the rear of the room
- 7-20. In addition to securing Navy speakers for all appropriate occasions, a local speakers bureau performs which of the following functions?
1. Issues audio tapes to AFRTS stations
 2. Provides technical advice to the motion picture industry on naval subjects
 3. Provides in-depth reference material concerning primary naval subjects
 4. Supports and administers the local Toastmasters club
- 7-21. *Navy Talking points* should be a part of your speakers bureau for which of the following reasons?
1. They provide information on important Navy issues that can be used in a speech
 2. They provide valuable information on how to run a speakers bureau
 3. They may be used to establish the policy of the speakers bureau
 4. They may be distributed to a group when a speaker is unavailable

- 7-22. Of the following items, which is, NOT normally a part of the command speakers bureau planning directive?
1. A current roster of participants
 2. Specific details on the operation of the bureau
 3. Applicable restrictions
 4. Current administrative procedures
- 7-23. Who, if anyone, should be excluded from participating in a speakers bureau?
1. Nonrated sailors
 2. Navy civilians
 3. Junior officers
 4. No one
- 7-24. What is the best way to recruit speakers for the speakers bureau?
1. Make sure the public affairs office is on the command check-in sheet and speak with each individual personally
 2. Ask the chairperson of the local Toastmasters chapter to place an advertisement in the local civilian newspaper
 3. Make sure excerpts from Chapter 6 of the J01 & C TRAMAN are printed periodically in the Plan of the Day
 4. Ask the personnel officer for permission to review all personnel records on a quarterly basis
- 7-25. You can ease the task of recruiting speakers for a speakers bureau by taking what action?
1. Making sure participation in the speakers bureau carries extra weight in personnel evaluation
 2. Contacting prospective speakers during off-duty hours
 3. Publishing the speakers bureau directive in the Plan of the Day
 4. Publicizing any awards or commendations given to speakers bureau participants
- 7-26. A typical speaker's folder should include all except which of the following pieces of information?
1. Past public speaking training
 2. Preferred speaking style
 3. Biographical data sheet
 4. Past speaking engagements and evaluations
- 7-27. A speaker will be more inclined to accept a speaking engagement if the speakers bureau offers which of the following services?
1. A good civic organization file
 2. A complete reference library
 3. A large speaker folder
 4. A comprehensive letter file
- 7-28. The letter file of a speakers bureau is primarily used to store transcriptions of all speeches made during a calendar year.
1. True
 2. False
- 7-29. To develop appropriate speaking platforms, you must advertise your speakers bureau. You can do this by taking which of the following actions?
1. Informing nearby military commands
 2. Sending letters to various organizations
 3. Notifying the local Toastmasters club
 4. Each of the above
- 7-30. You receive a request for a speaker by telephone. Before firming up the speaking arrangements, what further action, if any, should you take?
1. Ask the caller for a follow-up letter
 2. Ask the caller if you can meet with him personally
 3. Call the PAO in next highest command in the chain and inform him of the request
 4. None

- 7-31. You receive a speaking request and decide that it is in the best interest of the Navy. You immediately make plans to perform an in-depth analysis of the audience, occasion and location. This should be accomplished by reviewing which of the following speakers bureau files?
1. Letter
 2. Civic organization
 3. Speaker
 4. Chamber of commerce
- 7-32. The public affairs office should provide speaker assistance in all except which of the following areas?
1. Selecting an appropriate topic
 2. Suggesting support material
 3. Providing a typewritten copy of the speech
 4. Assigning an assistant to help with the operation of audiovisual equipment, if requested
- 7-33. The senior JO should evaluate every speaking engagement by personally attending each one.
1. True
 2. False
- 7-34. A command may publish a funded newspaper if the combined military and civilian work force totals at least how many individuals?
1. 500
 2. 1000
 3. 1500
 4. 2000
- 7-35. When, if ever, is commercial advertising permitted in a funded newspaper?
1. When all advertising money is donated to the MWR fund of tile command
 2. When it is authorized by the CO and area coordinator
 3. When all advertising money is added to the public affairs allocation of a command's operating fund
 4. Never
- 7-36. Commercial advertising for a civilian enterprise (CE) newspaper is sold by what individual?
1. CE newspaper publisher
 2. CE newspaper editor
 3. PAO
 4. Senior JO
- 7-37. From the Navy's standpoint, what is the most appealing feature of the CE newspaper?
1. It is published at little real cost to the Navy
 2. It is staffed exclusively by personnel assigned by the CE newspaper publisher
 3. It is published at no cost to the Navy
 4. It is fully funded by participating local merchants
- 7-38. In a contractual relationship between a Navy command and a CE newspaper publisher, what should be the key consideration?
1. The overall profits received by the publisher
 2. The information needs of the command
 3. The distribution methods of the publisher
 4. The financial needs of the command

- 7-39. You should draft a CE newspaper contract using which of the following publications?
1. NAVPUBINST 5720 series
 2. PA Regs
 3. NAVPUBINST 5600.4 series
 4. Both 2 and 3 above
- 7-40. In a CE newspaper selection committee, the senior JO usually serves in which of the following capacities?
1. Technical advisor
 2. Voting member
 3. Committee chair
 4. Both 2 and 3 above
- 7-41. A CE newspaper contract must be rebid after a total of how many years?
1. Five
 2. Six
 3. Three
 4. Four
- 7-42. What is normally the minimum copy to reader ratio in a CE newspaper contract?
1. 1:5
 2. 1:6
 3. 1:7
 4. 1:8
- 7-43. The maximum number of pages per issue in a CE newspaper depends largely on which of the following factors?
1. The amount of advertising sold and the availability of editorial copy
 2. The frequency of publication and the availability of advertising sold
 3. The location of the editorial sources and the availability of production facilities
 4. The amount of advertising sold and the availability of production facilities.
- 7-44. When, if ever, should the name of a CE newspaper be registered as a trade name by the publisher?
1. When the total circulation of the newspaper exceeds 10,000
 2. When the total advertising space of the newspaper is less than 30 percent
 3. When the command accepts a minimum lump-sum payment of \$3,000 from the publisher
 4. Never
- 7-45. The total amount of commercial advertising in a CE newspaper may NOT exceed what percentage of the total newspaper?
1. 40
 2. 50
 3. 60
 4. 70
- 7-46. In a typical CE newspaper contract, what individual is responsible for distribution?
1. PAO
 2. CE newspaper publisher
 3. MWR officer
 4. Transportation officer
- 7-47. To determine whether a prospective publisher is reputable, you should gather data from which of the following sources?
1. Current or former clients of the publisher
 2. Better Business Bureau
 3. Chamber of Commerce
 4. All of the above
- 7-48. The CE newspaper publisher normally pays for and provides the Navy editorial staff with which of the following materials?
1. Computers
 2. Floppy disks
 3. Printer ribbons
 4. Paper

- 7-49. There are 42 tenant commands within NAS Coquina. The CO of this base is authorized to publish what number of CE or funded newspapers?
1. 1
 2. 5
 3. 21
 4. 42
- 7-50. A newspaper staff stylebook normally includes information on all except which of the following areas?
1. Headline styles
 2. Computer usage procedures
 3. Feature writing techniques
 4. Ship or aircraft squadron designations
- 7-51. The use of color photography in a CE newspaper is normally limited by which of the following factors?
1. The CE publisher's ability to make color available
 2. The overall cost of the color photorgraphy
 3. The color photography skills of Navy staff members
 4. The rules listed in NAVPUBINST 5720.4 series
- 7-52. You decide to run an "opinion" column in your CE or funded newspaper. If an opinion differs from command or Navy policy, what action, if any, should you take?
1. Rewrite the opinion to fall in line with command and Navy policy
 2. Run an editor's note at the end of the opinion that states it is not endorsed by the Navy or command
 3. Run the opinion as is, but offer your personal rebuttal at the end
 4. None
- 7-53. Which of the following individual normally serves as the editor of a CE newspaper?
1. Senior JO
 2. Government service employee
 3. Publisher employee
 4. Both 2 and 3 above?
- 7-54. What member of the CE or funded newspaper staff is responsible for the entire editorial content of the newspaper?
1. PAO
 2. Editor
 3. Associate editor
 4. Leisure editor
- 7-55. The assoicate editor of a CE or funded newspaper is responsible for all except which of the following tasks?
1. Assigning pages for layout
 2. Accepting or rejecting story assignments
 3. Coordinating the distributio of the newspaper with the publisher
 4. Supervising other editors
- ?-56. For which of the following reasons should the editor and associate editor do more than just manage the CE or funded newspaper staff?
1. To establish contacts and credibility
 2. To impress subordinate staff members and to win their trust
 3. To be competitive in the annual CHINFO Merit Awards competition
 4. To learn the different facets of newspaper production
- 7-57. Because of manning constraints, the sports editor of a CE or funded newspaper should set up a newsgathering system with which of the following individuals?
1. PAO
 2. Base gym manager
 3. MWR manager
 4. PRT coordinator

- 7-58. In a CE or funded newspaper staff, general assignment writers are accountable to which of the following individuals?
1. Leisure editor
 2. Sports editor
 3. Associate editor
 4. Editor
- 7-59. Classified ads in CE newspapers are listings of commercial goods and services available to members of the command.
1. True
 2. False
- 7-60. You are unsuccessful in enlisting the services of a volunteer cartoonist for your CE or funded newspaper. What action should you take?
1. Direct a general assignment writer to take over all cartoonist duties
 2. Ask the publisher to provide a cartoonist
 3. Lift the art you need from existing Navy publication
 4. Order the monthly Navy Editor Service from NIRA
- 7-61. The amount of photographic support a CE or funded newspaper staff can get from the base imaging facility largely depends upon the availability of which of the following resources?
1. Funds
 2. Personnel
 3. Both 1 and 2 above
 4. Transportation
- 7-62. The associate editor should examine personnel factors and work in progress before making story assignments. This is done primarily for what reason?
1. To make sure the staff is adequately cross-trained
 2. To make sure no one staff member is backed up on assignments
 3. To maintain a good working relationship with the editor
 4. To make sure that military duties receive top priority
- 7-63. The newspaper staff master assignment sheet should be maintained in which of the following locations?
1. Editor's office
 2. associate editor's office
 3. Main office bulletin board
 4. Coffee lounge
- 7-64. What is the purpose of a copy log?
1. To list stories that are ready for the editor's review
 2. To list, by date, all of the stories produced by the staff in a production year
 3. To list, by date, the stories that are typeset and ready for proofreading
 4. To list stories that are completed and ready for layout in the paper
- 7-65. Which of the following items are NOT normally part of a typical newspaper staff credential?
1. Expiration date
 2. Social security number
 3. Organization name
 4. PAO or CO signature

- 7-66. You are the associate editor of a large CE newspaper. A staff planning session has prompted several major style and editorial changes to all main sections of the paper. In this case, you should run a readership survey within how many months of the changes?
1. 2 - 4
 2. 5 - 7
 3. 8 - 12
 4. 13 - 17
- 7-67. Before you start a beat system for your newspaper, you should consider which of the following factors?
1. Tile size of the command or installation and the size, of the Staff
 2. The size and circulation of the newspaper
 3. The total number of stringers available and the size of the newspaper
 4. The total number of potential readers and the size of the command
- 7-68. You are in charge of running a stringer system for your funded newspaper. As a minimum requirement, you should make sure your stringers can perform which of the following functions?
1. Type 15 words a minute
 2. Call in news tips
 3. Write simple news stories
 4. Take simple news photographs
- 7-69. You should provide feedback to your stringers in which of the following forms?
1. Recognition
 2. Constructive criticism
 3. Both 1 and 2 above
 4. Training
- 7-70. When selecting a photograph for publication, you should consider the quality of the photograph as well as the information in the outline.
1. True
 2. False
- 7-71. When selecting a photograph for publication from a contact sheet, which of the following is NOT a rule for you to follow?
1. The photograph should be composed to follow the "rule of thirds"
 2. The subject of the photograph should be identifiable in at least a one-quarter frontal view
 3. The photograph should have only one center of interest
 4. The subject of the photograph should be looking at the point of interest
- 7-72. You are running a story about the services available at the local Navy hospital. To support the story, you consider a photograph that shows a hospital patient in the background. Before you use the photograph, what action, if any, should you take?
1. Get a signed release form from the CO of the hospital
 2. Get a signed release form from the photographed patient
 3. Get verbal permission from the PAO of the hospital
 4. None
- 7-73. All of the following items are included in a typical set of newspaper galley proofs except which one?
1. Cutlines
 2. Artwork
 3. Photographs
 4. Headlines

7-74. When you proof the blueline, you can get the most thorough check by comparing it to which of the following documents?

1. Galley proofs
2. Reporter's original copy
3. Editor's working copy
4. Master assignment sheet

7-75. Desktop publishing encompasses which of the following newspaper production techniques?

1. Design
2. Document reproduction
3. Page makeup
4. All of the above

ASSIGNMENT 8

Textbook Assignment: "Newspaper Staff Supervision" and "Broadcast Management," pages 7-14 through 8-28.

- 8-1. Microcomputers used in desktop publishing require what minimum amount of memory?
1. 350K
 2. 512K
 3. 603K
 4. 720K
- 8-2. You should consider including a good dot-matrix printer as part of your desktop publishing outfit for which of the following reasons?
1. To use as a backup in case the main printer fails
 2. To print first drafts of pages
 3. To print figures and graphics
 4. To produce near-typeset-quality print at a reasonable cost
- 8-3. You should consider all except which of the following microcomputer peripherals for use with your desktop publishing system?
1. Mouse
 2. Scanner
 3. Digitizer
 4. External modem
- 8-4. Before You purchase desktop publishing software, you should examine which of the following points?
1. Compatibility with existing hardware
 2. Availability of a good graphics file
 3. Both 1 and 2 above
 4. Popularity among local civilian public relations offices
- 8-5. The rules and regulations of Navy broadcasting are contained in which of the following DoD instructions?
1. 5120.31-R
 2. 5120.20-R
 3. 5396.31-R
 4. 5720.44-R
- 8-6. In managing an NBS detachment, you should avoid which of the following practices?
1. Segregating personnel according to job description
 2. Asking a JO to complete a nontechnical PMS check
 3. Assigning the detachment YN2 to an evening board watch
 4. Both 2 and 3 above
- 8-7. The chief engineer at an NBS detachment usually has direct access to the manpower and resources of what section?
1. Administration
 2. Operations
 3. Training
 4. supply
- 8-8. What section of an NBS detachment is responsible for television and radio news, production and programming?
1. Engineering
 2. Administration
 3. Supply
 4. Operations

- 8-9. For natural disaster purposes, the manager of an NBS detachment should list the procedures station personnel must follow in which of the following sources?
1. SOP book
 2. Command disaster plan
 3. PAO log book
 4. Detachment adverse incident plan
- 8-10. A spot announcement written by a JO2 in the continuity department should be kept in the alibi file for what total number of months?
1. 6
 2. 9
 3. 3
 4. 12
- 8-11. The continuity section of an NBS detachment normally operates in conjunction with which of the following departments?
1. Television
 2. Operations
 3. Radio
 4. Engineering
- 8-12. Cross-training at an NBS detachment is important for which of the following reasons?
1. To produce well-rounded leaders of the Navy of tomorrow
 2. To keep people interested in their jobs
 3. To guard against over-specialization
 4. All of the above
- 8-13. When developing a master television programming schedule, your primary goal should be to provide the viewer with what service?
1. Entertainment
 2. Command information
 3. Training
 4. Education
- 8-14. Compatibility, with regard to television programming, is defined in what way?
1. Scheduling similar materials within a specified block
 2. Scheduling materials to conform to the daily activities of the audience
 3. Scheduling materials to maximize the use of station equipment
 4. Scheduling materials that are approved by the commander
- 8-15. To obtain compatibility in your programming schedule, you should use which of the following programming strategies?
1. Principle blocking
 2. Day division
 3. Appeal blocking
 4. Dayparting
- 8-16. The program director should assemble a programming schedule with a good audience flow. In doing this, he is trying to accomplish which of the following goals?
1. Keeping the audience tuned in
 2. Maintaining the consistency of the schedule
 3. Keeping the schedule moving with few interruptions
 4. Maintaining a good relationship with the audience
- 8-17. To obtain the best possible audience flow in a programming schedule, the program director should base his schedule on which of the following sources of information?
1. Informal conversations with members of the audience
 2. Formal conversations with members of the audience
 3. Results of the most recent audience survey
 4. Results of the most recent command attitude survey

- 8-18. You should consider repeating a popular program during your programming day for which of the following reasons?
1. To satisfy those audience members who request to see it again
 2. To meet the needs of command shift workers
 3. To offer additional training opportunities for your staff members
 4. To prove your flexibility to the chain of command
- 8-19. Television stations at NBS detachments are provided with what total number of programming hours per week?
1. 67
 2. 85
 3. 92
 4. 114
- 8-20. A program director may use Tele-Tips for which of the following reasons?
1. To determine natural break times. for inserting local spots
 2. To obtain the latest SATNET program advisory
 3. Both 1 and 2 above
 4. To obtain the latest news on the entertainment industry
- 8-21. SATNET is designed to provide NBS detachments overseas with which of the following programs?
1. New movies
 2. New SITCOMS
 3. Time-sensitive news and sports
 4. Music videos
- 8-22. Because AFRTS programming cannot compete directly with similar civilian programming, AFRTS-BC programming in certain geographical locations may be subject to partial airing restrictions.
1. True
 2. False
- 8-23. You schedule *Victory at Sea* to air Monday through Friday at 2100. This is an example of what type of blocking?
1. Free form
 2. Vertical
 3. Diagonal
 4. Horizontal
- 8-24. The free form blocking technique incorporates which of the following blocking techniques?
1. Diagonal
 2. Vertical
 3. Horizontal
 4. Both 2 and 3 above
- 8-25. To obtain balance when you prepare a television schedule, how should you pattern your prime time programming block?
1. By simulating stateside prime time blocking
 2. By simulating AFRTS prime time blocking
 3. By copying the prime time blocking of another successful broadcasting detachment
 4. By duplicating the free form blocking technique in DoD 5120.31-R
- 8-26. You are in charge of programming at an NBS detachment. You decide that the time blocking method will best suit your program scheduling needs. To make this method work, you must take which of the following actions?
1. Use the horizontal blocking programming method
 2. Use the free form blocking programming method
 3. Use filler material to start all programs on the hour or half hour
 4. Use television library (TL) videocassettes to start all programs at odd times

8-27. When you schedule your programs to run back-to-back and start them at odd times, you are using what type of time technique?

1. Timer blocking
2. Off-time blocking
3. Direct blocking
4. Sequential blocking

8-28. Initially, you should construct your master program schedule in which of the following ways?

1. By drawing a grid on a dry marker or chalkboard and filling in the blocks
2. By making a rough draft of the schedule on a program schedule work sheet
3. By writing the programs on index cards of different colors and placing them in the desired order
4. By making a rough draft of the schedule using the programming guidance available from SATNET

8-29. The weekly programming schedule serves what primary purpose?

1. To publicize the schedule to the command
2. To provide alibi copy for the programming director
3. To maintain the consistency of the programming from week to week
4. To simplify last-minute changes to the daily schedule

8-30. All except which of the following items is usually included in a weekly television schedule?

1. The title of the program
2. The day of the broadcast
3. The time of the broadcast
4. The run time of the program

8-31. To understand the audience appeal of the programs available at your radio station, you should take which of the following actions?

1. Personally interview as many radio listeners as you can
2. Review the list of programs available at your station
3. Both 1 and 2 above
4. Review the AM radio segment of Tele-Tips

8-32. You should play up-tempo music and provide news and information during which of the following radio programming dayparts?

1. Afternoon drive time
2. Midday drive time
3. Morning drive time
4. Fringe time

8-33. You should schedule prerecorded AFRTS-BC programs in which of the following time slots?

1. During the afternoon drive time
2. During the midday drive time
3. After the afternoon drive time
4. after the morning and midday drive times

8-34. In addition to playing music, a DJ should air what type of information?

1. That of immediate interest to the local community
2. That of moderate interest to the local community
3. That of general importance to command personnel
4. All of the above

8-35. According to an AFRTS-Arbitron survey, which of the following local live DJ show formats is considered the most viable for prime-time?

1. Top-40
2. Urban
3. Country
4. Adult contemporary

- 8-36. Before you add a local live DJ show to your radio schedule, you should consider which of the following factors?
1. The DJ's popularity
 2. The manpower resources of the station
 3. The DJ's skill level
 4. The CO'S music preference
- 8-37. The majority of the prerecorded radio shows provided by AFRTS-BC are a total of how many minutes?
1. 45
 2. 50
 3. 55
 4. 60
- 8-38. When, if ever, can your top-of-the-hour radio newscast exceed five minutes?
1. When the most recent audience survey justifies it
 2. When the music format of the following DJ show includes many short selections
 3. When training concerns justify it
 4. Never
- 8-39. The master radio program schedule sheet differs from the radio program schedule work sheet in which of the following ways?
1. The master schedule sheet lists the program sources; the work sheet does not
 2. The master schedule sheet lists the times the shows air; the work sheet does not
 3. The master schedule sheet does not list the names of the shows; the work sheet does
 4. The master schedule sheet does not describe the content of the shows; the work sheet does
- 8-40. A full week of radio programming usually contains what time blocking technique?
1. Vertical
 2. Horizontal
 3. Both vertical and horizontal
 4. Off-time
- 8-41. Your NBS detachment is equipped with both AM and FM radio stations. To satisfy the different musical preferences of the audience, you schedule two 1300 radio shows: classical music on AM and top-40 on FM. This is known as what type of programming method?
1. Reverse
 2. Counter
 3. Competitive
 4. Forward
- 8-42. Broadcast quality video cameras are designed to reproduce colors accurately at what color Temperature?
1. 2800°K
 2. 3200°K
 3. 5500°K
 4. 7300°K
- 8-43. What type of light is most commonly used in the broadcast industry?
1. Pulse xenon
 2. Direct beam
 3. Tungsten halogen
 4. Quartz iodine
- 8-44. What is the approximate color temperature of fluorescent light?
1. 3200°K
 2. 3400°K
 3. 4500°K
 4. 5400°K
- 8-45. Which of the following video camera filters does NOT affect the color temperature of light entering a camera?
1. Neutral-density
 2. Direct sunlight
 3. Fluorescent light
 4. Dusk/dawn

- 8-46. If you are not sure what video camera filter to use in a given situation, What should you do?
1. White balance the camera
 2. Use a neutral-density filter
 3. Use a direct sunlight filter
 4. Take a color temperature meter reading
- 8-47. You and your ENG team are preparing to do a stand-up in the CO's office (ashore command). Which of the following lighting approaches should you take?
1. Using whatever natural light is available
 2. Using a pulse xenon light
 3. Bouncing the light off the overhead onto the reporter
 4. Both 3 and 4 above
- 8-48. If you overlight a subject during a righttime ENG shoot, what will most likely result?
1. The amount of contrast between the subject and background will decrease
 2. The amount of contrast between the subject and background will increase
 3. The acceptable depth of field range will decrease
 4. The risk of scrim failure will increase
- 8-49. With regard to microphone usage during an ENG shoot, you should adhere to which of the following guidelines?
1. Use the camera-mounted microphone for stand-ups whenever possible
 2. Use the lavalier microphone only when it will not be visible on camera
 3. Use the camera-mounted microphone only to record natural sound
 4. Use the lavalier microphone only to record natural sound
- 8-50. Your ENG team is assigned to cover a news conference. When you arrive at the site, you discover that all that available microphone space on the lectern is taken. What should you do?
1. Use the camera-mounted microphone
 2. Clip a lavalier microphone to one of the public address speakers
 3. Tape a stick microphone to either the left or right side of the lectern
 4. Clip a lavalier microphone to a microphone already in place
- 8-51. Piecing together a two-minute story from shot sequences taken during a 14-month construction project is known as what time technique?
1. Filmic
 2. Aggregate
 3. Composite
 4. Inclusive
- 8-52. You should write the intro to a video news story at what point?
1. Before the story is written and assembled
 2. Before selecting the sound bites for the story
 3. After the rough outline is written
 4. After the story is written and assembled
- 8-53. In a video news story, the primary information transmission carrier is what element?
1. The script
 2. The video images
 3. The subliminal message
 4. The transitory meaning
- 8-54. What individual answers to the NBS detachment officer in charge and is responsible for making news assignments?
1. Senior reporter
 2. News director
 3. Broadcast engineer
 4. ENG supervisor

ASSIGNMENT 9

Textbook Assignment: "Broadcast Management" and "Audience Surveys," pages 8-29 through 9-10.

- 9-1. When using the beat call system to gather news, how often should you call your contacts?
1. Once a day
 2. Twice a day
 3. Once a week
 4. Twice a week
- 9-2. as a general rule, print publications should not be used when you localize a story for the nightly newscast.
1. True
 2. False
- 9-3. The staff members of an NBS detachment (television section) should be trained to follow the principles of which of the following fields of journalism?
1. Photojournalism
 2. Scriptwriting
 3. ENG reporting
 4. Copy editing
- 9-4. You should sequence your shots when you shoot a basic video news story. This involves your photographing the object in what way?
1. In relation to its surroundings, then as a single object, then concentrating on several parts of the object
 2. In relation to any similar objects, then on one main part of the object, then concentrating on its surroundings
 3. In relation to its main parts, then as a single object, then as one of many objects
 4. In relation to its surroundings, then as a single object, then concentrating on its news appeal
- 9-5. You are preparing to shoot a stand-up at a Special Olympics track event when you discover that you have left the tripod at the studio. To get the most stable shot without a tripod, you should use which of the following techniques?
1. Have a staff member support you from behind
 2. Rest the camera on your thighs while kneeling
 3. Rest the camera on the ground and angle it carefully toward the reporter
 4. Kneel down and rest your posterior on the heels of your feet
- 9-6. To minimize the appearance of camera movement when shooting a moving object, what should you do?
1. Lean against a wall and place your weight on the outside foot
 2. Set the zoom at the shortest focal length, possible
 3. Use a neutral density filter while setting the zoom at the longest focal length possible
 4. Hold the camera like a rifle and take very shallow breaths
- 9-7. Stand-ups are done primarily for what reason?
1. To make a reporter famous by keeping him in the public eye on a consistent basis
 2. To allow a reporter to convey a great deal of information about a story at the scene
 3. To mimic the techniques used in civilian broadcast journalism
 4. To minimize the use of zooms and pans in covering a news story

- 9-8. When, if ever, should one-man shooting assignments be encouraged as a regular practice?
1. When the members of the news team feel comfortable doing it
 2. When the results are better than two-member shooting assignments
 3. When the newscast can benefit from wider coverage
 4. Never
- 9-9. The anchor of your nightly newscast should exhibit which of the following qualities when on the air?
1. Be competent as a broadcaster
 2. Have an appearance that will not distract the audience
 3. Be in control of the newscast
 4. Each of the above
- 9-10. Under normal circumstances, the anchor should open the nightly newscast in what way?
1. By using his personal identification
 2. By using the cold start method as an introduction to the lead story
 3. By introducing the lead news story, then giving his personal identification later in the show
 4. By giving the top three news headlines, then going to the first story
- 9-11. The intros and outs of a story should be read by the anchor for which of the following reasons?
1. To give the impression that the anchor is in control of the program
 2. To give the newscast added plausibility
 3. Both 1 and 2 above
 4. To avoid confusion on the part of the news team
- 9-12. When, if ever, is it appropriate for the anchor to converse with other members of the news team (sports and weather anchors, for example) while on the air?
1. When there is extra time to kill
 2. When the anchor introduces another segment of the newscast and its anchor
 3. When the presence of adverse news in the newscast calls for a break in the tension
 4. Never
- 9-13. Which of the following video stories should NOT be considered for submission to Nsvy News This Week ?
1. An explosion aboard an aircraft carrier kills three sailors
 2. A new advance in paper recycling saves a command thousands of dollars annually
 3. A senior chief retires with 26 years of service
 4. A tropical storm hits a naval air station, resulting in thousands of dollars worth of damage
- 9-14. What is the most effective way to cover sports for the nightly newscast?
1. Place a reporter in charge of sports full-time
 2. Assign the responsibility of sports reporting to your staffers on a rotating basis
 3. Use the beat call system
 4. Assign the responsibility of sports reporting to the co-anchor as a collateral duty
- 9-15. What factor is the most important in a video sports story?
1. Drama
 2. Human
 3. Synchronization
 4. Contemplation

- 9-16. You assign an ENG team to shoot video of a Captain's Cup softball game. You should position your ENG team in which of the following locations?
1. Up and behind home plate
 2. In foul ground near first base
 3. Either 1 or 2 above
 4. In foul ground near third base
- 9-17. When reading sports copy, the sports anchor should use a fast-paced delivery for which of the following reasons?
1. To fit as much sports news into the typically abbreviated time slot
 2. To communicate to the viewer a feeling of suspense
 3. To communicate to the viewer a feeling of action
 4. To set up another segment of the newscast, such as the "lighter side" of news
- 9-18. You are scheduled to interview the command sailor of the year on the SITE system. Before the interview begins, you should convey to the interviewee which of the following thoughts?
1. You also will be as nervous as he will be
 2. You might ask a critical question or two to keep the interview interesting
 3. You are on his side and conducting the interview to tell his story
 4. You will be in charge of the interview from start to finish
- 9-19. You are the senior journalist aboard the USS Gunn (AVT 1). It is 1930, and the regular evening television programming is on the air. Suddenly, the CO calls to tell you the ship has passed its first-ever Operational Propulsion Plant Examination (OPPE). He wants you to do a live studio interview with the chief engineer (CHENG) in five minutes. You know nothing about the CHENG or the OPPE. After introducing the CHENG, how should you start the interview?
1. Ask the CHENG to explain the entire evolution
 2. Ask your initial questions based on the five Ws
 3. Ask the CHENG to give you a brief personality sketch on himself
 4. Ask your initial questions based on the CHENG'S past OPPE experiences
- 9-20. In an interview, you should base each new question on the interviewee's most recent answer for which of the following reasons?
1. To sustain audience interest in the interview
 2. To maintain control of the interview
 3. To keep your question bank replenished
 4. To produce an interview with a natural sounding flow
- 9-21. During an interview, you can communicate instructions to the camera operator by using which of the following methods?
1. Eye movements
 2. Hand signals
 3. Seat shifting
 4. All of the above

- 9-22. What is the main advantage of the "talking head" camera shot in an interview?
1. It can highlight the interviewee's personality
 2. It is easier to edit than other camera shots.
 3. It includes the element of immediacy
 4. It gives the audience a desirable dramatic effect
- 9-23. You are in charge of the 30-minute nightly newscast at your NBS detachment. What policy should you establish and pass to your reporters regarding the selection of interview sound bites?
1. Making mental notes on possible sound bites during the interview
 2. Conducting the interview, reviewing it, then selecting the appropriate sound bite
 3. Guiding the interviewee toward a preconceived sound bite in a polite manner
 4. Scripting the sound bite in advance with the help of the interviewee
- 9-24. An interviewer, when listening to an interviewee's response, should avoid making any verbal sounds or using body language for which of the following reasons?
1. To preserve the integrity of potential sound bites
 2. To give the interviewee the respect he deserves
 3. Both 1 and 2 above
 4. To allow the camera operator to get a good audio level on the interviewee
- 9-25. What statement most accurately describes a basic tenet of announcing?
1. Evaluating a person's voice is extremely difficult
 2. Announcing is a gift few people are born with
 3. You cannot change the basic sound of a person's voice
 4. The fundamentals of announcing are extremely subjective in nature
- 9-26. What breathing method allows you to gain the proper degree of control when announcing?
1. Pharynx induced
 2. Diaphragmatic
 3. Velumatic
 4. Larynx dominated
- 9-27. While physical in nature, the quality of an announcer's voice is also attributed to what two states of being?
1. Emotional and rational
 2. Mental and emotional
 3. Mental and rational
 4. Logical and emotional
- 9-28. What are the two types of resonance?
1. Sounding board and cavity
 2. Cavity and reverberant
 3. Sounding board and reverberant
 4. Sonorous and cavity
- 9-29. What cavity resonator of the voice is considered the most variable?
1. Nose
 2. Throat
 3. Mouth
 4. Sinus cavity
- 9-30. The only control an announcer has over the invariable vibrators (windpipe and bronchial tubes) is to keep them in good physical condition.
1. True
 2. False

- 9-31. A downward inflection at the end of an idea represents which of the following emotions?
1. Uncertainty
 2. Self-assurance
 3. Sarcasm
 4. Malice
- 9-32. Announcers use a sudden change in inflection (either up or down) for which of the following reasons?
1. To project a sense of authority
 2. To underscore a single item or a series of items
 3. To clarify a sentence with a double meaning
 4. To project an air of concern
- 9-33. By combining duration and volume, you can create which of the following elements of announcing?
1. Emphasis
 2. Intensity
 3. Contrast
 4. Both 2 and 3 above
- 9-34. An audience survey will provide you with valuable information in all except which of the following categories?
1. Recognizing possible personnel changes
 2. Identifying the demographics of a typical audience member
 3. Determining the intelligence level of a typical audience member
 4. Learning the approximate size of the potential audience
- 9-35. Audience survey information that is already on hand at our command is known as what type of data?
1. Aggregate
 2. Composite
 3. Consolidated
 4. Incorporated
- 9-36. Content analysis provides data that reflects what your audience is actually viewing, reading or thinking, not on what is being said or printed.
1. True
 2. False
- 9-37. What is the main advantage of research done through mail analysis?
1. Thoroughness
 2. Cost effectiveness
 3. Succinctness
 4. Swiftiness
- 9-38. The success of the toll-free telephone line operated by CHINFO during Operation DESERT STORM was partially attributed to which of the following factors?
1. The vast amount of statistical feedback gained
 2. The money saved in gathering statistical information from family members.
 3. Both 1 and 2 above
 4. The analysis of the trends found in the calls
- 9-39. What is the main drawback of the telephone survey?
1. The total cost in terms of resources and manpower
 2. The possibility of one telephone line serving several individuals
 3. The probability of the surveyor being confused with a solicitor
 4. The risk of contacting the same person more than once and getting different responses
- 9-40. What survey method is considered the most accurate for gathering data?
1. Mail
 2. Telephone
 3. Personal interview
 4. Random analysis

- 9-41. To get a good response rate when using a mail survey, you should take which of the following actions?
1. Keep the survey short
 2. Have the CO sign the survey
 3. Include a self-addressed. stamped envelope inside the survey mailer
 4. All of the above
- 9-42. In a mail survey, you should stress which of the following points?
1. That the survey must be returned within three business days
 2. That the respondent will not have his identity released
 3. That the survey must not be returned with any stray marks on it
 4. That the respondent will be compensated for his time
- 9-43. If you desire a +/-4 percent margin of error, how many survey responses must you receive?
1. 625
 2. 750
 3. 875
 4. 950
- 9-44. If you break your survey results into smaller demographic categories (Such as age or sex), which of the following results will occur?
1. The sample size will increase
 2. The margin of error will increase
 3. The sample size will decrease
 4. The margin of error will decrease
- 9-45. What is the best way to randomly select respondents for an audience survey?
1. Select a number from 0-9, then match this number with the first digit of the social security numbers listed on the base alpha roster
 2. Select a letter from A-Z, then match this letter with the first letter of the last names listed on the base alpha roster
 3. Select a number from 1-12, then match this number with the birth months listed on the base alpha roster
 4. Select a number from 0-9, then match this number with the last digit of the social security numbers listed on the base alpha roster
- 9-46. What is the most effective way to ensure the clarity of a mail survey?
1. Mail the survey to CHINFO for an external review
 2. Seek volunteers to complete the survey and offer feedback
 3. Compare the survey to the sample found in *PA Regs*, Chapter 3
 4. Include detailed instructions in the survey
- 9-47. Because of the difficulty in tabulation, you should avoid using which of the following types of survey question?
1. Open-ended
 2. Yes-no
 3. Multiple choice
 4. Both 2 and 3 above
- 9-48. To measure the intensity of an particular belief or attitude, you should use what type of scale?
1. Linear
 2. Likert
 3. Limnetic
 4. Lenticular

- 9-49. When you write multiple choice questions for an audience survey, you should avoid which of the following practices?
1. Writing questions that ask for a numerical response
 2. Numbering the responses with letters
 3. Placing the last question in a category at the top of a page
 4. Writing responses that have overlapping categories

- 9-50. What statement best describes the use of graphs to display survey results?
1. Display survey results in a manner that best reflects your own personal views while staying within the boundaries of good taste
 2. Display survey results in a manner that is aesthetically pleasing while staying within the boundaries of security
 3. Display survey results in the most understandable manner possible while keeping within the boundaries of fair presentation
 4. Display survey results in the most elaborate manner possible while keeping within the boundaries of good taste

