



NONRESIDENT TRAINING COURSE

January 1998



Mineman, Volume 7

NAVEDTRA 14160

NOTICE

Pages 6-6, 6-9, 6-10, 6-13, 6-16, 6-17, 6-18,
6-19, 6-20, 6-21, 6-22, 6-23, must be printed
on a **COLOR** printer

DISTRIBUTION STATEMENT A: Approved for public release; distribution is unlimited.

Although the words “he,” “him,” and “his” are used sparingly in this course to enhance communication, they are not intended to be gender driven or to affront or discriminate against anyone.

DISTRIBUTION STATEMENT A: Approved for public release; distribution is unlimited.

PREFACE

By enrolling in this self-study course, you have demonstrated a desire to improve yourself and the Navy. Remember, however, this self-study course is only one part of the total Navy training program. Practical experience, schools, selected reading, and your desire to succeed are also necessary to successfully round out a fully meaningful training program.

COURSE OVERVIEW: In completing this nonresident training course, you will demonstrate a knowledge of the subject matter by correctly answering questions on the following subjects:

- magazines and fire suppression systems;
- small arms;
- pyrotechnics;
- marlinespike seamanship;
- deck seamanship;
- boat seamanship;
- anchoring, mooring, and towing;
- mechanical minesweeping;
- acoustic minesweeping;
- magnetic minesweeping;
- combination minesweeping;
- minesweeping safety.

THE COURSE: This self-study course is organized into subject matter areas, each containing learning objectives to help you determine what you should learn along with text and illustrations to help you understand the information. The subject matter reflects day-to-day requirements and experiences of personnel in the rating or skill area. It also reflects guidance provided by Enlisted Community Managers (ECMs) and other senior personnel, technical references, instructions, etc., and either the occupational or naval standards, which are listed in the *Manual of Navy Enlisted Manpower Personnel Classifications and Occupational Standards*, NAVPERS 18068.

THE QUESTIONS: The questions that appear in this course are designed to help you understand the material in the text.

VALUE: In completing this course, you will improve your military and professional knowledge. Importantly, it can also help you study for the Navy-wide advancement in rate examination. If you are studying and discover a reference in the text to another publication for further information, look it up.

*1998 Edition Prepared by
MNCS Anthony D. D'Amico*

Published by
NAVAL EDUCATION AND TRAINING
PROFESSIONAL DEVELOPMENT
AND TECHNOLOGY CENTER

**NAVSUP Logistics Tracking Number
0504-LP-026-8140**

Sailor's Creed

“I am a United States Sailor.

I will support and defend the Constitution of the United States of America and I will obey the orders of those appointed over me.

I represent the fighting spirit of the Navy and those who have gone before me to defend freedom and democracy around the world.

I proudly serve my country's Navy combat team with honor, courage and commitment.

I am committed to excellence and the fair treatment of all.”

CONTENTS

CHAPTER	PAGE
1. Magazine and Fire Suppression Systems	1-1
2. Small Arms	2-1
3. Pyrotechnics	3-1
4. Marlinspike Seamanship	4-1
5. Deck Seamanship	5-1
6. BoatSeamanship	6-1
7. Anchoring, Mooring, and Towing	7-1
8. Mechanical Minesweeping	8-1
9. Acoustic Minesweeping	9-1
10. Magnetic Minesweeping	10-1
11. Combination Minesweeping	11-1
12. Minesweeping Safety	12-1
APPENDIX	
I. Glossary	AI-1
II. Abbreviations and Acronyms	AII-1
III. References Used to Develop the TRAMAN.	AIII-1
INDEX	INDEX-1

NONRESIDENT TRAINING COURSE follows the index

SUMMARY OF THE MINEMAN TRAINING SERIES

This series of training manuals was developed to replace *the Mineman 3 & 2* and *Mineman 1 & C* manuals. The content is directed toward personnel working toward advancement in the Mineman rating.

The seven volumes in this series are based on major topic areas with which the Mineman should be familiar. Their topics include the following areas:

- Volume 1: Mine warfare, operations, and organization.
- Volume 2: Mine shop administration and supply.
- Volume 3: Mine maintenance and explosive materials.
- Volume 4: Mines and mine components.
- Volume 5: Exercise and training mines.
- Volume 6: MCM CIC operations
- Volume 7: MCM deck operations

INSTRUCTIONS FOR TAKING THE COURSE

ASSIGNMENTS

The text pages that you are to study are listed at the beginning of each assignment. Study these pages carefully before attempting to answer the questions. Pay close attention to tables and illustrations and read the learning objectives. The learning objectives state what you should be able to do after studying the material. Answering the questions correctly helps you accomplish the objectives.

SELECTING YOUR ANSWERS

Read each question carefully, then select the BEST answer. You may refer freely to the text. The answers must be the result of your own work and decisions. You are prohibited from referring to or copying the answers of others and from giving answers to anyone else taking the course.

SUBMITTING YOUR ASSIGNMENTS

To have your assignments graded, you must be enrolled in the course with the Nonresident Training Course Administration Branch at the Naval Education and Training Professional Development and Technology Center (NETPDTC). Following enrollment, there are two ways of having your assignments graded: (1) use the Internet to submit your assignments as you complete them, or (2) send all the assignments at one time by mail to NETPDTC.

Grading on the Internet: Advantages to Internet grading are:

- you may submit your answers as soon as you complete an assignment, and
- you get your results faster; usually by the next working day (approximately 24 hours).

In addition to receiving grade results for each assignment, you will receive course completion confirmation once you have completed all the

assignments. To submit your assignment answers via the Internet, go to:

<http://courses.cnet.navy.mil>

Grading by Mail: When you submit answer sheets by mail, send all of your assignments at one time. Do NOT submit individual answer sheets for grading. Mail all of your assignments in an envelope, which you either provide yourself or obtain from your nearest Educational Services Officer (ESO). Submit answer sheets to:

COMMANDING OFFICER
NETPDTC N331
6490 SAUFLEY FIELD ROAD
PENSACOLA FL 32559-5000

Answer Sheets: All courses include one “scannable” answer sheet for each assignment. These answer sheets are preprinted with your SSN, name, assignment number, and course number. Explanations for completing the answer sheets are on the answer sheet.

Do not use answer sheet reproductions: Use only the original answer sheets that we provide—reproductions will not work with our scanning equipment and cannot be processed.

Follow the instructions for marking your answers on the answer sheet. Be sure that blocks 1, 2, and 3 are filled in correctly. This information is necessary for your course to be properly processed and for you to receive credit for your work.

COMPLETION TIME

Courses must be completed within 12 months from the date of enrollment. This includes time required to resubmit failed assignments.

PASS/FAIL ASSIGNMENT PROCEDURES

If your overall course score is 3.2 or higher, you will pass the course and will not be required to resubmit assignments. Once your assignments have been graded you will receive course completion confirmation.

If you receive less than a 3.2 on any assignment and your overall course score is below 3.2, you will be given the opportunity to resubmit failed assignments. **You may resubmit failed assignments only once.** Internet students will receive notification when they have failed an assignment--they may then resubmit failed assignments on the web site. Internet students may view and print results for failed assignments from the web site. Students who submit by mail will receive a failing result letter and a new answer sheet for resubmission of each failed assignment.

COMPLETION CONFIRMATION

After successfully completing this course, you will receive a letter of completion.

ERRATA

Errata are used to correct minor errors or delete obsolete information in a course. Errata may also be used to provide instructions to the student. If a course has an errata, it will be included as the first page(s) after the front cover. Errata for all courses can be accessed and viewed/downloaded at:

<http://www.advancement.cnet.navy.mil>

STUDENT FEEDBACK QUESTIONS

We value your suggestions, questions, and criticisms on our courses. If you would like to communicate with us regarding this course, we encourage you, if possible, to use e-mail. If you write or fax, please use a copy of the Student Comment form that follows this page.

For subject matter questions:

E-mail: n311.products@cnet.navy.mil
Phone: Comm: (850) 452-1548
DSN: 922-1548
FAX: (850) 452-1370
(Do not fax answer sheets.)
Address: COMMANDING OFFICER
NETPDTC N311
6490 SAUFLEY FIELD ROAD
PENSACOLA FL 32509-5237

For enrollment, shipping, grading, or completion letter questions

E-mail: fleetservices@cnet.navy.mil
Phone: Toll Free: 877-264-8583
Comm: (850) 452-1511/1181/1859
DSN: 922-1511/1181/1859
FAX: (850) 452-1370
(Do not fax answer sheets.)
Address: COMMANDING OFFICER
NETPDTC N331
6490 SAUFLEY FIELD ROAD
PENSACOLA FL 32559-5000

NAVAL RESERVE RETIREMENT CREDIT

If you are a member of the Naval Reserve, you may earn retirement points for successfully completing this course, if authorized under current directives governing retirement of Naval Reserve personnel. For Naval Reserve retirement, this course is evaluated at 6 points. (Refer to *Administrative Procedures for Naval Reservists on Inactive Duty*, BUPERSINST 1001.39, for more information about retirement points.)

Student Comments

Course Title: Mineman, Volume 7

NAVEDTRA: 14160 **Date:** _____

We need some information about you:

Rate/Rank and Name: _____ SSN: _____ Command/Unit _____

Street Address: _____ City: _____ State/FPO: _____ Zip _____

Your comments, suggestions, etc.:

<p>Privacy Act Statement: Under authority of Title 5, USC 301, information regarding your military status is requested in processing your comments and in preparing a reply. This information will not be divulged without written authorization to anyone other than those within DOD for official use in determining performance.</p>
--

NETPDTC 1550/41 (Rev 4-00)

CHAPTER 1

MAGAZINES AND MAGAZINE SPRINKLER SYSTEMS

LEARNING OBJECTIVES

Upon completing this chapter, you should be able to do the following:

1. Recall the types and designations of shipboard magazines, and the security measures and inspection criteria associated with shipboard magazines.
2. Describe the purpose and functioning of shipboard magazine sprinkler systems. Identify the primary components of magazine sprinkler systems, including various control valves, gauges, and alarm systems.

MAGAZINES

In this chapter we will discuss only shipboard magazines and their sprinkler system. For information on shore magazines, refer to *Mineman, Volume 3*.

A *magazine* is any compartment, space, or locker used, or intended to be used, for the stowage of explosives or ammunition of any kind. A term always associated with a magazine is *magazine area*. A magazine area includes the magazine itself and any spaces or passages containing magazine entrances intended to be used for the handling and passing of ammunition. It also includes areas adjacent to explosive stowages, including loaded ammunition lighters, trucks, and railroad cars, where special safety measures are required.

Magazines are physically located for ease of receiving and issuing explosives, the best obtainable protection (security), and the most favorable stowage conditions.

MAGAZINE TYPES

There are several types of magazines on ships; among these are primary, ready-service, missile, locker, and chemical. Each type is designed specifically for a particular type of ammunition. In this TRAMAN, we will limit our discussion to primary magazines and ready-service magazines.

Primary Magazines

Primary magazines are designed as ammunition stowage spaces, generally located below the main deck and usually below the waterline. They are adequately equipped with insulation, ventilation, and sprinkler systems and are provided with fittings so they may be locked securely. Primary magazines can accommodate a vessel's complete allowance of ammunition for peacetime operation.

Ready-Service Magazines

Ready-service magazines are spaces physically convenient to the weapons they serve. They provide permanent stowage for part of the ammunition allowance. Normally they are equipped with insulation, ventilation, and ammunition sprinkler systems, and are secured by locking. The combined capacities of the primary and ready-service magazines are normally sufficient to hold the ship's allowance for war and emergencies.

Regardless of its type, each magazine is marked by a label plate showing its compartment number and the type of ammunition it is designed to contain.

MAGAZINE DESIGNATIONS

Magazines are designated according to the type of explosive they contain. Recall from above that each

magazine is usually designed to hold only one type of explosive. Based on this assumption, a magazine may have any one of the following designations:

- Powder magazine
- Fixed-ammunition magazine
- Small arms magazine
- Warhead locker
- Projectile magazine or room
- Bomb magazine
- Missile magazine
- Fuze magazine
- Detonator locker
- Pyrotechnic magazine or locker

While stowing only one type of ammunition in a magazine is desirable, it is not always possible, due to space limitations. Therefore, in certain situations prescribed by the operational commander, more than one type of ammunition can be stowed in a magazine. However, the mix cannot include pyrotechnics that have been removed from their containers or fuzes and detonators that are not integral parts of the ammunition. These items must be stowed according to the current instructions related to the particular items.

Where mixed stowage of ammunition is necessary, precautions should be taken to make sure the various types of ammunition are segregated within the magazine and that each type is suitably marked for ready identification. *Ammunition Afloat*, NAVSEA OP-4, provides answers to specific questions concerning stowage requirements.

MAGAZINE SECURITY

In peacetime, all magazines, explosives lockers, ready-service lockers, and areas such as ammunition hoists leading into magazine spaces are kept closed and locked, except when they are opened for inspection, ventilating purposes, testing, or authorized work. These spaces are not entered unnecessarily and are opened only when authorized by the weapons officer. The weapons officer is responsible for making sure that the spaces are locked when they are not being used.

The only thing that may be stored in a magazine is the material it was designed to hold. A magazine may not be used to store empty paint cans or grease cans, oily waste rags, or similar fire hazards. Additionally, the only personnel allowed to be in a magazine are those who have business there.

The commanding officer (CO) is the custodian of all magazine keys. The CO may, however, designate certain persons under his or her command to have custody of duplicate keys. The designated individual will use the duplicate keys each morning to inspect the magazines and take magazine temperatures.

MAGAZINE INSPECTIONS

Every ship has requirements for periodic (daily, weekly, monthly, bimonthly, quarterly, semiannual, or annual) inspections of its magazines and their contents. These inspections should follow the appropriate 3-M Systems maintenance requirement cards (MRCs) and other source publications such as *Ammunition Afloat*, NAVSEA OP-4.

A magazine is considered to be in satisfactory condition if an inspection shows that it meets the requirements listed on applicable MRCs. Daily inspection requirements usually include checking the general condition and cleanliness of the space. Less frequent inspections (monthly, quarterly, and so on) normally require a more detailed check of specific magazine conditions and equipment. The inspector should understand each 3-M inspection requirement completely and should follow it to the letter. Doing so not only ensures a safe ammunition storage area but also fulfills the requirements of periodic inspections, such as the explosive safety inspection (ESI). ESI inspectors use the same inspection criteria as those listed on your MRCs.

The most frequently conducted magazine inspection is, obviously, the daily inspection. The main purpose of a daily magazine inspection is to check and record space temperatures. Temperature is the most important factor that affects powder and propellant stability. Because of the importance of maintaining proper temperatures in magazines, we will spend the next few pages discussing how and why temperatures are taken, recorded, and evaluated.

Magazine Temperatures

Temperature readings normally are taken once a day. The exact time may vary, but on most ships the readings are taken in the morning (around 0800 for example). A special maximum and minimum thermometer is used. (Sometimes it's called a high-low thermometer.) Figure 1-1 illustrates a typical maximum and minimum thermometer.

Every magazine or locker will have at least one such direct-reading thermometer, located where maximum space temperature variations normally occur. It will be installed so that it is readily accessible for taking readings and for resetting the index pointers.

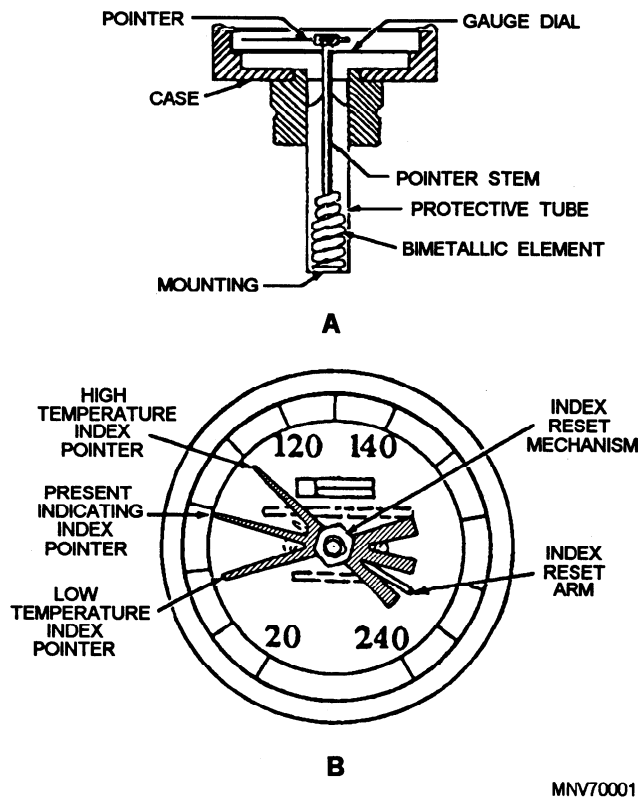

Figure 1-1.—Bimetallic maximum and minimum thermometer:
A. Internal components; B. Dial face and pointers.

View A of figure 1-1 shows the internal components of the device. The temperature-sensitive element is a single-helix low-mass coil. The coil fits closely inside the thermometer stem. The bimetal element is carefully sized and aged for lifetime stability, and is covered with a fluid to assure good heat transfer. The fluid also permits maximum speed of response and reduces pointer oscillations caused by outside vibrations. The case and stem are made from stainless steel for strength and anticorrosion purposes.

View B of figure 1-1 illustrates the dial face of the thermometer. It is 3 inches in diameter, with a plastic window to protect the index pointers. The index reset arm is on the outside of the window and is used to reset the high-low pointers. Temperature graduations on our example are marked off in 20-degree increments. The approximate readings on this thermometer are 100°F, high; 78°F, present; and 55°F, low. If you are assigned the duty of taking magazine temperature readings, you should record the high, low, and present temperatures and then reset the high and low pointers in line with the present pointer. As temperature rises during the day, the present pointer will push the high pointer up the scale. As temperature falls during the night, the present pointer will reverse direction and push the low pointer down the scale. As the sun comes up, the present pointer will move back up the scale. Thus, the inspector will see three different temperature readings that reflect the temperature variations throughout a 24-hour period.

The 45-degree spread between the high and low pointers in our example is a bit large, but is used for clarity. Check the temperature requirements for the magazine you are inspecting and have the magazine air-conditioning (A/C) or ventilating system turned on if the temperature rises into the high zone. The optimum temperature should be around 70°F. If the A/C system is not working, artificial cooling (fans, blowers) may have to be used.

The bimetallic maximum and minimum thermometer in figure 1-1 is becoming the standard thermometer in shipboard magazines. However, you may come across a different model with only a maximum (high) index pointer and a reset knob. This type of thermometer is acceptable. The older liquid-in-glass (tube) mercury high-low thermometer is no longer authorized for shipboard use. If you see one of the mercury units in a magazine, notify your supervisor.

Records of Magazine Temperature Inspections

Like other maintenance procedures, magazine inspections have records that must be maintained. The most common written records are the daily magazine temperature report form and the magazine temperature record (fig. 1-2). 3-M Systems records may also be considered as records of magazine inspections.

The magazine temperature record is a card posted in each magazine. Each day, the inspector enters the maximum and minimum temperatures for the previous 24 hours in that magazine. The card is replaced every month, and the old one is turned over to the weapons officer.

The daily magazine temperature report summarizes the results of magazine inspections for the whole ship. This form includes not only spaces for entering the highest and lowest magazine temperatures, but also for reporting the condition of the magazines and their ventilating devices, and (under REMARKS) for miscellaneous, nondaily routine work.

The daily magazine temperatures are transferred from the record cards to a magazine log that is a permanent record of all magazine temperatures. A

separate section of the magazine log is usually set aside to record the results of the monthly sprinkler system tests.

MAGAZINE SPRINKLER SYSTEMS

Sprinkler systems are used for emergency cooling and fire fighting in magazines, ready-service rooms, and ammunition- and missile-handling areas. A magazine sprinkler system is a network of pipes secured to the overhead and connected by a sprinkler system control valve to the ship's continually pressurized saltwater firemain. The pipes are fitted with sprinkler head valves arranged so the water forced through them showers all parts of the magazine or ammunition- and missile-handling areas.

A modern sprinkler system can wet down all exposed bulkheads at the rate of 2 gallons per minute per square foot and can sprinkle the deck area at the rate of 4 gallons per minute per square foot. Magazine sprinkler systems are designed to completely flood their designated spaces within an hour. To prevent unnecessary flooding of adjacent areas, all compartments equipped with sprinkler systems are watertight. Upper deck-handling and ready-service

A				B	
MAGAZINE TEMPERATURE RECORD				DAILY MAGAZINE TEMPERATURE	
5ND GEN 90 (REV 11-48)				DD, DE CLASSES	
COMPARTMENT		THERM. NO.	MONTH		NOTE: To be submitted to O. O. D. by 1130 daily
A 304 M		279	APRIL		U.S.S. <u>T. F. TREMENDOUS</u>
DATE	MAXIMUM	MINIMUM	INITIAL		DATE <u>1 APR 93</u>
1	84	72	RAC		IN <u>A-304 M</u>
2	82	70	RAC		IN <u>A-204 M</u>
3					
4					INSPECTED MAGAZINE'S CONDITION <u>OK</u>
5					INSPECTED MAGAZINE VENTILATION CONDITION <u>OK</u>
6					INSPECTED SMOKELESS POWDER SAMPLES CONDITION <u>OK</u>
29					CONDUCTED WEEKLY TEST OF MAGAZINE SPRINKLER SYSTEMS
30					DATE <u>1 APR 93</u>
31					REMARKS <u>TEST OF MAGAZINE SPRINKLER SYSTEMS SATISFACTORY</u>
					SIGNATURE (GMC or GM in Charge) <u>C. Barber</u> SIGNATURE (Gunners Officer) <u>B. B. Berman</u>
					DESCLANT FORM 8000-7 (Rev. 11/5.5)

Figure 1-2.—A. The magazine temperature record; B. Daily magazine temperature report.

rooms are equipped with drains that limit the maximum water level to a few inches. Magazines are completely enclosed; if flooded, they would be exposed to the full firemain pressure. The firemain pressure on most ships is considerably higher than the pressure magazine bulkheads could withstand; therefore, magazines are equipped with exhaust ventilators located in the bulkhead near the overhead. An exhaust ventilator is a pipe with a check valve that permits pressure release (usually to topside). Since the diameter of the pipe is large enough to allow water to flow out as fast as it flows in, no excess pressure can build up in the magazine compartment. On newer ships, magazines are also equipped with small, capped drainpipes located in the bulkhead near the deck. The caps may be removed in the adjacent compartment to drain flooded magazines.

Shipboard magazine sprinkler systems are hydraulically- controlled saltwater/seawater-operated systems. There are two basic types of sprinkler systems—the dry-type and the wet-type. In the dry-type system, water is not delivered to the sprinkler heads until the system is activated. In the wet-type system, water is continually available at the sprinkler heads and is sprayed in the magazine when heat activates the sprinkler head. Both types may be found on some ships. However, the wet-type system is being discontinued. Therefore, we will cover only the dry type. Technical information on both types is contained in *Magazine Sprinkler System*, NAVSEA S9522-AA-HBK-010.

A dry-type magazine sprinkler system consists basically of three subsystems. The first subsystem is the loop of piping and valves that delivers firemain water to the sprinkler heads. The second subsystem is the hydraulic control system. This system uses firemain water, through smaller piping, to operate the control valves in the first subsystem. The third subsystem is the thermopneumatic system. This system provides automatic control of the hydraulic control system. A manual valve is installed in the hydraulic control system to activate the main sprinkler control valve in case the automatic system is inoperative or slow to respond. We discuss all of these subsystems, along with the magazine sprinkler control valve and the alarm system, below.

As you read about each area of the sprinkler system, you may wish to refer to figure 1-3, which shows how the system components are related. Pay particular note to the legend list for the symbols. In addition to the orifices and valves, this figure also identifies the OPEN and CLOSE loops of the operating pressure circuit.

MAGAZINE SPRINKLER CONTROL VALVES

Magazine sprinkler control valves (commonly referred to as main valves) are globe-type valves, normally closed but designed to open wide when actuated, to supply seawater to the sprinkler system. They are diaphragm operated and open at a minimum system operating pressure of 40 psi.

The diaphragm-operated control valve (fig. 1-4) is held closed by the combination of firemain pressure acting against the valve disk and valve spring force acting against the upper diaphragm washer. When the hydraulic control system is actuated, pressurized seawater from the firemain enters the diaphragm chamber and pushes (via the diaphragm) against the bottom of the upper diaphragm washer. The bottom surface area of the upper diaphragm washer is larger than the surface area of the valve disk. This difference in surface areas allows the water pressure in the diaphragm chamber to create a lifting force greater than the closing force created by the spring and pressure on the valve disk. As a result, the valve disk is lifted and water is allowed to flow through the valve. When the control system is secured, the operating pressure is bled from the diaphragm chamber and the valve is closed by the force of the valve spring.

The control valve may be actuated either automatically or manually. We will discuss automatic actuating first, followed by manual actuation.

AUTOMATIC (THERMOPNEUMATIC) CONTROL SYSTEM

The automatic control system is designed to actuate the magazine sprinkler system in response to both a rapid rise in temperature (caused by an active fire) and the reaching of a preset temperature (caused by a smoldering fire). The thermopneumatic elements, which monitor the temperature of the magazine and activate the sprinkler system, generate a pneumatic signal in response to thermal action. The pneumatic signal can be either a sudden increase or decrease in air pressure.

The automatic control system consists of heat-sensing devices (HSDs), transmission lines (Rockbestos®- or Rockhide®-covered copper tubing), circle seal check valves, and a pneumatically released pilot (PRP) valve.

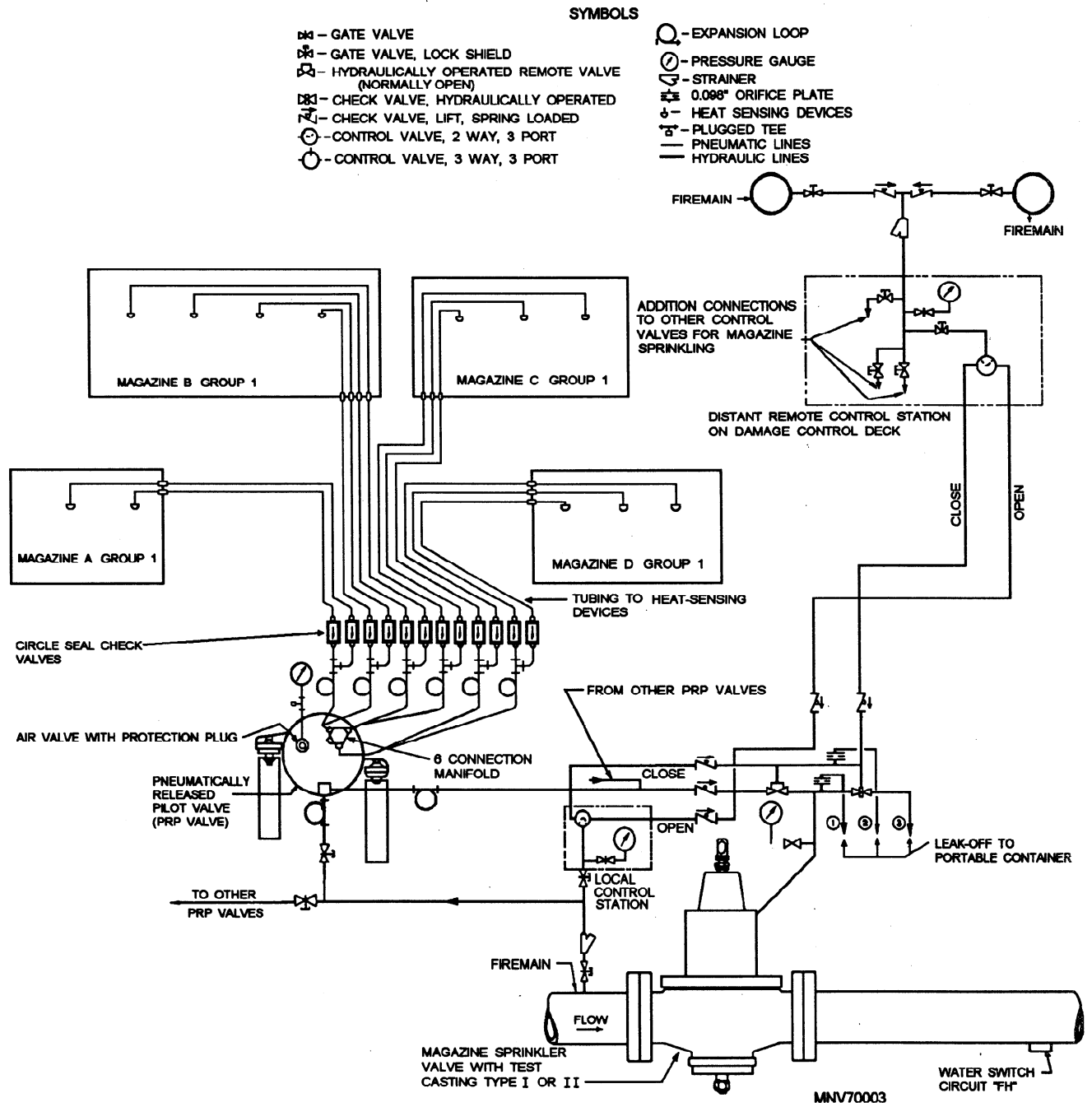

Figure 1-3.—Hydraulic (SW) and thermopneumatic control systems for magazine sprinkler valves.

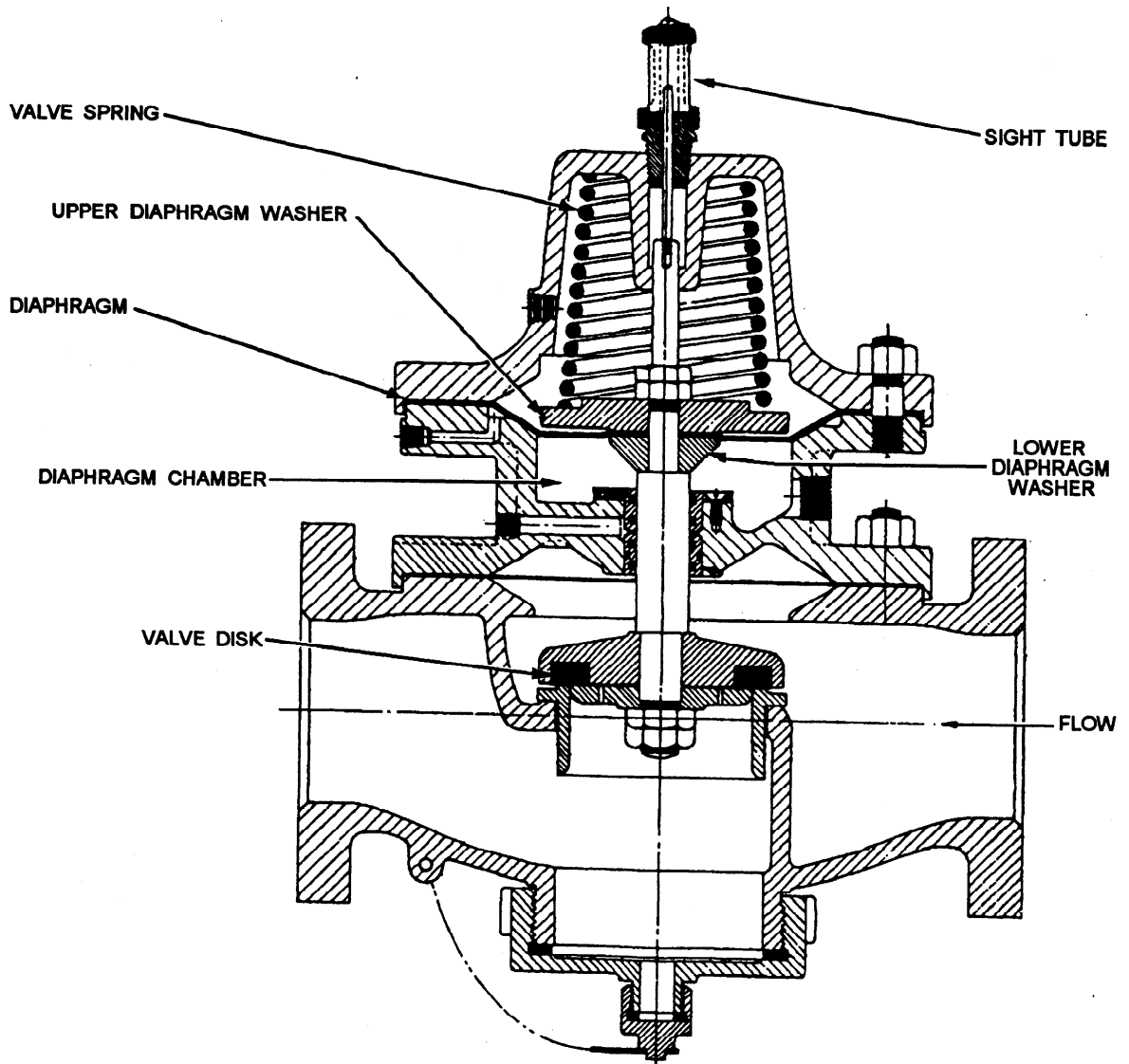
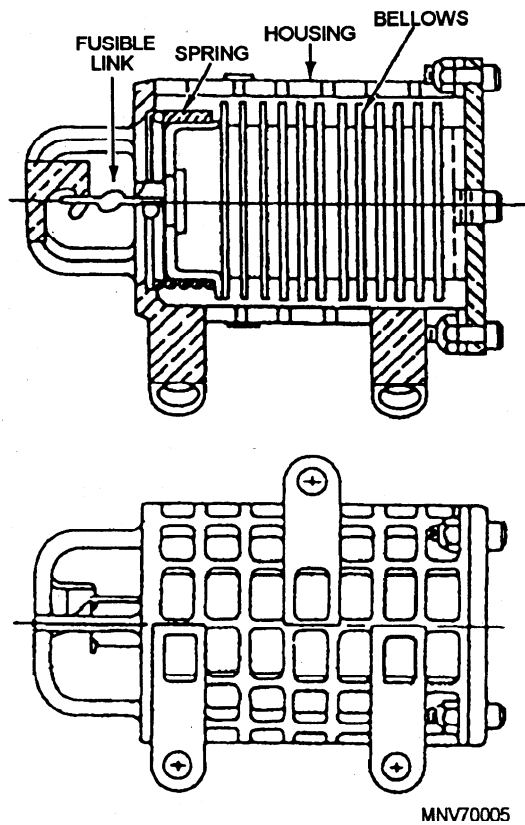

Figure 1-4.—Diaphragm-operated magazine sprinkler control valve.

MNV70004



MNV70005

Figure 1-5.—Heat-sensing device (HSD).

Heat-Sensing Device (HSD)

The HSD (fig. 1-5) is a thin-walled, air-filled, spring-loaded bellows designed to create a pressure in response to either a rapid or slow rise in temperature.

The spring and bellows are held in the compressed/expanded positions, respectively, by a fusible link that connects the bellows to the HSD housing. The fusible link is designed to part when the link temperature reaches 160°F (23°F).

HSDs are mounted on the overhead of the protected space and are connected to the manifold of the PRP valve by individual 1/8-inch transmission lines. A circle seal check valve is installed in each transmission line.

If an active fire occurs in the protected space, heat from the fire will be transferred to the air within the bellows, causing the air to expand and create a pressure. This pressure will be transmitted to the rear of the release diaphragm of the PRP valve, thereby creating the differential pressure necessary to trip the valve.

If a smoldering fire occurs, the pressure within the bellows will increase too slowly to trip the PRP valve. Therefore, the temperature will continue to increase. If it reaches 160°F (±3°F), the fusible link in the end of the collet will part, removing the restraint holding the bellows. The bellows will collapse under the tension of the spring and create a pressure impulse that will be transmitted to the rear of the release diaphragm of the PRP valve. This pressure impulse will create the differential pressure necessary to trip that valve.

Transmission Lines

The lines that connect the thermopneumatic elements to the PRP are called *transmission lines* and are Rockbestos®- or Rockhide®-covered seamless copper tubing.

Vented Check Valve

The vented check valve (fig. 1-6) is a brass, spring-loaded check valve designed to check against a rapid change of air pressure in one direction and to open when air pressure is applied in the other direction. One vented check valve is installed in each transmission line (above the PRP, with a maximum of 12 per PRP) from an HSD

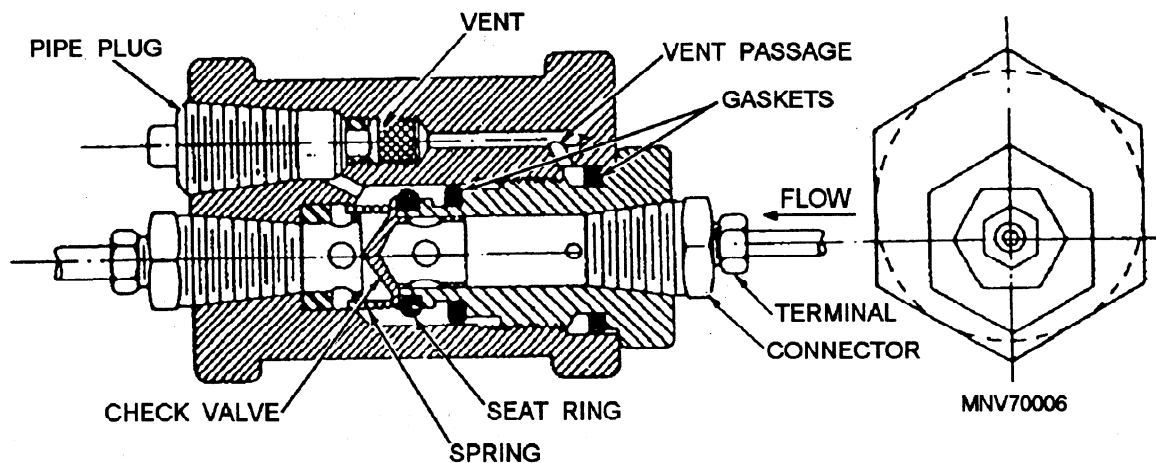

MNV70006

Figure 1-6.—Vented check valve.

with the direction-of-flow arrow pointing toward the PRP. Since the PRP manifold contains only six ports for transmission tubing connection, systems requiring seven or more HSDs will Tee together vented check valves, starting with the seventh check valve. The check valves prevent the rapid increase in air pressure created in an individual HSD from pressurizing the entire system. The check valve body contains a vent installed in a bypass around the main valve. The vent permits a slow backflow of air to equalize system pressure in response to normal changes in ambient temperature.

Pneumatically Released Pilot (PRP) Valve

The PRP valve (fig. 1-7) is a normally closed spring-loaded pilot valve that opens automatically to actuate the magazine sprinkler system in response to a pneumatic signal from one or more thermopneumatic elements.

The main components of the PRP valve are the operating mechanism, the compensating vent, and the pilot valve. The operating mechanism and the compensating vent are housed in a circular bronze case. The pilot valve is mounted on the front of the case and is installed in a 3/8-inch line that connects the firemain to the sprinkler system hydraulic control system piping.

The PRP valve case is provided with shock mounts and brackets for fastening to a bulkhead.

The operating mechanism consists of a spring-loaded operating lever operated by a release diaphragm through a series of linkages and levers. The rear of the release diaphragm is connected to the tubing from the HSDs. The front of the release diaphragm is open to the interior of the PRP valve case. When the PRP valve is set, the operating lever is cocked to hold the valve closed. A sudden or gradual increase in pressure transmitted from one or more HSDs will move the diaphragm, releasing the operating lever. As the operating lever moves, it causes the seat holder to move away from the seat, thereby permitting seawater to enter the hydraulic control system piping and actuate the sprinkler system.

The PRP valve is equipped with a compensating vent that leaks off the slight increases or decreases of pressure within the HSDs caused by normal temperature fluctuations in the protected compartment. This leakoff of slow pressure changes equalizes the pressure on both sides of the release diaphragm and prevents inadvertent tripping of the PRP valve. The compensating vent is calibrated at the factory and should not be adjusted by ship's force.

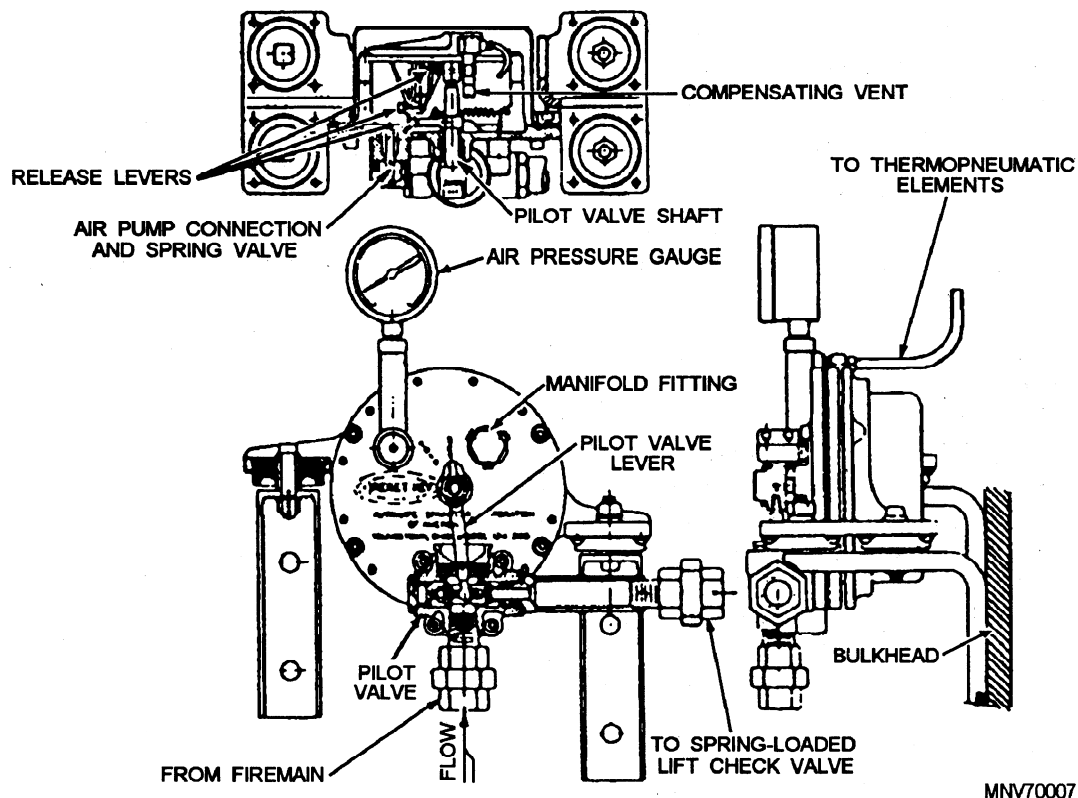

Figure 1-7.—Pneumatically released pilot (PRP) valve.

The rate-of-rise circuit is designed to trip the PRP valve and actuate the sprinkler system when sufficient heat is absorbed by the HSDs to create a definite pressure within the circuit over a given period of time. This pressure acts against the rear of the release diaphragm to create the pressure differential necessary to trip the PRP valve. A differential pressure of at least 8 ounces per square inch across the release diaphragm is necessary to trip the PRP valve.

NOTE

The gauge mounted on the front of the PRP valve indicates the pressure within the entire system-not the differential pressure. At times the gauge may indicate a positive pressure within the system. This is a normal condition caused by expansion of air within the system due to an increase in ambient temperature. The pressure indicated on the gauge exists on both sides of the PRP valve release diaphragm.

HYDRAULIC CONTROL SYSTEM

The hydraulic control system operates the valves in the dry-type magazine sprinkler system. It uses seawater from the firemain to actuate the magazine sprinkler control valve.

The hydraulic control system (which is better known as the operating pressure circuit) consists of the control system piping, a manual control valve, a hydraulically-operated remote-control valve, spring-loaded lift check valves, and a hydraulically-operated check valve (normally used with the diaphragm-operated magazine sprinkler valve) or a power-operated check valve (normally used with the piston-operated magazine sprinkler valve).

Operating Pressure Circuit (Control System Piping)

The operating pressure circuit is used to open and close the sprinkler control valves. It connects the manual control valves, the hydraulically-operated components of the control system, and the magazine sprinkler valve. The operating pressure circuit is divided into an OPEN loop and a CLOSE loop. The OPEN loop transmits operating pressure from the OPEN port of the manual control valve(s) to the operating chamber of the magazine sprinkler valve and the inlet of the hydraulically-operated check valve via the hydraulically-operated remote control valve. The

CLOSE loop transmits operating pressure from the CLOSE port of the manual control valve(s) to the operating pressure connections of the hydraulically-operated remote control valve and the hydraulically-operated check valve.

Manual Control Valve

The manual control valve is a rotary disk plate-type valve installed to permit rapid hydraulic operation of the magazine sprinkler valve. Most systems allow manual sprinkler activation and securing from either a local operating station or a remote station. This application uses the three-way, three-position manual control valve (fig. 1-8). Applications that do not incorporate a remote manual control station or an automatic control feature use a three-way, two-position manual control valve.

A locking device, in the form of a key, is installed in the control valve handle to prevent accidental operation of the sprinkler system. The locking key is secured to the handle with a single-strand lead-wire seal and fastened to the valve cover by a safety chain.

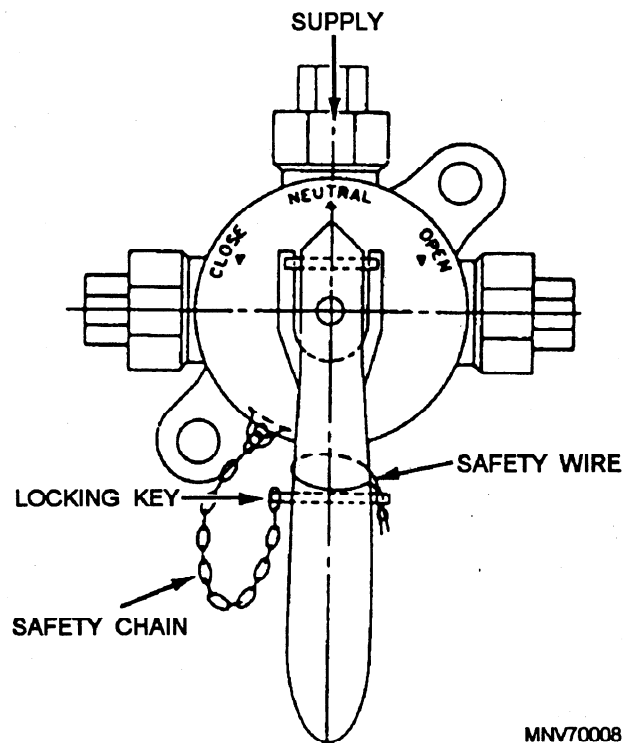

Figure 1-8.—Manual control valve.

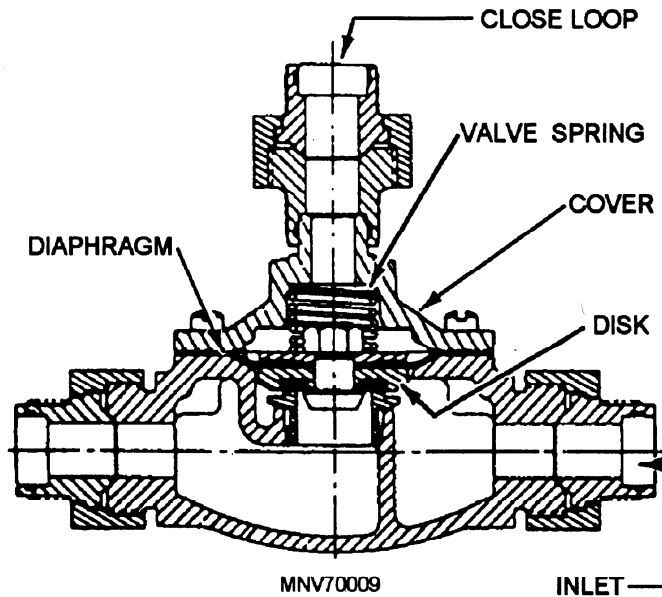

Figure 1-9.—Hydraulically-operated remote control valve.

Hydraulically-Operated Remote Control Valve

The hydraulically-operated remote control valve (fig. 1-9) is a diaphragm-operated, globe-type valve that is opened by operating pressure acting against the underside of the disk and closed by operating pressure acting on the top of the diaphragm. The purpose of this valve is to permit the magazine sprinkler valve to be secured from an operating station other than the one from which it was actuated. Additionally, this valve permits the magazine sprinkler valve to be secured from

any control station when it has been actuated automatically.

Spring-Loaded Lift Check Valve

This valve (fig. 1-10) is a spring-loaded, diaphragm-operated lift check valve that closes tightly against reverse flow and opens wide to permit flow in the normal direction. Spring-loaded lift check valves permit the control system to be operated from more than one control station by preventing backflow through the other stations.

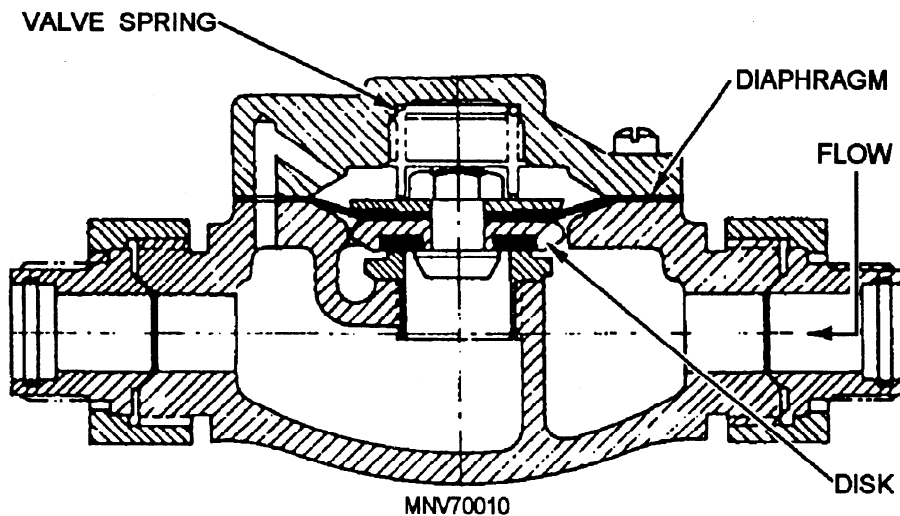

Figure 1-10.—Spring-loaded lift check valve.

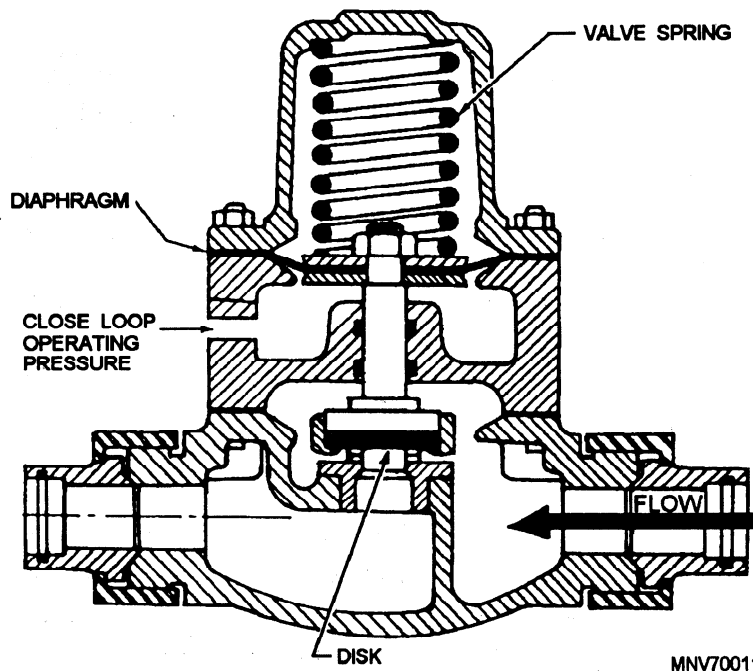

Figure 1-11.—Hydraulically-operated check valve.

Hydraulically-Operated Check Valve

The hydraulically-operated check valve (fig. 1-11) is a normally closed, diaphragm-operated, globe-type check valve that is opened by operating pressure in the CLOSE loop acting against the underside of the diaphragm. This valve permits the operating pressure to be vented from the diaphragm chamber of the magazine sprinkler valve, thereby permitting that valve to close rapidly and completely.

Orifices

Two 0.098-inch orifices are installed in the control system piping to prevent a buildup of pressure in the piping due to leakage past a control system component. The orifices also vent operating pressure from the control system piping when the manual control valve is returned to the NEUTRAL position. Orifice No. 1 is installed in the OPEN loop upstream from the hydraulically-operated check valve. Orifice No. 2 is installed in the CLOSE loop adjacent to the operating pressure connection of the hydraulically-operated check valve. When the control system is actuated, there will be a steady flow of water from orifice/drain line No. 1 and no flow from orifice/drain line No. 2. When the control system is secured, there will be a steady flow of water from orifice/drain line No. 2 and a diminishing flow from orifice/drain line No. 1. When the manual

control valve is returned to the NEUTRAL position, the operating pressure is vented from the CLOSE loop via orifice/drain line No. 2, thereby permitting the hydraulically-operated check valve to close.

MAGAZINE ALARM SYSTEMS

Several types of warning devices or systems are used on board ship. One of them is the alarm system activated by the water switch (fig. 1-12) on the dry side of the sprinkler system main (group) control valves. This alarm is designated *FH* and indicates by sound or light that the main control valve is open or leaking.

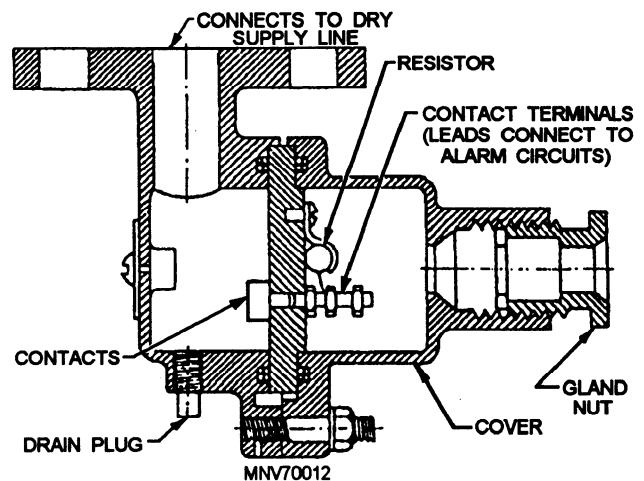

Figure 1-12.—FH alarm sensor.

Another type of alarm is the flooding alarm, designated *FD*, that incorporates a float switch located near the deck. As water accumulates on the deck, the float rises, making a set of contacts and sounding an alarm. If the sprinkler system is actually activated, both alarms should sound within seconds of each other.

Another type of alarm system, designated the *F* alarm, is actuated by heat. This alarm sounds when the temperature in an ammunition stowage area rises to 105°F. The sounding of this alarm allows the temperature to be reduced before sprinkling becomes necessary.

SYSTEM TESTING

Each sprinkling system must be tested regularly to be sure that it operates properly. During the test, all components that should operate during an actual use are tested. This is a major test that, if not conducted properly, could cause damage to both equipment and careers. Therefore, if you participate in a sprinkling system test, follow the approved testing procedures exactly. The proper officials (weapons Officer, DC Central, OOD, etc.) should have been notified, and the appropriate tag out procedures should have been completed. We will not discuss the specific procedures, but we do need to briefly discuss the use of the test casting.

Look back at the magazine sprinkler control valve in figure 1-4. If the system is tested without somehow blocking the flow of water through the valve, firemain water will flow rapidly into the magazine distribution piping and will probably damage the stores in the magazine. To allow the valve to be tested without wetting the magazine, the manufacturers of the control valve developed a special plug, called the *test casting*.

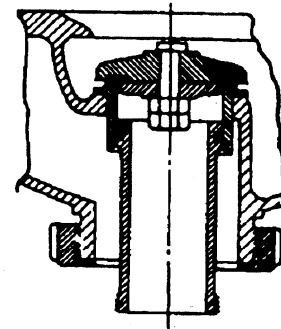

MNV70013

Figure 1-13.—Test casting installed in a magazine sprinkler control valve.

The test casting is simply a bypass attachment that allows system water to flow out of the bottom of the control valve, rather than through its normal exit port. Before the control valve is tested, the bottom cap of the valve is removed and the test casting is screwed, hand tight, into the bottom of the valve seat, as shown in figure 1-13. As long as the test casting is properly installed, no water will flow into the magazine during the system test.

If you are assigned to install a test casting, be sure to install the correct casting. Your ship will have the same number of test castings as it does sprinkler system control valves because each valve comes from the manufacturer with its own test casting. Test castings are not interchangeable. When a valve is received on board a ship, the valve and its test casting are both stamped with the same, unique number. Be sure the test casting you install has the same identification number as the valve you plan to test.

CHAPTER 2

SMALL ARMS

LEARNING OBJECTIVES

Upon completing this chapter, you should be able to do the following:

1. Discuss the operation and maintenance of Navy small arms, and the special precautions associated with those small arms.
2. Describe the cycle of operation, disassembly, assembly, and safeties of Navy handguns, shoulder weapons, and machine guns.
3. Describe the operating cycle, safeties, and maintenance of the Remington M870 shotgun.
4. Discuss the Mk 87 Mod 1 line-throwing kit and describe what is needed in preparation for firing.
5. Describe the controls, safeties, and operation of the M79 grenade launcher.

SMALL ARMS FUNDAMENTALS

The term *small arm* means any firearm with a caliber (cal.) of .60 inch or smaller and all shotguns. Since there are no .60-cal. weapons in the Navy, all pistols, rifles, shotguns, and machine guns up through .50 cal. are small arms.

In this chapter we will review small arms nomenclature and operation, as well as how small arms operate in the automatic and semiautomatic modes. We will then describe the small arms currently used by the Navy—including hand guns, shoulder weapons, shotguns, and machine guns. We will conclude with brief discussions on small arms special precautions, maintenance, storage and issue requirements, and range duties.

As a Mineman on board mine countermeasures ships, you will be concerned with pistols, rifles, shotguns, and machine guns. Your responsibility in the field of small arms is twofold. First, you must know how to use and maintain them. Second, you must be able to train other personnel in their operation, safe handling, and maintenance.

Most small arms are procured from the Army and issued by the Navy to its field activities and the fleet. Information on basic operator maintenance is provided

on maintenance requirement cards (MRCs), but all other information (operation, troubleshooting, parts lists, and so on) is normally found in Army technical manuals (TMs) and field manuals (FMs). FMs and TMs list the spare parts, special tools, and organizational maintenance procedures for a particular weapon. The FM is the operator's manual, intended for personnel in the field who must maintain the weapon. OP 0 also lists TMs, FMs, and OPs that pertain to small arms.

SMALL ARMS NOMENCLATURE

Before we begin the study of the individual weapons, we need to examine some of the quirks in small arms nomenclature (names of the parts). Generally, terminology pertaining to the weapons themselves is fairly standard because the Navy has adopted most of the Army's system of identification. Minor differences do exist, however. For example, the Army's carbine M1A2 is known in the Navy as the carbine Mk 1 Mod 2. Notice that the Navy uses the abbreviations Mk (mark) and Mod (modification) as the equivalents of the Army's letter designations *M* and *A*.

The diameter of a shotgun's bore is referred to as the *gauge* of the shotgun. Gauge (with the exception of the .410 shotgun) is not a measurement of inches or millimeters. Instead, it is the number of lead balls of

that particular diameter required to make a pound. For example, if you measure the diameter of a 12-gauge shotgun's bore, you will find it to be 0.729 inch. If you were to make a number of lead balls of this diameter and weigh them, you would find that 12 of them make a pound.

So the larger the bore of a shotgun, the smaller the gauge number. A 16-gauge shotgun, for example, has a smaller bore than a 12-gauge.

CYCLES OF OPERATION

Every weapon has a cycle of operation. This cycle is a group of actions that takes place when a round is fired and that must occur before the next round can be fired. In the automatic small arms currently used by the Navy, the sequence of actions or the way they take place may vary between weapons of different design; however, they always occur.

There are eight steps in the cycle of operation, as shown in figure 2-1. We will briefly discuss each step.

Feeding

The feeding action places a round in the receiver just to the rear of the chamber. In its simplest form it amounts to putting a cartridge by hand in the path of the device that will chamber the round. Most often, feeding is done by a spring-loaded follower in a magazine. However, magazines have a limited capacity that

cannot sustain the continuous rate of fire required by machine guns. Therefore, machine gun ammunition is belted, and the rounds are fed to the rear of the chamber by cam and lever action.

Locking

The locking action holds the bolt in its forward position for a short time (after firing) to prevent the loss of firing gas pressure until the bolt is unlocked by other forces. For low-power weapons, it is possible to seal the breech for a short time by merely increasing the weight of the bolt. The bolt starts to move as soon as the weapon fires. But if the bolt is sufficiently heavy, it will not move far enough to release the gases until their pressure has been satisfactorily reduced. This method is used by submachine guns and other straight blowback-operated small arms such as .22-cal. rimfire autoloading pistols.

Firing

The firing action occurs when the firing pin strikes the primer of the cartridge.

Unlocking

Unlocking occurs after the firing of the round. Actions for unlocking are just the reverse of those required for locking. For most rifles, the first movement of the bolt is a rotating movement that disengages the locking lugs.

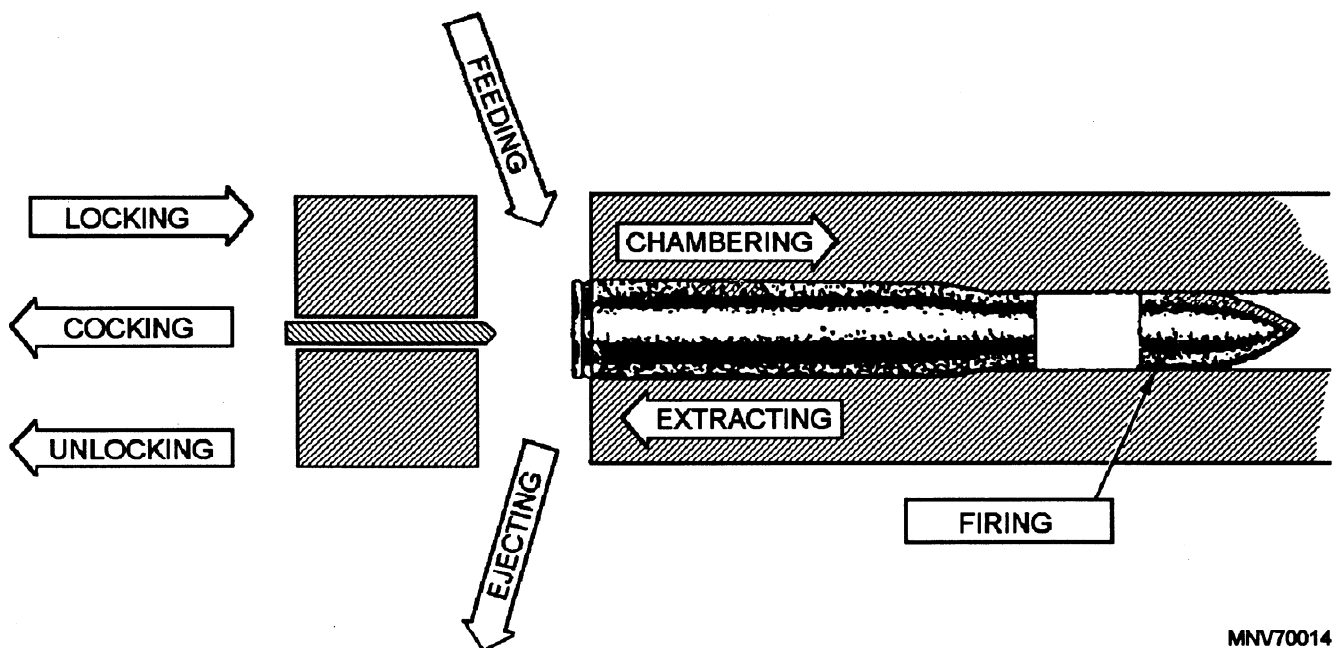

MNV70014

Figure 2-1.—The small arms cycle of operation.

Extracting

The extracting action pulls the empty case out of the chamber. The extractor (normally a small hooked piece of metal encased in the bolt) snaps over the rim of the cartridge case when the round is chambered. As the bolt moves rearward after firing, the extractor hauls out the empty brass.

Ejecting

In addition to being pulled out of the chamber, the case must also be thrown free of the receiver. This action is called ejection and is created by placing a small projection on one side of the receiver so that, as the bolt and case move to the rear, the case will strike the projection and be expelled from the weapon. This method is used in the .45-cal. pistol. Another method of ejecting the case is to incorporate a spring-loaded ejector in the face of the bolt. In this arrangement the case is flipped from the weapon as soon as its forward end clears the chamber. This method is used in the M14 rifle.

Cocking

Cocking is the retraction of the firing mechanism (firing pin and hammer) against spring pressure so that there will be sufficient energy to fire the cartridge in the next cycle of operation. The firing pin, hammer, or, in some cases, the bolt itself is held in a cocked position by a piece called the *sear*.

Firing is initiated by squeezing a trigger. This movement trips the sear, releasing the firing mechanism (firing pin, hammer or, in automatic weapons, such parts as the bolt group), causing it to move forward with enough force to discharge the round.

AUTOMATIC AND SEMIAUTOMATIC FIRING SYSTEMS

A semiautomatic weapon unlocks, extracts, ejects, cocks, and reloads automatically. However, the trigger must be pulled each time to fire a round. By this definition, the .45-cal. M1911A1 pistol is semiautomatic, though it is often called automatic. A fully automatic weapon keeps on firing as long as the trigger is kept pulled.

Two examples of weapons that can be fired both automatically and semiautomatically are the 7.62-mm M14 rifle and the 5.56-mm M16 rifle.

OPERATING PRINCIPLES

Automatic and semiautomatic weapons are classified by how they obtain the energy required for operation. Fundamentally, small arms obtain their operating energy from the forces of the explosion created when a round of ammunition is fired. The use of these forces does not reduce the effectiveness of the weapon; it simply uses otherwise wasted energy.

Methods of Operation

There are three basic types of operation for automatic and semiautomatic small arms—gas operation, recoil operation, and blowback operation. Figure 2-2 shows the three methods.

GAS OPERATION.—In gas-operated weapons, a portion of the expanding powder gases behind the bullet is tapped off into a gas cylinder located beneath the barrel. (The hole connecting the barrel and cylinder is near the muzzle end.) As the bullet passes this hole, gases push this piston rearward. The piston is connected by a rod to an operating mechanism of the weapon, such as the bolt. The piston carries the bolt rearward with it, unlocking the bolt, extracting and ejecting the case, and cocking the weapon.

RECOIL OPERATION.—As a round is fired, high pressures develop behind the bullet and force it down the barrel. The force behind the bullet is also directed rearward against the breech. If the barrel and bolt are secured to one another, the entire force of recoil is felt on the shooter's shoulder. But, by designing the barrel and breech assembly so they can slide in the frame or receiver, the energy of the rear moving assembly can be used to compress springs, move levers, and so on, necessary to complete the cycle of operation.

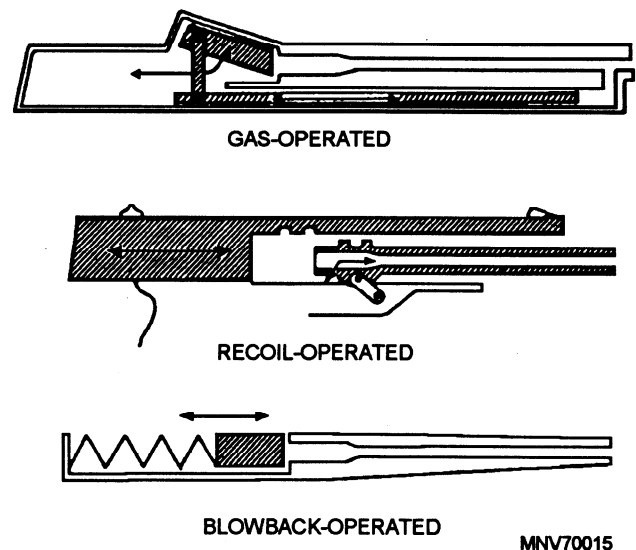

Figure 2-2.—Types of operating systems.

MNV70015

Generally, in recoil-operated weapons, the barrel and the bolt move rearward together for a short distance. Then the barrel is stopped and the bolt (now unlocked) continues to the rear against spring pressure until the empty case is ejected. The force of recoil is also used to cock the weapon and to compress the spring, returning the bolt to its firing position, and chambering a new round in the process.

There are two basic methods of recoil operation for semiautomatic and automatic small arms. They are the long-recoil (Browning) and short-recoil (Maxim) methods.

Long-Recoil Method.—The dynamics of a long-recoil operation are similar to those in straight blowback operation, except that the barrel, breechblock, and component parts recoil together for the complete recoil cycle. This recoil distance must be greater than the length of the complete round. At the end of the recoil stroke, the bolt is held while the barrel counterrecoils alone. One important difference in the long-recoil type of operation is that ejection takes place on counterrecoil instead of recoil. An example of a long-recoil weapon is the Browning designed, Remington model 11 shotgun used by the Navy before and during World War II.

Short-Recoil Method.—The dynamics of short-recoil-operated weapons approach those of the retarded blowback types more nearly than those of the long-recoil type. To eliminate all blowback tendencies, the bolt latch is not released until the propellant gases become ineffective. After unlatching (unlocking), the bolt continues recoiling and in some mechanisms is accelerated by mechanical or gas systems. The barrel is arrested by a spring, a buffer, a stop, or a combination of these and is caused to return by these or the counterrecoiling components. Examples of short-recoil-operated weapons are the .45-cal. pistol and the Browning machine gun.

BLOWBACK OPERATION.—There are some similarities between recoil- and blowback-operated weapons, but there are also several major differences. In recoil operation, the bolt and the barrel are locked together until the bullet has left the barrel and most of the recoil thrust is spent. The combined thrust of the recoiling barrel, bolt, and some other parts is used to operate the weapon. In blowback (inertia) operation, however, the bolt is not locked to the barrel and in most cases the barrel does not recoil. The bolt is held closed by spring pressure and the mass of the breechblock. The initial blow of the exploding cartridge starts the bolt moving rearward, but the weight of the bolt is such that

it does not allow the chamber to be entirely opened until the round has left the bore. Action by a recoil spring returns the bolt to the closed position, chambering anew round.

Thus, the weight of the breechbolt is an important factor in the design and operation of a blowback-operated weapon. When used with low-powered ammunition, it is a suitable arrangement. A military rifle, however, using the standard .30-cal. cartridge and the blowback action would require a 27-pound breechblock.

Besides the submachine gun, many types of so-called pocket automatic pistols and .22-cal. automatic rifles use blowback operations.

Range and Rate of Fire

Every weapon has a certain range (how far the bullet goes) and rate of fire (how fast it fires). The range of a weapon is usually indicated in terms of maximum range and maximum effective range. The rate of fire of an automatic weapon is stated as the cyclic rate of fire and the sustained rate of fire.

MAXIMUM RANGE.—Maximum range is the greatest distance that the bullet will travel.

MAXIMUM EFFECTIVE RANGE.—Maximum effective range is the greatest distance at which a weapon may be expected to fire accurately to inflict damage or casualties.

CYCLIC RATE OF FIRE.—The cyclic rate of fire is the maximum rate at which a weapon will fire in automatic operation, stated in rounds per minute (rpm).

SUSTAINED RATE OF FIRE.—The sustained rate of fire is normally indicated in a chart that correlates the average number of rounds fired per minute with the number of minutes this rate can be sustained without causing damage to the weapon.

HANDGUNS

The Navy currently has three types of handguns in its inventory: the M1911A1 .45-caliber semiautomatic pistol; the 9mm, M9 semiautomatic pistol; and the .38-caliber revolver. We will discuss the operation, disassembly, and assembly of the .45-caliber and 9mm pistols below.

M1911A1 .45-CALIBER PISTOL

The .45-cal. M1911A1 pistol (fig. 2-3) is a recoil-operated, semiautomatic, magazine-fed, self-loading handgun with fixed sights. It is often called a .45-cal.

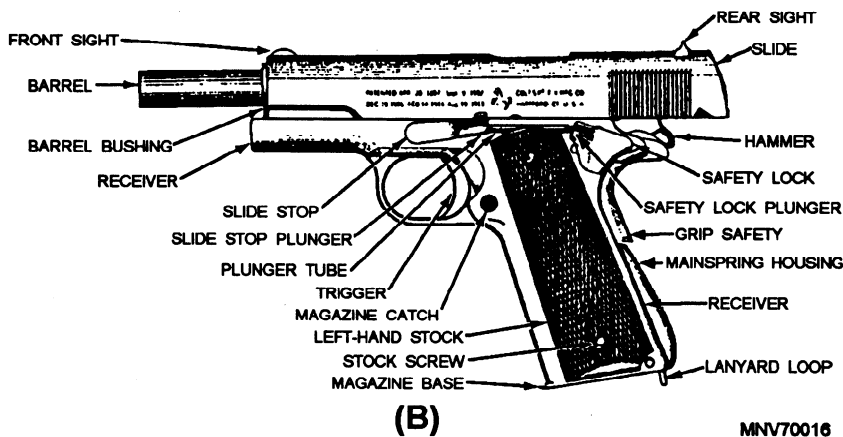
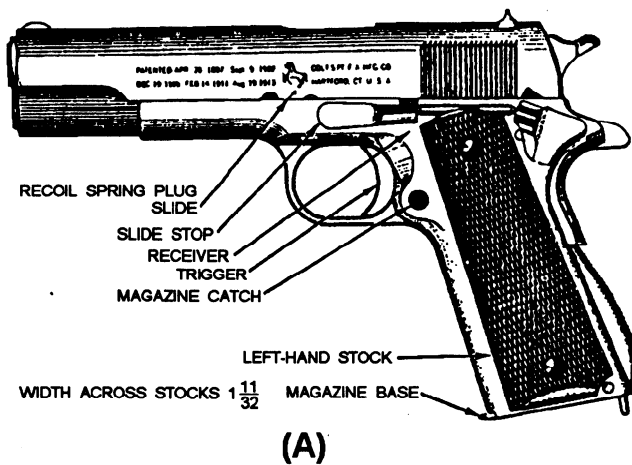

Figure 2-3.—.45-cal. M1911A1 semiautomatic pistol: A. Slide closed; B. Slide open.

semiautomatic pistol (SAP) or a .45-cal. autoloading Colt (the manufacturer) pistol (ACP). This text will refer to it as a .45-cal. pistol.

The magazine holds seven rounds when fully loaded; one round is fired with each squeeze of the trigger. Rifling in the barrel is machined for a left-hand twist (the only Navy weapon with left-hand rifling). Empty, the pistol weighs approximately 2 1/2 pounds. It has a maximum range of a little over 1,600 yards and a maximum effective range of about 50 yards.

Disassembly

Care of the .45-Cal. pistol includes daily preventive maintenance, prefiring cleaning, and postfiring cleaning. For daily maintenance the pistol need not be disassembled; but, for the prefiring and postfiring cleaning, the pistol should be disassembled.

General disassembly (fig. 2-4) is necessary for normal care and cleaning, and after the weapon has been fired.

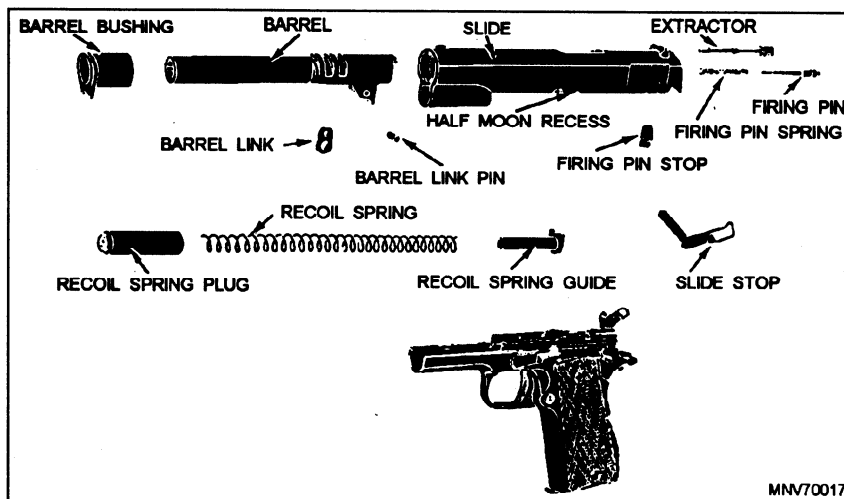

Figure 2-4.—A field-stripped .45-cal. pistol.

To do a good job of cleaning and inspecting the weapon, you must know the names of the parts. By knowing the names of the parts, you will also be able to better understand how the weapon operates.

GENERAL DISASSEMBLY (FIELD-STRIPPING).—Before you performing work on any weapon, be sure the weapon is clear of ammunition. On the M1911A1, you do this by removing the magazine, pulling the slide to the rear, and inspecting the chamber. When you have cleared the weapon, perform the following steps:

1. Cock the hammer and put the safety lock in its UP (safe) position. Depress the recoil spring plug and turn the barrel bushing about one-quarter turn clockwise. This releases the tension on the spring. Allow the spring to expand slowly, under control, to prevent injury or loss of parts. Turn the recoil spring plug counterclockwise and remove it from the recoil spring. Move the safety lock back down to its FIRE position.

2. Draw the slide to the rear until the half-moon recess (on the slide) is directly above the projection on the slide stop. Push out the slide stop from right to left.

3. Turn the pistol upside down and draw the receiver to the rear, disengaging it from the slide. Lay the receiver down.

4. Draw the recoil spring and its guide to the rear and out of the slide.

5. Take the barrel bushing out of the slide by turning it counterclockwise as far as it will go, then lifting up.

6. Lay the barrel link forward and pull the barrel out of the muzzle end of the slide.

7. Take out the firing pin by pressing on the rear of the firing pin with any pointed object until you can slide out the firing pin stop. Keep your fingers over the firing pin, allowing the spring tension to ease; then lift both the firing pin and the spring from the slide.

8. Pry the extractor out of the rear of the slide.

Safeties

There are three safety features and one positive safety on the .45-cal. pistol. The three safety features are the half-cock notch, the grip safety, and the disconnector. The positive safety is the safety lock (sometimes called the thumb safe).

The safety lock positively locks the slide in the forward position. In addition, a stud on the safety lock (fig. 2-5, view A) blocks the shoulders of the sear to

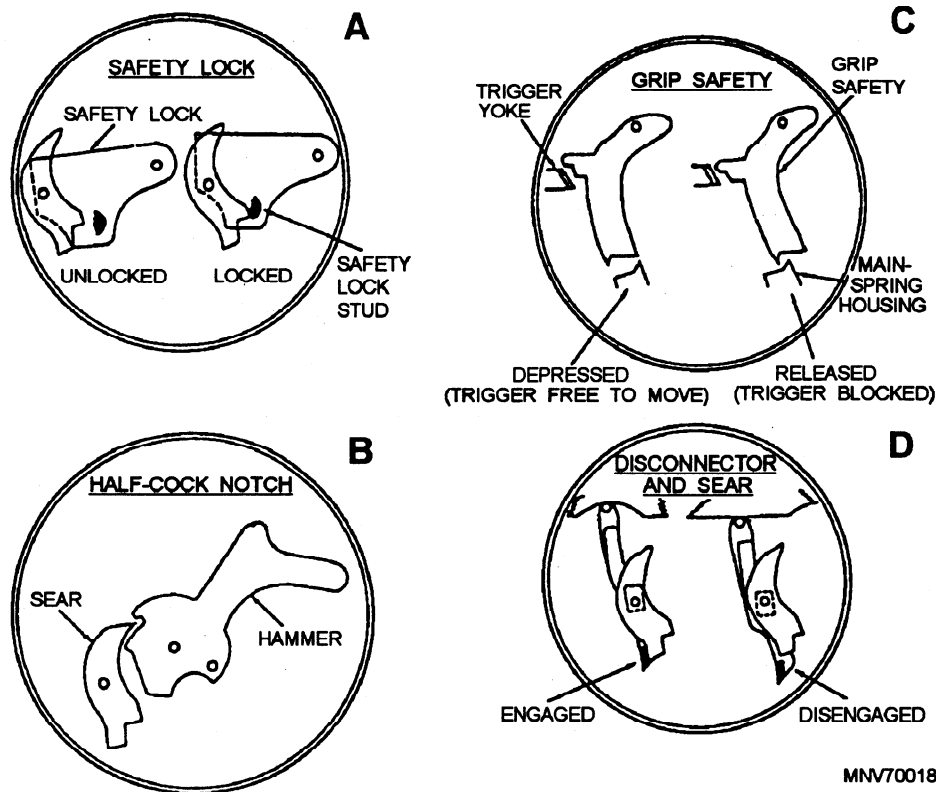

MNV70018

Figure 2-5.—Safeties on the .45-cal. pistol.

prevent any movement of the sear out of the full-cock notch of the hammer.

The half-cock notch is the notch just above the full-cock notch (fig. 2-5, view B). It has a lip that keeps the sear from moving out of the notch when pressure is applied to the trigger.

The grip safety (fig. 2-5, view C) indirectly stops any movement of the sear by blocking trigger movement. If the trigger cannot be actuated, the sear cannot move and the hammer will not fall.

The disconnecter (fig. 2-5, view D) prevents firing unless the slide is fully forward and locked. Any time the slide is not fully forward, the nose of the disconnecter is forced downward. In this condition the disconnecter spade does not contact the sear when the trigger is pulled. When the trigger is pulled, the disconnecter will be pushed to the rear; but the sear remains in position, holding the hammer to the rear.

When the slide is forward, the disconnecter rides up into a recess on the underside of the slide. The spade of the disconnecter (dark area) bears against lugs on the sear. When the trigger is pulled, the trigger yoke pushes back against the disconnecter spade, which transmits the motion to the sear, rotating the sear nose out on the full-cock notch of the hammer, and the weapon fires.

Cycle of Operation

Refer to figures 2-3 and 2-4 as we explain the functions of the pistol. We will assume that a loaded magazine has been placed in the weapon, a round loaded into the chamber, the grip safety depressed, the trigger squeezed, and the round fired. The cycle of operation now begins.

As the gases from the burned powder expand, the bullet is forced down the barrel while an equal force is directed rearward against the slide. The slide and the barrel are locked together at this point, and both are forced rearward. The barrel link is pinned to the receiver by the slide stop shaft and to the barrel by the barrel link pin. As the barrel moves rearward, it pivots on the slide stop shaft and is moved downward as well as to the rear. As the barrel locking ribs are disengaged from the recesses in the slide, unlocking is completed.

As the slide moves aft in recoil, the extractor pulls the empty case along with it. Extraction is completed when the cartridge clears the chamber.

Ejection occurs when the cartridge strikes the stationary ejector, pivots on the extractor, and flips from the weapon through the ejection port.

Cocking began as soon as the slide started its recoil movement. The hammer is moved rearward and the hammer strut is pushed down against the mainspring, compressing it. When the slide strikes the recoil spring guide collar, its rearward movement is stopped. The recoil spring then causes the slide to begin its forward movement. The hammer follows the slide for a short distance. Then the sear, which bears against the hammer through the action of the sear spring, enters the full-cock notch of the hammer and holds it in a cocked position. Feeding starts as soon as the slide, moving to the rear, clears the top of the magazine. The magazine follower, under pressure from the magazine spring, forces the top round against the lips of the magazine. This places the top cartridge in position to be picked up by the face of the slide during its forward movement.

Chambering occurs when the forward moving slide pushes a new round into the chamber. As the bullet is pushed up the ramp into the chamber, the base of the cartridge slides up the face of the slide. As this happens the groove on the base of the cartridge is engaged by the hooked extractor.

After chambering, the slide continues forward a small distance, pushing the barrel ahead of it. As the barrel moves, it pivots up and forward on the barrel link. The locking ribs on the barrel enter the locking recesses in the slide, thereby locking the two together.

Firing will start the cycle all over again. When the grip safety is depressed and the trigger is squeezed, the trigger yoke presses against the disconnecter, which pushes aft on the sear. The sear rotates on its pin, disengaging from the notch on the hammer. The mainspring pushes up on the hammer strut, rotating the hammer forward. The hammer strikes the firing pin which, in turn, strikes the cartridge primer.

For more information on the M1911A1 .45-Cal. pistol refer to U.S. Army TM 9-1005-211-12.

Section I. GENERAL INFORMATION

9mm PISTOL

1. FIRING PIN BLOCK
2. EXTRACTOR/LOADED CHAMBER INDICATOR
3. TRIGGER
4. FRONT SIGHT
5. SLIDE ASSEMBLY
6. DISASSEMBLY LEVER
7. SLIDE STOP
8. REAR SIGHT
9. DECOCKING/SAFETY LEVER
10. HAMMER
11. RECEIVER
12. GRIP
13. LANYARD LOOP
14. MAGAZINE (SEATED)
15. MAGAZINE CATCH ASSEMBLY
16. DISASSEMBLY BUTTON

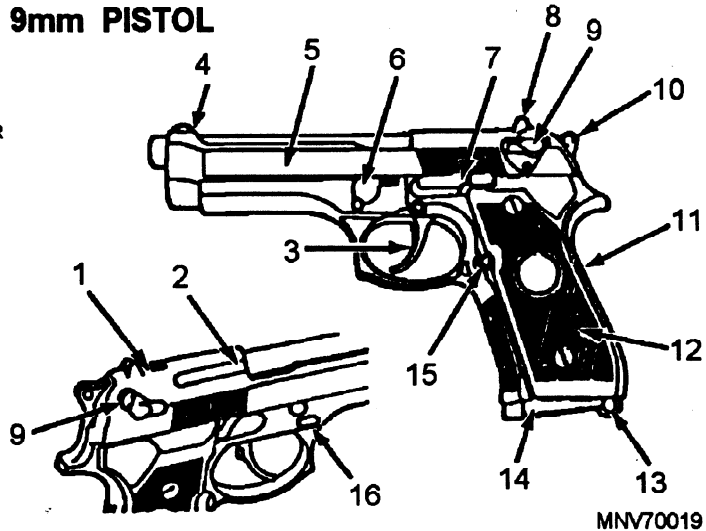

Figure 2-6.—9mm, M9 semiautomatic pistol.

9MM, M9 SEMIAUTOMATIC PISTOL

The 9-mm, M9 pistol (fig. 2-6) is a single- or double-action, short-recoil-operated, semiautomatic, magazine-fed, self-loading handgun with fixed sights. The M9 is primarily designed as a personal defense sidearm for guards, sentries, and boarding and landing parties.

The M9 is chambered for the 9-mm cartridge. The magazine (fig. 2-7) has a capacity of 15 rounds, which is more than double that of the traditional magazine of the same length. Empty, the pistol weighs approximately 2.1 pounds. It has a maximum range of 1,962.2 yards (1,800 meters) and a maximum effective range of 54.7 yards (50 meters).

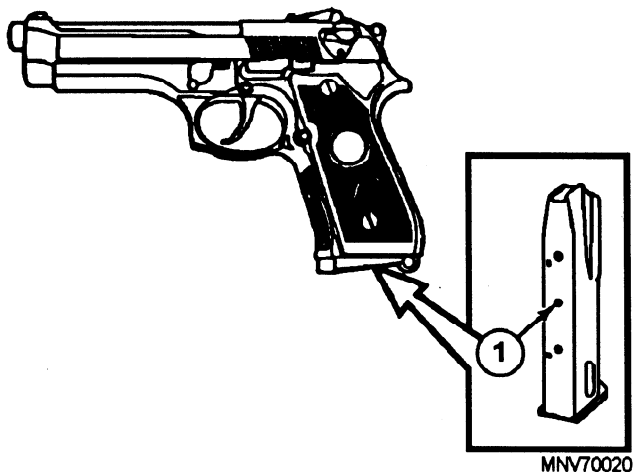

Figure 2-7.—M9 magazine.

Operation

The M9 pistol has a short recoil system using a falling locking block. The pressure developed by the expanding gases of a fired round recoils the slide and barrel assembly. After a short distance, the locking block is disengaged from the slide, the barrel stops against the frame, and the slide continues its rearward movement. The slide then extracts and ejects the fired cartridge case, cocks the hammer, and compresses the recoil spring. The slide moves forward, stripping the next cartridge from the magazine, and feeds it into the chamber. After the last cartridge has been fired and ejected, the slide and barrel assembly will remain open by the magazine follower pressing up on the slide stop lever.

Disassembly

Disassembly of the M9 is covered by current 3-M Systems MRCs and is normally limited to the general disassembly (field-stripping) level. The M9 is designed for ease of field stripping under adverse conditions. With practice, you should be able to field strip it in seconds. Before you begin disassembling the pistol, remove the magazine and be sure that the pistol is unloaded. You can disassemble and assemble the pistol with the safety in either the ON or OFF position. But for safety purposes, and to prevent damage to the pistol, always engage the safety (ON position, warning dots covered, down position) before you begin disassembly.

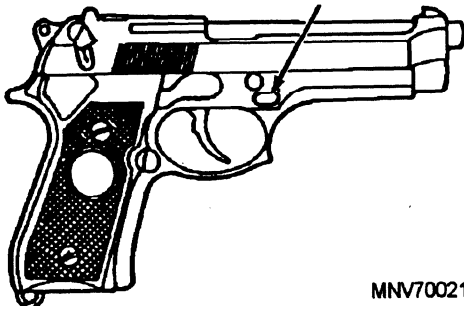

MNV70021

Figure 2-8.—Disassembly lever release button.

To field strip the M9, hold the pistol in your right hand with the muzzle slightly elevated. With your forefinger, press the disassembly lever release button (fig. 2-8), and with your thumb rotate the disassembly lever (fig. 2-9) downward until it stops. Pull the slide and barrel assembly (fig. 2-10) forward and remove it from the receiver assembly.

WARNING

Be careful as you remove the recoil spring and the spring guide. The assembly is under spring tension. If you let it fly from the pistol, it could injure you or become damaged or lost.

Firmly hold the slide in the palm of one hand and slightly compress the recoil spring and spring guide (fig. 2-11). At the same time, lift and remove the recoil spring and the spring guide (fig. 2-12). Be careful as you release the spring tension. After you have released the spring tension, separate the recoil spring from the spring guide (fig. 2-13).

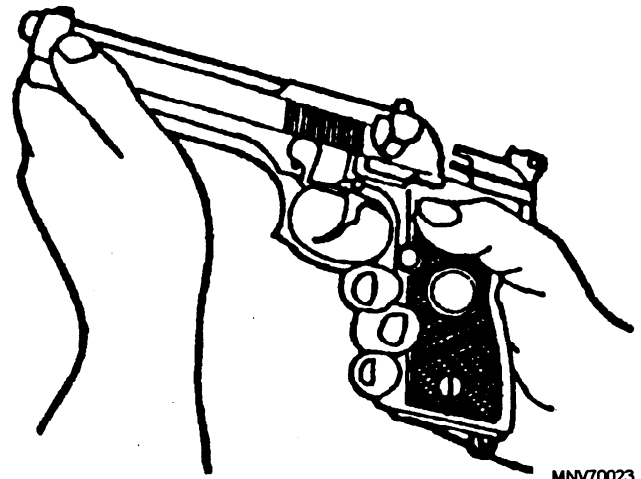

MNV70023

Figure 2-10.—Removal of slide and barrel assembly.

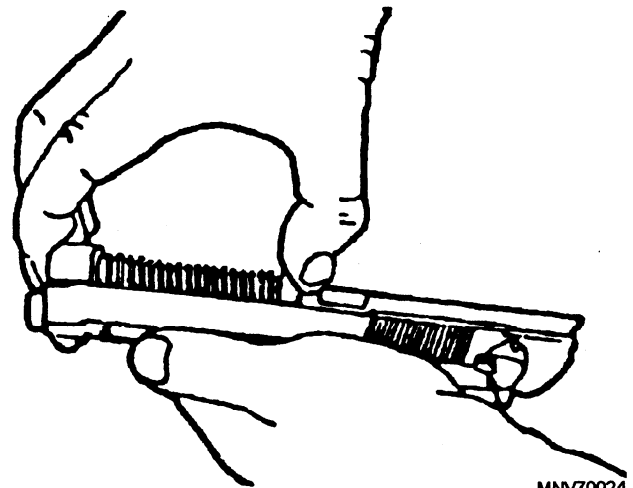

MNV70024

Figure 2-11.—Compressing the recoil spring.

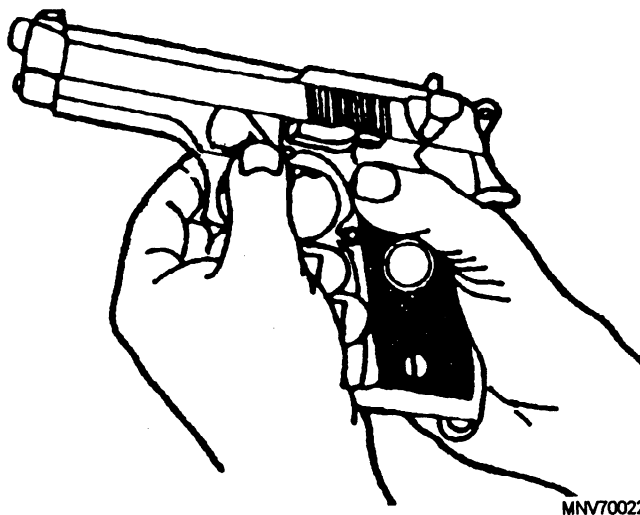

MNV70022

Figure 2-9.—Disassembly lever.

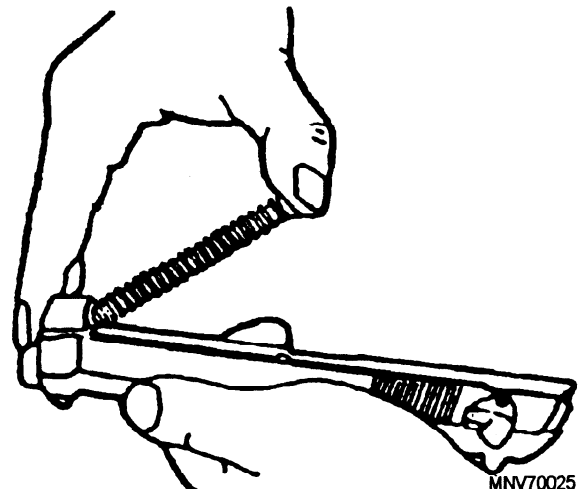

MNV70025

Figure 2-12.—Removing the recoil spring and spring guide.



MNV70026

Figure 2-13.—Recoil spring and spring guide.

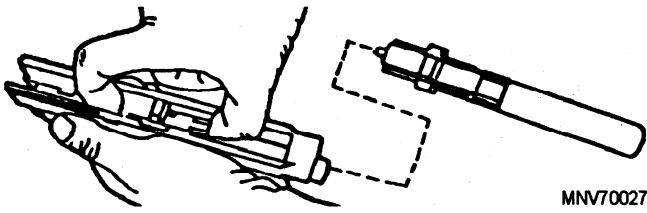

Figure 2-14.—Removing the barrel from the slide.

To remove the barrel from the slide, push in on the locking block plunger (fig. 2-14) while pushing the barrel forward slightly. Lift and remove the locking block and the barrel assembly from the slide.

When you have disassembled the pistol, check the parts for damage or excessive wear as you clean them. For more information on the M9 pistol, refer to Navy SW 370-AA-OPI-010/9mm.

SHOULDER WEAPONS

Shoulder weapons are designed to be held with both hands; they are braced against the shoulder to absorb the force of recoil and to improve accuracy. The primary Navy shoulder weapons are the M14 rifle, the Remington M870 shotgun, and the M79 grenade launcher. We will discuss the operation and maintenance of each of these weapons.

M14 RIFLE

The M14 rifle (fig. 2-15) is a lightweight, air-cooled, gas-operated, magazine-fed shoulder weapon. It is designed for both semiautomatic fire and fully automatic fire (750 rounds per minute). The M14 is chambered for 7.62-mm cartridges and can

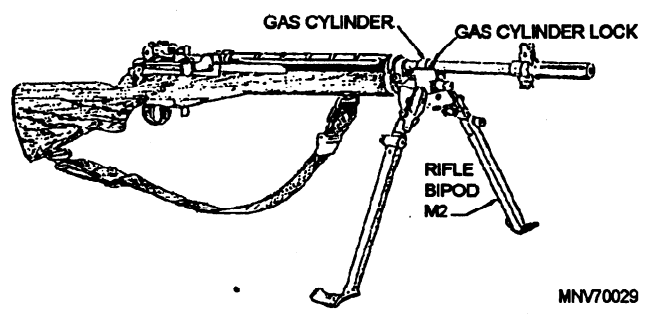

Figure 2-16.—7.62-mm M14 rifle with the bipod installed.

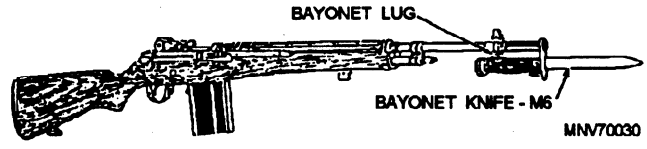

Figure 2-17.—7.62-mm M14 rifle with the M6 bayonet knife.

accommodate a 20-round cartridge magazine, the M2 rifle bipod (fig. 2-16), and the M6 bayonet (fig. 2-17).

M14 Rifle Controls

Figure 2-18 shows an M14 rifle equipped with a selector for automatic operation. Position the selector as in view A for semiautomatic fire and as in view B for automatic fire. Most of the M14 rifles issued to the Navy will not be equipped with the automatic selector; only semiautomatic fire will be possible.

The safety is located just forward of the trigger guard. To prevent the weapon from firing, press the safety rearward. To permit firing, press the safety forward. The safety can only be engaged when the weapon is cocked.

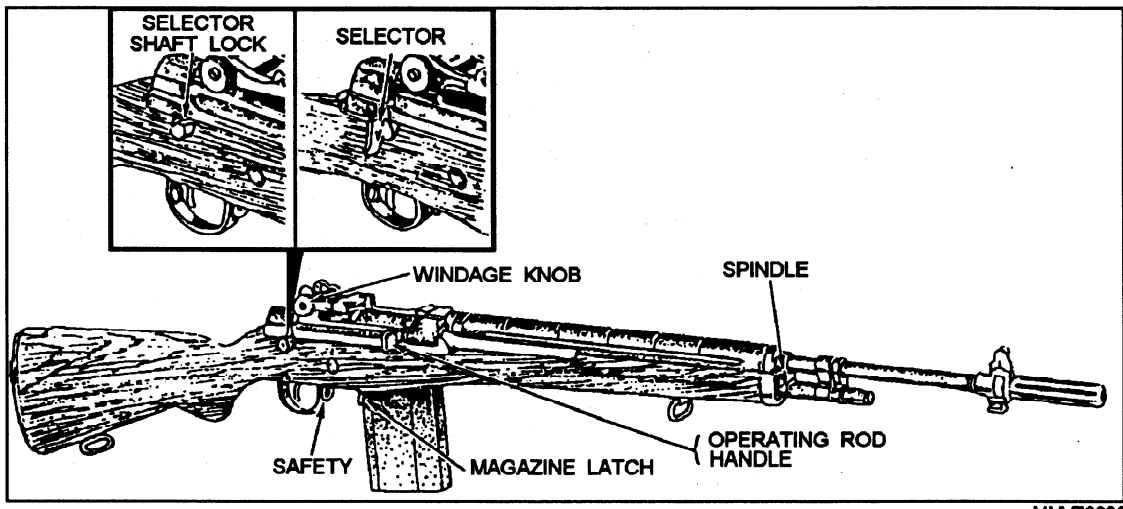

Figure 2-15.—7.62-mm M14 rifle and controls—right-front view.

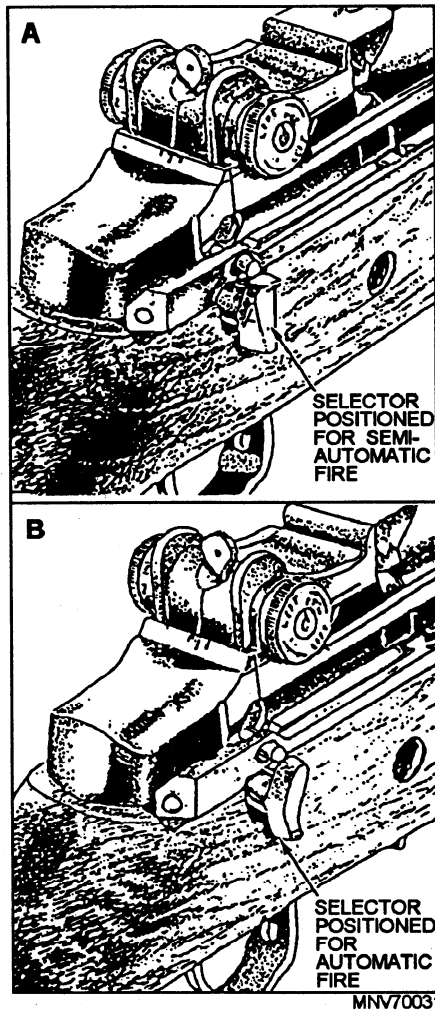

Figure 2-18.—Selector for automatic and semiautomatic fire.

If a magazine is in the rifle, press the magazine latch (fig. 2-19) and remove the magazine. Pull the operating handle all the way to the rear and check to see that the weapon is free of ammunition. Then ease the operating rod forward to the locked position and move the safety to the rear (SAFE position).

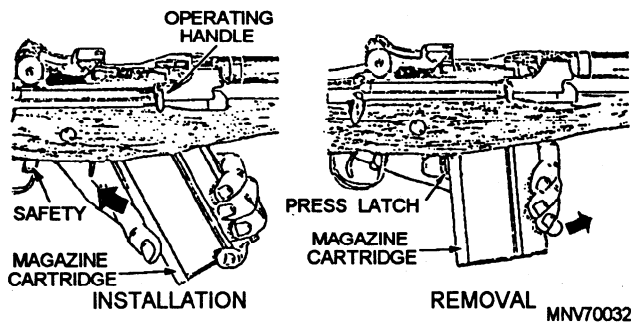

Figure 2-19.—Installation and removal of the magazine.

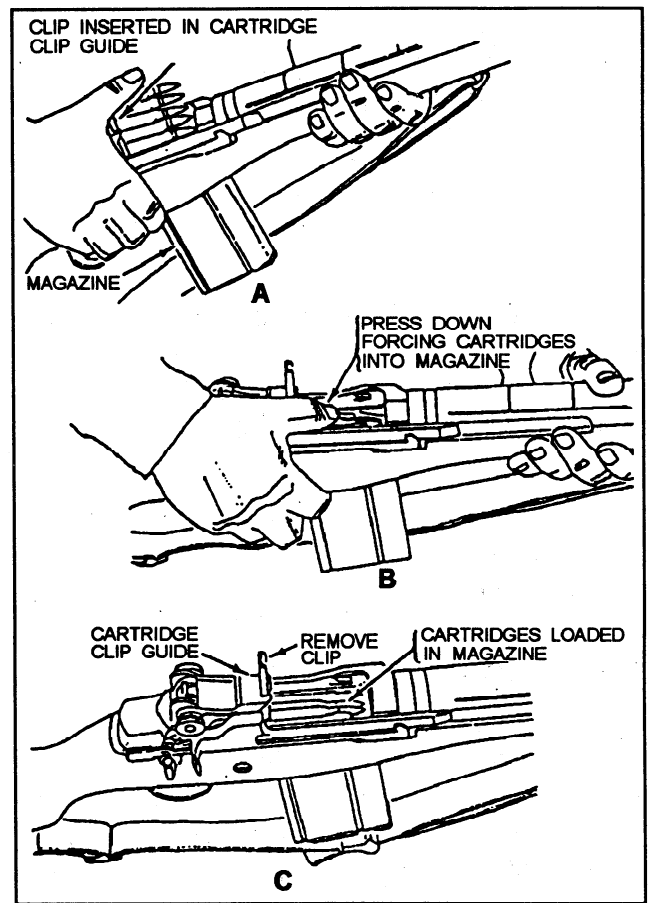

Figure 2-20.—Loading the magazine through the cartridge clip guide.

There are two methods for reloading an empty magazine. Figure 2-20 shows the method with the magazine in the rifle. (This method should only be used in the field since it creates a possible accidental firing situation.) After the last round is fired from a magazine, the magazine follower will engage the bolt lock and hold the bolt in the rear position. If this fails to happen, make sure you did not have a misfire, then pull the operating handle to the rear and manually depress the bolt lock (located on the left side of the receiver), ease the bolt down against it, then engage the safety. Insert a 5-round clip into the cartridge clip guide, as shown in figure 2-20, and push the cartridges down into the magazine. Four 5-round clips will fully load a magazine. After you have unloaded and removed the last clip, pull the operating handle to the rear to release the bolt lock; then release the handle. This will let the bolt go into battery, stripping and feeding the top round into the chamber. The weapon is now ready to fire.

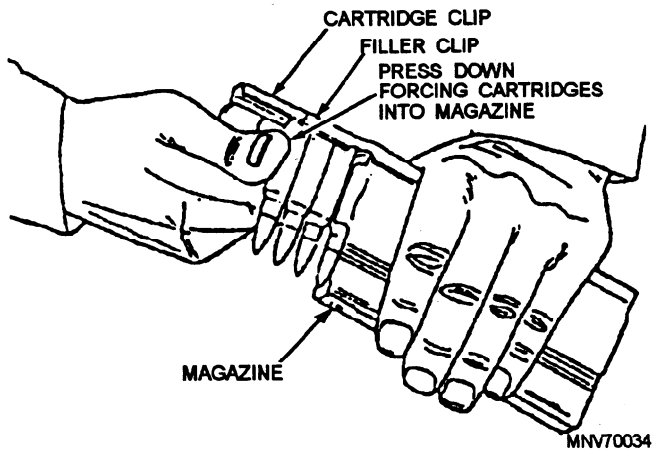

Figure 2-21.—Loading the magazine with a loading tool.

The safest way to reload a magazine is shown in figure 2-21. Each bandolier containing the 5-round clips also contains a magazine loading tool. Insert the tool over the top rear of the magazine as shown in figure 2-21, insert a 5-round clip into the loading tool, and press the cartridges into the magazine.

To load a full magazine into a rifle, insert the front end of the loaded magazine well into the front catch until the front catch snaps into engagement, then pull the magazine rearward and upward until the magazine latch locks it into position (fig. 2-19).

The gas spindle valve (fig. 2-22) controls the gases used in firing the rifle. When the slot of the spindle valve is in the vertical or ON position (upper view), the valve is open and directs gases to the operating piston for ordinary functioning of the rifle. When the slot is in the horizontal or OFF position (lower view), the spindle valve is closed. This permits the full pressure of the gas to be used in propelling a rifle grenade or line-throwing projectile.

The rear sight controls consist of a windage knob and a pinion assembly. (See figure 2-15.) The windage knob is used to adjust the sight laterally. Turn the knob clockwise to move the sight to the right and counterclockwise to move the sight to the left. The pinion assembly adjusts the sight aperture vertically. Turn the pinion clockwise to raise the sight and counterclockwise to lower the sight.

Firing the M14 Rifle

If your command does not want the rifle to fire on automatic, the selector will be replaced by a selector

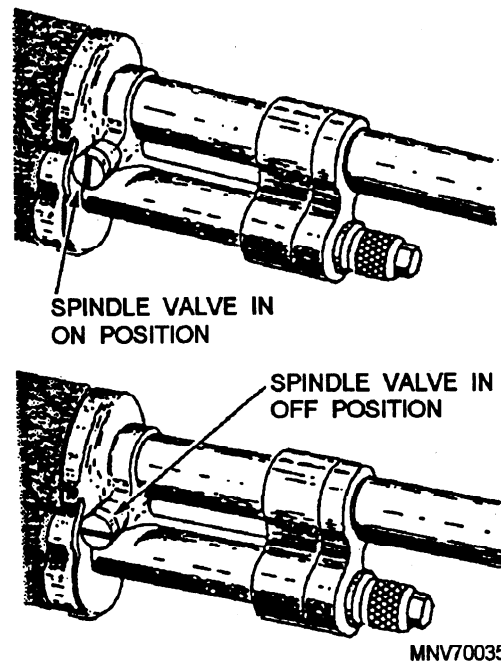

Figure 2-22.—Gas spindle valve in the ON and OFF positions.

shaft lock (See figure 2-15.) so that only semiautomatic fire is available.

To fire a rifle equipped with a selector shaft lock, simply push the safety forward and then fire a round with each squeeze of the trigger.

To fire semiautomatic fire on a rifle equipped with a selector, position the selector for semiautomatic fire and then fire a round with each squeeze of the trigger.

To fire automatic fire with a selector (rifle cocked), proceed as follows:

1. Position the selector for automatic fire.
2. Push the safety forward.
3. Squeeze the trigger. The rifle will fire automatically as long as the trigger is squeezed and there is ammunition in the magazine. Release the trigger to cease firing.
4. After the last round is fired, the magazine follower (a spring-driven plate in the magazine that forces cartridges upward as rounds are expended and cases ejected) actuates the bolt lock, locking the bolt in the rearward position. When you have removed the empty magazine inserted a loaded one, release the bolt lock by retracting the operating rod, thereby drawing the bolt rearward; then close the bolt. As the bolt assembly is closed, the top cartridge in the magazine is pushed forward into the chamber.

Unloading the M14 Rifle

To unload the M14 rifle, proceed as follows:

1. Push the safety to the SAFE (back) position:
2. Grasp the magazine with your thumb on the magazine latch, and squeeze the latch to release it. Push the magazine forward and downward to disengage it from the front catch, and then remove it from the magazine well, as shown in the right-hand view of figure 2-19.
3. Pull the operating rod handle all the way to the rear and lock it using the bolt catch.
4. Inspect the chamber to make sure it is clear.

The rifle is clear only when no round is in the chamber, the magazine is out, the safety is set (to the rear), and the bolt is in the REAR position.

Field-Stripping the M14 Rifle

Figure 2-23 shows how the M14 rifle breaks down into seven group assemblies. You should be able to disassemble the rifle to this extent for cleaning, lubrication, and maintenance. This procedure is called field-stripping the rifle. The names of the numbered group assemblies shown in figure 2-23 are as follows:

1. Magazine

2. Firing mechanism
3. Stock with butt plate assembly
4. Handguard assembly
5. Operating rod and connector group
6. Bolt assembly
7. Barrel and receiver group

To withdraw the firing mechanism (No. 2 in fig. 2-23) from the stock, proceed as follows:

1. Remove the magazine.
2. Place the safety in the SAFE position after making sure the rifle is cocked.
3. Disengage the hooked end of the trigger guard from the firing mechanism housing.
4. Swing the trigger guard away from the stock (but do not rotate it more than 90 degrees), and pull straight away from the stock to draw out the firing mechanism.

To remove a stock with a butt plate assembly after removing the firing mechanism, proceed as follows:

1. Grasp the receiver firmly with one hand and strike the butt of the stock sharply with the palm of the other.
2. Lift the stock from the barrel and receiver group.

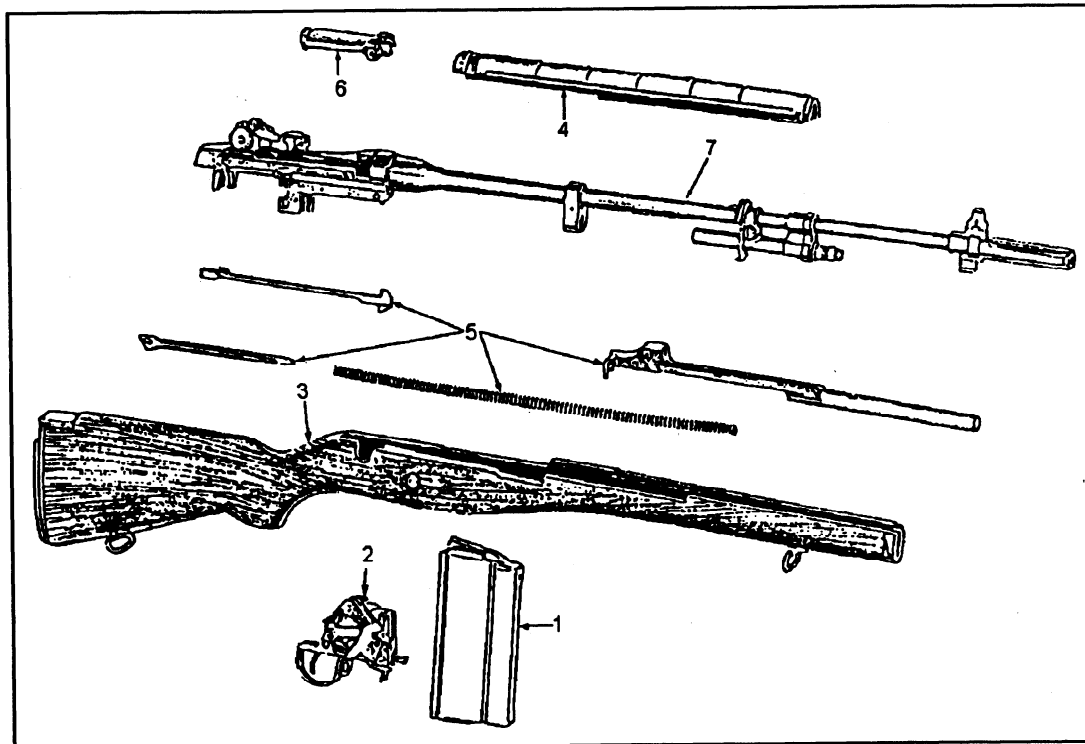

MNV70036

Figure 2-23.—Group assemblies of the M14 rifle.

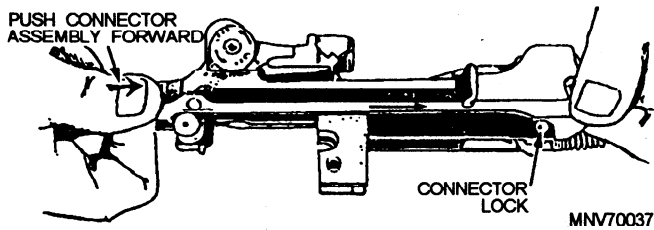

Figure 2-24.—Disengaging the connector assembly.

To separate the operating rod and connector group from the barrel and receiver group, proceed as follows:

1. Depress the rear sight to the lowest position and turn the barrel and receiver group on its side with the connector assembly upward.

2. If the rifle has a selector, press in and turn the selector until the face marked A is toward the rear of the sight knob and the projection forward is at an angle of about 35 degrees. Then, remove the connector assembly as indicated in steps 3 and 4 below.

3. If the rifle has a selector shaft lock, press forward on the rear of the connector assembly with your right thumb, as shown in figure 2-24, until you can lift the front end off the connector lock.

4. Rotate the connector assembly about 35 degrees clockwise until the slot at the rear is aligned with the elongated stud on the sear release (fig. 2-25); then lower the front end of the connector assembly and lift it off the sear release.

The next step is to remove the operating rod spring guide, the operating rod spring, and the operating rod. These parts are identified as 2, 3, and 4 respectively in figure 2-26. The correct step-by-step procedure is as follows:

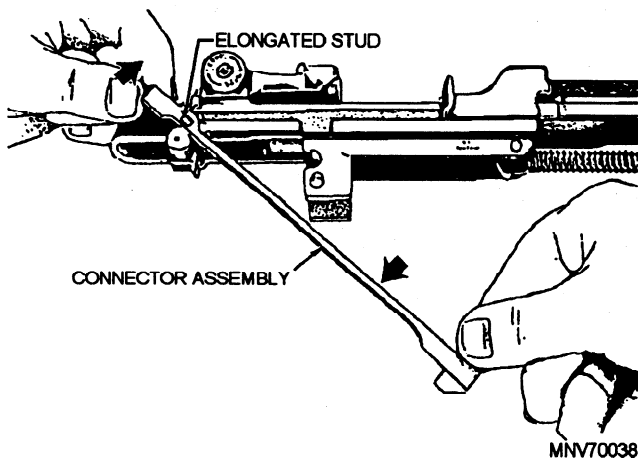

Figure 2-25.—Removing the connector assembly.

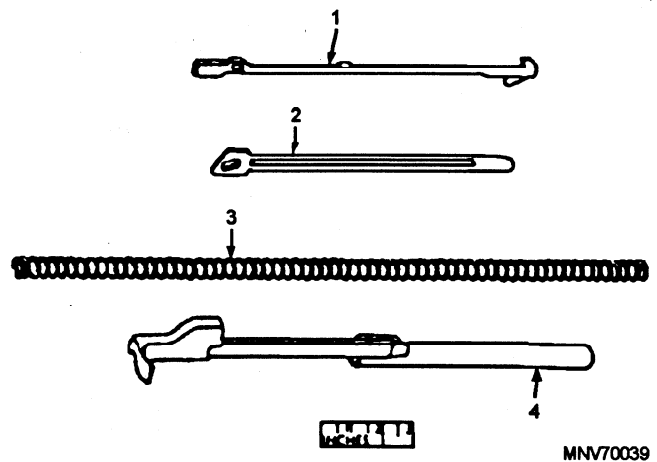

Figure 2-26.—Component parts of the operating rod and connector group.

1. With the barrel and receiver group upside down, pull forward on the operating rod spring, relieving pressure on the connector lock pin. Pull the lock outward to disconnect the operating rod spring guide.

2. Remove the operating rod spring guide and the operating rod spring. Turn the barrel and receiver group right side up.

3. Retract the operating rod until the key on its lower surface coincides with the notch in the receiver. Lift the operating rod free and pull it to the rear, disengaging it from the operating rod guide.

4. To remove the bolt, after removing the operating rod, grasp the bolt roller that engages with the operating rod and slide it forward. Lift the bolt upward and outward to the right with a slight rotating motion and remove it from the receiver. The weapon is now field-stripped for cleaning.

Reassembly of this weapon is basically the reverse of disassembly. A step-by-step procedure for reassembly and other maintenance procedures is covered in the U.S. Army FM 23-8.

SHOTGUNS

Shotguns used by the armed forces are military versions of civilian models made to military specifications. The Remington model 870 (M870) and the Mossberg model 500 (M500) are the Navy's standard issue riot-type shotguns. In this section we will describe the Remington M870 (fig. 2-27) in detail, then note how the Mossberg 500 differs. The Mossberg 500 is very similar to the Remington 870 in construction and operation.

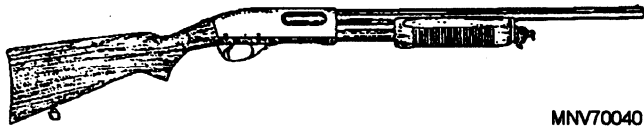

MNV70040

Figure 2-27.—Remington M870 shotgun.

REMINGTON M870 SHOTGUN

The M870 shotgun, used by the Navy for guard work, is a manually operated, magazine-fed (tubular), pump-action shoulder weapon.

Technical Description

The essential features of the Remington M870 shotgun are displayed here in chart form for easy reference.

Length of shotgun	39 inches (approximately)
Length of barrel	20 inches
Magazine capacity-rounds	4
Shell (gauge)	12
Ammunition	12 gauge, 2 3/4 inch 00 buck, military round
Safety	Crossbolt type

Functioning of the Remington M870

The M870 shotgun can be loaded and unloaded in several different ways. The following paragraphs describe the different options for loading and unloading the M870 and how to operate the mechanical safety. A single load puts a round directly into the chamber for fast firing, while a magazine load fully loads the tubular magazine, but does not chamber a round. Loading the barrel from the magazine chambers a round from the loaded tubular magazine for firing.

SAFETY.—Before loading or unloading the weapon, push the safety (fig. 2-28) across the rear of the trigger, left to right, to the SAFE position (the red band on the safety will not show).

FIRE POSITION.—Push the safety across to the FIRE position (the red band on the safety will show). The trigger can then be pulled to fire the gun.

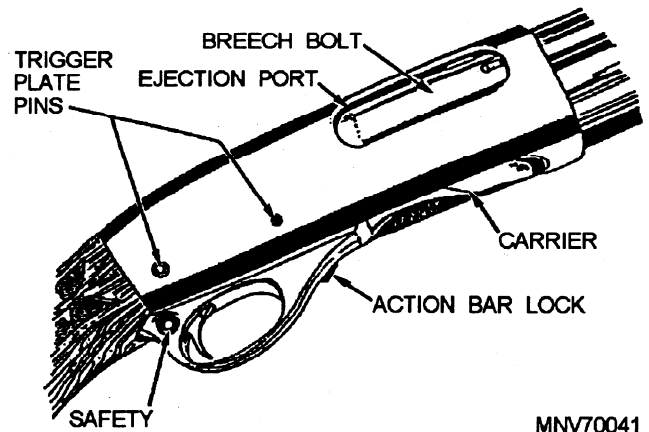

MNV70041

Figure 2-28.—Remington M870 receiver nomenclature.

SINGLE LOAD.—Push the safety to the SAFE position. Press in the action bar lock (fig. 2-28) if the action is cocked and pull the fore-end (forward handgrip) fully to the rear. Place the shell into the open ejection port upon the downthrust carrier. Slide the fore-end toward the muzzle to load the shell into the barrel chamber and lock the action closed.

MAGAZINE LOAD.—Push the safety to the SAFE position. Slide the fore-end completely forward to close the action. Turn the gun bottom upward and press the shell against the carrier, then forward fully into the magazine. Make sure the rim of the shell snaps past the shell latch to prevent the shell from sliding back over the carrier. Should this occur, open the action or, if necessary, remove the trigger plate assembly (fig. 2-29), if the gun is cocked, to remove the shell.

LOADING THE BARREL FROM THE MAGAZINE.—Shells can be fed from the loaded magazine by simply pumping the fore-end. Press in the action bar lock if the gun is cocked. Pump the fore-end back and forth to open and close the action.

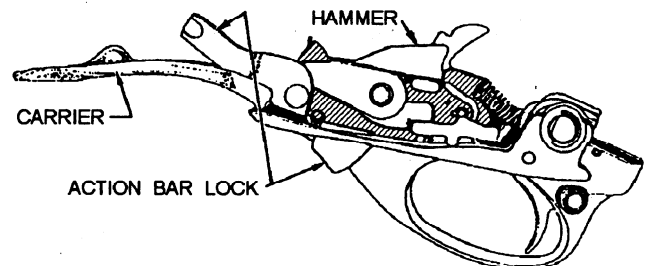

MNV70042

Figure 2-29.—M870 trigger plate assembly.

UNLOADING THE GUN.—Push the safety to the SAFE position. Press in the action bar lock; pull the fore-end (fig. 2-30) slowly rearward until the front end of the shell from the barrel is even with the ejection port in the receiver. Lift the front of the shell outward and remove it from the ejection port. Continue pulling the fore-end back fully until the next shell releases from the magazine. Roll the gun sideways to allow the released shell to drop from the ejection port. Close the action by pushing forward on the fore-end. Continue this procedure until the magazine and the gun are empty.

CAUTION

Open the action and check the shell chamber in the breech and the magazine to make sure no rounds remain in the gun.

UNLOADING THE BARREL ONLY.—Push the safety to the SAFE position. Press in the action bar lock and pull the fore-end rearward until the front end of the shell from the barrel is even with the front end of the ejection port. Lift the front end of the shell from the receiver as described previously. You can now place a shell with different powder and shot combination into the chamber and close the action without disturbing the shells in the magazine.

Remington M870 Operating Cycle

The entire operating cycle of the M870 shotgun is completed by pulling the trigger, sliding the fore-end rearward to open the action, and sliding the fore-end forward again to close the action. The fore-end is mounted on double-action bars and is fully controlled and operated by the shooter.

Maintenance

The following discussion on maintenance of the M870 shotgun covers only action necessary for routine maintenance of the weapon. If you become involved in

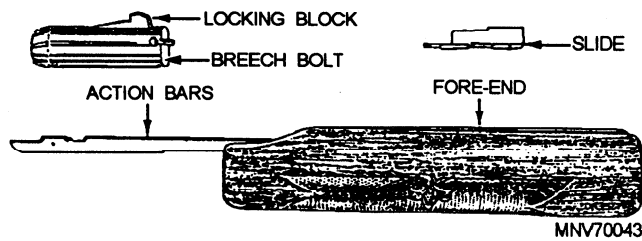

Figure 2-30.—M870 fore-end assembly.

maintaining the M870 shotgun, perform the maintenance according to the MRCs for the weapon.

Before you begin disassembling the weapon, be sure no shells remain in the chamber or the magazine

BARREL.—To remove and clean the barrel, push the safety to the SAFE position. Open the action, unscrew the magazine cap, and pull the barrel from the receiver. Replace the magazine cap on the end of the magazine tube. To clean the barrel, use a cleaning rod with a lightly oiled cloth. If powder fouling remains in the barrel, use a powder solvent to scrub the bore. After using solvent, wipe the barrel clean and re-oil it very lightly. Replace the barrel by removing the magazine cap, inserting the barrel in the receiver, and replacing the magazine cap.

TRIGGER PLATE ASSEMBLY.—With the safety pushed to the SAFE position, cock the action. Tap out the front and rear trigger plate pins (fig. 2-28). Lift the rear of the trigger plate from the receiver, then slide it rearward to remove it from the gun. Clean the trigger assembly as a unit by brushing it with a solvent. Wipe the trigger assembly dry and re-oil it very sparingly. As you replace the plate assembly, make sure the action bar lock enters the receiver easily and operates in position.

FORE-END ASSEMBLY UNIT.—Push the safety to the SAFE position. Close the action and remove the magazine cap and the barrel. Reach into the bottom of the receiver and press the left shell latch inward. Remove the fore-end by sliding it forward off the magazine tube. After you have removed the fore-end assembly from the gun, you may remove the breech bolt parts and the slide from the ends of the action bars.

NOTE

The top right edge of the slide may bind on the bottom front edge of the ejector port in the receiver. To free the slide, push downward on the front end of the bolt.

It is not necessary to disassemble the bolt for routine cleaning. Brush it with solvent to clean it; then wipe it dry.

To reassemble the weapon, reverse the disassembly steps. The following procedures will help make reassembly easier.

When you assemble the fore-end parts, be sure the gun is cocked. During this assembly, place the slide in

the correct position on the ends of the double-action bar. Place the breech bolt assembly, which includes the attached locking block assembly, over the slide on the action bars. Insert the end of the action bars into the matching grooves in the receiver. Move the fore-end slowly until contact is made with the front end of the right shell latch. Press the front right shell latch into the side of the receiver and continue moving the fore-end past this latch until contact is made with the left shell latch. Press the front of the left shell latch in to allow the fore-end assembly to pass and move freely into the receiver. Assemble the barrel to the receiver and tighten firmly with the magazine cap. This completes the assembly of the shotgun.

For further information on the Remington M870 shotgun, refer to the U.S. Air Force TM TO-11W3-6-2-1.

MOSSBERG M500 SHOTGUN

While very similar to the M870, the Mossberg M500 has a few significant differences. The following is a brief description of the differences that affect operation of the weapon. Figure 2-31 illustrates the

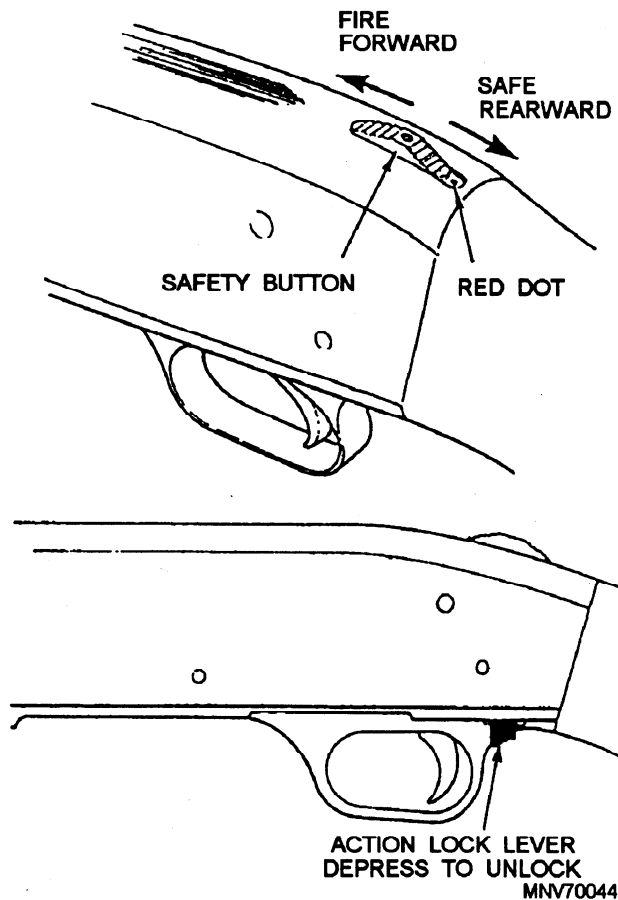

Figure 2-31.—Mossberg M500 shotgun safety and action release.

location of the safety switch and the action locklever on the M500 shotgun. The M500 safety switch is located on the top of the receiver. The action lock release is located behind the trigger guard. The M870 has the safety switch in the trigger guard and the action lock release to the front of the trigger guard. The disassembly and maintenance of the M500 and the M870 are so similar that they are both currently covered on the same MRC. You can find further information on the Mossberg M500 shotgun in the manufacturer's owner's manual supplied with the weapon.

MK 87 MOD 1 LINE-THROWING RIFLE ADAPTER KIT

This kit replaces the Mk 87 Mod 0 kit that replaced the 45/70 line-throwing gun. Included in the kit are 6 projectiles, 1 launcher, 18 chemical light wands, and 1 recoil pad. The line-throwing assembly (launcher, projectile, and canister) is designed to be used with the M14 rifle and M64 grenade cartridge.

LAUNCHER

The launcher (fig. 2-32) is used to hold the projectile and trap propellant gases that propel the projectile. It consists of a cylindrical steel tube approximately 8.5 inches long and 2.75 inches in diameter at the launching end and 1 inch in diameter at the connecting end. When used with the M14 rifle, the launcher slides over the flash suppressor and is secured to the rifle by the latch and its wire loop that fits over the rifle's bayonet lug. The safety retaining pin, fastened to the launcher by a stainless steel lanyard, fits through the latch to lock the launcher to the rifle.

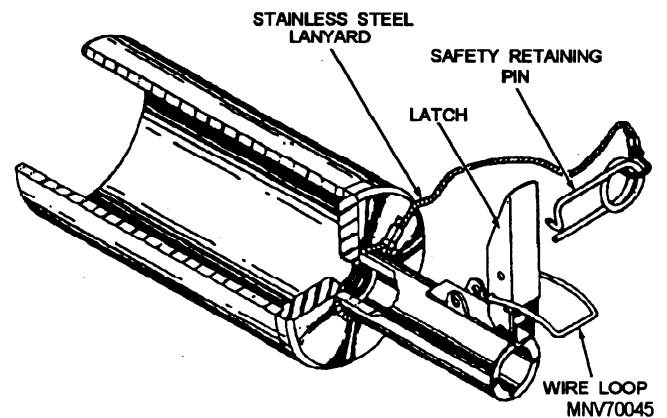

Figure 2-32.—Launcher.

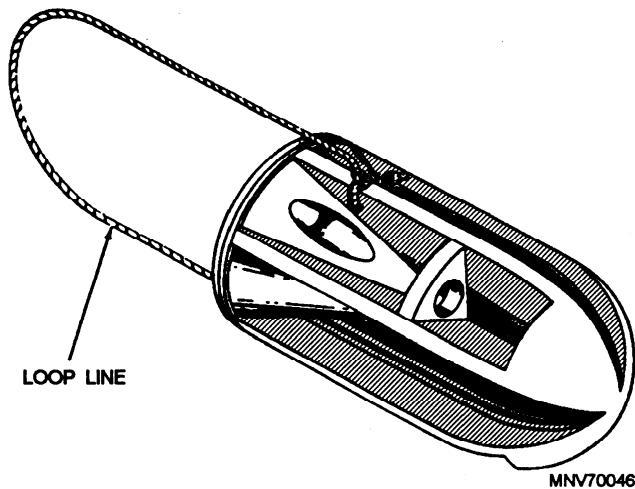

Figure 2-33.—Projectile.

PROJECTILE

The projectile (fig. 2-33) fits into the launcher. When the rifle grenade cartridge is fired, the projectile carries one end of the attached shot line to the desired destination. The projectile also houses the chemical light wands for night operation.

The reusable projectile is made of butyl rubber with a stainless steel disk assembled in the base end. The disk absorbs the impact of the propellant gases and the wadding of the rifle grenade cartridge. The hole and groove shown in figure 2-33 support the light wand. Three of these supports, located 120 degrees apart, are contained in each projectile. The loop line is used to connect the shot line to the projectile.

CHEMICAL LIGHT WAND

The chemical light wand (fig. 2-34) is used to illuminate the projectile during night operations. The light wand is installed by inserting it, tapered end first, into the hole and groove of the projectile.

The light wand is a two-component chemical illuminate system consisting of a yellow-green oxalate

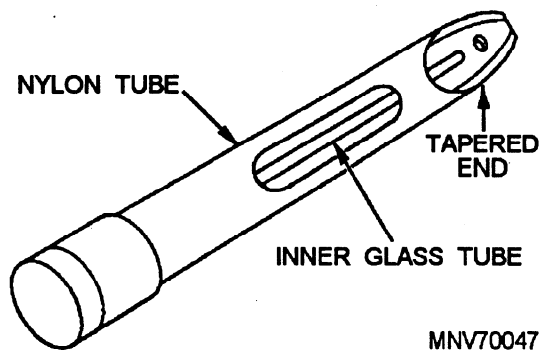

Figure 2-34.—Chemical light wand.

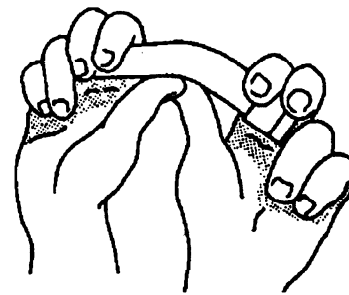

Figure 2-35.—Activating the chemical light wand.

solution inside a nylon tube. To activate the light, flex the nylon tube enough to break an inner glass tube, as shown in figure 2-35, and shake the wand well. Do not activate the light wand until you are ready to use it because once it is activated it must be used or disposed of. Do not dispose of the chemical light wand overboard as it may be mistaken for a man overboard exercise.

WARNING

If the nylon tube should puncture during activation, you may experience some mild discomfort from excessive skin or eye exposure to the oxalate solution. If this should happen, wash the exposed areas with soap and water as soon as possible.

Since the chemical light produces no flame or heat, its storage is not restricted to ventilated and unconfined (topside) spaces. The active life of the chemical light is from 3 to 12 hours, depending on the ambient temperature. Its shelf life is approximately 2 years under normal conditions.

The canister (fig. 2-36) is made of polyethylene and houses the spool of shot line. The canister is attached to the rifle by the clamp shown in the figure.

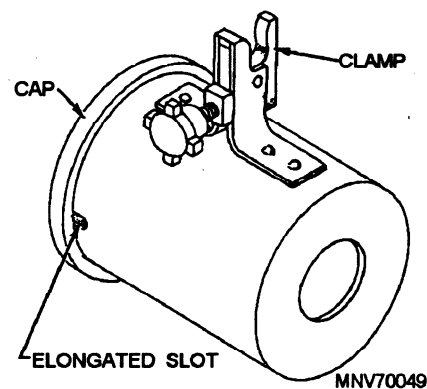

Figure 2-36.—Canister.

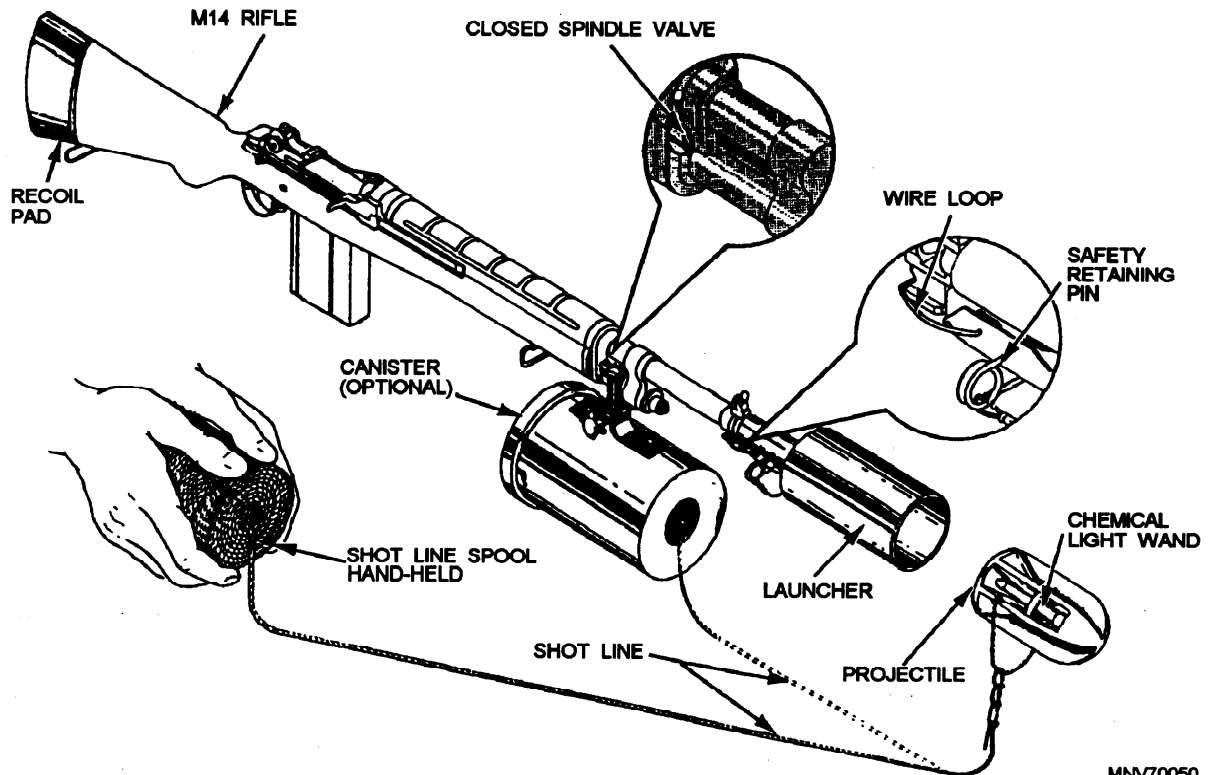

Figure 2-37.—Mk 87 Mod 1 kit on M14 rifle.

MNV70050

To install the shot line in the canister, remove the cap from the after end of the canister. Place the spool of shot line in the canister and feed the line from the center of the spool through the hole in front of the canister. Tie a knot in the bitter end of the shot line and slide it into the slot at the after end of the canister. Replace the canister cap. (The action of placing the knotted end of the shot line into the canister slot attaches the bitter end of the shot line to the canister.) Connect the line coming from the front end of the canister to the loop line on the projectile. Connect these lines (shot line and loop line) by a series of loosely tied half-hitch knots (three to five). Figure 2-37 shows the canister, shot line, and launcher mounted on the M14 rifle.

Note in figure 2-37 that the use of the canister is optional. With another person holding the shot line, the canister is not needed. The canister is part of the Mod 0 kit and should be retained for optional use with the Mod 1 kit.

RECOIL PAD

The slip-on recoil pad provided in this kit reduces the recoil on the operator when the projectile is launched. It is made of neoprene rubber that resists attacks by oil and other solvents and is designed for a

tight fit on the butt stock. Care is required during installation to prevent tearing. Once the pad is installed on the rifle used for line throwing, it should not be removed. The recoil pad is shown installed on the M14 rifle in figure 2-37.

GRENADE CARTRIDGES

Figure 2-38 shows the grenade cartridge M64 (7.62-mm) used with the M14 rifle for firing the line-throwing projectile. You can identify the cartridge by looking at, or by feeling, the five-pointed crimped end.



M64
(M14)

MNV70051

Figure 2-38.—M64 (M14) grenade cartridge.

You should load only one cartridge into the rifle at a time, and should not load it until you are at the rail, just before firing, with the rifle pointing outboard in a safe direction. Never use any cartridge other than one designated to fire a line-throwing projectile.

SHOT LINE

The nylon shot line comes in spools (fig. 2-39). The line is approximately 550 feet long and has a tensile strength of 125 pounds. It is wound around a wooden spindle in a way that prevents the line from fouling when the projectile is fired. The line is colored international orange and is treated with a water-repellent solution to make it buoyant enough to float on the surface for at least 24 hours.

PREPARATION FOR FIRING

On the M14 rifle, the spindle valve must be in the CLOSED (slot parallel to the barrel) position (See figure 2-37.) before the line-throwing projectile is fired.

NOTE

This position of the spindle valve is described as being in the OFF (horizontal) position in the first part of this chapter and in the TM9-1005-223-10.

FIRING

Before you fire the line-throwing projectile from the M14 rifle, elevate and aim the rifle over and across the designated target. Although the projectile is made of rubber, it has enough velocity to cause injury. Keep the rifle elevated until the projectile reaches its target to prevent line entanglement.

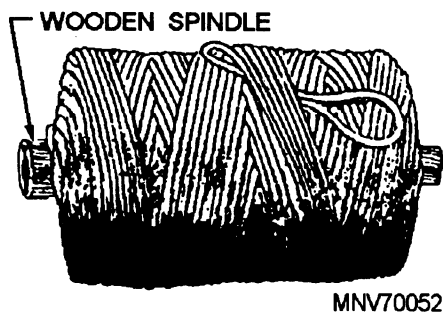

Figure 2-39.—Shot line.

Table 2-1.—Range Data

M14 RIFLE	
Degrees of Elevation	Range
60	80 yards
45	90 yards
30	85 yards
0	55 yards

NOTE: 0° (degrees) is when the rifle is parallel to the surface.

If you experience a misfire or hangfire, wait 10 seconds before you eject the grenade cartridge. Report the malfunction according to OPNAVINST 5102.1.

The maximum reliable range of the line-throwing projectile is approximately 90 yards when fired from the M14 rifle. This range depends upon having a dry shot line. You can use a wet line if a dry line is not available, but it will reduce the range. Table 2-1 provides the approximate range data for firing from the M14 rifle.

MAINTENANCE

Maintenance and operation of the Mk 87 Mod 1 line-throwing rifle adapter kit is covered in NAVSEA SW350-A1-MMO-010. Kit maintenance is also covered by a 3-M Systems MRC.

MACHINE GUNS

The Navy currently uses the Browning .50-caliber machine gun and the 7.62-MM M60 machine gun. We discuss both of these weapons below.

THE .50-CALIBER BROWNING MACHINE GUN

Browning machine guns (abbreviated BMGs) are standard Army weapons used by the Navy. The .50-cal. BMG now used by the Navy and the Army is the M2.

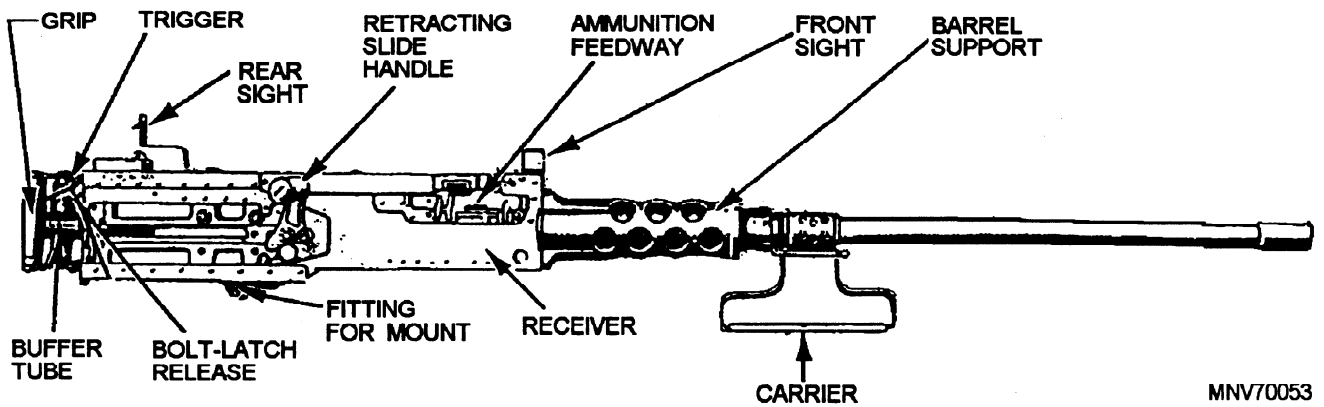

MNV70053

Figure 2-40.—.50-cal. HB Browning machine gun (M2).

The M2 BMG is only equipped with an air-cooled heavy barrel (HB) since the light air-cooled barrel is no longer in use.

For a time the .50-cal. BMG (fig. 2-40) was not used aboard surface ships, but it has since been installed on most types of ships and landing craft.

The .50-cal. BMG is a complex weapon, beyond the scope of this TRAMAN. Therefore, we will not discuss its mechanisms and principles of operation. In this chapter, we will simply describe the weapon and discuss how to operate it. For detailed information on the .50-cal. BMG, refer to the Army's FM 23-65.

The main characteristics of the .50-Cal. BMG (M2) are as follows:

Weight of the receiver group	56 lb
Weight of the barrel	26 lb (approx)
Total weight of the gun, complete, on its tripod mount, M3	126 lb (approx)
Maximum range (M2 ball)	7,400 yd
Maximum effective range	2,000 yd
Cyclic rate of fire	450-500 rpm
Muzzle velocity (M2 ball)	2,930 fps
Length of the gun overall	65 in. (approx)
Length of the barrel	45 in.

General Description

The .50-cal. HB M2 Browning machine gun is a belt-fed, recoil-operated, air-cooled machine gun. The gun is capable of both semiautomatic fire and automatic fire.

Ammunition can be fed from either the left or right side of the receiver (alternate feed) by having some of the gun's parts repositioned. However, under most circumstances, the ammunition is fed from the left side. A disintegrating metallic link belt is used in feeding. To prepare the gun for automatic firing, you must load the first round manually.

The force for recoil operation of the weapon is furnished by the expanding gases and is controlled by various springs, cams, and levers.

Air cooling of the weapon is permitted through maximum exposure to the air of the barrel and the receiver. Perforations in the barrel support allow air to circulate around the breech end of the barrel and help to cool the parts. The heavy barrel is used to retard early overheating.

Operating the .50-Cal. BMG

The safest and best way to operate a .50-cal. machine gun is to follow the correct procedures. By following set procedures, you prevent damage to the gun and possible injury to you or others in the area. The operating procedures of the .50-cal. BMG include prefire checks, loading and unloading, and postfire checks.

The primary prefire check requirement is the inspection of the weapon's headspace and timing. This is done with a head-space and timing gauge

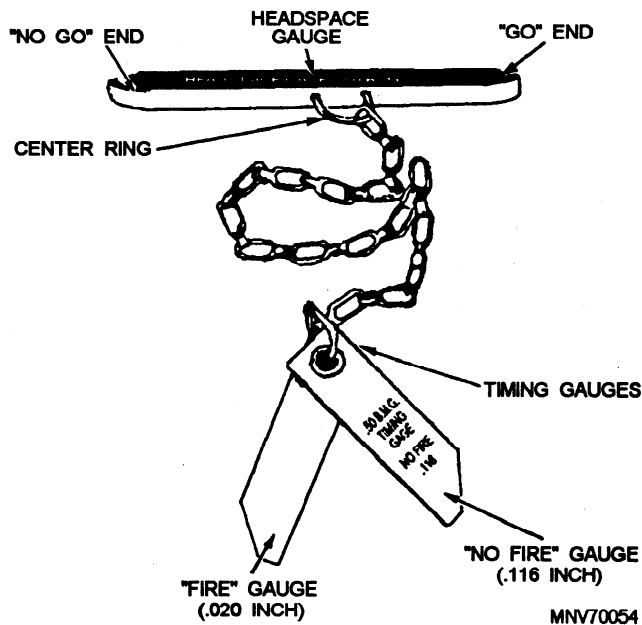

Figure 2-41.—Headspace and timing gauge.

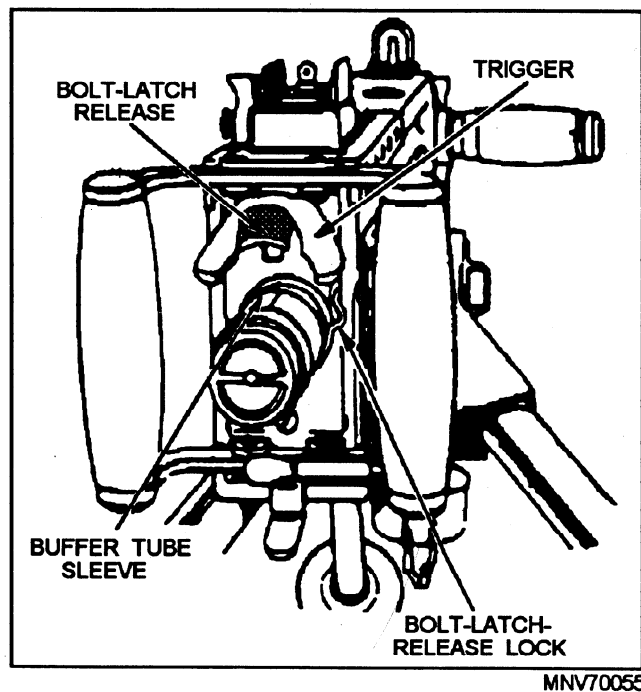

Figure 2-42.—Bolt-latch release free of the bolt-latch-release lock.

(fig. 2-41). Refer to the weapon's technical manual for instructions on how to use the gauge.

The operator must also select automatic or semiautomatic firing; automatic is the normal mode of operation. The mode of operation is determined by the position of the bolt-latch-release lock (fig. 2-42). For automatic firing, the bolt-latch release must be locked in the DEPRESSED position by the bolt-latch-release lock. To engage the bolt-latch-release lock, first depress the bolt-latch release. Then turn the bolt-latch-release lock counterclockwise until it hooks and retains the bolt-latch release in the DEPRESSED position.

To load the weapon, with the cover closed insert the double-loop end of the ammunition belt into the feedway until the first round is held by the belt-holding pawl (fig. 2-43). Then pull the retracting slide handle all the way to the rear and release it. With the bolt-latch-release lock positioned to engage the bolt-latch release, the bolt and retracting slide handle will move forward under pressure of the driving spring group, thus half-loading the gun. If the bolt-latch release is up and free of the bolt-latch-release lock, the bolt latch will hold the bolt to the rear. Push the retracting slide handle all the way forward (before releasing the bolt); then press down on the bolt-latch release to let the bolt go forward.

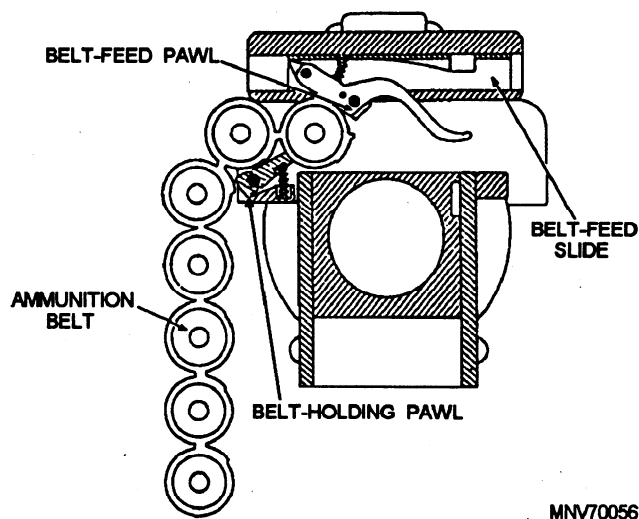

Figure 2-43.—First round held in feedway by belt-holding pawl.

To fully load the gun, follow the same procedure as for half-loading, except pull and release the bolt twice. When you have fully loaded the machine gun, fire it by depressing the butterfly trigger.

WARNING

Once fully loaded, the M2 .50-cal. machine gun maintains a round of ammunition in the chamber at all times. During sustained firing operations, the high temperature of the barrel may cause the round in the chamber to fire without the trigger being depressed. This is known as cook-off. Therefore, you should always keep the weapon pointed in a safe direction or cleared during breaks in firing. According to *Clearing of Live Ammunition From Guns*, NAVSEA SW300-BC-SAF-010, the M2 HB reaches cook-off temperature after a burst of 250 rounds or more.

While firing the M2, or any other belt-fed machine gun, you may experience an emergency condition known as *runaway firing*. In this situation, firing continues after the trigger has been released. If this happens to you, twist the ammunition belt at the feed slot. This will cause the weapon to jam and cease firing.

WARNING

In case of a runaway gun, keep the weapon laid on target and keep the cover closed. Again, DO NOT UNLATCH THE COVER!

To unload the gun, the unlock the bolt-latch release, turn the cover-latch release, and raise the cover. Lift the ammunition belt from the gun, pull the bolt to the rear, and examine the chamber and the T-slot to see that they hold no rounds. After you have finished this examination, allow the bolt to go forward, close and latch the cover, and press the trigger.

Gun maintenance

The importance of a thorough knowledge of how to care for, clean, and preserve the machine gun cannot be overemphasized. Proper care, cleaning, and preservation determine whether this gun will shoot accurately and function properly when needed. The bore and chamber must be kept in perfect condition to ensure accurate fire. Because of the close fit of working surfaces and the high speed at which the gun operates, it is important that the receiver and moving parts be kept clean, well-lubricated, and free of burrs, rust, dirt, or grease.

To be cared for properly, the machine gun must be cleaned according to a prescribed schedule. Such a schedule normally follows the 3-M Systems MRCs. TM 9-1005-213-10 also provides maintenance instructions for this gun. Under combat conditions, it may be necessary to clean the gun where it is mounted; however, when possible, the gun should be disassembled, cleaned, and oiled in a clean, dry location where it is least exposed to moisture, dirt, and so on. Be particularly careful to remove all sand or dirt; it will act as an abrasive on moving parts, causing excessive wear, sluggish operation, or malfunction. Do not oil parts excessively. Excessive oil solidifies and causes sluggish operation or complete failure,

Each gun should be cleaned as soon after firing as possible, and each time it is taken to the field and returned. Under combat conditions, the gun should be cleaned and lightly oiled daily. Under ideal conditions, where the gun is not used and is stored in a clean, dry place, it may only be necessary to inspect, clean, and lubricate the gun once a week. The threads on the gun barrels must be protected against being burred during handling and cleaning.

For more detailed information on the prescribed cleaning materials, lubricants, and rust preventives to be used in the .50-cal. BMG maintenance, refer to the Army's FM 23-65 and TM 9-1005-213-10.

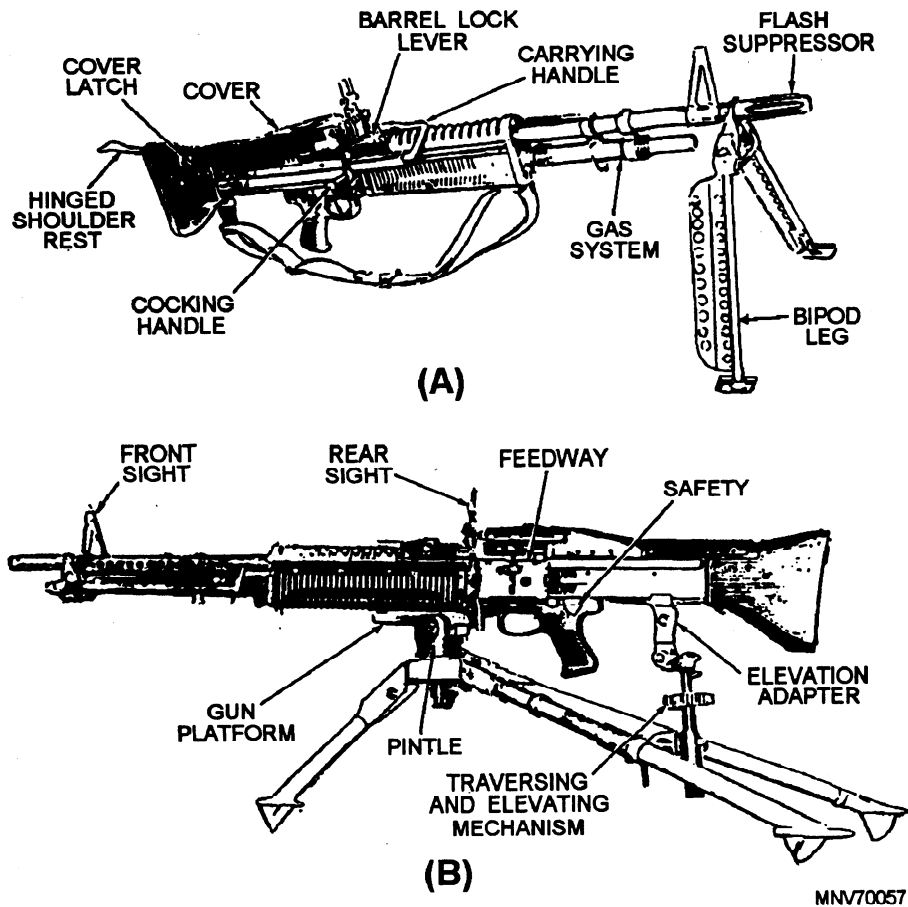

Figure 2-44.—M60 machine gun: (A) Bipod mounted; (B) Tripod mounted.

7.62-MM M60 MACHINE GUN

The M60 machine gun (fig. 2-44) is an air-cooled, belt-fed, gas-operated automatic weapon. The machine gun was originally developed for use by ground troops; however, it is used on many types and classes of ships, river patrol craft, and combat helicopters.

The essential features of the M60 are as follows:

Length	43.5 in. (110.5 cm)
Weight	23 lb (10.4 kg)
Maximum range	3,725 meters (4,075 yd)
Maximum effective range	1,100 meters (1,200 yd)
Ammunition	7,62-mm ball tracer, armor-piercing, incendiary, and dummy
Rates of fire: Sustained	100 rpm
Rapid	200 rpm
Cyclic	550 rpm

The M60 has a front sight permanently affixed to the barrel. The rear sight leaf is mounted on a spring-type dovetail base (fig. 2-45). It can be folded forward to the horizontal when the gun is to be moved. The range plate on the sight leaf is marked for each 100 meters, from 300 meters to the maximum effective

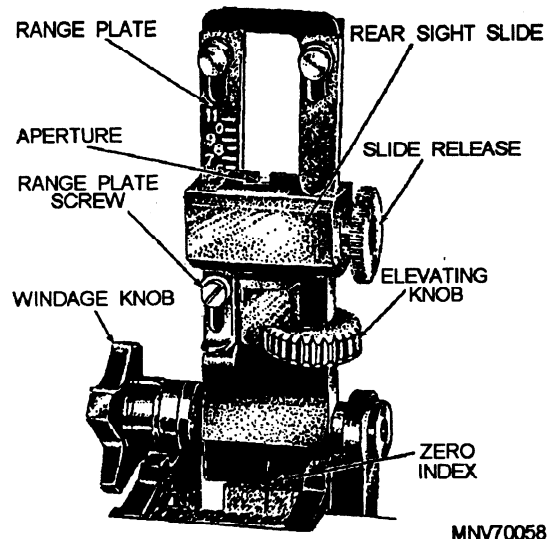

Figure 2-45.—M60 rear sight.

range of 1,100 meters. Range changes may be made by using either the slide release or the elevating knob. The slide release is used for making major changes in elevation. The elevating knob is used for fine adjustments, such as during zeroing. Four clicks on the elevating knob equal a 1-mil change of elevation. The sight is adjustable for windage 5 mils right and left of zero. The windage knob is located on the left side of the sight. One click on the windage knob equals a 1-mil change of deflection.

NOTE

1 mil equals 1 inch at 1,000 inches, 1 yard at 1,000 yards, 1 meter at 1,000 meters, and so on.

A safety lever located on the left side of the trigger housing has an S (SAFE) position and an F (FIRE) position. When the safety lever is in the SAFE position, the bolt cannot be pulled to the rear or released to go forward. The cocking lever, on the right side of the gun, is used to pull the bolt to the rear. It must be returned manually to its FORWARD position each time the bolt is manually pulled to the rear.

Operation

The machine gun is designed to function automatically as long as ammunition is fed into the gun and the trigger is held to the rear. Each time a round is

fired, the parts of the machine gun function in a certain sequence. Many of the actions occur simultaneously and are only separated for teaching purposes. The sequence of operation is known as the cycle of operation.

For ease of understanding, the complete cycle of operation is discussed in the following eight steps:

1. Feeding: A round is positioned in the feed tray groove.
2. Chambering: A round is stripped from the belt and placed in the chamber.
3. Locking: The bolt is locked inside the barrel socket.
4. Firing: The firing pin strikes and initiates the primer of the cartridge.
5. Unlocking: The bolt is unlocked from the barrel socket.
6. Extracting: The empty case is pulled from the chamber.
7. Ejecting: The empty cartridge case is thrown from the receiver.
8. Cocking: The sear engages the sear notch.

The cycle starts when a round is put into the feed tray groove and the trigger is pulled, releasing the sear from the sear notch (fig. 2-46). It stops when the trigger

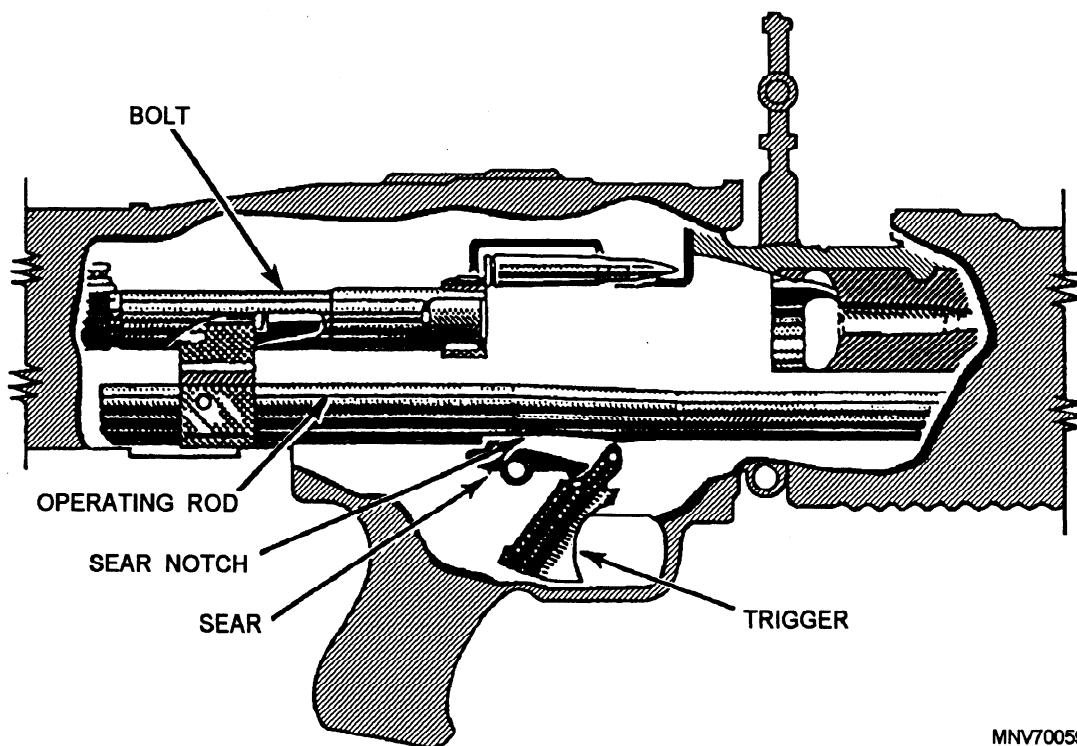

Figure 2-46.—The sear disengaging from the sear notch.

MNV70059

is released and the sear again engages the sear notch in the operating rod. When the trigger is held to the rear, the rear of the sear is lowered and disengaged from the sear notch. This allows the operating rod and bolt to be driven forward by the expansion of the operating rod spring. Now that the gun is functioning, we can trace the steps of the cycle.

As the bolt begins its forward movement, the feed cam is forced to the right, causing the feed cam lever to pivot in the opposite direction and forcing the feed pawl over the next round in the belt, ready to place the round into the feed tray groove when the rearward action occurs again (figure 2-47). As the bolt moves to the rear after the firing, the cam roller in the top of the bolt forces the feed cam to the left. The feed cam lever is forced to pivot, moving the feed pawl to the right, placing a round into the feed tray groove.

As the bolt travels forward, the upper locking lug engages the rim of the cartridge. The pressure of the front and rear cartridge guides holds the round so that positive contact is made with the upper locking lug of the bolt. The front cartridge guide prevents the link's

forward motion as the round is stripped from the belt. The upper locking lug carries the round forward, and the chambering ramp causes the nose of the cartridge to be cammed downward into the chamber as shown in figure 2-48. When the round is fully seated in the chamber, the extractor snaps over the rim of the cartridge, and the ejector on the face of the bolt is depressed.

As the round is chambered, the bolt enters the barrel socket. The upper and lower locking lugs contact the bolt camming surfaces inside the barrel socket and start the rotation of the bolt clockwise. The action of the operating rod yoke against the bolt camming slot, as the operating rod continues forward, causes the bolt to complete its one-quarter turn clockwise rotation (fig. 2-49). Locking is then completed.

After the bolt reaches its fully forward and locked position, the operating rod continues to go forward, independently of the bolt, for a short distance. The yoke, engaged between the firing pin spools, carries the firing pin forward. The striker of the firing pin protrudes through the aperture in the face of the bolt,

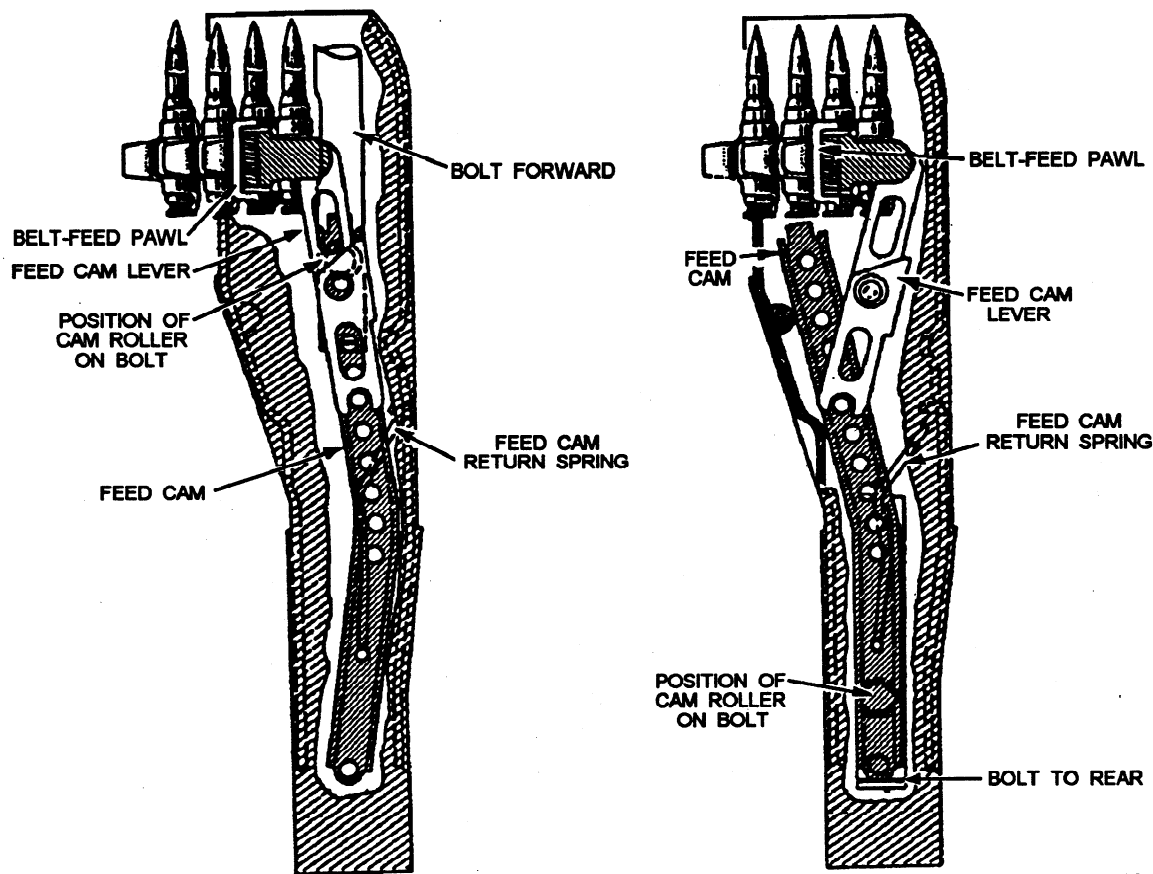

MNV70060

Figure 2-47.—Feeding.

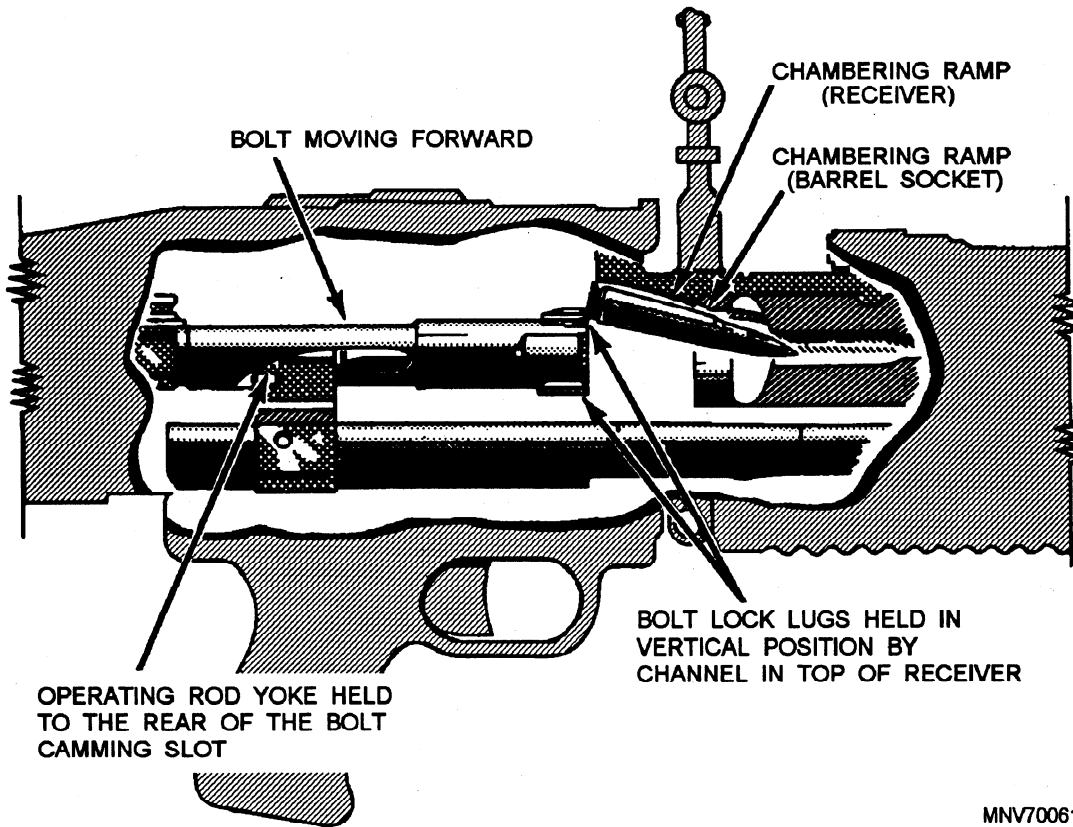

MNV70061

Figure 2-48.—Chambering.

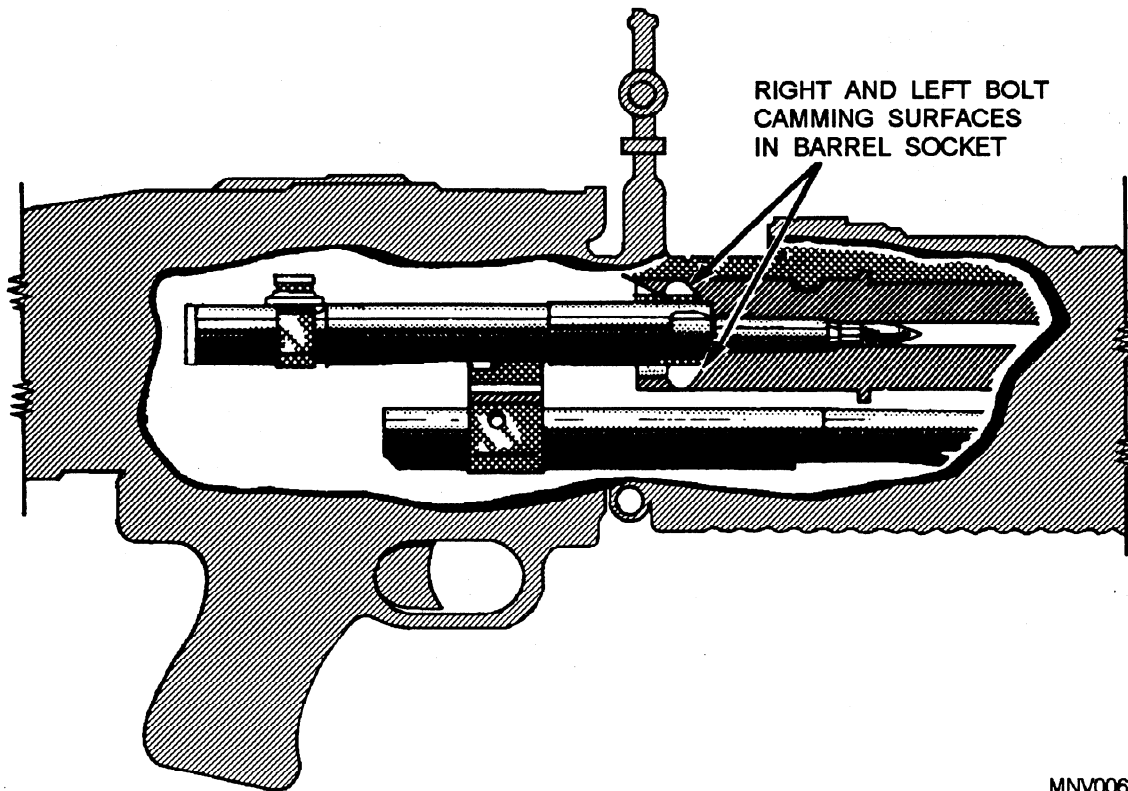

MNV0062

Figure 2-49.—Weapon locked, ready to fire.

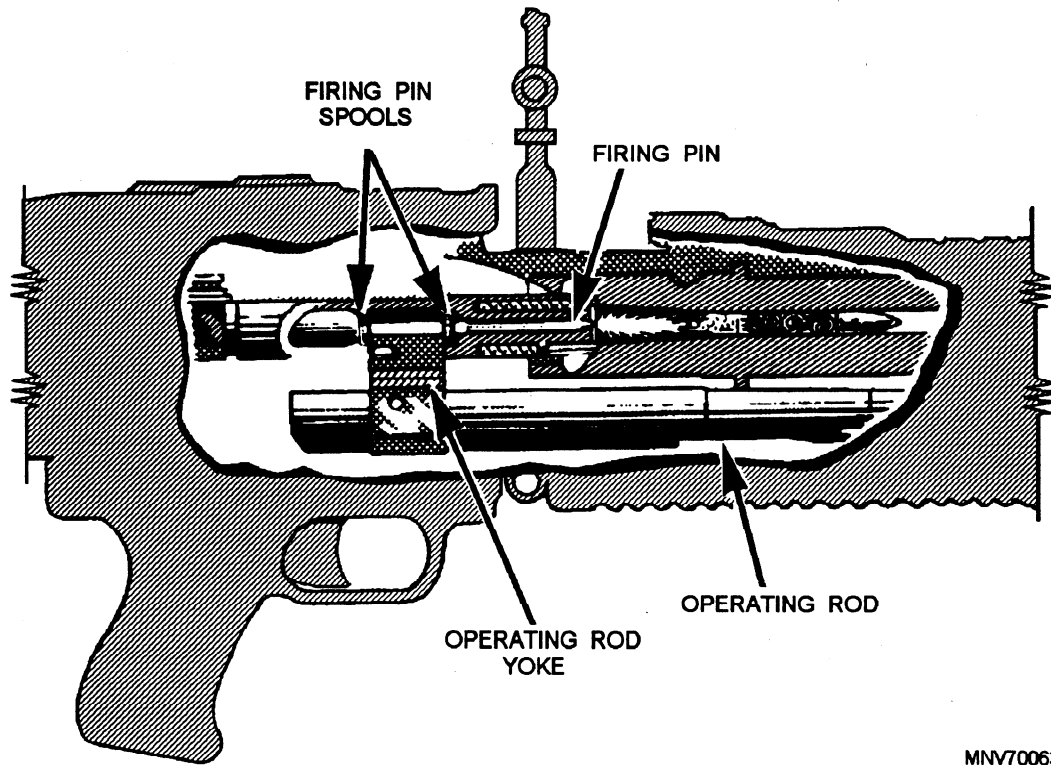

Figure 2-50.—Firing.

MNV70063

strikes the primer of the cartridge, and ignites it. This action is depicted in figure 2-50.

After the cartridge is ignited and the projectile passes the gas port, part of the expanding gases enters the gas cylinder through the gas port. The rapidly expanding gases enter the hollow gas piston, as shown in figure 2-51, and force the piston to the rear. The operating rod, being in contact with the piston, is also pushed to the rear. As the operating rod continues to the rear, the operating rod yoke acts against the bolt camming slot to cause the bolt to begin its counterclockwise rotation. The upper and lower locking lugs of the bolt, contacting the bolt camming

surfaces inside the barrel socket, cause the bolt to complete its one-quarter turn rotation (counterclockwise) and unlock the bolt from the barrel socket. Unlocking begins as the yoke of the operating rod contacts the curve of the bolt camming slot and ends as the bolt clears the end of the barrel socket.

While unlocking is going on, extraction is beginning. The rotation of the bolt, in unlocking, loosens the cartridge case in the chamber. As the operating rod and bolt continue to the rear, the extractor (gripping the rim of the cartridge) pulls the cartridge case from the chamber. As the case is withdrawn from the chamber, the ejector spring expands. The ejector

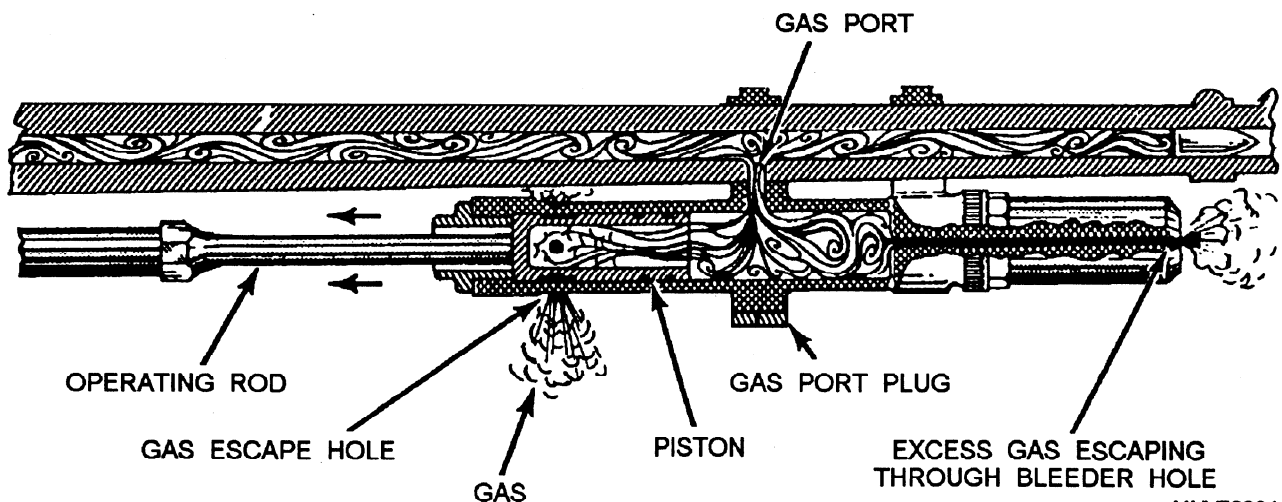

Figure 2-51.—Unlocking action of gases.

MNV70064

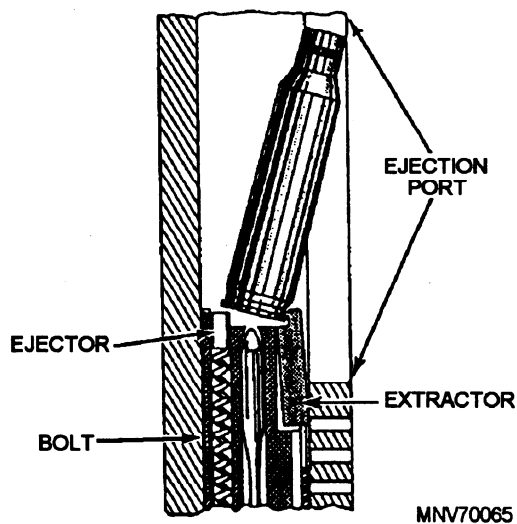

Figure 2-52.—Extraction and ejection.

presses on the base of the cartridge case, forcing the front of the spent case against the right side of the receiver, as shown in figure 2-52. As the bolt continues to the rear, the action of the ejector pushing against the base of the cartridge case and the extractor gripping the right side of the case causes the cartridge case to spin from the gun as the case reaches the ejection port. The empty link is forced out of the link ejection port as the rearward movement of the bolt causes the next round to be positioned in the feed plate groove.

As the expanding gases force the gas piston to the rear, the operating rod is initially moved independently of the bolt. The yoke of the operating rod acts against the rear firing pin spool, withdrawing the firing pin from the primer of the spent cartridge case. The action of the operating rod yoke continuing to the rear against the rear firing pin spool fully compresses the firing pin spring. As long as the trigger is held to the rear, the weapon will continue to complete the first seven steps of functioning automatically. When the trigger is released and the sear again engages the sear notch, the cycle of functioning is stopped and the weapon is cocked.

Disassembly

Two types of disassembly procedures may be performed on the M60 machine gun—general and detailed. General disassembly procedures involve removing most of the major groups and assemblies of the weapon, while the detailed procedures consist of removing the components of the major groups. Because detailed disassembly is so complex, we will discuss only the general disassembly procedures.

The M60 machine gun can be disassembled into eight major groups and assemblies without the use of force or special tools. These groups and assemblies are shown in figure 2-53. With the exception of the barrel

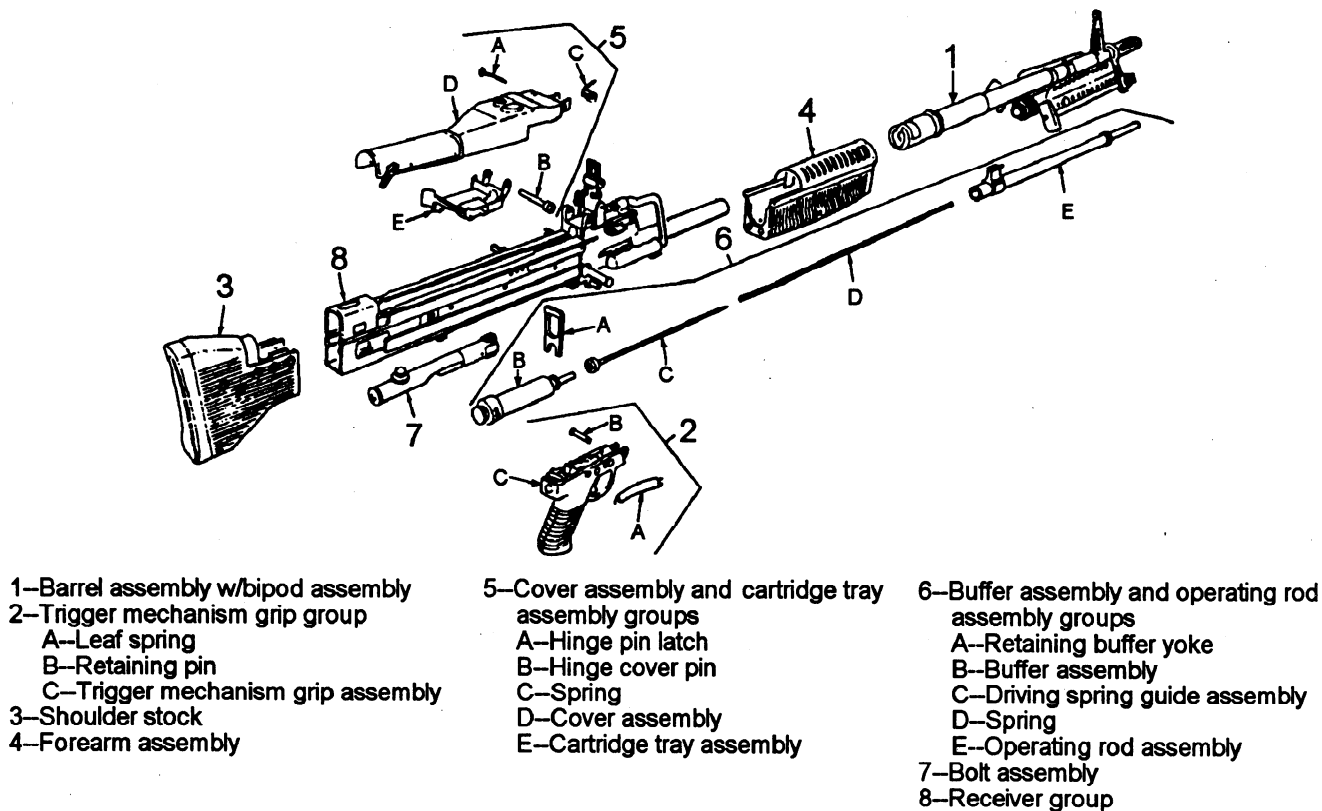

- 1—Barrel assembly w/bipod assembly
- 2—Trigger mechanism grip group
 - A—Leaf spring
 - B—Retaining pin
 - C—Trigger mechanism grip assembly
- 3—Shoulder stock
- 4—Forearm assembly

- 5—Cover assembly and cartridge tray assembly groups
 - A—Hinge pin latch
 - B—Hinge cover pin
 - C—Spring
 - D—Cover assembly
 - E—Cartridge tray assembly

- 6—Buffer assembly and operating rod assembly groups
 - A—Retaining buffer yoke
 - B—Buffer assembly
 - C—Driving spring guide assembly
 - D—Spring
 - E—Operating rod assembly
- 7—Bolt assembly
- 8—Receiver group

MNV70066

Figure 2-53.—Major groups and assemblies of the M60 machine gun.

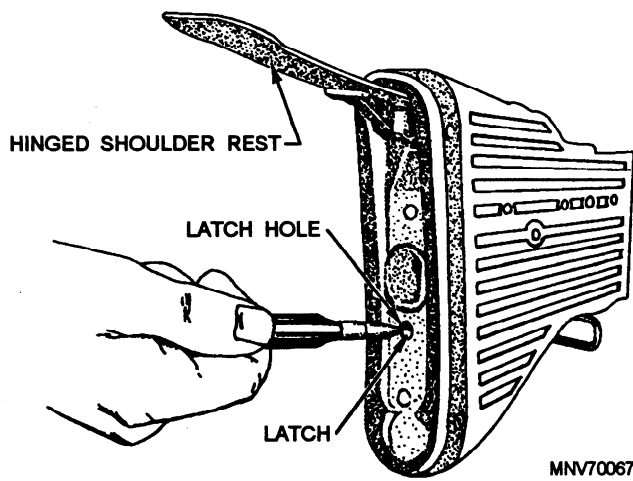

Figure 2-54.—Releasing the stock latch.

assembly, all disassembly can be done with a driftpin or a similar pointed object.

General disassembly begins with the bolt forward, the cover closed, and the safety on SAFE. Before you begin disassembling the weapon, inspect it thoroughly to make sure it is unloaded. As you disassemble the weapon, place the parts (in the order in which you remove them) on a clean, flat surface. This reduces the possibility of losing some of the parts and will aid you in reassembling the weapon. When you reassemble the weapon, replace the parts in reverse order.

REMOVING THE STOCK.—To remove the stock, raise the hinged shoulder rest and insert the nose of a driftpin into the latch hole as shown in figure 2-54. With the latch depressed, remove the stock by pulling it directly to the rear.

REMOVING THE BUFFER GROUP.—The buffer assembly group consists of the buffer yoke and the buffer. To disassemble the group, hold the palm of your hand against the exposed buffer and press the buffer lightly. Remove the buffer yoke from the top of the receiver as illustrated in figure 2-55. Withdraw the

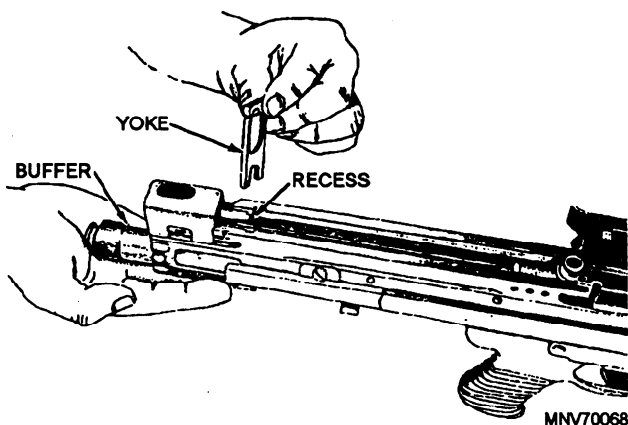

Figure 2-55.—Removing the buffer group.

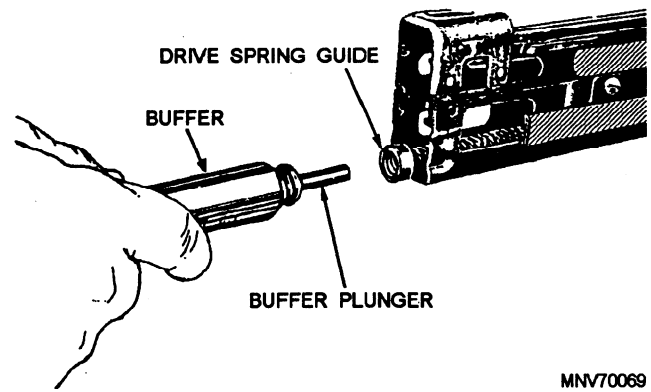

Figure 2-56.—Separating the buffer from the drive spring guide.

buffer slowly. Allow the drive spring to expand until the end of the drive spring guide is exposed at the rear of the receiver. Pull the buffer plunger from the drive spring guide (fig. 2-56).

REMOVING THE OPERATING GROUP.—The operating rod assembly group consists of the operating rod, the drive spring, the drive spring guide, and the bolt assembly. To remove the group, pull the drive spring guide and spring from the receiver and separate them. With the left hand, grasp the pistol grip and pull the cocking handle to the rear until the bolt is separated from the barrel socket. Continue to pull the operating rod and bolt to the rear by pulling the cam roller as shown in figure 2-57, view A.

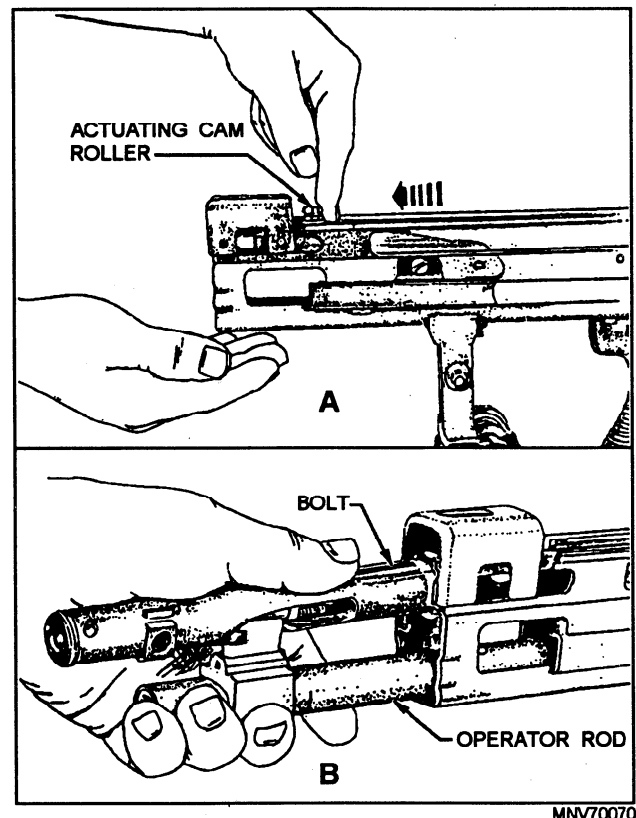

Figure 2-57.—Removing the operating group.

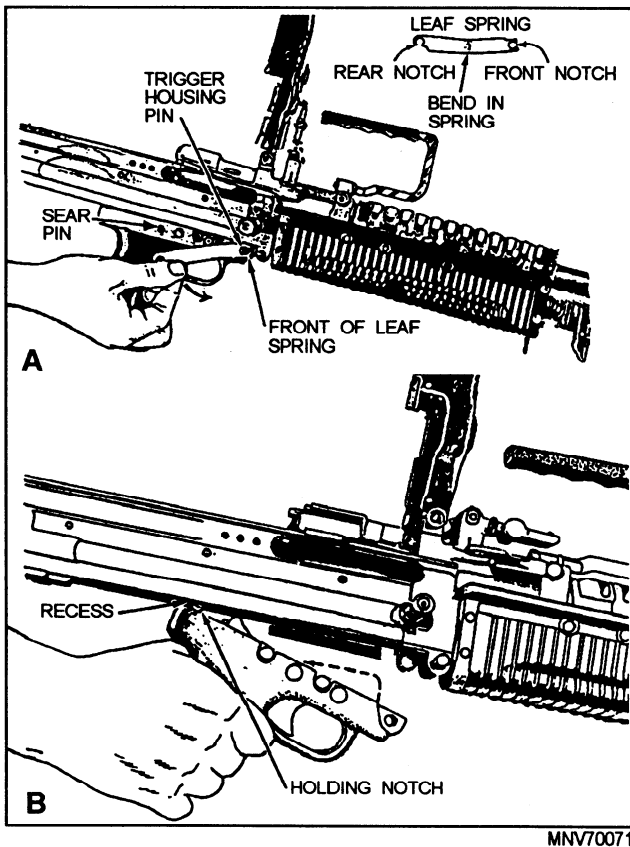

Figure 2-58.—Removing the trigger mechanism grip group.

When the operating rod and bolt are exposed approximately 4 inches to the rear of the receiver, grasp them securely to prevent the bolt from turning in, and remove them from the receiver (fig. 2-57, view B). Relax your grip and allow the bolt to rotate slowly. It is not necessary to separate the bolt from the operating rod.

REMOVING THE TRIGGER MECHANISM GROUP.—The trigger mechanism grip group consists of the trigger mechanism grip assembly (trigger housing, sear, sear pin, sear plunger, sear plunger spring, trigger pin, and trigger), trigger housing pin (interchangeable with the sear pin), and leaf spring. To remove the group, press in on the front of the leaf spring and rotate the front end down to clear it from the trigger housing pin as shown in figure 2-58, view A. Pull forward to disengage the rear notch from the sear pin. Remove the trigger housing pin by pushing it to the left. Slide the trigger housing slightly forward, rotate the front of the housing down, and remove it (fig. 2-58, view B).

REMOVING THE BARREL ASSEMBLY.—The barrel assembly consists of the barrel, the flash

suppressor, the front sight bipod assembly, and the gas cylinder. To remove the assembly, raise the barrel lock lever to the vertical position and remove the barrel assembly by pulling it to the front as shown in figure 2-59.

General disassembly to this point leaves the receiver group, the cover assembly and cartridge tray assembly groups, and the forearm intact, and is sufficient for general maintenance and cleaning of the M60 machine gun.

Assembly

The assembly procedures for the M60 machine gun are basically the reverse of the steps taken during disassembly. Starting with the receiver, attach each group and assembly in the following manner:

1. Make sure the barrel lock lever is in the vertical position, as shown in figure 2-59. Insert the rear of the barrel under the barrel cover and align the gas cylinder nut with its recess in the forearm assembly. Lower the barrel lock lever.

2. Engage the holding notch of the trigger housing in its recess in the bottom of the receiver (fig. 2-58, view B). Rotate the front of the trigger housing up and align the holes of the trigger housing with the mounting bracket on the receiver. Insert the trigger housing pin from the left. Engage the rear of the leaf spring with the sear pin (fig. 2-58, view A). Make sure the leaf spring is positioned so that the bent portion is pressed against the side of the trigger housing. Rotate the front of the leaf spring up and engage it with the trigger housing pin.

3. Insert the end of the operating rod into the receiver. Hold the rod with one hand. With the other hand, push forward on the rear of the bolt, causing the bolt to rotate until the locking lugs are in the vertical position. With the cam roller up, push the operating rod

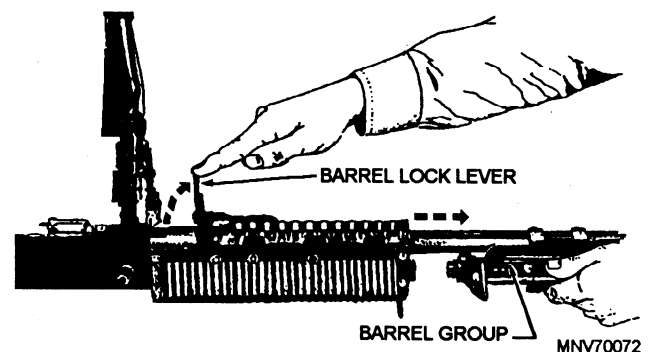

Figure 2-59.—Removing the barrel assembly.

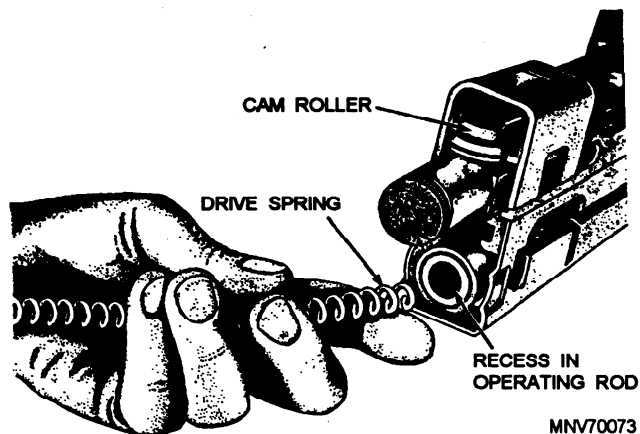

Figure 2-60.—Inserting the drive spring.

and the bolt into the receiver until the end of the operating rod is even with the rear of the receiver. Insert the drive spring guide into the drive spring; then insert the opposite end of the drive spring into the recess of the operating rod, as shown in figure 2-60. Pull the trigger and push in the drive spring until the head of the guide is approximately one inch from the receiver (fig. 2-56).

4. Insert the buffer plunger into the drive spring guide, as shown in figure 2-56. Push forward on the buffer until the operating rod and the bolt go fully forward. Push in on the buffer until the recesses on the buffer are aligned with the recesses in the receiver. Replace the buffer yoke from the top of the receiver, as shown in figure 2-55.

5. Align the guide rails of the stock with the guide rails on the receiver. Push forward until the stock is fully seated. You will hear a distinct click when the latch engages.

6. To check for correct assembly, pull the cocking handle to the rear and return it to its forward position. Close the cover and pull the trigger. The bolt should go forward.

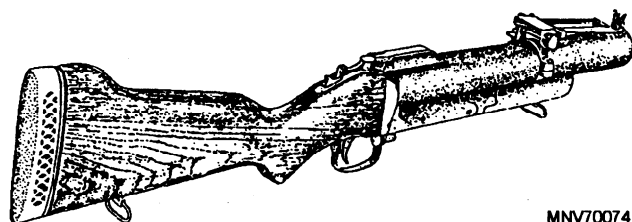

Figure 2-61.—M79 grenade launcher.

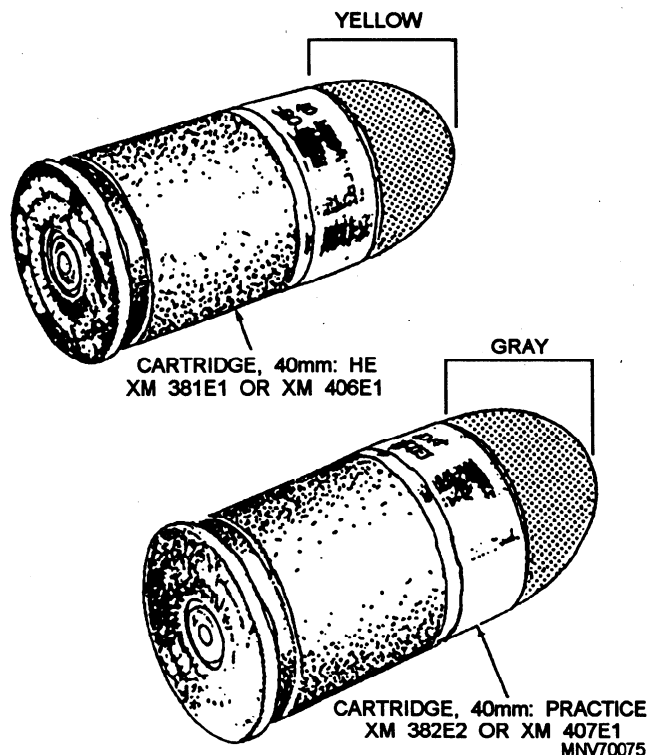

Figure 2-62.—Cartridges used with the M79 grenade launcher.

NOTE

The bolt must be in the rear (cocked) position before you can close the cover.

For further information on the M60 machine gun, refer to the Army's TM 9-1005-224-24 and TM 9-1005-24-10.

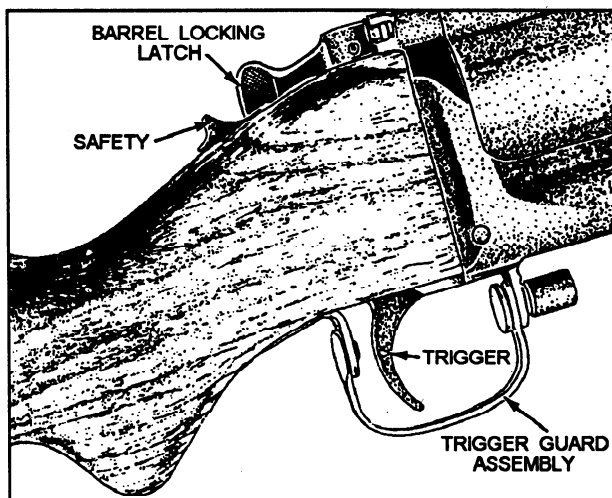

Figure 2-63.—Grenade launcher controls.

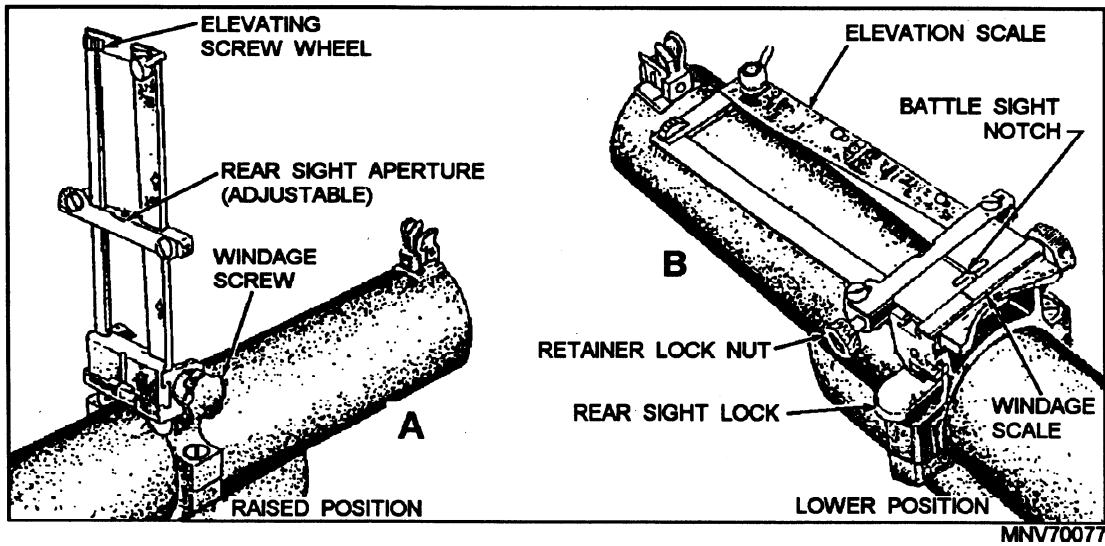

Figure 2-64.—Rearsight assembly.

GRENADE LAUNCHER

The M79 grenade launcher (fig. 2-61) is a break-open, single-shot weapon. It is breech loaded and chambered for a 40-mm metallic cartridge case with internal primer. Cartridges used with the M79 grenade launcher are shown in figure 2-62.

Controls of the M79 Grenade Launcher

The safety (fig. 2-63) located just behind the barrel locking latch. It is in the SAFE position when pulled all the way back and in the FIRING position when pushed all the way forward.

The barrel locking latch (fig. 2-63), when pushed all the way to the right, permits the breech end of the barrel to be swung up into the OPEN position. The grenade launcher cocks as it opens.

The trigger guard (fig. 2-63) is shown in lowered position. It can be released for setting to one side or the other by pushing back the cylindrical housing at the front. This makes it possible for a person wearing heavy gloves or mittens to fire the grenade launcher. The sights are shown in figure 2-64.

Operating the M79 Grenade Launcher

Use the following procedures to load and fire the M79 grenade launcher.

PREPARATION FOR FIRING.—Check the bore to be sure it is free of foreign matter or obstructions. Check all ammunition to be sure you are

using the proper type and grade. Check the launcher to be sure it is properly cleaned. Also inspect it for malfunctions and other defects.

LOADING.—Point the muzzle of the launcher at the ground and clear the area of all personnel.

Move the barrel locking latch all the way to the right and break open the breech. If the safety is not already on SAFE, this procedure will cause it to move to SAFE, provided that the barrel locking latch is moved to its full limit of travel.

Insert the projectile portion of the ammunition into the chamber opening (fig. 2-65) and push the complete round forward into the chamber until the extractor contacts the rim of the cartridge case. Close the breech.

FIRING.—Before you fire the launcher, you must be in either a standing or prone position. In the standing position, place the butt against your shoulder. In the

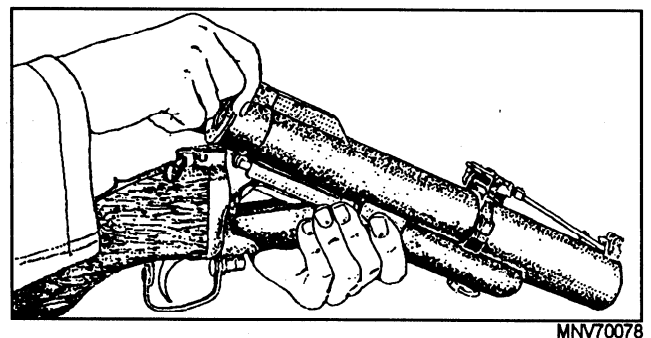
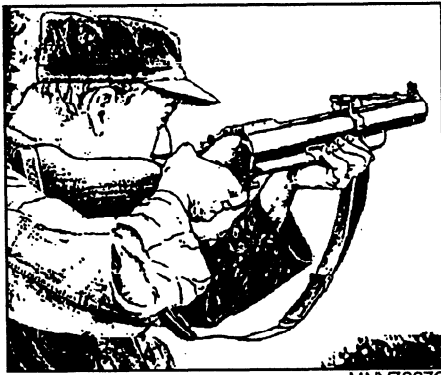

Figure 2-65.—Loading the M79 grenade launcher.



MNV70079

Figure 2-66.—Firing the M79 from the standing position.



MNV70080

Figure 2-67.—Firing the M79 from the prone position.

prone position, place the butt against the ground. (See figures 2-66 and 2-67.)

To engage targets at ranges from 50 to 80 meters (165 to 265 feet), place the rear sight frame in the lowered (called the battle sight) position (fig. 2-64). To engage targets at longer ranges, place the rear sight

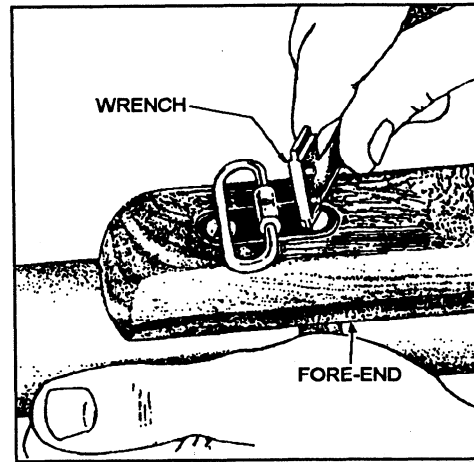

MNV70081

Figure 2-68.—Removing the fore-end assembly retainer screw.

frame in the upright position (fig. 2-64) and set the sight aperture bar at the approximate target range of the scale. TM 9-1010-205-10 provides detailed instruction on use of the launcher's sights.

When you fire grenades at targets within battle sight ranges (50 to 80 meters or 165 to 265 feet), you must be in a protected position. Do NOT fire upon targets that are within 80 meters (265 feet) of friendly troops.

Field-stripping the M79 Grenade Launcher

Field-stripping the M79 grenade launcher consists of separating the fore-end assembly from the barrel and receiver group and separating the stock from the receiver group.

To remove the fore-end assembly, first use the wrench assembly shown in figure 2-68 to remove the machine screw shown in the same figure. Then pull the front end of the fore-end assembly away from the barrel, as shown in figure 2-69, until the lug on the rear sight

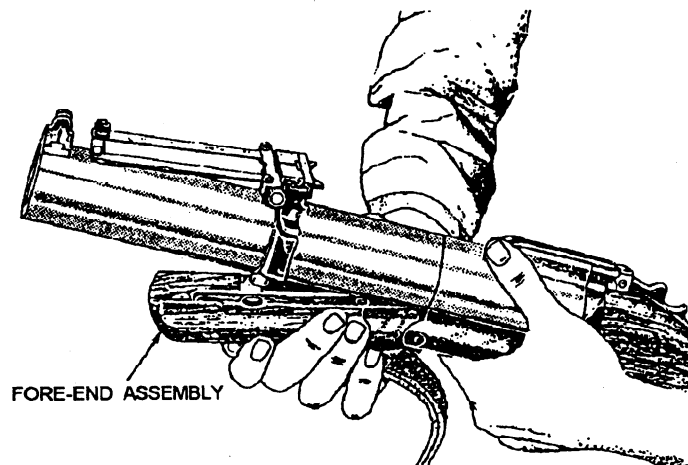

MNV70082

Figure 2-69.—Removing the fore-end assembly.

base is clear of the hole in the upper surface of the fore-end bracket. Keeping the lug clear of the hole, pull forward on the fore-end assembly until it is free of the receiver assembly.

To remove the barrel group from the receiver group, fast actuate the barrel locking latch and open the breech. Then, holding the stock and receiver stationary, move the barrel rearward in the receiver until it is disengaged from the fulcrum pin as shown in figure 2-70. Separate the barrel from the receiver group.

To separate the stock from the receiver group, use a combination wrench assembly, as shown in figure 2-71, and remove the pin-headed machine screw that secures the stock to the receiver group.

For further information on the M79 grenade launcher, refer to U.S. Army TM 9-1010-205-24 and TM 9-1010-205-10.

SPECIAL PRECAUTIONS FOR SMALL ARMS

Semiautomatic pistols in the hands of inexperienced or careless persons are largely responsible for the saying, It's always the unloaded gun that kills. Many accidental deaths and injuries are due to the mistaken belief that removing the magazine from a pistol (or other magazine-fed weapon) is all that is necessary to unload it. Simply removing the magazine DOES NOT unload the weapon. To completely unload a pistol or other magazine-fed weapon and render it safe to handle, you must not only remove or empty the magazine, but also make absolutely certain that the chamber is empty. The only way you can do this is to pull back the slide or bolt and inspect the chamber either visually or, if it is dark, by feel. You should do this after you have removed the magazine and with the muzzle

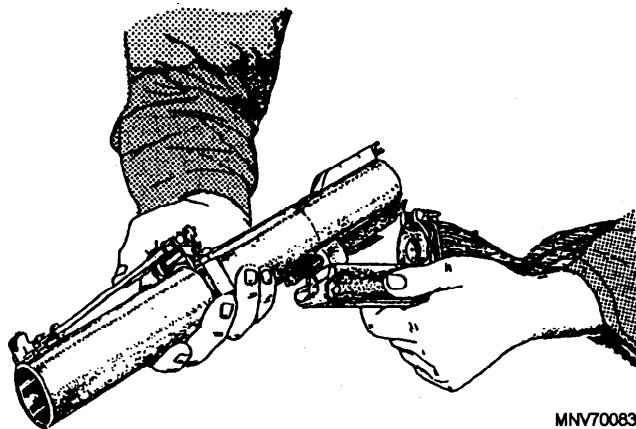

Figure 2-70.—Removing the barrel group.

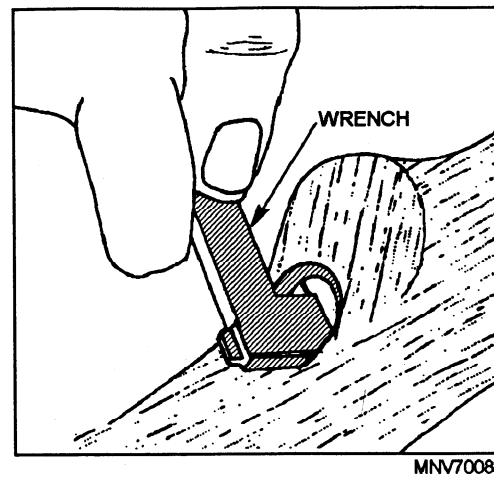

Figure 2-71.—Removing receiver group attaching screw.

pointed upward. Of course, if the chamber is loaded, the round will be extracted and ejected when you operate the slide. I didn't know it was loaded is never an excuse for the accidental discharge of a weapon. All weapons must be considered loaded when the slide or bolt is forward or the magazine is in the weapon. A weapon is safe only when the slide or bolt is locked in the open position, the magazine is out of the weapon, and the chamber is visibly empty.

When you handle revolvers, a simple visual inspection is sufficient to determine if any chambers in the cylinder are loaded.

Keep the hammer fully down when a pistol or revolver is not loaded. When the pistol is cocked, keep the safety lock in the ON (SAFE) position until you are ready to fire.

Let us review briefly some of the safety precautions that apply to the handling of all small arms:

- Never point a weapon at anyone or anything you are not ready to destroy.
- Unless you plan to use the weapon immediately, never carry it with a round in the chamber.
- Unless you are about to fire a weapon, always keep its safety in the SAFE position. Always keep your finger away from the trigger. When the safety is moved from the SAFE to the FIRE position, many small arms will fire if the trigger is pressed as the safety is released.
- Consider a gun loaded until you have opened the chamber and verified that it is empty. It is not enough to wait afterward, I didn't know it was loaded. The empty weapon is the dangerous one.

- Before you fire any weapon, be sure there are no obstructions in the bore.

- Before you fire any weapon, be sure the ammunition you are using is the right ammunition. For example, M14 ammunition cannot be used in the M16 rifle. Nor should illumination signals be used in shotguns, even though they look much like shotgun shells.

- Before firing, be sure there is no grease or oil on the ammunition or in the bore or chamber. Although lead bullets may be lightly waxed or greased, there must never be any lubricant on the cartridge case.

- Keep ammunition dry and cool. Keep it out of the direct rays of the sun. Keep ammunition clean, but do not polish it or use abrasives on it. Do not attempt to use dented cartridges, cartridges with loose bullets, or cartridges eaten away by corrosion. Be particularly careful with tracer ammunition, which can ignite spontaneously if it gets damp.

- Misfires and hangfires can occur with small arms ammunition as well as with other types. On some weapons, like the automatic pistol, you can recock and attempt to fire again without opening the breech. If, after a couple of tries, this proves unsuccessful, or if you cannot recock the weapon without opening the bolt, wait at least 10 seconds, then open the bolt and eject the defective round. Dispose of defective small arms ammunition according to current regulations.

- A misfire with blank cartridges may leave unburned powder deposited in the bore; always check the bore after any misfire and clean it if necessary.

- If you experience a light recoil or report, clear the weapon and check the bore for an obstruction. This may indicate a partial burning of the propellant that may not have been sufficient to force the bullet clear of the muzzle.

WARNING

Never try to dislodge a bullet from the barrel by firing another bullet.

SMALL ARMS MAINTENANCE

The cleaning, preservation, and care given to small arms are determining factors in their operation and shooting accuracy. You have undoubtedly heard that an ounce of prevention is worth a pound of cure. This can aptly be applied to the maintenance of all ordnance weapons and equipment. To properly maintain these weapons, you must use a system of preventive maintenance. The preventive maintenance procedures for Navy small arms are set forth in the appropriate 3-M Systems MRCs.

Preventive maintenance is the systematic care, inspection, and servicing of material to maintain it in a serviceable condition, to prevent breakdowns, and to assure operational readiness. To maintain your small arms in a state of readiness, you must ensure that they are serviced (including lubrication) each time they are used and periodically when in stowage.

Inspections of each weapon are an important part of preventive maintenance. Inspections to see if items are in good condition, correctly assembled, secure, not worn, and adequately lubricated, apply to most items in preventive maintenance procedures.

STOWAGE AND ISSUE OF SMALL ARMS

Small arms should always be stowed in an authorized and secure stowage to prevent pilferage. A strict accountability must be maintained at all times. This includes access control, key custody, and storage requirements.

Since all small arms are considered equipage, a signature of subcustody is required before they are issued from their normal place of stowage. Any type of signed custody record may be used as long as it bears the receiving individual's signature. Your armorer has a list of personnel who are qualified to be issued weapons. Anyone who is not on that list will not be able to draw a weapon from the armory. Out-of-the-ordinary requests for weapons are usually prearranged and authorized. Questionable requests for weapons are referred to the chief, the division officer, or the command duty officer.

CHAPTER 3

PYROTECHNICS

LEARNING OBJECTIVES

Upon completing this chapter, you should be able to do the following:

1. Discuss the common pyrotechnic devices currently in use on modern Navy surface ships.
2. Describe the procedures for handling and stowing pyrotechnics safely.

INTRODUCTION

Pyrotechnic is the Greek word for fireworks. The Navy uses fireworks not for celebration, but for illumination, marking, and signaling. An example is the illuminating projectile, or star shell, used to illuminate targets for gunfire. The star shell is a pyrotechnic device encased in a projectile body of standard external shape and fired from a standard rifled gun.

In this chapter, we will discuss the common pyrotechnic devices currently in use on modern Navy surface ships. For further information on these and other pyrotechnic devices used by the Navy, refer to *Pyrotechnic Screening, Marking, and Countermeasure Devices*, NAVSEA SW050-AB-MMA-010. All the pyrotechnics we study here are intended for signaling and marking. The devices we will discuss are:

- marine location markers,
- marine illumination signals and the pyrotechnic pistols and projectiles used in firing them, and
- distress and hand signals.

Also, at the end of this chapter, we will provide some basic information on the proper handling and stowage of these devices.

MARINE LOCATION MARKERS

Marine location markers are used as night or day long-burning reference markings on the surface of the ocean. They are dropped over the side from surface ships for man-overboard marking, navigation drills, and other similar operations. These markers may also be dropped from aircraft for search and rescue operations. The two marine location markers currently in use are the Mk 58 and the Mk 6.

MK 58 MARINE LOCATION MARKER

The Mk 58 marine location marker is the primary marine location marker found aboard surface vessels. It is approximately 21 1/2 inches long and weighs about 12 3/4 pounds. It contains a battery squib, some starter mix, two pyrotechnic candles, and a transfer fuse between the two candles. Before the marker is launched (thrown overboard), the tear tape over the water port must be removed so that seawater can enter the marker and activate the battery. Battery current energizes the electric squib, which ignites the starter mix, which, in turn, lights the pyrotechnic candle. As the first candle burns out (in 20 to 30 minutes), the second candle is started by the transfer fuse, for a total burning time of approximately 40 to 60 minutes. The Mk 58 currently is available in two versions, the Mod 0 and the Mod 1.

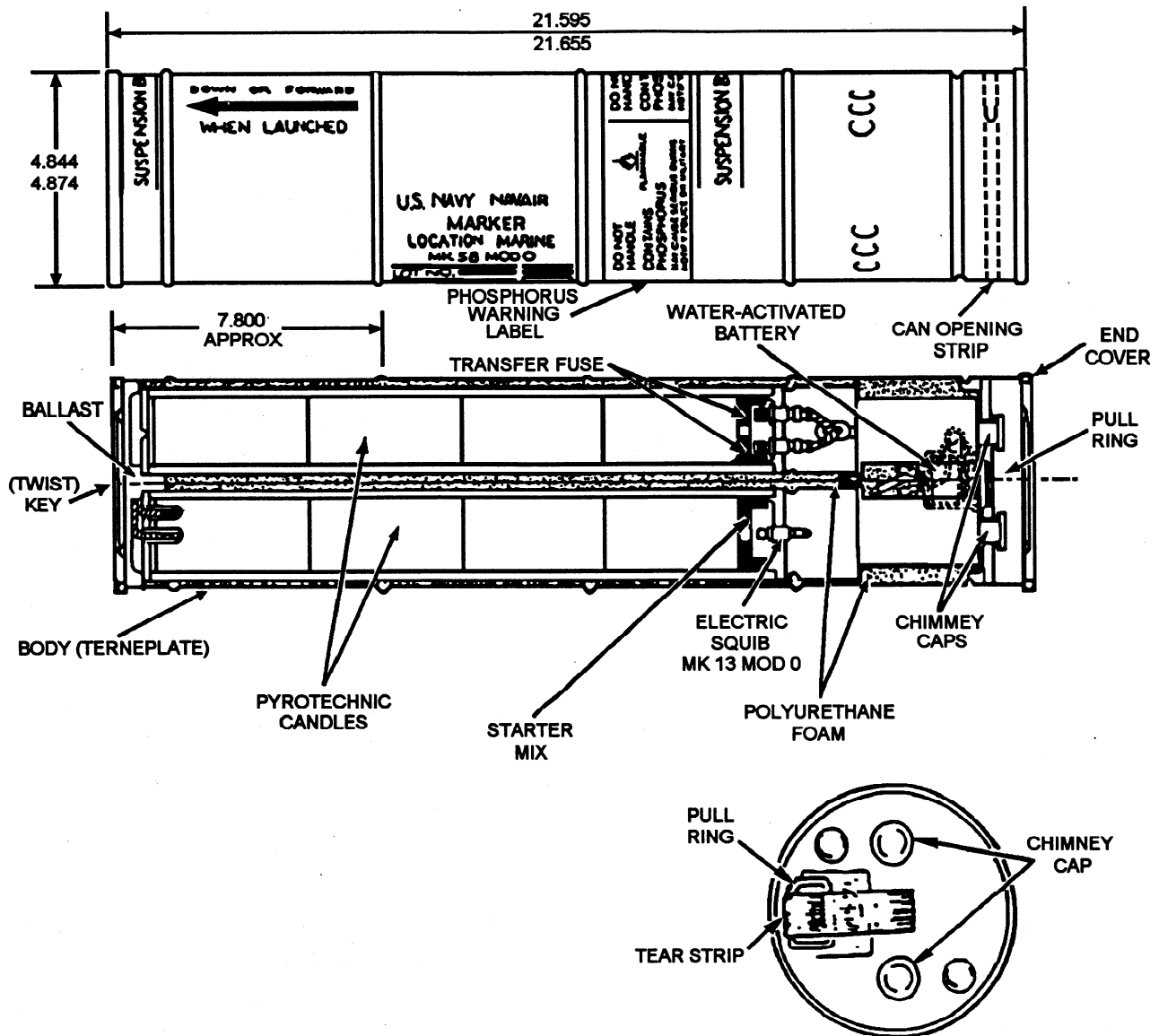

MNV70085

Figure 3-1.—The Mk 58 Mod 0 marine location marker.

The Mod 0 (fig. 3-1) is a hermetically sealed can whose end cover can be removed with a twist key, much like the lid on a canned ham. Notice on the figure that the opening key is attached to the bottom of the can. If you open one of these devices, be careful. The rim left by the can opening strip is very sharp and can cause serious cuts to your hands as you attempt to remove the tear strip, located under end cover. Figure 3-1 shows the tear strip and its attached pull ring. The chimney caps cover the holes through which the flames and smoke pour when the device is activated.

To correct the safety problem created by removing the end cover with a key, the Mod 1 (fig. 3-2) has a smooth rim at its top and is capped with a replaceable

polyethylene cover. Notice on figure 3-2 the slight difference in the tear strip. Also notice that the chimney caps have been replaced by adhesive foil disks.

MK 6 MARINE LOCATION MARKER

The Mk 6 smoke and illumination signal (fig. 3-3) is a pyrotechnic device that is launched only from surface craft, to produce a day or night floating reference point. One of its principal uses is as a man-overboard marker. It was previously approved for launching from low-performance aircraft as a long-burning marker but has been replaced for this purpose by the Mk 58 marine location marker.

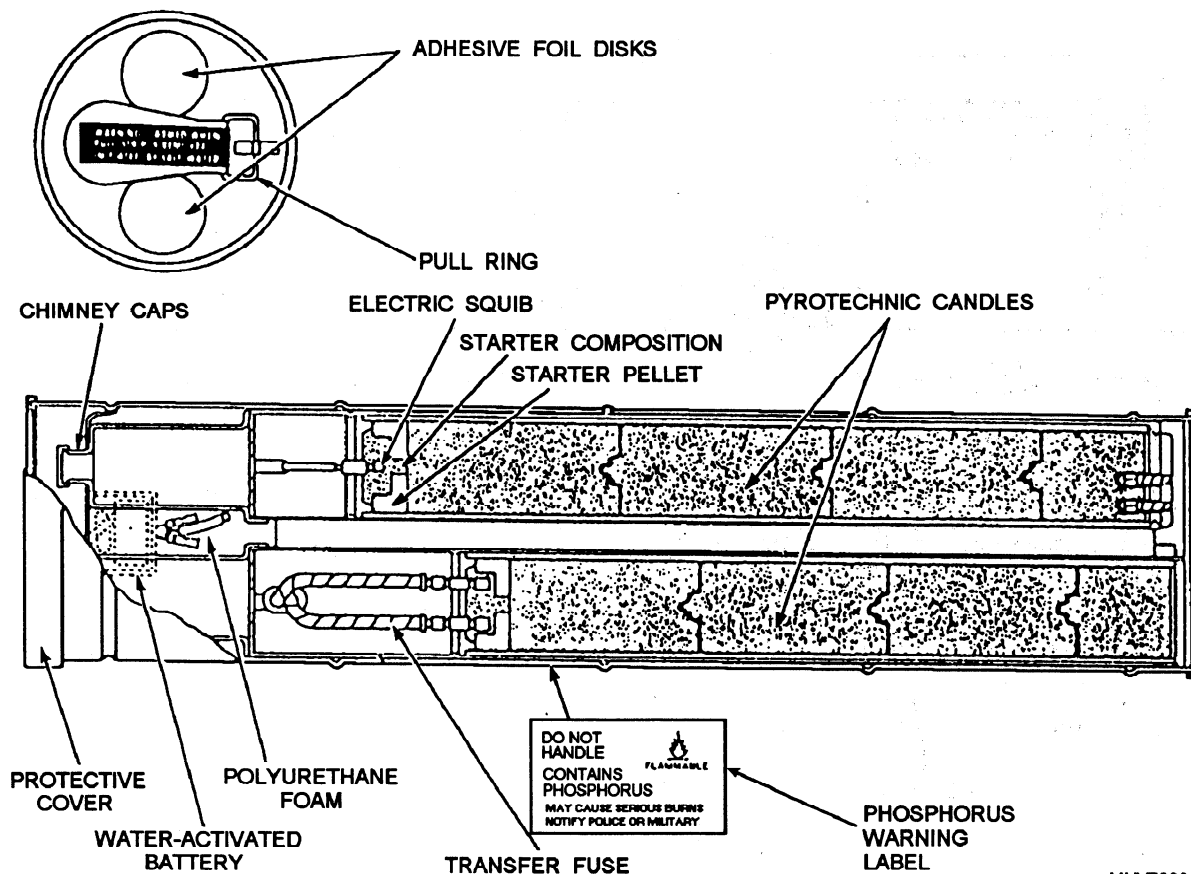

Figure 3-2.—The Mk 58 Mod 1 marine location marker.

The Mk 6 signal consists of a wooden body with a flat, die-cast metal plate fixed to its bottom end to protect it from water impact damage and to maintain it in the correct floating attitude. There are four flame and smoke emission holes in the opposite end, each capped and sealed with tape. The pull-wire ring, also at the emission end, is also covered with tape.

The Mk 6 signal has a direct-firing ignition system. Ignition results from pulling the pull ring. The pull ring is pulled by hand, and the device is thrown into the water immediately. The pull wire ignites a 90-second delay fuse that ignites the quick match at the top of the first of four candles. The quick match ignites the first candle starting mix, which, in turn, initiates burning of that candle. Expanding gases of combustion force the cap and tape from the emission hole, allowing smoke and flame to be emitted. When the first candle is nearly burned out, a transfer fuse carries the ignition to the quick match of the next candle in series. This process continues until all four candles have burned. A yellow flame and gray-white smoke are produced for a minimum of 40 minutes.

After the device has been removed from its shipping container, the following rules apply:

1. Do not disturb the tape over the pull ring until immediately before you launch the device. This tape not only prevents an accidental pull on the pull ring but also protects the igniter assembly from moisture, which might render the signal useless.

WARNING

This signal is initiated by the physical movement of a friction wire through ignition compound. Take extreme care to prevent tension on the pull ring during all handling operations.

2. If you prepare this device for launching and do not launch it, securely retape the pull ring into position at the top of the signal without exerting any pulling force on the pull-wire igniter.

3. Under no circumstances should these signals be stowed or restowed with their pull rings exposed or with

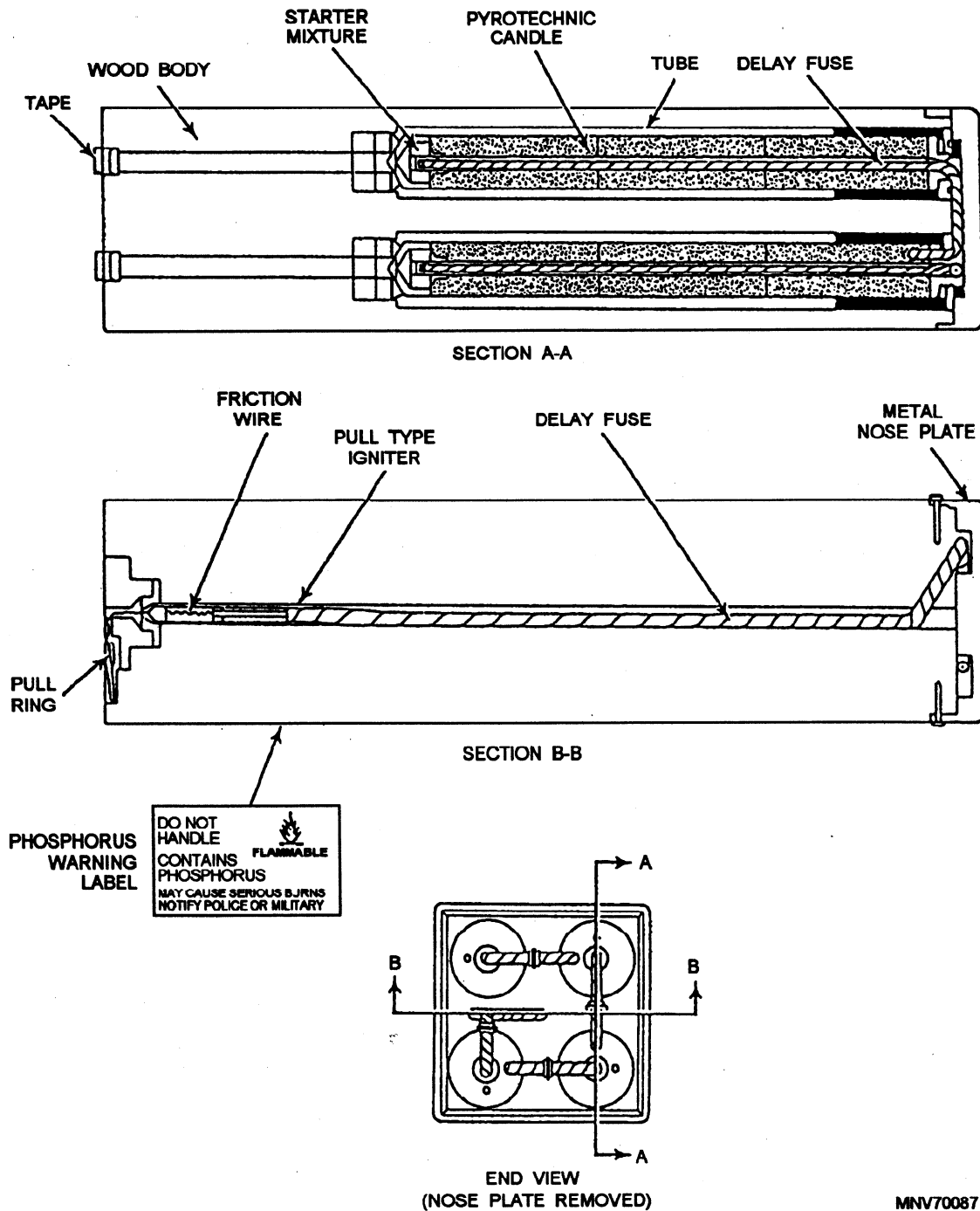

Figure 3-3.—The Mk 6 Mod 3 marine location marker.

any wires, strings, or other material of any kind joined to their pull rings.

All safety precautions pertaining to this signal must be observed. In addition, the following specific rules apply:

1. Do not remove the tape over the pull ring until immediately before you launch the device.

2. Throw the Mk 6 signal over the side immediately after you pull the pull ring. This device has a maximum 90-second delay between initiation and candle ignition.

3. In all handling situations, take extreme care to avoid pulling on the pull ring. The slightest movement of the friction igniter may start the ignition train.

The Mk 6 marine location marker is being replaced by the Mk 58. There are, however, remaining serviceable stocks of the Mk 6 available. If you have any of these markers in your inventory, use them first. Man-overboard and navigation drills are good instances where these stocks can be efficiently expended.

MARINE ILLUMINATION AND SMOKE SIGNALS

Marine illumination signals are similar in appearance to a standard shotgun cartridge. When one of these signals is fired from the proper pistol or projector, a burning star (somewhat like a star from a Roman candle) shoots high into the air. In this section, we will describe the marine illumination and smoke signals and pyrotechnic pistols currently in use. These include the

- Mk 2 marine illumination signal,
- Mk 5 pyrotechnic pistol,
- AN-M37A2 through AN-M39A2 series, double-star illumination signal,
- Mk 1 marine illumination signal, and
- AN-M8 pyrotechnic pistol.

MK 2 MARINE ILLUMINATION SIGNAL

The Mk 2 marine illumination signal is a six-second signal that is available in three colors: red, green, and

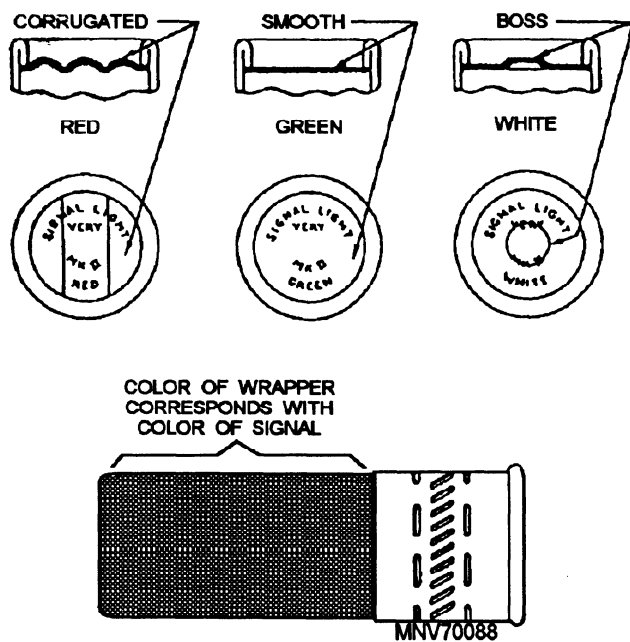

Figure 3-4.—The Mk 2 marine illumination signal.

white. Each cartridge has a percussion primer and a propelling or expelling charge of ten grains of black powder, which projects the burning star to a height of about 200 feet. The star charge is a tightly-packed cylinder wrapped with a quick match (a fast-burning fuse) that ignites when the signal is fired. The star charge is separated from the expelling charge by a shock-absorbing wad of hard felt. The cartridge is closed by a wad whose end is shaped so that color of the star can be determined at night by feel, as shown in figure 3-4.

The red star has a corrugated closing wad, the green star has a smooth closing wad, and the white star has a small conical boss on its closing wad. Each of the signals may also be identified by the corresponding color of the paper on its cartridge.

The illumination signals are available in ten-round metal or cardboard containers. The containers are packaged in wooden boxes that hold 40, 45, or 100 containers.

MK 5 Pyrotechnic Pistol

Mk 2 marine illumination signals are fired from the Mk 5 pyrotechnic pistol. This pistol is a breech-loaded, double-action, single-shot device, 11 inches long. Metal parts are mounted on a plastic frame. The operating instructions for the Mk 5 pistol are as follows:

1. To load the pistol, depress the latch button below the barrel. At the same time, pull the barrel downward, as shown in figure 3-5, view A. Insert the signal shell (view B). Bush the barrel upward until it latches in the closed position. The pistol is now ready to fire.

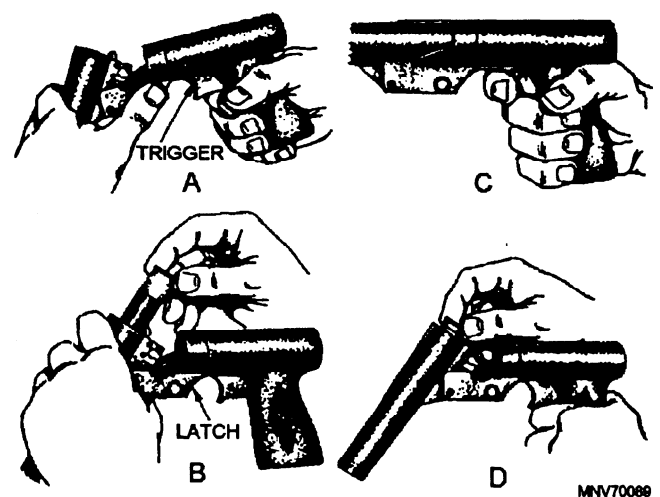

Figure 3-5.—Operation of the Mk 5 pyrotechnic pistol.

2. To fire the pistol, aim it upward at the desired angle, normally 60 degrees, but clear of other ships or personnel. Pull the trigger, as shown in figure 3-5, view C. Keep your elbow slightly bent when firing to absorb the shock of recoil and to prevent the pistol from knocking itself out of your hand.

3. To extract the expended shell, break the pistol open again (view A) and pull the shell out of the chamber (view D).

WARNING

The pyrotechnic pistol is cocked at all times when the breech is closed; it has no positive safety mechanism. **DO NOT** load an illumination signal into the pistol until just before you are ready to use it. **DO NOT** leave unfired signals in the pistol.

The Mk 5 pistol must be kept in serviceable condition at all times. Clean it thoroughly after each use according to the procedure prescribed on the appropriate 3-M System maintenance requirement card (MRC).

When you load or fire a pyrotechnic pistol, **NEVER** point it in the direction of other personnel or vessels.

NEVER use the Mk 5 pistol with ammunition other than that authorized for use with it. Conversely, never fire illumination signals from shotguns or from projectors other than those authorized

**AN-M37A2 THROUGH AN-M39A2 SERIES,
DOUBLE-STAR AIRCRAFT
ILLUMINATION SIGNAL**

The AN-M37A2 through AN-M39A2 series illumination signals (fig. 3-6) are fired from the AN-M8 pyrotechnic pistol for either day or night identification or signaling. Each signal projects two stars of the same color, which burn from 7 to 13 seconds, to an altitude of approximately 250 feet above the point of launch. The 25,000-candlepower stars are visible from 2 to 3 miles in daylight and 5 miles at night in clear weather. The display colors are indicated by 1/4-inch bands around the circumference of the signal and by colors on the closing wad. No provision is made for identification by touch as with the Mk 2 marine illumination signal. These signals ignite upon firing since they have no delay fuse.

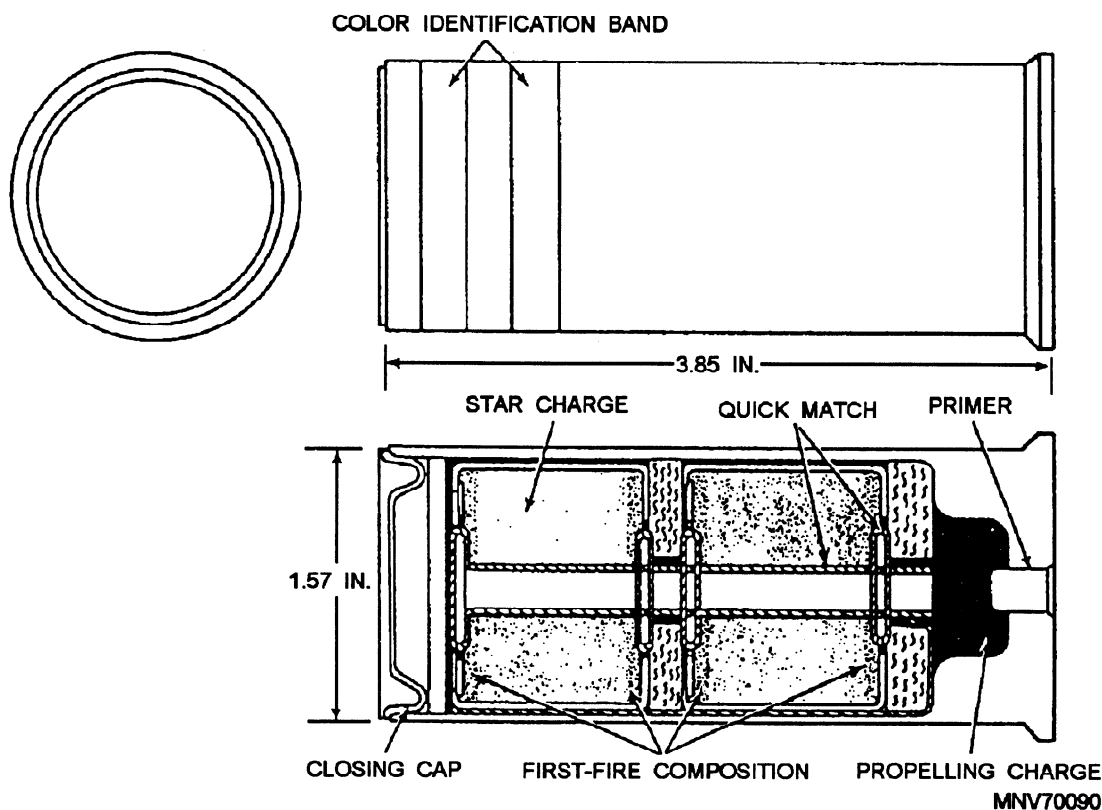

Figure 3-6.—The AN-M37A2 through AN-M39A2 aircraft illumination signals.

MK 1 MARINE ILLUMINATION SIGNAL

The Mk 1 marine illumination signal (fig. 3-7) is a general-purpose signal fired from the AN-M8 pyrotechnic pistol. The Mk 1 signal is available in two versions: the Mod 0 and the Mod 1. The Mod 0 produces a red, green, or yellow 7- to 11-second star that falls free and leaves a trail of white light, similar to a comet. The Mod 1 produces a 20- to 30-second parachute-suspended red star. Both rounds are expelled from the pyrotechnic pistol by an auxiliary explosive to an approximate altitude of 30 feet. A rocket motor then ignites to propel the signal to a minimum height of 500 feet. It is stabilized in flight by folded fins that spring out once the signal is fired. At the end of its burn, the rocket propellant ignites an expelling charge and the pyrotechnic composition

MK 2 MARINE SMOKE SIGNAL

The Mk 2 marine smoke signal (fig. 3-8) is intended primarily for signaling between ships and aircraft. It consists of a parachute-suspended red smoke display that persists for 20 to 30 seconds at a minimum height of 500 feet. The Mk 2 smoke signal is fired from the AN-M8 pyrotechnic pistol and functions much the same as the Mk 1 marine illumination signal.

AN-M8 Pyrotechnic Pistol

The AN-M8 pyrotechnic pistol (fig. 3-9) is similar to the Mk 5 pyrotechnic pistol. It can be used with a number of shotgun-shell-shaped signals. The AN-M8 pyrotechnic pistol is loaded and fired in much the same fashion as the Mk 5. To open the breech for loading and unloading, raise the breechblock and pivot the hinged barrel down. The same safety and maintenance procedures also apply.

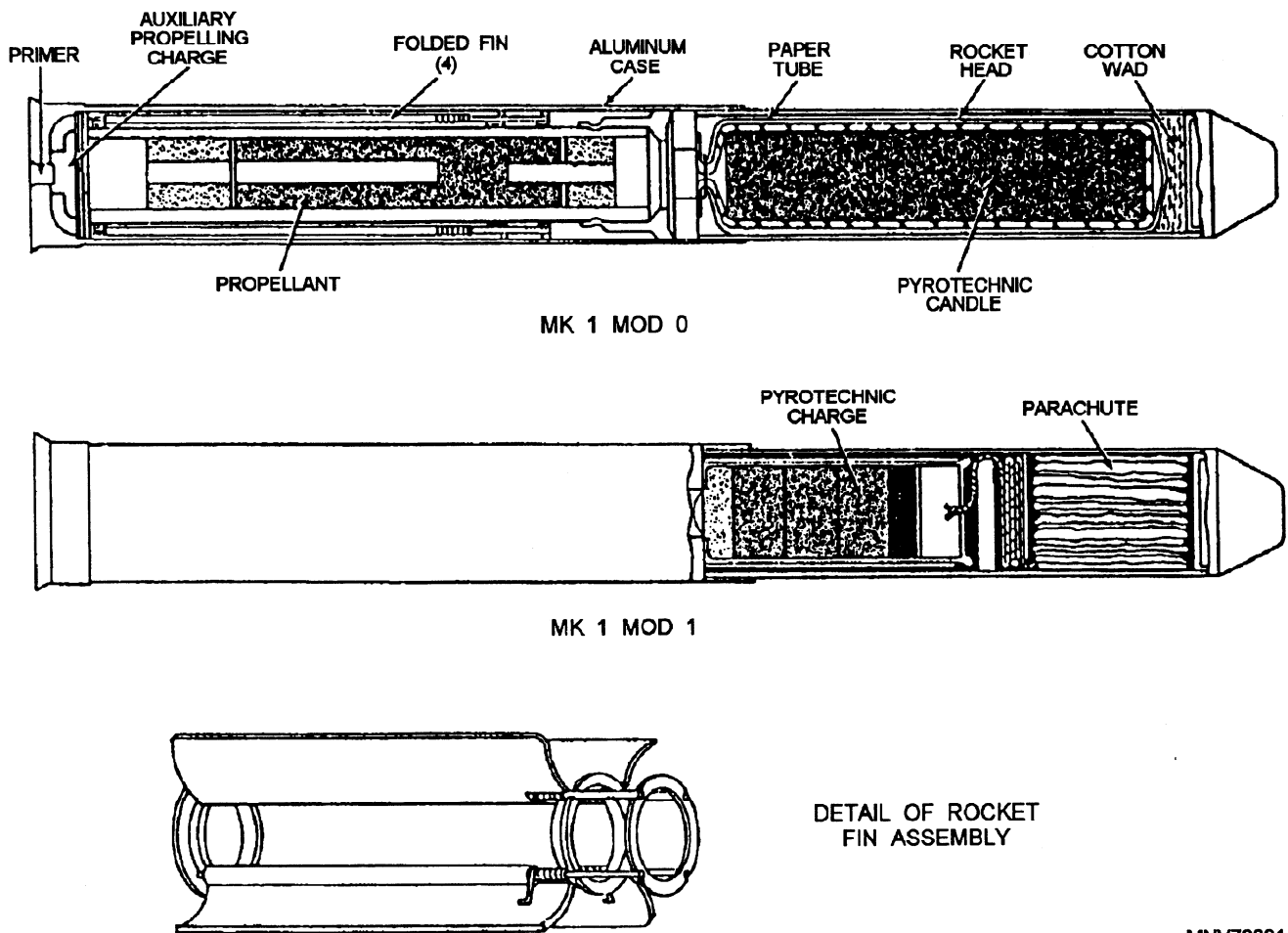

MNV70091

Figure 3-7.—The Mk 1 marine illumination signal.

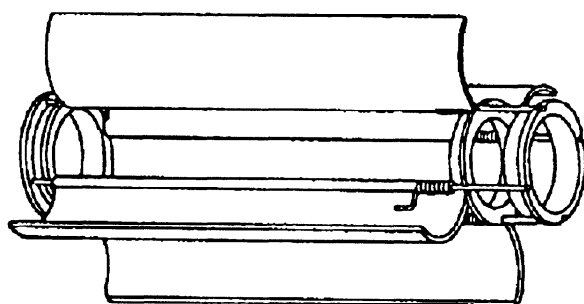
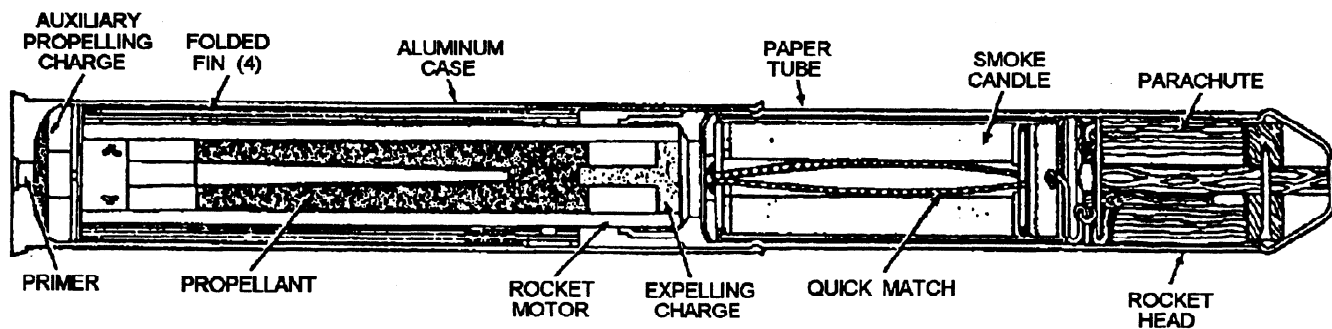

DETAIL OF ROCKET
FIN ASSEMBLY

MNV70092

Figure 3-8.—The Mk 2 marine smoke signal.

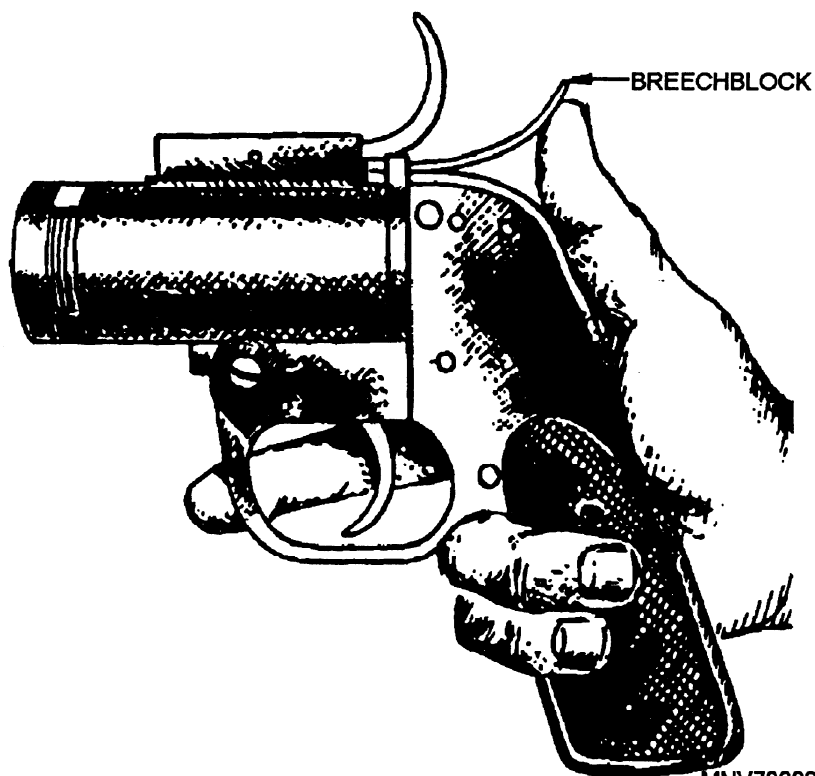

MNV70093

Figure 3-9.—The AN-M8 pyrotechnic pistol.

PERSONNEL DISTRESS SIGNALS

Three types of personnel distress pyrotechnic devices are currently found aboard surface ships. The Mk 13 smoke and illumination signal and the Mk 1 Navy light are hand-held signaling devices. The Mk 79 personnel distress signal kit contains compact light signal rounds that are shot into the air.

Mk 13 MARINE SMOKE AND ILLUMINATION SIGNAL

The Mk 13 marine smoke and illumination signal (fig. 3-10) is a metal cylinder about 5 1/8 inches long and 1 5/8 inches in diameter. It weighs between 6 and 7 ounces. One end contains a canister that, when ignited, produces orange smoke for about 20 seconds. The other end contains a pyrotechnic flame pellet that will burn for approximately 20 seconds.

Each end of the metal tube is enclosed by a plastic cap. Under each cap is a pull ring. When you pull the ring, a friction wire moves through a cap coated with a composition that ignites (by friction), setting off either the flare or the smoke canister (depending on which ring you pull).

The signal body carries illustrated instructions for use. The flame end plastic cap has three prominent protrusions (beads) across its face to identify it as the end to use at night. When you use the signal, point it away from your face and hold it at arm's length at a 45-degree angle after it ignites. After the end of the signal that you ignited burns out, douse the signal to cool its metal parts. Keep the signal so that, if necessary, you can use the other end. Each end is separately insulated and waterproofed. NEVER try to use both ends at once. When you use the smoke signal, keep it to leeward.

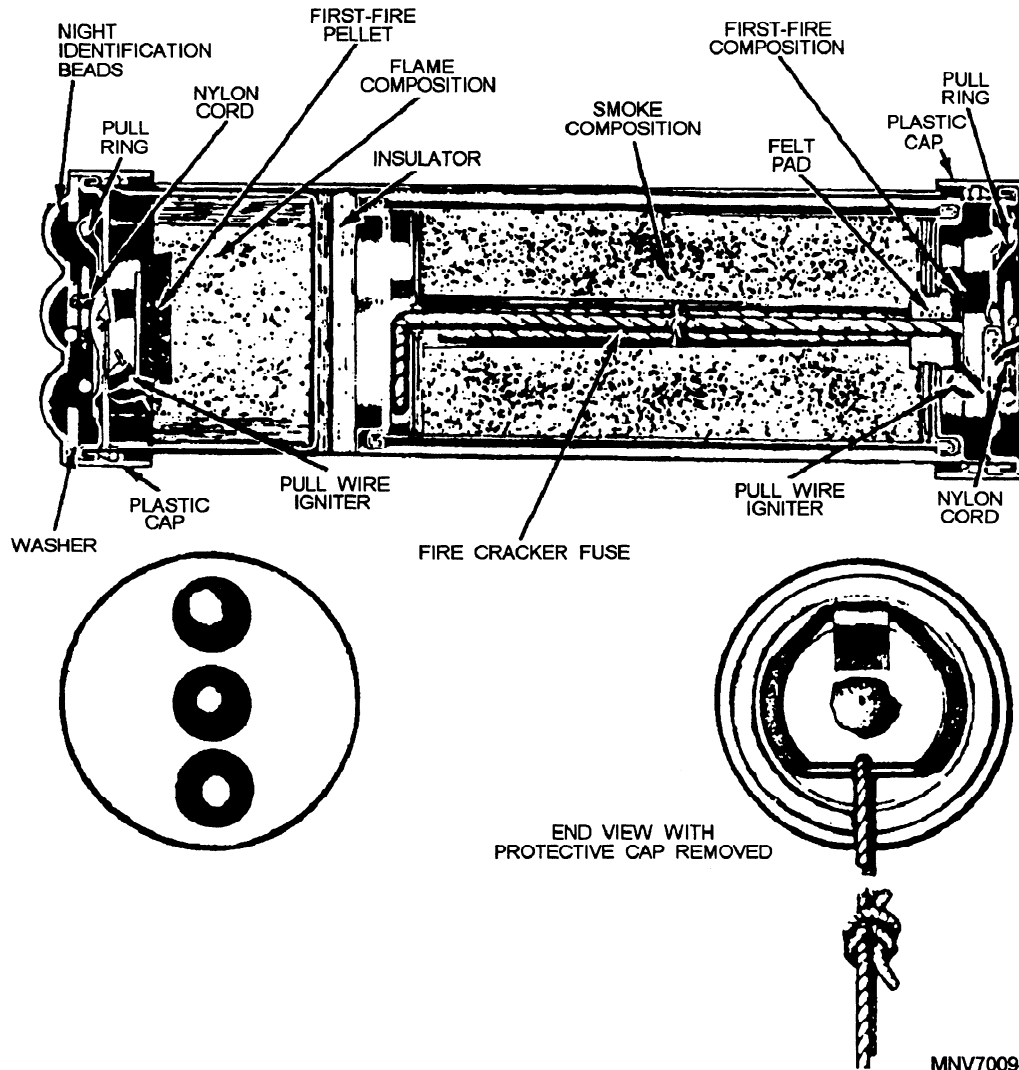

Figure 3-10.—The Mk 13 marine smoke and illumination signal.

These signals are packaged 12 per aluminum container (Mk 3), with 9 containers (108 signals) per wooden box. They may also be packaged 18 signals per aluminum container (M2A1).

MK 1 NAVY LIGHTS

Navy lights are hand torches that burn with a brilliant light visible up to 3 miles at night. They come in two colors, blue and red. The blue lights (Mk 1 Mod 1) burn for 75 seconds; the red lights (Mk 1 Mod 0) burn for 135 seconds. The two lights are similar in appearance and construction (fig. 3-11).

Navy lights consist of a paper tube that contains the pyrotechnic substance, with a wooden handle at one end and a cover with an exterior coating of abrasive, like that on the scratching side of a safety matchbox, at the other end. A tear strip protects the exterior of the cover. The upper end of the paper tube, beneath the cover, is capped by a fabric impregnated with igniting compound similar to that on the head of a safety match.

To ignite the Navy light, tear off the protective strip, remove the cover, and scrape the inverted cover across the top of the paper tube. As you strike the light, hold it pointing away from you at an angle of about 45 degrees to avoid contact with hot particles falling off the pyrotechnic candle. Hold the light at that angle while it burns.

Navy lights are shipped in metal containers, each containing 6 to 12 lights. The metal containers are packed into cardboard cartons that hold 12 metal containers. Since these lights deteriorate when exposed to moisture, they should not be removed from their containers until they are needed for use. For the same reason, keep them away from water or moisture. Lights that have been left in open containers for more than 6 months should be turned in to the nearest ammunition depot at the earliest opportunity. Lights that have become chemically encrusted or give off an acetic acid (vinegar) odor should be disposed of immediately. Put them in a weighted sack and dump them overboard.

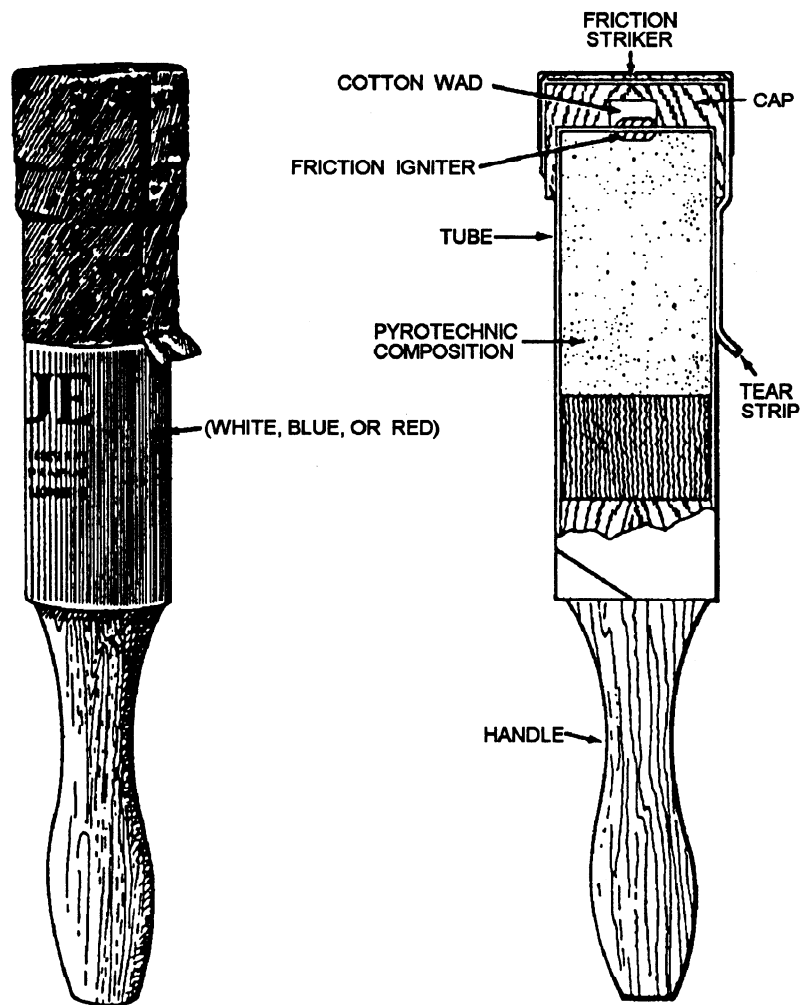

MNV70095

Figure 3-11.—The Mk 1 Navy light.

**MK 79 MOD 0 AND MOD 2 PERSONNEL
DISTRESS SIGNAL KIT**

This kit (fig. 3-12) is designed to be used by downed aircrew personnel or personnel in life rafts as a distress signaling device. It is small and lightweight so that it can be carried in pockets of flight suits or on life rafts. Each signal contains a red pyrotechnic star that will burn for a minimum of 4 1/2 seconds. On activation, this star is propelled upward to a minimum height of 250 feet.

The Mk 79 Mod 0 kit consists of one Mk 31 Mod 0 surface signal projector, a plastic bandoleer holding seven Mk 80 hand-fired signals, and an instruction

sheet. The Mk 79 Mod 2 kit contains Mk 80 Mod 2 signals.

The projector consists of a steel cylinder slightly more than 5 inches long and approximately 1/2 inch in diameter. The base (or handle) is knurled to provide a more positive gripping surface. The firing end of the projector has internal threads that match the external threads of the signal. Near this end is a firing slot through which the trigger screw moves when it is released from the safety slot. The trigger screw is attached to the firing pin that is forced against the signal primer by a helical spring within the knurled portion of the cylindrical body.

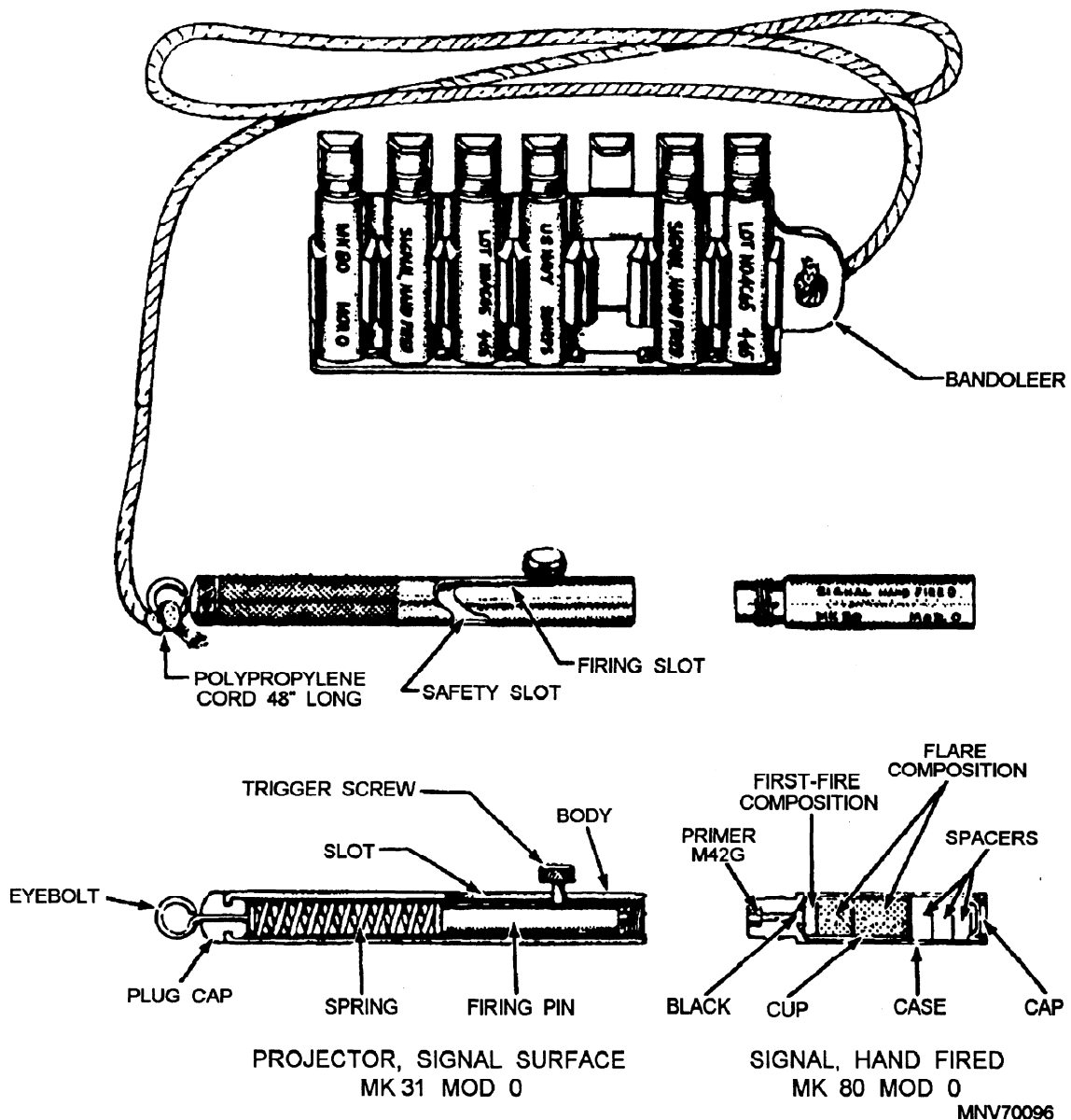

Figure 3-12.—The Mk 79 Mod 0 illumination signal kit.

A plastic bandoleer designed to hold seven signals is attached to the base of the projector by a 48-inch polypropylene cord.

Operating Instructions

The Mk 31 Mod 0 projector is a simple signaling device. Operate it as follows:

1. Cock the firing pin of the projector by moving the trigger screw to the bottom of the vertical slot and slipping it to the right so that it moves to the upper end of the angular (safety) slot.

2. Break the protective plastic tab away from the signal you plan to attach to the projector.

WARNING

The plastic tabs over the signals in the bandoleer protect the percussion primers from being struck accidentally. Do not remove a signal's tab until just before you load the signal into the projector.

3. Mate the projector with the signal and rotate the projector clockwise until it is seated on the signal. Pull the signal from the bandoleer.

4. Hold the projector over your head with your arm fully extended. Be sure the projector is pointed at a slight angle away from your body.

5. While firmly gripping the projector, fire the signal by slipping the trigger screw to the left out of the safety slot and into the firing slot.

NOTE

This action should be one continuous movement so that your thumb does not interfere with the forward motion of the firing pin.

6. If the signal fails to fire, pull the trigger screw back to the bottom of the firing slot against the force of the spring, and release it quickly.

WARNING

Whenever you remove a misfired cartridge, be sure to keep it pointed in a safe direction and do NOT place any part of your hand over the discharge end of the cartridge.

7. Unscrew the spent signal case or signal that has failed to fire and discard it by throwing it over the side.

8. Place the trigger screw in the safety slot and reload, as in step 4, if you need to fire another signal.

Safety Precautions

The following special safety precautions apply to the use of the Mk 79 kit:

1. Signals in this kit are ignited by percussion primers, which should be protected against being struck. Protruding tabs of the bandoleer, which extend over the signal bases, prevent accidental striking of the primers. Do not tear them off or bend them back except when you load a signal into the projector.

2. Do not load the projector until just before you are ready to fire the signal. If you load a signal into the projector but do not fire it immediately, return it to the bandoleer.

WARNING

Do NOT use dented or damaged signals. Dents or other imperfections may cause violent actions if you fire such a signal.

3. Inspect the signals periodically to ensure that they are not dented or otherwise damaged.

4. Keep the signals away from fire and other heat sources.

5. Check the projector trigger screw frequently to ensure that it is tight. A loose trigger can release the firing pin prematurely and cause injury, or it might fall out and be lost during emergency loading, thereby rendering the projector useless.

6. Keep the trigger screw in the safety slot while you load a signal.

7. When you fire the projector, be sure to raise your arm well above your head and hold the projector in a vertical position. NEVER point a loaded projector toward other personnel or toward your body.

PYROTECHNIC SAFETY, HANDLING, AND STOWAGE

The following general information is taken directly from chapter 1 of *Pyrotechnic Screening, Marking, and Countermeasure Devices*, NAVSEA SW050-AB-MMA-010.

PYROTECHNIC SAFETY

All pyrotechnic and screening devices, while designed and tested to be safe under normal conditions, can be subject to accidental ignition because of a wide variety of circumstances. The general rule to follow is: Be constantly aware that pyrotechnics contain chemical components that are intended to burn with intense heat, and act accordingly.

Toxic Hazards of Pyrotechnics

Many chemicals used in pyrotechnics, screening equipment, and dye-marking devices are poisonous if taken internally. This also applies to the residue of burned pyrotechnics. From the inhalation standpoint, the products of pyrotechnic devices and smoke generators often present a serious problem. Many of the smokes and fumes given off by pyrotechnics and screening devices are considered nontoxic and are only mildly irritating to the eyes and nasal passages when encountered in relatively light concentrations out-of-doors. Heavy concentrations in closely confined spaces, however, are dangerous and may be lethal because they reduce the amount of oxygen in the air. Avoid anything more than a brief exposure to the gases of combustion or to screening smokes. If you must, spend more than a brief time in the gases or smokes, protect yourself by using an appropriate breathing apparatus.

PYROTECHNIC HANDLING AND STOWAGE

All pyrotechnics and smoke-screening devices are designed to withstand normal handling. However, they should still be handled as little as possible, to lessen the chances of damage, which might cause accidental ignition or leakage. Many devices contain dangerous materials and are therefore designed with built-in safety features, which should be maintained in good operating condition. Dents, deformations, or cracks in the outer body may interfere with the proper functioning of these

safety features or might cause ignition during handling or stowage. Because of the potential dangers associated with these devices, take great care to prevent damage both to the devices and to their containers.

Effect of Moisture on Pyrotechnics

The proper functioning of pyrotechnic, dye-marking, and screening devices is frequently affected by moisture. Some compositions become more sensitive and dangerous when exposed to moisture, while others tend to become difficult to ignite and less dependable in operation. When you handle or stow these devices, exercise care to prevent damaging their seals because some of them are activated when their chemical contents react with moisture in the air. Also, bear in mind that some marine location markers, such as the Mk 58, are saltwater-activated. In emergency situations, markers with damaged seals could be activated by exposure to fire-fighting water or runoff.

Effect of Temperature on Pyrotechnics

Pyrotechnics and some screening devices may become adversely affected by excessively high or variable temperatures. These devices should never be stored where direct rays of the sun could generate excessively high temperature. Stowage should be in dry, well-ventilated places that provide the greatest possible protection from such conditions. All Navy pyrotechnics have been designed to withstand temperatures from -65°F to 160°F, so they should be safe from deterioration or damage within that range. However, every reasonable effort should be made to maintain stowage temperature at not more than 100°F. Specific ammunition stowage temperature requirements for all types of ammunition are addressed in NAVSEA OP 4.

CHAPTER 4

MARLINESPIKE SEAMANSHIP

LEARNING OBJECTIVES

Upon completion of this chapter, you should be able to do the following:

1. Describe the different types of line that the Navy uses.
2. Describe the care and handling of natural and synthetic lines. Identify how to work out kinks and twists in line.
3. Explain how to splice line.
4. Identify the practical knots, bends, and hitches that are used in typical Seaman's work.
5. Describe different types of seizing and explain their uses.
6. Explain how wire rope is constructed and used.

INTRODUCTION

This chapter deals with the art of knotting and splicing, an age-old craft in which all mariners must be proficient. Rope is manufactured from wire, fiber, and combinations of the two. After completion of this chapter, you should be able to explain the construction of line and wire rope and understand their use and care. You will gain knowledge in supervising line-handling details, along with the terminology and safety factors to be observed. You will also learn how to tie many useful knots and how to splice line.

FIBER ROPE (LINE)

Fiber rope—or *line*, as it is commonly called—is fashioned from natural or synthetic (man-made) fibers. When we refer to line, we mean rope made from either of these two fibers. Lines made from a variety of natural fibers (cotton, agave, jute, hemp, and abaca) have seen service in the Navy in the past, and some still are used. For example, tarred hemp is known as marline and ratline. Manila (made from the fibers of the abaca plant) formerly was authorized for use only where great strength was required. Now, manila is authorized for general purposes and serves as lashings, frapping lines, steady lines, and riding lines on fueling rigs. Synthetic lines made of nylon, armaid (Kevlar®),

polyester (Dacron®), and polypropylene have been substituted for manila in most applications.

CONSTRUCTION OF LINE

Line currently used in the Navy may be three-strand, four-strand, braided, or plaited. In three-strand line, the fibers are first twisted to the right to form yarns. Next, the yarns are twisted to the left to form strands. Then, the strands are twisted to the right to form line.

The procedure just described is standard and is used in making right-laid line. Figure 4-1 shows how three-strand right-laid line is made. The system is reversed when left-laid line is made. In either instance, the

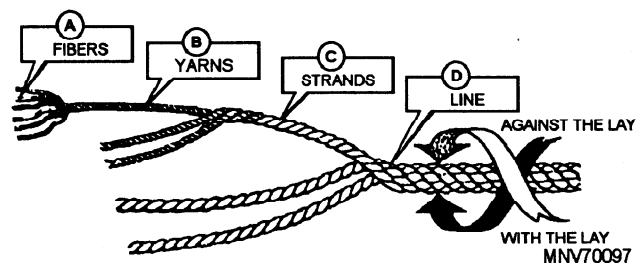

Figure 4-1.—Fiber groupings in a three-strand line.

principle of opposite twists must be observed. The reason for this is to keep the line tight or stable and to prevent the parts from inlaying when a load is suspended on it. All Navy line 1 3/4 inches in circumference or larger must be right laid. This requirement is important because if a left-laid line and a right-laid line were bent together, they would unlay each other under strain.

Braided lines have certain advantages over twisted lines. They will not kink or cockle (explained later), nor will they flex open to admit dirt or abrasives. The construction of some braids, however, makes it impossible to inspect the inner yarns for damage. The more common braided lines are hollow-braided, stuffer-braided, solid-braided, and double-braided.

Hollow-braided lines usually consist of an even number of parallel, tapelike groups of small yarns braided into a hollow, tubelike cord. This type of construction, formerly in cotton, was used for signal halyards—a purpose now served largely by plaited polyester. Other uses are parachute shroud lines and shot lines for line-throwing guns.

Stuffer-braided lines are manufactured in a similar manner except that the braid is formed around a highly twisted yarn core, which rounds out and hardens the line. This type of construction in cotton is used for sash cord (heaving lines).

Solid-braided lines are fashioned in various ways. One familiar solid-braided line is the one used for lead lines, taffrail log lines, and the like. This braid is of large yarns, either single or plied, tightly braided to form a hard, relatively stiff line that will not kink, snag, or swell in water.

Double-braided line is, essentially, two hollow-braided ropes, one inside the other. The core is made of large single yarns in a slack, limp braid. The cover also is made of large single yarns but in a tight braid that compresses and holds the core. This line is manufactured only from synthetics, and 50 percent of its strength is in the core. Double-braided line is used for mooring ships, towlines, and many other purposes.

Plaited line is made of eight strands—four right-twisted and four left-twisted. These strands are paired and worked like a four-strand braid (fig. 4-2). Thus two pairs of right-laid strands and two pairs of left-laid strands are formed into a line that is more or less square. Plaited line is used for towlines, ship mooring lines, messengers, and many other applications. Plaited line is available in nylon, polyester, and polypropylene.

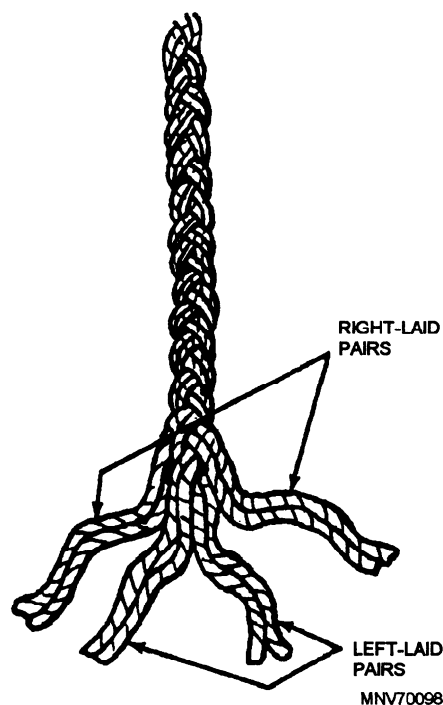

Figure 4-2.—Plaited line.

SIZE DESIGNATION

Line 1 3/4 inches or less in circumference is called *small stuff*. Its size is designated by the number of threads (or yarns) that make up each strand. You may find anywhere from 6 to 24 thread, but the most commonly used sizes are from 9 to 21 thread. See figure 4-3. Some small stuff is designated by name. One type is *marline*, a left-laid, two-strand, tarred hemp. Marline is mainly used for seizings. When you need something stronger than marline, use *housesline*, a left-laid, three-strand, tarred hemp. Rope yarns can be used for temporary whippings, seizings, and lashings. The yarns are pulled from strands of old line that has outlived its usefulness. Pull the yarn from the middle, away from the ends, or it will get fouled.

	* CIRCUMFERENCE		THREAD
	INCHES	MILLIMETERS	
	3/4	19.05	6
	1	25.40	9
	1 1/8	28.58	12
	1 1/4	31.76	15
	1 1/2	38.10	21
	1 3/4	44.45	24

MNV70099

Figure 4-3.—Small stuff.

Line larger than 1 3/4 inches is designated by its circumference, in inches. A 5-inch line, for example, is constructed of natural or synthetic fibers and measures 5 inches in circumference. In general, lines larger than 5 inches are called *hawses*, which are available in sizes up to 21 inches.

CARE AND HANDLING OF LINE

It is not news to experienced Seamen that misuse and abuse of their gear shortens its life. Yet, because of carelessness and lack of knowledge, line is the one item that receives more abuse than any other equipment the Seaman uses. Also, line in a doubtful condition puts more lives in jeopardy than any other gear. Therefore, you should learn and exercise the proper care and methods of handling line.

NATURAL-FIBER LINES

Coils of line should always be stowed on shelves or platforms clear of the deck. They should never be covered with an accumulation of junk that may prevent the evaporation of moisture, because line composed of vegetable (natural) fiber is susceptible to mildew and rotting if it stays wet.

Coils of large line should be stowed with their proper side up for opening. Line from 2 to 4 inches, which will be needed in various lengths on deck, should be opened, and a few feet of the end led out. Mooring line should not be opened until it is needed.

Whenever possible, line that has become wet in use should be dried thoroughly before it is stowed. Sometimes this is impossible, as with mooring lines, which must be stowed before the ship clears port. If line must be stowed wet, it should be laid up on grating in long fakes or suspended in some way that will allow it to dry as quickly as possible. It should never be covered before it is dry.

Stretch and, usually, elongation occur when natural-fiber line under tension is wetted down. The line shrinks in diameter, adding more strain. When the line dries, it does not recover to its original size and shape. Thus its length is increased and its diameter and strength are decreased. New line, which still contains a large amount of its original waterproofing oil, does not shrink as much as old line, from which much of the oil has dissipated through exposure. Nevertheless, whatever the condition, taut lines, such as boat falls, must be slacked when it begins to rain or when spray begins to wet them.

Distortions, Kinks, and Twists

Most damage to a line occurs as the line is being hauled in under a strain. The initial load on the line is created as the line coils onto the winch. If a line does not lead fairly to a winch drum (90° to the drum axis), it will become badly distorted as it is heaved in. Notice in view 1 of figure 4-4 that the line from the load approaches the drum at an angle other than 90°. If a strain is put on the line in this situation, the line will become fouled on the drum and may be damaged. To keep the line from fouling and becoming damaged, it must be changed as shown in view 2 of figure 4-4. This involves putting turns of line inside (toward the base of the drum) of the part from the load so the line feeds onto the drum at a 90° angle. Because the outside end is attached to the load and is unavailable, enough slack must be hauled up in the hauling part to make the necessary number of turns. The turns should be started inboard, as shown in the figure.

Whenever possible, a right-laid line should be put on a winch drum or capstan right-handed or in clockwise turns. Heaving on a right-laid line with left-handed turns will eventually kink the line. About the only time left-handed turns cannot be avoided is when a winch is heaving on two lines at once, one on each drum.

A line with a kink in it or a cockle that is twisted from having a dip in it should never be heaved hard while that condition exists. A strong strain on a kinked or twisted line will put a permanent distortion in the

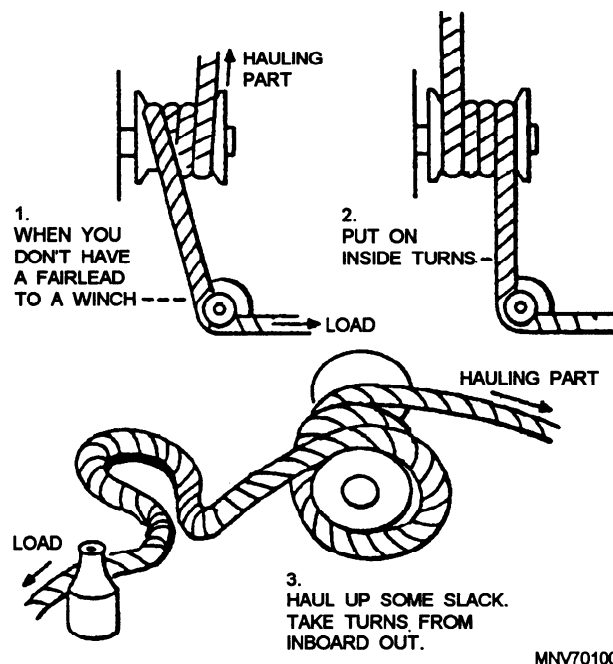

Figure 4-4.—Putting on inside turns to get a fair lead.

line. Figure 4-5 shows what frequently happens when a line with a kink in it is heaved on. The kink, which could have been worked out, is now permanent, and the line is ruined.

A condition similar to a kink is the cockle (or hockle), which actually is a kink in an inner yarn that forces the yarn to the surface. When a strain is applied to a twisted rope with the load free to rotate, the lay of the rope lengthens as the turn runs out of the rope. Actually, what happens is that the turn is transferred to the strands. When the twist in the strand builds to a point where it can take no more, the inside yarns pop through the outer ones. Cockles also can be formed in a line wound on a capstan or gypsy head in the direction that tends to unlay the line. You can correct a cockle by stretching the line and twisting the free end to restore the original lay.

Securing lines improperly can cause drastic reduction in strength. The strength of a line can be reduced by as much as 50 percent for knots and bends and 40 percent for hitches. Figure-eight bends on cleats and H bitts have the same effect. See figure 4-6 for the correct way to secure a line on H bitts. When lines are properly secured with round turns on H bitts, the line will retain 90 percent of its strength. When lines are used on double bitts, figure eights reduce the rope strength by only 25 percent.

Deterioration

In addition to being damaged by mechanical factors during service, natural-fiber lines also suffer the effects of aging under storage conditions. Natural-fiber lines basically consist of cellulose and have the same aging properties as paper. That is, they turn yellow or brown and become brittle with time, even under the best storage conditions. The color change indicates that the line has lost breaking strength (BS). The loss usually amounts to 1 to 2 percent per year of storage.

However, BS is not a true index of the line's utility. More important is the loss of bending strength, indicated by the fibers' becoming brittle and stiff. Bending strength decreases five times as rapidly as BS. Deterioration of bending strength causes the fibers to rupture easily when bent over sheaves or other holding devices. Once deterioration begins, the line breaks down with each successive bend, even under light



MNV70101

Figure 4-5.—Result of a strong strain on a line with a kink in it.

loading conditions. Because of this, it is important that the age of unused lines be determined from the manufacturer's identification marker tape within the line strand. The marker tape will tell you who made the line, the date the line was made, and the fiber type.

WARNING

If natural-fiber line's age exceeds 5 years, do not use the line for critical operations or operations involving the lives of personnel. Natural-fiber ropes more than 5 years old (even though unused) may only be used for lashing, fenders, or matting.

Natural-fiber ropes more than 5 years old (even though unused) may only be used for lashing, fenders, or matting.

It is a good idea to maintain a rigging log to help you determine when to remove natural-fiber lines from service and replace them with serviceable lines. Unless you maintain a log, you may have to cut a line open to determine its age.

The following are some pointers on the use and care of natural-fiber and synthetic line. Remember them.

- Coil right-laid line right-handed, or clockwise.
- Keep line from touching stays, guys, and other standing rigging.
- When you surge line around bitts or capstans, take off enough turns so the line will not jerk, but will surge smoothly.
- If line becomes chafed or damaged, cut out the damage and splice the line. A good splice is safer than a damaged section.
- Do not lubricate line.
- Whip all line ends.

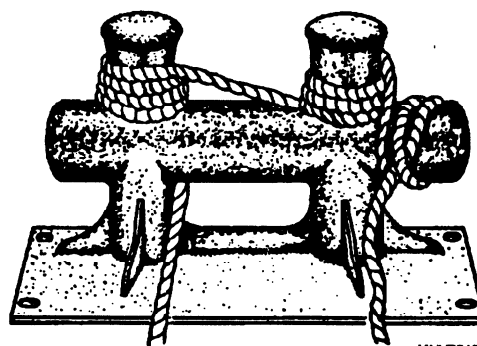

MNV70102

Figure 4-6.—Securing lines to H bitts.

- Inspect line frequently for deterioration. Open the lay and inspect the fibers. White powdery residue indicates internal wear.
- Do not drag a line over sharp or rough objects; doing so can cut or break the outer fibers. When line is dragged on the ground, dirt and other particles are picked up and eventually work into the line, cutting the inner strands.
- The strength of line exposed to the atmosphere deteriorates about 30 percent in 2 years from weathering alone.
- Line loaded in excess of 75 percent of its breaking strength will be damaged permanently. Inspect the inside threads to see if all or a portion of the fibers in the threads are broken.
- Keep bitts, chocks, and cleats in smooth condition to minimize abrasion.
- Use chafing gear on rough, hard surfaces and sharp metal edges.
- Apply loads slowly and carefully.

SYNTHETIC-FIBER LINES

The synthetic fibers currently in use for making line are (in descending order of strength) nylon, aramid, polyester (Dacron®), polypropylene, and polyethylene.

The characteristics of synthetic line differ from those of manila line. This causes the safety precautions for synthetic-fiber line to be more exacting than those for manila line. A complete list of precautions is given

in chapter 613 of the *Naval Ships' Technical Manual (NSTM)*, but the more important precautions you should observe are as follows:

- Because of the lower coefficient of friction of synthetic-fiber line, you must exercise extreme care when you pay a line out or ease it from securing devices (bitts, capstans, cleats, gypsy heads, etc.). For control in easing out, take no more than two round turns on cleats or bitts. For checking a line under strain, take two round turns followed by no more than two figure-eight bends. Any more than this will present a danger to personnel and cause difficulty in handling the line.
- To minimize the hazard of pulling a line handler into a securing device when a line suddenly surges, have safety observers ensure that all the line handlers stand as far as possible from the device, with a minimum distance of at least 6 feet from the securing device being tended or worked. Note that this is particularly critical in mooring operations.
- Since a snap-back action inevitably occurs when a line parts under tension, never allow personnel to stand in the direct-line-of-pull of the line when it is being pulled or when it is under tension. A synthetic line parting under tension will snap back at near the speed of sound, and there will be no time to clear the area. Where possible, position line handlers a minimum of 90° from the direction of the tension force (fig. 4-7).

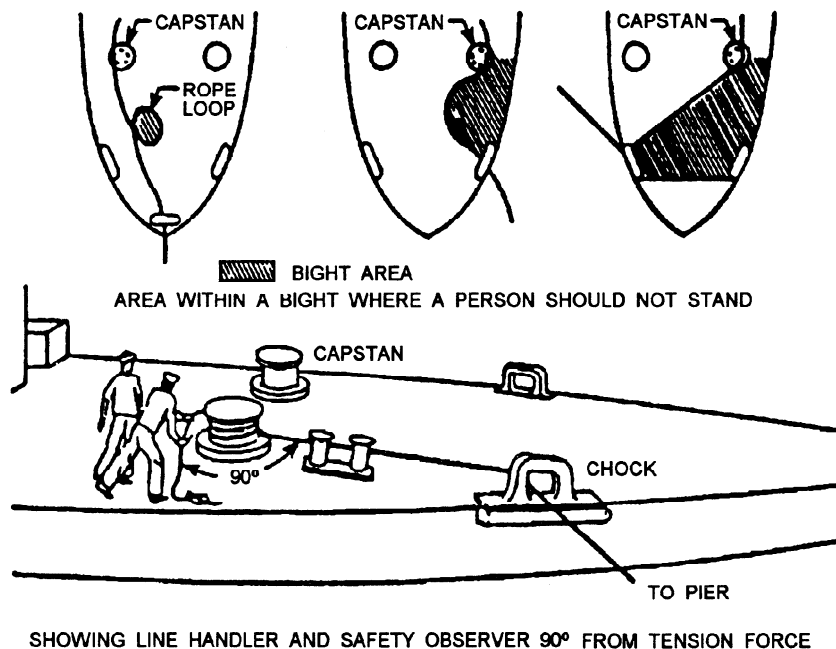

Figure 4-7.—Safe working area.

MNV70103

Table 4-1.—Synthetic-fiber-line Constructions and Characteristics

Rope Construction	Breaking Strength	Abrasion Resistance	Stretch	Cost	Rotation Under Load
Three Strand	Medium	Good	Highest	LOW	Yes
Double Braided	High	Good	LOW	High	No
Plaited	Medium	Good	High	Medium	No

- Before you begin an operation using synthetic line, determine the capacity of all the gear and fittings used with the line, such as blocks, pad eyes, shackles, and line couplings, to ensure that their strength exceeds the minimum breaking strength of the rope. Synthetic lines have higher breaking strengths than equal sizes of manila line. Since many of the fittings used in the fleet were designed for natural-fiber line, they may fail if used improperly with synthetic line. Where the substitution of synthetic-fiber line for manila line is authorized, *NSTM*, chapter 613, provides the appropriate guidance for the substitution.
- Synthetic line has poor knot-holding characteristics. Some knots that offer good characteristics for securing manila line, such as the square knot, are not adequate for belaying or securing synthetic line. The bowline is one knot known to offer reasonable security when you are bending together or securing synthetic line.

Regardless of the line fiber material, you must heed the following safety rules whenever you handle line:

- Never stand in the bight of a line or in the direct-line-of-pull when the line is being pulled or under tension. See figure 4-7 for examples of danger areas.

- Never continue to increase the load on a line after the rigs have been two-blocked or tightened. Many injuries and fatalities have occurred when operators have not observed this rule.
- Be sure that a safety observer is posted in every case where lines are being worked.

Line Characteristics

Lines are classified by both their construction and their material. The most common line constructions currently used in the Navy are three-strand, double-braided, and plaited. The most common properties of the three constructions are shown in table 4-1. The most common properties of the three materials are shown in table 4-2. You can use the information in these tables to determine the construction and material needed for a particular application.

If, for example, a line must be able to withstand abrasion (abrasion being the condition a line is subjected to in a chock or around a capstan head), the best choice is a three-strand nylon line. Notice that one of the characteristics listed in the tables is stretch. Stretch is a misunderstood characteristic in synthetic line. In some applications of line, excessive stretch is a disadvantage. In other applications, stretch is an advantage. When a line is subjected to impact loading, as it is in towing, the more stretch the line has, the better it can absorb impact.

Table 4-2.—Synthetic-fiber-line Materials and Characteristics

Rope Material	Breaking Strength	Abrasion Resistance	Stretch	Cost	Resistance to Sunlight
Nylon	High	Good	High	High	Good
Polypropylene	Low	Fair	Medium	LOW	Medium
Polyester (Dacron)	Medium	Best	Least	High	Good

Although line stretching can be beneficial to a job, it can also be detrimental to the line, when overdone. The amount a line stretches is directly related to the load placed on the line. As long as the load is within the line's safe working load (SWL), the line will be safe to use. To ensure the longest life, use a line within its SWL. The SWL of line ranges from one-sixth to one-tenth of the minimum breaking strength (BS) of new line, allowing for the type of application, the weather, and the blocks and other gear being used with the line.

If a line is loaded beyond its SWL, it may reach a critical point, which is near the BS of the line. A line may repeatedly be brought to its SWL without impairing the line or reducing its useful life. From the standpoints of safety and economics, it makes sense to take precautions not to surpass the SWL of a line. A simple device that will keep you from exceeding a line's SWL is a *tattletale cord*. A tattletale cord is a bight of six-thread manila hanging from two measured points on the working line. The line, when tensioned to its stretch limit, will stretch to a certain percentage of its elastic length. When this point is reached, the tattletale cord becomes taut, warning that there is danger of exceeding the stretch limit of the line. Figure 4-8 shows a tattletale cord on a three-strand nylon line. Table 4-3 shows standard lengths of tattletale cords and the distances between suspension points for various lines. Use tattletale cords and every other guide available to you to ensure that you do not ignore the SWLs.

Concerning the BS of line, the current practice in the Navy is to use the minimum BS. Minimum BS is defined as the lowest BS encountered in all of the test samples broken. Line manufacturers usually publish average BSs, which may be 10 to 25 percent higher than the minimum BSs. The actual BS of a line can be anywhere from the minimum BS to 35 percent higher.

Table 4-3.—Dimensions for Tattletale Cords

Type of Synthetic Rope	Length of Tattletale (Inches)	Distance Between Marks (Inches)
Nylon Three-Strand	35 1/2	30
Nylon Plaited	43 1/2	40
Nylon Double-Braid	43 1/2	40
Polyester Three-Strand	63 1/2	60
Polyester Plaited	62 1/2	60
Polyester Double-Braid	62	60

Normally, synthetic-fiber line is furnished on reels and is unreeled in the same fashion as wire rope. (We discuss wire rope in detail later in this chapter.) If you receive a synthetic line made up in a coil, do not open the coil and pull the end up through the tunnel as with natural-fiber lines. Set the coil on a turntable and pull on the outside end while somebody rotates the turntable. Should a coil collapse and the line kink and tangle, do not try to untangle it by pulling on the line. Secure one end and drop the remainder of the coil into the sea. In the water, the line will relax and gradually uncoil without forming permanent kinks or cockles. (DO NOT TRY THIS WHILE THE SHIP IS UNDER WAY.) This water treatment also removes bulges in new, soft-laid line and hardens the line structure.

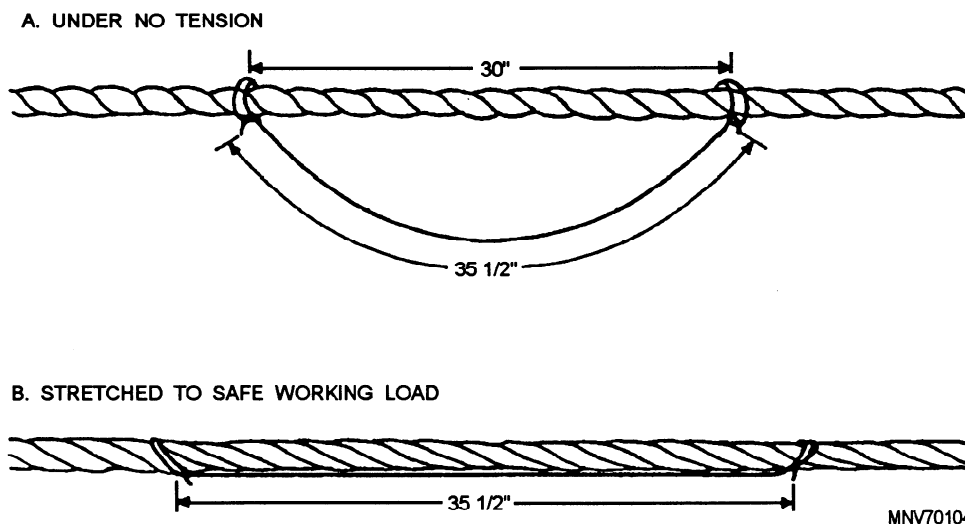

Figure 4-8.—Tattletale cord on a twisted nylon line.

Before you use a new three-strand synthetic-fiber line, fake (coil) it down on deck and allow it to relax for 24 hours. The shorter the line, the less time the relaxing process takes; for example, a length of less than 50 feet will relax in 1 hour.

When wet, synthetic line shrinks slightly and may swell slightly. When the line is tensioned, the water squeezes out; under working loads, it appears as vapor. Because line under tension develops friction, and thus heat, the water has a beneficial cooling effect. However, nylon loses 15 percent of its strength from water being absorbed by nylon molecules.

Nylon, aramid, and polyester lines exhibit almost no decrease in strength due to sunlight, but polypropylene does. Polypropylene line may lose as much as 40 percent of its strength in 3 months when exposed to tropical sunlight if the line is made without ultraviolet inhibitors. Ultraviolet inhibitors can be added to the line at the time of manufacture to reduce the effects of sunlight. White polypropylene line has almost no inhibitors added, while black polypropylene has the most inhibitors added. However, just because a polypropylene is black does not mean that it has had ultraviolet inhibitors added. If a polypropylene line has had ultraviolet inhibitors added, it should meet military specification MIL-R-24049. Line obtained through the Naval Supply System (stock system), meets the proper specifications.

Oil and grease do not cause synthetics to deteriorate, but they may make them slippery. When this happens, the line should be scrubbed down.

Table 4-4.—CID-A-A-50435 Aramid Rope Characteristics

CIRCUMFERENCE (INCHES)	BREAKING STRENGTH (POUNDS)
3 3/8	50,000
3 1/2	60,000
3 3/4	70,000
4 1/8	96,000
4 3/4	135,000
5 3/8	180,000
5 7/8	225,000
6 1/4	280,000
7 5/8	350,000
8 3/16	420,000

Four-Strand Aramid Line

Four-strand aramid lines are designed to fail sequentially, meaning that one of the four strands will fail before the other strands. This line has been proven to work better than a three-strand mooring line, and less line handlers are required due to the smaller size of line required to moor a ship. Table 4-4 shows the characteristics of aramid rope.

Aramid line is being phased into the Navy as a substitute for three-strand nylon; table 4-5 compares equivalent sizes of lines, from three-strand nylon to polyester double-braided line.

Table 4-5.—Aramid Rope Substitution

ARAMID 4-STRAND CID-A-A-50435	NYLON 3-STRAND MIL-R-17343	NYLON PLAITED MIL-R-24377	NYLON DOUBLE- BRAIDED MIL-R-24050	POLYESTER DOUBLE- BRAIDED MIL-R-24677
3 3/8	4 1/2	4	4	4
3 1/2	5	4 1/2	4 1/2	4 1/2
3 3/4	5 1/2	5	5	5
4 1/8	6	6	5 1/2	6
4 3/4	7	7 1/2	7	7
5 3/8	8	9	8	8
5 7/8	9	10	9	9
6 1/4	10	11	10	10

The following is an inspection guideline. Rope technology has not yet advanced to the point where a rope can be inspected visually to determine the exact

extent of damage. Therefore, you must use sound judgement to determine the serviceability of a given section of rope.

CHARACTERISTICS	RESPLICE (IF LOCALIZED)	REPLACE
1. Rope suspected of being shock loaded.		X
2. Rope has exceeded 75 percent of its minimum breaking strength.		X
3. Bulk of surface yarns or strands reduced by approximately 50 percent for a linear distance equal to four times the rope's circumference.	X	X
4. Three or more adjacent cut yarns in the strands of ropes 5 inches or less in circumference.	X	X
5. Four or more adjacent cut yarns in the strands of ropes 5 inches or more in circumference.	X	X
6. Stretch out: Circumference reduced by 5 percent from circumference when new.		X
7. Chockling	X	
8. Oil and grease	Wash in mild detergent	
9. Heavy surface fuzz progressive.	X Remove source of abrasion	X
10. Burns or melting visible for a length of over four times the rope circumference.	X	X
11. Rust on nylon.	X (or clean)	
12. More than four adjacent pulled cover strands (which cannot be reincorporated into cover braid).	X	X
13. Core visible through cover because of cover damage(except single braids).	X	X
14. Core damage - pulled, cut, abraded, or melted strands.		X
FOR THREE-STRAND AND EIGHT-STRAND PLAITED ROPES		
15. Damage in valley between strands.	X	X
16. Powdering between adjacent strand contact surfaces.	X	X
WHEN IN DOUBT REMOVE FROM SERVICE!		

Table 4-6.—Rope Elongation

TYPE	APPROXIMATE ELONGATION AT BREAK (PERCENT)		
	NYLON	POLYESTER	ARAMID
Three-strand	55	35	—
Double-braided	30	30	—
Plaited	65	45	—
Four-strand	—	—	6

Nylon rope, on parting, is stretched nearly one-half of its original length. This length is recovered instantaneously on parting, causing snap back with hazardous force. In view of this danger, it is imperative that no one stand in direct line of the pull when a heavy load is applied to the line. Polyester rope is stretched nearly one-third of its original length and is as dangerous as aramid rope, which stretches six percent. Table 4-6 shows the approximate elongation of nylon, polyester, and aramid ropes at break. These elongation percentages were taken from the mil specs and commercial item descriptions for the ropes.

SPLICING LINE

The ends of line may be joined permanently by a long splice or by a short splice. Whether a long or a short splice is used depends on how the line is to be used. The short splice is described in the NSTM, Chapter 613 and will not be repeated here. In this manual, we will discuss only the long splice.

LONG SPLICE

A long splice does not change the diameter of a rope materially; therefore, it is used to join two ropes when the rope will run over sheaves in a block. To make a long splice, take the following steps:

1. Unlay the end of each rope 15 turns.
2. Place the ends together, as shown in view A of figure 4-9, and seize five of the strands together.
3. Unlay the loose strand ten more times.
4. Lay the opposite strand from the other rope in the groove left by inlaying the first strand (view B).
5. Tie an overhand knot, as shown in view C.

6. Cut out the seizing and unlay a strand in the opposite direction.

7. Repeat steps 4 and 5.

8. Tie an overhand knot in the two remaining strands.

9. Take a tuck with each strand or split each strand and make tucks in opposite directions with the halves.

View D shows the completed long splice.

ALONGSIDE MOORING

Mooring alongside a pier and getting under way from a pier are basic, yet extremely critical, functions performed by the deck department. Mooring a ship safely takes preparation, training, and the teamwork of all hands. A sound working knowledge of capstans, gypsy heads, deck and pier fittings, and the proper use of mooring lines is a must.

MOORING LINES

Ships are moored to piers, wharfs, and quay walls, and nested with other ships by mooring lines, which vary in size depending on the type of ship. For instance,

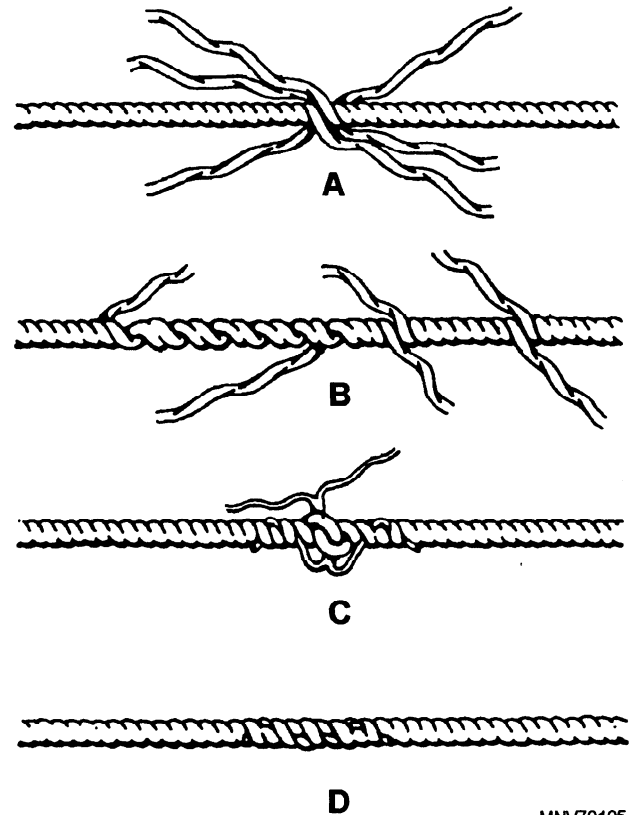

MNV70105

Figure 4-9.—Long splice in fiber line.

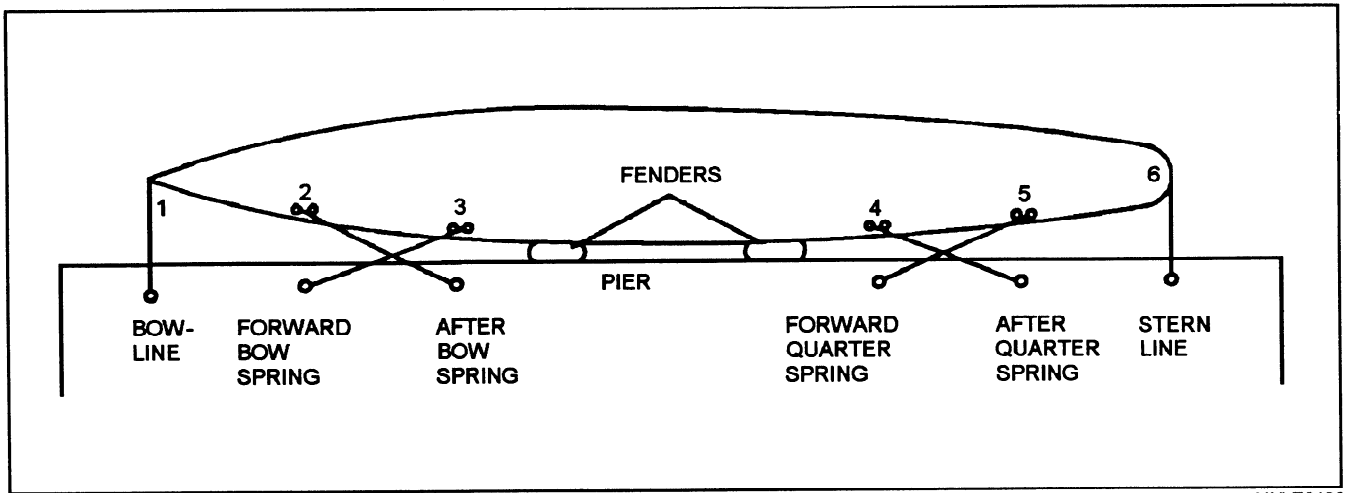

MNV70106

Figure 4-10.—Mooring lines of a ship.

a destroyer uses a 5-inch synthetic line, while a carrier uses an 8-inch synthetic line. In general, mooring lines must satisfy two requirements. First, they must be as light as possible for ease in handling; and second, they must be strong enough to take the strain of mooring, getting underway, and holding the ship in heavy weather.

Mooring lines are named, according to their use, as bowlines, stem lines, breast lines, or spring lines. The bowline runs through the bullnose or chock nearest the eyes of the ship and holds the bow in. The stern line runs through the stem chock or quarter chock, holding the stem in. A breast line is led nearly straight across to the pier, controlling the distance of the ship from the pier. Breast lines are called bow, waist, or quarter breasts. A spring line leads at an angle of about 45 degrees from the ship to the pier and controls fore-and-aft movement.

Spring lines leading forward are the forward bow spring or the forward quarter spring. These lines keep the ship from going aft. Spring lines tending aft are the after bow spring or the after quarter spring. Their purpose is to keep the ship from moving forward.

The standard moor on most ships is six mooring lines. These lines are numbered from forward to aft and are called by number in line-handling evolutions because numbers are shorter and more precise than names. See figure 4-10. A ship may use fewer or more lines as necessary, in which case the numbers are changed accordingly. When the ship is in position and secure, the mooring lines are doubled up, which means that a bight of line is passed to the pier or to another ship, giving three parts of line. The bight is evened up with the single part of line so that each of the three parts is taking an equal strain. See figure 4-11.

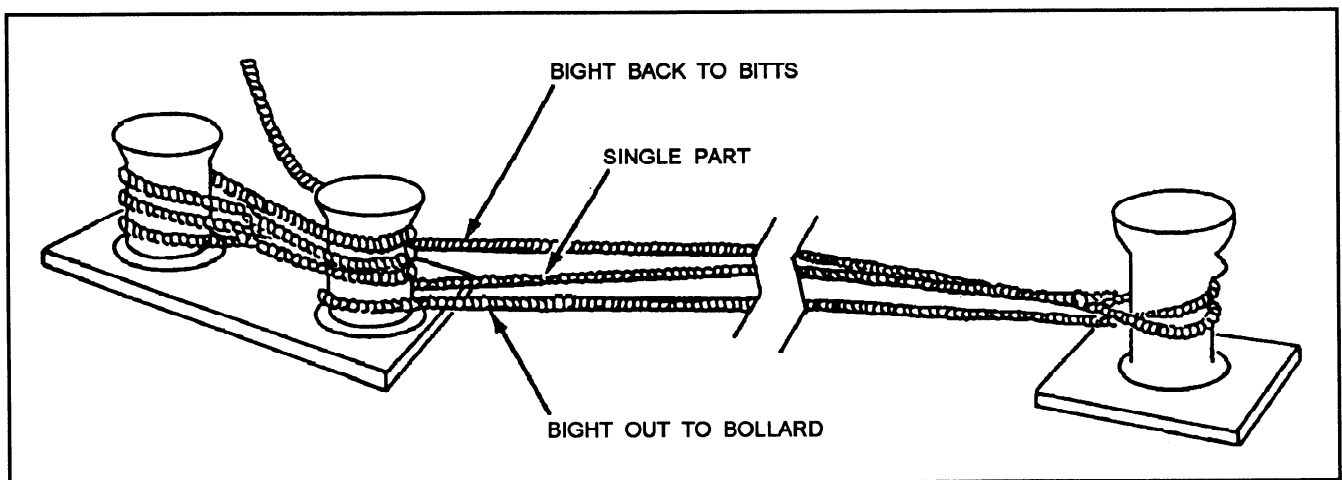

MNV70107

Figure 4-11.—Correct method of doubling up.

Preparing to Moor

Well in advance of mooring, the lines are broken out and faked down, each near the chock through which it will pass (fig. 4-12). An eye is passed through the chock

and laid back over the lifeline. During this breakout phase, all the lines should be checked for abrasion, wear, breaks, or decomposition. The tattletale cord spliced into the synthetic lines must be checked.

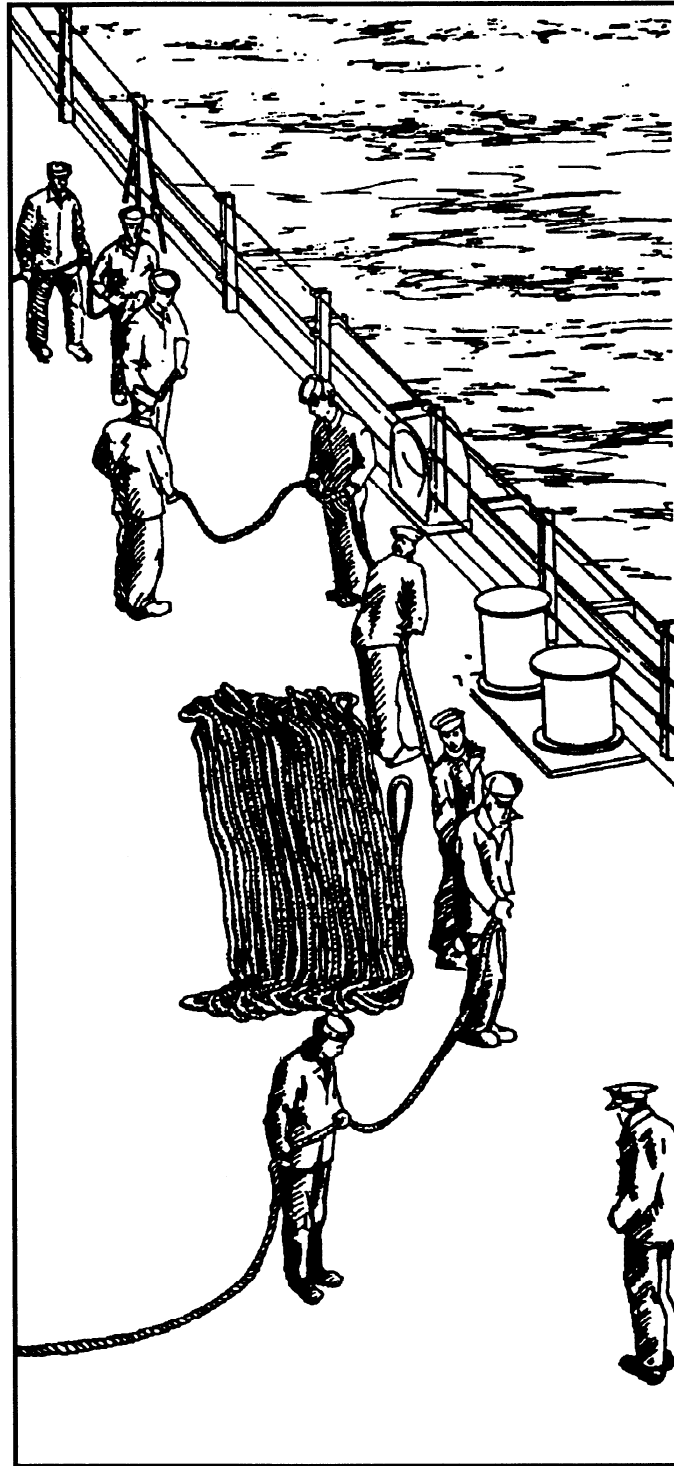

MNV70108

Figure 4-12.—Preparing to moor.

CAUTION

No synthetic line, other than four-strand aramid line, may be used as a mooring line without having a tattletale cord attached. The tattletale cord shows line handlers when the line is stretching toward its safe working load and to the danger point. Since four-strand aramid fiber rope stretches only 6 percent at minimum breaking strength, tattletale cords cannot be used to determine the strain on these mooring lines. Do not use a tattletale with natural-fiber rope.

Mooring Line Delivery Lines

Since mooring lines are usually too heavy to heave properly, lighter weight lines are thrown from the ship to the pier and used as delivery lines to pull the mooring lines from the ship to the pier. These lines include heaving lines, bolos, and line-throwing gun lines. The speed with which the lines are sent to the pier is often critical, especially in strong winds or currents.

HEAVING LINES.—A heaving line is basically a line that is thrown by hand from the ship to the pier. It is important to have more than one heaving line on station. A second heaving line should be made up and kept ready to throw in case the first throw fails. Once the heaving line is successfully cast to the pier, it can be bent to the mooring line needed first. All mooring lines larger than 5 inches must have messengers of 1 1/2 inches in circumference, and 12 to 18 inches long attached to them so that the heaving line does not part during delivery to the pier.

BOLO.—In addition to the heaving lines, it is useful to have bolo lines ready, both fore and aft. A bolo consists of a padded weight attached to the end of a nylon shot line. An experienced, skillful sailor can throw a bolo twice the distance of a heaving line, and because of its size and weight, a bolo is more effective in the wind. However, a bolo can be *very dangerous*, especially when large numbers of people are on the pier. With its size and speed of delivery, a bolo could seriously injure someone who happened to be in its way. For this reason, its use is discouraged and sometimes prohibited by some commanding officers.

LINE-THROWING GUN LINE.—A third delivery line, also posing danger to those on the pier, is

the line-throwing gun line. In mooring, it is used when the heaving line or bolo will obviously not be effective.

CAUTION

The line-throwing gun may not be loaded until it is actually needed. When the gun is loaded, it must be pointed outboard, barrel up.

DECK MACHINERY

When the sea detail is set and the line-handling stations are manned, it is important to test the capstans and gypsy heads. The anchors will also be made ready to let go. This is done for emergencies on approach, or an anchor can be used as a poor-man's tug when laid underfoot in a mooring evolution. Anchors and anchoring are covered in chapter 7 of this manual. Once the capstans and gypsy heads are satisfactorily tested, the mooring lines may be fairled to power if desired.

FENDERS

The main purpose of fenders is to protect the ship from contact with the pier or another ship.

The most common ship fender is a pneumatic fender made of rubber, about 4 feet long and 3 feet in diameter. It should be positioned amidships at the extreme beam. This fender is normally the only one the ship rides against when it is

alongside of another ship. A number of additional fenders, depending on the size and type of ship, are kept ready on the forecastle and on the fantail. These are normally smaller pneumatic fenders or homemade manila fenders about 4 feet long and 1 foot in diameter.

COMMANDS TO LINE HANDLERS

Commands to a ship's line handlers originate on the bridge. These commands must mean the same thing to the line handlers as they do to the originators on the bridge. Further, the commands must be carried out immediately. Therefore, the more common commands have been standardized. The following examples and definitions are in common use and form the basis for orders to line handlers:

STAND BY YOUR LINES	Man the lines and stand ready to work.
PASS ONE	Pass line number one to the pier; place the eye over the appropriate bollard but take no strain.
TAKE A STRAIN ON ONE	Put line number one under tension.
SLACK ONE	Take all tension off of line number one and let it hang slack but not in the water.
EASE ONE	Let number one line out until it is under less tension but not slacked
TAKE NUMBER TWO TO THE CAPSTAN	Lead the end of line number two to the capstan; take the slack out of the line but take no strain.
HEAVE AROUND ON TWO	Apply tension on number two line by hauling on it with the capstan.
AVAST HEAVING	Stop the capstan, or stop heaving around.
HOLD FIVE	Do not allow any more line to go out on number five even though the risk of parting the line may exist.
CHECK FIVE	Hold number five line but not to the breaking point; allow only enough line to render around the deck fitting to prevent it from parting.
SURGE FIVE	Hold moderate tension on number five line but allow it to slip enough to permit movement of the ship (used when moving along the pier to adjust position).
DOUBLE UP	Pass an additional bight on all mooring lines, or line indicated, so that there are three parts of each line to the pier. To ensure that the three parts take an equal strain, pass a stopper on the standing part and take a round turn on the barrel of the bitts closest to the chock. Next pass a bight of the line to the pier, then take the standing part to power, remove the stopper and take the slack out of the line (equalizing all three parts). Once this is done, pass the stopper and fairlead the standing part to the second barrel and figure-eight the line over both barrels to secure it.
SINGLE UP	Take in all bights and extra lines so there remains only a single part of each of the normal mooring lines.
TAKE IN ALL LINES	Used when secured with your own lines, it means to have the ends of all lines cast off from the pier and brought aboard.
TAKE IN ONE (OR NUMBER ONE)	When used by the Boatswain's Mate in charge on the forecastle, it is preceded by the commands slack one and cast off one, which mean merely to retrieve line number one and bring it back on deck.
CAST OFF ALL LINES	When secured with your own lines, it is a command to those tending the mooring lines on the pier or on another ship to disengage or throw off the lines from the bollards or cleats. When secured with another ship's lines in a nest, it means to cast off the ends of her lines and allow the other ship to retrieve her lines.
TAKE IN THE SLACK ON THREE (OR NUMBER THREE)	Heave in on number three line but do not take a strain.

Often, the ship must move up the pier or wharf in short steps; in this case, the command “Shift lines on the dock forward (or aft)” or “Walk number one forward (or aft)” is given. Supplementary information about the distance of the move is also sent down from the bridge. Caution must be used in this movement, since control of the ship’s position is still being exercised by the use of the mooring lines, and the ship’s propulsion or tugs will be used to make the move.

If the ship’s auxiliary deck machinery should be used to haul in on a line, the command “Take one (number one) to the capstan” is given. This may be followed by “Heave around on one (number one)” and then, “Avast heaving on one (number one)”.

DIPPING THE EYE

If two mooring lines are placed over the same bollard, the second one should be led up through the eye of the first, then placed over the bollard. This procedure makes it possible for either line to be cast off without disturbing the other.

FRAPPING LINES AND RAT GUARDS

When a ship is pierside or inboard in a nest, she will normally frap her lines. This is done by wrapping the mooring line snugly with small stuff, marrying the three parts of the mooring line together.

When the frapping is complete, the rat guards are placed on the lines. Canvas chafing gear must first be lashed to the mooring line to protect it from the metal rat guard. Rat guards are circular metal disks, lashed together on a mooring line with the concave side to the pier. Rat guards should not be used when the ship is moored outboard in a nest; however, lines that are run to the pier must have them installed.

LINE-HANDLING SAFETY PRECAUTIONS

Whenever you handle lines, observe the following safety precautions:

- Tend the lines well behind the bitts in case the line surges or parts.
- Do not stand in the direct line of pull of a working line. Under no circumstances stand in the bight of a line.
- Do not even try to check a line that is running out rapidly by stepping on it.

- When you handle lines, fake down the standing part to prevent fouling.
- Remember that nylon, polyester, and other synthetic lines are characterized by high elasticity and low friction. The following rules apply:
 - a. Add an extra turn when you are securing a line to a bitt, cleat, capstan, or other holding device.
 - b. When you ease synthetic line out from holding devices, use extreme caution because of the high elasticity, rapid recovery, and low friction.
 - c. Remember, three strand nylon line, on parting, is stretched to about 1 1/2 times its original length and snaps back at near the speed of sound.
 - d. Know your gear and its capabilities; train deck personnel; quiz line handlers on their duties and on safety on station.
 - e. Make sure all the hands involved are safety briefed before and critiqued after an evolution.
 - f. Never use synthetic mooring lines without a tattletale cord.

KNOTS, BENDS, AND HITCHES

Among Seamen, the landsman’s all-inclusive term *knot* must give way to *knot* in its more specific meaning and to the terms *bends* and *hitches*. Seamen, in addition, must know which knot, bend, or hitch will serve best in a particular circumstance.

KNOTS AND BENDS

A knot, according to a Seaman’s use of the term, is usually a line bent to itself. The knot forms an eye or a knob or secures a cord or line around something, such as a package.

A bend ordinarily is used to join two lines together.

Reeving Line Bend

Frequently it is necessary to bend together two lines that must reeve around a capstan or winch drum. The best knot for this purpose is the reeving line bend, as

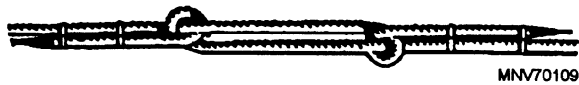

Figure 4-13.—Reeing line bend.

shown in figure 4-13. As you can see, it consists of taking a half hitch with the end of each line around the standing part of the other and seizing the bitter ends. Make sure the seizings are tight; otherwise, the knot will pull out.

Double Matthew Walker

The double Matthew Walker has many uses in fancy work, but it also has practical applications, such as keeping the end of a line from coming unlaed. This use should be considered only a temporary measure, because a proper whipping should be put on the line at the earliest opportunity and the knot cut off. Take a look at figure 4-14 before reading further.

To tie a double Matthew Walker, unlay 6 or 8 inches of line. Take the right strand, pass it around the other two and up through itself (view 1 of fig. 4-14). Next, pass the center strand around the third, under the first, and up through its own bight, as shown in view 2. Then pass the last strand around and under the other two, and up through its own bight (view 3). Tighten the knot by working out the slack and pulling tight. After tightening the knot, cut the ends off short or re-lay and whip them, as shown in view 4.

Fisherman's Bend

The fisherman's bend is a knot used to bend a line to a becket or an eye. To tie it, simply take two turns

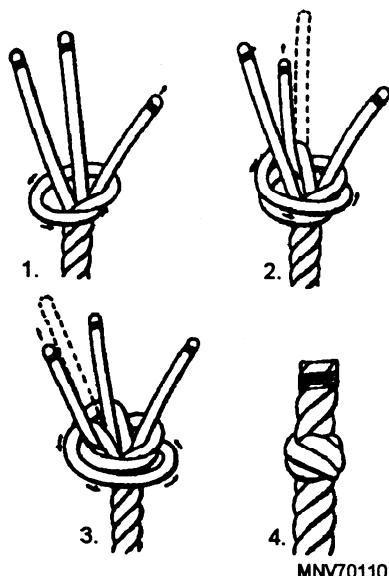

Figure 4-14.—Tying a double Matthew Walker.

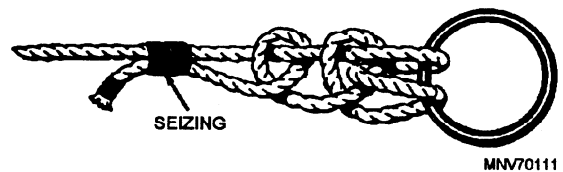

Figure 4-15.—Fisherman's bend.

through the eye. Tie a half hitch through the turns and another half hitch around the standing part (fig. 4-15).

Single Bowline on a Bight

The single bowline on a bight comes in handy whenever you need an eye in the center of a line. It can be tied quickly, does not jam tightly, and you do not need an end of the line to tie it. To get your securing lines taut, use a single bowline on a bight for securing equipment or cargo.

Tie the knot well up on the standing part and run the bitter end around a stanchion or through a pad eye and back through the eye of the knot. Heave back on the bitter end in a line between the knot and stanchion or pad eye. This gives the same effect as having a block on the line at the knot and, discounting friction, doubles your pull. Heave it taut and secure the end. To tie this knot, form bights A and B, as shown in view 1 of figure 4-16. Next, lay part C between bights A and B, as shown in the second view. Then reach through bight A, over part C, and pull bight B back through A. Tighten by pulling on part D and bight B. (The completed knot is shown in view 3.)

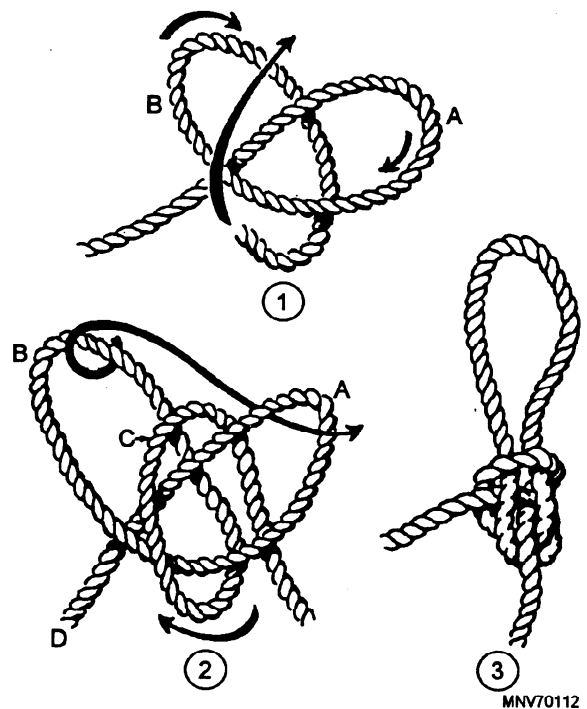

Figure 4-16.—Single bowline on a bight.

Spanish Bowline

The Spanish bowline can be used whenever it is desirable to have two eyes in the line. Its primary use, however, is as a substitute for the boatswain's chair. Many prefer it to the French bowline because the bights are set and will not slip back and forth when the weight is shifted.

To tie this knot, take a bight and bend it back away from you, as shown in view 1 of figure 4-17, forming two bights. Then lap one bight over the other, as shown in view 2. Next, grasp the two bights where they cross (point a in view 2), and fold this part down toward you, forming four bights, as shown in view 3. Next, pass bight c through bight e and bight d through bight f (view 4). See the complete knot in view 5.

A word of caution here: ALWAYS use manpower to hoist a person in a boatswain's chair (or any substitute). Otherwise, if the chair or a part of the knot

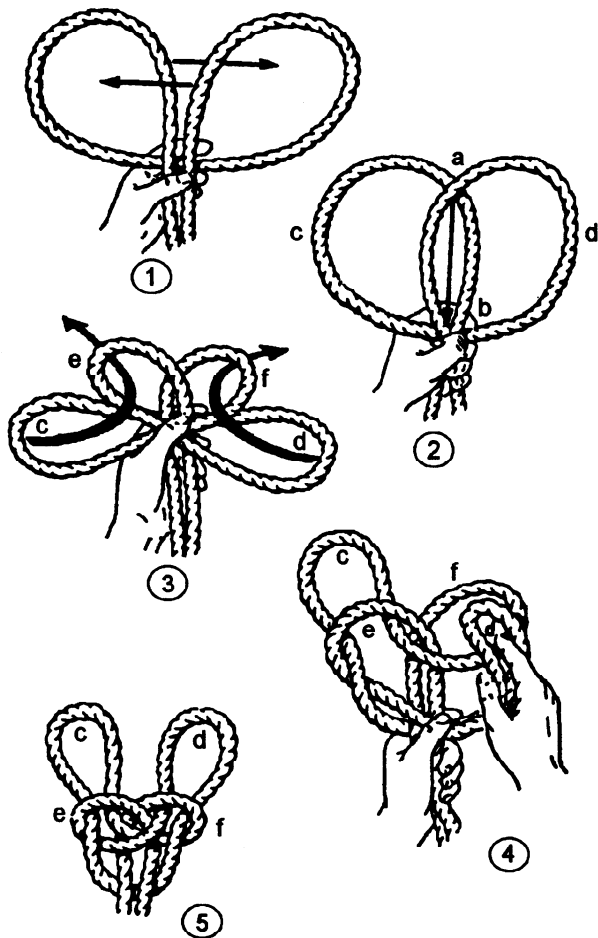

MNV70113

Figure 4-17.—Spanish bowline.

catches on a projection and the hoisting cannot be stopped in time, injury to the person seated is almost inevitable. Use enough personnel for the job, but no more.

Masthead Knot

The masthead knot is seen usually in fancy work, but it also has a practical purpose. In the days of sailing ships, masthead knots were set at the top of the masts, and the stays and shrouds were secured to the eyes of the knots. It is a good knot to remember if you ever have to rig a jury mast.

In tying the masthead knot, first lay up three underhand bights, the second on the first, and the third on the second, as shown in view A of figure 4-18. Then thread the inboard parts of the outboard bights under and over the parts of the other two bights, working each to the outside. Pull both bights tight. Work the slack into the knot to equalize the size of the three eyes (view B, fig. 4-18). Splice the two ends together and you have four eyes to which you can secure stays and shrouds.

Rolling Hitch

The rolling hitch is one of the most useful and most important hitches used on deck. It can be used for

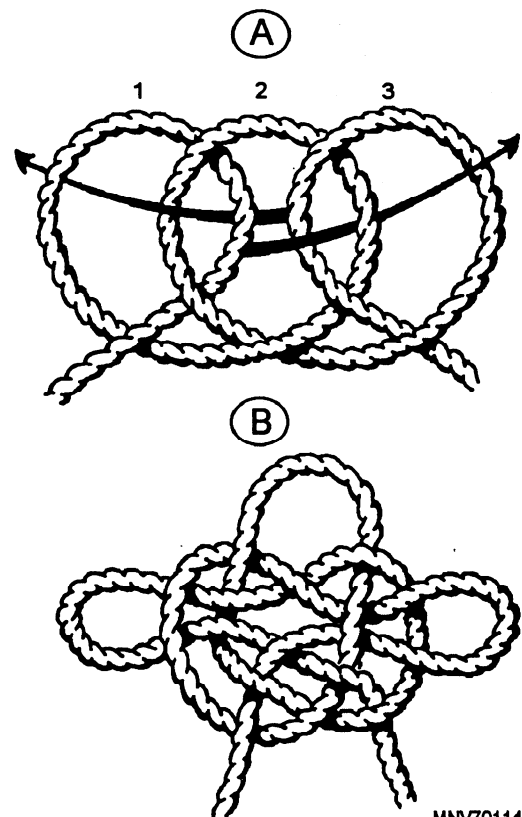

MNV70114

Figure 4-18.—Masthead knot.

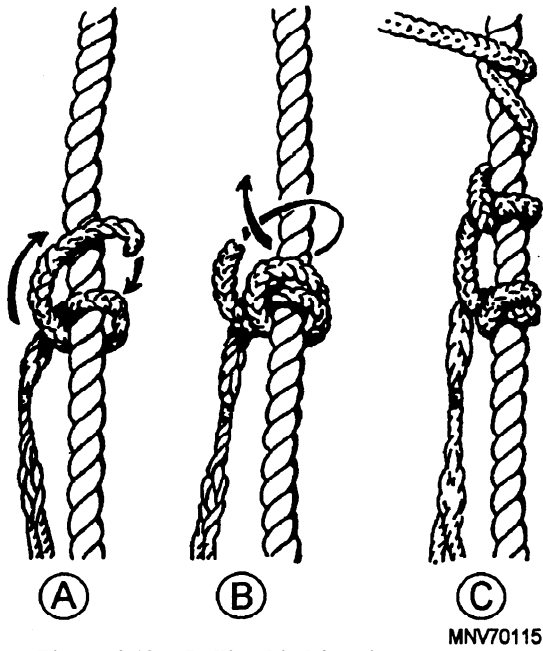

Figure 4-19.—Rolling hitch/passing a stopper. MNV70115

passing a stopper on a boat fall or mooring line when you are shifting the fall or line from the winch or capstan to a cleat or bitt. It also may be used to secure a taut line back on itself. If properly tied, it will hold as long as there is a strain on the hitch.

To tie a rolling hitch, take a half hitch around the line with the stopper, as shown in view A of figure 4-19. pull tight and take another turn. This turn must cross over the first (view A) and pass between the first turn and the stopper (view B). This completes the rolling hitch itself, but it must be stopped off in one of several ways.

One way is to take two or more turns with the lay of the line and then marry the stopper to the line by hand or seize the stopper to the line with marline. Another way is to tie a half hitch directly above the rolling hitch. A third way is to tie a half hitch about a foot above the rolling hitch (view C), then take a couple of turns against the lay, and marry or seize the stopper to the line.

Timber Hitch

The timber hitch is used on logs, spars, planks, or other comparatively rough-surfaced material. It should not be used on pipes or other metal.

Look at figure 4-20 to see how to tie a timber hitch. Take one or more half hitches around the timber to cant the timber if it must be hoisted through a small hatch or other small opening.

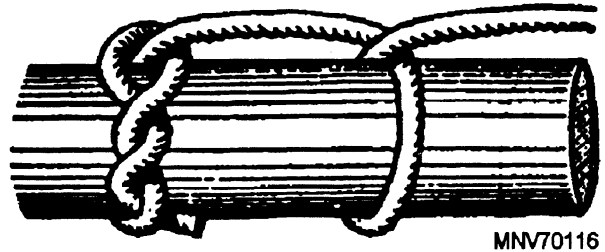

Figure 4-20.—Timber hitch and a half hitch. MNV70116

Marline Hitch

Another hitch that requires no detailed explanation is the marline hitch. (Just remember that the end of the line goes over the standing part and under the round turn so that it binds itself.) This hitch is used to secure on furling sails and to frap awnings and doubled-up mooring lines (fig. 4-21). When cinched up, it will hold itself tight.

Blackwall Hitch

The Blackwall hitch, single or double, is used to secure a rope to a hook. It can be made quickly and, when tied properly, is secure. Except when there is insufficient rope end remaining to make a bowline, it seldom is used.

To tie a Blackwall hitch, make an underhand loop, slip it up over the hook, pull it tight around the back of the hook, then slide it down onto the hook. In tying the double Blackwall hitch, pass the strap around the hook and eye in the whip, as shown in figure 4-22. Make sure the standing part binds the bitter end at the back of the hook and in the hook, as shown. Notice that the bight stays around the eye in the whip and is not slid down onto the hook.

Round Turn with Two Half Hitches

The combination of a round turn with two half hitches may be used in a ring, in a pad eye, or on a spar. It is particularly useful on a spar because it grips tightly and holds its position (fig. 4-23).

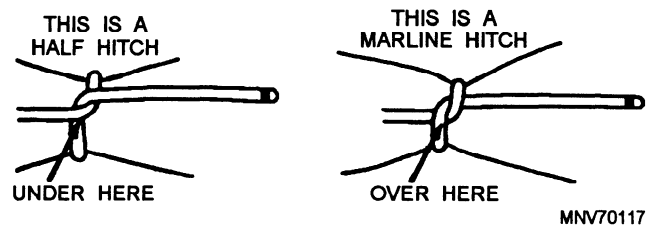

Figure 4-21.—Difference between a marline hitch and a half hitch. MNV70117

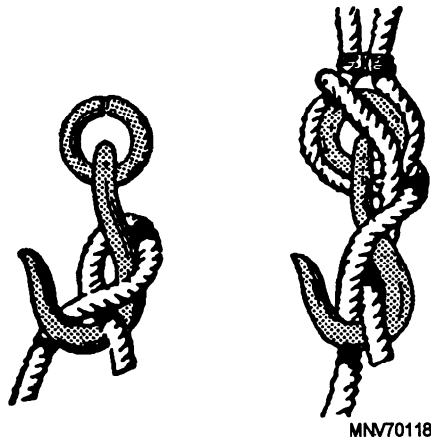

Figure 4-22.—Blackwall hitch, single and double.

Sheepshank

The sheepshank knot is generally thought of as merely a means to shorten a line, but in an emergency, it can also be used to take the load off a weak spot in the line.

To make a sheepshank, form two bights and then take a half hitch around each bight (fig. 4-24). If you are using the sheepshank to take the load off a weak spot, make sure the spot is in the part of the line indicated by the arrow.

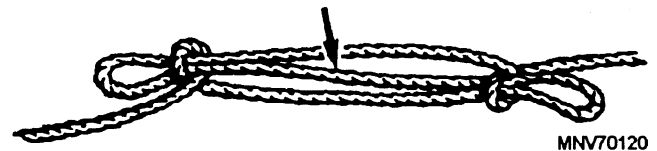

Figure 4-24.—Sheepshank.

First, as in all seizings, splice an eye in the end of the seizing stuff. Take a turn around the line, and pass the end of the stuff through the eye. Pull it taut and double the stuff back, taking several turns around the line. Then pass the end under the turns and again through the eye. Last, tie a clove hitch over the turns and between the two parts of the line. See views A and B of figure 4-25 for the steps in making a flat seizing.

ROUND SEIZING

View C of figure 4-25 shows the completed round seizing. Stronger than the flat seizing, it is used where strain is greater.

Start it as you did the flat seizing, taking your turns and leading the end under them and back through the eye. Then take another row of turns over the top of the first row. Finish by tucking the end under the last turn and heaving taut or with a crossed clove hitch as in the flat seizing.

SEIZINGS

Seizings are used when two lines or two parts of a single line are to be married permanently. This should be done with seizing stuff, which is generally rope-laid, tarred American hemp of 6, 9, or 12 threads. For seizing small stuff, however, sail twine is adequate.

Many types of seizings were used for special purposes in old sailing ships, but the four described here should suffice for Seamen in modern ships.

FLAT SEIZING

Flat seizing is light and is used where strain is not too great.

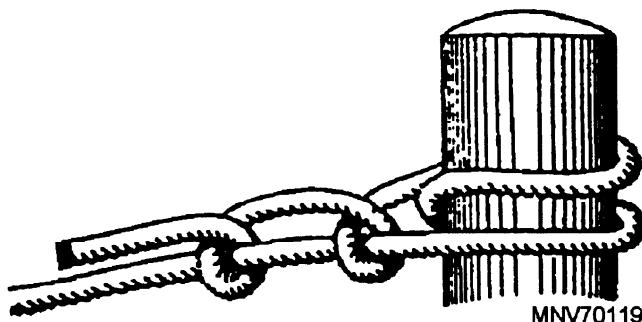

Figure 4-23.—Round turn with two half hitches.

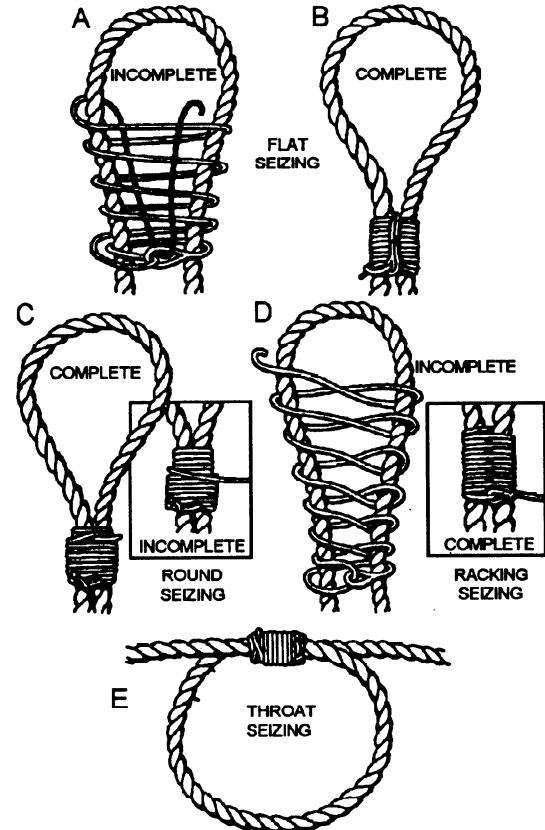

Figure 4-25.—Seizings.

RACKING SEIZING

Use racking seizing where there is an unequal strain on the two parts of the line. Lay turns around the line in figure-eight fashion for about ten turns. Then pass the seizing stuff back in the opposite direction, and take a row of turns over the top of the racking as is done in a round seizing (fig. 4-25, view D). Finish off by passing the end through the eye again, and tie an overhand knot.

THROAT SEIZING

Throat seizing is actually a round seizing and is used wherever a temporary eye is needed in the middle of a line. View E of figure 4-25 shows a completed throat seizing.

MOUSING HOOKS AND SHACKLES

A hook is moused to keep slings, straps, and so forth, from slipping out of the hook and to strengthen the hook if there is the danger that the load will bend it. If the purpose of the mousing is to keep a strap or sling from escaping, marline or rope yarn may be used. If the purpose is to strengthen the hook, seizing wire or a shackle may be used. The proper method for each purpose is shown in figure 4-26.

Shackles are moused whenever there is the danger that the shackle pin will work loose and come out because of vibration. Several turns are taken through the eye of the shackle pin and around the shackle itself with seizing wire so the pin cannot turn.

WIRE ROPE

Wire rope may have few applications on some Navy ships, but on minesweeping ships, wire rope is extremely important. The following information on wire rope is of a general nature. Wire rope used in minesweeping operations will be discussed in later chapters on minesweeping.

CONSTRUCTION OF WIRE ROPE

The basic unit of wire rope construction is the individual wire made of steel or other metal in various sizes. These wires are laid together to form strands. The number of wires in a strand varies according to the

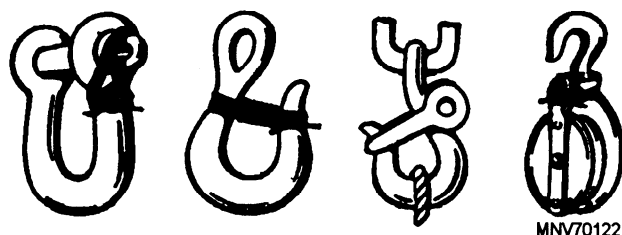

Figure 4-26.—Methods of mousing.

purpose for which the rope is intended. A number of strands are laid together to form the wire rope itself. Wire rope is designated by the number of strands per rope and the numbers of wires per strand. Thus a 6 x 19 rope has 6 strands with 19 wires per strand but can have the same outside diameter as a 6 x 37 wire rope, which has 6 strands with 37 wires of much smaller size per strand. Wire rope made up of a large number of small wires is flexible, but the small wires break so easily that the wire rope is not resistant to external abrasion. Wire rope made up of a smaller number of larger wires is more resistant to external abrasion but is less flexible.

The strands of the wire rope are laid up around a central core, which may be fiber, a single strand of wire, or an independent wire rope. A fiber core contributes flexibility, cushions the strands as the wire rope contracts under strain, and holds a portion of lubricant for continuous lubrication. A wire core is stronger than fiber and can be used where conditions such as high temperatures would damage fiber. Some end views of the arrangements of strands in wire ropes are shown in figure 4-27.

Wire rope may be fabricated by either of two methods. If the strands of wires are shaped to conform to the curvature of the finished rope before their laying up, the wire rope is termed preformed. If the strands are not shaped before fabrication, the wire rope is termed non-preformed. When cut, preformed wire rope tends not to untwist and is more flexible than non-preformed wire rope.

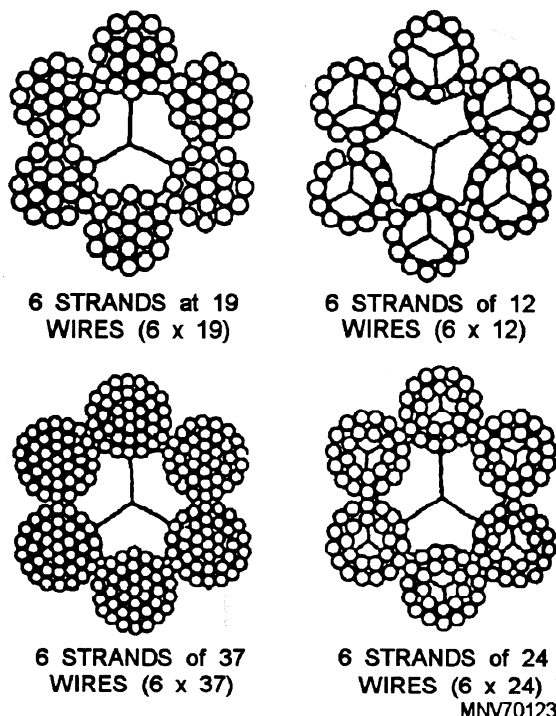

Figure 4-27.—Arrangement of strands in wire rope.

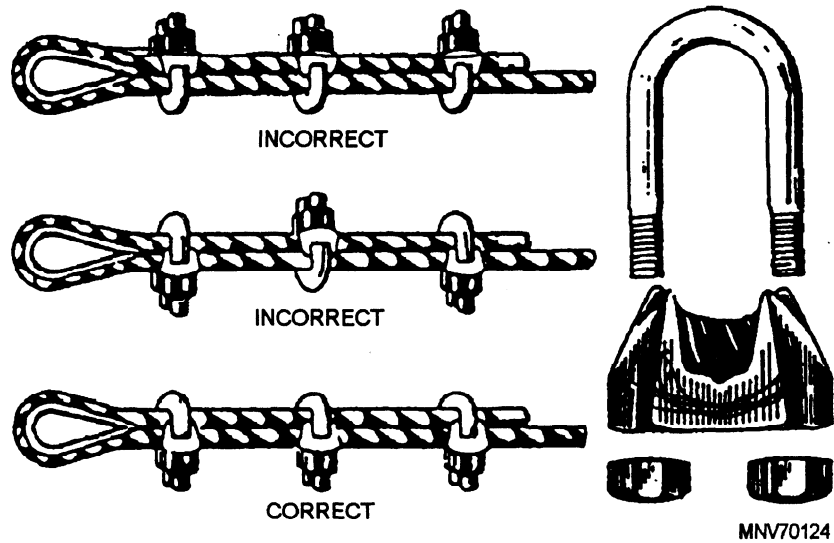

Figure 4-28.—The correct use and incorrect uses of wire rope clips.

WIRE ROPE CLIPS

A temporary eye splice may be put in wire by using wire rope clips. The correct and incorrect ways of using these clips are shown in figure 4-28.

Always place the U-bolt over the bitter end and the roddle (saddle) on the standing part. (Never saddle a dead horse.) Space the clips a distance apart equal to six times the diameter of the wire. After a rope is under strain, tighten the clips again. On operating ropes, tighten the clips every few hours and inspect the rope

carefully at points where there are clips. Pay particular attention to the wire at the clip farthest from the eye, because vibration and whipping are damaging here, and fatigue breaks are likely to occur.

To obtain maximum strength in a temporary eye splice, use the correct size and number of wire clips. The size is stamped on the roddle between the two holes. The correct number of clips to use for various sizes of wire ropes is shown in table 4-7.

For more detailed information on wire rope, refer to NSTM, Chapter 613, *Wire and Fiber Rope*.

Table 4-7.—Minimum Number of Clips Required

Rope Diameter (inches)	All 6 × 7 Ropes; All Ropes With Independent Wire Rope Centers	All 6 × 19 and 6 × 37 Ropes	Proper Torque to be Applied to nuts of clips [ft/lb (Dry)]
3/8	4	3	45
1/2	4	3	65
5/8	4	3	95
3/4	5	4	130
7/8	5	4	225
1	6	5	225
1 1/8	6	5	225
1 1/4	7	6	360
1 3/8	7	6	360
1 1/2	8	7	360
1 3/4	8	7	590

CHAPTER 5

DECK SEAMANSHIP

LEARNING OBJECTIVES

Upon completing this chapter, you should be able to do the following:

1. Describe the most common deck fittings used on board ship.
2. Describe the approved rigging and procedures for going aloft and working over the side.
3. Explain the safety requirements for going aloft and working over the side.
4. Describe the use and care of canvas and leather products on board ship. Explain how to sew the different types of stitches that are common to deck force duties.
5. Explain the purpose of underway replenishment and identify the basic rigs associated with underway replenishment.

DECK FITTINGS

Deck fittings are devices attached to the hull that assist in handling the ship. The most common fittings are found around the weather decks. A brief description of some common deck fittings (fig. 5-1) follows.

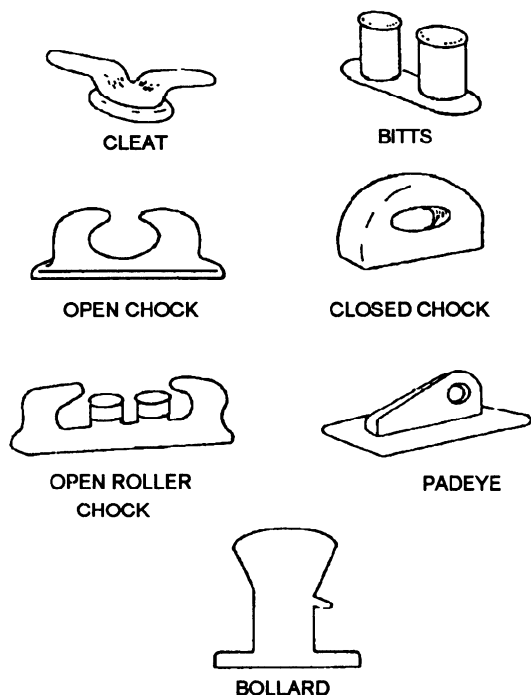

MNV70125

Figure 5-1.—Various deck fittings.

CLEAT

A cleat consists of an in-line pair of projecting horns and is used for belaying a line.

BITTS

Bitts are heavy vertical cylinders, usually arranged in pairs, that are used for making fast lines led through chocks. The upper end of a bitt is either larger than the lower end or is fitted with a lip to keep the lines from slipping off accidentally. Since bitts take very heavy loads, extra frames are worked into their foundations to distribute the strain. Usually, there is a set of bitts forward and aft of each chock. When constructed in pairs, each bitt is sometimes called a barrel.

CHOCK

A chock is a heavy fitting with smooth surfaces through which mooring lines are led. Mooring lines are run from bitts on deck through chocks to bollards on a pier when the ship is moored. There are three types of chocks: open, closed, and roller. An open chock is a mooring chock that is open at the top. A closed chock is a mooring chock closed by an arch of metal across the top. A roller chock is a mooring chock that contains a roller for reducing friction.

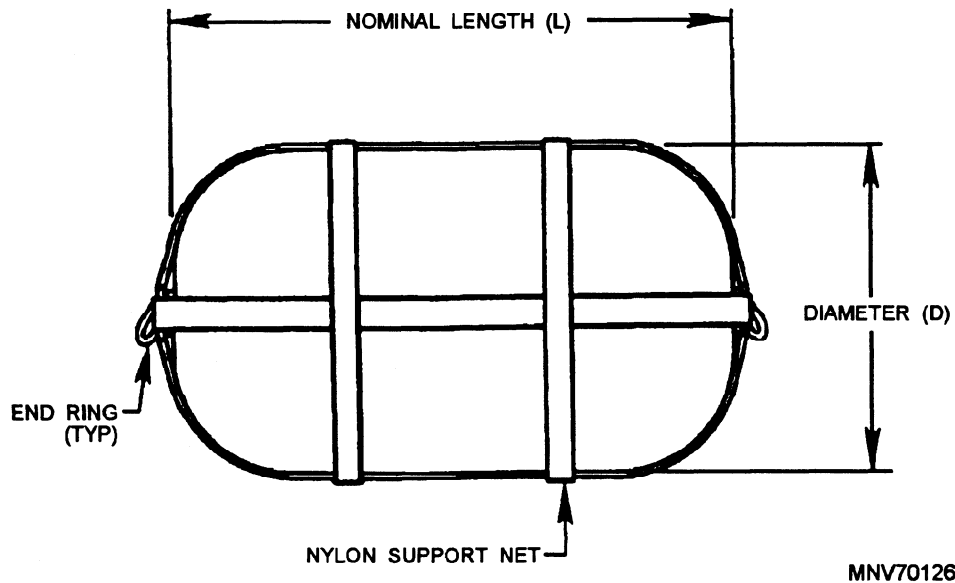

Figure 5-2.—Navy-style foam-filled fender.

PADEYE

A padeye is a plate with an eye attached, welded to the deck to distribute the strain over a large area, and to which a block can be hooked or shackled. A padeye is also used in towing operations.

BOLLARD

A bollard is a strong cylindrical upright on a pier, over which the eye (or bight) of a ship's mooring line is placed.

FENDERS

Fenders protect the ship from contact with the pier or another ship.

The most common ship fender is a pneumatic fender made of rubber, about 4 feet long and 3 feet in diameter. It should be positioned amidships at the extreme beam. This fender is normally the only one the ship rides against when it is alongside another ship. A number of additional fenders, depending on the size and type of ship, are kept ready on the forecastle and on the

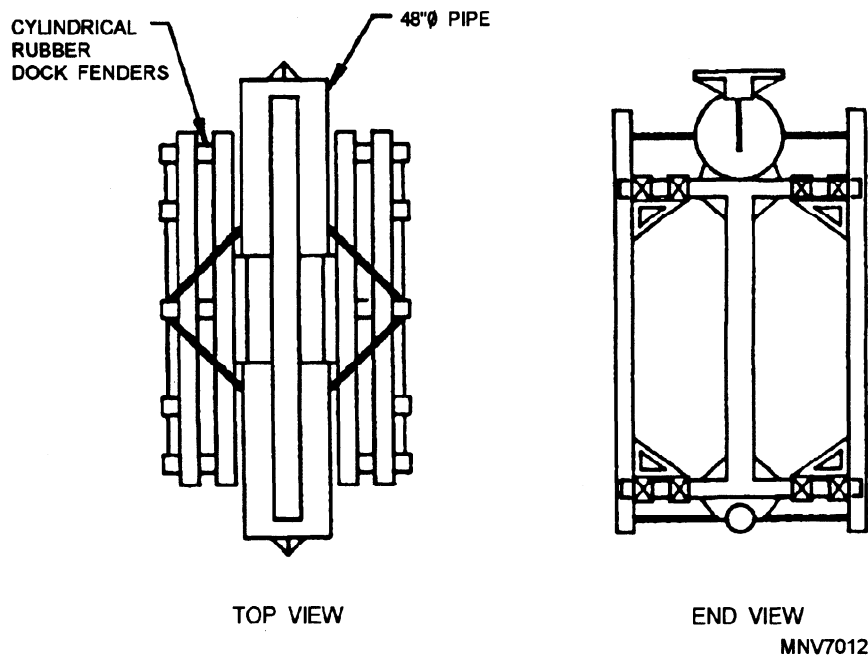

Figure 5-3.—Camels.

fantail. These are normally smaller pneumatic fenders or homemade manila fenders about 4 feet long and 1 foot in diameter. The Navy-type fender is shown in figure 5-2.

CAMELS

Camels are used to protect a fender system from damage due to the motion of moored ships and, where necessary, to provide proper clearance between a ship and a wharf or pier. Camels are floating separators that can be attached to a fender system, the wharf, pier, or the ship itself. The camels that are generally used for mooring a ship are shown in figure 5-3.

THE SEAMAN ALOFT

As a Mineman in the deck division, you will be involved in painting or doing repairs while working either aloft or over the side. To do these tasks safely, you must be able to rig and use both the boatswain's chair and the stage correctly. You must also know the safety precautions involved in working aloft and over the side.

BOATSWAIN'S CHAIR

The boatswain's chair is a hardwood seat attached to a double bridle of stout line, as shown in figure 5-4. It is always bent to the gantline by a double becket. A length of slack line is left hanging, as shown in the figure, for use in securing the chair to a mast, or in staying aloft.

For a straight drop, as when painting down a mast, rig the chair for self-lowering. When you ascend a mast, you will often find that the ladder takes you only to the crosstree. You must be hoisted from there to the truck (top of the mast) by personnel on deck. When there is no way of getting to the truck by ladder, a dummy gantline is usually left reeved from the cross-tree up through the sheave (pulley) at the truck and back to the crosstree. This allows you to attach the chair gantline to the

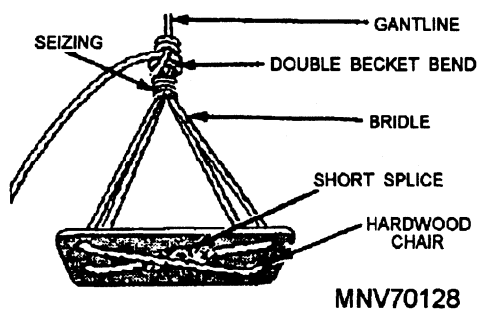

Figure 5-4.—The boatswain's chair.

dummy gantline and then use the dummy gantline to pull the chair gantline through the sheave. If there were no dummy gantline, someone would have to climb the topmast to reeve the chair gantline through the sheave. Never let the end get away from you and reeve out.

A recommended method of securing gantlines is diagrammed in figure 5-5. The end of the chair gantline is secured to the end of the dummy gantline by butting the two ends together and seizing the ends with turns of rope yarn back and forth between strands, so the joint will pass through the sheave without fouling. In use, the chair gantline is hauled up and through by the dummy gantline, the chair is heaved from the deck to the crosstree, and the hauling part is passed down to the personnel or deck crew.

Never let anyone attempt to hoist the chair aloft with the dummy gantline. Be sure all your tools and equipment are attached to the chair so that your hands are free and to ensure the safety of anyone below from falling objects. When you are ready to go up, and the deck crew is ready to heave around, get into the chair and give a signal to be pulled up. Assist the deck crew by hauling down on the hauling part. Keep your hands clear of the part the chair is on or they may get jammed into the sheave when you are two-blocked to the truck. When you reach your desired working height, signal the crew below to "Hold what you got". The deck crew will stop pulling and hold the chair in place. Reach above the double becket bend with your left hand and firmly squeeze the two parts of the gantline together. When you have a good grasp, command the deck crew Up behind. This tells them to let go of the gantline.

WARNING

At this point, your grasp is all that is keeping the chair from falling. With your right hand, pull the gantline through the bridle and squeeze the three parts together just above the double becket bend.

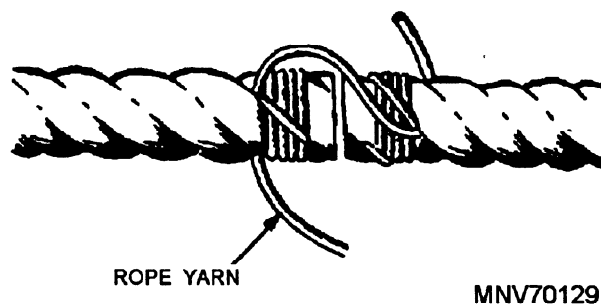

Figure 5-5.—Method of securing gantlines.

Now the strain is on the bridle, as in the first view of figure 5-6.

With your free left hand, pull up some slack from below so you will have enough line to pass over your head, around the chair, and under your feet, as in the second view of figure 5-6. This maneuver is a bit tricky, especially if you have a bucket or two hanging on the chair, but you will not have any trouble if you have enough slack pulled up. Keep hold of the gantline with your right hand until you have worked the hitch up to the apex of the bridle, as shown in the third view of figure 5-6. Then hold the two parts of the gantline above your right hand with your left, and work the rest of the slack down.

You are now in no danger of falling, and all you have to do to lower the boatswain's chair is pull up the

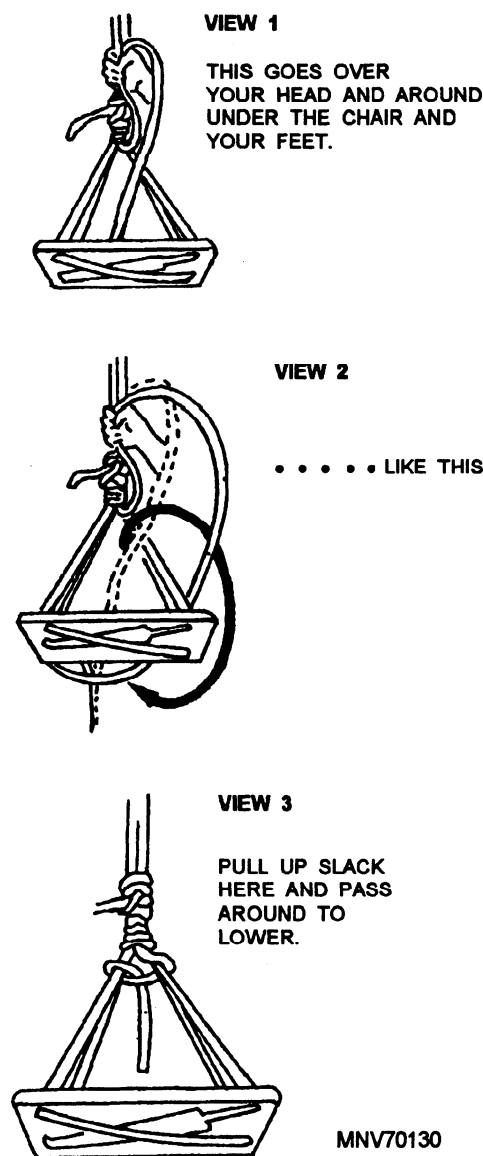

Figure 5-6.—Rigging for self-lowering.

slack and pass it around. Before you go aloft for the first time, practice hanging off deck a few times.

SAFETY PRECAUTIONS

The following are a few safety precautions you must follow whenever you work aloft. Before you go aloft, review all of the safety precautions on working aloft listed in OPNAV Instruction 5100, Vol II, Chapter 8.

1. Be sure you have permission from the officer of the deck (OOD) before you go aloft.
2. Be sure that radio and radar units are OFF and rotatable antennas are stopped and guarded. Ask if the "man aloft chit" has been completed. A man aloft chit is processed to ensure that key personnel are aware of any work being done aloft. The chit is signed by the ship's electrical maintenance officer (EMO), communications officer (COMMO), and command duty officer (CDO).
3. Tie your tools and equipment to the boatswain's chair to prevent them from falling on personnel below.
4. Wear a safety harness and secure it to a fixed object above you once you are aloft.

WORKING OVER THE SIDE

As with work aloft, work over the side has certain rules that must be followed. The following rules are the basic rules for all work over the side.

1. Personnel preparing to work over the side should notify the OOD. Upon securing, they should notify the OOD again.
2. All personnel working over the side of the ship on stages, boatswain's chairs, and on work floats or boats along the side of the ship must wear life jackets and, with the exception of personnel in boats, must be equipped with a parachute-type safety harness with safety lines tended from the deck above.
3. All personnel should be instructed in all applicable safety regulations before they are permitted to work over the side of the ship on scaffolding, stages, or in boatswains' chairs.
4. A competent petty officer must constantly supervise personnel working on scaffolding, stages, and in boatswains' chairs, and personnel must be assigned to tend the safety lines.

5. All tools, buckets, paint pots, and brushes used by personnel working over the side of the ship should be secured by lanyards to prevent their loss overboard or injury to personnel below.

STAGE

The stage is a stout plank, to the underside of which two short wooden horns are attached athwartships, either by nailing or bolting on, a foot or two from either end. When the stage is rigged properly, all the weight comes on the plank. The chief purpose of the horns is to hold the plank off the side.

The gantlines on your stage may be rigged in one of two ways. The first is by means of an eye splice in the end of the gantline (fig. 5-7). Be sure to pass the part between the half hitches under the plank. If you pass it over the plank, there will be nothing holding you up but the horns. The second method of rigging the stage is by means of the stage hitch, shown in figure 5-8. This method is the better of the two because there are two parts of the gantline under the plank instead of one, and there is no need to eye splice the end.

REEVING GANTLINES

The best way to reeve your gantline for lowering is over a smooth surface. Never have your gantlines running over a sharp edge. Place chafing gear wherever the lines from your shackles cross anything sharp.

Be sure to follow these safety precautions whenever you are part of an over-the-side working party:

- Lower one end of your partner's stage at a time while your partner keeps the other side secured.

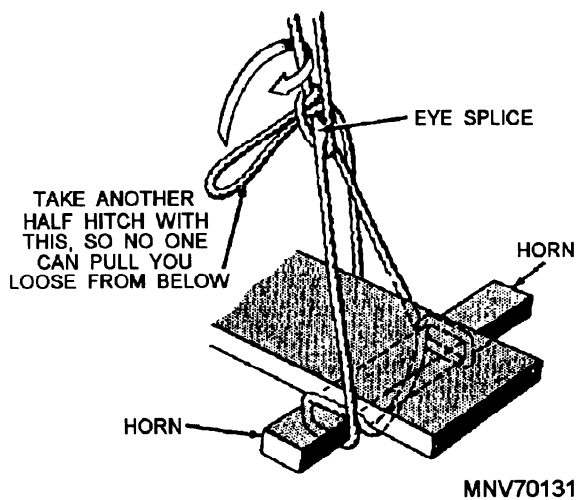

Figure 5-7.—Eye splice rig on a stage.

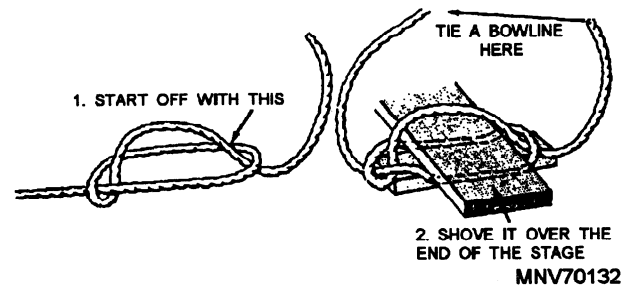

Figure 5-8.—Rigging with a stage hitch.

- Warn your partner before making moves that may jar the stage.
- Always wear a safety harness and lifeline when working on a stage.
- Always wear a life jacket when working over water.
- Keep clear of overboard discharges.
- Do not secure safety lines or gantlines to the stations that hold up the lifelines.
- Do not allow more than two persons on a stage at the same time.
- Secure tools to the stage with small stuff to prevent them from dropping.

TAKING SOUNDINGS

Soundings (measuring the depth of water) are taken when the ship is going into or out of port or approaching an anchorage. The hand lead is the most accurate means for obtaining soundings. It is used in shallow water and when the speed of the ship is slow. Even though ships today have modern depth-sounding equipment, lead lines are a mandatory piece of equipment and are routinely checked during inspections and refresher training periods.

LEAD LINE

The lead line or hand lead consists of a narrow block of lead weighing from 7 to 14 pounds, which is

attached to a marked line (fig. 5-9). With the ship making 12 knots, a good leadsman can get reliable soundings down to 7 fathoms. At slower speeds, of course, the lead has time to sink even deeper before the ship moves up to it. The lead line may also be used for determining the direction in which a ship, practically dead in the water, is moving. Direction of movement is found by placing the lead on the bottom, directly below the leadsman, and noting the direction of the motion of the ship as shown by the change of direction of the lead line from the vertical.

Before you heave the lead, take your station in one of the chains, which usually are platforms projecting over each side at the after end of the forecastle. The lower the lead over the side and support it in the heaving hand by a wooden toggle, inserted in the lead line about 2 fathoms from the lead. Coil the spare line in your other hand, free for running.

To make the heave, start by calling out "Watch-O-Watch," then swing the lead in a fore-and-aft direction

outboard of the chains to gain momentum. When you can swing the lead in a complete circle, and the force is great enough, let go of the lead as it swings forward at a point about level with the deck

As the ship moves ahead, heave in the spare line rapidly. Read the marker when the lead is on the bottom and the line hauled just taut, vertically. You will acquire the ability to heave the lead only by practice. It is necessary to practice with both hands because you will use your right hand for heaving from the starboard chain and your left hand for heaving from the port chain.

A good heave has no value unless you can read the depth correctly and quickly. Learn the markings of the lead line, which are identified in figure 5-9.

Lead lines often are marked at each half-fathom over the range of depth used most and may even have foot markings around the more important depths. Some lead lines are fixed so that you may read the depth at the level of the chains instead of at the water's edge. This procedure makes it easier to take sounds at night. Learn any special markings on the lead line that may be used on your ship.

Report each sounding to the bridge in a sharp, clear voice. When the sounding agrees with one of the marks, report it by mark; such as "Mark 2", "Mark 3", or "Mark 5".

When the sounding falls on an even fathom between marks, report it as "By the deep 4", "By the deep 8", "By the deep 9". If the reading does not give an even fathom, report it as "A quarter less three" (1/4 fathom less than 3 fathoms of water); "And a quarter, four" (1/4 fathom more than 4 fathoms of water); "And a half, four" (1/2 fathom more than 4), and so on. If the lead does not reach the bottom, report "No bottom at (number of fathoms)".

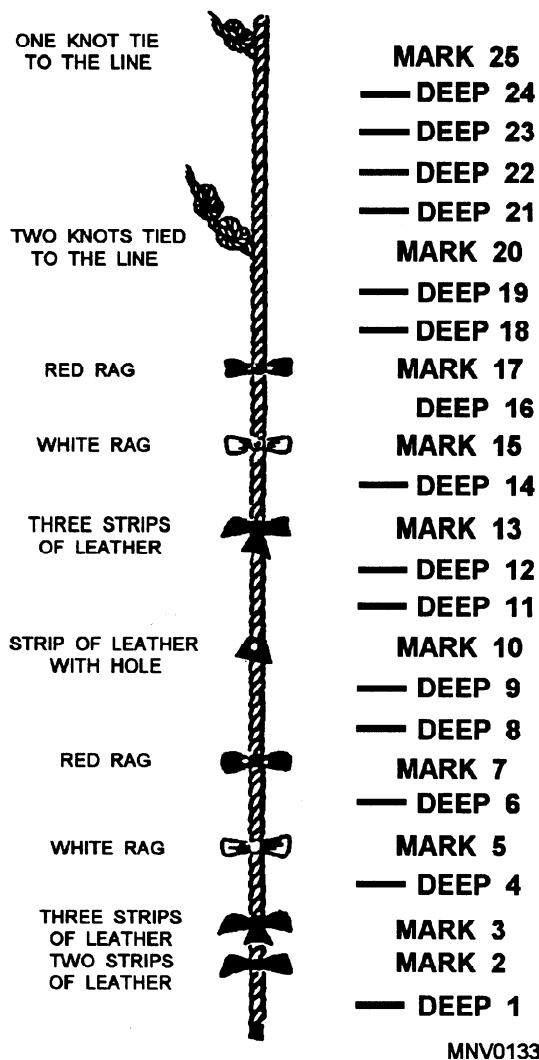

Figure 5-9.—Markings of lead line.

CANVAS AND LEATHER

Canvas and leather have long been important in a Seaman's life. In the next few pages, you will learn how to sew small articles by hand using some of the most common stitches.

Canvas, often called duck, is a general name for a class of strong, heavy, plain cloth woven of cotton or linen. *Numbered duck* is the canvas encountered most often, but occasionally you see the terms *ounce duck* or *army duck*. Numbered duck runs from No. 1, the heaviest, to No. 12, the lightest. Numbers 7, 9, and 11 are no longer issued.

Each number means a certain weight in ounces per square yard of cloth. For example, No. 1 means 28.71 ounces per square yard; No. 6 means 20.74 ounces per square yard; and No. 12 means 11.16 ounces per square yard. Canvas in weights other than those specifically designated under the numbered system is called ounce *duck*. Army ducks are ounce ducks similar to numbered duck, but have finer yarns, higher cloth counts, and usually lighter weights. The following items are a sample of articles made from different weights of canvas.

NO. OF CANVAS	ARTICLE
1	Sandbags
1	Hammocks
2	Hatch paulins
4	Berth bottoms
4	Seabags
4	Gun covers
4	Muzzle bags
6	Large boat covers
8	Hose rack covers
8	Soiled clothes bags
8	General-purpose paulins
10	Shower curtains
12	Destruction bags

Canvas is usually made up in bolts of from 85 to 100 yards, but is issued by the linear yard, in widths from 22 to 72 inches.

Even with the best of care, canvas is relatively short-lived, and for this reason, the Navy is using more synthetic fabrics. Synthetics are not only lighter and easier to stow, but also are rot- and mildew-resistant.

Synthetic fabric, like synthetic line, costs more than natural fabric. Because of this greater cost, you must be more selective in its use.

One type of synthetic fabric used extensively for tarps and awnings and for boat, winch, and reel covers is a nylon cloth with a vinyl film on both sides. (The smooth or face side is the side to expose to the weather.) Two different companies furnish this type of cloth under their own brand names (Herculite #80® and Hypalon®). These white or grey materials weigh approximately 19.6 ounces per square yard and come in

50-inch widths. They are fire-, water-, weather-, and mildew-resistant.

Another type of cloth, a black neoprene-coated material, is less suited for topside use but has many below-deck applications, such as for blackout and welding curtains. This material weighs approximately 2.3 ounces per square yard and comes in a 39-inch width. Generally, you should give synthetic cloths the same care as synthetic lines. When they are dirty, however, you should wash synthetic fabrics with saddle soap or any other mild soap and water; scrub them with a soft bristle brush, using a circular motion; and rinse them with clear water. In some instances, two cleanings may be necessary.

All hems should be triple-folded and sewed, but reinforcing material and other patches may be sewed or cemented in place. When you cement a patch, clean the area with a solvent. Then apply a coat of cement to the patch and to the surface to be repaired or strengthened. Allow these coatings to dry, then apply a second coat to each surface. When these coatings are tacky, position the patch. Rub or roll the patch and make certain that all points make contact.

With synthetic cloth, do not use manila for bolt ropes and lashings, because the manila will stain the cloth. Use cotton line or one of the synthetic lines. The eyelet-and-ring type of grommet has a tendency to slide and pull out of synthetic cloths; therefore, only the spur type of grommet is recommended.

TREATED CANVAS

Much of the canvas issued in the Navy is treated to make it resistant to fire, water, weather, and mildew. Some is waterproof and oil- and gasoline-resistant. Current specifications for building ships require that all topside canvas be treated according to the intended use. Canvas to be used below decks is usually white and untreated. Preservatives are available for shipboard use on untreated canvas or for re-treating canvas.

CARE AND STOWAGE

Canvas is very expensive, so learn to care for it and make sure to never abuse it. New and unused canvas, spare covers, and so on, should be stowed in a clean, dry storeroom. Never store canvas where acid is or has been stowed; acid fumes are detrimental to canvas. Make every effort to provide a space free from rats, mice, and insects. Do not stow wet, painted, or oil-soaked canvas below decks. Occasionally it is necessary to scrub canvas that has become dirty or stained by grease or oil.

Use a mild soap solution, rinse thoroughly, and hang the canvas up to dry.

All covers, awnings, and paulins should be inspected frequently and carefully, and all rips and tom or loose seams should be repaired. If a grommet tears out, sew a patch over the spot and put in another grommet. A larger size grommet may be substituted for one that has tom out if it is in a spot where appearance is unimportant. You can save time and trouble if you file away or enter into a log all information pertaining to renewing canvas articles aboard your ship.

Measuring Canvas

Take great care when you measure and cut canvas—**MEASURE TWICE AND CUT ONCE**. When you measure canvas for items that will be stretched taut (awnings, for example), **DEDUCT** one-half inch for each linear foot in both width and length. If the canvas is to be loose (as for hatch hoods and gun covers), **ADD** one-half inch for each linear foot in both width and length. Use the old article for a pattern whenever possible. When the old article is not available, make a sketch of the item, showing all the necessary dimensions, and work from that.

SEWING CANVAS BY HAND

In most instances when you are required to fabricate articles, you will need the appropriate tools, a few of which are as follows:

- Sail needles. Needles are numbered according to size; the higher the number, the smaller the needle. The heavier the canvas, the larger your needle should be. After being used, needles should be dried carefully and oiled or stowed in a container of powdered chalk to prevent them from rusting.
- Palms. Two types of palms are issued in the Navy; the sailmaker's palm (fig. 5-10) and the roping palm. At first glance you probably see no

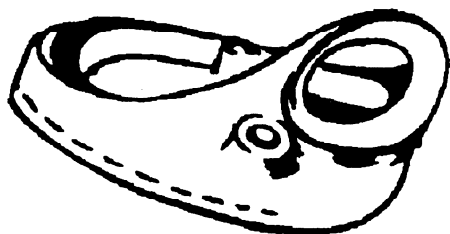

MNV70134

Figure 5-10.—Sailmaker's palm.

difference, but if you check the metal slug you can see that the roping palm is designed for larger size needles. This is the palm to use when jobs require the largest needles—sewing on bolt ropes, for example. They are designed to be worn in the palm of the hand and are used to aid in pushing a sail needle through the material being sewn.

- Sailmaker's hook or bench hook. This hook (fig. 5-11) has a swivel eye. It is used to hold the ends of two pieces of canvas being sewn together, as shown in figure 5-11.
- Beeswax. This substance can hardly be called a tool, but it is a necessary item. It reduces the wear on the sail twine while sewing is being done, and it retards deterioration. To use it, run the sail twine through the block surface of the beeswax. This gives the twine a waxed coat.
- Sail twine. Many different types of twine are used for sewing, but lacing twine (already waxed) is best for hand-sewing.

Stitches and Their Uses

The following are some of the common stitches that you will find useful in your work:

- Round stitch. The round stitch is the stitch most commonly used for joining two pieces of canvas. Turn back the edges, hold the pieces together, and send the needle through both pieces at right angles to the seam, as shown in figure 5-11.

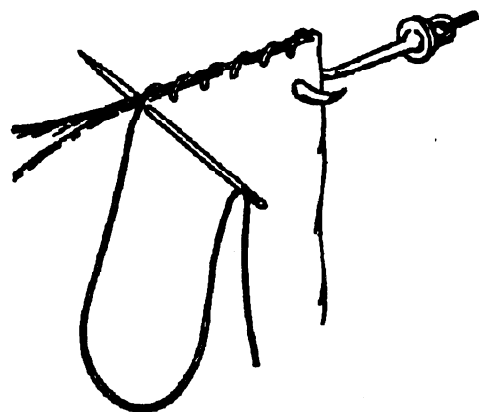

MNV70135

Figure 5-11.—Round-stitching a canvas held by a bench hook.

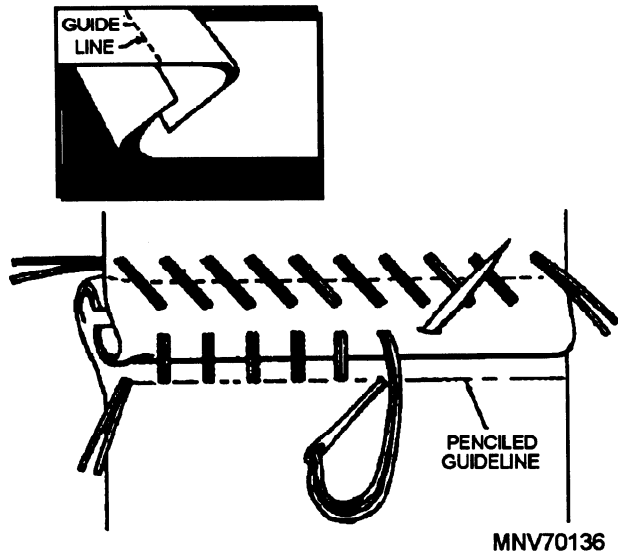

Figure 5-12.—Flat stitch.

- Flat stitch. A flat stitch is used when a strong seam is required, as on a paulin or a sail. Pencil a guideline 1 1/2 or 2 inches from the edge of each strip of canvas, depending on how wide you want the seam. Crease each piece on a line slightly less than halfway to the guideline. Make the folds away from the guidelines and interlock the folds (fig. 5-12). Interlocking the edges forms a watertight seam and keeps a ragged edge from showing. Insert the needle at the guideline, and stitch diagonally so that the stitches appear at right angles to the seam on top but run at an angle on the reverse side. After completing one edge, turn the canvas over and sew the other edge of the seam. Flat stitching also is used for patching.
- Baseball stitch. The baseball stitch is used to mend tears in light and medium canvas. Figure 5-13 shows how it is done. Keep enough tension on the thread to remove all loops and slack

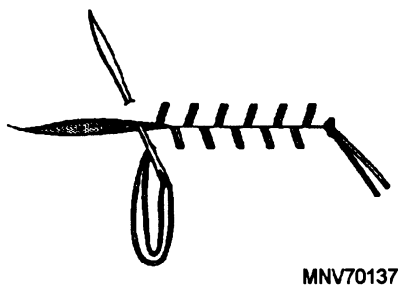

Figure 5-13.—Baseball stitch.

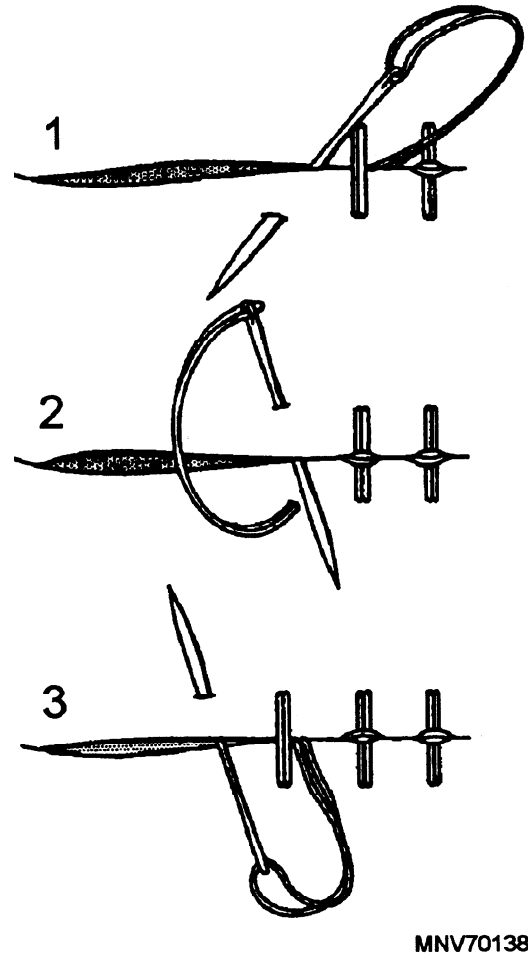

Figure 5-14.—Herringbone stitch.

thread. Do not apply too much tension, however, because this tends to pucker or draw the seam out of line.

- Herringbone stitch. The herringbone stitch is used to mend tears in heavy or painted canvas. Figure 5-14 shows the steps in making this stitch. As you can see from the picture, the herringbone stitch is very strong if applied correctly, as each stitch locks itself as it begins the next.

Sewing Bolt Ropes to Canvas by Hand

Bolt ropes are the ropes around the edges of awnings and sails. Their purpose is to take the strain of the stops, clews, reef points, and the like. To sew on a bolt rope, hem the canvas and lay the rope along the edge. Use a round stitch, the size of which is determined by the size of the rope. Sew the rope to the canvas,

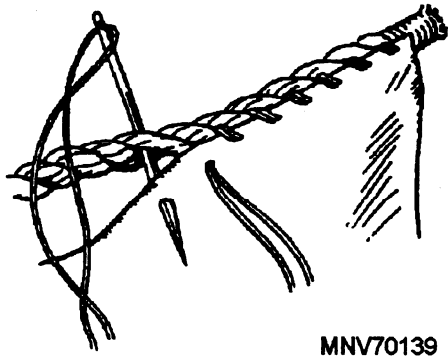

MNV70139

Figure 5-15.—Sewing a bolt rope to canvas.

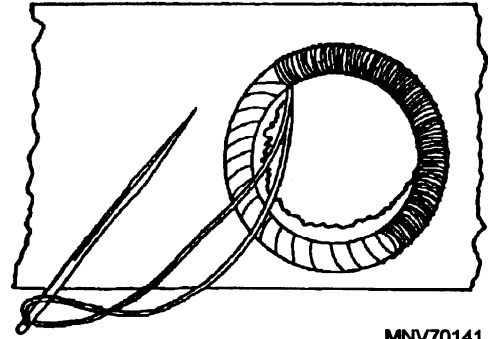

MNV70141

Figure 5-17.—Round-stitching a hand-sewn grommet.

strand by strand, as shown in figure 5-15. Carefully observe the following points when you sew on bolt ropes:

- Keep the rope taut and the canvas slack.
- Do not bunch the canvas, but hold your needle at such an angle that it goes through the canvas a fraction of an inch ahead of where it comes out from under the strand.
- Sew each strand to the canvas, making sure the needle goes under, not through, the strands.
- Do not let your stitches start to creep up around the rope, but keep them coming out of the rope in a straight line along the underside. If you let them creep, the canvas begins to curl around the rope.
- **BE SURE YOUR STITCHES ARE TIGHT.**

HAND-SEWING GROMMETS

Metal grommets have replaced the hand-sewn type. But if you are ever caught without the proper size of metal grommet, it is nice to know how to make one by hand. Properly made and sewn to the canvas, hand-sewn grommets are almost as strong as the metal type.

The first step is to fashion a two- or three-strand grommet of marline. To do this, form a ring with the marline, of the desired size. Start with an end, laying the strand about itself, as in view A, figure 5-16. Continue laying the marline about itself, as in making a piece of line, until you complete the circle, as in view B, figure 5-16. Half knot the ends and stretch this over a fid to make it round and firm. Next, take your sail twine and double it, then twist the two parts together and cover the pair with beeswax. Then punch a hole slightly smaller than the grommet in the canvas. Sew the grommet using a round stitch; keep your stitches close together to cover the grommet. See figure 5-17. After completing the stitches, shape the grommet again with a fid.

Using Metal Grommets

Several different types of metal grommets are in use, but the two that are most familiar are pictured in figure 5-18. The one in view A is called the eyelet-and-ring type, and comes in sizes 6 to 15, inclusive, with inner diameters from three-fourths of an inch to 2 inches. View B shows the spur type. It comes in sizes 0 to 6, inclusive, with inner diameters from one-fourth to three-fourths of an inch,

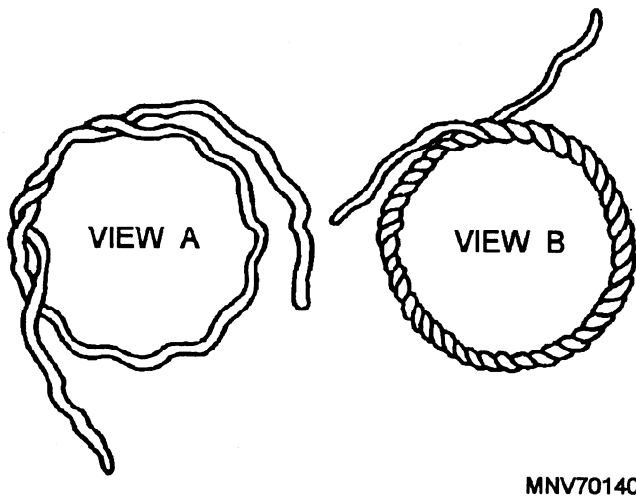

MNV70140

Figure 5-16.—Fashioning a marline grommet.

The cutting punches shown range in diameter from 1 inch down to seven-sixteenths of an inch in the double-bow type (view C), and from three-eighths to one-eighth of an inch in the single-bow type (view D). When you use these to punch holes in canvas, lay the

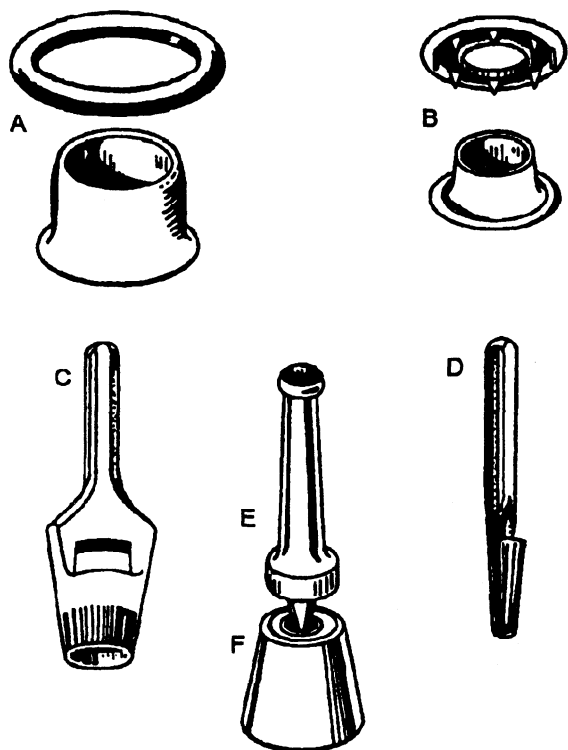

MNV70142

Figure 5-18.—Grommets, cutting punches, and inserting-punch die.

canvas on a piece of heavy sheet lead, and they will cut a neat, clean hole.

The grommet-inserting punches and dies are available in sets in the same sizes as the grommets; that is, from 0 to 15. Use the same size set as the size of grommet. In figure 5-18, view E shows the punch, and view F, the die.

The proper way to insert the spur type of grommet is to push the eyelet part of the grommet through the hole in the canvas. Place the eyelet on the die and, the spur over the eyelet. Fit the punch inside the eyelet and strike the top of the punch with a hammer. This will curl the edge of the eyelet down over the spur. Do not pound too hard on the punch, because that causes the grommet to cut through the canvas, and later it may pull out.

The eyelet-and-ring type of grommet is designed specially for awnings and sails. Properly used, this is the best of all types. First, sew the ring part to the canvas the same as the handmade grommet. Then place the eyelet in the ring and set it with the punch and die.

Sewing Metal Fittings to Canvas

Most metal fittings that must be sewn to canvas are rings of some sort. When you sew them on, as when you

make grommets, use your sail twine doubled and twisted together. Use as many round stitches as you can, stitching through the canvas over as great an area as possible, to spread the strain. Usually O-rings are secured to canvas by placing a webbed strap, folded canvas strip, or even a leather strap through the ring and sewing the strap to the canvas, using a flat stitch.

Awning Hooks

Awning hooks make canvas easy to install and remove. To position these hooks and to prevent them from sliding along the bolt rope, take several crisscross stitches around the hook, as shown in figure 5-19. Put several stitches around the concave pad on each side of the hook to take the strain of the awning lashings.

It is a good idea to sew a reinforcing patch over the edge of canvas at every place that you plan to attach a metal fitting.

LEATHER

Hides and skins, being of animal origin, vary in size (area), thickness, and weight. Subsequent tanning and finishing processes further alter these features. The following information concerning size, thickness, and weight is therefore only approximate.

The various types of leather include rigging, harness, shoe, chamois, kid, lacing, belting, and various artificial leathers. Of these, the three you are most likely to need are rigging, belting, and artificial leathers.

Rigging leather is designated by weight as light, medium, and heavy, and ranges from 6 ounces per square foot to over 10 ounces per square foot. It is issued by the pound. There are approximately 20 square feet per hide, and each sixty-fourth of an inch of thickness equals approximately 1 ounce per square foot.

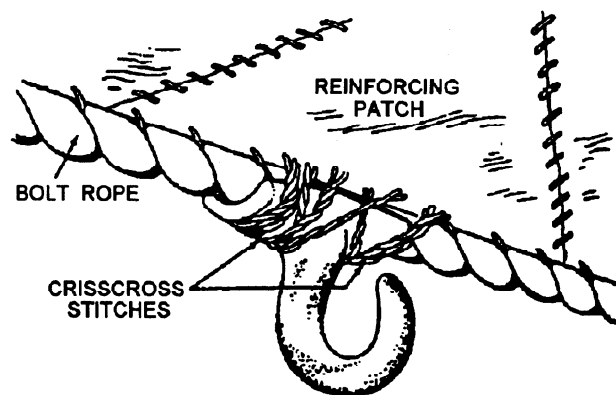

MNV70143

Figure 5-19.—Awning hooks.

Belting is either round or flat and is issued in any desired length by the linear foot. Round belting comes in two widths: one-fourth inch and three-eighths inch. Width is used instead of diameter because, despite the name, round belting is oval rather than perfectly round. Flat belting may be either single- or double-ply. Single-ply belting is available in 1- to 6-inch widths; double-ply, in 2- to 12-inch widths.

The most common types of artificial leathers are used for upholstery and are issued by the square foot.

CARE OF LEATHER

Leather exposed to the elements should be kept well oiled or waxed. Any oil that does not contain harsh chemicals is suitable, but the best is neat's-foot oil. Leather in places such as on lifelines may be kept well preserved by the application of paste wax. Saddle soap, an excellent preservative and cleaner, can be used on holsters, shoes, jackets, and other leather wearing apparel. If leather becomes badly soiled and stained, wash it with a mild soap and water solution, rinse it well, and then dry it in a spot away from intense heat. After it is dry, apply saddle soap or neat's-foot oil to replace the natural oils of the leather.

Leather is especially subject to mildew and rotting. It is also highly susceptible to accidental cutting, gouging, and abrading. Excessive heat causes it to shrink considerably, with subsequent rending and cracking. Acids, corrosives, or their fumes have a disastrous effect upon leather.

To avoid the problems mentioned above when you stow leather, follow the suggestions listed below.

- Stow rolls of leather on top of other materials to prevent crushing
- Stow leather well clear of any liquids or greases that might stain it
- To prevent hides stowed one on top of the other from sticking, place paper between the hides
- Leave original, moistureproof wrappers on as long as possible, to prevent mildew
- Be sure the compartment in which you store the leather is dry and well-ventilated.

SEWING LEATHER

When you need to join two leather edges by hand-sewing, groove the lines along which the stitches will

run to countersink the stitches below the surface. Draw a line parallel and close to the edge first, then make your groove with a grooving tool (a dull knife will do). Use a block of wood for a straightedge. Next, punch holes along the grooves for the stitches.

The shoemaker's or cobbler's stitch is shown in figure 5-20. A variation of this stitch is to cut the leather carefully so that the edges abut. Angle the grooves toward the edges of the leather and sew through the edges. Inset A of figure 5-20 shows the end view of the regular shoemaker's stitch. Inset B of figure 5-20 shows the variation.

For easier handling of leather, soak it in a bucket of water for a few minutes. This will soften the leather and make it easier to form.

UNDERWAY REPLENISHMENT

Underway replenishment (UNREP) is a broad term applied to all methods of transferring fuel, munitions, supplies, and personnel from one vessel to another while under way. The term *replenishment at sea*, formerly used in this sense, now applies to all methods except those for fueling at sea.

Before the techniques of UNREP were developed, a ship that ran low on fuel, supplies, or ammunition had to return to port, or the fleet had to lie to while the ship was partially replenished by small boats. If several or all of the ships were in need, the whole fleet had to return to port. The disadvantages were obvious. The effectiveness of a fleet was reduced by every ship that had to leave, and a ship or small group of ships detached

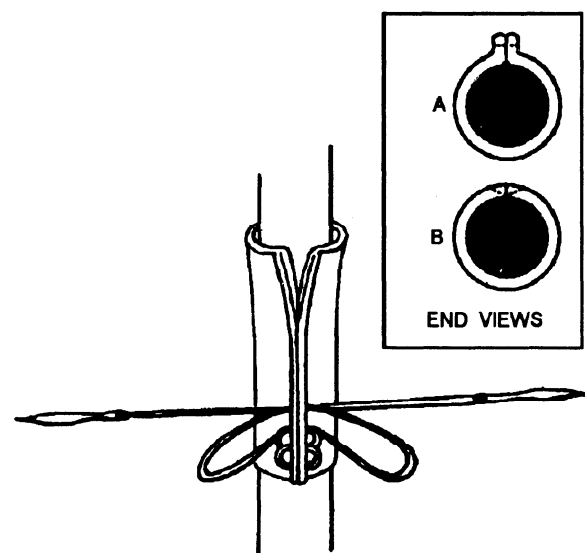

MNV70144

Figure 5-20.—Shoemaker's stitch.

from a fleet were in greater danger of being sunk or captured. A fleet lying to in order to replenish was more vulnerable to attack, and a fleet heading back to port left the way open for an enemy fleet to accomplish its mission. With UNREP, a whole fleet can be resupplied, rearmed, and refueled in a matter of hours while proceeding on its mission.

CONNECTED REPLENISHMENT

In connected replenishment (CONREP), two or more ships steam side by side, and the hoses and lines used to transfer fuel, ammunition, supplies, and personnel connect the ships. CONREP involves two processes—refueling and resupply. In fueling at sea (FAS), fuel is pumped from a delivering ship, which may be a replenishment oiler (AOR), oiler (AO), fast combat support ship (AOE), or a large combat ship. Other replenishment ships such as the combat store ship (AFS) and the ammunition ship (AE) can deliver lesser amounts of fuel, but their primary purpose is to deliver solid cargo—that is, supplies and ammunition—by the methods now referred to as replenishment at sea (RAS).

The most common refueling rigs are the span-wire and close-in rigs. The span-wire rig has several variations—single hose, double hose, and probe. The span wire may be either tensioned or untensioned. The span wire is tensioned by a ram tensioner. A tensioned span wire, or highline as it is called in RAS, is also used when the standard tensioned replenishment alongside method (STREAM) of transfer is used. STREAM transfer consists of an all-tensioned rig, highline, outhaul, and inhaul.

The illustrations in this chapter and the procedures described are representative only. For example, many items of rigging, such as guys and preventers, have been omitted from illustrations for purposes of clarity. *Standard Organization and Regulations of the U.S. Navy* (commonly called the SORM), OPNAVINST 3120.32, NWP 14 (Series), and *Underway Replenishment Hardware and Equipment Manual* provide the details of rigging and identify the personnel and tools required for each rig. Ship's plans show rigging details, while the SORM affixes responsibility for the various functions to be performed.

Underway Replenishment Hardware and Equipment Manual provides a catalog of the equipment used in the transfer of solid cargo and bulk fluids and a description of the methods used in UNREP. This manual permits the user to identify the equipment and its intended use, and to locate additional detailed

technical information related to the configuration, operation, maintenance, safety features, installation, and procurement of UNREP equipment.

COMMON REPLENISHMENT FEATURES

Many features are common to all replenishment operations. The officer in tactical command (OTC) is responsible for selecting a suitable course and speed, and for taking into consideration the mission of the group and the condition of the sea.

Generally, the delivering ship takes station, and the receiving ship maneuvers to come alongside and maintain position during the operation. During replenishment, individual flaghoists are displayed, as shown in figure 5-21.

Except for gear actually rigged on the receiving ship (such as fairlead blocks and riding lines) and for the distance line and burton whips, the delivering ship furnishes all the equipment.





BRIDGE-TO-BRIDGE PHONE/DISTANCE LINE

The bridge-to-bridge (B/B) phone/distance line provides both a sound-powered (S/P) phone circuit and a distance-between-ships visual indicating system. This line is required on all ships. See figure 5-22.

DISTANCE MARKERS

Distance markers on the B/B phone/distance line are arranged as shown in figure 5-23. You make the line up for use as follows:

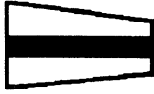
- Day: These markers are colored cloth, nylon-coated fabric, or painted-canvas markers, each 8 inches (20.3 cm) by 10 inches (25.4 cm), spaced at 20-foot (6.0-m) intervals from 0 to 300 feet (0 to 91.4 m). The distance is shown in numerals 5 inches (12.7 cm) high. The markers must be sewn, lashed, or otherwise stopped off in such a way that they will not slide along the line. You must provide grommets, as appropriate, to lash chemical lights for night replenishment.
- Night: Rig chemical lights to the distance line by using two blue chemical lights, one on each side of the 60-, 100-, 140-, and 180-foot (18.2-, 30.4-, 42.6-, and 54.8-m) markers. Lash one red chemical light on the approach-ship side of the other markers. (One-cell, pin-on-type red flashlights may be used instead of red chemical lights.)

VISUAL FLAGHOIST	
 <p>ROMEO DISPLAYED ON FORE YARDARM ON SIDE RIGGED</p>	<p style="text-align: center;">CONTROL SHIP</p> <p>AT THE DIP: AM STEADY ON COURSE AND SPEED AND AM PREPARING TO RECEIVE YOU ON SIDE INDICATED.</p> <p>CLOSE UP: AM READY FOR YOUR APPROACH.</p> <p>HAULED DOWN: WHEN MESSENGER IS IN HAND.</p>
 <p>ROMEO DISPLAYED ON FORE YARDARM ON SIDE RIGGED</p>	<p style="text-align: center;">APPROACH SHIP</p> <p>AT THE DIP: AM READY TO COME ALONGSIDE.</p> <p>CLOSE UP: AM COMMENCING APPROACH.</p> <p>HAULED DOWN: WHEN MESSENGER IS IN HAND.</p>
 <p>PREP DISPLAYED AT THE OUTBOARD YARDARM</p>	<p style="text-align: center;">RECEIVING SHIP</p> <p>AT THE DIP: EXPECT TO DISEGAGE IN 15 MINUTES.</p> <p>CLOSE UP: REPLENISHING COMPLETED; AM DISENGAGING AT FINAL STATION.</p> <p>HAULED DOWN: ALL LINES CLEAR.</p>
 <p>BRAVO</p>	<p style="text-align: center;">BOTH SHIPS</p> <p>WHERE BEST SEEN: FUEL OR EXPLOSIVES ARE BEING RECEIVED.</p> <p style="text-align: center;">APPROACH SHIP</p> <p>AT THE DIP: HAVE TEMPORARILY STOPPED SUPPLYING.</p> <p>CLOSE UP: FUEL OR EXPLOSIVES ARE BEING RECEIVED.</p> <p>HAULED DOWN: DELIVERY IS COMPLETED.</p> <p style="text-align: center;">RECEIVING SHIP</p> <p>AT THE DIP: HAVE TEMPORARILY STOPPED TRANSFERRING.</p> <p>CLOSE UP: FUEL OR EXPLOSIVES ARE BEING TRANSFERRED.</p> <p>HAULED DOWN: DELIVERY IS COMPLETED.</p>

NOTE: AT NIGHT, ROMEO CLOSE-UP MUST BE SIGNALLED BY FLASHING LIGHT.

MNV70145

Figure 5-21.—Replenishment flaghoists.

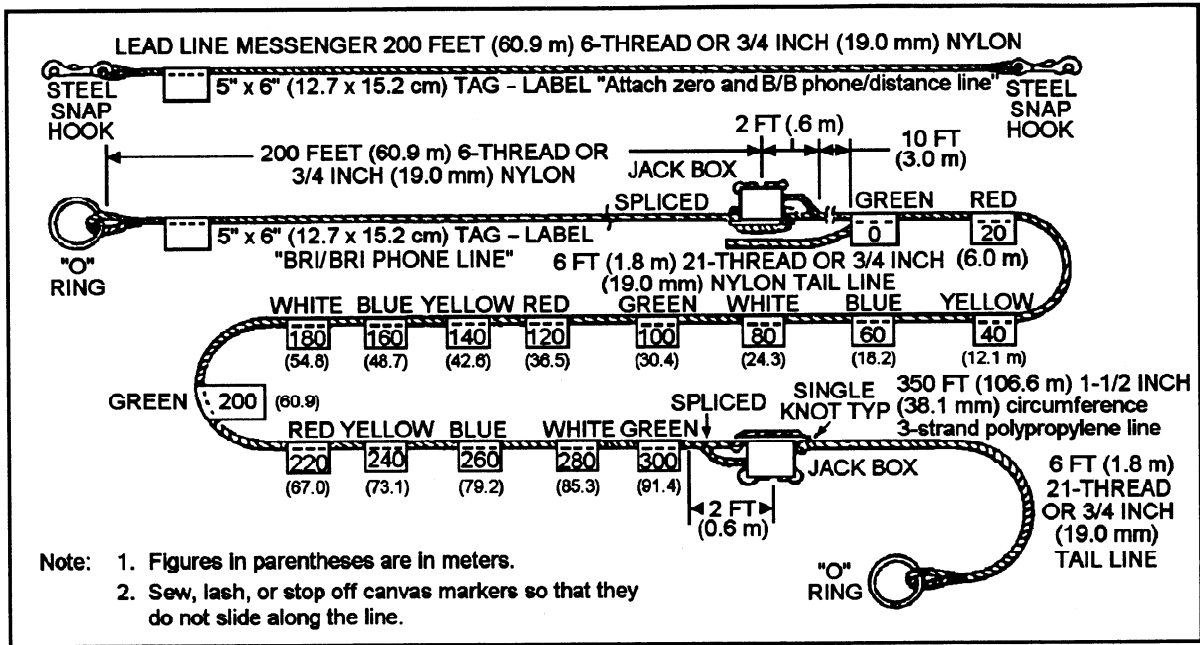

MNV70146

Figure 5-22.—Bridge-to-bridge (B/B) phone/distance line.

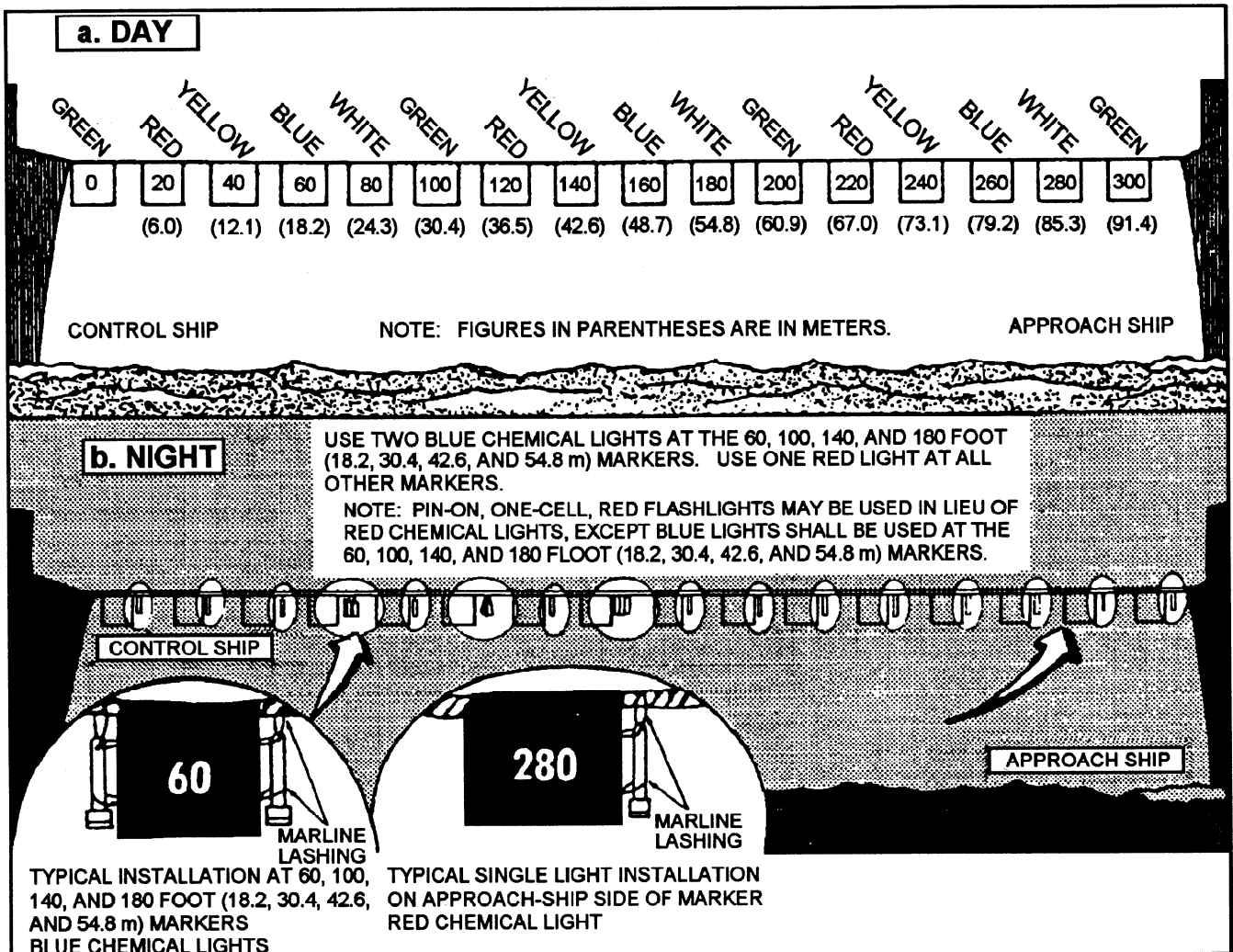

Figure 5-23.—B/B phone/distance line markings.







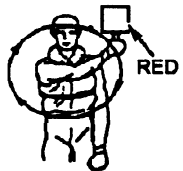

SIGNAL	SIGNAL	SIGNAL	REMARKS
<p>1</p>  <p>HEAVE AROUND</p>	<p>7</p>  <p>START BLOW THROUGH</p>	<p>13</p>  <p>REPLENISHMENT COMPLETED AT THIS STATION. COMMENCE UNRIGGING.</p>	<p>NOTE: RED AND AMBER PADDLES ARE SOLID COLOR. GREEN PADDLES WILL CONTAIN A 1 INCH WIDE WHITE DIAGONAL STRIPE RUNNING FROM UPPER LEFT TO LOWER RIGHT.</p> <p>DAY: COLORED PADDLES NIGHT: FLASHLIGHTS OR WANDS</p>
<p>2</p>  <p>AVAST</p>	<p>8</p>  <p>STOP BLOW THROUGH</p>	<p>14</p>  <p>PELICAN HOOK TO BE TRIPPED</p>	
<p>3</p>  <p>SLACK OFF</p>	<p>9</p>  <p>TEST S/P PHONE LINE</p>	<p>15</p>  <p>TRIP PELICAN HOOK</p>	
<p>4</p>  <p>HOOKED-UP OR CONNECTED</p>	<p>10</p>  <p>REPLACE S/P PHONE LINE</p>	<p>16</p>  <p>PREPARE FOR EMERGENCY BREAKAWAY</p>	
<p>5</p>  <p>START PUMPING OR COMMENCE TRANSFER</p>	<p>11</p>  <p>DETENSION</p>	<p>17</p>  <p>READY FOR BREAKAWAY</p>	
<p>6</p>  <p>STOP PUMPING OR CEASE TRANSFER</p>	<p>12</p>  <p>TENSION</p>	<p>18</p>  <p>EXECUTE BREAKAWAY</p>	

Figure 5-24.—Along side hand signals, standard procedures.

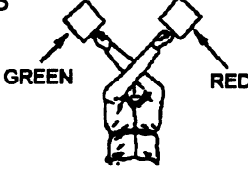
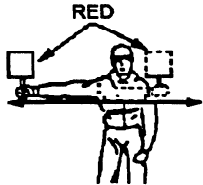
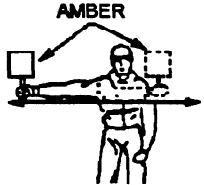
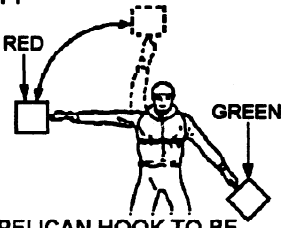
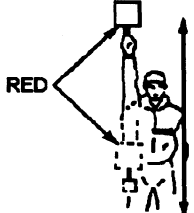
MNV70148

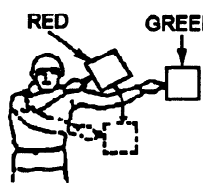
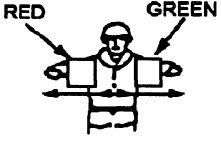
The zero end of the distance line (fig. 5-23) is secured at or near the outermost rail of the delivering ship, and the other end is hand tended on the receiving ship. Embedded in the polypropylene distance line are the conductors for the S/P telephone line, which provides the communication link between the bridges of the two ships.

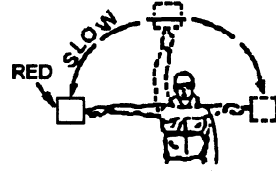
Each replenishment station has an S/P telephone line to the corresponding station on the other ship. Necessary commands are transmitted by S/P telephone, and a signalman also gives them by hand or light signals, as shown in figure 5-24. It is a good idea to post these hand signals at the replenishment stations or, better yet, to stencil them on the backs of the paddles.

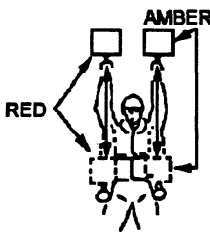
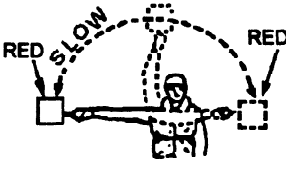
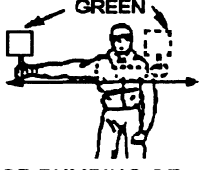
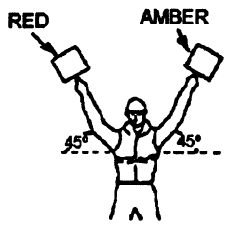
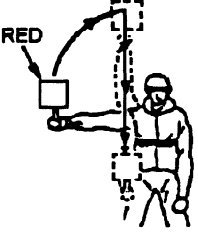
As the receiving ship completes its approach and steadies alongside, bolos or line-throwing gun lines are sent over from each station on the delivering ship to the opposite stations on the receiving ship. Telephone lines and messengers are sent over by means of these first lines.

MESSENGER

The messenger is the main line used to haul any basic rig between ships. See figure 5-25. The preferred location for handling the messenger and other lines is forward of the rig.

TRANSFER STATION MARKERS

Transfer station markers are (bunting, metal, or painted area markers for day, and red lights for night) to indicate the type of commodity that is to be transferred at the station. See figures 5-26 and 5-27.

FUELING AT SEA

Fueling at sea normally is conducted by using the span-wire method; the hose is carried between ships on a span wire, which may be tensioned or untensioned. Normally, the untensioned span wire is referred to as the

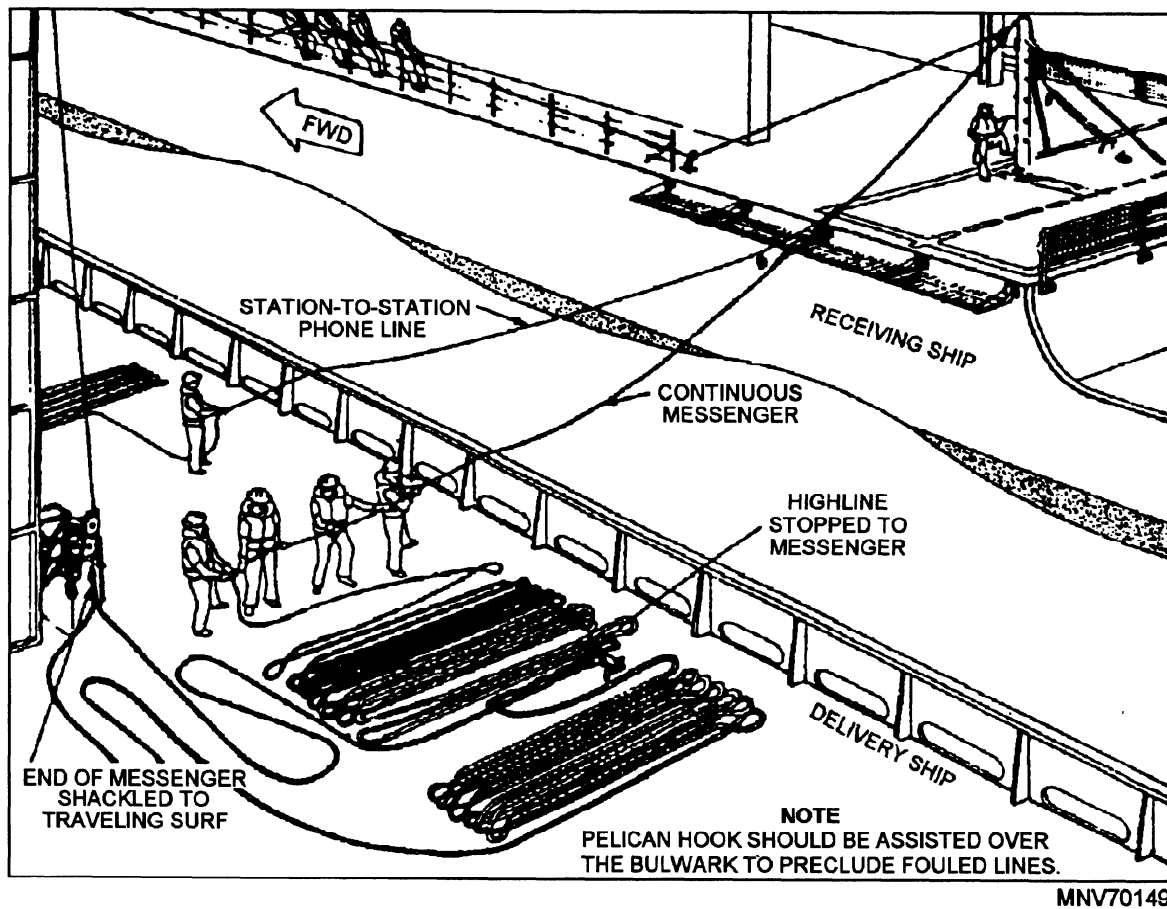



























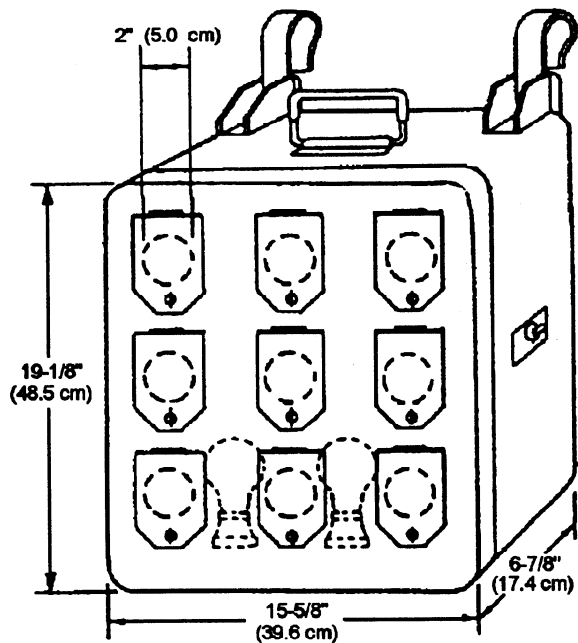

Figure 5-25.—Replenishment-at-sea messenger.

COMMODITY TRANSFERRED	CODE		
	DAY 3 ft ² (91.4 cm ²) BUNTING OR PAINTED AREA	NIGHT LIGHT BOX	
MISSILES	INTERNATIONAL ORANGE		
AMMUNITION	GREEN		
FUEL OIL	RED		
DIESEL OIL	BLUE		
F76	RED & BLUE TRIANGLES		
F44	YELLOW & BLUE TRIANGLES		
LUBE OIL	BLACK, YELLOW QUARTERS		
FEEDWATER	WHITE		
POTABLE WATER	WHITE WITH BLUE LETTER "P" CENTERED		
STORES	GREEN WITH WHITE VERTICAL STRIPES		
PERSONNEL AND/OR LIGHT FREIGHT	GREEN WITH WHITE LETTER "P" CENTERED		
FUEL OIL AND F44	RED/YELLOW & BLUE TRIANGLES		
F76 AND F44	RED/BLUE & YELLOW/BLUE TRIANGLES		
BRIDGE-TO-BRIDGE PHONE DISTANCE LINE	GREEN WITH WHITE LETTER "B" CENTERED		

MNV70150

Figure 5-26.—Transfer station markers.



BOX HAS NINE HOLES, EACH FITTED WITH A RED LENS. HAND-OPERATED INDIVIDUAL SHUTTERS HINGE UPWARD. ILLUMINATED BY TWO 25-WATT SHIELDED BULBS (ONE IS STAND-BY).
NSN 6230-00-658-3045.

MNV70151

Figure 5-27.—Station marker light box.

conventional span-wire rig (fig. 5-28). The tensioned span-wire method is referred to as STREAM. STREAM rigs are rigged with four saddles and a hose approximately 300 feet long (fig. 5-29). The hose hangs from trolley blocks that ride along the span wire. Saddle whips position the hose while the ship is being fueled and are used to retrieve the hose after the fueling operation is complete.

The span-wire rig permits ships to open out from 140 to 180 feet. Such distance is reasonably safe and makes it fairly easy to maneuver and keep station. These factors not only allow commanders a wider latitude in choosing a fueling course but also facilitate the use of anti-aircraft batteries, should the need for them arise. Additionally, the high suspension of the hose affords fair protection for it in rough weather.

CLOSE-IN METHOD

As we stated before, the close-in method of fueling is used when the delivering ship is not equipped with the span-wire rig or the receiving ship does not have a pad eye strong enough to hold a span wire.

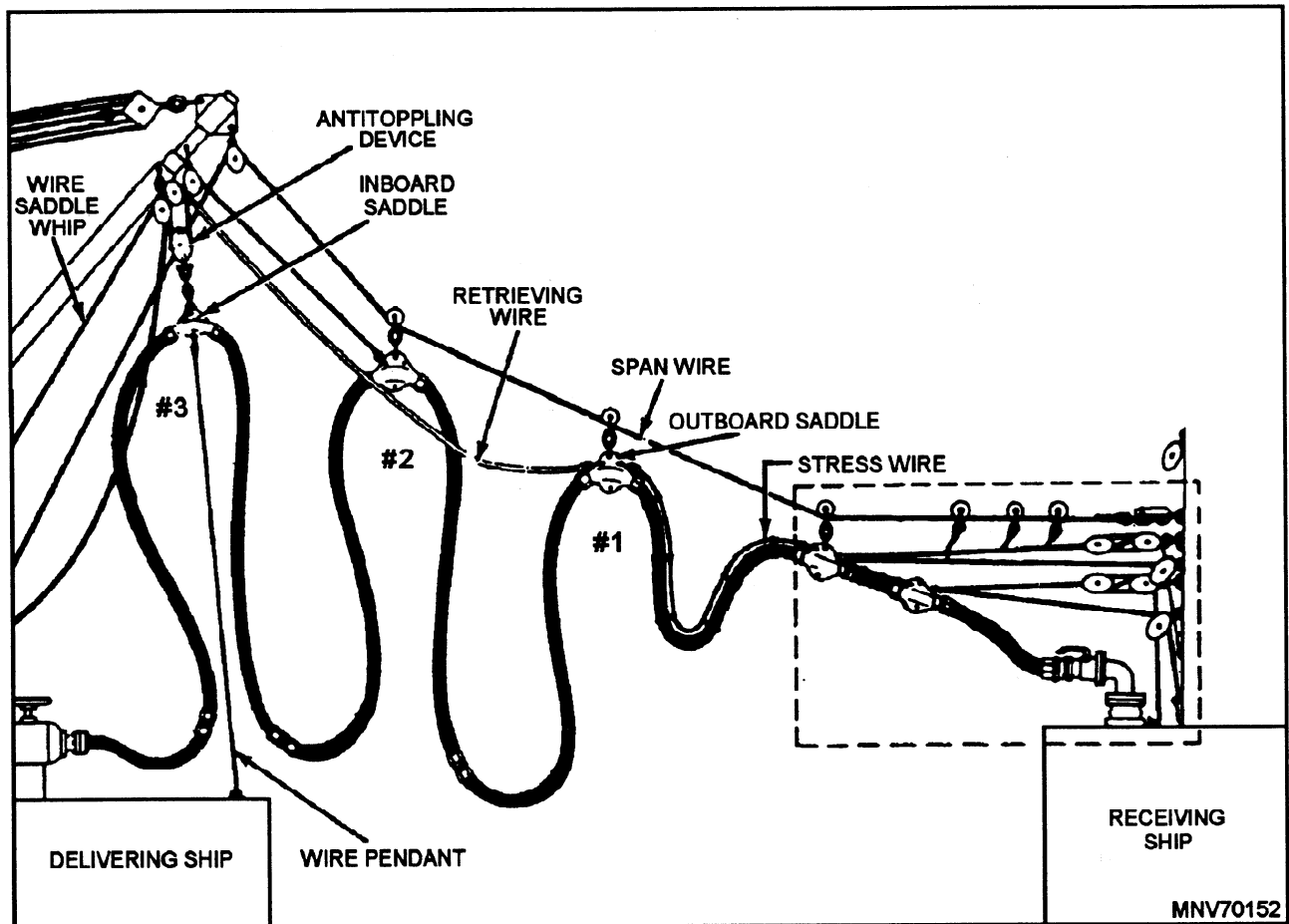

Figure 5-28.—Span-wire rig.

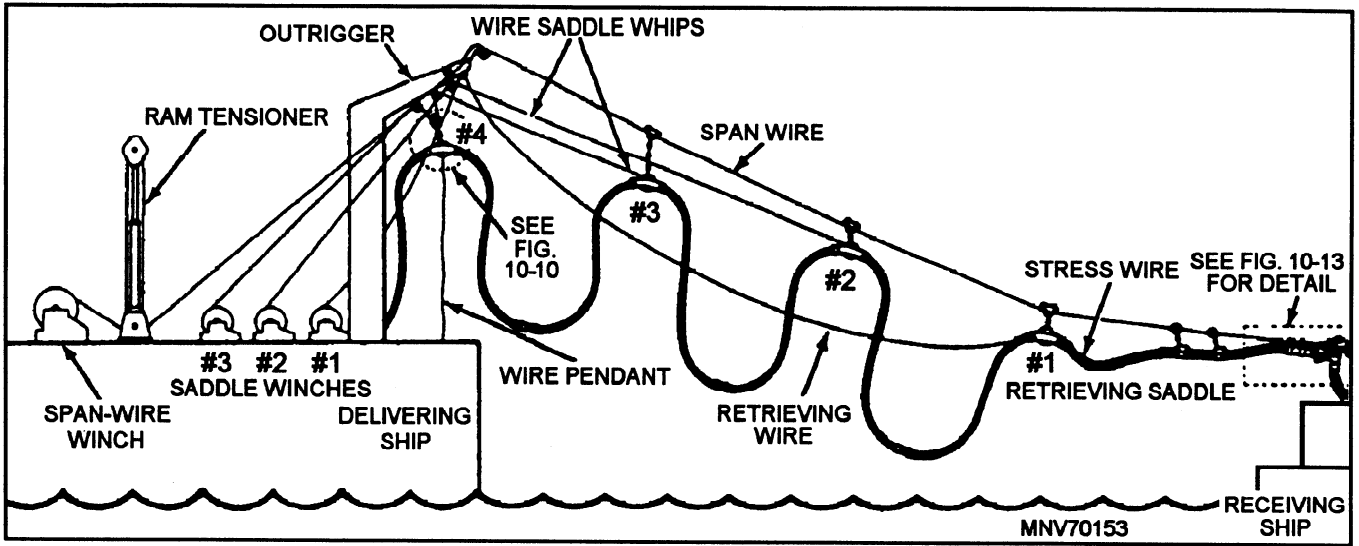

Figure 5-29.—Fuel STREAM.

In the close-in rig (fig. 5-30), the hose is supported by whips leading from the hose saddles to booms, king posts, or other high projections on the delivering ship.

REPLENISHMENT AT SEA

Various methods can be used to transfer provisions and stores between ships. Each has its advantages and disadvantages in relation to the size, structure, and

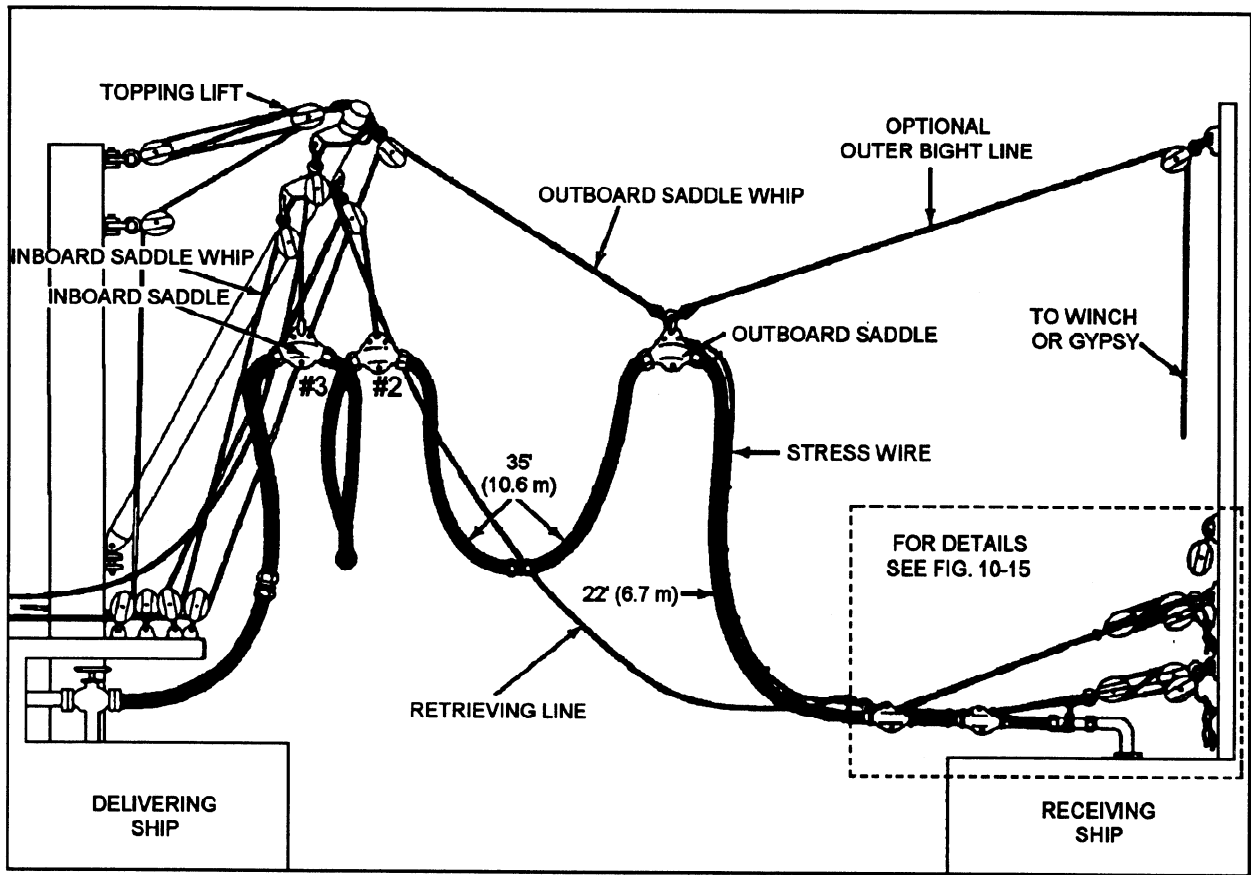

Figure 5-30.—Close-in rig.

rigging potential of the ships involved. The method to be used for a particular replenishment operation is usually selected on the basis of the following:

- Type and quantity of cargo to be transferred
- Capacity of the rig and associated fitting

- Weight and size of the heaviest or largest load
- Type and location of the receiving station

Conventional nontensioned methods of cargo transfer and their load capacities are found in NWP 14 (Series).

CHAPTER 6

BOAT SEAMANSHIP

LEARNING OBJECTIVES

Upon completing this chapter, you should be able to do the following:

1. Describe the boat davits used on MCM ships.
2. Describe the proper procedures for hoisting boats in and out of the water.
3. Explain how inflatable lifeboats operate and are maintained, and stowed.
4. Identify the flags in the flaghoist signaling system and explain how the system operates.
5. Describe the maritime buoyage systems and explain what each buoy means.
6. Describe the aids to navigation found in intercoastal waterways.
7. Describe the distress signals used by waterborne vessels.

INTRODUCTION

Every ship has on board some form of small boat that can be used for utility or emergency purposes. In this chapter, we discuss the boats carried on MCM ships. As part of that discussion, we also cover the flaghoist signaling system used to communicate between craft, and then discuss the aids to navigation used by both ships and boats.

NAVY BOATS

A Navy boat is an uncommissioned, waterborne unit of the fleet, not designated as a service craft, that is capable of limited independent operation. It may be assigned to and carried on a ship as a ship's boat or assigned to a shore station or fleet operating unit. The Navy boat on board MCM class ships is the rigid-hull inflatable boat (RIB).

Every Navy boat in active service must have a complete outfit of equipment. This equipment enables the boat, with its crew, to perform normal day-to-day functions and to weather minor emergencies. A copy the boat's outfit should be available to the boat coxswain. A good place to post the list is in the front of the boat log.

BOAT DAVITS

Basically, a davit is nothing more than a special crane designed for handling a boat in a safe and timely way.

The essential function of the davit arm is to swing the boat from its inboard position to a point outboard of the ship's side, from which the boat may be lowered; this process is reversed when the boat is hoisted. Hoisting operations are controlled by wire rope falls from which a hoisting hook is suspended.

SLEWING BOAT DAVIT

A slewing boat davit has a single arm mounted on a pedestal, which in turn is mounted to the ship. The arm rotates about the vertical axis of the pedestal to move the boat inboard and outboard. This electrically-powered boat davit design, commonly called a slewing arm davit (SLAD) (fig. 6-1), is used to handle rigid-hull inflatable boats (RIB) that are stowed on the deck of the ship next to the pedestal.

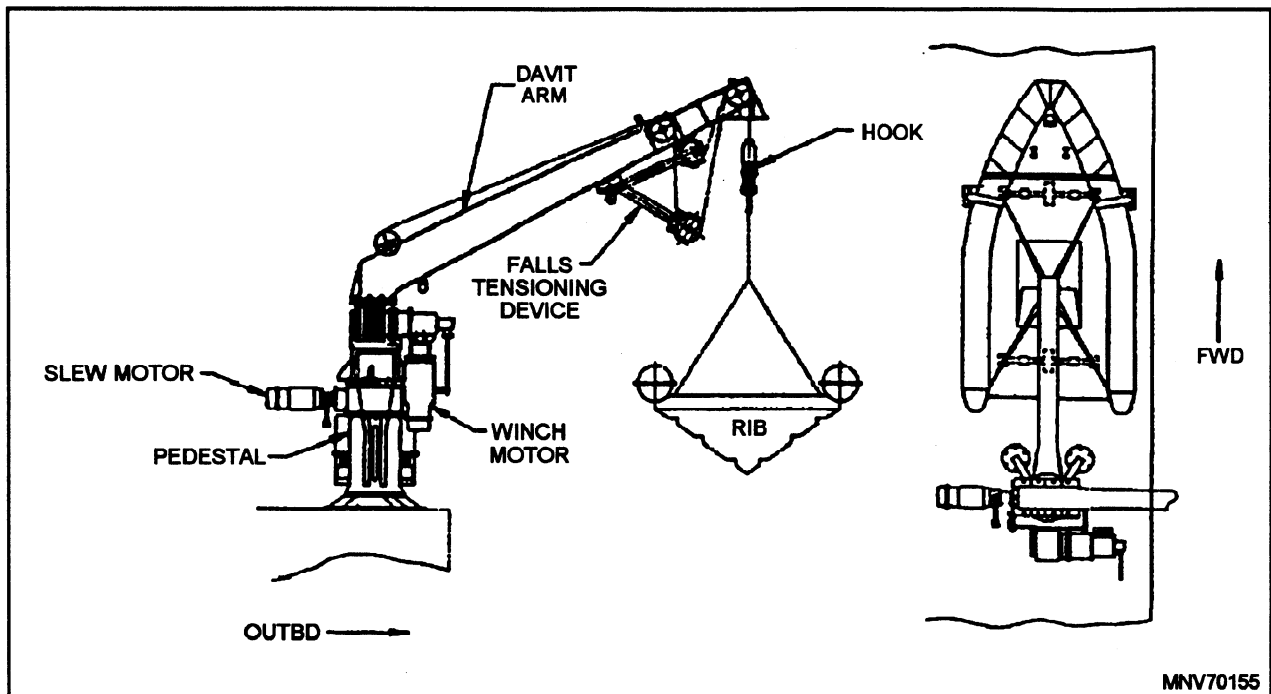

Figure 6-1.—Slewing arm davit (SLAD).

Standard Release Gear

On boat davits, the standard release gear used on the SLAD is the automatic release hook (fig.6-2).

Lowering Boats in Davits

The boat coxswain is responsible for making the boat ready and getting the crew into the boat. The

coxswain must make sure that all of the boat equipment is on hand. Everything must be rigged properly, and the fenders must be in place. The boat engineer checks the fuel and oil levels and tests the engine.

When the PO in charge of the lowering detail is satisfied that all is correct and the bridge gives permission to lower the boat, the operation can begin.

All personnel in the boat should wear an inherently buoyant life jacket and hard hat. In addition, they should keep a monkey line or life line in hand for safety during lowering and hoisting operations.

During lowering, the monkey lines should hang over and inboard, between the ship and the boat. This will prevent the lines from being fouled around an object or structure of the boat and will keep them clear of the boat once it is in the water.

When the boat is just clear of the water—that is, out enough that it is not slapped around by a wave—the lowering should be stopped and the engine started. This will give the boat maneuverability once it is waterborne. With the engine in operation, the boat can be lowered to the water.

Once the boat is waterborne, at the order “Cast off aft,” the after fall is released. At the order “Cast off forward,” the forward fall is released. The falls are pulled clear of the boat by the frapping lines. The boat is

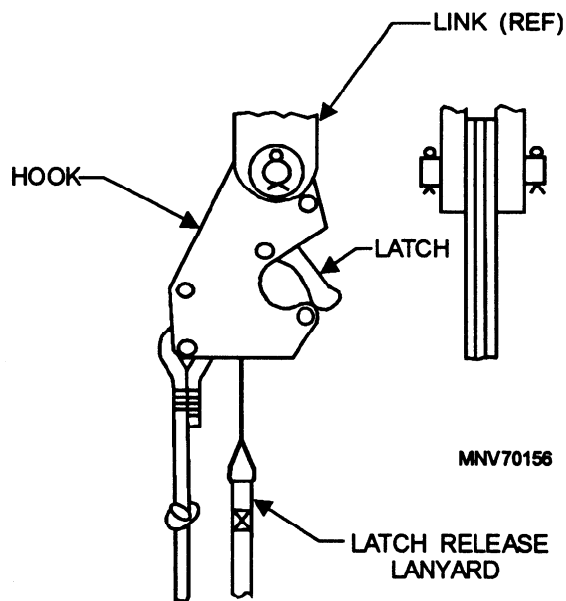

Figure 6-2.—Automatic releasing safety hook.

now riding to the sea painter (bow line), and the boat crew will cast off first the after and then the forward steadying lines. When the boat gains headway, they cast off the sea painter and the boat is free.

Hoisting Boats by Davits

The procedure for hoisting a boat by davits is the reverse of the lowering operation. The personnel on deck should have everything ready in advance. The davits are swung out, and the boat falls and monkey lines are lowered and held to the ship by frapping lines. Fenders are rigged, and the handling equipment is energized and tested

The ship should provide a lee for the approaching boat; that is, the ship should move ahead slowly in a direction to protect the boat from the sea and the wind.

As the boat comes alongside, the sea painter is passed to the boat and secured over the forward inboard cleat. As the boat rides back on the sea painter, the boat falls and monkey lines are eased out to the boat. The forward fall is secured first, then the after fall. When all is hooked up and secured, the crew on deck takes the slack out of the falls, hoists the boat aboard and secures it. Davits should be stopped at the weather deck to disembark the boat crew.

INFLATABLE LIFEBOATS

Experience from disasters and experiments conducted under different conditions have proven that personnel who abandon ship in water below 70°F must be kept entirely out of the water and protected from the elements if they are to survive.

Navy ships have inflatable lifeboats installed on board that not only keep surviving personnel out of the sea, but also have canopies to provide shelter from the elements. As with many safety items, we tend to accept

them as just another fixture installed on board. Unfortunately, improper installation and maintenance have accidentally launched some inflatable boats or, worse, made them useless when needed.

STANDARD ALLOWANCE

The standard shipboard allowance of inflatable lifeboats is whatever number will provide room for 100 percent of the ship's crew. The issue of inflatable lifeboats is determined and approved by NAVSEA.

TYPES OF INFLATABLE LIFEBOATS

The Navy has successfully used many types of rigid and inflatable lifeboats throughout the years. Today, Navy ships have either Mk 5 Mod 2, 15-person or Mk 6, 25-person encapsulated lifeboats on board. These lifeboats come packed in rigid fiber glass containers, with survival gear and rations packed inside the lifeboat. The containers are stowed in cradles or racks designed to accommodate them aboard ship.

CHARACTERISTICS OF INFLATABLE LIFEBOATS

The Mk 5 Mod 2 and Mk 6 inflatable lifeboats are designed for compact stowage aboard ship and for quick inflation if it becomes necessary to abandon ship. A few characteristics of these boats are shown in table 6-1. The lifeboats may be inflated by pulling on the sea painter (length, 100 ft), which extends through the opening at one end of the container. The sea painter is faked into a tube inside the carrying case; the entire length must be pulled out of the container to activate the inflation valves.

Each lifeboat has a double-layered canopy with boarding openings at each end. The openings are fitted with closures that may be closed as desired. An air

Table 6-1.—Characteristics of Inflatable Lifeboats

BOAT TYPE	CAPACITY	WEIGHT (lbs)	DIMENSIONS-INFLATED		DIMENSIONS-CASE/CONTAINER		
			L	W	H	W	L
Mk 5 Mod 2	15 persons	450	15'81"	7'4"	27"	dia	56"
					Rigid Container		
Mk 6	25 persons	515	17'9-3/4"	8'10-1/21"	27"	dia	56"
					Rigid Container		

space (about 3 1/2 inches) between the two layers of canopy fabric provides insulation against extremes of heat and cold.

A raincatcher tube for collecting rainwater is installed in the top of the canopy, near the center of the lifeboat. The lower end can be tied off to allow water to accumulate in it. Two plastic bags for collecting and storing water are provided in the survival equipment.

Life lines are provided around the inner and outer circumference of the boat. The outside line is intended to be an aid to boarding; the inside line is for survivors to use for support during heavy weather.

A righting line, knotted at 12-inch intervals, is attached to the bottom of the raft and can be used to right the lifeboat should it inflate upside down or be capsized from wave and wind action.

Rope ladders, located at each end of the lifeboat, are used for boarding.

LAUNCHING PROCEDURES

The Mk 5 Mod 2 and Mk 6 boats can be launched in either of two ways. They can be manually placed overboard or, if they are left on a sinking ship, they will automatically launch themselves.

Automatic Launching

If the ship should sink before the boats can be launched manually, the boats will sink with the ship to a depth of between 10 and 40 feet. At some point within these depths, water pressure will automatically activate the hydrostatic release, allowing the boats to float to the surface. For boats stowed in rigid containers, one end of the sea painter is attached to the cylinder valve actuating cables. The other end is attached to the lifeboat stowage point. As the ship continues down, the painter will pay out to its full length, creating a pulling force on the cylinder valve activating cables, releasing the compressed air into the boat and inflating it automatically. The painter has a predetermined breaking strength, less than the buoyancy of the boat, that allows it to break once the lifeboat has surfaced.

Manual Release Launch

If an abandon ship situation occurs and there is sufficient time to release the boats, you can trip the hydrostatic release manually by hitting its release button with the heel of your hand. After you clear away the stowage straps, push or roll the boat overboard.

Then pull the painter, actuating the cylinder valves and inflating the boat.

NOTE

The survival gear for boats packed in rigid containers is packed in the lifeboat, where it is immediately available when the lifeboat is inflated.

Inflation

The boat has the latest in improved inflation systems. The compressed air cylinder, under high pressure, ensures rapid (20 to 30 seconds) inflation at temperatures as low as -20°F. At high ambient temperatures, the compressed air system creates a somewhat higher than normal pressure in the hull tubes. This pressure is relieved by the pressure relief valves installed in each of the tube compartments. These valves will relieve at 3.5 psi and close automatically at 2.6 psi.

The boat, after initial inflation, will be quite firm. Cooler air temperatures will cause the boat tubes to soften. This is normal. As the sun causes the temperatures to rise during the day, the heat causes the tubes to firm up again. Use the hand pumps packed in the boat to “top off” the boat to normal pressure when required.

Inflate the inflatable floors and cross tubes by means of the hand pumps as soon as possible after you board the lifeboat, as they provide insulation against the colder water temperature.

Stowage

The standard Navy lifeboat container is stowed on a cradle that has a H-degree lip on its outboard side. (See fig. 6-3.) The purpose of this lip is to prevent the lifeboat from falling out of its cradle if the hydrostatic release is accidentally tripped

Securing Harness

The lifeboat is held securely in its stowage by three assemblies in one. These are (1) a hydrostatic release mechanism, (2) a plastic-coated wire-rope harness, and (3) a 1/4-inch-diameter double braided nylon cord. The 1/4-inch nylon cord is provided as an emergency means of launching the lifeboat in case the hydrostatic release device is frozen or inoperative. No substitution for the nylon cord is authorized. It is attached to the shackle on the hydrostatic release device by a bowline.

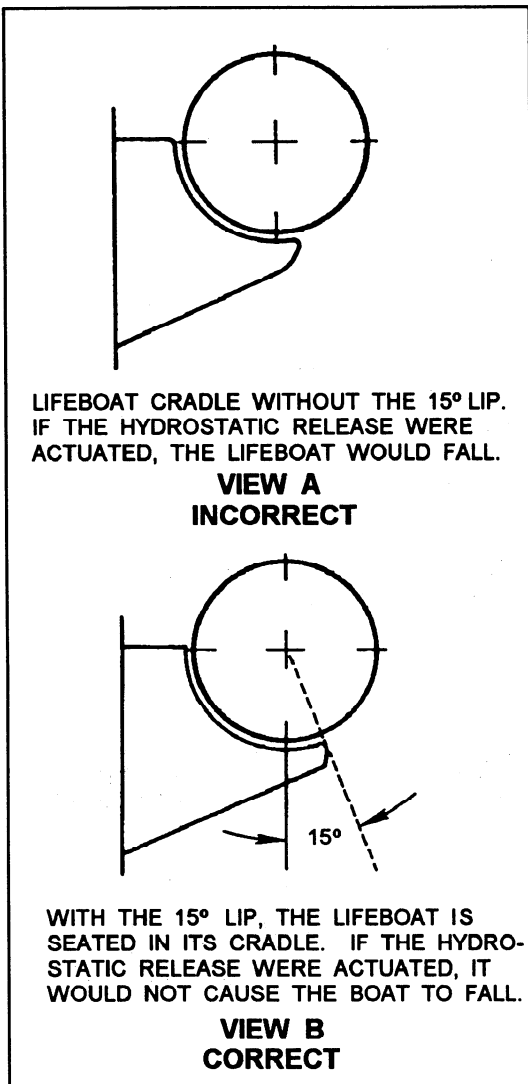

Figure 6-3.—15-degree lip on cradle.

The bitter end is passed through the thimble of the wire-rope harness, then back through the shackle five turns, and secured with a clove hitch and two half hitches. In an emergency, if the gear fails to work as designed, the nylon cord can be cut easily with a knife. Figure 6-4 shows a properly secured lifeboat.

Painter Line

The painter line for automatic launching of encapsulated lifeboats is 100 feet long and is faked inside the container to actuate the air inflation bottles. If you are directed to secure the painter line to the ship, use the following five-step procedure:

1. Remove the painter cork from the lifeboat container grommet.

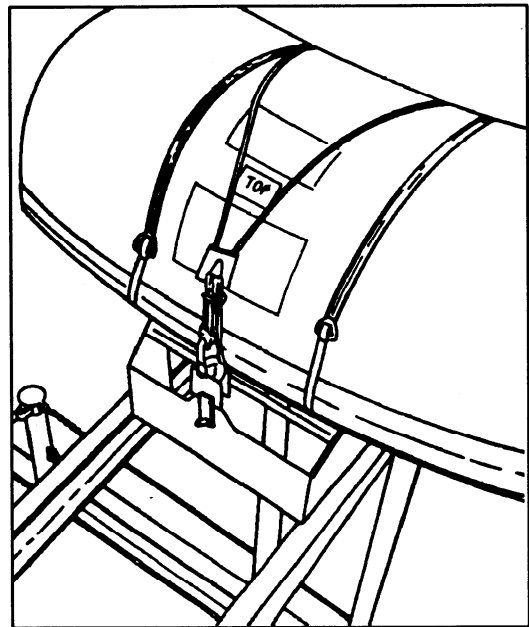

THIS LIFEBOAT IS PROPERLY SECURED WITH THE 1/4 - INCH NYLON CORD INSTALLED.

MNV70158

Figure 6-4.—Properly secured lifeboat.

2. Determine the length required for the painter to reach from the lifeboat to where it will be fastened to the ship's structure.



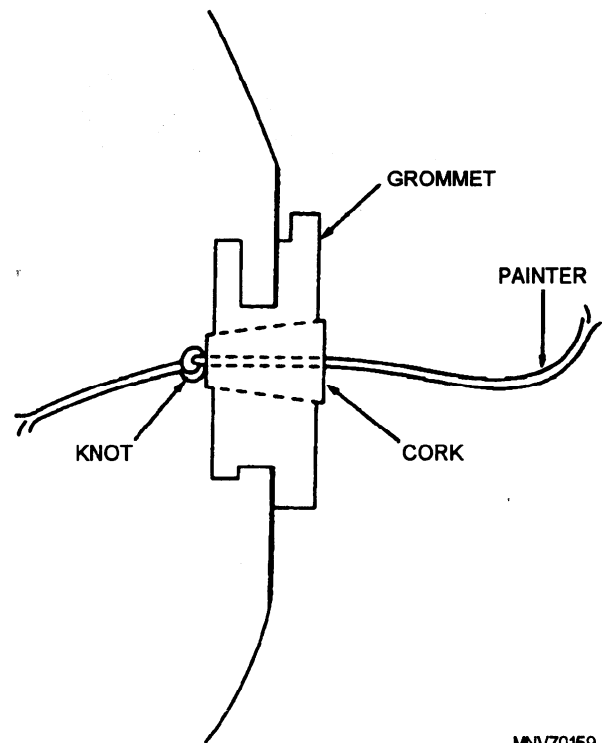







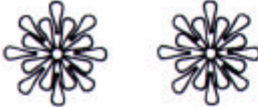





3. Tie an overhand knot in the painter line at the point determined above and immediately on the inside of the container next to the cork. (See fig. 6-5.)



MNV70159

Figure 6-5.—Container grommet (Mk 5 Mod 2 and Mk 6).

THIS PAGE MUST BE PRINTED ON A COLOR PRINTER.

FLAG OR BLINKER	SHIP-TO-BOAT SIGNALS		MEANING
	FLAG OR BLINKER	PYROTECHNIC FLARE	
			STEADY ON PRESENT COURSE.
	(EIGHT)		STEER STRAIGHT AWAY FROM THE SHIP.
	(EIGHT)		STEER LEFT. WHEN HAULED DOWN, CEASE TURN AND STEADY ON PRESENT COURSE.
	(PORT)		
	(EIGHT)		STEER RIGHT. WHEN HAULED DOWN, CEASE TURN AND STEADY ON PRESENT COURSE.
	(STARBOARD)		
	(EIGHT)		STEER STRAIGHT TOWARD THE SHIP.
	(SCREEN)		
	(QUEBEC)		RETURN TO THE SHIP.
	BOAT-TO-SHIP SIGNALS		
			CANNOT FIND THE MAN.
BLINKER OR SEMAPHORE			HAVE RECOVERED THE MAN.
			NEED ASSISTANCE.

MNV70160

Figure 6-6.—Man overboard/pilot rescue signals.

4. Reinstall the cork securely into the grommet.
5. Fasten the painter securely to the ship's structure at a point accessible to the person launching the lifeboat.

LIFEBOATS AND SIGNALS

JCS Pub 2, *Unified Action Armed Forces* requires that a ship at sea have at least one boat rigged and ready for use as a lifeboat. Your ship's boat bill will specify the exact condition of the lifeboat and the items of equipment that must be in it. On MCM class ships, the rigid-hull inflatable boat is used as the lifeboat.

At the beginning of each watch, the lifeboat coxswain will muster the crew, check the boat and gear, have the engine tested, and report to the officer of the deck.

Every crew member must know lifeboat recovery procedures, in case someone goes overboard. Quick recovery is particularly important in cold water, in which a victim can live only a few minutes.

Once a lifeboat is in the water, it will be directed to the victim, but the victim's position relative to the ship will probably have changed before the lifeboat gets there. To help direct the boat to the victim, a simple system of signals is used.

During the day, directions are given by flags hoisted where they can be seen best; at night, directions are given by flashing light or pyrotechnics. Figure 6-6 shows the flaghoist, flashing light, and pyrotechnic signals and their meanings. At night, pyrotechnics fired by the Mk 5 pyrotechnic pistol may also be used to direct the boat.

The boat should approach from downwind, to keep from being blown over the victim. The last part of the approach should be made with the engine stopped, with the recovery attempt made at the bow. If possible, the coxswain should try to avoid having the screw turning in the vicinity of the victim.

FLAGHOIST SIGNALING

Flaghoist signaling provides a rapid and accurate system for sending maneuvering and information signals of reasonable length, during daylight, between ships within sight of each other. Of all visual signals, a flaghoist signal tends to ensure the most uniform execution of a maneuver.

For signaling by flaghoist, the Navy uses the international alphabet flags and numeral pennants and,

in addition, a set of numeral and special meaning flags and pennants.

PARTS OF A FLAG

Figure 6-7 shows the various types of flags and their parts.

- The FLY is the length of the flag, measured from the staff to the flag's outside edge.
- The HOIST is the vertical width of the flag when it is flying free.
- The TABLING is the double thickness of bunting-taped, bound, and stitched-at the staff side of a flag.
- The TAIL LINE, carrying the snap hook, is a short length of halyard attached to the lower part of the tabling. It serves as a spacer, separating the flags of a hoist to make reading the signals easier.
- The RING is attached to the top of the tabling and snaps into the tail line of the preceding flag or hook of the halyard.
- The TACKLINE is a 6-foot length of braided signal halyard with a ring at one end and a snap hook at the other. The tackline is used to separate signals or groups of numerals that if not

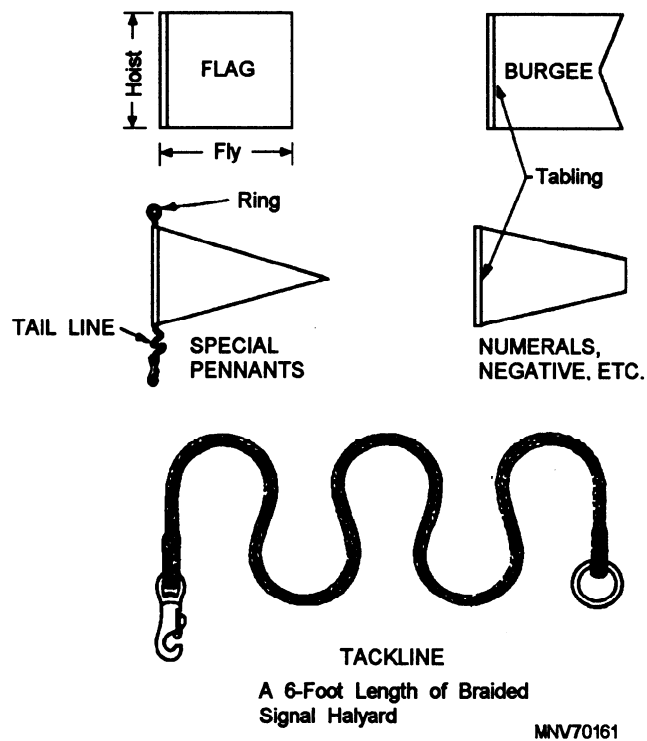

Figure 6-7.—Parts of a flag.

separated could convey a meaning different from the intended meaning.

HOW TO READ FLAGHOISTS

The flags of a hoist are always read from the top down. When a signal is too long to fit on one halyard—when, in other words, it requires more flags than can be made into a single hoist—the signal must be continued on another halyard. When a signal is broken into two or more hoists, it must be divided at points where there can be a natural space without affecting the meaning of the signal.

A complete signal or group of signals—whether on one hoist or on two or more adjacent hoists flying at the same time—is called a *display*. When displays of more than one hoist are raised, the separate hoists are run up, one by one, in the correct order. Do not try to run them up simultaneously.

As a general rule, a signal too long to be shown completely on three halyards is made into two or more displays. When two or more displays are used, the heading must be hoisted on a separate halyard and kept flying while successive displays are made.

When two or more hoists are flying, they are read from outboard in or from forward to aft. Figure 6-8 shows how to read a three-hoist display from the top down and from outboard in.

Flags may also be hoisted at the triatic stay. This is a line extending from the foremast to a stack or another mast. Such signals are read from forward to aft. A triatic stay is shown in figure 6-9. This illustration also shows hoists at two positions on a yardarm.

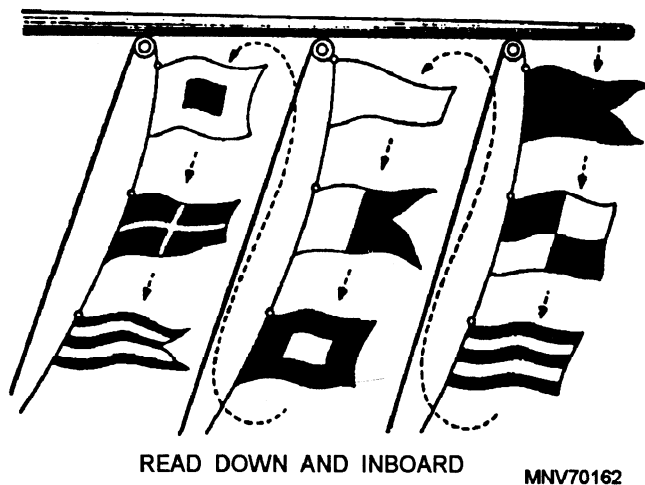

Figure 6-8.—Reading flaghoists

Signals hoisted at yardarms of different heights are read beginning at the highest yardarm. When several hoists are displayed simultaneously from different points, they are read in the following order: (1) masthead, (2) triatic stay, (3) starboard yardarm, and (4) port yardarm.

Terms used to describe the status of flaghoists are as follows:

- Close-up: A hoist is *close-up* when its top is touching the block at the point of hoist—that is, when the hoist is up as far as it will go.
- At the dip: A hoist is *at the dip* (or dipped) when it is hoisted three-fourths of the way up toward the point of hoist.
- Hauled down: A hoist is *hauled down* when it is returned to the deck.
- Superior position: Any hoist or portion of a hoist that is to be read before another hoist or portion of a hoist is said to be in a *superior position*.

FLAGS AND PENNANTS

Since flaghoist signaling is such a common method of sending signals, you must learn all of the flags and pennants well enough to recognize any one of them. (See figs. 6-10 and 6-11.)

Memory aids are a big help in learning the flags. For example: CHARLIE, TANGO, and WHISKEY are the only flags that are *red*, *white*, and *blue*. You could also think of them as WTC—watertight compartment.

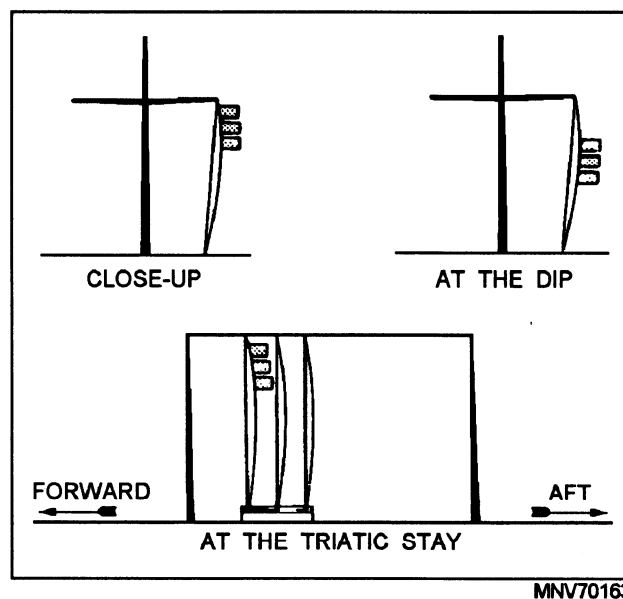

Figure 6-9.—Flaghoist positions.

FLAG and NAME	Spoken	Written	FLAG and NAME	Spoken	Written	FLAG and NAME	Spoken	Written
 A	ALFA	A	 M	MIKE	M	 Y	YANKEE	Y
 B	BRAVO	B	 N	NOVEMBER	N	 Z	ZULU	Z
 C	CHARLIE	C	 O	OSCAR	O	 1	ONE	1
 D	DELTA	D	 P	PAPA	P	 2	TWO	2
 E	ECHO	E	 Q	QUEBEC	Q	 3	THREE	3
 F	FOXTROT	F	 R	ROMEO	R	 4	FOUR	4
 G	GOLF	G	 S	SIERRA	S	 5	FIVE	5
 H	HOTEL	H	 T	TANGO	T	 6	SIX	6
 I	INDIA	I	 U	UNIFORM	U	 7	SEVEN	7
 J	JULIETT	J	 V	VICTOR	V	 8	EIGHT	8
 K	KILO	K	 W	WHISKEY	W	 9	NINE	9
 L	LIMA	L	 X	XRAY	X	 0	ZERO	0

Figure 6-10.—Alphabet and numeral flags.

THIS PAGE MUST BE PRINTED ON A COLOR PRINTER.

PENNANT and NAME	Spoken	Written	PENNANT or FLAG	Spoken	Written	PENNANT or FLAG	Spoken	Written
 1	PENNANT ONE	p1	 CODE or ANSWER	CODE or ANSWER	CODE or ANS	 NEGATIVE	NEGAT	NEGAT
 2	PENNANT TWO	p2	 SCREEN	SCREEN	SCREEN	 PREPARATIVE	PREP	PREP
 3	PENNANT THREE	p3	 CORPEN	CORPEN	CORPEN	 PORT	PORT	PORT
 4	PENNANT FOUR	p4	 DESIGNATION	DESIG	DESIG	 SPEED	SPEED	SPEED
 5	PENNANT FIVE	p5	 DIVISION	DIV	DIV	 SQUADRON	SQUAD	SQUAD
 6	PENNANT SIX	p6	 EMERGENCY	EMERGENCY	EMERG	 STARBOARD	STARBOARD	STBD
 7	PENNANT SEVEN	p7	 FLOTILLA	FLOT	FLOT	 STATION	STATION	STATION
 8	PENNANT EIGHT	p8	 FORMATION	FORMATION	FORM	 SUBDIVISION	SUBDIV	SUBDIV
 9	PENNANT NINE	p9	 INTER-ROGATIVE	INTER-ROGATIVE	INT	 TURN	TURN	TURN
 0	PENNANT ZERO	p0						
TACK LINE	TACK	—						

SUBSTITUTES					
 1st. SUBSTITUTE	FIRST SUB	1st.	 3rd. SUBSTITUTE	THIRD SUB	3rd.
 2nd. SUBSTITUTE	SECOND SUB	2nd.	 4th. SUBSTITUTE	FOURTH SUB	4th.

Figure 6-11.—Numeral pennants; special flags and pennants.

THIS PAGE MUST BE PRINTED ON A COLOR PRINTER.

CHARLIE has horizontal stripes—a berthing compartment has tiers of horizontal bunks. Anything watertight is completely enclosed—the blue square of WHISKEY completely encloses the white square, which completely encloses the red square. That leaves TANGO, the flag with the vertical stripes. You could also remember TANGO as being similar to the flag of France (the stripes are in reverse order). You can make up any number of such things to jog your memory. They do not have to be logical. Often, the more exaggerated or silly they are, the easier they are to remember. Here’s an example: “Gee, what a lot of stripes,” for GOLF.

The numbered flags are easy. From 1 through 9, the basic colors, red, yellow, and blue, are repeated in that order. The first three have horizontal stripes, the next three have diagonal stripes, and 7, 8, and 9 have vertical stripes. Take one good look at zero. You are not apt to forget it.

Numeral flags are used along with alphabet flags and special pennants in flag signals, but numeral pennants are used only in call signs. The special flags and pennants are used in tactical maneuvers to direct changes in position, speed, formation, and course; to indicate units; and to designate specific units.

SUBSTITUTES

Substitutes are used to prevent alphabet flags, numeral flags, or numeral pennants from appearing more than once in the same hoist. They are what their name implies—substitutes for other flags or pennants already used in the hoist.

- FIRST SUBSTITUTE repeats the first flag or pennant in the hoist.
- SECOND SUBSTITUTE repeats the second flag or pennant in the hoist.
- THIRD SUBSTITUTE repeats the third flag or pennant in the hoist.
- FOURTH SUBSTITUTE repeats the fourth flag or pennant in the hoist.

If you wanted to send the signal CHARLIE BRAVO BRAVO CHARLIE, it would read from the top down:

CHARLIE

BRAVO

SECOND SUBSTITUTE

FIRST SUBSTITUTE

The FIRST SUBSTITUTE has repeated the first flag in the hoist, and the SECOND SUBSTITUTE has repeated the second flag in the hoist.

Substitutes are not used to repeat other substitutes, but they can repeat the flag that a substitute represents. The tackline is not repeated. Therefore, when you count to determine which flag the substitute represents, do not include the tackline in the count.

Substitutes are also used as absentee pennants when a ship is not under way. They are flown from sunrise to sunset on the yardarms of the mainmast and indicate the absence of embarked officers and officials for less than 72 hours.

The FIRST SUBSTITUTE flown outboard at the starboard yardarm indicates the absence of the flag officer or unit commander whose flag or pennant is flying on the ship.

The SECOND SUBSTITUTE is the chief of staff’s absentee pennant and is flown inboard at the port yardarm. When displayed with the THIRD SUBSTITUTE, it must be inboard.

The THIRD SUBSTITUTE is the captain’s absentee pennant. It is flown outboard from the port yardarm. If the captain is absent over 72 hours, this pennant indicates the absence of the executive officer.

The FOURTH SUBSTITUTE indicates the absence of the civil or military official whose flag is flying on the ship. It flies from the inboard starboard yardarm. When displayed with the first substitute, it must be inboard.

NOTE

In the absence of a commanding officer who is acting as a temporary unit commander, both absentee pennants are displayed.

SINGLE FLAGS

Many one-flag signals are used in the Navy. Small vessels, which do not maintain a constant signal watch while in port, frequently rely on the Petty Officer of the Watch to recognize some of these signals or to rouse out a QM or SM when needed. Of course, INDIA flying at the dip on an approaching vessel requires breaking out deckhands, not a Signalman, because INDIA shows that the ship is coming alongside. Every sailor should know at least the few signals listed here. (Except where noted, these signals are flown where best seen.)

- **ALFA:** Divers or underwater demolition personnel are down. If a numeral group follows ALFA, the numbers indicate in hundreds of yards the radius within which the personnel are working.
- **BRAVO:** The BRAVO flag is hoisted whenever vessels are transferring fuel or explosives. During gunnery practice, it is flown on the appropriate side. It is also required in a boat (in the bow or where best seen) transporting fuel or explosives. While BRAVO flies, the smoking lamp is out.
- **INDIA:** In port, INDIA at the dip on an approaching ship indicates that it is preparing to come alongside. When the flag is hauled close up, it is ready to come alongside. INDIA is displayed on the side that the evolution is to take place. The receiving ship also flies INDIA on the appropriate side, at the dip to show it is making preparations, and close up to show it is ready to receive the approaching vessel. When the first line is secured, INDIA is hauled down on both ships. At sea, ROMEO serves as this signal.
- **JULIETT:** Your ship's call followed by JULIETT displayed on another ship indicates that the other ship has a semaphore message for your ship. JULIETT followed by DESIG indicates a priority message. The hoist remains flying during transmission and is hauled down when the message has been sent.
- **MIKE:** The ship having medical guard duty flies MIKE.
- **OSCAR:** OSCAR indicates man overboard and is made up ready to break.
- **PAPA:** PAPA calls all personnel attached to that ship to return to the ship.
- **QUEBEC:** QUEBEC is the boat recall. When flying alone, it orders all boats to return immediately. QUEBEC plus one or more numeral pennants recalls the boat addressed.
- **ROMEO:** In port, ROMEO is flown by the ship having the ready duty. At sea, it is flown by ships preparing for and ready for replenishing. It is hauled down when the fast messenger is in hand (alongside method) or when the hose is in hand (astern method).
- **SIERRA:** SIERRA is flown while a ship is holding signal drill.
- **YANKEE:** In port, YANKEE is flown by the ship with the visual communications duty.
- **EIGHT flag:** The EIGHT flag is used when a boat is being directed by a ship during man overboard. The EIGHT flag hoisted alone means steer straight away from the ship. The EIGHT flag hoisted with the port or starboard flag means steer to the left (or right). The EIGHT flag hoisted with SCREEN (BLACK PENNANT) means steer straight to the ship.
- **FIVE flag:** The FIVE flag is the breakdown flag and is usually carried at the foretruck and made up ready to break. Every sailor should be able to recognize and know the meaning of the FIVE flag and the OSCAR. Both flags are always carried ready to break.

You will need practice if you are to remember the flags and pennants. Probably the best time to practice reading hoists is during slack periods while standing watches. During these periods, there usually will be a Signaller nearby who can check you. You will soon become quite proficient at reading flags and will learn the meanings of many maneuvering and other signals.

UNITED STATES STORM-WARNING SIGNALS

The combinations of flags and pennants shown in figure 6-12 are hoisted at the National Weather Service and other shore stations in the United States to indicate existing or predicted unfavorable winds. The meanings of the various displays are as follows:

- **Small-craft warning:** One red pennant displayed by day or a red light over a white light at night indicates that winds up to 38 miles an hour (33 knots) and/or sea conditions dangerous to small-craft operations are forecast for the area.
- **Gale warning:** Two red pennants displayed by day or a white light above a red light at night indicates that winds ranging from 39 to 54 miles an hour (34 to 47 knots) are forecast for the area.
- **Storm warning:** A single red flag with a black square center displayed by day or two red lights at night indicates that winds 55 miles an hour (48 knots) or above are forecast for the area. If the winds are associated with a tropical cyclone

THIS PAGE MUST BE PRINTED ON A COLOR PRINTER.

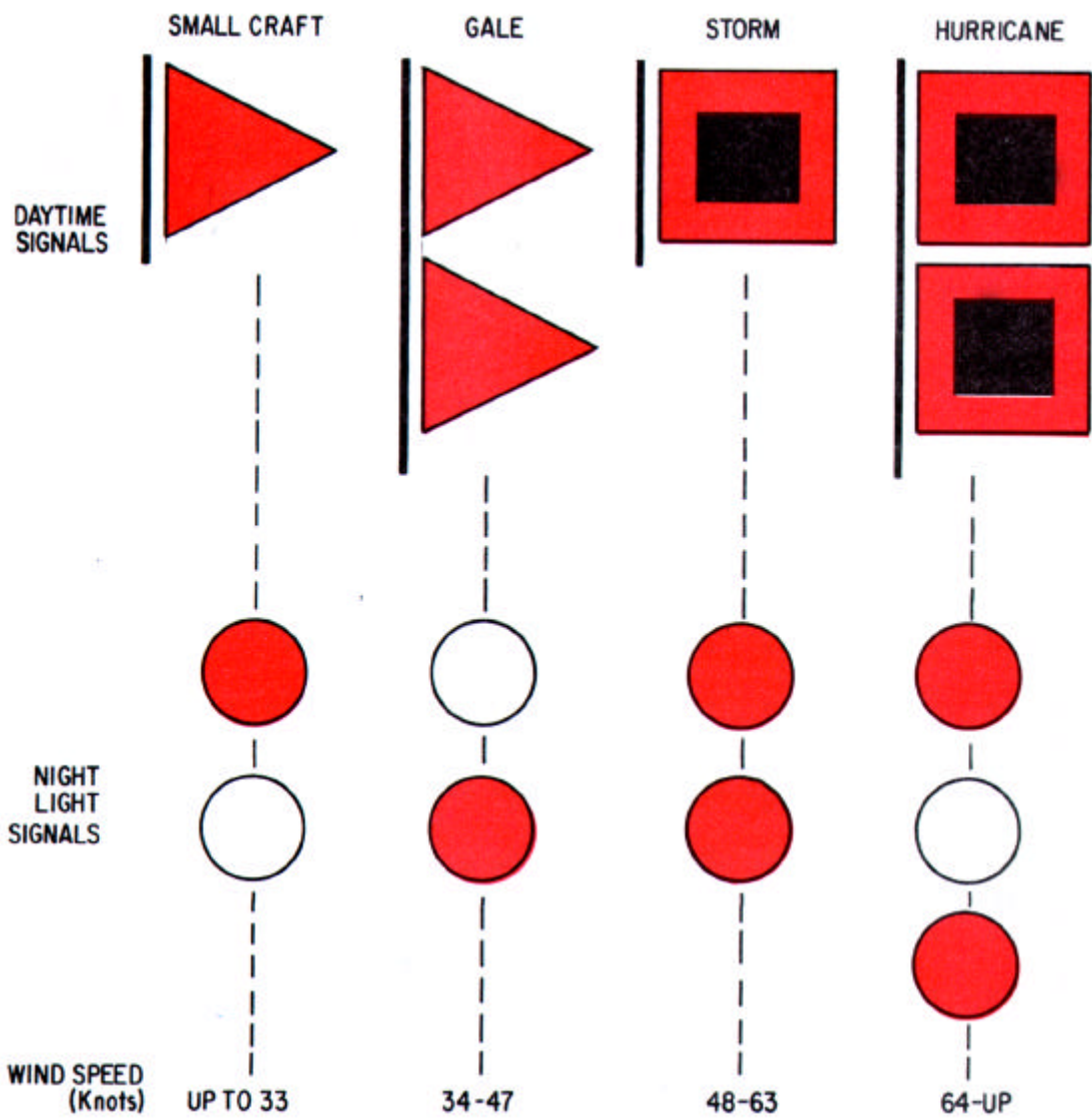

Figure 6-12.—Small-craft, gale, storm, and hurricane warnings.

(tropical storm), the storm-warning display indicates that winds ranging from 55 to 73 miles an hour (48 to 63 knots) are forecast.

- Hurricane warning: Two red flags with black square centers displayed by day or a white light between two red lights at night indicates that winds of 74 miles an hour (64 knots) or above are forecast for the area.

MARITIME BUOYAGE SYSTEM

A buoyage system is a collection of buoys (floating markers) placed to guide ships in and out of channels, to warn them away from hidden dangers, and to lead them to anchorage areas. Before 1982, as many as 30 different buoyage systems were in use around the world. In 1982 an agreement was signed by all maritime countries, establishing two international buoyage regions and condensing all buoyage into one

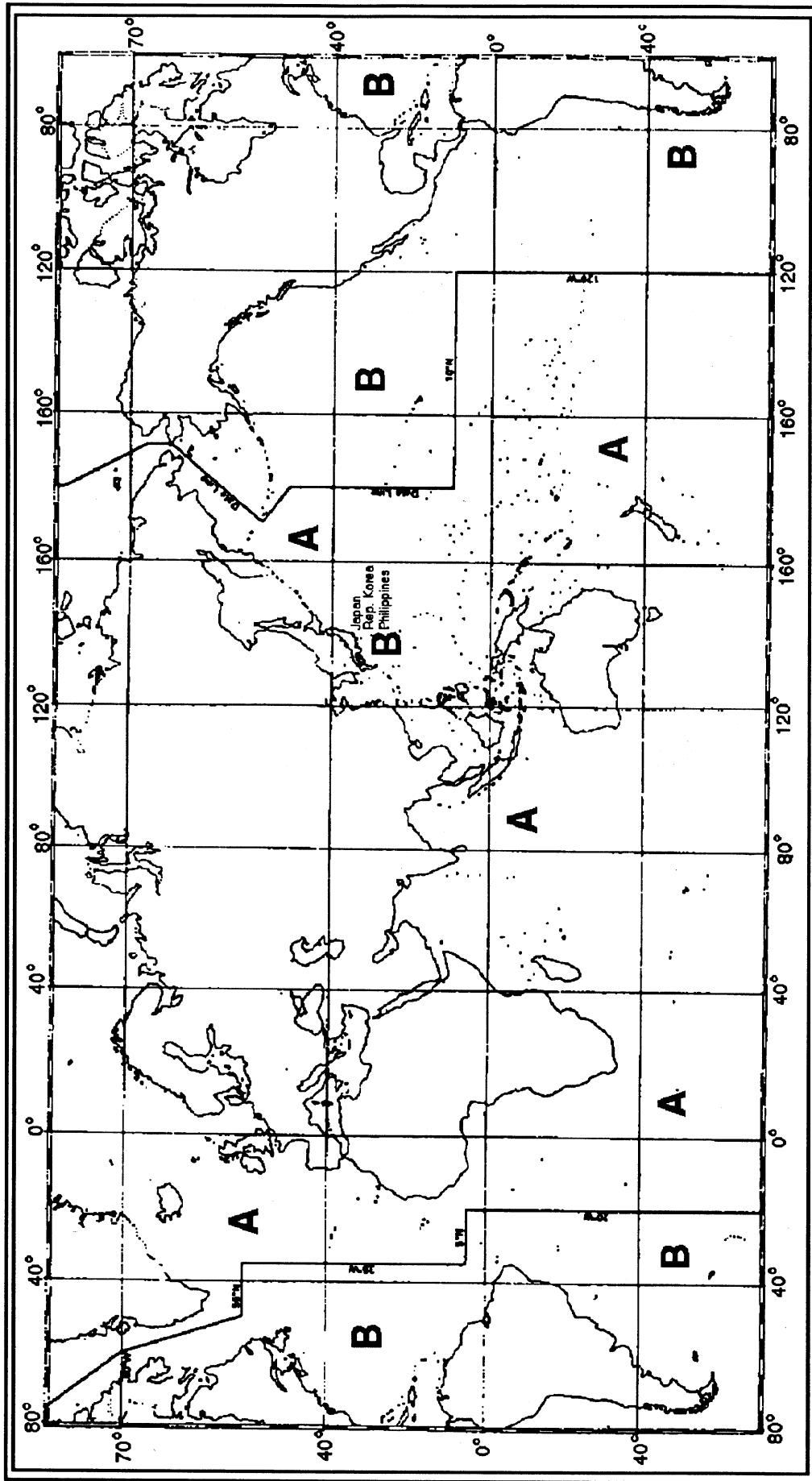

MNV70167

Figure 6-13.—IALA Maritime Buoyage System, buoyage regions A and B.

system. (See fig. 6-13.) This agreement was sponsored by the International Association of Lighthouse Authorities (IALA) and bears its name.

The IALA Maritime Buoyage System provides rules that apply to all fixed and floating markers other than lighthouses, sector lights, range lights, lightships, and large automatic navigational buoys (lanbys).

BUOYS

Buoys have various sizes and shapes; however, they have distinctive coloring, shapes, and topmarks to indicate their purpose by day and colored lights with specific phase characteristics by night.

Although buoys are valuable aids to navigation, you must never depend on them exclusively. Buoys frequently drag their moorings in heavy weather or may be set adrift if run down by passing vessels. Lights on lighted buoys may go out of commission. Whistles, bells, and gongs actuated by the motion of the sea may fail to function in smooth water.

Buoy Shape

There are five basic buoy shapes (fig. 6-14); namely, *can*, *nun*, *spherical*, *pillar*, and *spat*: With the exception of pillar and spar buoys, the shape of the buoy indicates the correct side on which to pass. Can buoys may sometimes be referred to as cylindrical, and nun buoys may be referred to as *conical*. The term *pillar* is used to describe any buoy that is smaller than a lighthouse buoy and has a tall, central structure on a broad base. Lighted buoys in the United States are referred to as pillar buoys.

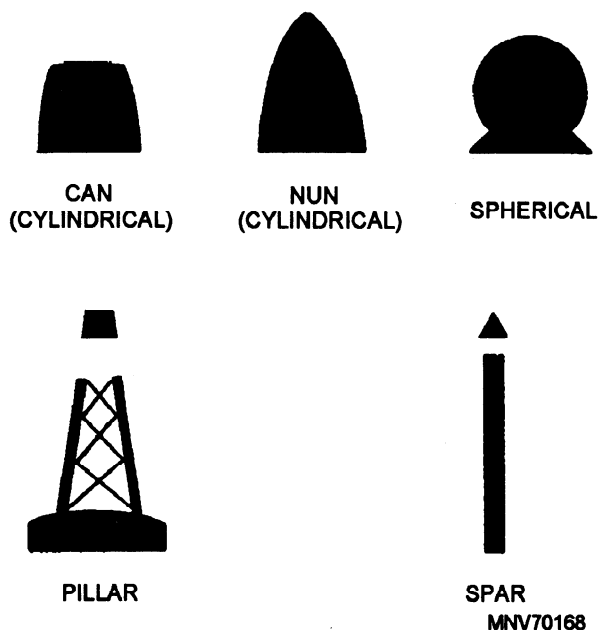

Figure 6-14.—Types of buoys.

Topmarks

Topmarks are small shapes placed on top of some lighted buoys to aid in daytime identification. The IALA Maritime Buoyage System uses can, nun, spherical, and X-shaped topmarks only. Topmarks on pillar and spar buoys are particularly important to indicate the side on which they will be passed and will be used, wherever practical.

Lights

Where marks are lighted, red and green lights are reserved for port and starboard or starboard and port lateral marks. Yellow lights are for special marks, and white lights are used for other types of marks, which we will discuss later in this chapter.

LATERAL MARKS

Lateral marks are generally used for well-defined channels. They indicate the route to be followed and are used in conjunction with a “conventional direction of buoyage.” This direction is defined in one of two ways:

- Local direction of buoyage—the direction the mariner should take when approaching a harbor, river estuary, or other waterway from seaward.
- General direction of buoyage—in other areas, a direction determined by the buoyage authorities, following a clockwise direction around continental landmasses, given in *Sailing Directions*, and, if necessary, indicated on charts by a symbol.

The numbering or lettering of buoys is an optional feature. In the United States, fairway and channel buoys are always numbered odd to port and even to starboard, approaching from seaward.

BUOYAGE REGIONS

As we mentioned previously, two International Buoyage Regions were established under IALA. Navigational charts produced and printed after 1983 indicate the buoyage region to which a chart refers.

Lateral Marks Used in Region A

As shown in figure 6-13, International Buoyage Region A covers Europe and Asia with the exception of Japan, the Republic of Korea, and the Republic of the Philippines. The major rule to remember in this region is “red to port” when you are returning from seaward.

Port hand marks for this area are shown in figure 6-15.

- Color: Red
- Shape (buoys): Can, pillar, or spar
- Topmark (when required): Single red can
- Light (when fitted)
- Color: Red
- Phase characteristics: Any except a composite group flashing (2 + 1)

Starboard hand marks for this area are shown in figure 6-16.

- Color: Green
- Shape (buoys): Nun, pillar, or spar
- Topmark (when required): Single green cone, point upward
- Light (when fitted)
- Color: Green
- Phase characteristics: Any except a composite group flashing (2 + 1)

When a vessel is proceeding in the “conventional direction of buoyage,” a preferred channel is indicated by a modified port or starboard lateral mark at the point where a channel divides.

THIS PAGE MUST BE PRINTED ON A COLOR PRINTER.

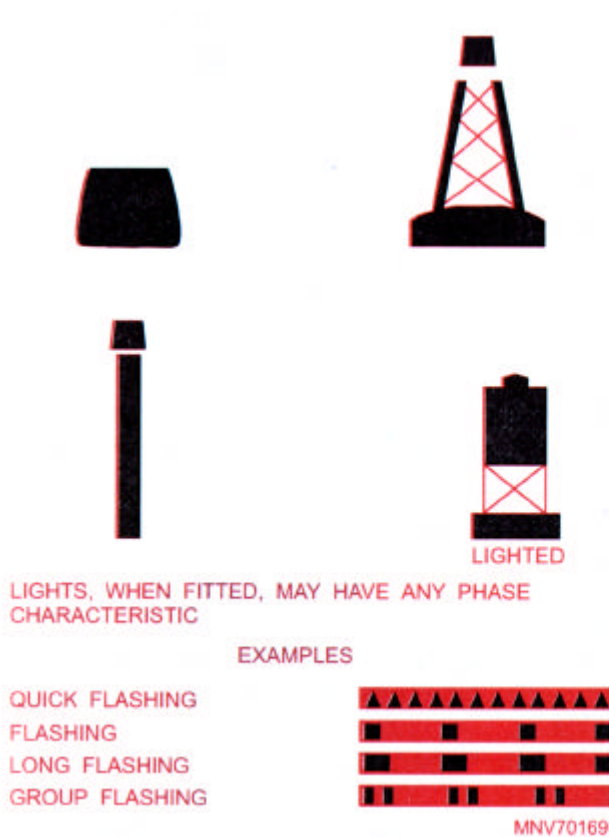

Figure 6-15.—IALA Maritime Buoyage System, International Buoyage Region A, port hand marks (buoys).

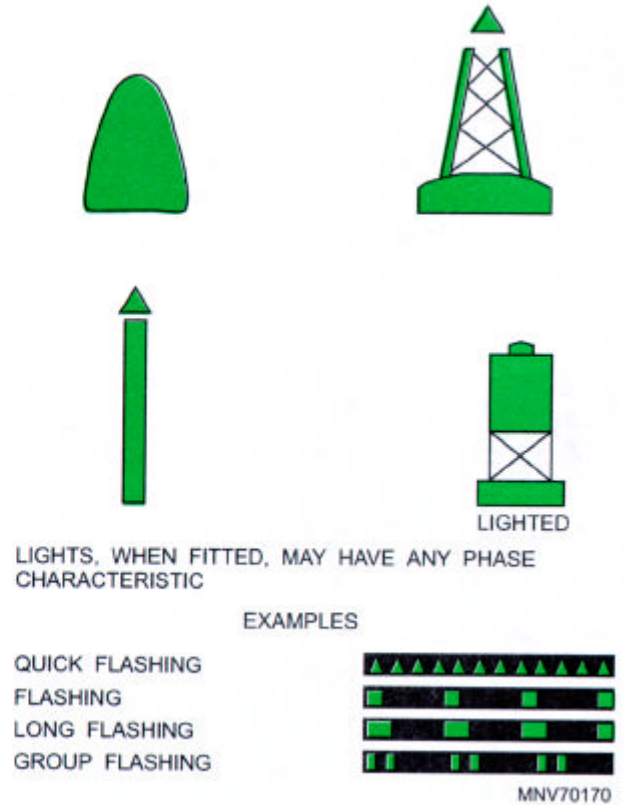

Figure 6-16.—IALA Maritime Buoyage System, International Buoyage Region A, starboard hand marks (buoys).

The preferred channel to port is indicated by the signals shown in figure 6-17.

Color: Green with one broad red horizontal band

Shape (buoys): Nun, pillar, or spar

Topmark (when required): Single green cone, point upward

Light (when fitted)

Color: Green

Phase characteristics: Composite group flashing (2 + 1)

The preferred channel to starboard is indicated by the signals shown in figure 6-18.

Color: Red with one broad green horizontal band

Shape (buoys): Can, pillar, or spar

Topmark (when required): Single red can

Light (when fitted)

Color: Red

Phase characteristics: Composite group flashing (2 + 1)

Lateral Marks Used in Region B

Basically, Region B covers the Western Hemisphere, Japan, the Republic of Korea, and the Philippines. The main rule to remember in this region is red right returning from seaward.

THIS PAGE MUST BE PRINTED ON A COLOR PRINTER.

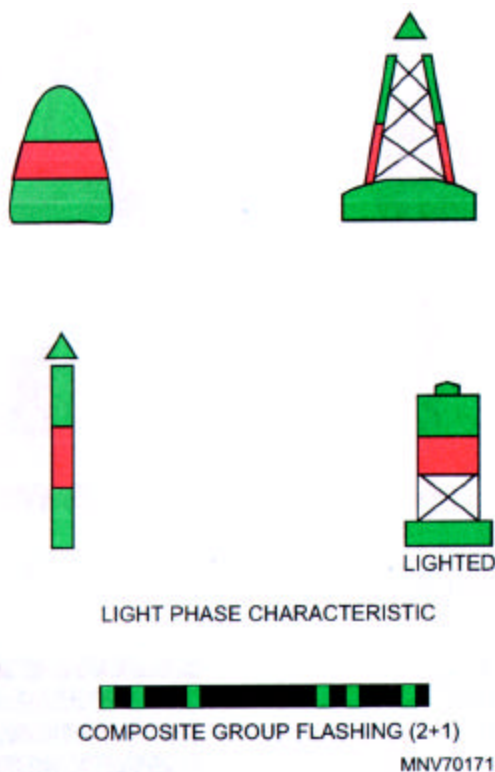

Figure 6-17.—IALA Maritime Buoyage System, International Buoyage Region A, preferred channel to port.

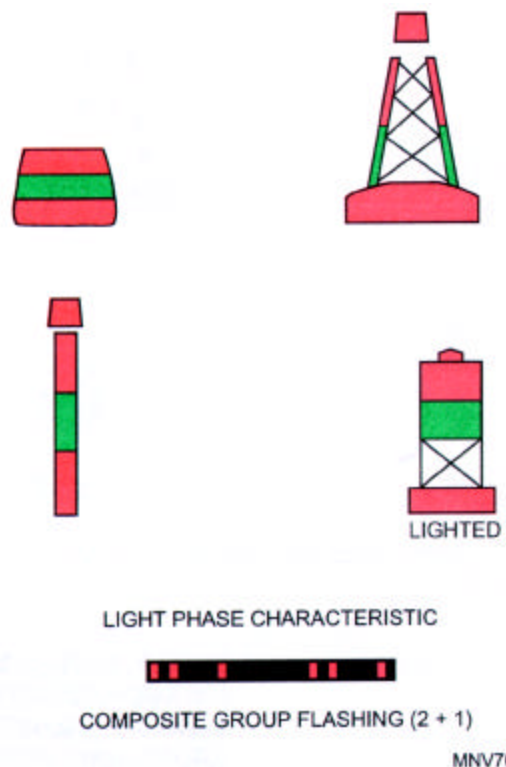

Figure 6-18.—IALA Maritime Buoyage System, International Buoyage Region A, preferred channel to starboard.

Port hand marks are shown in figure 6-19.

Color: Green

Shape (buoys): Can, pillar, or spar

Topmark (when required): Single green can

Light (when fitted)

Color: Green

Phase characteristics: Any except a composite group flashing (2 + 1)

Starboard hand marks are shown in figure 6-20.

Color: Red

Shape (buoys): Nun, pillar, or spar

Topmark (when required): Single red cone, point upward

Light (when fitted)

Color: Red

Phase characteristics: Any except a composite group flashing (2 + 1)

The preferred channel to port is indicated by the signals shown in figure 6-21.

Color: Red with one broad green horizontal band

Shape (buoys): Nun, pillar, or spar

Topmark (when required): Single red cone, point upward

Light (when fitted)

Color: Red

Phase characteristics: Composite group flashing (2 + 1)

THIS PAGE MUST BE PRINTED ON A COLOR PRINTER.

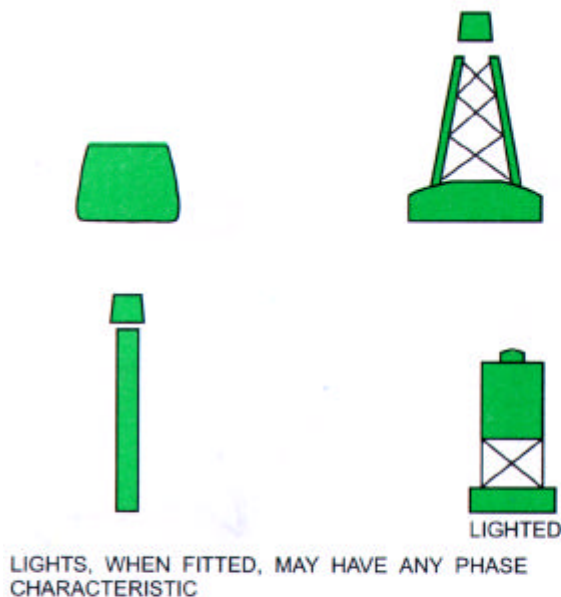

EXAMPLES

QUICK FLASHING
FLASHING
LONG FLASHING
GROUP FLASHING



MNV70173

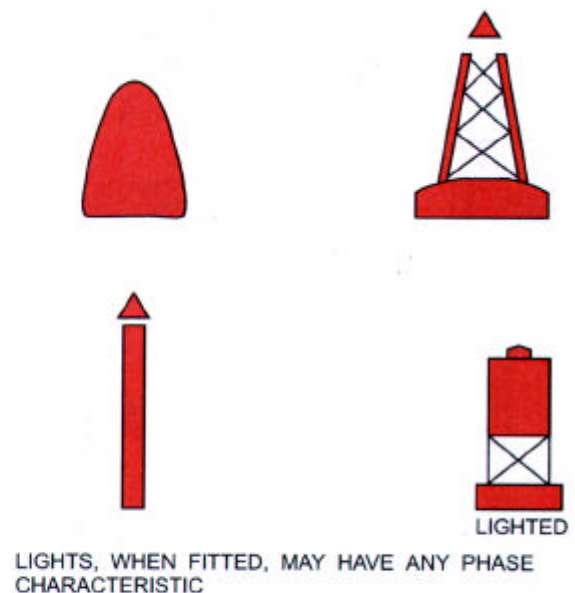

EXAMPLES

QUICK FLASHING
FLASHING
LONG FLASHING
GROUP FLASHING

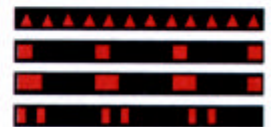

MNV70174

Figure 6-19.—IALA Maritime Buoyage System, International Buoyage Region B, port hand marks (buoys).

Figure 6-20.—IALA Maritime Buoyage System, International Buoyage Region B, starboard hand marks (buoys).

The preferred channel to starboard port is indicated by the signals shown in figure 6-22.

Color: Green with one broad red horizontal band

Shape (buoys): Can, pillar, or spar

Topmark (when required): Single green can

Light (when fitted)

Color: Green

Phase characteristics: Composite group flashing (2 + 1)

NOTE

In buoyage Regions A and B, if marks at the sides of a channel are numbered or lettered, the numbering or lettering will follow the “conventional direction of buoyage.”

CARDINAL MARKS

In some navigable bodies of water, the area having the best navigable water needs to be marked. Some of the reasons for marking the area are as follows:

- To indicate the deepest water in the area.
- To indicate the safe side on which to pass a danger.
- To draw attention to a feature in a channel, such as a bend, junction, branch, or end of a shoal.

Such an area is indicated by a cardinal mark, or buoy, that is placed in one of the four quadrants (north, east, south, or west) from the best water. A cardinal mark takes its name from the compass quadrant in

THIS PAGE MUST BE PRINTED ON A COLOR PRINTER.

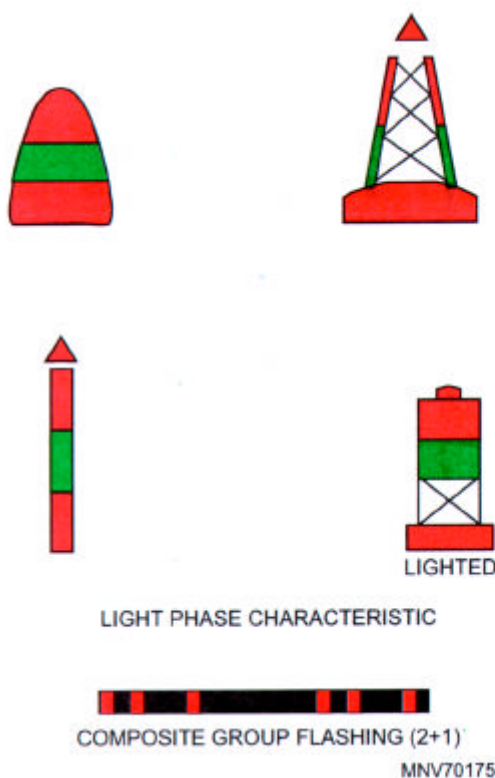

Figure 6-21.—IALA Maritime Buoyage System, International Buoyage Region B, preferred channel to port.

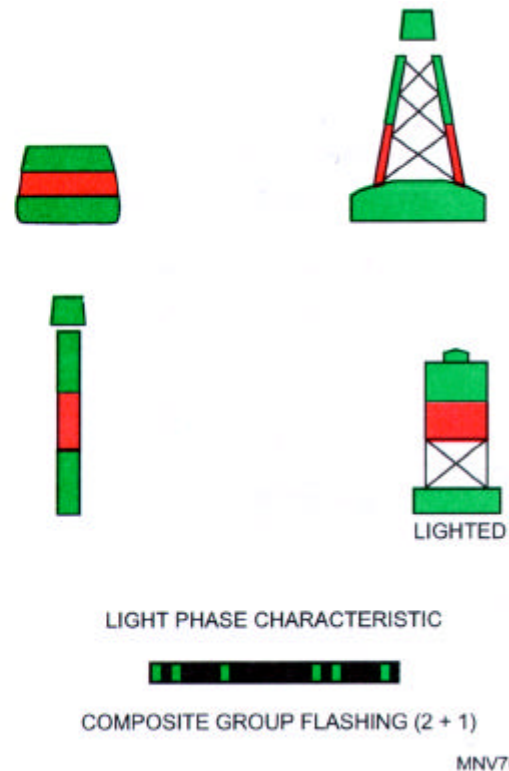

Figure 6-22.—IALA Maritime Buoyage System, International Buoyage Region B, preferred channel to starboard.

which it is placed. Figure 6-23 shows the four IALA Maritime Buoyage System cardinal marks, as related to a point of interest.

Notice that each quadrant shows the buoy or mark with its specific color coding, topmark, and light pattern. Basically, the figure tells you that you will be safe if you pass north of a north mark, east of an east mark, south of a south mark, and west of a west mark.

Topmarks

By day, topmarks are the most important features of cardinal marks. To interpret cardinal marks, you must know the arrangement of the cones. For north, the point of each cone is up. For south, the point of each cone is down. The west topmark resembles a wine glass.

Cardinal marks carry topmarks, whenever practical, with the cones as large as possible and clearly separated.

Color

Black and yellow horizontal bands are used to color cardinal marks. The position of the black band, or bands, is related to the points of the black topmarks. The black and yellow horizontal bands are used as follows:

- North—black band above yellow band
- South—black band below yellow band
- West—black band with yellow bands above and below
- East—black band above and below yellow band

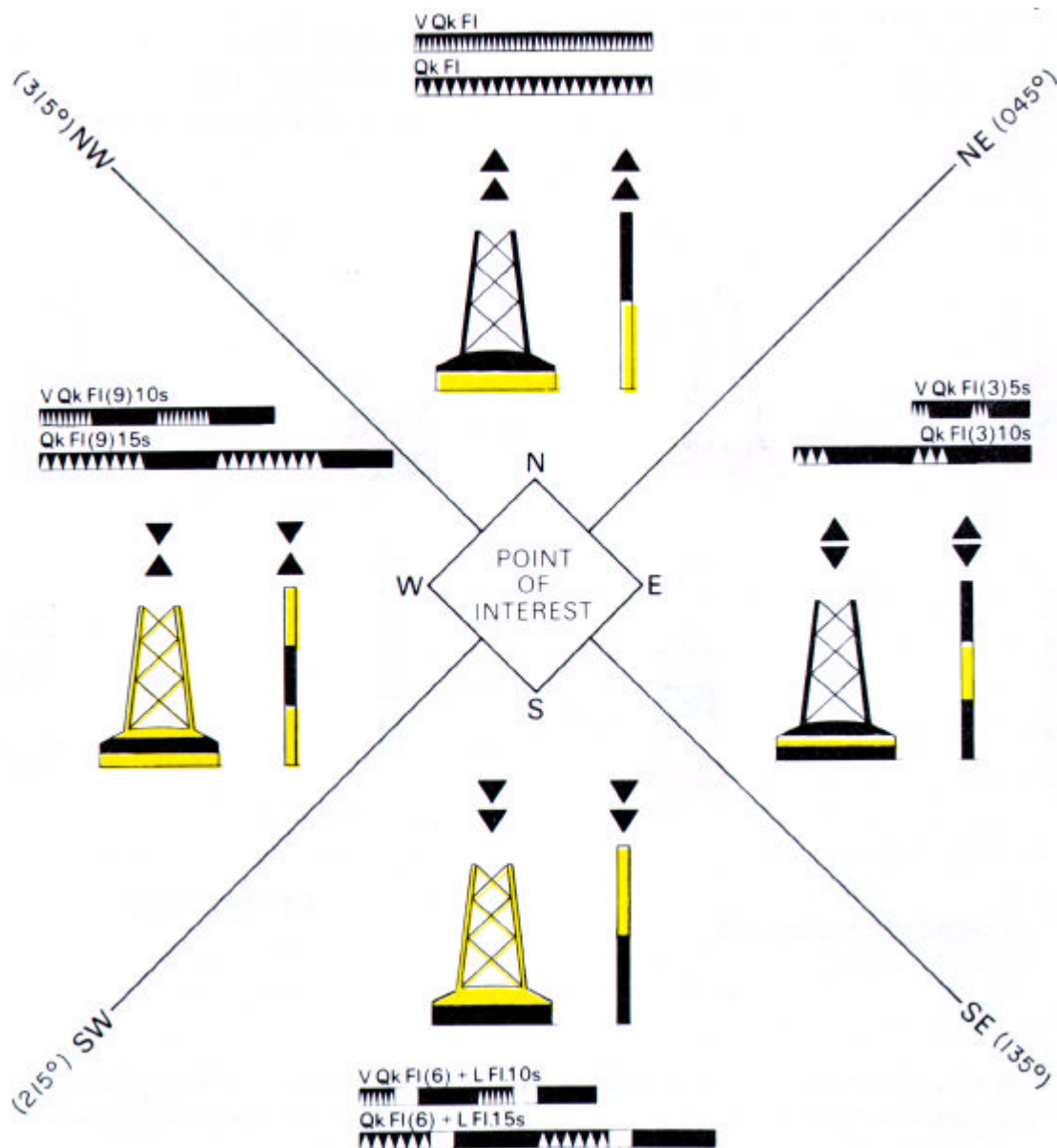

Figure 6-23.—IALA Maritime Buoyage System, cardinal marks.

The shape of a cardinal mark is not important, but in the case of a buoy, it will be a pillar or a spar.

Light Characteristics

When lighted, a cardinal mark exhibits a white light. The characteristics are based on a group of quick (Qk) or very quick (VQk) flashes. These flashes distinguish it as a cardinal mark and indicate its quadrant. The distinguishing QK or VQK flashes are as follows:

- North—uninterrupted
- East—three flashes in a group
- South—six flashes in a group followed by a long flash
- West—nine flashes in a group

As a memory aid, associate the number of flashes in each group with a clock face (3 o'clock—east, 6 o'clock—south, and 9 o'clock—west).

The long flash immediately following the group of flashes of a south cardinal mark is to ensure that its six flashes cannot be mistaken for three or nine.

Quick flashing lights flash at a rate of 50 to 79 flashes per minute. Very quick flashing lights flash at a rate of 80 to 159 flashes per minute. The two rates of flashing are used in situations that might cause confusion for mariners. For example, suppose two north buoys are placed near enough to each other that they might be mistaken for one another. In this case, one buoy would be set for quick flashing, while the other would be set for very quick flashing.

ISOLATED DANGER MARKS

An isolated danger mark (fig. 6-24) is erected on, or moored above, an isolated danger of limited extent. The isolated danger mark has navigable water all around it.

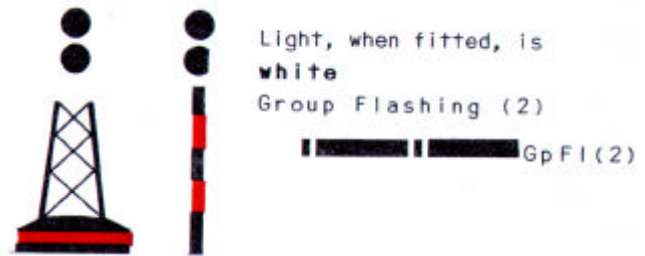

Figure 6-24.—IALA Maritime Buoyage System, isolated danger mark.

The extent of the surrounding navigable water is not important. The isolated danger mark can, for example, indicate either a shoal that is well offshore of an islet separated by a narrow channel from the coast.

A black double-sphere topmark is, by day, the most important feature of an isolated danger mark. Whenever practical, this topmark will be carried with the spheres as large as possible, mounted vertically, and clearly separated.

The isolated danger mark is painted black, with one or more red horizontal bands. Its shape is not significant, but if the mark is a buoy, it will be a pillar or spar.

If the danger mark is a spar buoy and is lighted, it will have a white flashing light showing a group of two flashes. The association of two flashes and two spheres in the topmark may be a help in remembering these characteristics.

SAFE WATER MARKS

A safe water mark (fig. 6-25) is used to indicate there is navigable water all around the mark. Such a

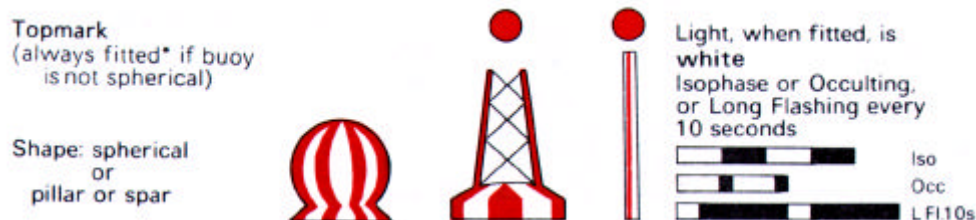

Figure 6-25.—IALA Maritime Buoyage System, safe water marks.

mark may be used as a center line buoy, a midchannel buoy, or a landfall buoy.

Red and white vertical stripes are used to indicate safe water marks. The vertical stripes distinguish them from the black-banded danger marks. Spherical, pillar, or spar buoys may be used as safe water marks. Whenever practical, a pillar or spar buoy used as a safe water mark will carry a single red sphere topmark.

When lighted, a safe water mark exhibits a white light. The phase characteristics of the light may be occulting, equal interval (isophase), one long flash every 10 seconds, or Morse "A."

SPECIAL MARKS

A special mark (fig. 6-26) may be used to point out a special area or feature. You can find the nature of the special area or feature by consulting the chart, *Sailing Directions*, or *Notice to Mariners*. The uses of a special mark include the following:

- Ocean Data Acquisition System (ODAS) buoys carrying oceanographic or meteorological sensors
- Traffic separation marks
- Spoil ground marks
- Military exercise zone marks
- Cable or pipeline marks, including outfall pipes
- Recreation zone marks

Another function of a special mark is to define a channel within a channel (for example, a channel for

deep-draft vessels in a wide-approach area where the limits of the channel for normal navigation are marked by red and green lateral buoys).

Yellow is the color used for special marks. The shape of a special mark is optional, but it must not conflict with a lateral mark or a safe water mark. For example, an outfall buoy on the port side of a channel could be can-shaped but not conical.

When a topmark is carried, it takes the form of a single yellow X. When a light is exhibited, it is yellow. The phase characteristics may be any except those used for the white lights of cardinal, isolated danger, and safe water marks.

NEW DANGERS

A newly discovered hazard to navigation, not yet shown on charts or included in *Sailing Directions* or sufficiently announced by *Notice to Mariners*, is called a "new danger." The term *new danger* covers naturally occurring obstructions, such as sandbanks or rocks, and man-made dangers, such as wrecks.

A new danger is marked by one or more cardinal or lateral marks following the IALA Maritime Buoyage System. When the danger is especially grave, it will be marked by marks that are identical until the danger has been sufficiently announced.

When a lighted mark is used for a new danger, it must exhibit a quick flashing or a very quick flashing light. When it is a cardinal mark, it must exhibit a white light. When it is a lateral mark, it must exhibit a red or green light.

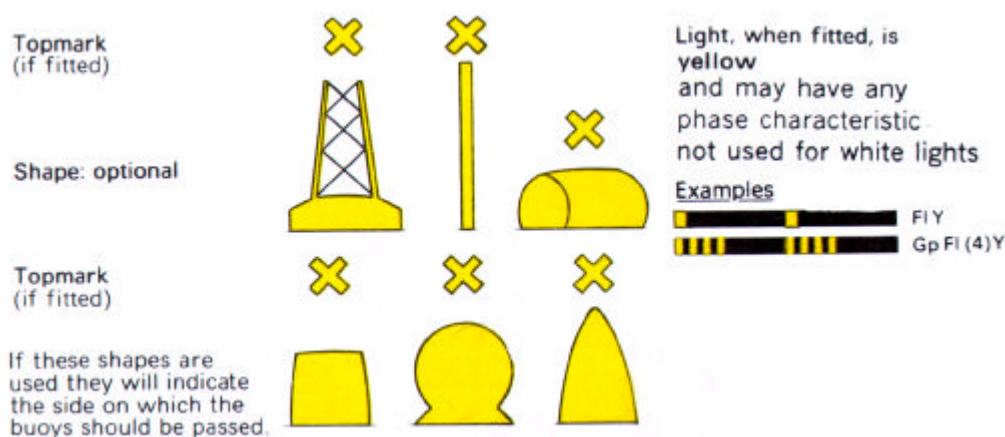

Figure 6-26.—IALA Maritime Buoyage System, special marks.

The duplicate mark may carry a radar beacon (RACON), coded D (-), showing a signal length of 1 nautical mile on a radar display.

DAYMARKS

Unlighted aids to navigation (except unlighted buoys) are called daymarks (fig. 6-27). A daymark may consist of a single pile with a mark on top of it, a spar supporting a cask, a slate or masonry tower, or any of several structures.

Daymarks, like lighthouses and light structures, are usually colored, to distinguish them from their surroundings and make them easy to identify. Daymarks marking channels are colored and numbered like channel buoys. Many are fitted with reflectors that show the same colors a lighted buoy would show at night in the same position.

AIDS IN THE INTRACOASTAL WATERWAY

The Intracoastal Waterway, called the inland waterway, is a channel in which a light-draft vessel can navigate coastwise from the Chesapeake Bay almost to the Mexican border, remaining inside the natural or artificial breakwaters for almost the entire length of the trip.

Every buoy, daymark, or light structure along the Intracoastal Waterway has part of its surface painted yellow—the distinctive coloring adopted for this waterway. Somewhere on a lighted buoy is a band or a border of yellow.

Red buoys and daymarks are to the right, green to the left, as you proceed from the Chesapeake Bay toward Mexico. As in other channels, red buoys have even numbers; green buoys, odd numbers. Because the numbers would increase excessively in such a long line of buoys, they are numbered in groups that usually contain no more than 200 buoys. At certain natural dividing points, numbering begins again at one.

Lights on buoys in the Intracoastal Waterway follow the standard system of red lights on red buoys and green lights on green buoys. Lights on lighted aids besides buoys also agree with the standard rules for lights on aids to navigation.

DISTRESS SIGNALS

When a vessel or seaplane on the water is in distress and requires assistance from other vessels or from the

THIS PAGE MUST BE PRINTED ON A COLOR PRINTER.

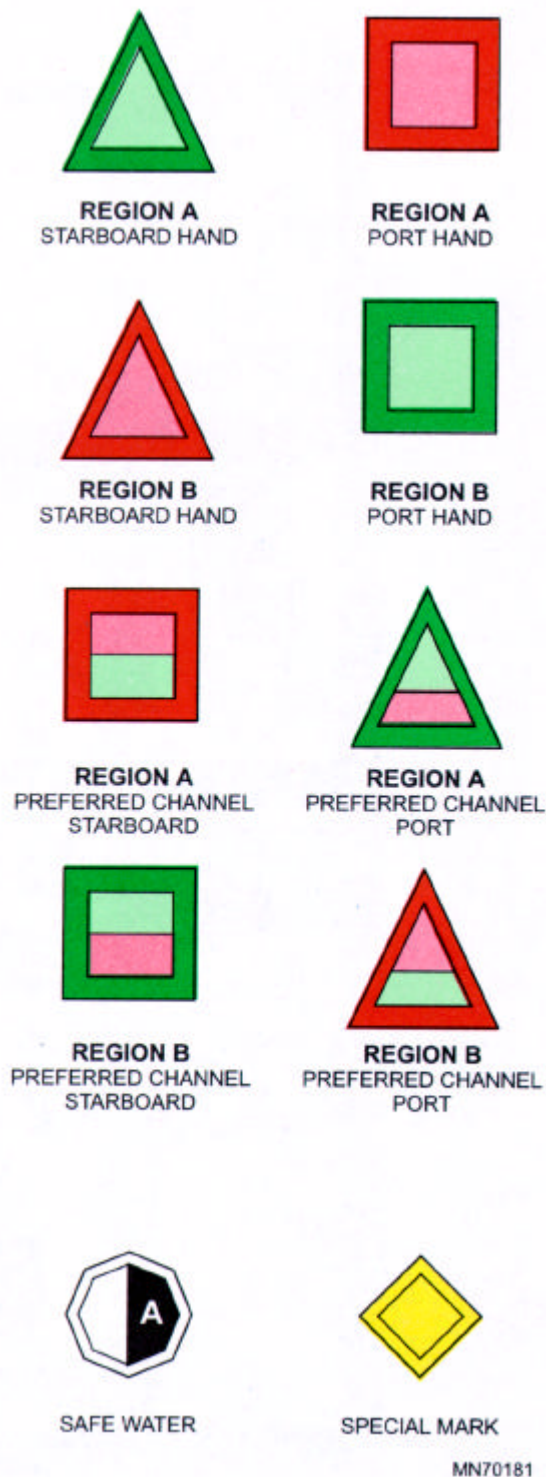
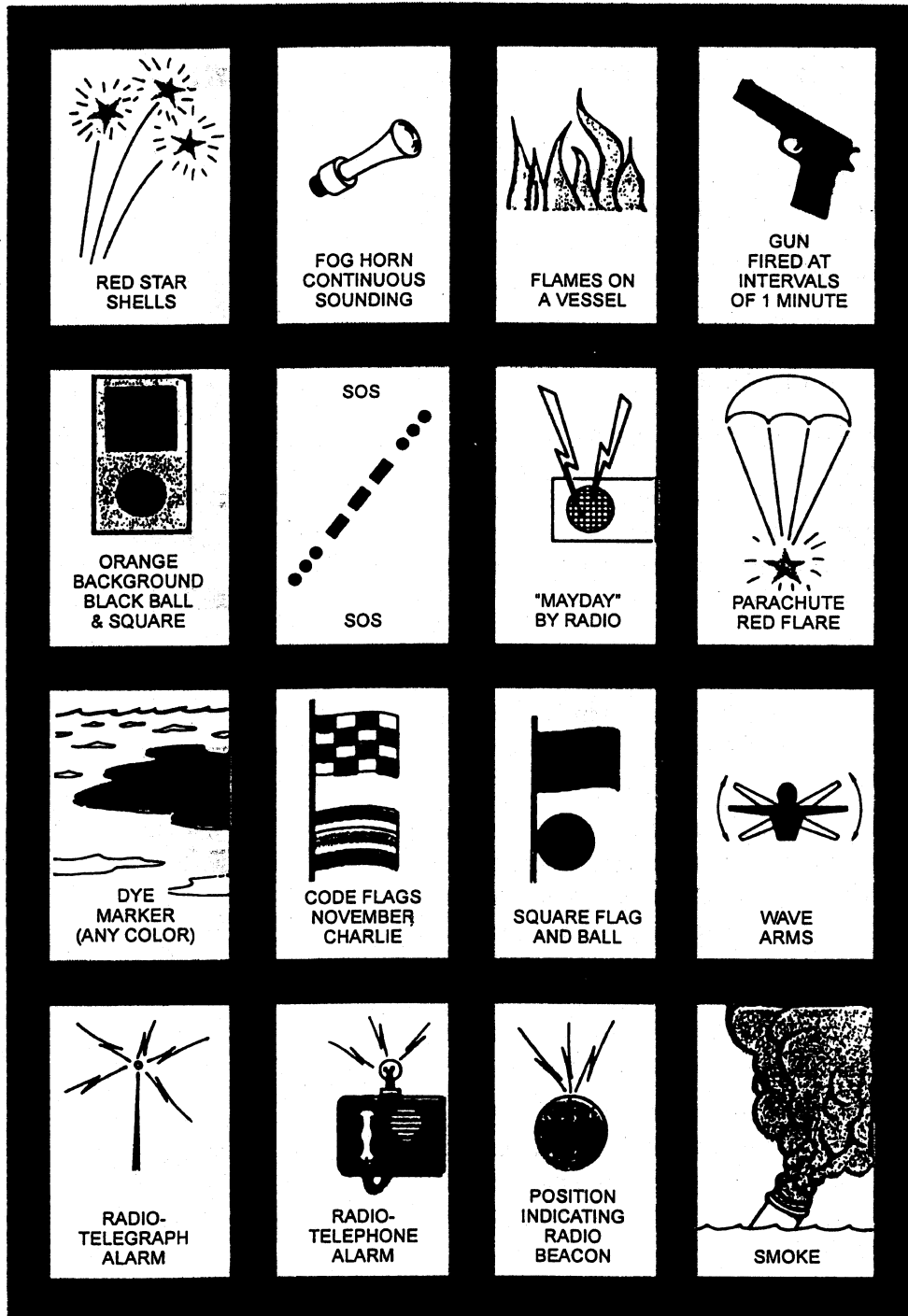

Figure 6-27.—IALA Maritime Buoyage System, lateral daymark

shore, it may use or display one or more international distress signals, either together or separately. The international distress signals are shown in figure 6-28 and are described below.

- A gun or other explosive signal fired at intervals of about 1 minute
- A continuous sounding with any fog signal apparatus



MNV70182

Figure 6-28.—International/Inland distress signals.

- Rockets, or shells, throwing red stars, fired one at a time at short intervals
- A signal made by radiotelegraphy or by any other signaling methods, consisting of the group . . . - - - . . . (SOS in Morse code)
- A signal sent by radiotelephone consisting of the spoken word *Mayday*
- The International Code signal of distress indicated by NOVEMBER CHARLIE (flag hoist)
- A signal consisting of a square flag having above or below it a ball or anything resembling a ball
- Flames on the vessel (as from a burning tar barrel, oil barrel, and so on)
- A rocket parachute flare showing a red light
- A smoke signal giving off a volume of orange smoke
- Slowly and repeatedly raising and lowering arms outstretched to each side

CHAPTER 7

ANCHORING, MOORING, AND TOWING

LEARNING OBJECTIVES

Upon completing this chapter, you should be able to do the following:

1. Describe and identify anchors and their related appendages.
2. Describe the standard methods for anchoring and mooring ships.
3. Describe the procedures for rigging and unrigging for towing a ship and for being towed. State the basic rules for adjusting lines during the tow.
4. Identify and describe the principal types of salvage.

INTRODUCTION

In chapter 4 we discussed the procedures involved in tying a ship up to a pier. In this chapter, we discuss how to anchor a ship and moor it to a buoy. We also briefly cover towing and salvage.

ANCHORS

Although several types of anchors are in use aboard Navy ships, mine countermeasures ships use a lightweight-type (LWT) anchor called the Danforth (figure 7-1).

IDENTIFYING ANCHORS

Each anchor of over 100 pounds ordered by the Naval Sea Systems Command is assigned a serial number, which is cast or cut into the anchor before it is delivered. Serial numbers are found on the shank of lightweight anchors. These numbers must be recorded in the ship's anchor log. If you receive a new anchor, be certain to record the proper numbers. Do not confuse these numbers with other figures, such as the weight of the anchor.

CHAIN AND ITS APPENDAGES

All Navy ship anchors are connected to some length of anchor chain. Modern Navy anchor chain is made of die-lock chain with studs. The size of the link is determined by its diameter, called wire *diameter*. The

Federal Supply Catalog lists standard sizes from 3/4 to 4 3/4 inches. Wire diameter is measured at the end and a little above the center line of the link. The length of a standard link is 6 times its diameter; its width is 3.6 times its diameter. All links are studded; that is, a solid piece is forged in the center of the link. Stud prevent the chain from kinking and the links from pounding on adjacent links.

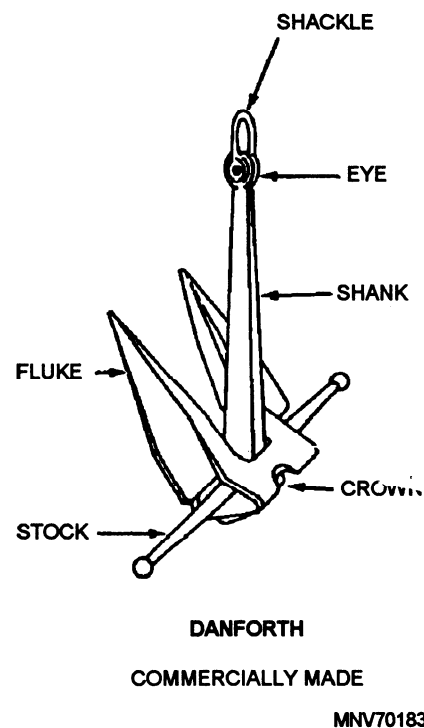

Figure 7-1.—Lightweight-type (LWT) anchor.

Heavy-duty and high-strength die-lock chains are physically similar to some of the smaller sizes of standard die-lock chain but have higher breaking strengths. Size for size, the links fit the same wildcat (windlass drum).

Chain Nomenclature

A chain is made of many parts besides links, and a variety of equipment is used to maintain the chain. The following paragraphs describe a chain and its associated hardware:

- **STANDARD SHOTS.** The lengths of chain that are connected together to make up the ship's anchor chain are called *shots*. A standard shot is 15 fathoms (90 feet) long. Each shot of chain usually bears a serial number, either stamped or cut at the time of manufacture, on the inner side of its end links. If an end link is lost or removed from a shot, this identification number should be either cut or stamped on the inside of the new end link of the altered shot.

- **DETACHABLE LINKS.** Shots of anchor chain are joined by a detachable link, shown in figure 7-2. The Navy type of detachable link consists of a C-shaped link with two coupling plates, which form one side and the stud of the link. A taper pin holds the parts together and is locked in place at its large end by a lead plug. Detachable link parts are not interchangeable, so matching numbers are stamped on the C-link and on each coupling plate to ensure identification and proper assembly. You will save time and trouble trying to match these parts if you disassemble only one link at a time and clean, slush, and reassemble it before disassembling another. When you reassemble a detachable link, make sure the taper pin is seated securely. You can do this by driving the pin in with a punch and hammer before you insert the lead plug over the pin's large end. Detachable link toolbox sets contain tools and parts, including spare taper pins and lock plugs, for assembling and disassembling links and detachable end links.

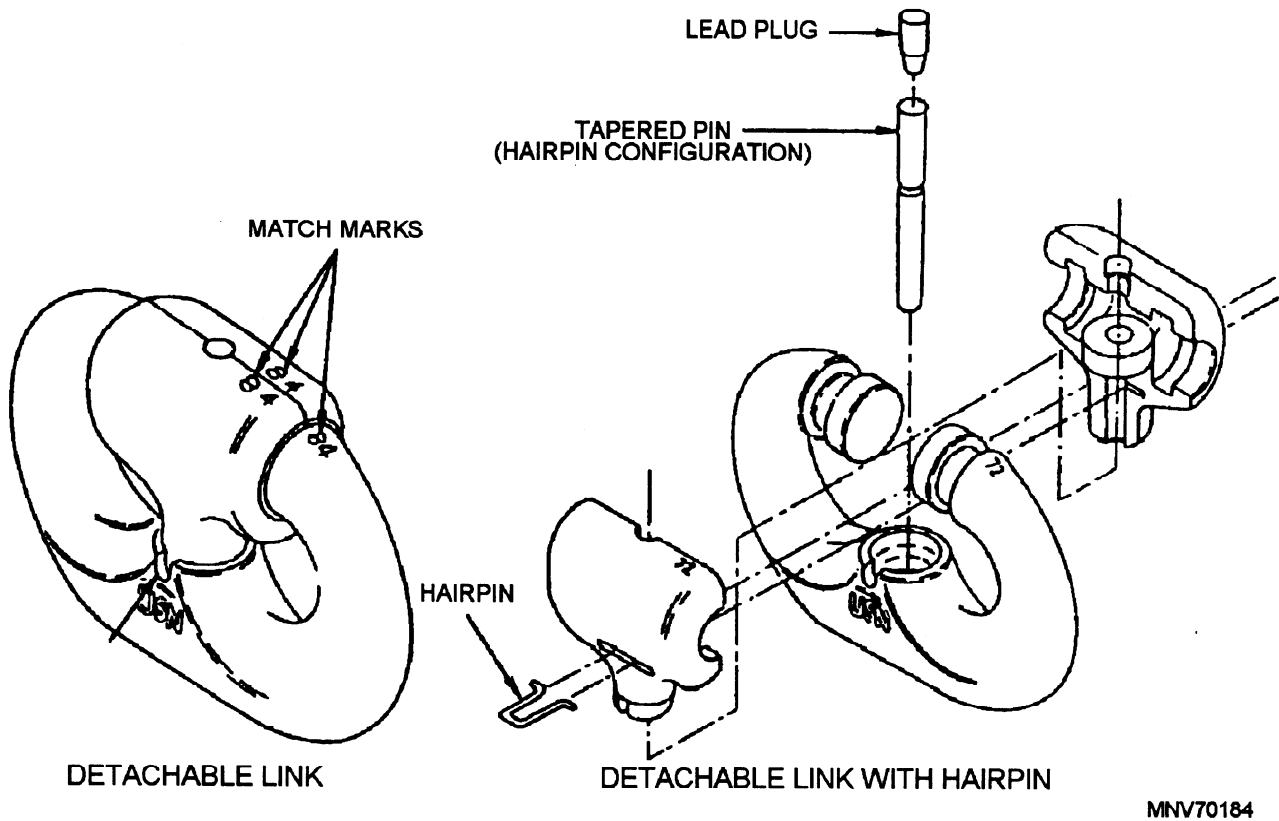
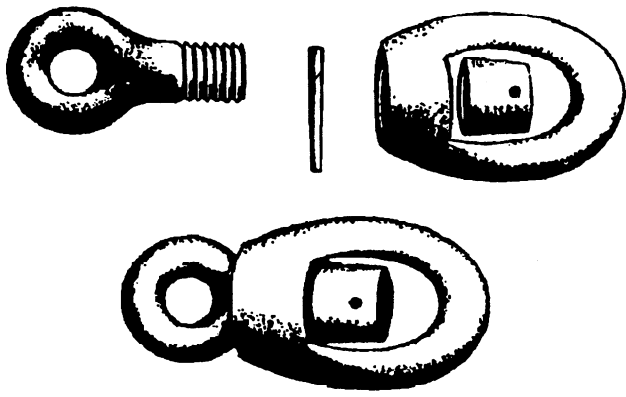

Figure 7-2.—Detachable link.



MNV70185

Figure 7-3.—Chain swivel.

- **BENDING SHACKLE.** A bending shackle is used to attach the anchor to the chain.
- **CHAIN SWIVEL.** A chain swivel (fig. 7-3) is furnished as part of the outboard swivel shot. It

minimizes kinking and twisting of the anchor chain.

- **OUTBOARD SWIVEL SHOTS.** Standard outboard swivel shots (fig. 7-4), also termed *bending shots*, consist of detachable links, regular chain links, a swivel, an end link, and a bending shackle. They are fitted on most vessels to attach the anchor chain to the anchor. They also make it possible to stop off the anchor and break the chain between the windlass and the anchor. The taper pins in the detachable links in the outboard swivel shot are additionally secured with a U-shaped, stainless steel, wire-locking clip (sometimes called a hairpin). This hairpin, inserted in holes drilled through the coupling plates, engages a keyway or groove on the taper pin. (See figure 7-2.)
- **RIDING, HOUSING, AND TOWING CHAIN STOPPERS.** Chain stoppers are used to hold the anchor taut in the hawsepipes, to ride at anchor, or to hold the anchors when the anchor chain is disconnected for any reason. Riding and

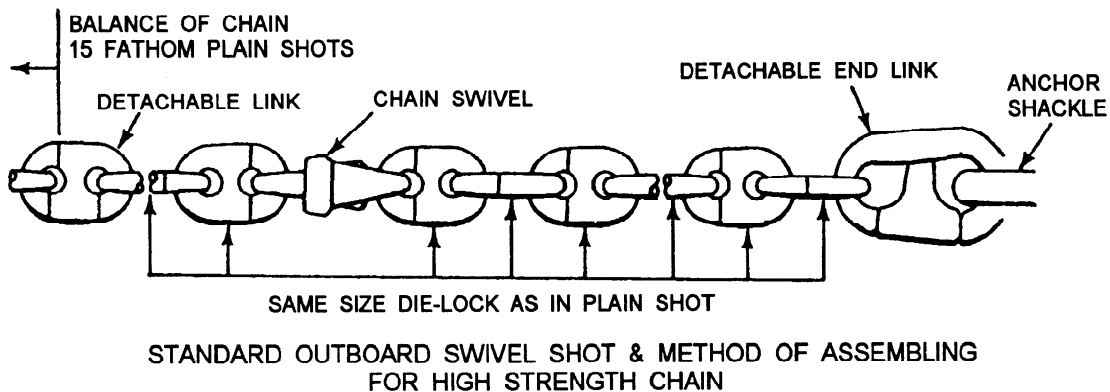
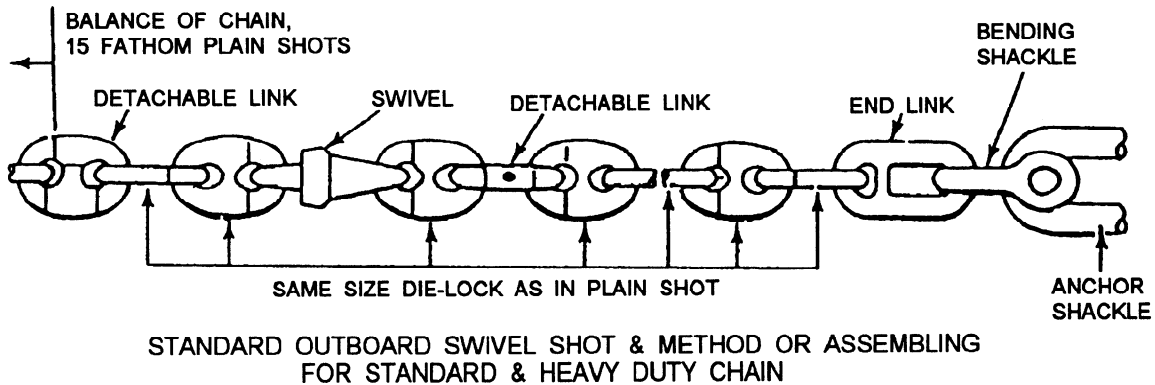

MNV70186

Figure 7-4.—Outboard swivel shot.

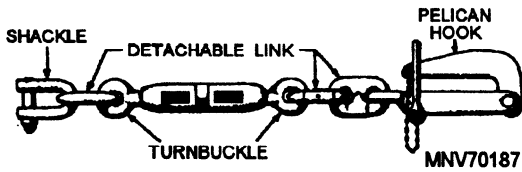

Figure 7-5.—Chain stopper.

housing chain stoppers (fig. 7-5) consist of a turnbuckle inserted in a short section of chain with a slip or pelican hook attached to one end of the chain and a shackle at the other end. The housing stopper is nearest the hawsepipe, the riding stopper is farther aft. These stoppers are secured by the shackles to permanent pad eyes on the vessel's deck. When in use, a stopper is attached to the anchor chain by straddling a link with the tongue and strongback of the pelican hook. Special housing chain stoppers, such as the devil's claw or the pawl type of stoppers, normally are used with horizontal windlasses and where space limitations do not permit use of Navy standard stoppers. Although stoppers alone are more than adequate for holding the anchor, they should be backed up with the wildcat brake. Upon anchoring, you should first set the wildcat brake band, then set the stoppers tight, making sure you equalize the tension on them, so that one is not loaded more than the other. The wildcat should be left disconnected from the windlass. A Navy standard chain stopper is shown in figure 7-5.

Towing chain stoppers are similar to riding and housing chain stoppers, except that towing chain stoppers have locking plates added. (See fig. 7-6.) These locking plates prevent the towing chain stopper from unscrewing when subjected to the shock loading

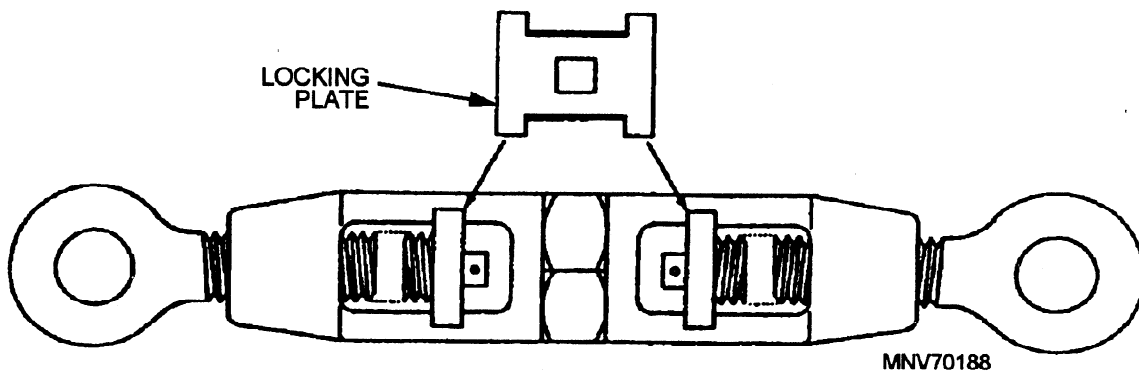

Figure 7-6.—Anchor chain stopper modified for towing.

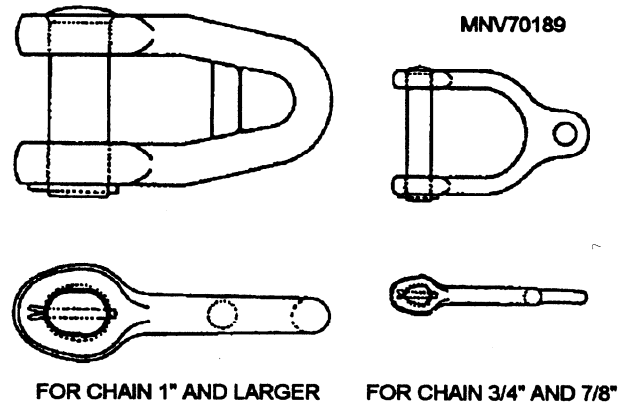

Figure 7-7.—Mooring shackles.

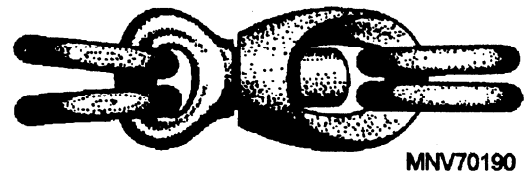
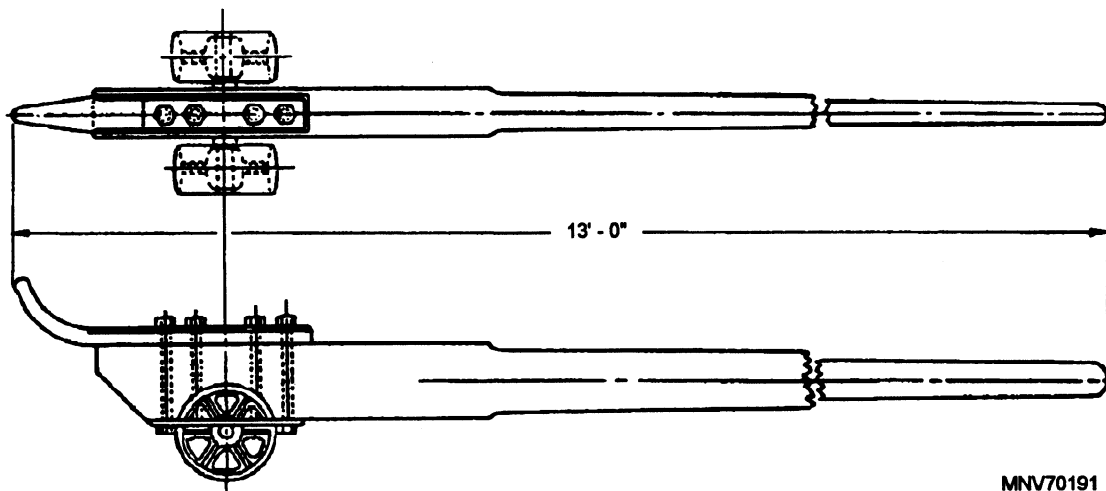

Figure 7-8.—Mooring swivel.

of the towing hawser. Towing chain stoppers should be used whenever the ship is being towed.

- **MOORING SHACKLES.** Mooring shackles are forged steel shackles (fig. 7-7) that are used to attach anchor chains to mooring buoys. All mooring shackles, regardless of size, have a standard mortise (opening) of 7 inches. Mooring shackles should not be used for any other purposes.
- **MOORING SWIVELS.** Forged steel swivels, with two links attached at each end (fig. 7-8), are used to moor with two anchors. They are inserted in the chain outboard of the hawse and keep the chain from twisting as the ship swings. Mooring swivels should be attached in the chain



MNV70191

Figure 7-9.—Cable jack.

with the eye-end outboard, or down, to prevent them from hooking on the outer lip of the hawse when they are heaved back aboard. However, most ships today have large rounded lips on the hawsepipes, making it unlikely that a reversed swivel will catch.

- **CHAIN CABLE JACKS.** A cable jack (fig. 7-9), consisting of a lever mounted on an axle and two wheels, is used to handle anchor chain in sizes 2 3/4 inches and above. It is used to pick the chain up to pass a chain stopper. A pinch-point crowbar type anchor bar is issued for smaller sizes of chain.
- **CLEAR HAWSE PENDANT.** A clear hawse pendant is a wire rope pendant, 5 to 15 fathoms long, with a thimble at one end and a pelican hook attached to a length of open-link chain fitted in a thimble at the other end. It is used in clearing a hawse fouled by the anchor chain. (See fig. 7-10.)
- **DIP ROPE.** A dip rope is a fiber rope pendant, fitted at one end with a thimble and a dip shackle

large enough to engage a link of the anchor chain at the other end. This pendant is used to moor or clear a hawse. Information on dip shackles and proportional dimensions for the different sizes of chain are given in NSTM, chapter 581.

Anchor Chain Markings

The detachable links of anchor chain are painted red, white, or blue as follows: red, to indicate 15 fathoms; white, 30 fathoms; blue, 45 fathoms; red, 60 fathoms; white, 75 fathoms; and so on.

At the 15-fathom mark, one link on each side of the detachable link is painted white, and one turn of wire is wrapped securely around each stud. At the 30-fathom mark, two links on each side of the detachable link are painted white, and two turns of wire are wrapped around each of the last white studs. At the 45-fathom mark, three links on each side of the detachable link are painted white, and three turns of wire are wrapped around each of the last white studs. At the 60-fathom mark, four links on each side of the detachable link are painted white, and four turns of wire are wrapped around each of the last white studs, and so on, for each shot.

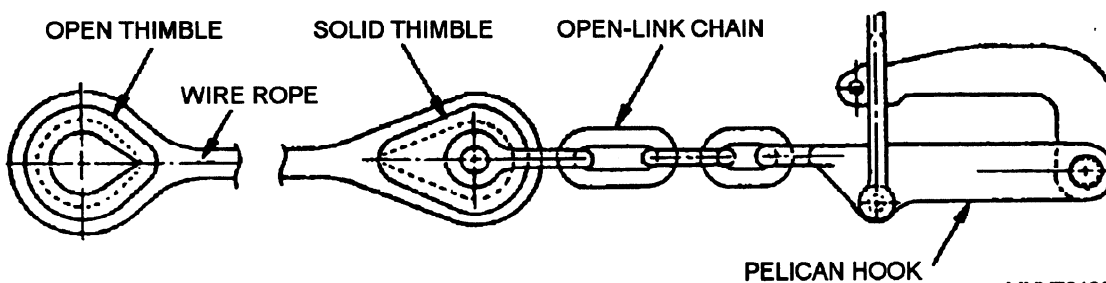

MNV70192

Figure 7-10.—Clear hawse pendant.

Each link of the entire next-to-last shot is painted yellow. The last shot is entirely red. These last two shots are the warning and the danger shots. Their purpose is to show you the approach of the chain's bitter end.

Securing the Bitter End

The bitter end of the anchor chain is secured to a pad eye in the chain locker by a safety anchor shackle. The pad eye, welded to a specially reinforced bulkhead, is rated at 1.75 times the breaking strength of the shackle. The strength of the shackle must approximate the weight of 20 shots of anchor chain hanging from the hawsepipe.

CARE OF GROUND TACKLE

Anchors, chains, and appendages must be kept in good condition by the ship's force. This process involves the actions described below.

The chain should be overhauled whenever necessary, with precautions taken to see that the various shots are properly marked and in good order. As the chain comes in, when a ship is getting under way, each link should be examined for cracks and other defects. Two competent observers, preferably petty officers, should be detailed to examine the chain.

Disassembly of detachable links in the outboard swivel shot with hairpins requires removal and probable destruction of the lockwire. Replacement wire of the same type should be on hand before the lockwire is removed. Replacement hairpins can be fabricated on board ship from corrosion-resistant steel. (See NSTM, chapter 581, or the applicable MRC.)

Anchor chain and its appendages should be carefully examined for cracks, excessive wear, distortion, or other defects. Parts that require coating should be painted with anchor chain gloss black paint. (See NSTM, chapter 581.) Shackle bolts, locking pins, and swivels should be examined carefully and put in order. The turnbuckles in chain stoppers require frequent attention to keep them clean, free from rust, and well lubricated with new lubricant.

At least once each 18 months all anchor chain (including shackles, shackle pins, and detachable links) should be examined, overhauled, and placed in a good state of preservation. To distribute the wear uniformly throughout the length of the chain, the shots should be shifted to new positions as necessary during this

inspection. If, during overhaul of the chain, significant defects are discovered, they should be brought to the attention of the Naval Sea Systems Command. If immediate replacement of a defective shot is not practical, it should be shifted to the bitter end of the chain.

Recovery of Ground Tackle

When a chain has been slipped or parted, every possible means must be used to recover both the anchor and the chain. When recovery by the ship's force is impossible, the lost anchor and chain should be buoyed and bearings taken of the location of the loss.

ANCHORING AND MOORING

Letting go a single anchor is perhaps the simplest way of securing a ship to the bottom, and when the holding ground is good, the ship should ride easily in bad weather, provided an ample scope of chain is used. One disadvantage of using one anchor is that in a strong current, or in a gale, the ship may sheer, or rotate about the anchor, considerably. Also, when a ship is anchored, it swings to the combined efforts of the wind and current. Therefore, it is necessary to have an unobstructed area equal to the length of the ship plus the scope (length) of chain used. If, for some reason, the anchorage does not afford such an area, the ship must be moored.

A ship is moored when the port and starboard anchors are down at a considerable distance apart and with enough chain on each anchor that the ship is held with its bow approximately midway between them. A ship moored requires an unobstructed area the size of a circle with a radius only slightly larger than the length of the ship.

Mooring to a buoy is another way of securing a ship. The buoys are usually anchored with a three-point moor. This requires the ship to use only its anchor chain forward and, if it is mooring bow and stem between two buoys, to also use a mooring line aft. The radius of swing is limited to the ship's length and the scope of anchor chain veered or the area between the two buoys.

Now that we have discussed anchoring and mooring in general, we will cover the equipment used and the personnel involved in letting go a single anchor. Mooring with more than one anchor is covered in other training manuals for Boatswain's Mate and in ship-handling books and courses.

ANCHORING

The ship's First Lieutenant is in charge on the forecastle while the ship is anchoring and weighing anchor. Aboard most ships, the First Lieutenant's assistants are the ship's Boatswain and Chief Boatswain. In their absence, the senior PO of the division responsible for the ground tackle is the First Lieutenant's assistant. An EN (Engineman) is present to operate the anchor windlass, and an EM (Electrician's Mate) must be in the anchor windlass room to take care of any electrical failure. The First Lieutenant has a telephone talker, whose duty is to relay orders and information between the forecastle and the bridge. The PO in charge of the anchor detail musters the detail and ensures that all necessary gear is available. Several Seamen, whose duties are discussed later, are also required.

Necessary equipment is as follows:

- Detachable link toolbox set
- Chain stopper wrench
- Chain cable jack or anchor bar
- Maul
- Telephones
- Anchor buoy and line

On ships with two wildcats, both anchors are made ready for letting go. While this is being done, the telephone talker receives from the bridge such information as the anchor to be used, depth of water, type of bottom, scope of chain to be used, and any other information pertinent to the operation.

The exact procedures for making the anchor ready for letting go may vary, but the following tasks must be performed: The First Lieutenant or the petty officer in charge must give a safety briefing. All personnel involved in the anchoring evolution must be in the proper uniform; that is, with trouser legs tucked in and wearing safety goggles and hard hats with chin straps. Only necessary personnel may be allowed on the forecastle. The Seaman tending the lead line, in addition to wearing a hard hat, must wear a safety harness and life jacket. All personnel should be quizzed about their jobs, and they must be exact in their answers.

The windlass is tested; the anchor in the hawse is freed. The anchor will be walked out if the ship is anchoring in deep water or if the bottom is rocky; otherwise, the brake is set and the wildcat is disengaged.

All but one stopper is taken off, and the anchor buoy is shackled to the chafing chain or pendant. The chain locker is checked for any loose gear that may become wedged in the chain pipes or come flying out, endangering the personnel on deck.

While the anchor detail gets the ground tackle ready, the Quartermasters on the bridge take bearings, and the navigator plots the bearings on a chart and advises the conning officer of the ship's position. Distances to the anchorage are relayed to the forecastle.

In letting go by the stopper, the weight of the anchor must be on the stopper. The brake will be released on the command "STAND BY".

In letting go by the brake, the weight of the anchor will be on the brake and the stopper with the windlass disengaged. The stopper will be taken off at the command "STAND BY".

At the command "STAND BY", the personnel on the forecastle are alert and ready, awaiting the next command. When letting go by the stopper, two Seaman take stations at the stopper. When the command "LET GO" is given, one Seaman pulls the pin from the stopper tongue. The other Seaman, with a maul, knocks the bail off the tongue of the pelican hook and steps clear, and the chain will pass through the hawse with a roar.

If the anchor buoy was not stopped off with sail twine, the Seaman tending it must let it go exactly at the command "LET GO". On the bridge, the anchor ball is hoisted. The flag is hauled down from the truck, and the jack and ensign are hoisted smartly fore and aft.

You will notice that the ship is moving (usually backing) when the anchor is dropped. This keeps the anchor chain from piling on itself, damaging the chain, or piling on or fouling the anchor.

When the anchor is dropped and hits bottom, the brake should be set to help prevent piling. Reports are made to the bridge informing them on the initial status of the anchor, how much chain is out, what position it tends, and what strain it has on it. The bridge is also informed of whether the anchor buoy is watching. (This means that the buoy has surfaced and marks the location of the anchor.) As the ship gains sternway, the anchor chain is veered out by the brake about a shot at a time to control the speed of the chain. This is continued until sufficient chain is out to ensure that the pull on the anchor is horizontal on the bottom. The brake is now applied, and the anchor is set by the ship's backing down and riding on the chain. Once the anchor is set and

holding, the brake is taken off, and the chain is veered to the desired scope.

As each chain marking passes the wildcat, the report “(Number) fathoms on deck” is made to the conning officer. The direction the chain is tending is indicated by pointing the arm and/or reporting “Chain tending (number) o’clock”. Depending on the preference of the commanding officer, the way reports are given may vary from ship to ship. These reports enable the conning officer to maneuver the ship properly.

When the desired scope of chain is out, the order “PASS THE STOPPERS” is given. The brake is set, and the stoppers are applied and evened up. The brake is taken off; then the chain is slacked between the windlass and the stopper. The brake is set, and the wildcat is left disengaged. Before the anchor detail is secured, all gear must be picked up and stowed.

Scope of Chain

Under normal conditions, a ship usually anchors to a scope of chain between five and seven times the depth of the water. This is important to prevent losing the anchor or the anchor and part of the chain in heavy weather. When a ship at anchor is subjected to heavy

weather, a strain much stronger than normal is placed on the chain. More and more of the chain’s length lifts off the bottom as the strain increases. When the scope is not long enough, the chain lifts all the way to the shank, and the anchor breaks out and drags before the chain parts. With too long a scope, however, the breaking strain of the chain is reached and the chain parts before its entire length lifts off the bottom.

Weighing Anchor

When the ship is weighing anchor, the same gear and personnel should be available on the forecastle as for anchoring. In addition, there must be a grapnel for retrieving the anchor buoy, and a saltwater hose must be rigged to wash the mud from the chain and the anchor.

The following procedures are carried out in making ready for weighing anchor. After the windlass is energized, the anchor windlass is tested. Then the brake is set, and the riding stopper is cast off and cleared from the chain. The anchor is now engaged, held by the brake and backed up by the housing stopper. When everything is ready, the report “Ready to heave in” is made to the bridge.

The ship will be riding on its anchor chain, as shown in view A of figure 7-11. If the wind or current is strong,

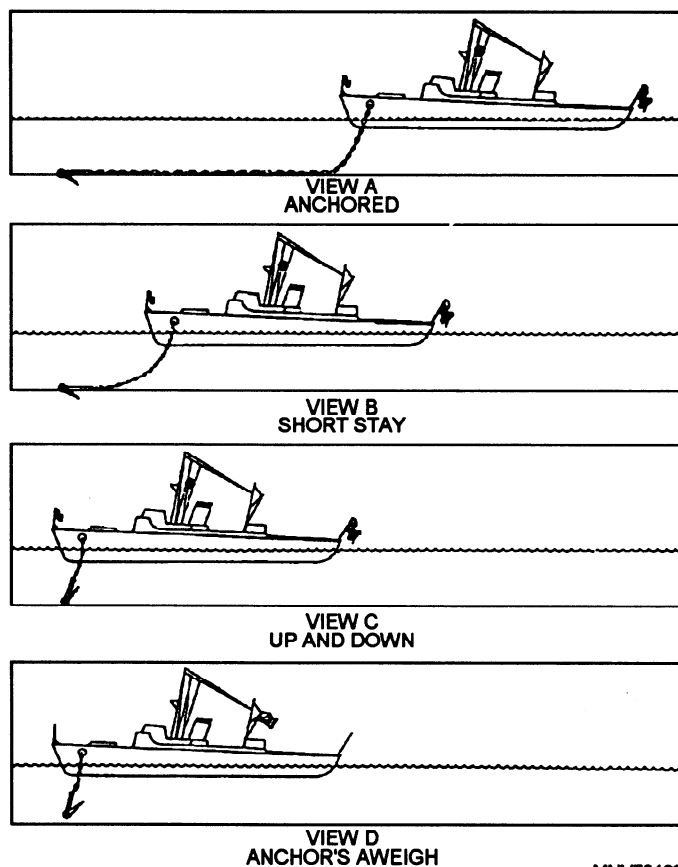

MNV70193

Figure 7-11.—A ship from anchored to under way.

the conning officer may put on enough turns (screw turns) to take the strain off the ground tackle.

On the command "HEAVE AROUND", the brake is taken off and the chain is heaved in enough to take the strain off the stopper. The stopper is cast off, and heaving around is resumed. Reports are made to the bridge periodically on the direction that the chain is tending, the amount of chain out, and what kind of strain is on the chain.

If the command were "HEAVE AROUND TO SHORT STAY", the chain would be heaved in just short of breaking out the anchor, as seen in view B of figure 7-11. The bridge is notified when the chain is at short stay.

When the command "HEAVE AROUND AND UP" is given, the chain will be heaved in. When the flukes of the anchor have broken out and the crown still rests on the bottom, the bridge is notified "Anchor breaking ground", and then "Anchor is up and down", as seen in view C of figure 7-11.

When the anchor is free from the bottom, the bridge is notified "Anchors aweigh", as seen in view D of figure 7-11. The jack, ensign, and anchor ball will be hauled down, and the underway ensign hauled smartly to the truck.

When the anchor comes into view and its condition can be noted, the report "Anchor in sight" is made. With this report, the bridge is told if the anchor is clear, fouled, or shod (meaning caked with mud and bottom).

The anchor is reported as housed when the shank is in the hawsepipe and the flukes are against the ship's side. The anchor buoy is recovered as soon as possible, and the report is made to the bridge when the anchor buoy is on board.

The anchor is again made ready for letting go and kept that way until the anchor detail is told to secure it after the ship is outside the harbor or channel.

To secure the anchor for sea, the brake is set; then the stoppers are passed and evened up (meaning that they take equal strain). The brake is taken off; then the chain is slacked between the wildcat and the stopper. The brake is set and the wildcat is disengaged. To prevent water from entering the chain locker, the buckler plates are secured over the chain pipes (on some ships, canvas chain pipe covers go over the plates).

MOORING TO A BUOY

When the ship is about 1,000 yards from the mooring buoy, a boat containing a buoy party of three or

four personnel, in addition to the boat's crew, is lowered to the water. All hands in the boat must wear life jackets and must be qualified second class swimmers.

The ship is maneuvered so it will come to a stop with the bow directly over the buoy. The boat comes alongside the buoy and two members of the buoy party get on the buoy. Then the crew members in the boat take from the ship the ends of the dip rope, a messenger, and a mooring/buoy wire with a mooring shackle that is large enough to engage the ring on the buoy. The shackle pin is secured to the shackle with a lanyard to prevent its loss. The wire is shackled to the ring, and the dip rope is passed through the ring and tied to the messenger. Then the crew gets back into the boat, and the boat clears the buoy.

Meanwhile, these mooring preparations are made on the forecastle: The anchor is disconnected, and the mooring shackle is secured to the anchor chain. The dip rope is fastened to the chain a short distance above the shackle. The other end of the dip rope is pulled back aboard by means of the messenger and is taken to the capstan. In the meantime, the mooring/buoy wire is heaved taut. The mooring/buoy wire serves to hold the bow of the ship in position. The mooring shackle is pulled into position by walking out the chain and heaving around on the dip rope. The buoy party again gets on the buoy and secures the shackle to the ring. Then the mooring/buoy rope is slacked off, unshackled, and the moor is complete.

Trolley Method

The trolley method of mooring to a buoy is a simple and rapid means of easing the bitter end of the chain (controlled by an easing-out line) down to the mooring buoy by letting it slide on the wire shackled to the buoy. (See fig. 7-12.)

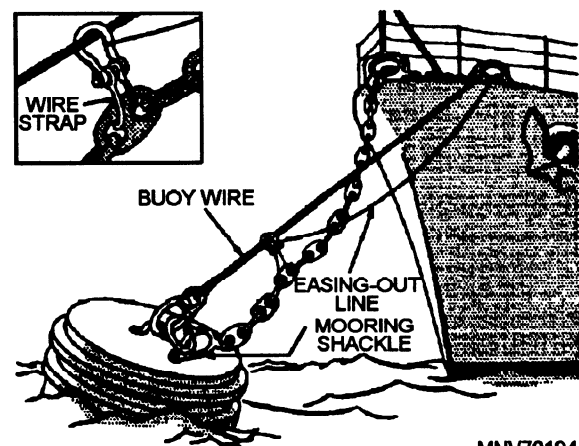

MNV70194

Figure 7-12.—Trolley method.

One or more large shackles over the buoy wire serve as trolleys. The chain is connected to the trolley by a short wire strap passed around the stud of a link near the bitter end. Enough chain must hang free to allow it to be shackled easily to the mooring ring. Connecting it to the fourth or fifth link usually provides the proper amount of free-hanging chain. Other preparations on deck are much the same as for the ordinary method of mooring to a buoy, except that sufficient chain for the maneuver is roused up and allowed to hang in a bight over the side during the approach, and it is not necessary to use a dip rope. The easing-out line, in addition to controlling the travel of the chain during the mooring operation, prevents the bitter end of the chain from dropping into the water during the approach.

When the ship is mooring by the trolley method, the buoy party in the boat takes only the end of the wire to the buoy. The wire is either shackled directly to the ring of the buoy, or a short wire strap is passed through the ring and the eye of the wire, and the ends of the strap are shackled together. The buoy party is always provided with a strap when the size of the ring on the buoy is unknown. If possible, the buoy wire is connected to a ring other, than the one to which the chain will be shackled.

The ship is maneuvered to bring the bullnose abreast of the buoy and about 10 yards away. Once the buoy wire is secured, it is heaved taut and kept that way. The chain is allowed to slide down the wire by slacking off the easing-out line, and the mooring shackle is secured to the ring of the buoy by the buoy party. The wire is then slacked and cast off, completing the moor.

On ships with unusually large and heavy chain, two or more trolleys should be used, and it is a good idea to pass a line from the deck, through the ring of the buoy, and to secure it to the mooring shackle or the first link. Then, by using this line and the easing-out line, the personnel on deck are able to assist the working party on the buoy to get the mooring shackle into position.

Bow and Stern Buoy Moor

The bow and stem buoy moor is used by all navies. It is used throughout the world where the harbors are small and congested or in areas where ships are out of service.

In this type of moor, the ship's bow is moored to the forward buoy in either manner described above. At the same time, a stem line or cable is run to the stem buoy. The ship approaches at an angle of about 20° to the geographical line-of-bearing of the two buoys. While lines are being passed to the bow buoy party, similar

lines are passed from the ship by boat to the stem buoy party. After the lines are made fast to the buoys, adjustments are made from on deck to spot the ship equidistantly, bow and stern, from the respective buoys. Most ships use an anchor chain forward and a nylon towing hawser or a wire rope aft.

Slipping a Mooring

For this maneuver, a strong line or flexible wire is run through the buoy ring and back on deck for use as a slip rope. A strain is taken on it, and the chain is unshackled. Should the ship be riding to a bight of the chain, an easing-out line is used to ease the chain through the ring while the chain is being hauled in. The ship now rides to the slip rope, and unmooring is completed by letting the end of the slip rope go and reeving it through the buoy ring.

TOWING

All naval vessels are required to be able to tow and be towed. Equipment varies with the types of ships, and procedures vary with the circumstances. Equipment used, as well as procedures for towing and being towed, is listed in the ship's towing bill.

RIGGING FOR TOWING OR BEING TOWED

To describe every towing rig would be impractical, so we have limited our description of rigging for emergency towing to the standard synthetic gear and some parts of the wire rigs.

NAVSEA provides the latest guidance concerning authorized synthetic towing hawsers and end fittings. The preferred towline is a nylon rope of nonrotating construction that is either plaited or double-braided. These lines must have a minimum breaking strength within 10 percent of the breaking strength of the emergency tow hawser shown in the ship's plans. NAVSEA does not recommend the use of swivels with any of these towlines.

The towing gear consists of reinforced structure points (referred to here as hard points), a chafing chain, a towing hawser, and connectors. On the towed ship, the chafing chain and hard points are usually made up from the ship's anchor chain and chain stoppers fair-led through the bow chock. A typical arrangement is shown in figure 7-13. On the towing ship, the hard point is provided by a towing pad which is usually located on the centerline, although it is sometimes found on the quarter because of equipment interference. A section of chafing chain is connected to the pad by a pelican hook,

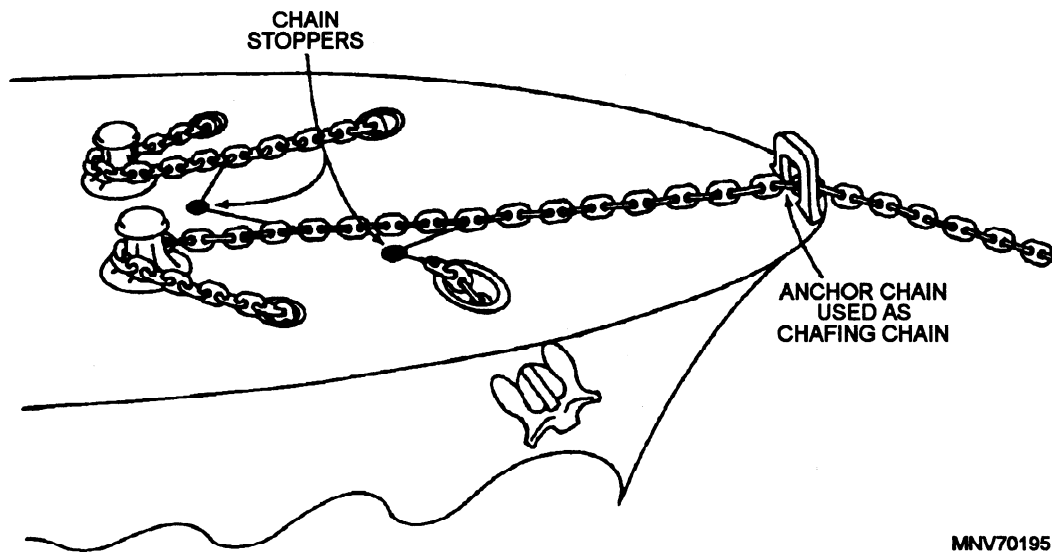

Figure 7-13.—Typical bow chafing chain arrangement for being towed.

which is used for dropping the tow in case of emergency. The other end of the chafing chain is fair-lead through a closed chock on the stern. A typical arrangement is shown in figure 7-14. Since it is logical to assume that the reason a ship has to be towed is because it has lost power, the rigging arrangement aboard the ship to be towed must be laid out so no power assistance is required. Therefore, practice operations should be performed with the towed ship using no power equipment.

Towed-Ship Rigging Procedure

The towed ship rigs for being towed by breaking the anchor chain inboard of the swivel shot. The anchor not in use is secured in the hawsepipe by a chain stopper and a preventer made of wire. The wildcat brake is set up. When the chain pipe has a compressor, it is used to keep the chain from falling back into the chain locker; when there is no compressor installed, a bar through the chain and across the chain pipe can substitute for the compressor. The chain is then moved over in alignment with the bow chock. It will be hauled through the bow chock later by the towing hawser as a strain is taken on the hawser by the towing ship. The connector fittings are standard rigging and detachable links of the size of chain being used. The towing hawser is either wire, whose size and length satisfy the ship's plans, or synthetic hawser 600 feet long. Attached to the hawser is a messenger made up of 100 fathoms of 3-inch line and 50 fathoms of 1 1/2-inch line. (For a lo-inch circumference or larger hawser, use the 4-inch in place of the 3-inch.) Two 100-fathom lengths of 6-thread or 9-thread line are attached to the 1 1/2 line and run outboard on both sides of the ship. Then the 6-thread

line is attached to the shot line, reducing the weight on the shot line while the messenger is passed to the receiving ship. The hawser and messenger are faked out and stopped off to a strongback, with turns of 21-thread line running over a chop block to provide constant control while the hawser is paid out. These stops are cut on command as the hawser pays out. A retrieval line is connected to the anchor chain end of the towing operation to retrieve the towing hawser. The same procedure is followed on the towing ship, except that the pelican hook is rigged to the hard point, and the chafing chain to the pelican hook, fair-lead out the stern chock. You will notice that we have referred to the ship to be towed as being the provider of the rig. Which ship ultimately provides the initial hawser is a command decision, and circumstances will be different in each case.

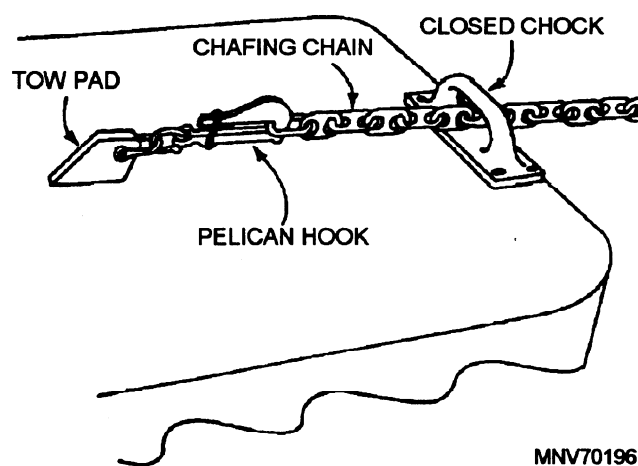

Figure 7-14.—Typical stern chafing chain arrangement for towing.

When both ships' hawsers are used to increase the length of the tow to 1,200 feet (fig. 7-15, one ship will haul in the other's hawser and connect the two hawsers together with a pear-shaped detachable link, then pay out the hawser as the other ship goes ahead, taking up the slack as it goes, until all the hawser is out. When only one ship's hawser is, the ship receiving the other's hawser connects it to either the anchor chain, broken forward, or the chafing chain, rigged aft.

The messenger is secured to the towing hawser as shown in figure 7-16, view A; or if a wire hawser is to be used, it may be modified as in view B. If desired, a third method may be used; that is, a strap is eye-spliced, as an extension to the messenger, and a shackle used to make the connection between the messenger and strap, which is secured to the hawser as in view A.

Approaching the Tow

The position the towing ship takes in relation to the tow during the approach depends on which vessel drifts faster. When the towing ship drifts faster than the tow, the towing ship takes position forward and to windward. When the tow drifts faster, the towing ship takes position ahead and to leeward. The idea is that one ship drifts past the other, allowing more time for passing and hooking up the topline. The towing ship always ensures there is plenty of room to maneuver. If a normal close approach cannot be made, because of sea conditions, the topline messenger may have to be buoyed with life jackets and floated down to the tow. Often, however, the approach is close enough to use heaving lines, so there should be three or four heaving lines on deck, as well as a line-throwing gun and bolos.

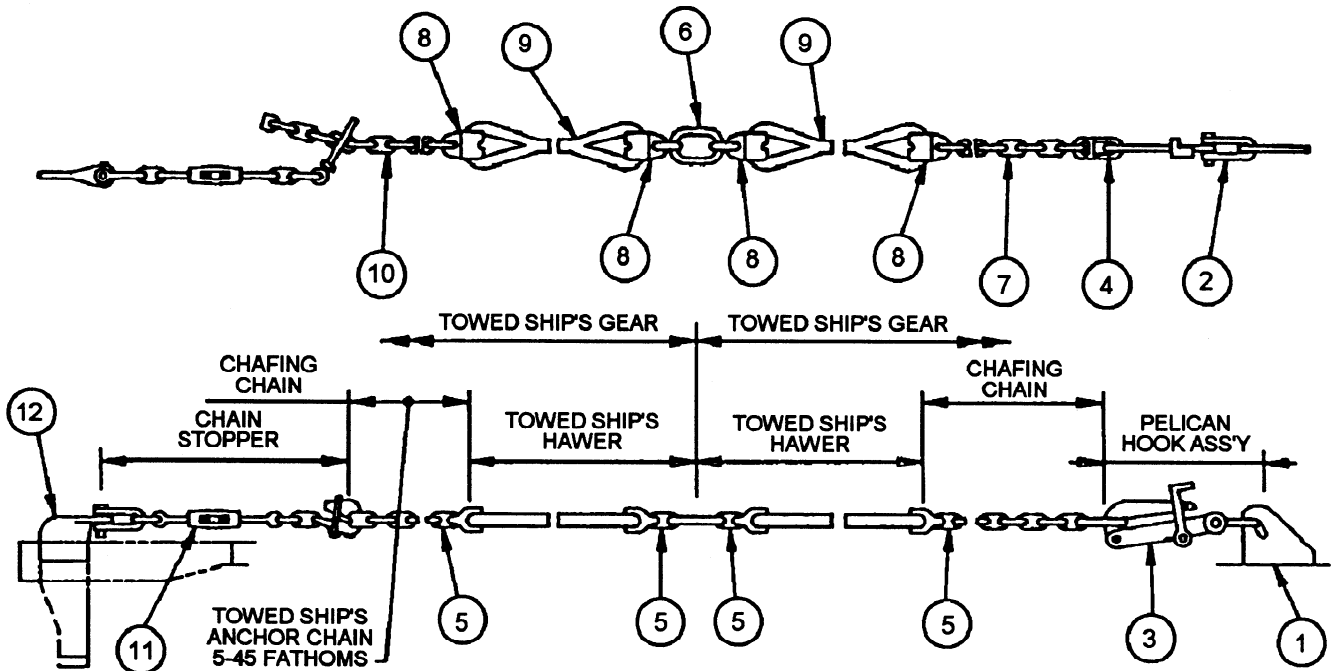

ASSEMBLY OF TOWING GEAR

PIECE	DESCRIPTION	PIECE	DESCRIPTION
1	TOWING PAD	7	CHAIN
2	SHACKLE	8	TOWING THIMBLE
3	PELICAN HOOK	9	TOWING HAWSER
4	END LINK	10	ANCHOR CHAIN
5	DETACHABLE LINK	11	CHAIN STOPPER
6	NATO LINK	12	CHAIN STOPPER DECK PADEYE

MNV70197

Figure 7-15.—Towing hawser arrangement.

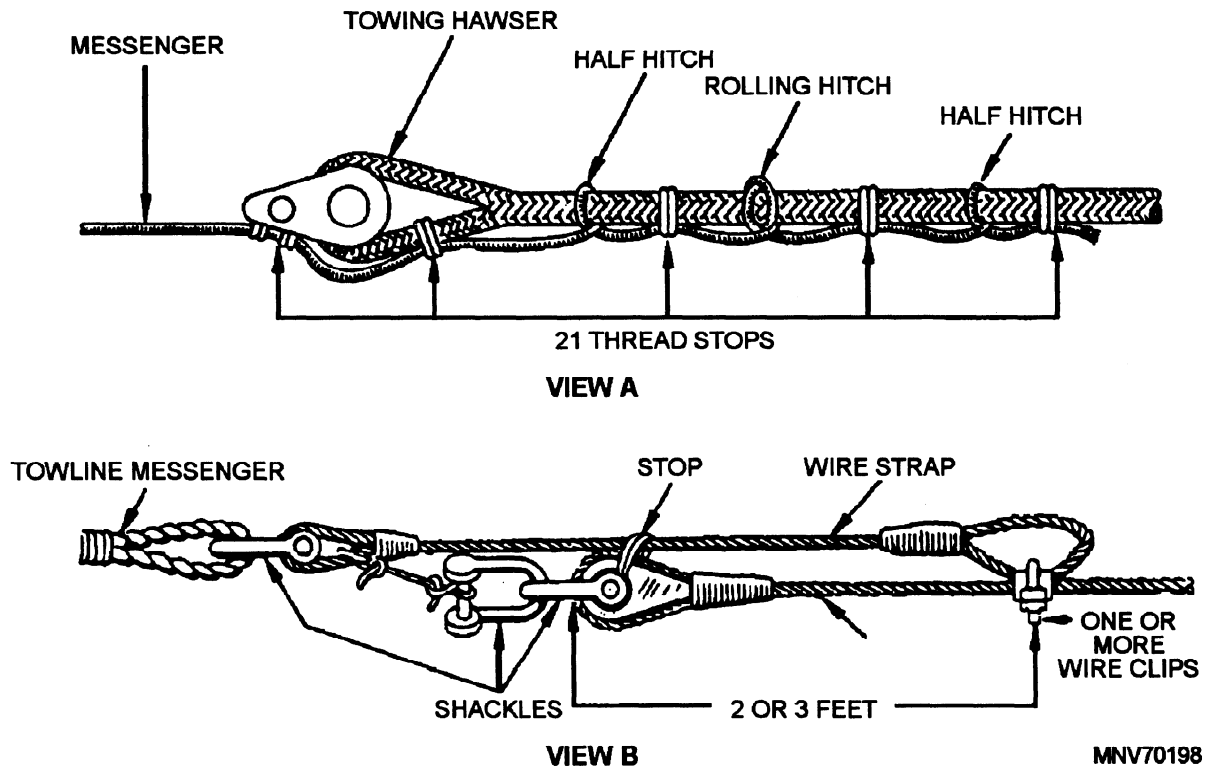

Figure 7-16.—Method of securing messenger to towline.

Passing the Rig

The end of the towline messenger is passed as soon as possible to the towing ship. During the approach, personnel on the towing ship are stationed at intervals along the deck to receive the towline messenger. Once the messenger is received, the end is led through the stem chock and run forward. You may take the messenger to a capstan, but this method is much slower than heaving it in by hand until a heavy strain is taken. The final hauling of the towing hawser is usually done by the capstan. Once the end of the towing hawser is aboard, the seizing that secures the coupling to the messenger is cut, and the towed ship's hawser is connected to your hawser. A stopper is bent onto the hawser; the messenger is removed; and the towlines are hooked up but not yet deployed. The towing ship puts on turns sufficient for steerageway and continues at this steady speed until the towline is completely taut. This slow speed deploys the towline off the towing ship, in a slow orderly fashion, until all the faked out line is off the deck and the chafing chain has been hauled through the stem chock.

The added tension hauls the remaining towline off the towed ship until its anchor chain comes taut. At this point, the bar is removed from the chain over the chain

pipe and the brake on the wildcat is slackened. The chain is permitted to be hauled out until it clears the bow chock by 6 or more feet. The brake is applied and two towing chain stoppers are passed onto the chain.

While a ship is towing, an emergency release capability is required. The chain is veered out to the first detachable link and the stoppers are passed forward of the detachable link. This will provide access to the link in case the tow must be released.

Getting in Step

When a ship is towing with synthetic line, no catenary (line droop) is required. It is not uncommon to have the hawser completely out of the water; in fact, it is desirable because it lowers the towing resistance and prevents the line from being damaged by bottom fouling or objects in the water. When heavy seas are encountered, the rule is slow down. At this point, it is important to keep the ships in step to lessen the surge loads. To do this, cast off the stoppers, and adjust the scope to get the vessels in step. The tow must ride so that it reaches the top of a crest at the same time the towing ship does. If not, the towing ship might reach the crest while the tow is in a trough, whipping the towline out of the water and subjecting it to unnecessary and

dangerous strains. (See fig. 7-17.) When the scope is adjusted properly, the chain is secured in the same way as before.

Dropping the Tow

When the ships are dead in the water and the order is given, the tow engages its wildcat, casts off the stopper, and heaves in on the chain. When the end of the towline is aboard, the messenger is bent on the towline. Turns are taken around the capstan with the messenger, and the chain is walked out until the strain is on the messenger. Then the towline is unshackled and eased out. Personnel on the towed ship run in the towline by capstan or hand. Care must be taken on the towing ship that the catenary does not become too heavy for the crew on the towed ship to handle.

When a recovery line is rigged on the towing ship, the end of it is led through the towing chock from outboard to inboard and hauled in by hand (or, if necessary, by power) until the chafing chain and the inboard end of the towline are aboard. Then the towline is hauled the rest of the way in.

SALVAGE

The term *salvage* covers everything from refloating stranded vessels to wreck removal. World War II provided a prime example of the value of salvage operations. The U.S. Navy salvage organization during this period salvaged and reclaimed ships and equipment worth over 2 billion dollars.

PRINCIPAL TYPES OF SALVAGE

It is, of course, impossible to place all wrecks into a neat category. Nearly all will fall within one of four principal types of salvage. The types of salvage are:

- **RESCUE SALVAGE.** Rescue salvage provides emergency salvage services to vessels and aircraft in distress at sea. The most important service is towing damaged ships to a safe harbor. Fire fighting, pumping, and minor patching also are services a salvage ship can render in an emergency. Major problems are storms and gales, fire, collision, machinery failure, shifting

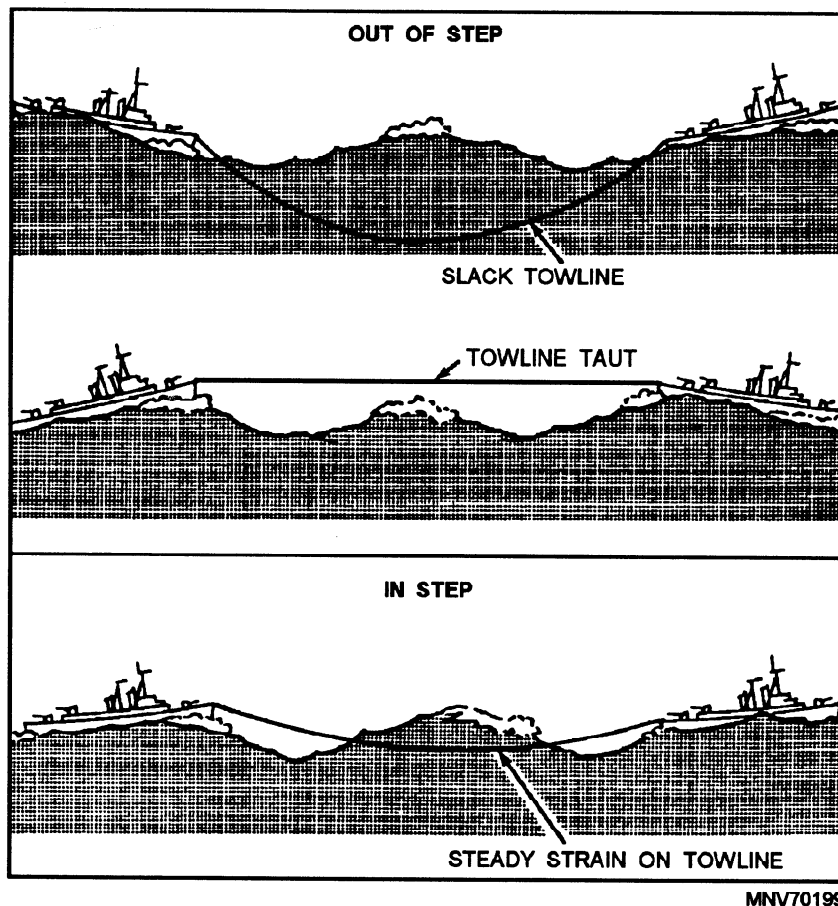

Figure 7-17.—Examples of out-of-step and in-step during towing.

cargo, loss of rudder or propeller, and battle damage.

- **HARBOR SALVAGE.** Harbor salvage consists of salvaging ships, removing wreckage, and general salvage work in harbors. Collision is the chief cause of damage to ships in a harbor. After a collision, either one or both ships may be sunk or beached. One of the ships may sink in the main channel, blocking the channel completely; or it may sink alongside the best pier, preventing cargo unloading. You can be sure of one thing, the Navy will be called upon to provide a salvage ship or salvage team. (In wartime, salvage teams are activated.)

Weather is another major enemy to ships in a harbor. Often a storm strikes without warning, catching harbor craft and barges with single lines out and ships anchored with insufficient chain. The results are beached barges, sunken harbor craft, and stranded ships.

Another feature of harbor salvage is harbor clearance away from the combat area. A great deal of this type of salvage was performed during World War II.

- **OFFSHORE SALVAGE.** Offshore salvage is concerned with refloating vessels stranded or sunk in exposed locations along a coast. Strandings occur as the result of many factors, such as weather, errors in navigation, poor seamanship, improper ship handling, and engineering problems.
- **COMBAT SALVAGE.** Combat salvage consists of services rendered to an amphibious assault force and is not limited to salvage alone. These services are performed by a combat salvage group composed of one or more salvage teams and salvage vessels of all types. This group is manned and equipped to rescue personnel, retrieve stranded craft from the beach, make emergency repairs ashore or afloat, fight fires, give emergency supplies, aid in damage control afloat, tow disabled craft, perform underwater surveys, and do general repair work.

CHAPTER 8

MECHANICAL MINESWEEPING

LEARNING OBJECTIVES

Upon completing this chapter, you should be able to do the following:

1. State the principles and the objective of mechanical minesweeping.
2. Describe the operation of mechanical minesweeping equipment.
3. Recall the various types of mechanical minesweeping.

INTRODUCTION

Minesweeping equipment can be subdivided into two basic types: mechanical and influence. Mechanical gear depends upon physical contact between the sweep and the mine or its attachments. Influence gear (acoustic/magnetic) is designed to actuate influence mines by simulating the influence signature of a ship (magnetic, acoustic, pressure, or a combination of two or more such influences).

The objective of mechanical minesweeping is to cut the mooring cable of the mine. This causes the mine to float to the surface, where it can be either exploited or neutralized.

The standard moored sweep, or OROPESA, is referred to as the "O"-type. Variations of the standard gear are designed to counter mines at very deep or very shallow depths. The basic principles of "O"-type gear are illustrated in figure 8-1.

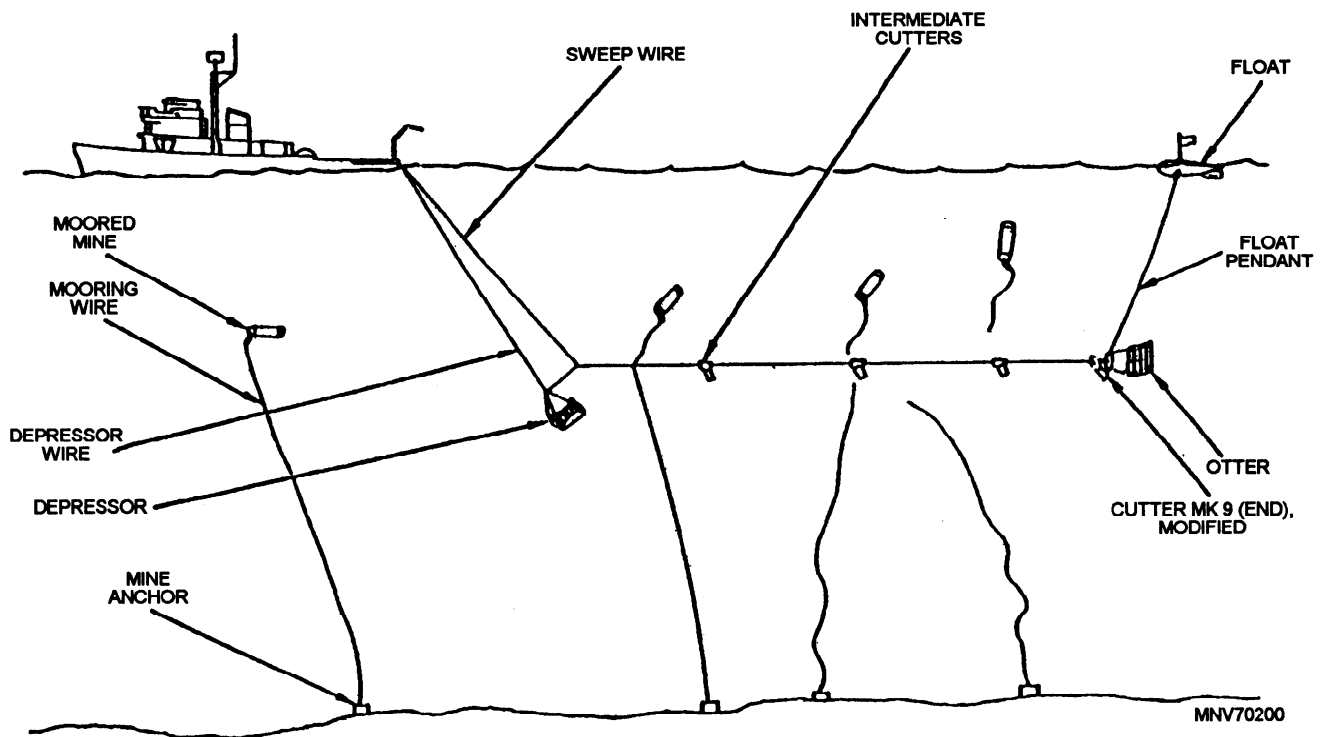

Figure 8-1.—Moored minesweeping.

Figure 8-2 shows the position of equipment on an MCM ship's fantail.

During a sweep, a sweepwire is towed from the stern of the minesweeper at a depth well below the depth at which mine cases are expected to be encountered. Sweepwires may be streamed from one or both sides of the ship. They are diverted, or spread away from the sides of the ship, by an *otter* attached to their outboard end and supported by a float attached with a float pendant.

The depth of the sweep is regulated by the length of the float pendant. To maintain the entire length of the sweepwire at approximately the same depth, a depressor is secured to the sweepwire near its inboard end. The depth of the sweepwire near the inboard end is determined by the length of the depressor tow wire.

Sweepwires are armed with special cutting devices attached to their outboard end (end cutter) and at intervals along their length (intermediate cutters).

When the sweepwire contacts a mine mooring cable, the mooring is cut by one of the cutters or, in some cases, by the sweepwire itself, allowing the buoyant mine case to rise to the surface, where it can be exploited or neutralized.

MECHANICAL MINESWEEPING EQUIPMENT

To this point, we have provided an overview of the mechanical minesweeping operation. The following paragraphs describe the major individual components of a typical mechanical system, such as the sweep and depressor wires, cutters, floats, kites, and bridles.

SWEEP WIRE

A nonmagnetic 5/8-inch, 4,000-foot wire rope with a breaking strength of 32,000 pounds is used as a sweep wire for general minesweeping operations.

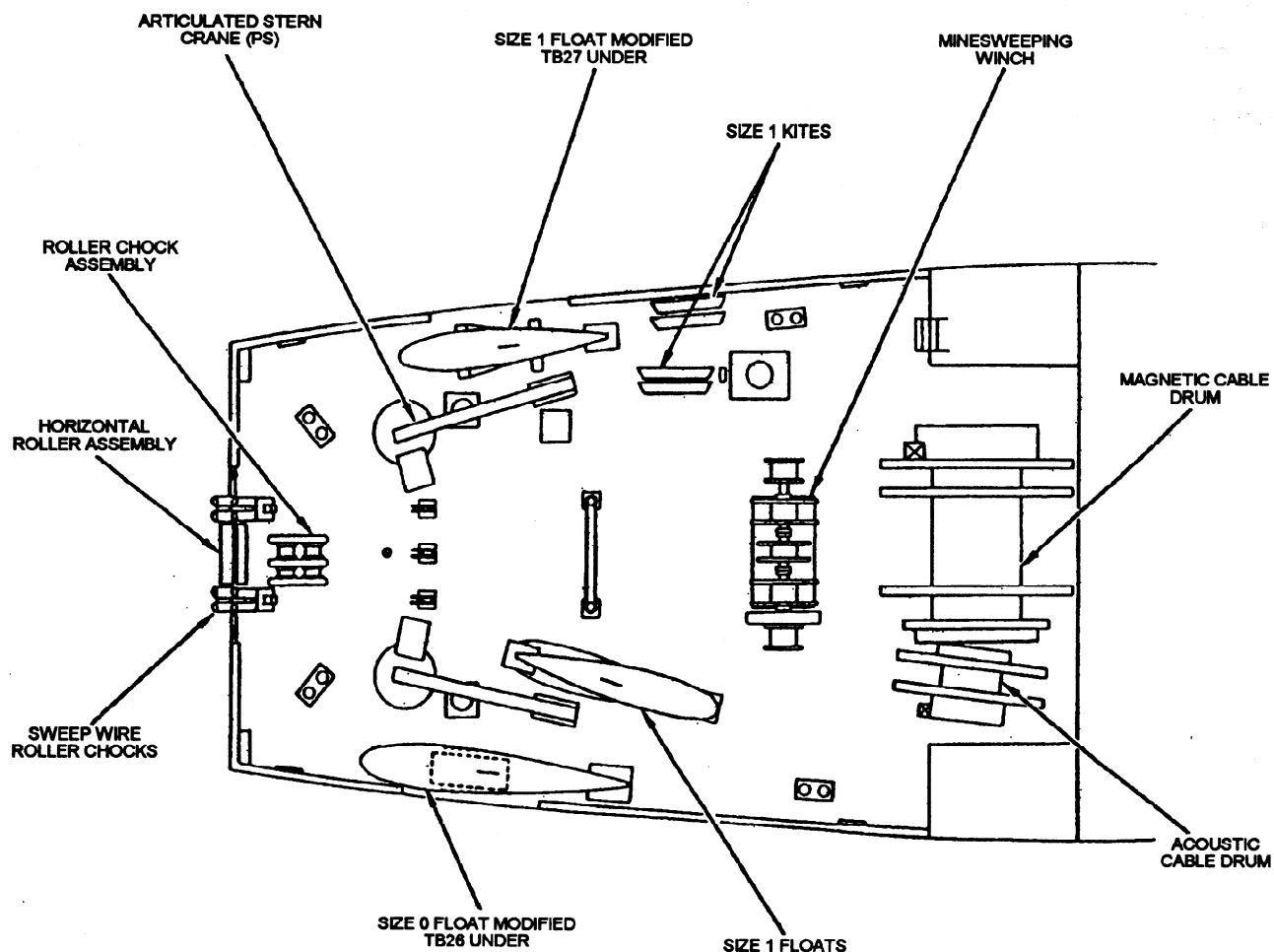

MNV70201

Figure 8-2.—Equipment on an MCM ship's fantail.

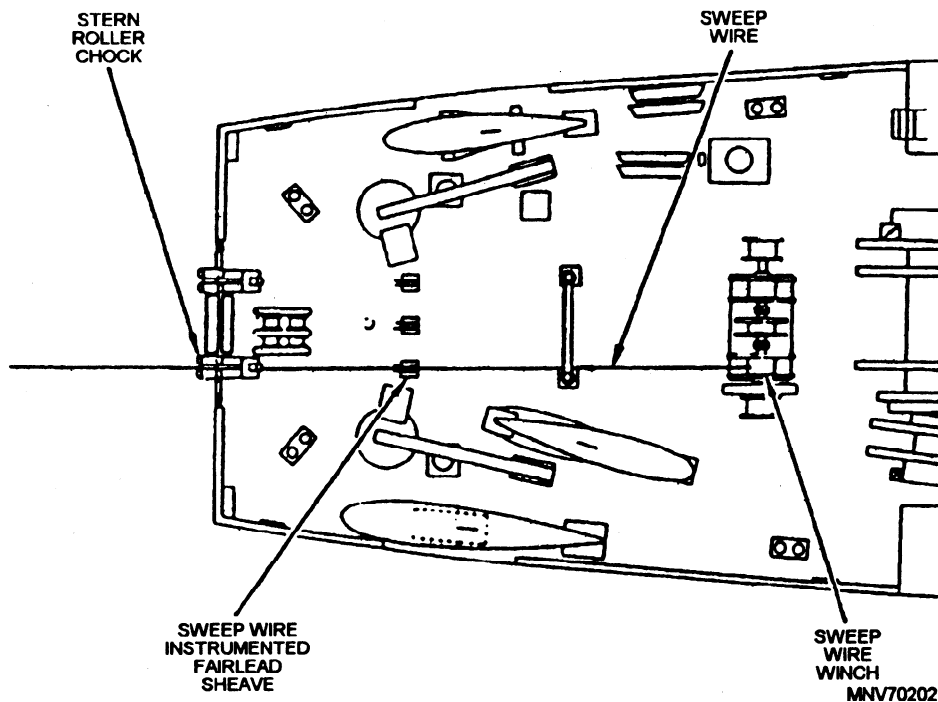

Figure 8-3.—Sweep wire.

An MCM-1 class ship is equipped with two sweep wires. Right-hand lay wire is used on the starboard side and left-hand lay wire on the port side to overcome wire sag during towing operations. The safe working load of the sweep wire is one-half of its breaking strength. Figure 8-3 illustrates the location of the sweep wire on the fantail of an MCM ship.

DEPRESSOR WIRE

The depressor wire is a 5/8-inch, 1,800-foot-t-long wire rope used to tow a depressor that will regulate the depth of the sweep wire. Figure 8-4 illustrates the location of the depressor wire on the fantail of an MCM ship.

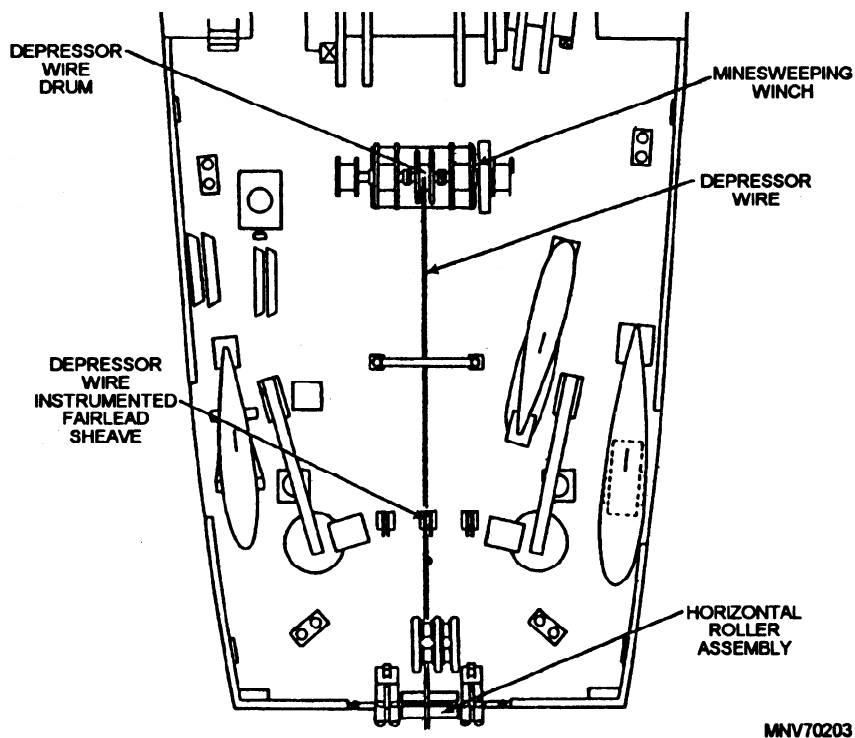

Figure 8-4.—Depressor wire.

MINESWEEPING CUTTERS

Various types of minesweeping cutters, both mechanical and explosive, are in common service use. Mechanical cutters are designed to sever the mine mooring when it is jammed into the jaws of the cutter. Explosive cutters sever the mooring by means of an explosive-driven blade.

Minesweeping cutters are further designated as end cutters, intermediate cutters, or wire rope cutters. The end cutter protects the otter from mine mooring wires. The intermediate cutters, located inboard of the end cutter, are used to cut mine moorings. The wire rope cutters are designed to cut the sweep wire or the depressor wire in an emergency. Table 8-1 lists common types of minesweeping cutters.

Table 8-1.—Minesweeping Cutters

Cutter	Type	Designation
Mk 9 Modified	Mechanical	End
Mk 12 Mod 2 Modified	Explosive	Intermediate
Mk 14 Mod 0 Modified	Explosive	Intermediate
Mk 15 Mod 0	Explosive	Wire rope

Modified Mk 9 Cutter

The modified Mk 9 cutter (figure 8-5) is a mechanical end cutter that weighs approximately 38 pounds. The cutter is made from a nonmagnetic material, with the exception of the cutting blade, which is tungsten tool steel. It is designed to attach close to the outboard end of a sweep. When a mine mooring is jammed into the Mk 9's cutting jaws, the cutter severs the mine mooring. The end cutter protects the otter from fouling.

The Mk 9 cutter can be rigged as either a port or starboard cutter, with a reversible elevating fin and cutting blades. When the cutter is laid on the deck with its jaw facing forward, the elevating fin side down, and the cutting blades on top, the large shackle will point to the side of the ship for which the cutter is rigged.

Modified Mk 12 Mod 2 Cutter

The modified Mk 12 Mod 2 cutter (figure 8-6) is an explosive, one-time use per sweep, intermediate cutter that weighs approximately 25 pounds. It is made from a nonmagnetic material. In a typical minesweeping operation, four Mk 12 cutters are attached to each sweep wire.

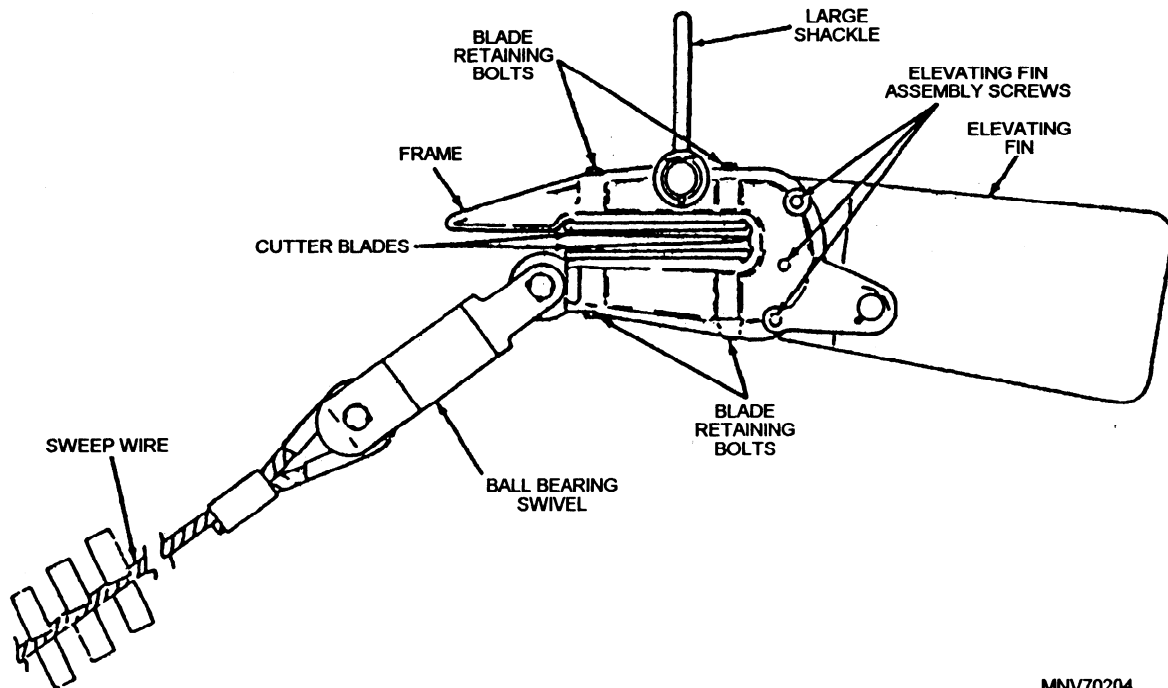

MNV70204

Figure 8-5.—Modified Mk 9 cutter assembly rigged for starboard.

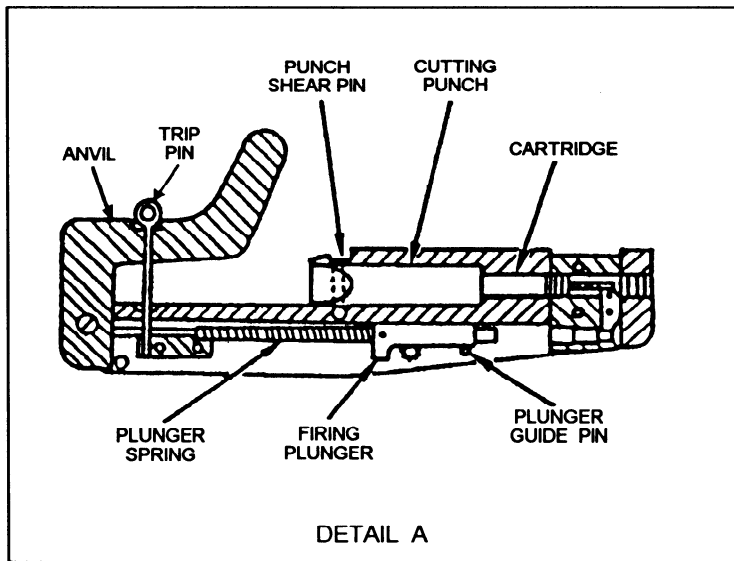
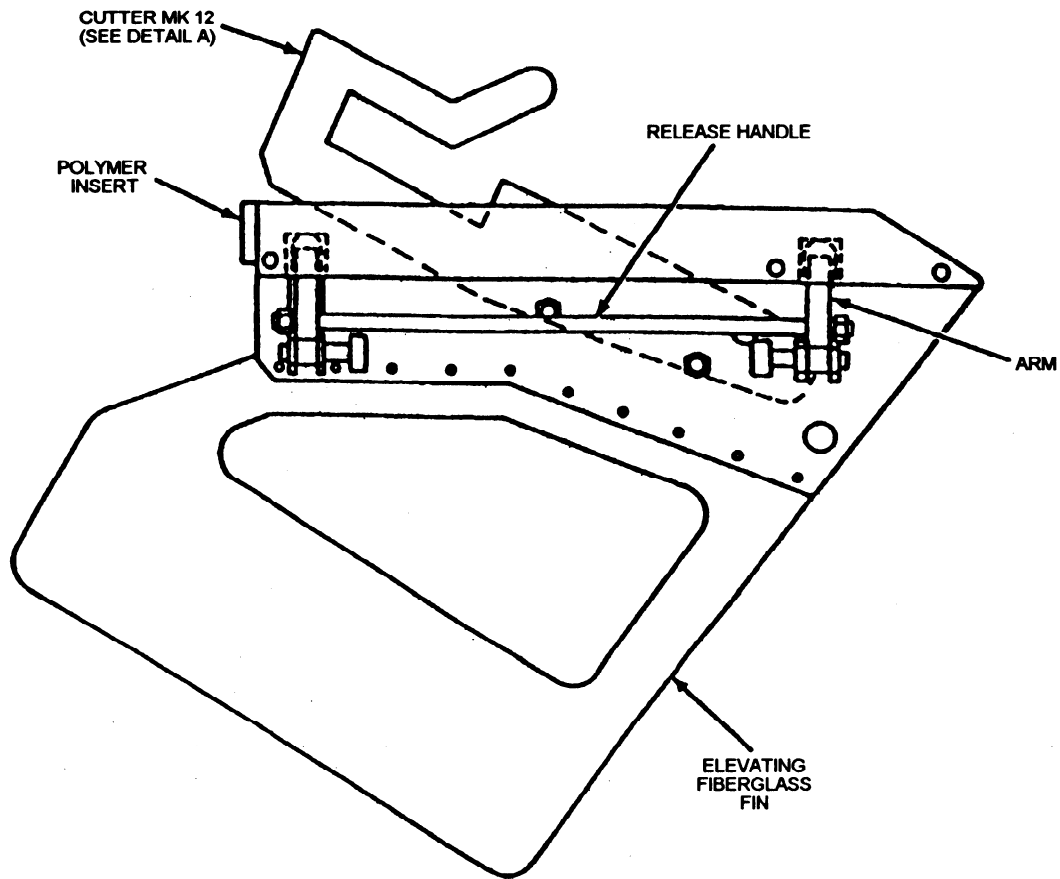

MNV70205

Figure 8-6.—Modified Mk 12 Mod 2 cutter assembly.

The cutter assembly is actuated by a mine mooring striking the trip pin, which releases the spring-operated firing plunger. The plunger transmits its motion to the rocker arm, which causes the firing pin to strike the cartridge primer, firing the Mk 192 cartridge. This

drives the cutter punch forward at high speed, causing the cutter punch to cut the mine mooring and also to shear the anvil screw, which separates the anvil from the cutter body assembly. When the anvil drops away, the way is cleared for succeeding moorings to be cut by the

remaining serviceable cutters attached to the sweep wire. The cutters are interchangeable from starboard to port sweep without modification.

Modified Mk 14 Mod 0 Cutter

The modified Mk 14 Mod 0 cutter (figure 8-7) is an explosive intermediate cutter with quadruple cutters. It

is made of nonmagnetic materials and weighs approximately 33 pounds. The cutter assembly operates in the same manner as the Mk 12 Mod 0 cutter, with the anvil separating from the cutter body after a mine mooring is cut. This clears the way for succeeding moorings to be cut by the remaining units on the Mk 14

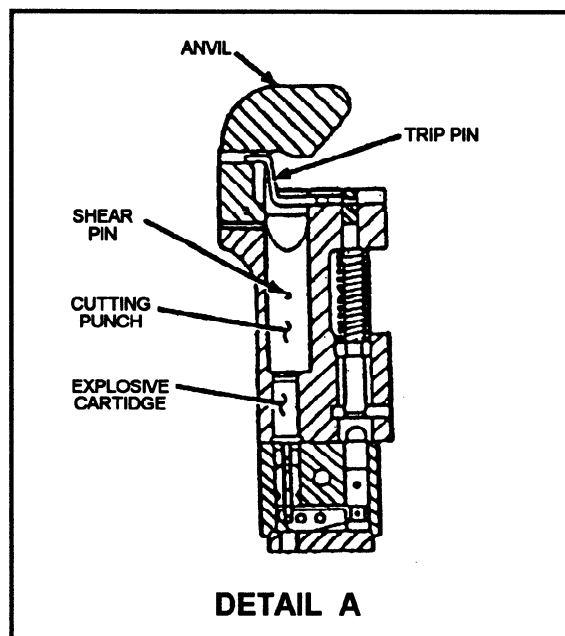
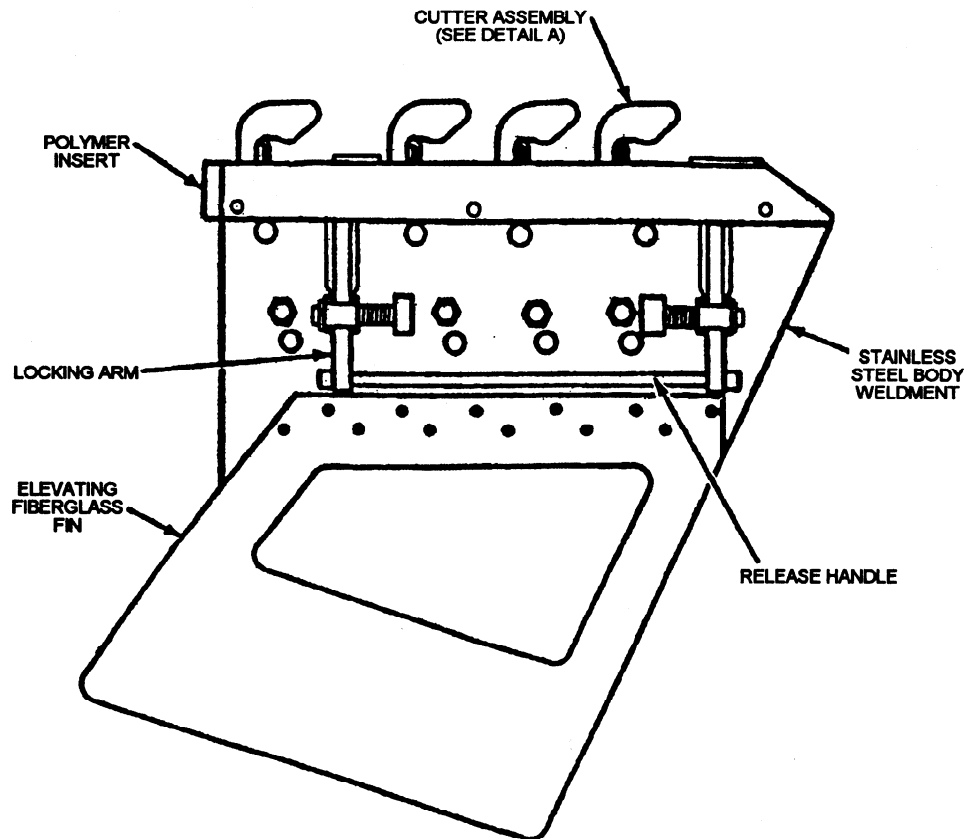

MNV70206

Figure 8-7.—Modified Mk 14 Mod 0 cutter assembly.

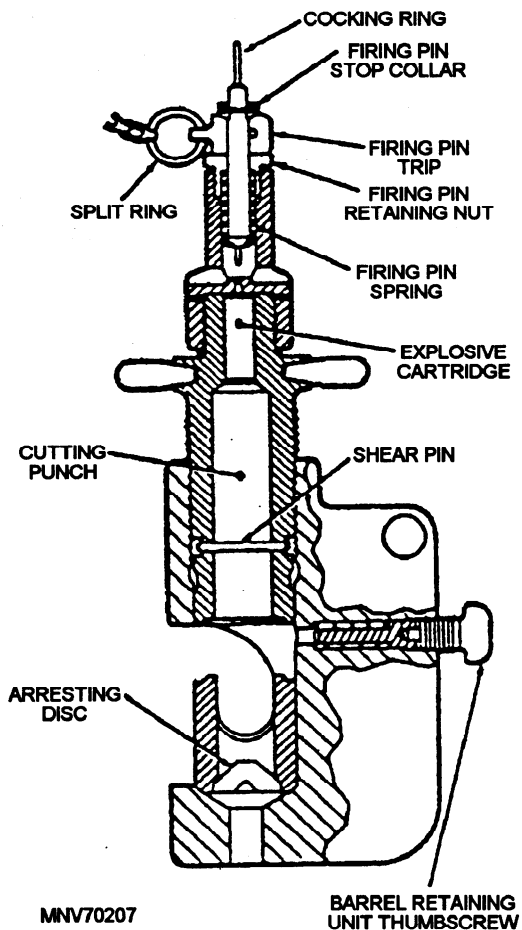

Figure 8-8.—Mk 15 Mod 0 cutter assembly.

Mk 15 Mod 0 Cutter

The Mk 15 Mod 0 cutter (figure 8-8) is an explosive, single-cartridge-operated device designed to cut wire ropes. The cutter is used primarily as an on-deck emergency cutter for severing the sweep and depressor wires in emergency conditions. It is mounted on each sweep and depressor wire in use. Two types of explosive charge cartridges can be used, the Mk 154 for above water use, and the Mk 155 for below water use.

The Mk 15 cutter is actuated by a lanyard, which releases the firing trip pin. The spring-loaded trip pin releases a firing pin which strikes a cartridge that, in turn, drives a punch down the barrel of the cutter, through the wire rope.

FLOATS

The purpose of minesweeping floats is to support either minesweeping otters or acoustic devices during minesweeping operations. The size 1 float (figure 8-9) is used in all mechanical minesweeping operations in support of the otter. The float also serves as a marker for the approximate outboard end of the sweep, allowing the sweep width to be checked by observation from the ship. Otter performance may also be visually checked by observing the depth at which the float rides.

The float's flag, with black and red horizontal stripes, indicates whether a port or starboard sweep is

cutter. The cutters are interchangeable from starboard to port sweep without modification.

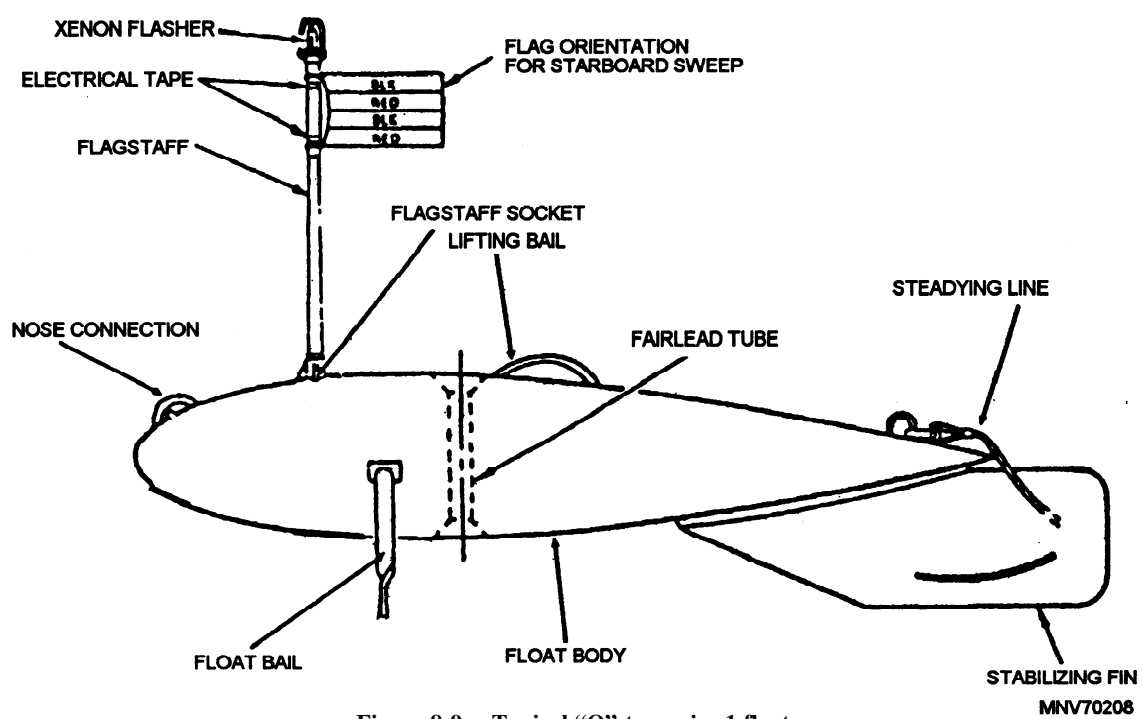

Figure 8-9.—Typical "O"-type, size 1 float.

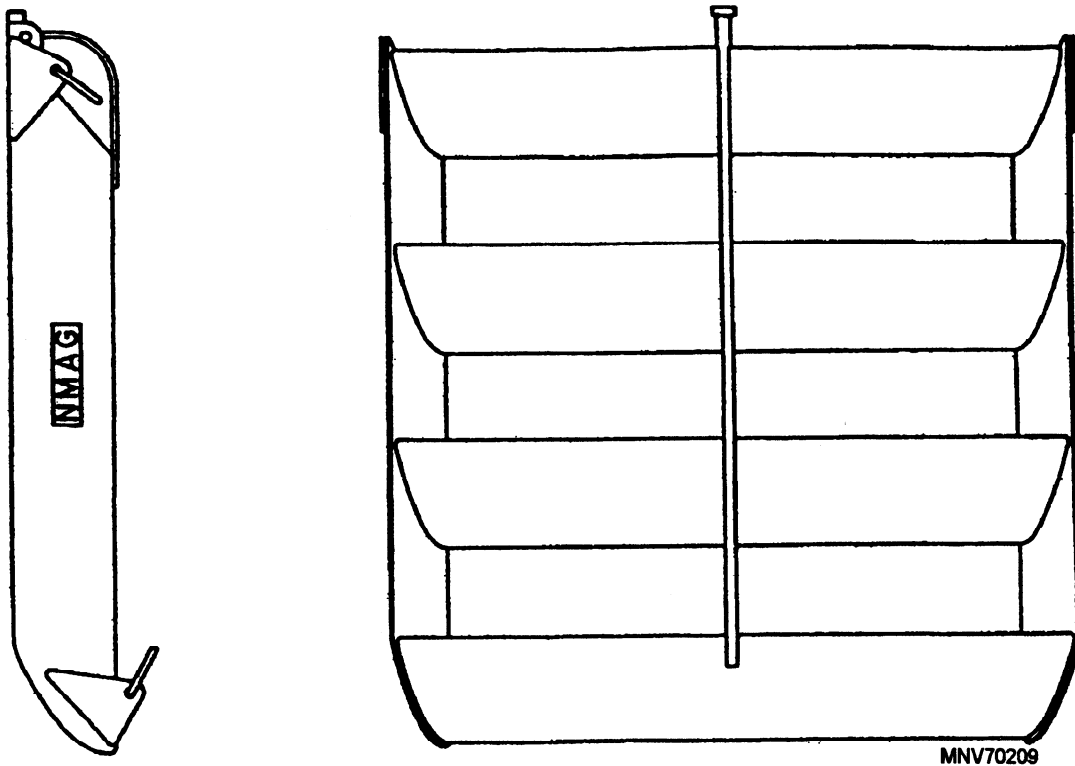

Figure 8-10.—Size-1 multiplane kite.

being conducted. A black stripe on top indicates a starboard sweep; a red stripe on top indicates a port sweep.

MULTIPLANE KITES

The size 1 multiplane kite (figure 8-10) is designed for use as either an otter or a depressor. The function

that the multiplane kite performs is governed by the rigging of the bridle.

Otter

The multiplane kite, when rigged as an otter (figure 8-11), provides span and depth to the outboard end of the sweep (figure 8-12).

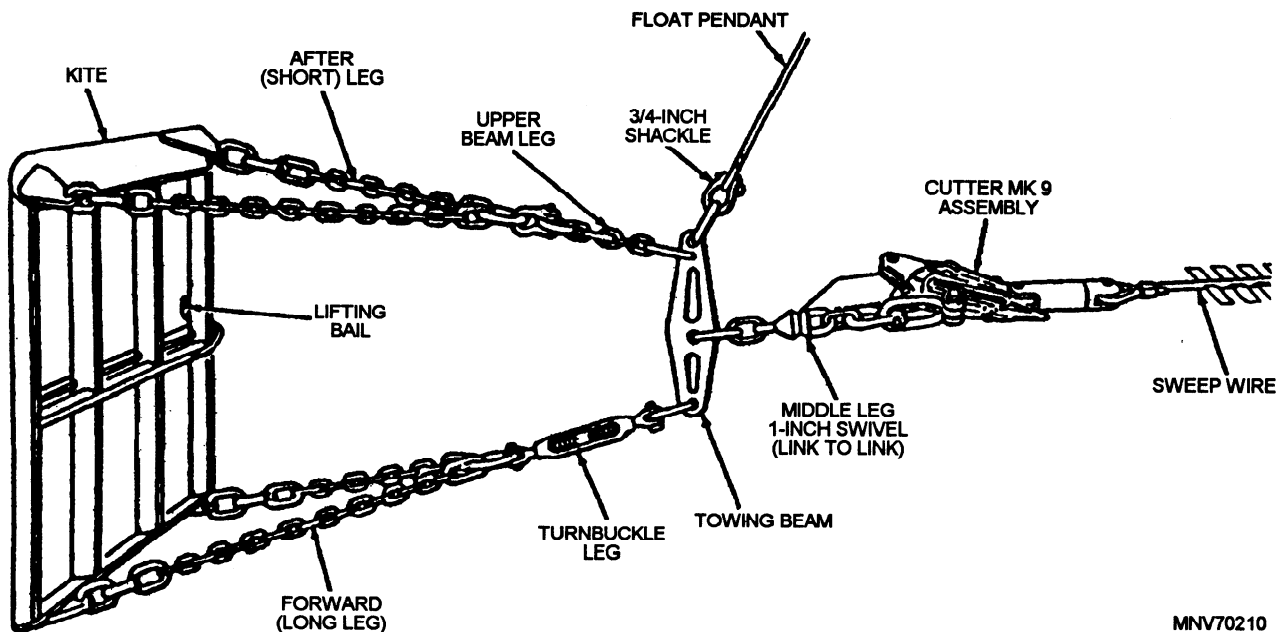

Figure 8-11.—Multiplane kite rigged as a starboard otter.

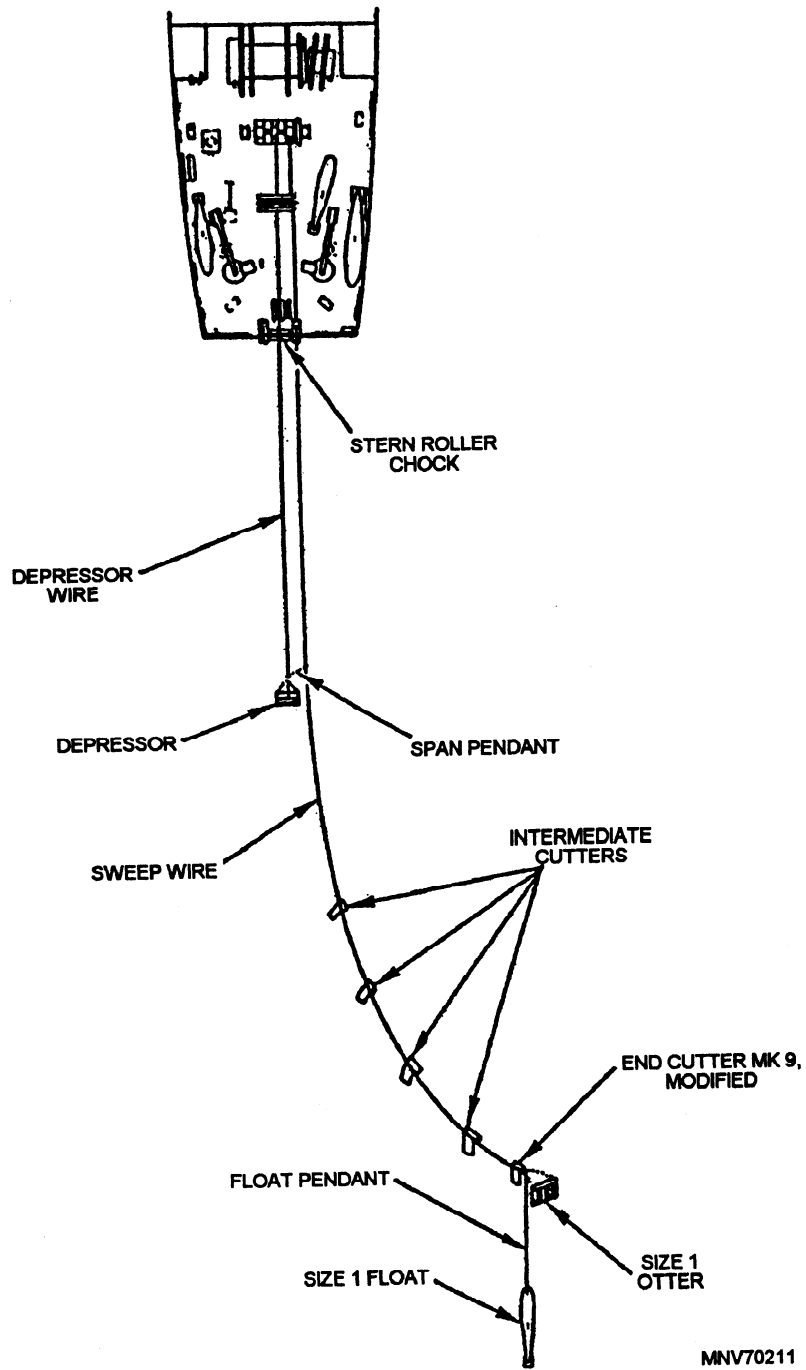

Figure 8-12.—Moored minesweeping “O”-type gear.

Depressor

The multiplane kite, when rigged as a depressor (figure 8-13), provides span and depth to the inboard end of the sweep (figure 8-12).

BRIDLES

Bridles are used to connect multiplane kites to the sweep/depressor wire and to govern their function in the minesweeping configuration.

Otter Bridle

Figure 8-14 illustrates an otter bridle and its components.

Depressor Bridle

Figure 8-15 illustrates a depressor bridle and its components. Some sweeps use both depressor and otter setups.

MECHANICAL SWEEP CONFIGURATIONS

Mechanical sweep configurations, using standard "O"-type gear, are illustrated in figures 8-16 through 8-19.

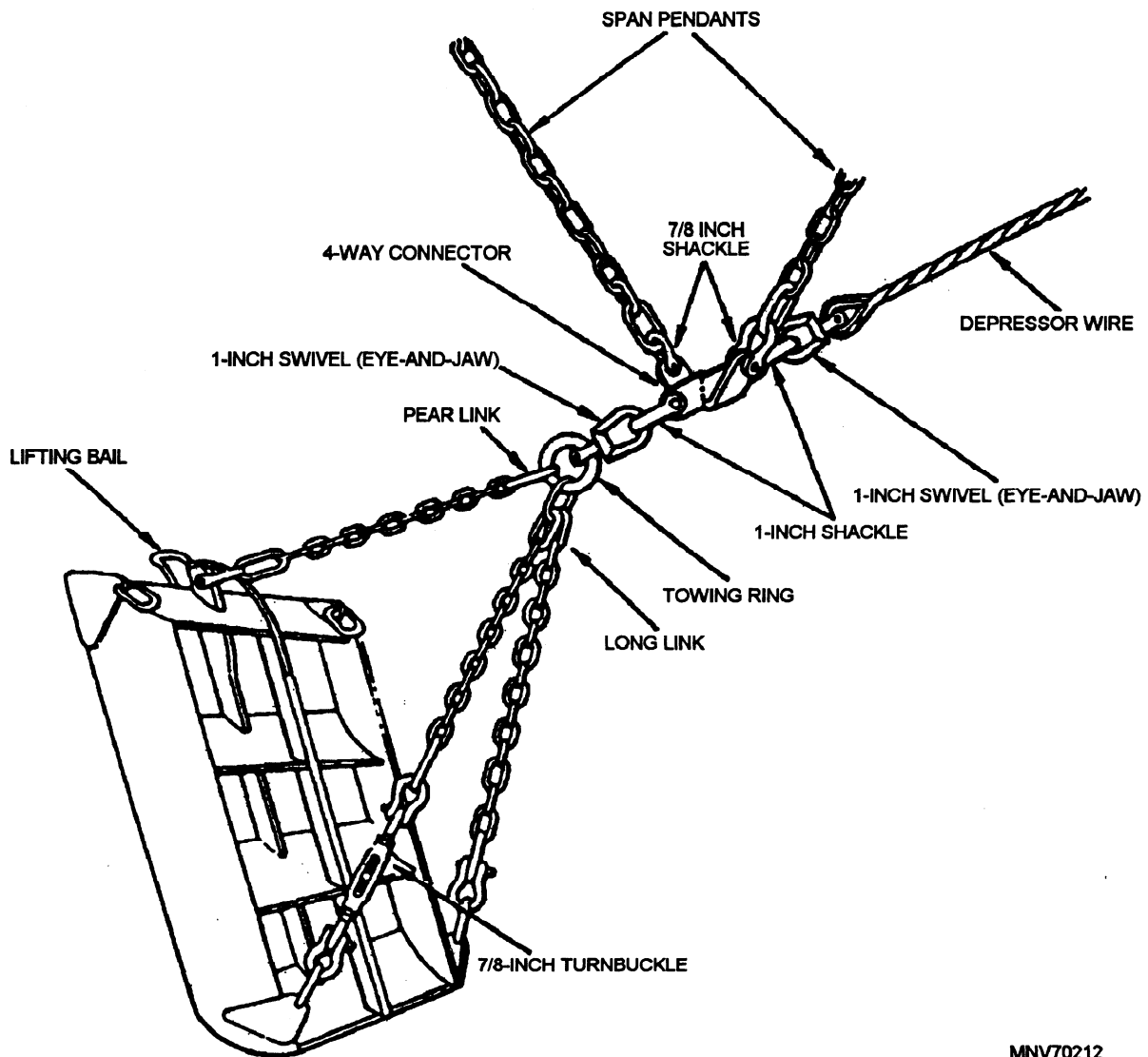
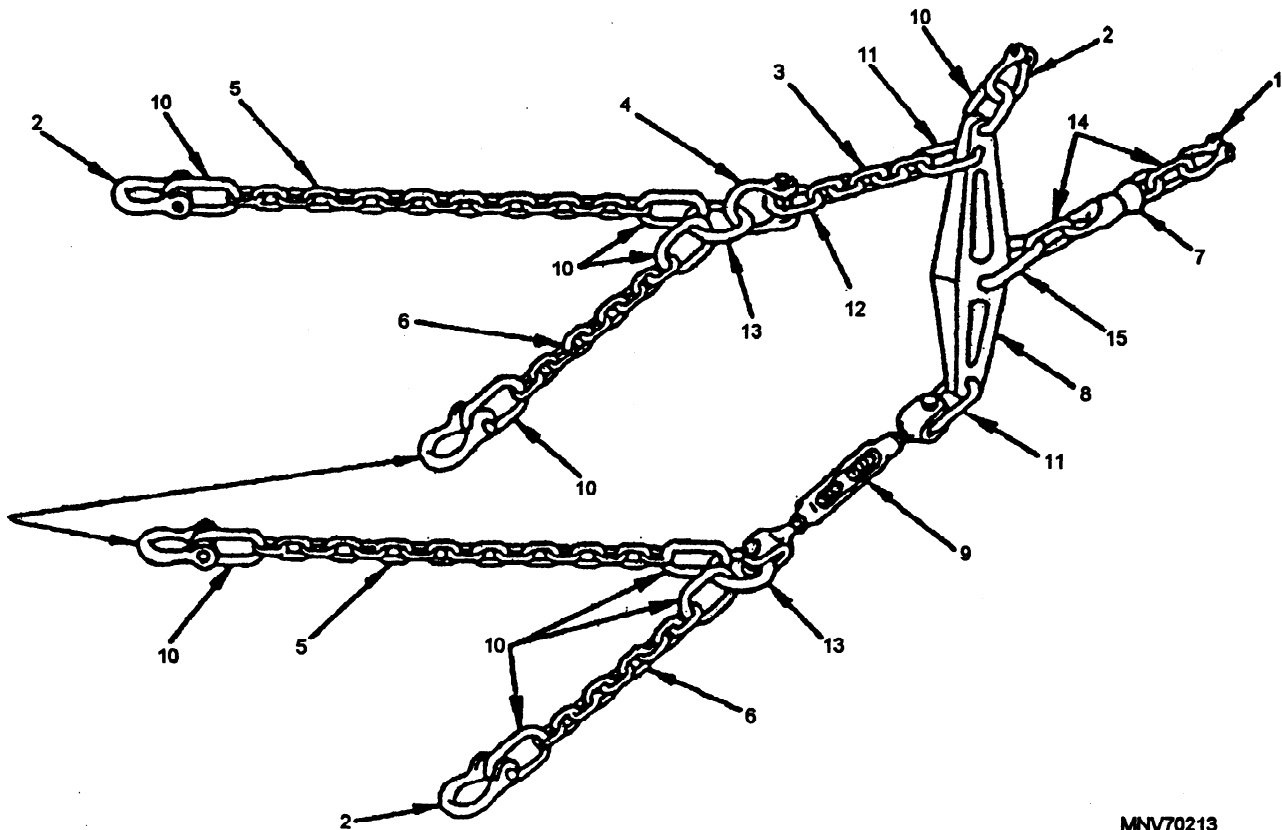

Figure 8-13.—Multiplane kite rigged as a depressor.

MNV70212



MNV70213

- | | |
|---|----------------------------------|
| 1. Shackle, anchor, screw pin, 1-inch | 9. Turnbuckle, 7/8- × 6-inch |
| 2. Shackle, anchor, screw pin, 3/4-inch | 10. Long link, 3/4-inch |
| 3. Upper beam leg, 3/4-inch chain | 11. Long link, 7/8-inch |
| 4. Shackle, anchor, screw pin, 7/8-inch | 12. Long link, 7/8-inch |
| 5. Forward (long) leg, 5/8-inch chain | 13. Ring, 1-inch × 5 1/8-inch OD |
| 6. After (short) leg, 5/8-inch chain | 14. Long link, 1-inch |
| 7. Swivel, link-to-link, 1-inch | 15. Pear link, 1 1/8-inch |
| 8. Beam | |

Figure 8-14.—Otter bridle.

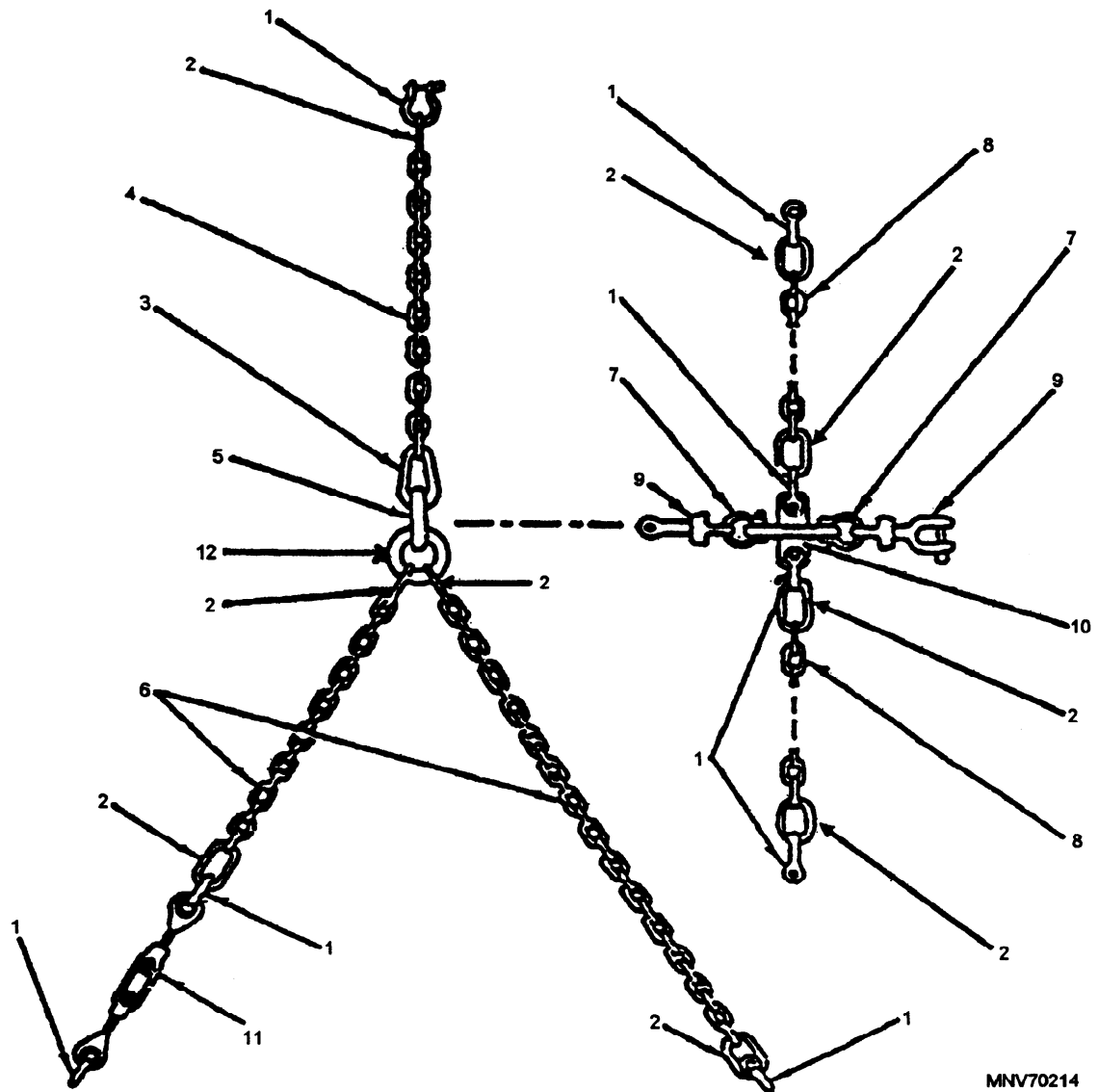

MNV70214

- | | |
|--|--|
| <ul style="list-style-type: none"> 1. Shackle, anchor, screw pin, 7/8-inch 2. Long link, 3 3/8-inch inside length × 7/8-inch dia material 3. Pear link, 5 7/8-inch inside length × 7/8-inch dia material 4. After (short) leg, 3/4-inch chain 5. Ring, towing, 1-inch ID × 1 1/2-dia material | <ul style="list-style-type: none"> 6. Forward (long) leg, 3/4-inch chain 7. Shackle, anchor, screw pin, 1-inch 8. Pendant, span, 3/4-inch chain 9. Swivel, eye to jaw, 1-inch 10. Connector, 4-way 11. Turnbuckle, eye and eye, 7/8- × 12-inch 12. Ring, 3 3/8-inch ID × 1 1/4-inch materials |
|--|--|

Figure 8-15.—Depressor bridle, size 1.

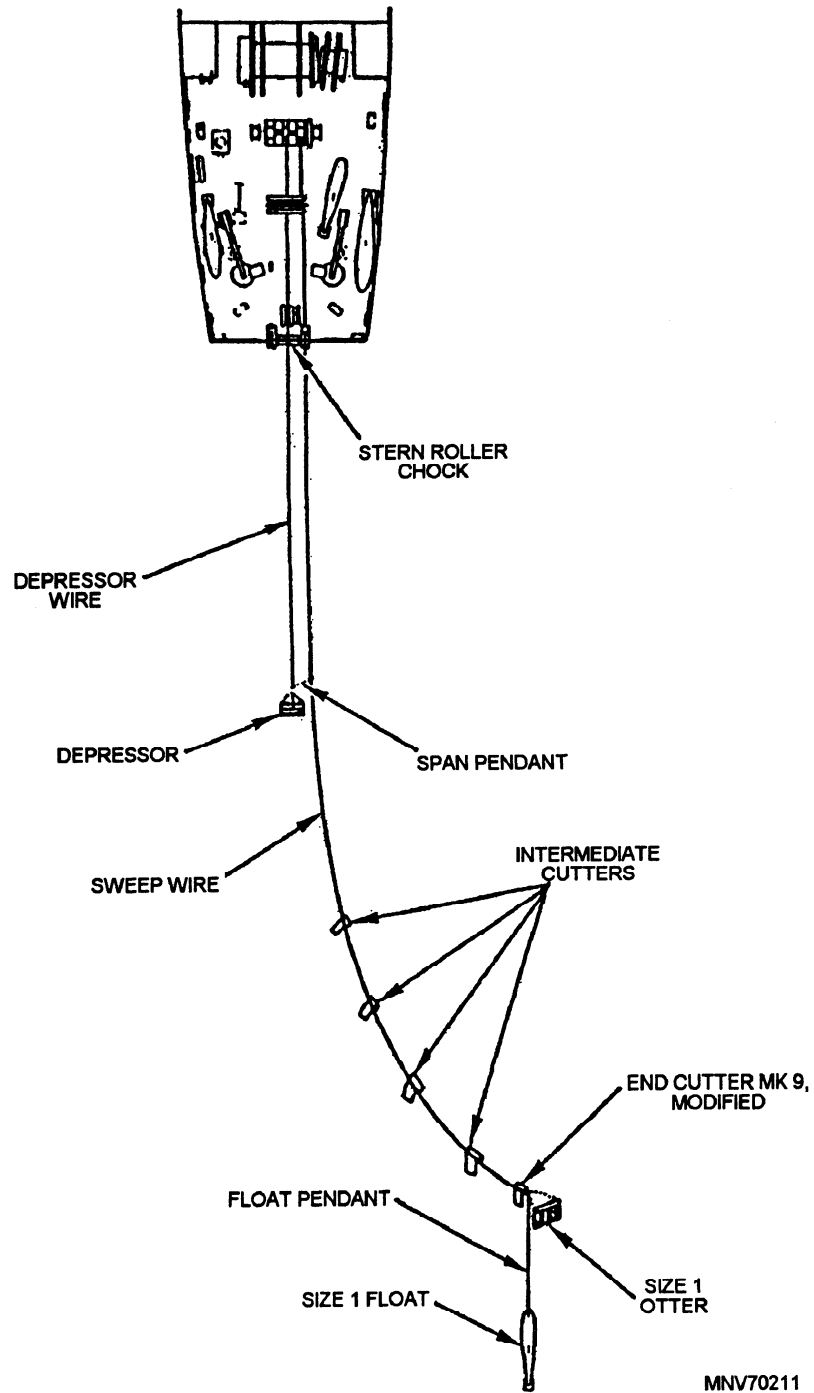

Figure 8-16.—Moored minesweeping configuration (single “O”-type gear streamed to starboard).

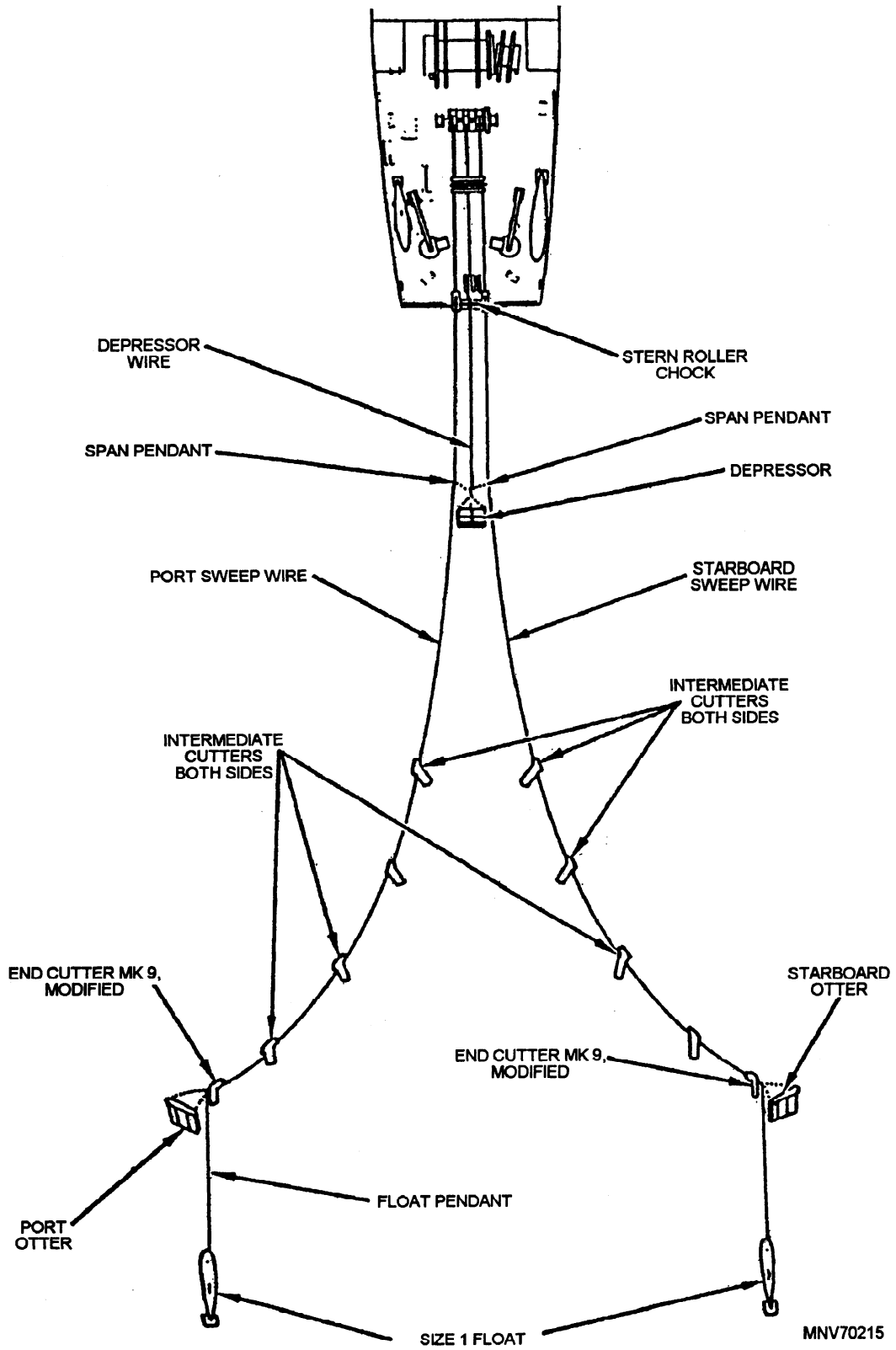

Figure 8-17.—Moored minesweeping configuration (double "O"-type gear streamed to port and starboard).

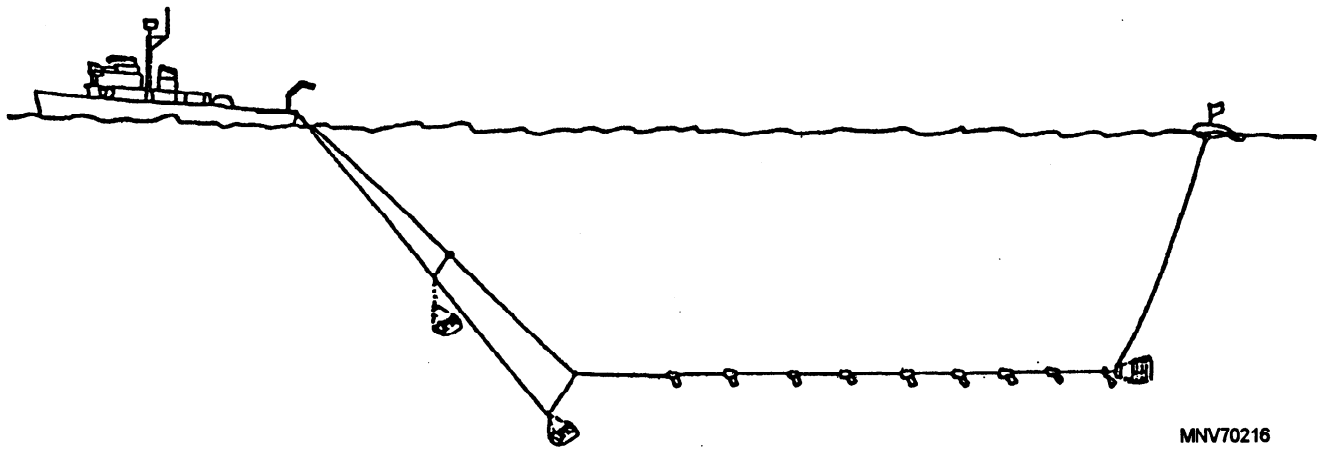

Figure 8-18.—Size 1 deep sweep (Single-ship deep sweep).

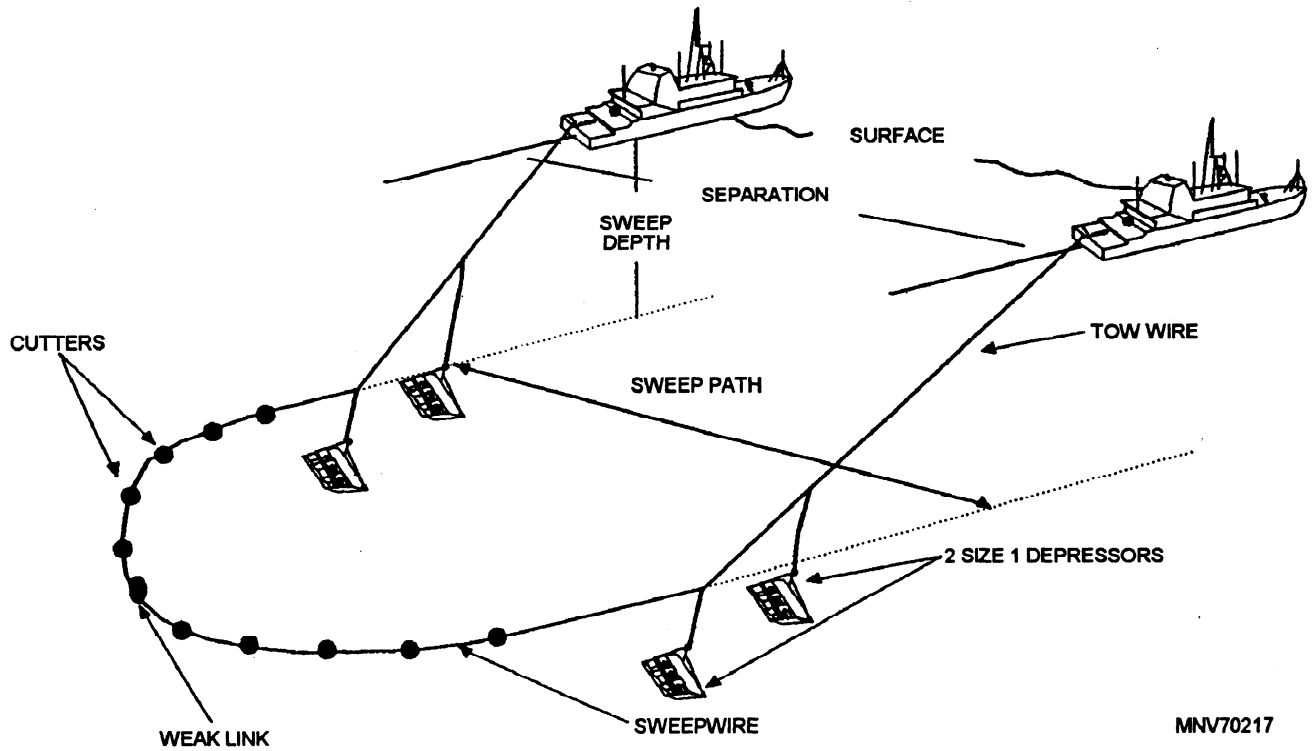

Figure 8-19.—Improved deep moored sweep configuration.

CHAPTER 9

ACOUSTIC MINESWEEPING

LEARNING OBJECTIVES

Upon completing this chapter, you should be able to do the following:

1. Describe the purpose of acoustic minesweeping.
2. Recall the different types of sound frequencies a ship will produce.
3. Recall the purpose and function of acoustic devices and their associated equipment.

INTRODUCTION

Ships under way produce varying amounts of sound (acoustics). Over the years, mines that detonate in response to some of these sounds have been developed. Some of the mines detonate as soon as they detect a certain sound. Others register a count each time they detect the sound and detonate when they reach a specific count. Acoustic minesweeping is used to either detonate these mines or to cause their detecting devices to register a ship count. Table 9-1 lists the types of sounds that may be used to trigger acoustic mines.

Acoustic minesweeping equipment is designed to simulate the acoustic signature of a ship and to detonate the mines a safe distance from the minesweeper.

ACOUSTIC MINESWEEPING EQUIPMENT

Acoustic minesweeping equipment consists of power-driven devices, which are normally towed astern, and waterflow-operated devices that are operated by the flow of water as they are towed.

Table 9-1.—Frequency Ranges and Sources

Frequencies	Sound Sources
Low	Main propulsion machinery, hull vibrations, and propeller cavitation
Medium	Auxiliary and main machinery
High	Hull vibrations and propeller cavitation

ACOUSTIC DEVICE A MK 2(g)

The Acoustic Device A Mk 2(g) (commonly known as *rattle bars*) (figure 9-1) is a mechanical device that produces a chattering sound for countering acoustic influence mines.

The A Mk 2(g) consists of a frame made of three 34-inch parallel bars and two end plates and two 30-inch, movable parallel bars. The two 30-inch bars are mounted at each end to swing arms that allow them to oscillate in the center of the frame. As the A Mk 2(g) is towed through the water, the flow of water between its parallel pipes and bars causes them to hit each other with great force, producing sound. The sound output depends on ship's speed. Higher speed increases the output; lower speed decreases it. During turns, the device has a tendency to stop chattering unless its speed through the water can be maintained.

The A Mk 2(g) is made of corrosion-resistant steel and weighs approximately 135 pounds. It has a relatively short life because of the mechanical stress placed on its parts. This stress increases in proportion to the speed of tow. The device also is subject to fouling by weeds and debris.

AUXILIARY DEPRESSOR

The auxiliary depressor (figure 9-1) is used to prevent excessive hogging (or arching) of the sweep wire at high-speed sweeping operations. It is a roof-shaped device, 23-1/2 inches long, 11 inches wide, and 4 inches high, made of stainless steel, and weighs 15 pounds.

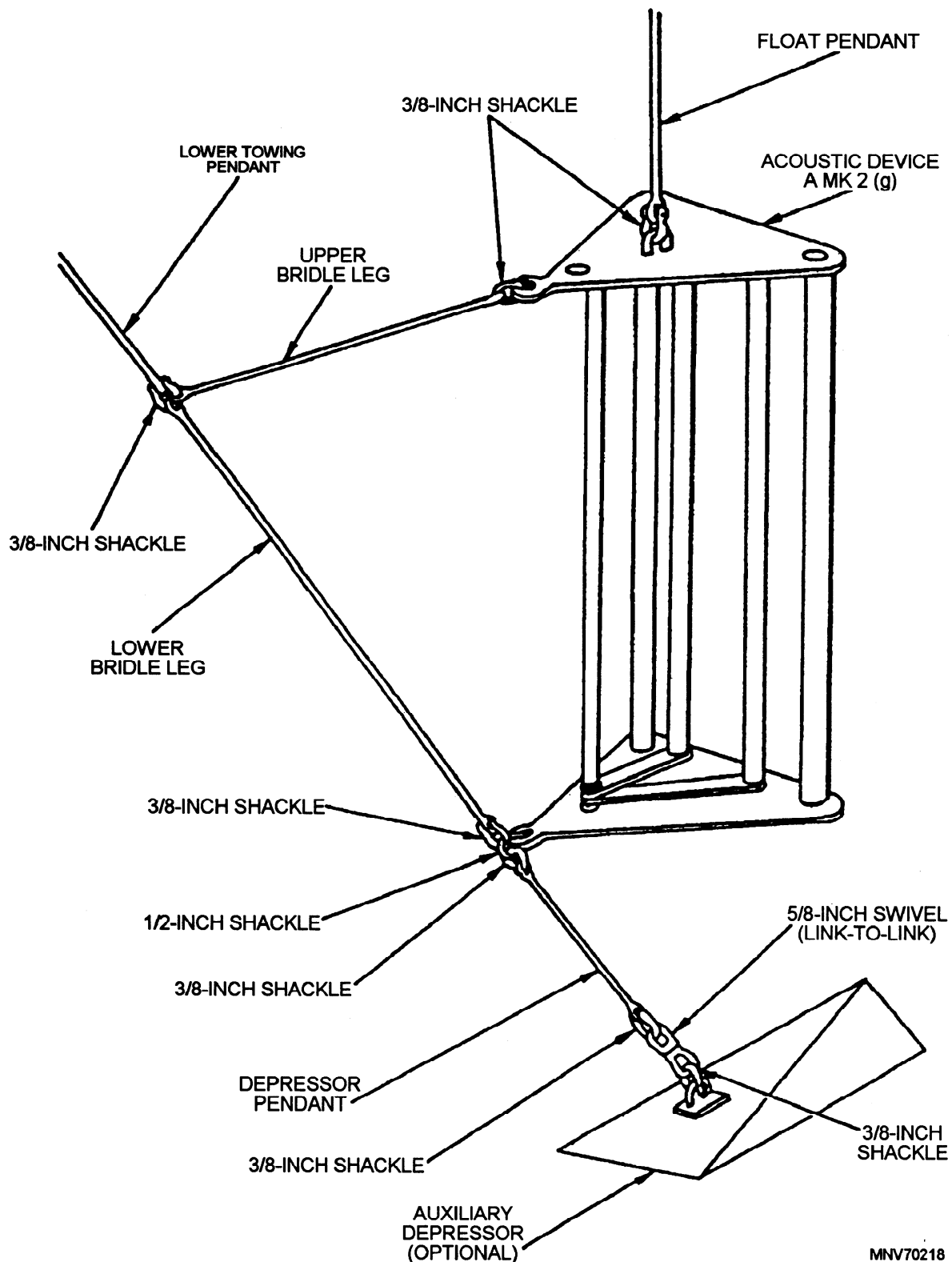

MNV70218

Figure 9-1.—Acoustic Device A Mk 2(g) rigged with an auxiliary depressor.

ACOUSTIC DEVICE, TB-26/A Mk 6(b)

The Acoustic Device TB-26/A Mk 6(b) (figure 9-2) is an electric-motor-driven mechanical oscillator that provides a controlled source of low-frequency acoustic signals for use in sweeping acoustic mines.

It is towed behind the ship by a buoyant acoustic power cable (APC) and provides varying ranges of low-frequency output through the use of selective eccentrics. The assembly uses a motor-driven mechanical oscillator containing two opposing piston

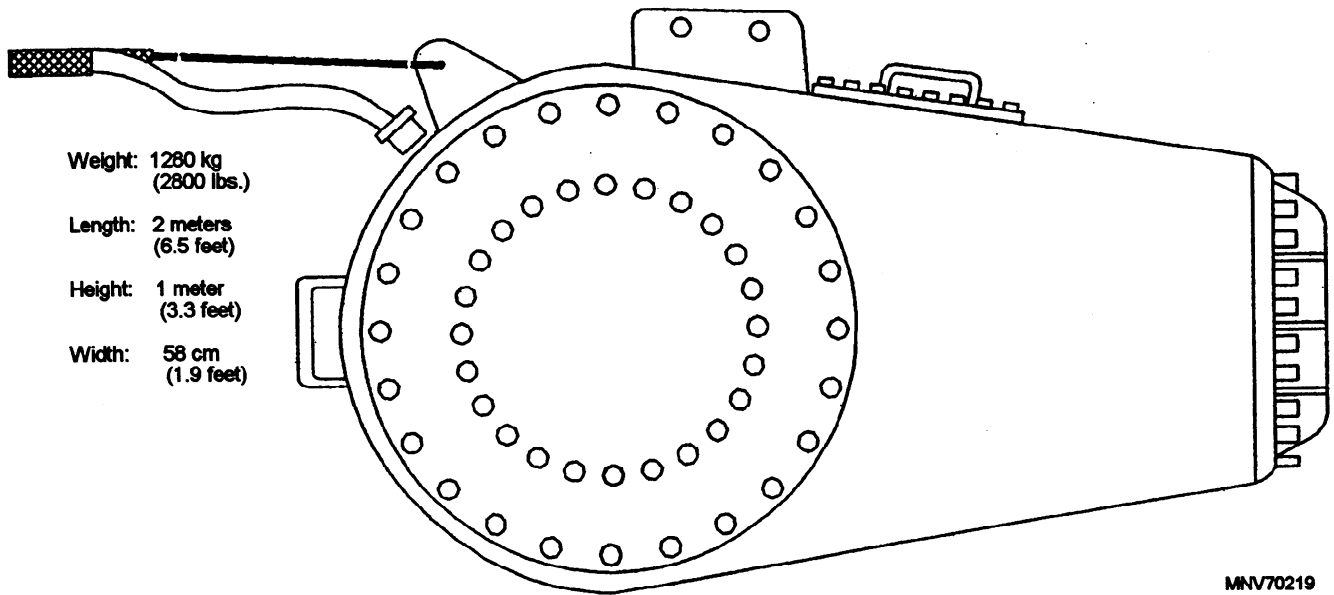

Figure 9-2.—Acoustic Device TB-26/A Mk 6(b).

diaphragms vibrated by the eccentrics. The frequency of the vibration is controlled by the speed of the electric motor within the apparatus.

**ACOUSTIC DEVICE TB-27/A
Mk 4(v)**

The Acoustic Device TB-27/A Mk 4(v) (figure 9-3) is a motor-driven mechanical device that produces controlled sound output for sweeping acoustic mines.

This device is also towed through the minefield by an acoustic power cable. An acoustic controller on board the ship sends voltage through the APC to operate a motor within the TB-27. The motor drives a hammer into a steel diaphragm, causing it to vibrate. By varying the motor speed, the controller can select a sound intensity and frequency appropriate for sweeping mines.

The functioning components of the acoustic device are the diaphragm, the striker assembly, the eccentric

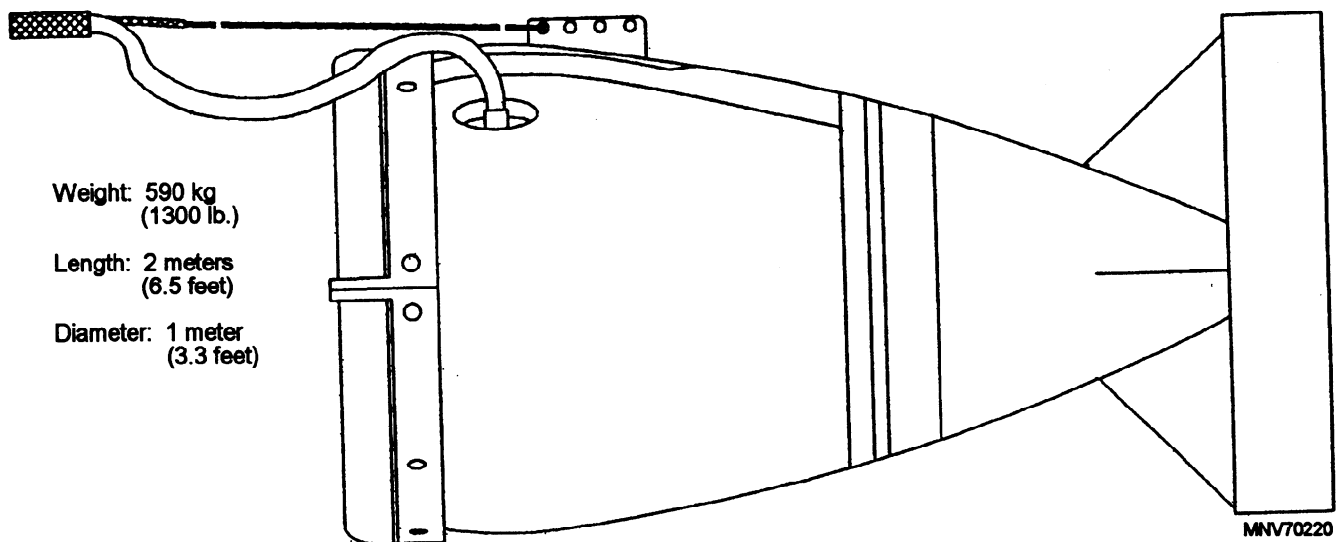

Figure 9-3.—Acoustic Device TB-27/A Mk 4(v).

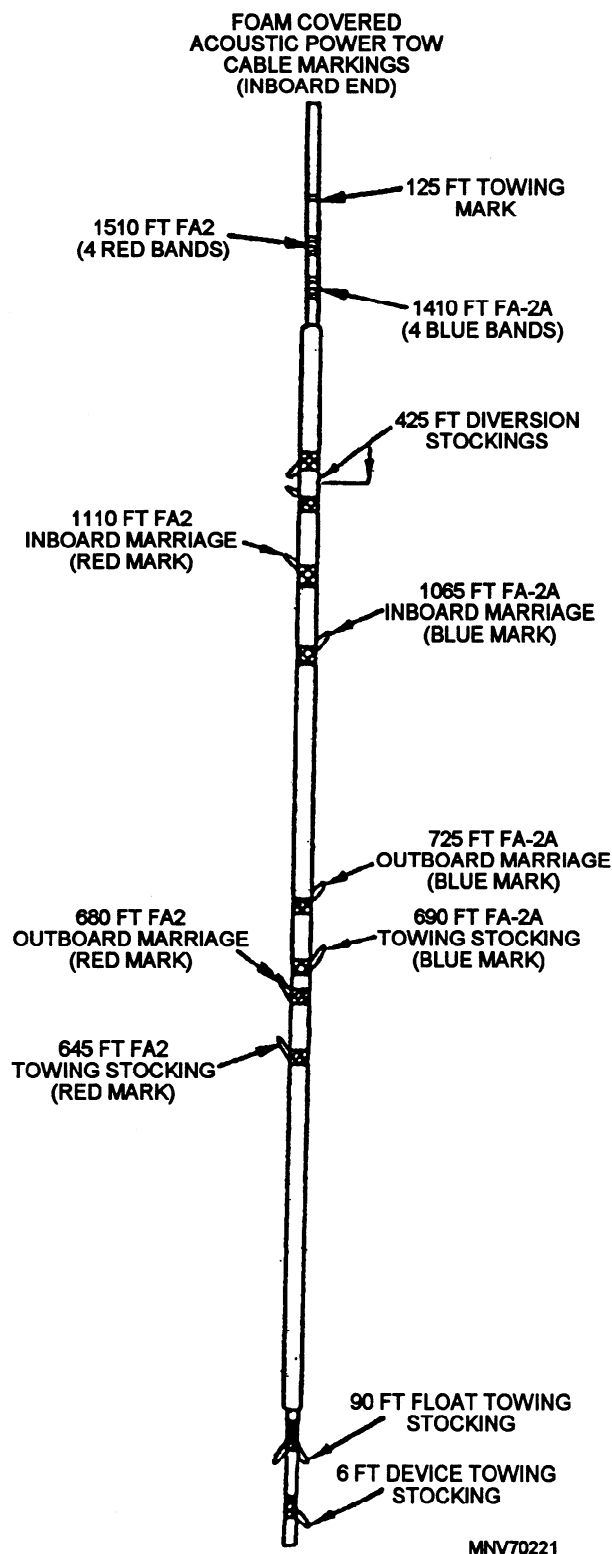

Figure 9-4.—Acoustic power cable.

shaft assembly, and the motor. Within the striker assembly, an eccentric controls the movements of a spring-driven hammer. The striker operates as a piston and strikes the diaphragm at a frequency governed by motor speed. The eccentric shaft assembly is a bearing-mounted shaft connected through an eccentric and ball-and-socket arrangement to the striker assembly. The eccentric shaft is rotated by a V-belt driven by the 1-1/2 horsepower, 240 Vdc motor. The motor receives its controlling voltage from the power converter unit (PCU) on board the ship.

ACOUSTIC POWER CABLE (BUOYANT)

The acoustic power cable (APC) (figure 9-4) provides electrical power to operate acoustic devices at an extended distance from the ship, contributing to the ship's safety during minesweeping operations. It contains four conductors, and is 1,650 feet long and 1-1/2 inches in diameter. It has two nonbuoyant sections, 125 feet on the outboard end and 250 feet on the inboard end. The buoyant section is 1,275 feet long and 3 inches in diameter. Polyethylene foam wrapped around the power cable provides the necessary buoyancy.

AUTOMATIC CONTROL UNIT SG-1224A/SLQ-37(V)

The automatic control unit (ACU) (figure 9-5) provides the waveforms used for acoustic and magnetic mine countermeasures.

Acoustic voltage waveforms provided by the ACU are converted to direct current by the power converter unit (PCU) and applied through the APC to run the motors in the TB-26 and the TB-27. Magnetic voltage waveforms provided by the ACU are sent to the ship's magnetic minesweeping generators, converted to high-amperage current, and applied to the ship's magnetic tail.

FLOATS

Minesweeping floats (figure 9-6) are used to support either minesweeping otters or acoustic devices

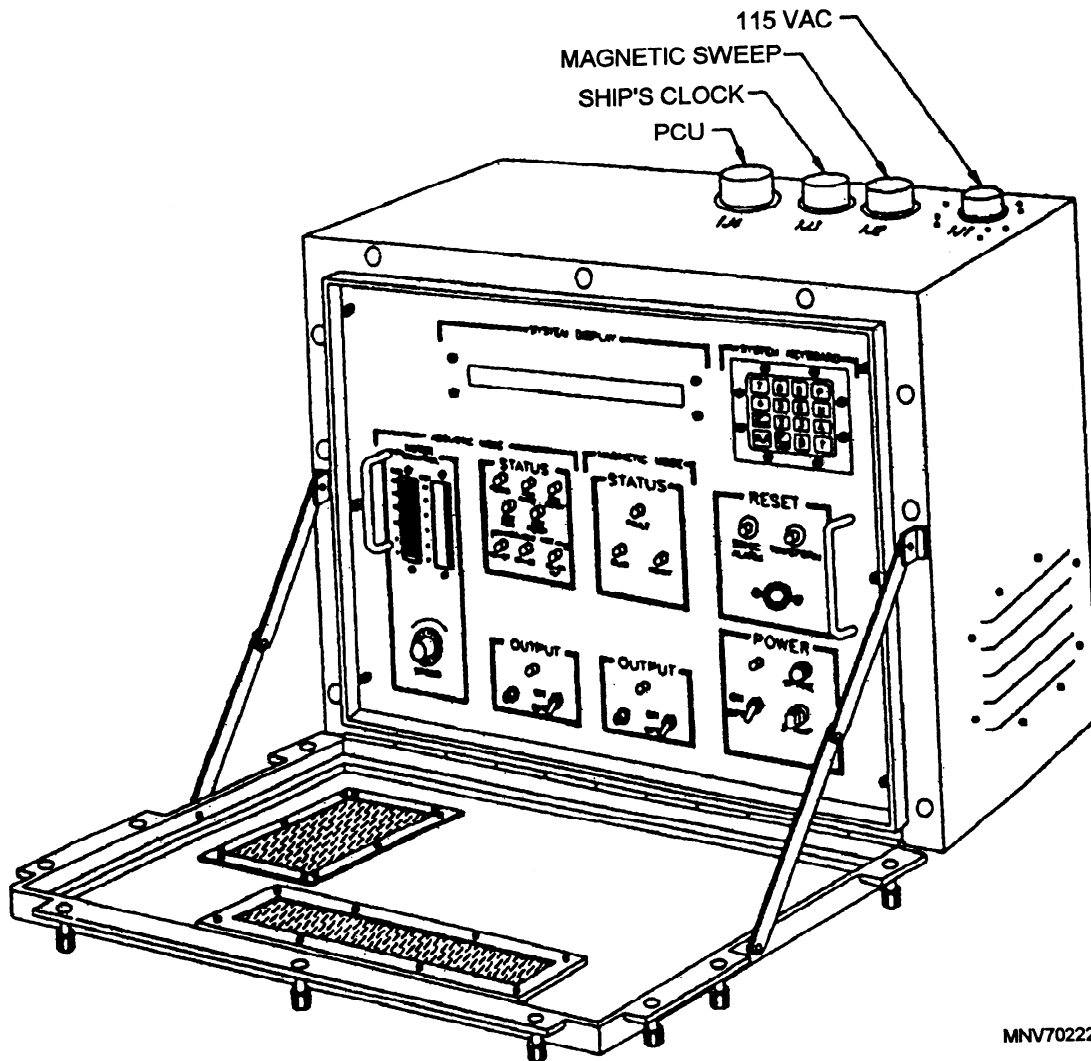

Figure 9-5.—Automatic Control Unit SG-1224A/SLQ-37(V).

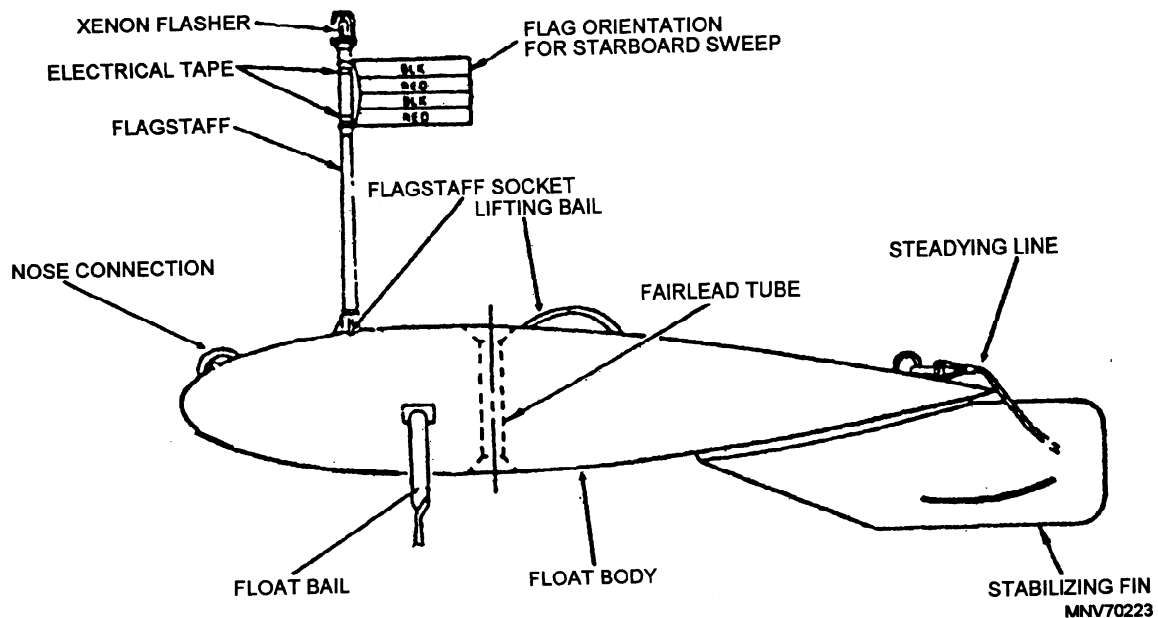

Figure 9-6.—Typical "O"-type float

during minesweeping operations. Floats generally come in three sizes: size 0, size 1, and size 5. Size 0 is the largest; size 5 is the smallest. (See table 9-2.)

Table 9-2.—Floats, Type “O” - Data

Nomenclature	Length (ft-in)	Weight (lb)	Buoyancy (lb)
Float, size 0	17-7	950	3300
Float, size 1	14-3	900	1500
Float, size 5	5-4 3/4	96	202

The size 0 float is used solely to support the acoustic device TB-26. The size 1 float is designed to support either an otter or the acoustic device TB-27. The size 5

float is used only with the A Mk 2(g) (rattle bars). All floats serve as a marker for the approximate outboard end of the sweep, allowing the sweep width to be checked by observation from the ship.

Recall, from chapter 8, that the float’s flag, with black and red horizontal strips, indicates whether a port sweep or a starboard sweep is being conducted. A black stripe on top indicates a starboard sweep; a red stripe on top indicates a port sweep.

Acoustic sweep configurations using the rattle bars, the TB-26, and the TB-27 are illustrated in figures 9-7 through 9-9.

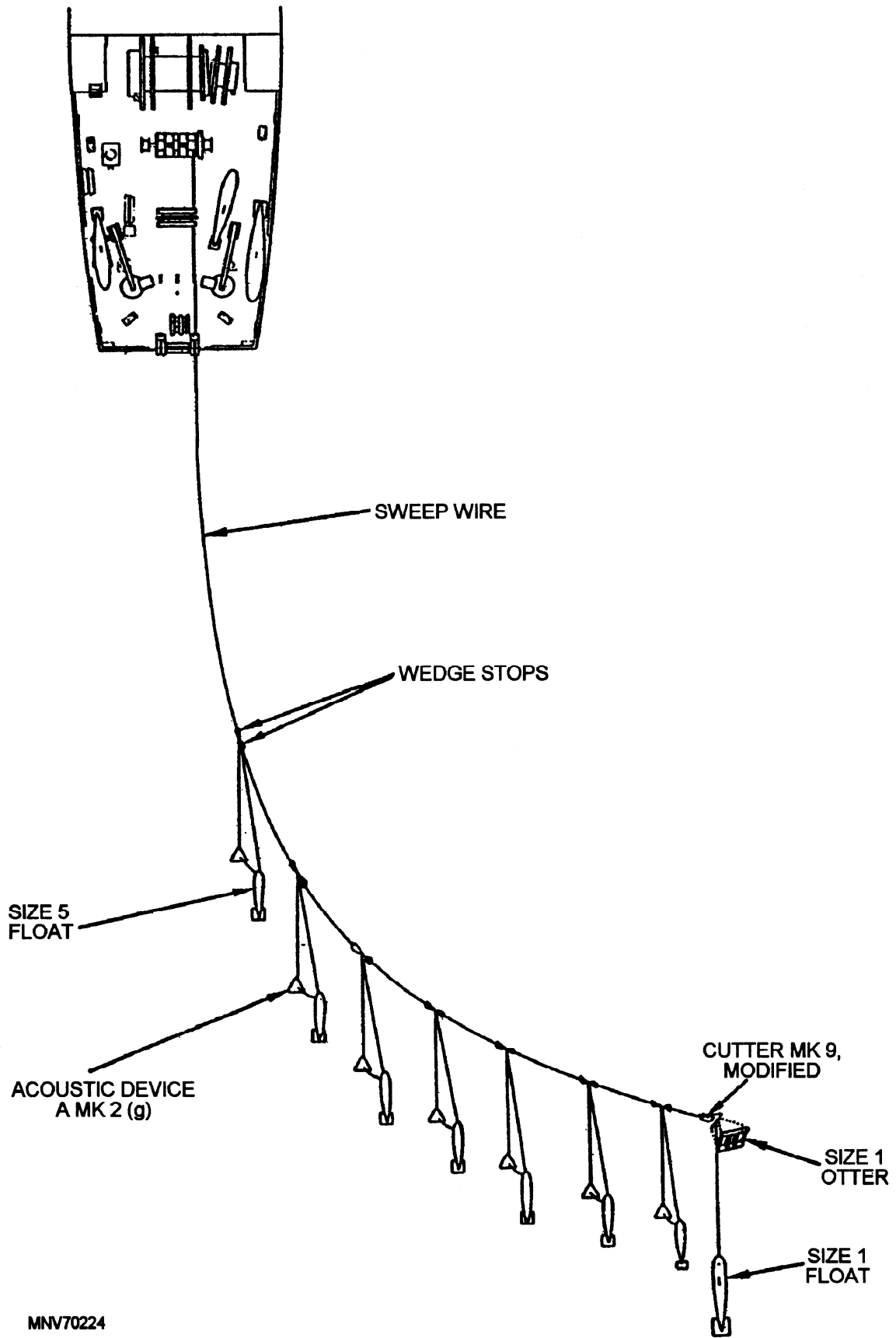

Figure 9-7.—Acoustic sweep configuration A Mk 2(g).

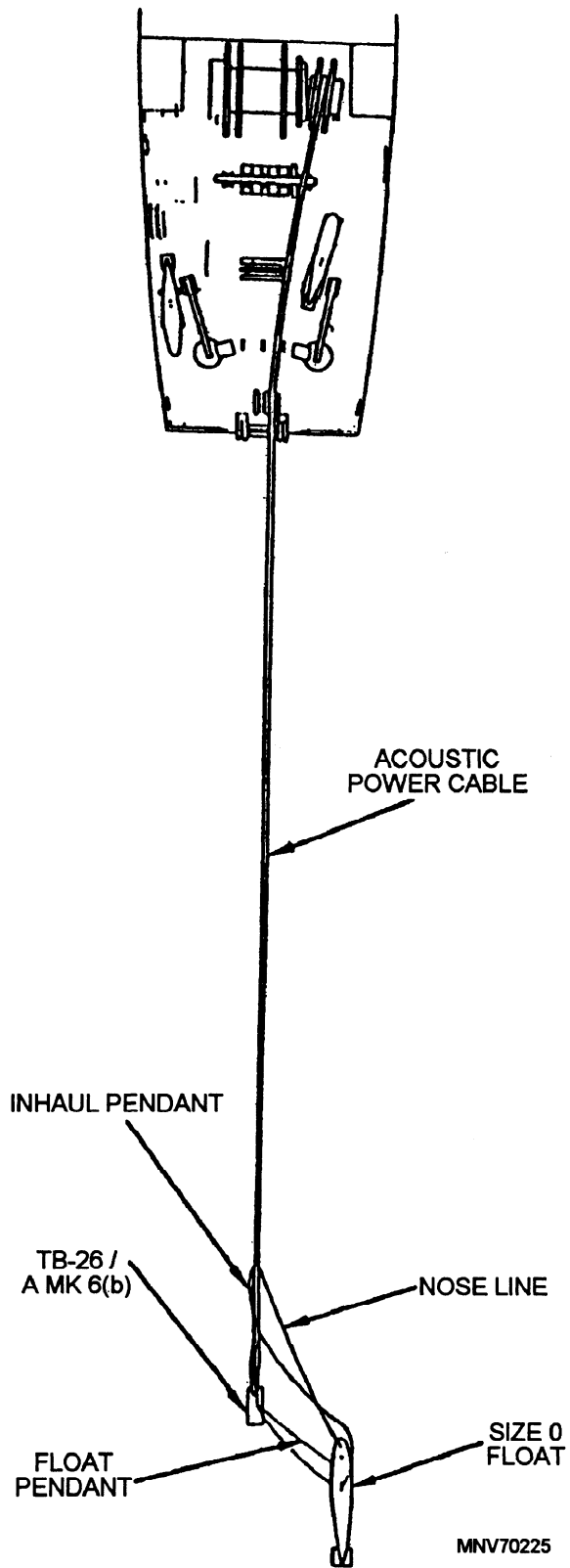

Figure 9-8.—Acoustic sweep configuration TB-26/A Mk 6(b) astern.

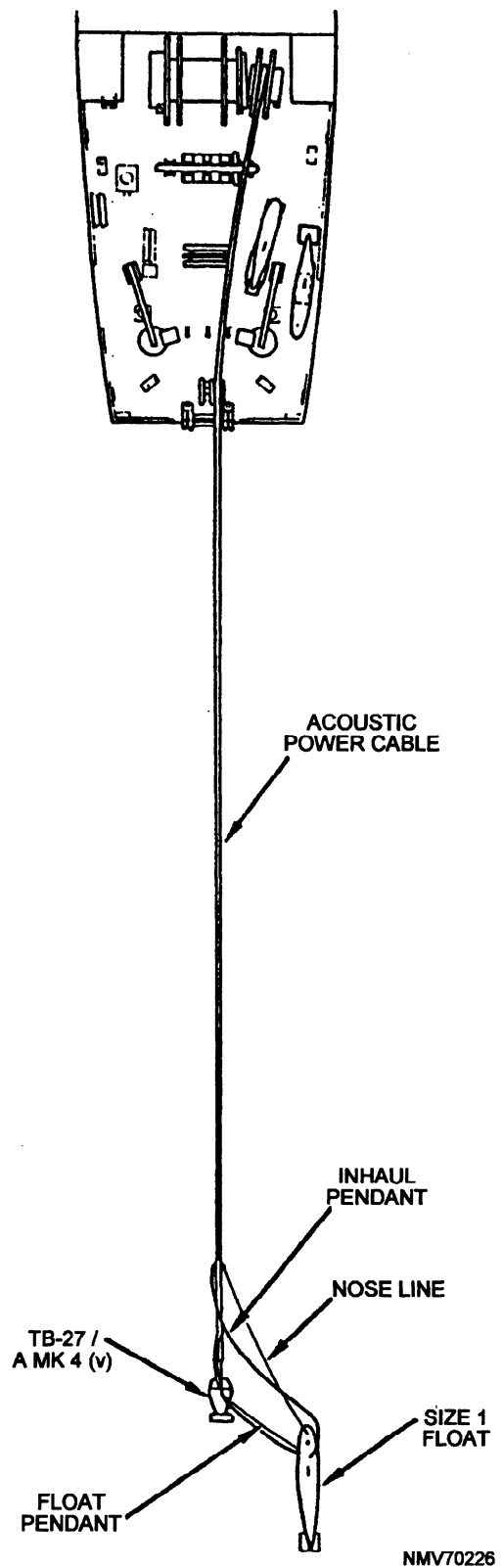

Figure 9-9.—Acoustic sweep configuration TB-27/A Mk astern.

CHAPTER 10

MAGNETIC MINESWEEPING

LEARNING OBJECTIVES

Upon completing this chapter, you should be able to do the following:

1. State the basic principles of magnetic minesweeping.
2. Describe the different types of magnetic minesweeping equipment.
3. Describe the primary sweep configurations, including the basic components associated with each configuration.

INTRODUCTION

Magnetic minesweeping involves creating a magnetic field in the water at a safe distance astern of a minesweeper strong enough to affect or destroy magnetic influence mines.

Most ships are surrounded by a magnetic field associated with their design and construction. As a ship moves, its magnetic field moves with it, causing a change in the Earth's magnetic field in the vicinity of the ship. Magnetic influence mines are designed to recognize this change in the Earth's magnetic field and to explode at the most appropriate time to damage the ship that produces the change. The mines' firing mechanisms respond to the change in magnetic field either by advancing a counter and exploding at a certain count or by exploding at first contact. Minesweepers counter these mines by generating an electrical current and applying it through insulated electrical cables to create a magnetic field over the mines. This magnetic field is strong enough to "fool" the mines into thinking a

ship is passing overhead and makes them react accordingly.

Magnetic sweeps may be streamed alone or in combination with an acoustic device. This chapter addresses magnetic sweeps only. Combination magnetic/acoustic minesweeping is discussed in chapter 11.

MAGNETIC MINESWEEPING EQUIPMENT

Unlike other minesweeping gear, the designation of a particular magnetic sweep does not refer to a specific item of equipment. Instead, it refers to a particular combination of basic magnetic minesweeping cable components for use in certain circumstances against certain types of mines.

MAGNETIC MINESWEEPING CABLE

The magnetic cable currently in service use is the quadded tail (figure 10-1). The quadded tail consists of

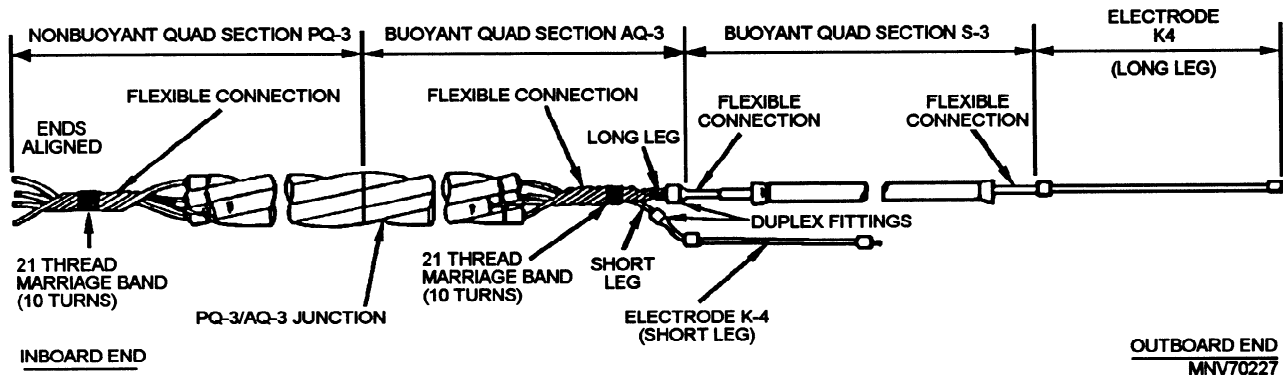

Figure 10-1.—Magnetic quadded tail assembly.

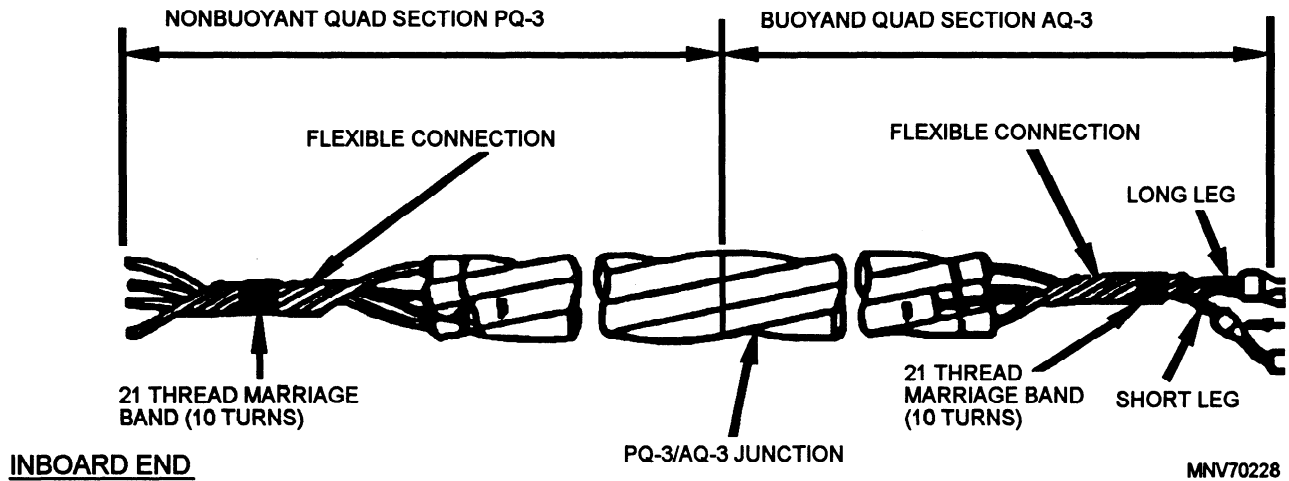

Figure 10-2.—Q-3 cable.

the following five sections, from which the standard M Mk 5(a), M Mk 6(a), and M Mk 6(h) sweeps are configured:

- PQ-3 quad section;
- AQ-3 quad section;
- S-3 section;
- CL-1 and CL-3 cables; and
- K-4 electrode.

Q-3 Cable

The Q-3 cable (figure 10-2) consists of four insulated aluminum conducting cables wrapped together around a central core to form the quad. Two

diagonally opposite conductors, 3 feet shorter than the remaining two conductors, are connected at their outer ends and form the “short leg” of the Q-3 cable. To this short leg may be connected a K-4 electrode, a CL-1 cable, or a CL-3 cable. The remaining two conductors are connected at their outer ends and form the “long leg” of the Q-3 cable. To this long leg may be attached a 900-foot single section of S-3 cable or a CL-3 cable. These cables may be terminated with either a K-4 electrode or a CL-3 cable.

The Q-3 cable is divided into two sections, the PQ-3 section (air cooled) and the AQ-3 section (water cooled). The junction between the PQ-3 and AQ-3 sections is marked with a band of red rubber, and the cable should be towed so that the red band is in the water at all times.

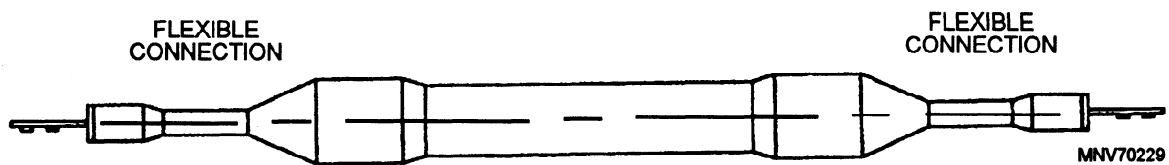

Figure 10-3.—S-3 cable.

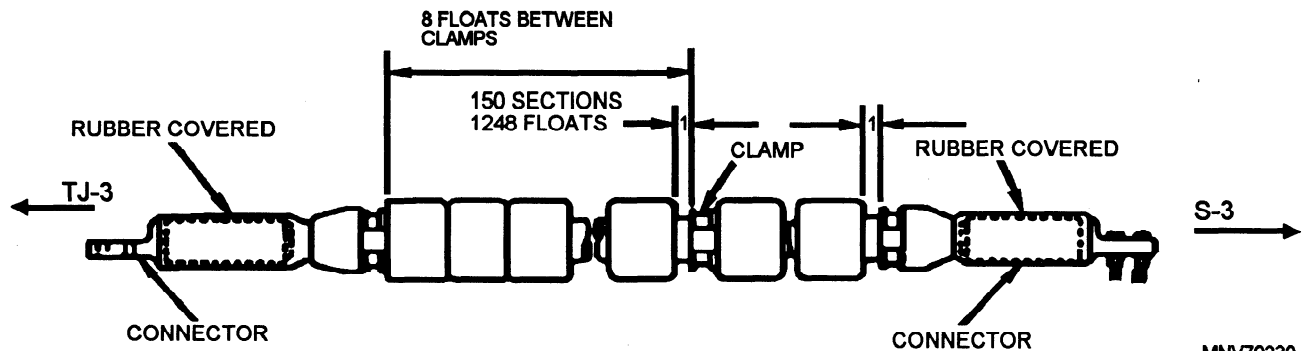

Figure 10-4.—CL-1/CL-3 cable.

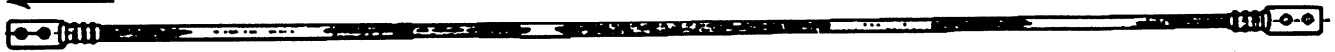

Figure 10-5.—K-4 electrode.

S-3 Cable

The S-3 cable (figure 10-3) is an aluminum single-conductor, buoyant cable terminated at both ends with flexible copper conductors and terminals.

CL-1 and CL-3 Cables

The CL-1 and CL-3 cables (figure 10-4) consist of one 450-foot length of hard-drawn, rope-stranded aluminum conductor, core-sealed with an asphalt base sealing compound, and jacketed with reinforced synthetic rubber. Buoyancy is provided by shell-type cylindrical plastic floats filled with foamed plastic. The primary difference between the two cables is size. The CL-1 is approximately 1 1/2 inches in diameter; whereas, the CL-3 is approximately 2 1/2 inches in diameter. Either the S-3 or the CL-1 is carried on board MCM ships at all times. If the ship carries the S-3, it will not carry the CL-1 and vice versa.

K-4 Electrode

The K-4 electrode (figure 10-5) consists of a concentric stranded copper conductor cable covered with cotton tape and seine braid. The K-4 electrode is 150 feet long and is terminated in flat lugs at both ends.

MAGNETIC SWEEP CONFIGURATIONS

The magnetic field produced by a ship consists of a vertical component and a horizontal component. Each sweep configuration is designed to exploit one or both of those components. Therefore, the sweep configuration to be used depends on which component(s) must be exploited. The paragraphs below illustrate the primary sweep configurations and identify the magnetic component(s) associated with each configuration.

STRAIGHT TAIL SWEEP M Mk 5(a)

The M Mk 5(a) sweep (figure 10-6) is effective against vertical component magnetic mines in salt water.

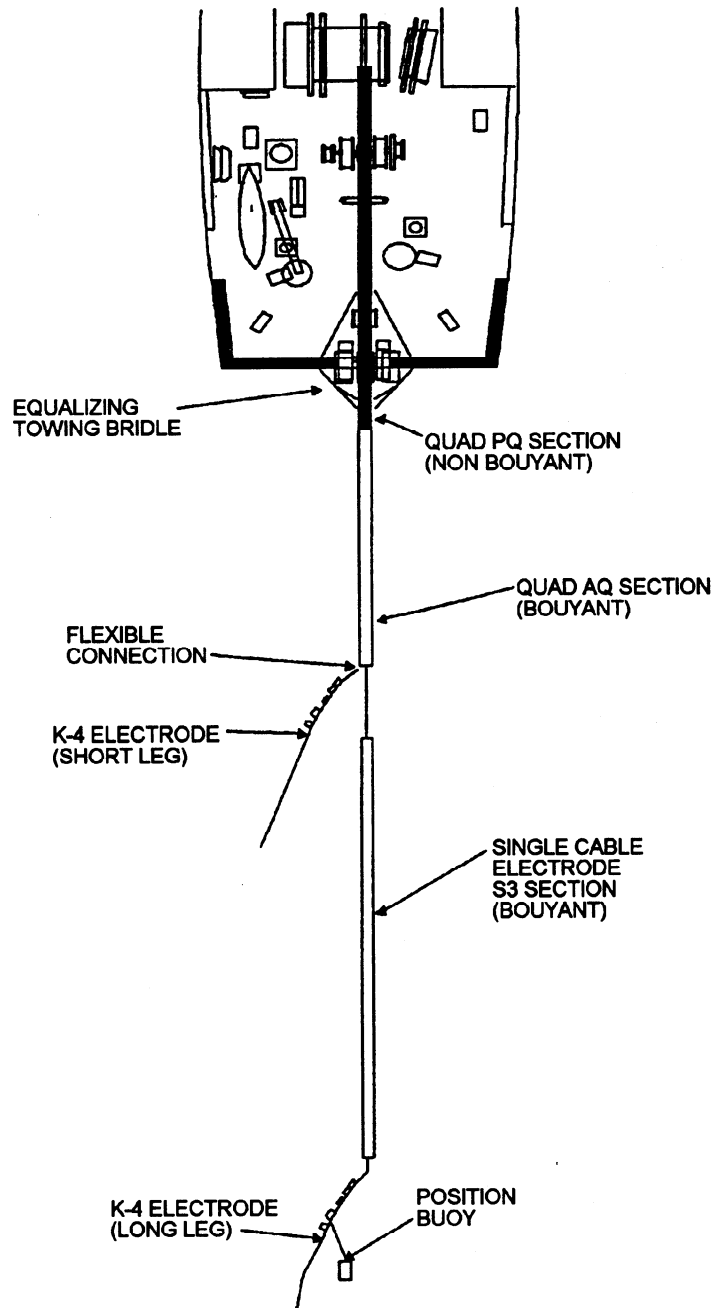

Figure 10-6.—Magnetic sweep cable configuration M Mk 5 (a).

DIVERTED LOOP M Mk 6(a)

The diverted loop M Mk 6(a) sweep (figure 10-7) is used primarily to sweep horizontal component magnetic mines only in salt water. It is also referred to as a "jig sweep."

DIVERTED LOOP M Mk 6(h)

The diverted loop M Mk 6(h) sweep (figure 10-8) is used primarily to sweep horizontal component magnetic mines in fresh or salt water. It is also referred to as a "jig sweep."

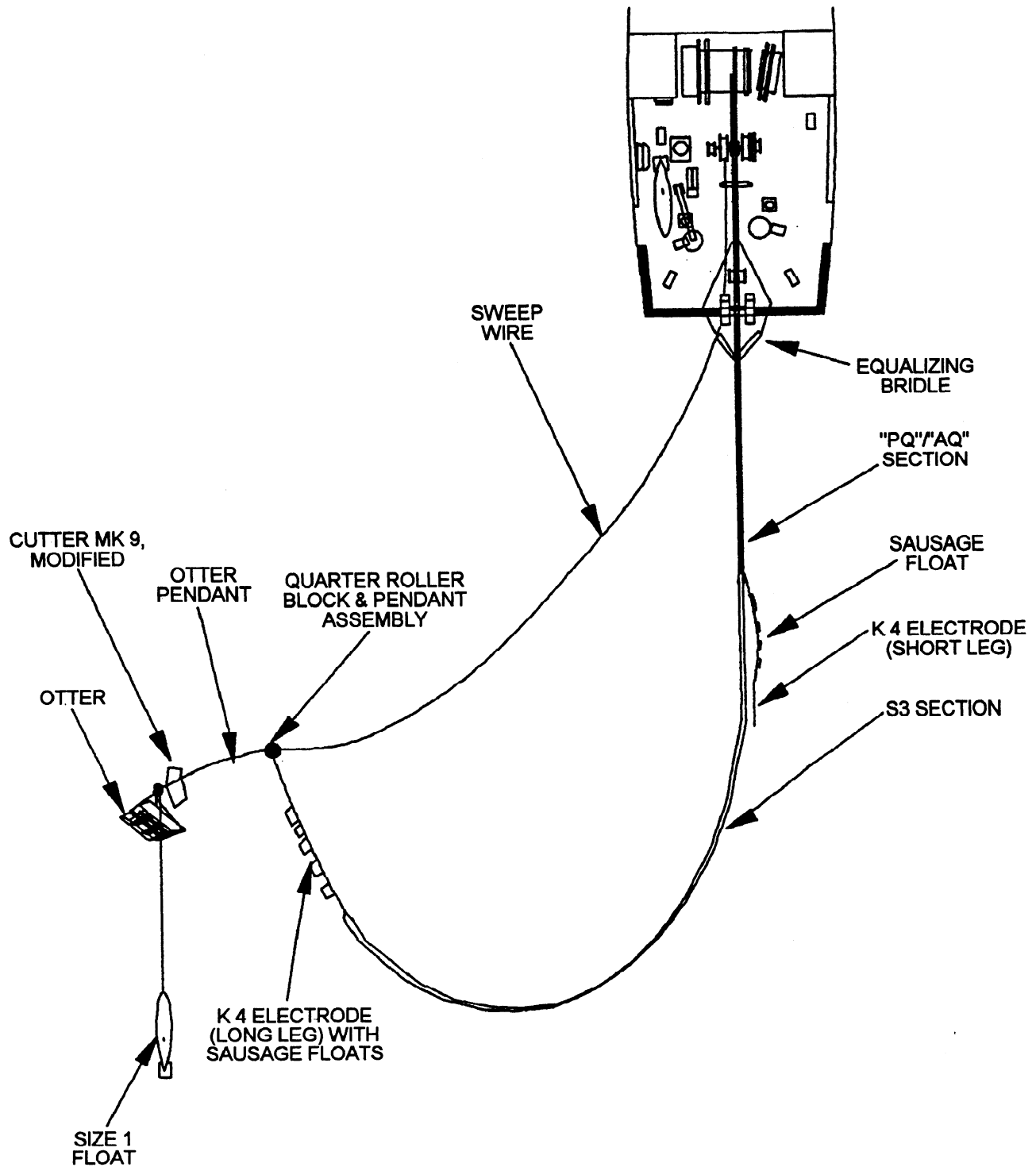

MNV70233

Figure 10-7.—Magnetic sweep cable configuration M Mk 6(a) (diverted loop).

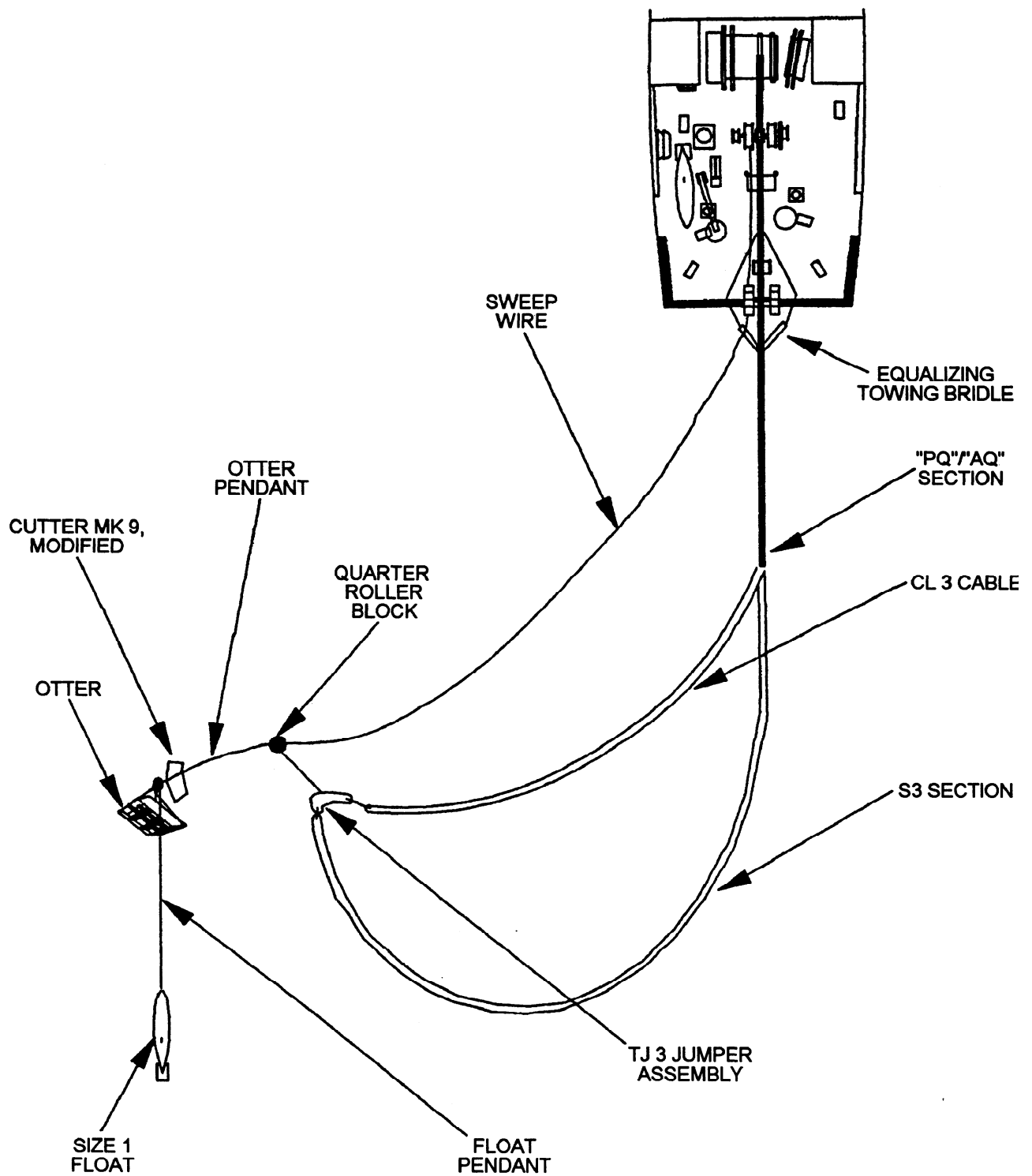

Figure 10-8.—Magnetic sweep cable configuration M Mk 6(h) (diverted loop).

MNV7023

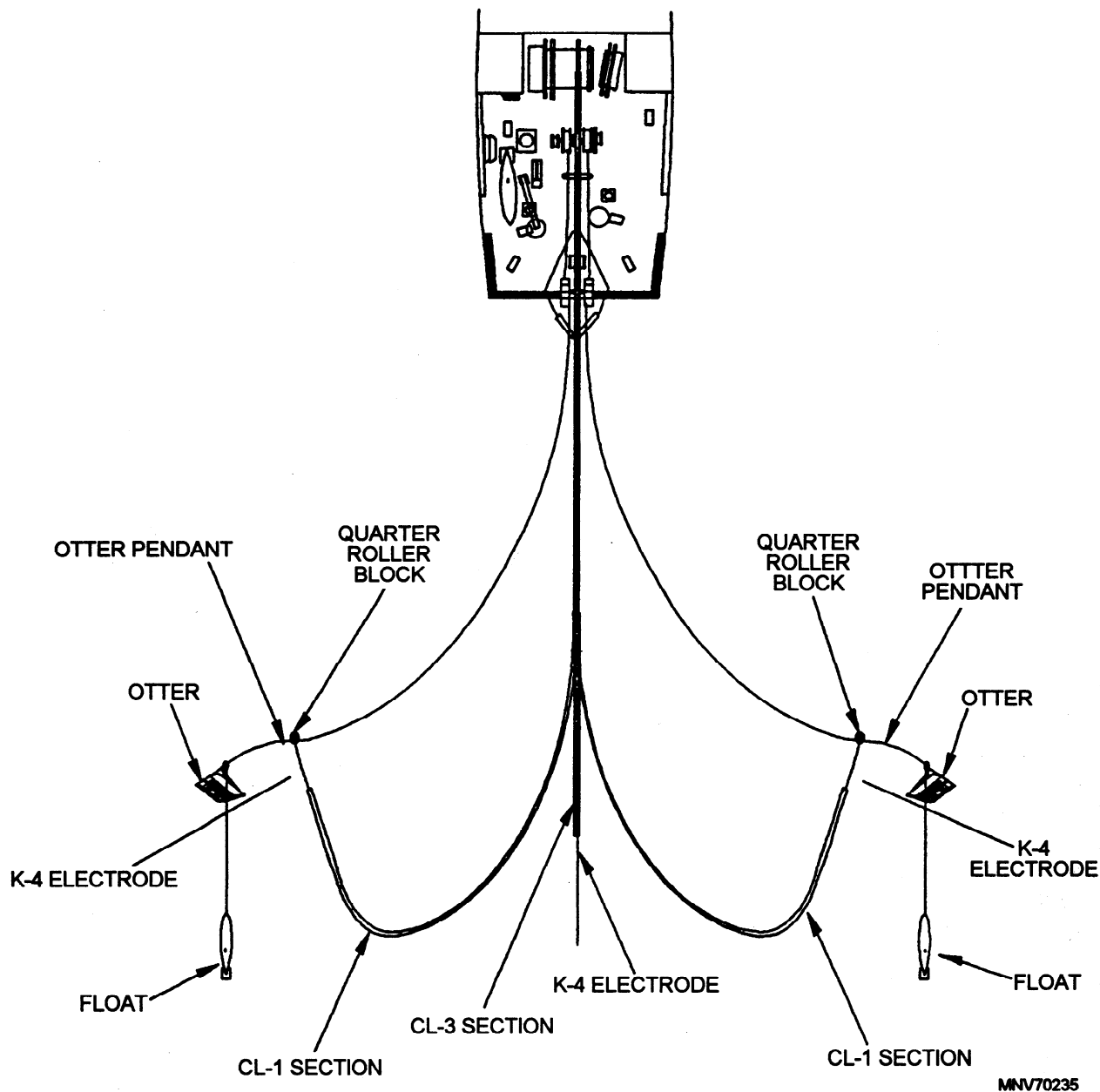

Figure 10-9.—Magnetic sweep cable configuration M Mk 7(b) (double diverted loop).

MNV70235

DOUBLE DIVERTED LOOP M Mk 7(b)

The double diverted loop M Mk 7(b) sweep (figure 10-9) is used to sweep both horizontal and vertical component mines in salt water. It is also referred to as an

“S”-type sweep. Use of this configuration requires the MCM to carry four CL-1 cables, each 450 feet long. In this configuration, the S-3 section is removed and replaced by the four CL-1 sections, connected as two CL-1 sections, each 900 feet long.

CHAPTER 11

COMBINATION MINESWEEPING

LEARNING OBJECTIVES

Upon completing this chapter, you should be able to do the following:

1. Describe the purpose of combination minesweeping.
2. Recall the three groups of combination sweeps.
3. Recall the different configurations of combination minesweeping.

INTRODUCTION

In previous chapters, we discussed minesweeping sweeps used to clear acoustic and magnetic influence mines. A third type of influence mine, which we did not discuss, is the pressure mine. Some mines are designed to be set off by a combination of these types of influence (magnetic-acoustic, pressure-acoustic, and magnetic-pressure). Therefore, a sweep was developed to counter all of these types (except pressure influence) in the same pass. At present, there is no minesweeping device that can simulate a ship's pressure signature.

This chapter illustrates numerous combination sweeps that are available. Combination minesweeping is used to detonate influence mines or cause their detecting devices to register a ship count as the sweep passes near them. The most effective combination sweeping is achieved when two types of gear are streamed from the same ship, superimposing the influence fields.

TYPES OF COMBINATION SWEEPS

Combination sweeps are subdivided into three groups: FA2, FA2A, and combination magnetic sweeps as follows:

Group 1: FA2 combination sweep consists of the M Mk 6(a) open-loop magnetic sweep with either a TB-26 or TB-27 acoustic device.

Group 2: FA2A combination sweep consists of the M Mk 6(b) closed-loop magnetic sweep with either a TB-26 or TB-27 acoustic device.

Group 3: Combination magnetic sweeps consists of the M Mk 5(a), M Mk 6(a), or M Mk 6(h) with an acoustic device towed astern.

The various combination sweeps and their associated equipment are listed in table 11-1 and illustrated in figures 11-1 through 11-10.

Table 11-1.—Combination Sweeps

Type	Equipment	Figure
FA2	M Mk 6(a) open diverted loop magnetic sweep with a TB-26 acoustic device	11-1
FA2	M Mk 6(a) open diverted loop magnetic sweep with a TB-27 acoustic device	11-2
FA 2A	M Mk 6(h) closed diverted loop magnetic sweep with a TB-26 acoustic device	11-3
FA 2A	M Mk 6(h) closed diverted loop magnetic sweep with a TB-27 acoustic & vice	11-4
Combination Magnetic	M Mk 5(a) sweep with a TB-26 acoustic device	11-5
Combination Magnetic	M Mk 5(a) sweep with a TB-27 acoustic device	11-6
Combination Magnetic	M Mk 6(a) sweep with a TB-26 acoustic device	11-7
Combination Magnetic	M Mk 6(a) sweep with a TB-27 acoustic device	11-8
Combination Magnetic	M Mk 6(h) sweep with a TB-26 acoustic device	11-9
Combination Magnetic	M Mk 6(h) sweep with a TB-27 acoustic device	11-10

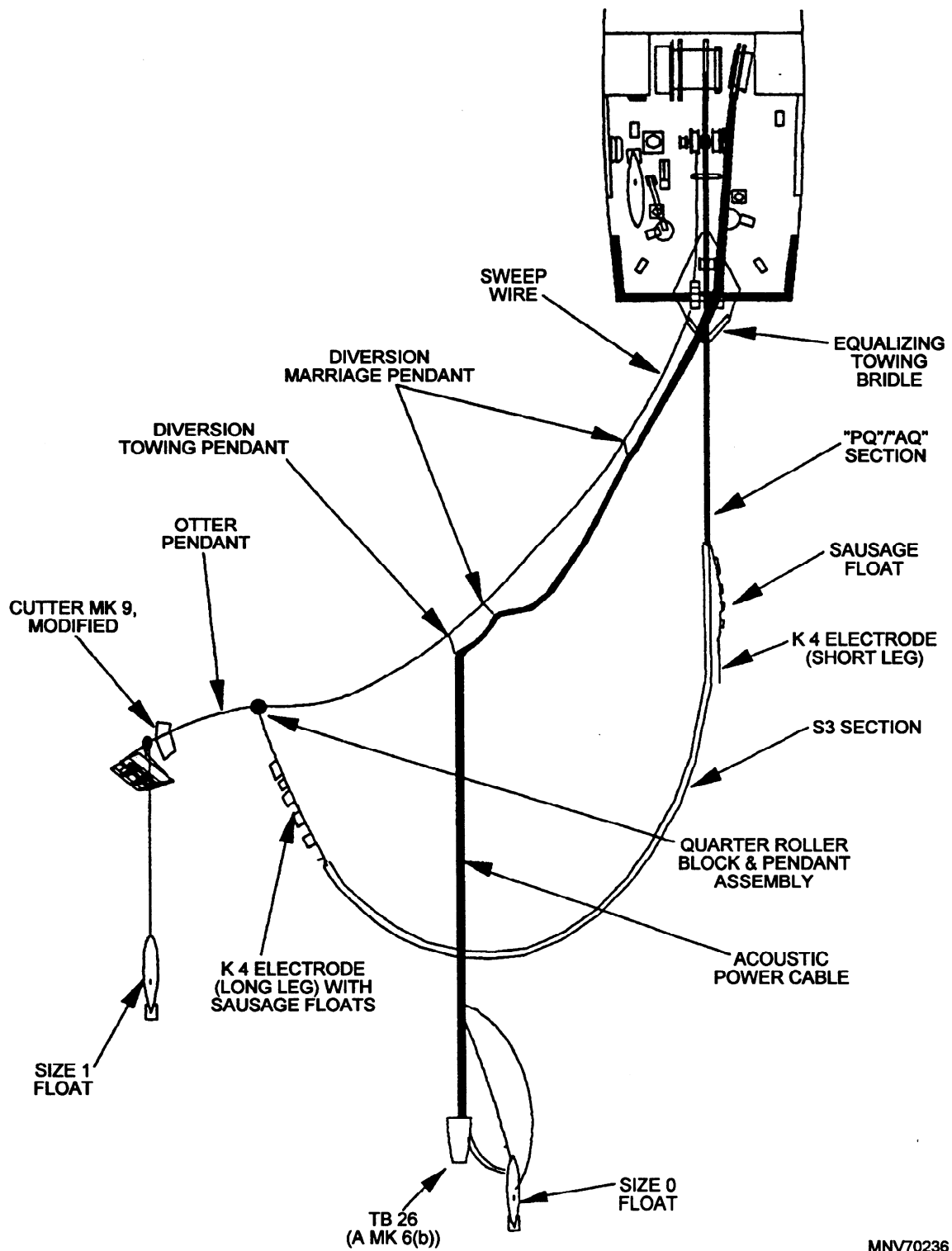
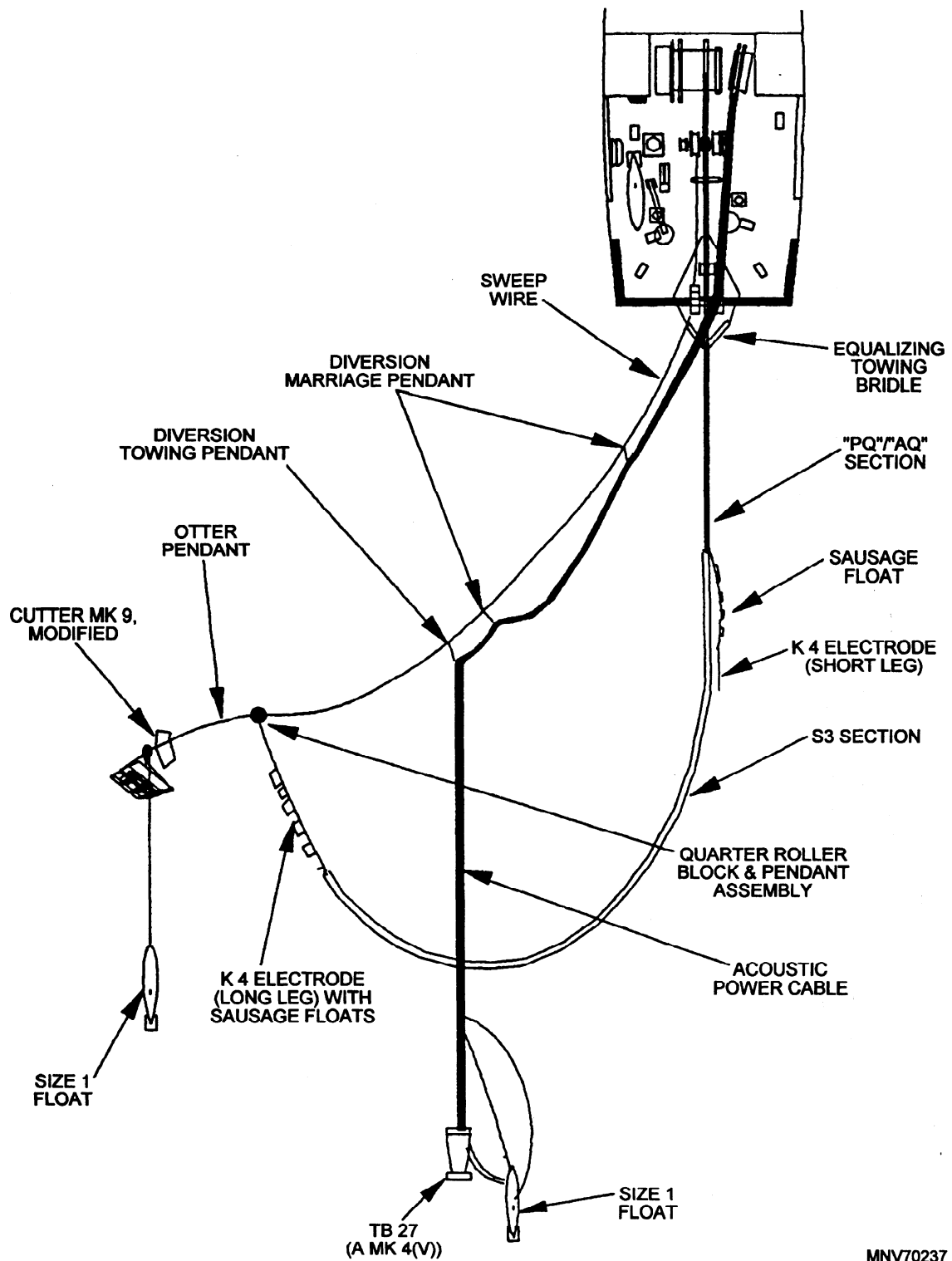

Figure 11-1.—FA 2 combination sweep configuration M Mk 6(a) with TB-26(A Mk 6(b)).



MNV70237

Figure 11-2.—FA 2 sweep configuration M Mk 6(a) with TB-27(A Mk 4(v)).

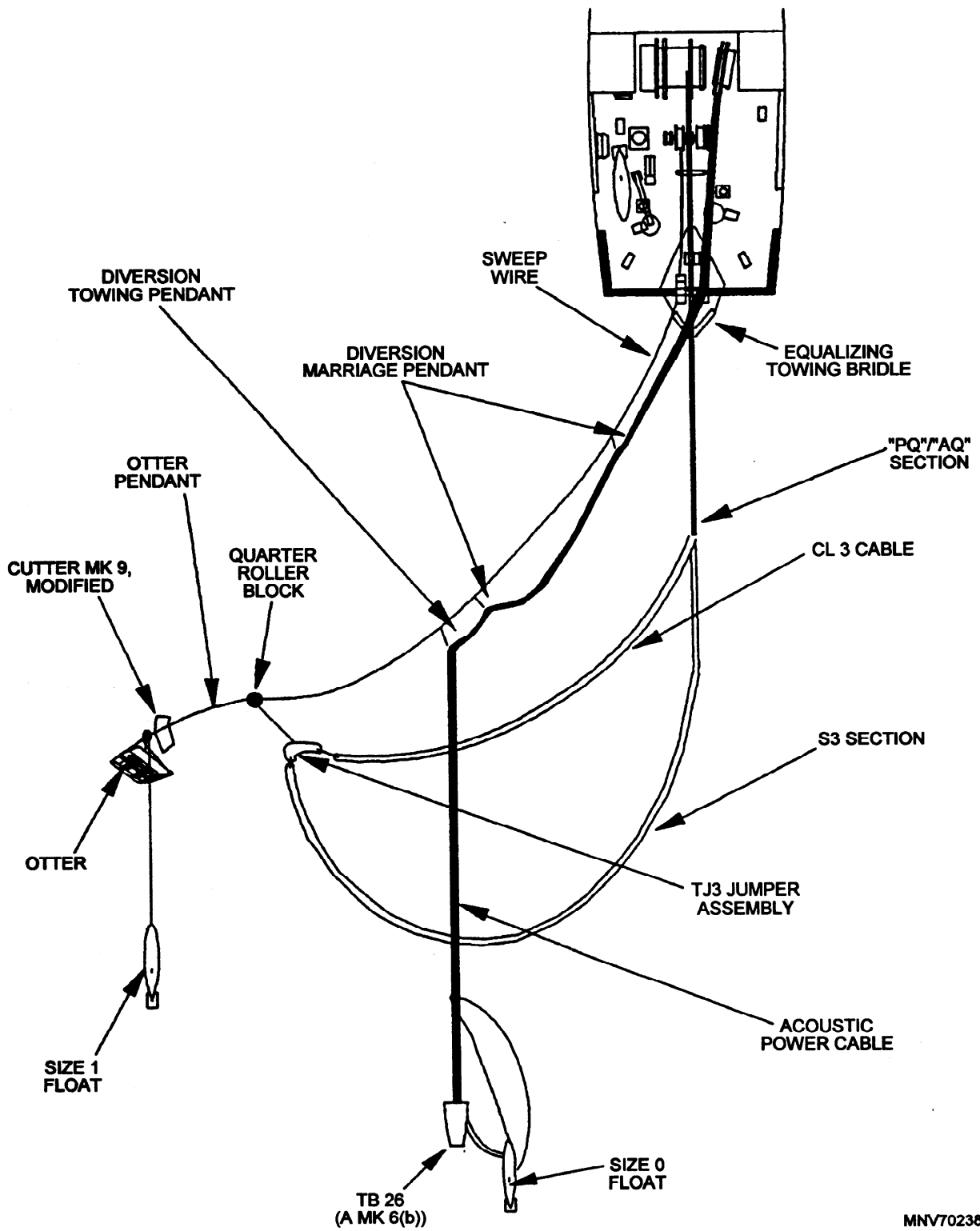

Figure 11-3.—FA 2A sweep configuration M Mk 6(h) with TB-26(A Mk 6(b)).

MNV70238

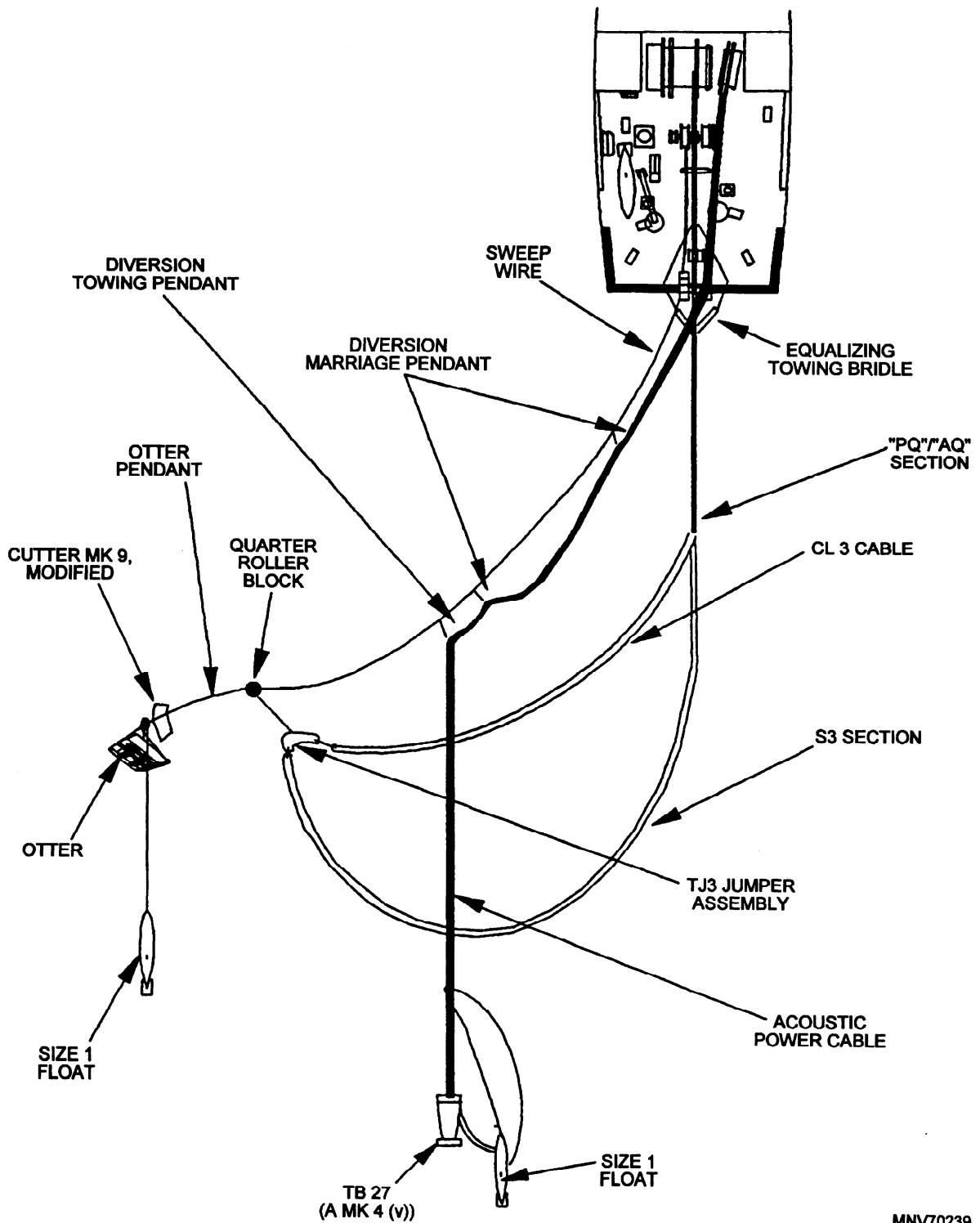

Figure 11-4.—FA 2A sweep configuration M Mk 6(h) with TB-27(A Mk 4(v)).

MNV70239

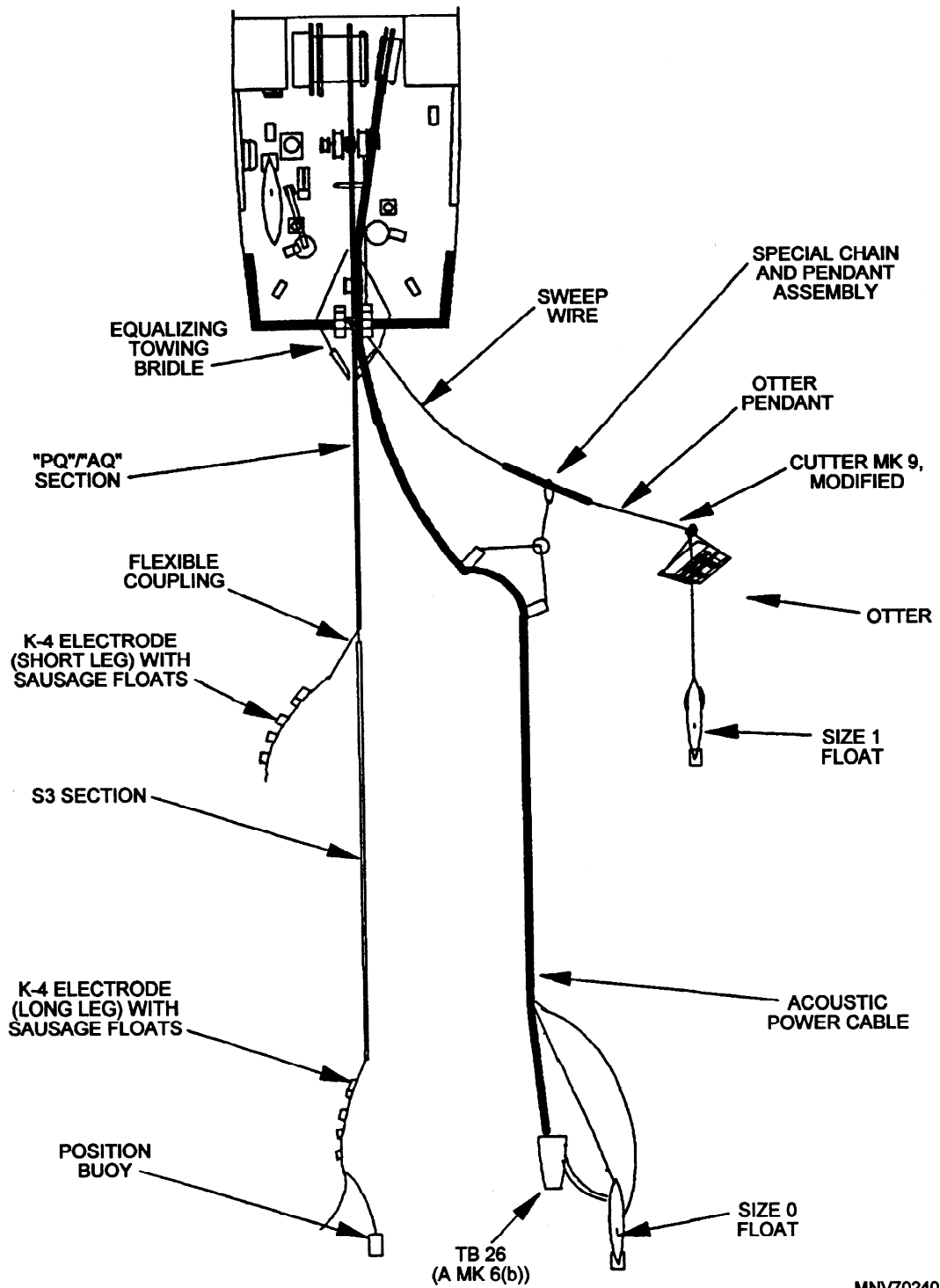

Figure 11-5.—M Mk 5(a) sweep configuration with TB-26(A Mk 6(b)) diverted to starboard.

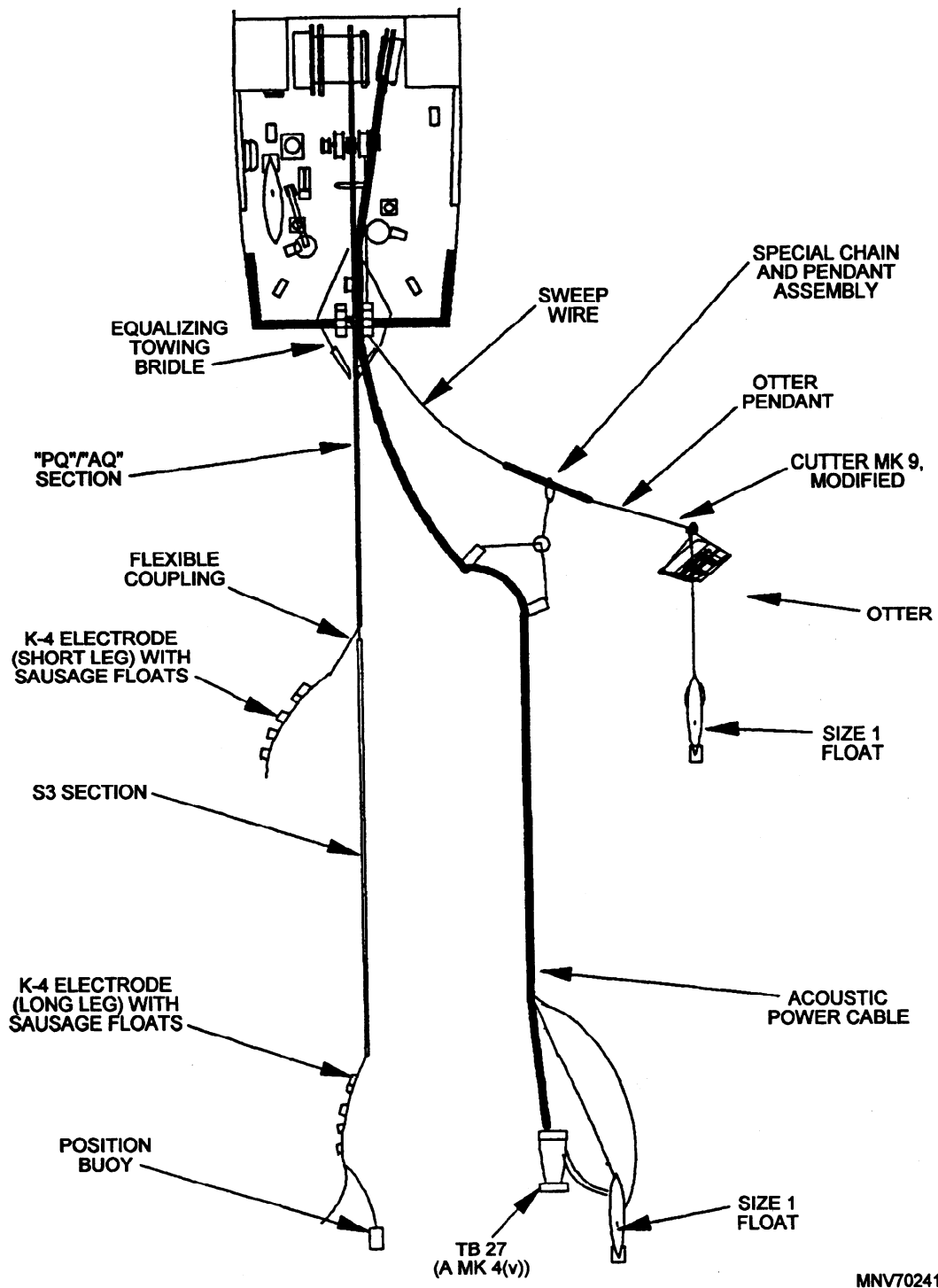

Figure 11-6.—M Mk 5(a) sweep configuration with TB-27(A Mk 4(v)) diverted to starboard.

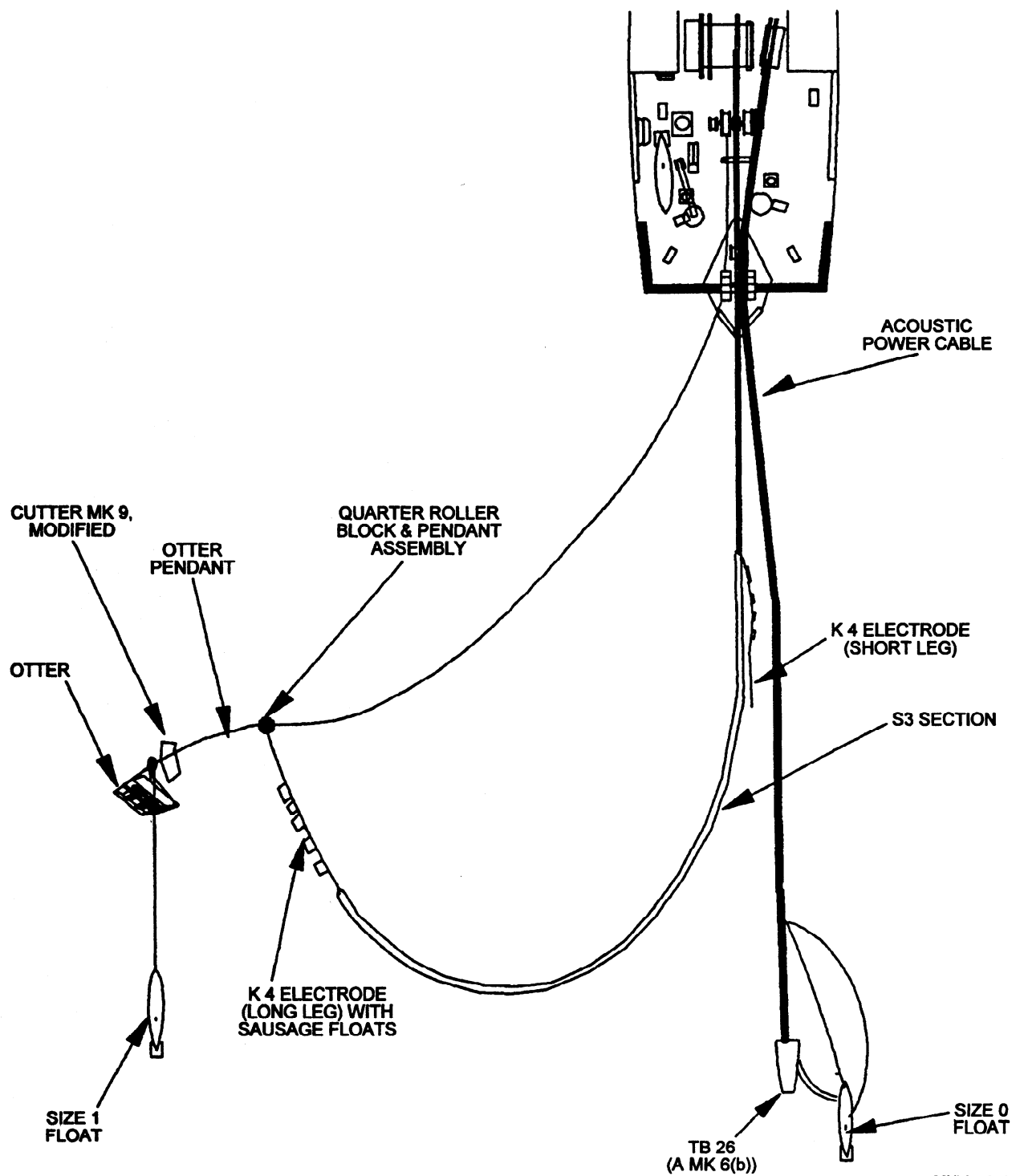

Figure 11-7.—M Mk 6(a) sweep configuration with TB-26(A Mk 6(b)) astern.

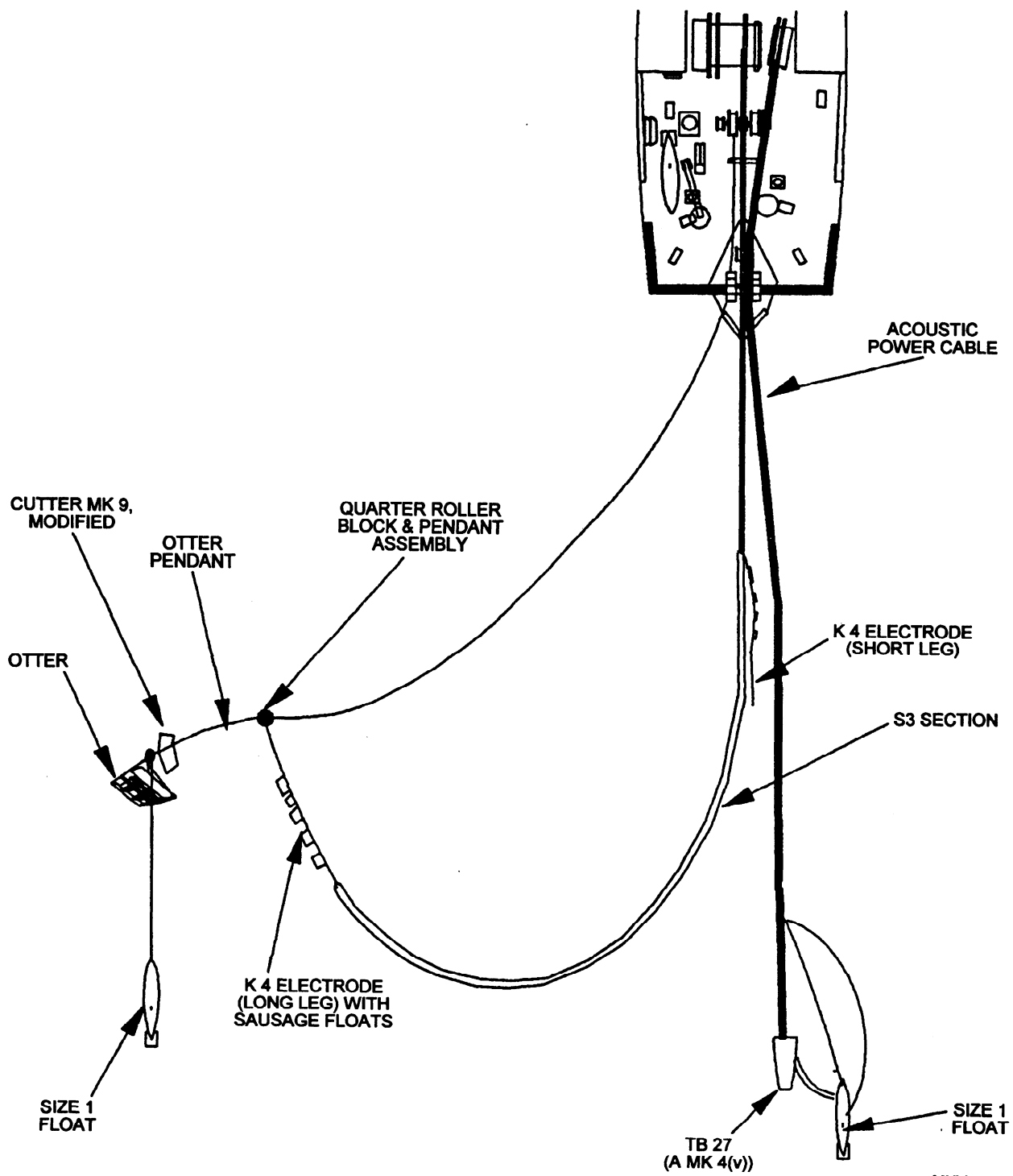

Figure 11-8.—M Mk 6(a) sweep configuration with TB-27(A Mk 4(v)) astern.

MNV70243

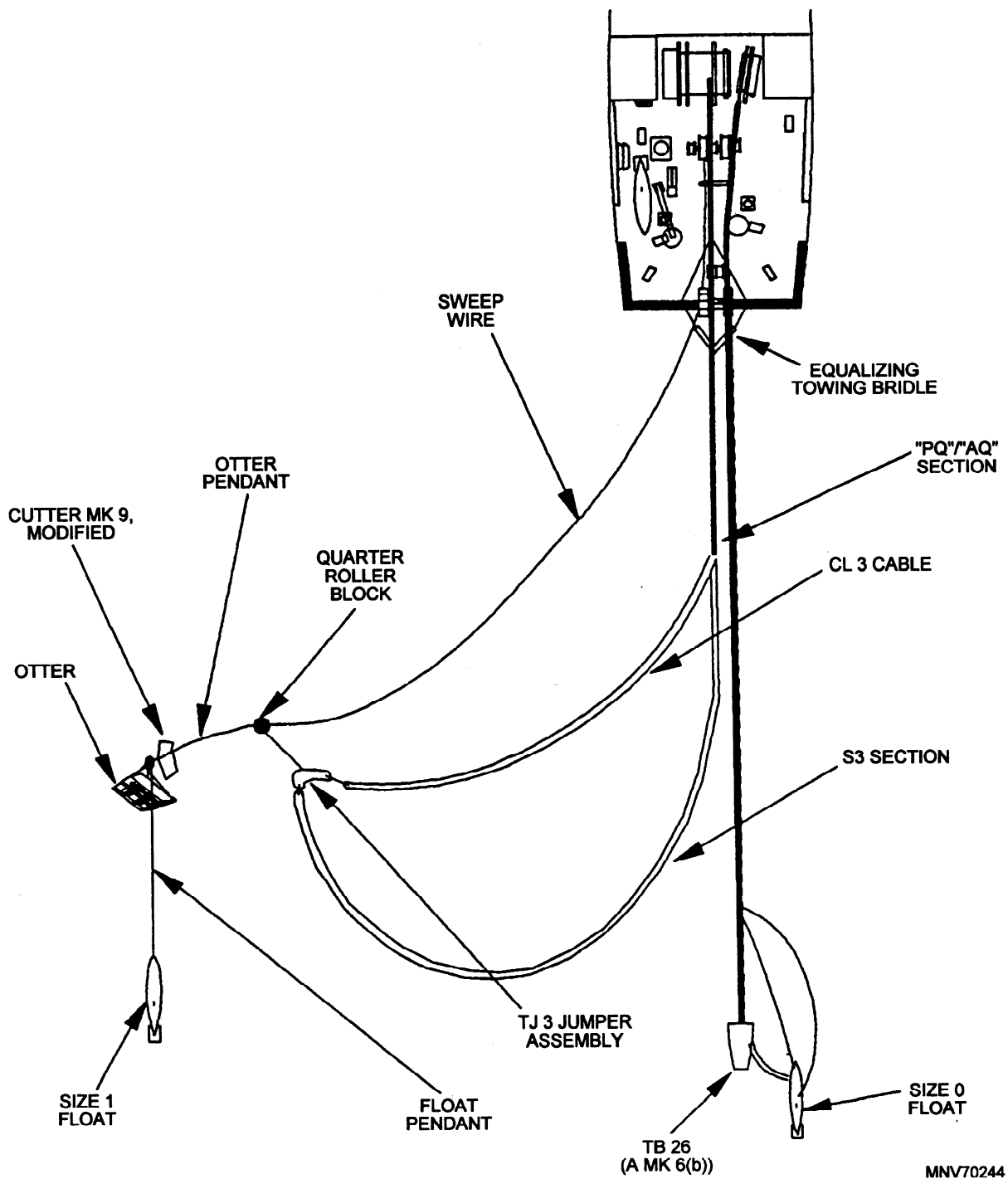

Figure 11-9.—M Mk 6(h) sweep configuration with TB-26(A Mk 6(b)) astern.

MNV70244

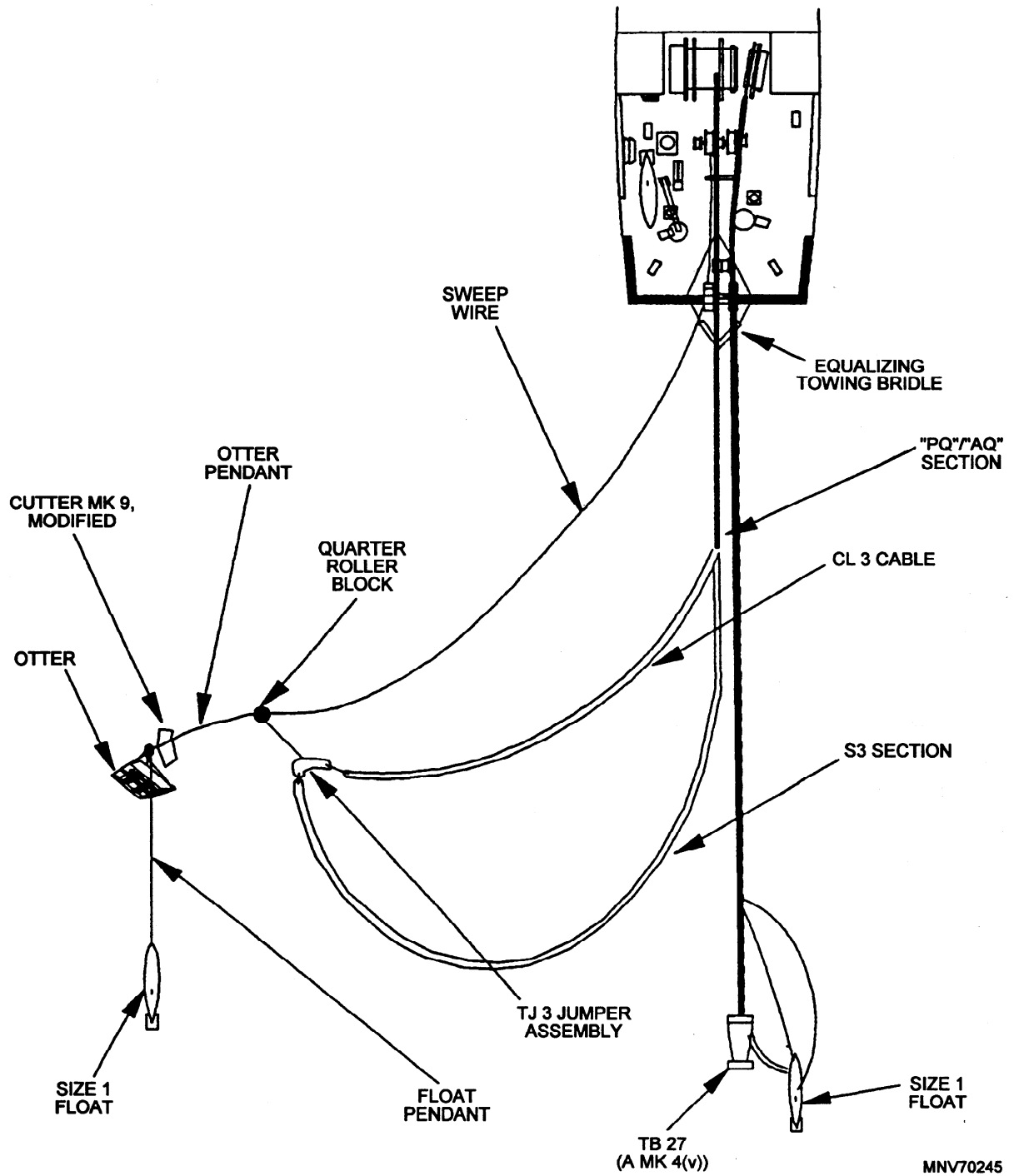

Figure 11-10.—M Mk 6(h) sweep configuration with TB-27(A Mk 4(v)) astern.

MNV70245

CHAPTER 12

MINESWEEPING SAFETY

LEARNING OBJECTIVES

Upon completing this chapter, you should be able do to the following:

1. Recall general minesweeping safety precautions.
2. Explain the need for minesweeping communications.
3. Explain the safe handling of explosive cutters.
4. Recall the safety precautions for moored minesweeping, influence minesweeping, and cold weather minesweeping.
5. Describe man-overboard procedures during minesweeping operations.

INTRODUCTION

Mine countermeasures (MCM) demand the use of a wide variety of specialized equipment to counter a wide variety of mines. Much of this equipment is heavy and cumbersome and, therefore, dangerous to use. As a Mineman, you must know and understand the safety precautions associated with the equipment to prevent injury to yourself or others.

This chapter provides safety information that all MCM minesweeper personnel should know concerning minesweeping operations. It includes specific and general safety precautions, as well as safety precautions pertaining to minesweeping communications, moored minesweeping, influence minesweeping, the explosive cutter, cold weather, and man-overboard procedures.

SAFETY PRECAUTIONS

Before a minesweeping operation begins, all personnel concerned should be briefed on the operation and given a thorough safety review. Additionally, designated personnel must ensure that the ship's degaussing system is working properly both before and throughout the minesweeping operation.

The following paragraphs divide the numerous safety precautions into specific precautions, general precautions, and other precautions:

SPECIFIC PRECAUTIONS

Specific safety precautions pertain to the following individuals.

- A responsible safety observer must be stationed on the fantail during all streaming and recovery operations.
- A Hospital Corpsman ready to render first aid must be stationed on the 01 level during all streaming and recovery operations.
- The petty officer in charge of the minesweeping operation must be in a location that allows him to communicate directly with all winch and crane operators during all minesweeping operations.
- Personnel assigned to the sweep detail must wear construction-type safety helmets with quick-acting breakaway chin straps fastened and worn under the chin. Phone talkers must wear standard phone talker helmets. Safety helmets must be color-coded as shown in table 12-1.

Table 12-1.—Color-coded Helmets

Helmet Color	Personnel
White	Officers, chief petty officers, and supervisors
Yellow	Rig captains
Green	Signalmen and phone talkers
Brown	Winch operators
Red	Line-throwing Gunner's Mates (or bolo heavers)
Blue	Deck riggers and line handlers
White with red cross	Hospital Corpsmen
Gray	All others (electricians, etc.)

- Line-throwing Gunner's Mates must wear red jerseys or vests. Signalmen must wear green jerseys or vests. Jerseys should be worn under life jackets; vests should be worn over life jackets.
- Phone talkers on the intership phone may not fasten their neck straps.
- Personnel working on the fantail while the gear is moving must wear orange fiberglass or kapok life jackets.
- Personnel assigned to the sweep detail working on the fantail must wear government-furnished safety shoes.
- Designated personnel must ensure that the semi-rigid hull boat (SRHB) is rigged and ready for man-overboard procedures.

GENERAL SAFETY PRECAUTIONS

The following general safety precautions pertain to most of the personnel involved in the minesweeping operation. These individuals must

- avoid wearing loose clothing that may catch in the gear. Long-sleeve shirts must be buttoned and pants must be tucked into socks.
- remove all jewelry, wrist watches, and keys. Authorized personnel may carry an appropriate knife and a small marlinespike for routine work and for use in an emergency.

- never stand on, step over, or straddle a line or wire that is, or is subject to be, under tension.
- never permit a wire or a line to run through anyone's hands; however, personnel handling message lines or inhaul lines hand-over-hand may wear gloves.
- when required to work over, through, or outboard of lifelines, wear the standard approved safety harness with an attached working line fixed to a solid object. In addition, a second line must be attached to the safety harness and tended by another person at all times.
- keep all gear not in actual use stowed and well-secured in the proper place to avoid a missile hazard and magnetic compromise.
- close all fantail hatches to ensure that maximum watertight integrity is maintained.
- know the capabilities and limitations of all equipment.
- be instructed in man-overboard procedures.
- be instructed in the procedures and hazards of emergency breakaway.
- observe all the precautions associated with good seamanship.

OTHER SAFETY PRECAUTIONS

The following safety precautions pertain to individuals not directly involved in the minesweeping operation:

- All nonessential personnel must remain clear of the fantail. After gear is streamed and stopped off, all other personnel should clear the fantail.
- Unauthorized personnel must stay inboard of all gear that is being prepared or handled for streaming or recovery.
- Unauthorized personnel must keep out of the bights of lines and wires.

For safety and efficiency, positive communications must be maintained between the bridge and the fantail at all times during minesweeping operations. When the minesweeping detail is set, the phone circuit should be manned by a talker who is

extremely knowledgeable in minesweeping terminology and phone procedures. At all times, the bridge must be kept informed of the situation on the fantail.

MOORED MINESWEEPING SAFETY PRECAUTIONS

The following safety precautions apply to moored minesweeping operations, in addition to the general minesweeping safety precautions:

- A properly briefed lookout should be stationed on the bow with a charged fire hose to spot floating or shallow-moored mines. If the lookout spots a mine, he or she should immediately report the sighting and state the mine's relative bearing and approximate distance from the ship. The lookout should then proceed as follows:
 - If the mine is floating, use the fire hose to direct a water stream into the water next to the mine in a manner to force the mine away from the ship. The water stream should never be aimed directly at the mine in an attempt to wash it away. Doing so might cause the mine to explode.
 - If the mine is shallow-moored, have the ship undertake evasive maneuvering.
- Personnel should never be permitted to stand or work under a suspended load, or to stand between a suspended swinging load and the taffrail or any solid object.
- All gear should be kept working (under normal tension) while it is streaming. Normal tension is approximately 500 pounds. Slackened gear can become dangerous when tension is reapplied. Way should never be allowed to come off the gear, particularly in shallow water. The most likely time of losing tension on gear or of the gear becoming dead in the water is during turns. The following rules concerning floats are the best safeguards:
 - Keep the float abaft the beam.
 - Prevent the float from crossing the ship's wake.
- Cutters, otters, or depressors should never be brought close aboard without being examined for mines fouled in the gear.

- Personnel should never be permitted to lean over, reach over, or handle sweep or depressor wires while the wires are under tension or are subject to tension.
- Leather palm gloves are permitted in inclement weather and at the discretion of the supervisor.

EXPLOSIVE CUTTER SAFETY PRECAUTIONS

The following safety precautions apply to explosive cutter operations, in addition to the general minesweeping safety precautions:

- Always treat cutters as a loaded gun and point them in a safe direction.
- Face the anvil outboard when cutters are stowed on the deck in preparation for use, with safety pins in place.
- Disarm cutters when they are not needed.
- Always fit a safety pin in a cocked, armed cutter and ensure that the pin cannot fall out. Do not remove the safety pin until the cutter is positioned on the sweep wire. On recovery, replace the safety pin before removing the cutter or any debris from the wire. Ensure that the safety pin is installed in the Mk 15 cutter before removing the cutter from the sweep wire.
- Use an arresting disc in the Mk 15 cutter in all above-water operations to absorb any excess energy of the cutting punch. In underwater operations, the arresting disc must not be used; the water absorbs the excess energy. In an underwater operation, an area within a 25-foot radius of the activity must be clear of personnel.
- If a cutter shows evidence of having fired and the cutting punch is still intact while the cutter is still on the sweep wire, immediately cock the firing plunger, remove the breech block, extract the cartridge carefully, and jettison the cartridge immediately.
- Keep hands and body clear of the anvil.
- Ensure that the correct explosive cartridge is used.
- Handle the stock cartridge according to appropriate safety precautions.

- When the cutter is released after placement on the sweep wire, veer the sweep wire as soon as practical and continue placing the needed cutters. Expedite the recovery until the cutters are close aboard and the safety pins can be installed.
- Do not modify or alter a cutter in any way. Doing so may result in casualties to personnel and damage to the cutter.
- Ensure that the firing (trip) lanyards do not become entangled and that they are long enough to reach the monitoring station on the 01 level to prevent accidental firing of the Mk 15 cutter.
- Use safety lanyards (tag lines) on all cutters when they are being placed on the sweep wires and remove them after the cutters are attached.
- All personnel should be kept clear of the fantail and acoustic or magnetic power cables when the gear is being pulsed.
- All power cables should be inspected upon their recovery following each normal streaming and after a known or suspected grounding or collision. All defects should be corrected before the cables are reused.
- All grips on the cables should be wrapped with two or more layers of heavy canvas secured with marlin when the cables are stowed on the reel. All shackles should be removed from the bridle, and the preventor pendant shackles should be positioned as flat as possible against the cables.

INFLUENCE MINESWEEPING SAFETY PRECAUTIONS

The following safety precautions apply to influence minesweeping operations, in addition to the general minesweeping safety precautions:

- All personnel must obtain permission from the commanding officer or the officer of the deck before entering the drum area.
- There should be no loose gear in the drum area.
- All personnel should stay clear of the drum when it is in motion.
- The operator should not turn the drum until he or she has ascertained that (1) all personnel are clear, and (2) all running parts of the drum are clear.
- The acoustic deck receptacle should not be opened unless:
 - Someone capable of rendering first aid for electric shock is present.
 - A electrician qualified to service the deck receptacle and connect or disconnect a cable is available.
 - No power is being supplied to the deck receptacle from the manual or automatic control panels.
- Radical speed changes should be avoided if the presence of acoustic mines is suspected.

COLD WEATHER MINESWEEPING PRECAUTIONS

The following additional precautions apply to cold weather minesweeping operations:

Magnetic Cable

Avoid excessive handling of the magnetic cable. Cold weather tends to stiffen the cable, and care must be taken to prevent the insulation from cracking or splitting. The temperature of the cable should be at least 5°F before it is streamed. Use portable electric heaters to warm the cable. During recovery, apply heat to prevent icing and to assist drying. Carefully remove any ice that forms during recovery, and dry the cable as much as possible as it is reeled in to prevent it from sticking together on the reel.

Deck Machinery

Cover deck machinery with canvas covers to prevent the accumulation of ice and snow. Operate the machinery periodically. Before using the machinery, inspect it for blocks of ice that may jam moving parts. Where practical, hand turn or jack the equipment and comply with cold weather lubrication charts, after ensuring that the lubricants are water-free.

Stern Roller Chocks

Clear the stern roller chocks, the “H” frame, and the auto rewind to ensure that they turn freely before you begin streaming and recovery operations.

Acoustic Devices

Apply heat to the acoustic devices internally before they are operated at temperatures below 20°F. Two

electrically energized 500-watt strip heaters placed in the hammer boxes for at least 20 minutes before the devices are operated will prevent freezing.

MAN-OVERBOARD PROCEDURES

Man-overboard instructions should be included in the MCM commander's operational order (OPORD). In addition, the ship must have a fully-equipped semi-rigid hull boat (SRHB) rigged ready for lowering during all minesweeping operations.

The following procedures apply if a person falls overboard during minesweeping operations:

- The ship losing the individual and all other minecraft within 4,000 yards must de-energize all influence gear to reduce the possibility of a mine explosion.
- The victim should be instructed to swim toward the sweep gear, which provides, in effect, a ready-made life raft. The victim should be warned, however, to approach the gear with caution.

The ship losing the individual should take the following measures immediately:

1. Drop a life buoy.
2. Sound six short blasts on the ship's whistle.
3. Report as rapidly as possible to the officer in charge and to the ships in formation.
4. By day, hoist flag OSCAR where it can be seen best.
5. By night, display two pulsating red lights arranged vertically, and fire one white flare.

The short length of the ship and its great inertia against a turn while it is performing sweeping operations render both rudder and engine maneuvering useless for recovery of personnel and dangerous for the ship. Such actions should not normally be considered. A service/utility craft, mine destruction/recovery ship, or a minesweeper without gear streamed (if available) should proceed immediately to the victim's assistance. If none of these ships is available, the best-placed minesweeper should be directed to make the rescue and to take the necessary sweep-handling action to render the ship manageable enough to lower a boat in the vicinity of the victim.

APPENDIX I

GLOSSARY

- ABOARD**—Within or on the ship. The sailor's term; landsmen use on "board".
- ANCHOR AT SHORT STAY**—The anchor chain is out at a minimum length with the anchor still holding.
- ANCHOR BUOY**—A small float attached to the anchor by a line to mark the anchor's location if the chain is slipped or parted.
- ANCHOR IN SIGHT**—A report made by the anchor detail to the bridge when the anchor is first sighted as it is brought in.
- ANCHOR IS CLEAR**—When the anchor is first clear of the water and there is nothing fouling it or on it.
- ANCHOR IS FOULED**—The anchor has picked up a cable, debris, rock or coral, or is wrapped in its own chain.
- ANCHOR IS SHOD**—The anchor is covered with mud or bottom.
- ANCHOR'S AWEIGH**—The anchor has lifted clear of the bottom.
- AN/SLQ-37**—The magnetic/acoustic minesweeping system aboard the MCM 1 Class ship.
- ANSLQ-38**—The mechanical minesweeping system aboard the MCM 1 Class ship.
- AVAST**—Stop; cease; as in "Avast heaving".
- BECKET**—The fitting on a block to which the dead end of the fall is attached.
- BELAY**—The act of securing a line to a cleat, a set of bitts, or any other fixed point. In connection with an order or announcement, express the ideas to disregard, as in "Belay that last order".
- BIGHT**—A loop of rope, line, or chain.
- BOAT FALLS**—The rig used to hoist or lower small boats.
- BOLLARD**—A strong cylindrical upright on a pier, around which the eye or bight of a ship's mooring line is placed.
- CAPSTAN**—A vertical shaft machine used for handling lines or wires on a drum.
- CARRY AWAY**—The act of breaking loose.
- CHAIN PIPE**—Pipe leading from the forecastle deck to the chain locker.
- CLEAT**—A device for belaying a line or wire, consisting essentially of a pair of prolonged horns.
- CLOSE UP**—The act of hoisting a flag to, or in, its highest position.
- COCKLE**—A kink in an inner yarn of rope, forcing the yarn to the surface.
- DAY BEACON**—An unlighted structure that serves as a daytime aid to navigation.
- DAYMARK**—The identifying characteristics of a day beacon. Also, the shape or signal displayed by a vessel to indicate a special purpose, such as fishing, laying cable, and dredging.
- DIP THE EYE**—To arrange the eyes of mooring lines on bitts or bollards so one line dips into the eye of the other so that either line may be removed without disturbing the other.
- FAKE**—The act of disposing of a line, wire, or chain by laying it out in long, flat bights laid one alongside the one another.
- FLUKES**—board arms or palms of an anchor. The part of the anchor that digs into the bottom.
- GANTLINE**—Line used as a single whip for hoisting and lowering a boatswain's chair or one end of a stage.
- GROMMET**—A reinforced hole in a sail or awning. A grommet can be fashioned with line or made of metal.
- HAWSER**—Any line over 5 inches in diameter.
- HEAVE**—To throw, as to heave the lead or heaving line. To haul in, especially by some powered heaving engine.

- HITCH**—A knot used to bend the end of a line to a ring or to a cylindrical object. Usually, but not always, designated as some form of hitch.
- HOIST**—To move an article vertically upward by means of some hoisting rig.
- HSD**—Heat sensing devices that are used to detect a slow or fast rise in temperature for automatic activation of a magazine sprinkler system.
- LANYARD**—Any line used to attach an article of equipment to a person.
- LEFT-LAID**—Refers to line or wire in which the strands spiral along in a counterclockwise direction as one looks along the line.
- LINE**—In general, sailors refer to fiber rope as line; wire rope is referred to as rope, wire rope, or just wire. More exactly, line refers to a piece of rope, either fiber or wire, that is in use or has been cut for a specific purpose, such as a lifeline, heaving line, or lead line.
- MAGAZINE**—Any compartment, space, or locker that is used, or intended to be used, for the stowage of explosives or ammunition of any kind.
- MARLINE**—Two-strand, left-laid tarred hemp small stuff.
- MAXIMUM RANGE**—The greatest distance that a projectile will travel.
- MOUSING**—Line fashioned around a hook or shackle to prevent the load from falling off or the shackle pin from being undone.
- OCCULATING LIGHT**—A navigational aid in which the period of light is equal to or more than the period of darkness.
- OGIVE**—The forward portion of a projectile.
- ONBOARD**—Word to describe equipment installed aboard a ship.
- OROPESA (or O-type)**—Designation given to mechanical sweep gear, by the British after the HMS OROPESA, the ship on which the gear was developed. It is a sweep in which a length of sweep wire is towed by a single ship, lateral displacement being caused by a multiplane kite (otter), and depth being controlled at the ship by a multiplane kite (depressor) and at the otter end by a float and pendant.
- OSPREY CLASS**—The MHC 51 Class coastal minehunter ship.
- OTTER**—In mine warfare, a device which, when towed, displaces itself sideways to a predetermined distance.
- PREVENTIVE MAINTENANCE**—The regular lubrication, inspection, and cleaning of equipment.
- PRIMARY MAGAZINES**—Ammunition stowage spaces, generally located below the main deck, and insofar as is practical, below the waterline.
- PRP**—Pneumatically released pilot valve.
- PYROTECHNIC**—A device used for illumination, marking, and signaling.
- RATGUARD**—A hinged metal disk that can be secured to a mooring line to prevent rats from using the line to gain access to the ship.
- RATTLE BARS**—Acoustic minesweeping gear (A Mk 2 (g)) made of pipes.
- READY-SERVICE MAGAZINES**—Spaces physically convenient to the weapons they serve; they provide permanent stowage for part of the ammunition allowance.
- RIGHT-LAID**—Refers to line or wire in which the strands spiral along in a clockwise direction as one looks along the line.
- SEA PAINTER**—A line led well forward on the ship to a boat alongside.
- SHOT**—One of the lengths of chain that, when joined together, makes up the anchor cable. A standard shot is 15 fathoms long.
- SLUSH**—The act of applying a protective coating to line or wire. The substance composing the protective coating so applied.
- SMALL ARMS**—Any firearm with a caliber (cal.) of .60 inch or smaller and all shotguns.
- SMALL STUFF**—Refers to a line 1 1/4 inches or less in circumference.
- SOUNDING**—A measure of the depth of the water.
- STOPPER**—A line or chain or a patented device used for stopping off a rope or chain.
- STREAMING**—The process of deploying minesweeping gear in preparation for a sweep operation.

TB-26—Towed body-26, An acoustic device aboard MCM 1 Class ships (formerly called A Mk 6(b).)

TB-27—Towed body-27, An acoustic device aboard MCM 1 Class ships (formerly called A Mk 4(v).)

UNLAY—Untwist and separate the strands of a rope.

WEIGH ANCHOR—Hoist the anchor clear of the bottom.

APPENDIX II

ABBREVIATIONS AND ACRONYMS

The entries listed in this appendix are abbreviations and acronyms as they are used in this training manual.

A

AA&E—Arms, ammunition, and explosives

A/C—Air-conditioning

ACP—Autoloading Colt pistol

ACU—Automatic control unit

AE—Ammunition ship

AFS—Combat stores ship

AO—Oiler

AOE—Fast combat support ship

AOR—Replenishment oiler

APC—Acoustic power cable

B

B/B—Bridge-to-bridge

BMG—Browning machine gun

BS—Breaking strength

C

cal—Caliber

CDO—Command Duty Officer

CO—Commanding Officer

COMMO—Communications Officer

CONREP—Connected replenishment

E

EM—Electrician's Mate

EMO—Electrical Maintenance Officer

EN—Engineman

ESI—Explosive Safety Inspection

F

FAS—Fueling at sea

FM—Field manual

H

HB—Heavy barrel

HSD—Heat-sensing device

I

IALA—International Association of Lighthouse Authorities

L

LWT—Lightweight-type

M

MCM—Mine countermeasures

MK—Mark

Mod—Modification

MRC—Maintenance requirement card

N

NSTM—Naval Ship's Technical Manual

NWP—Naval Warfare Publication

O

OOD—Officer of the Deck

OTC—Officer in Tactical Command

P

PCU—Power converter unit

PO—Petty officer
PRP—Pneumatically-released pilot

Q

QK—Quick
QM—Quartermaster

R

RACON—Radar beacon
RAS—Replenishment at sea
RIB—Rigid-hull inflatable boat
rpm—rounds-per-minute

S

SAP—Semiautomatic pistol
SLAD—Slewing arm davit

SM—Signalman

SORM—Standard Organization and Regulations of the
US Navy

S/P—sound-powered phone

STREAM—Standard Tensioned Replenishment
Alongside Method

SWL—Safe working load

T

TB—Towed body
TM—Technical manual

U

UNREP—Underway replenishment

V

VQK—Very quick

APPENDIX III

REFERENCES USED TO DEVELOP THIS TRAMAN

Note: Although the following references were current when this TRAMAN was published, their continued currency cannot be assured. Therefore, you need to ensure that you are studying the latest revision.

Chapter 1

Ammunition Afloat, NAVSEA OP 4, Naval Sea Systems Command, Washington, DC, 1988.

Magazine Sprinkler Systems, NAVSEA S9522-AA-HBK-010, Naval Sea Systems Command, Washington, DC, 1989

Chapter 2

Browning Machine Gun, Caliber .50 HB, M2, FM 23-65, Department of the Army, Washington, DC, 1972.

40-MM Grenade Launcher M79, TM 9-1010-205-10, Department of the Army, Washington, DC, 1985.

40-MM Grenade Launcher M79, TM 9-1010-205-24, Department of the Army, Washington, DC, 1972.

Machine Gun, 7.62-MM, M60, TM 9-1005-224-10, Department of the Army, Washington, DC, 1985.

Machine Gun, 7.62-MM, M60, TM 9-1005-224-24, Department of the Army, Washington, DC, 1987.

Military Shotgun, 12 Gauge, Pump Action, Model 870, TO 11W3-6-2-1, Secretary of the Air Force, Washington, DC, 1972.

Mortar; 60MM, M224, TM 9-1010-223-10, Department of the Army, Washington, DC, 1987.

Pistol, Caliber .45, Automatic, M1911A1, TM 9-1005-211-12, Department of the Army, Washington, DC, 1968.

Pistol, Semiautomatic, 9mm, M9, Navy SW 370-AA-OPI-010/9mm, Department of the Navy, Washington, DC, 1990.

Rifle, 7.62-MM, M14, TM-9-1005-223-10, Department of the Army, Washington, DC, 1972.

Rifle, 7.62-MM, M14, TM 9-1005-223-20, Department of the Army, Washington, DC, 1972.

Chapter 3

Gunner's Mate 3 & 2, NAVEDTRA 12443, Naval Education and Training Professional Development and Technology Center, Pensacola, Fla., 1996.

Chapter 4

Mooring and Towing, Naval Ships' Technical Manual, S9086-TW-STM-010, Chapter 582, Naval Sea Systems Command, Arlington, Va., 1990.

Wire and Fiber Rope and Rigging, Naval Ships' Technical Manual, S9086-UU STM-010, Chapter 613, Naval Sea Systems Command, Arlington, Va., 1995.

Chapter 5

Anchoring, Naval Ships' Technical Manual, S9086-TV-STM-010, Chapter 581, Naval Sea Systems Command, Arlington, Va., 1990.

Mooring and Towing, Naval Ships' Technical Manual, S9086-TW-STM-010, Chapter 582, Naval Sea Systems Command, Arlington, Va., 1990.

Wire and Fiber Rope and Rigging, Naval Ships' Technical Manual Chapter 613, S9086-UU-STM-010, Naval Sea Systems Command, Arlington, Va., 1995.

Chapter 6

Boats and Small Craft, Naval Ships' Technical Manual, S9086-TX-STM-010, Chapter 583, Naval Sea Systems Command, Arlington, Va., 1992.

International Code of Signal, Pub. 102, Defense Mapping Agency Hydrographic/Topographic Center Washington D.C., 1993.

Chapter 7

Mooring and Towing, Naval Ships' Technical Manual, S9086-TW-STM-010, Chapter 582, Naval Sea Systems Command, Arlington, Va., 1990.

U.S. Navy Ship Salvage Manual, Volumes 1-3, Naval Sea Systems Command, Arlington, Va., 1990.

Chapter 8

MCM 1 Class Tactical Manual (C), NWP 3-15.61 (NWP 65-10) (Rev. A), Naval Doctrine Command, Norfolk, VA, 1993.

Surface Mine Countermeasures, MCM Class Ships, SW570-FO-MMO-030, "Rigging, Streaming, and Recovery," Naval Sea Systems Command, Washington, DC., 1992.

Surface Mine Countermeasures, MCM Class Ships (C), SW570-FO-MMO-040, "Operation and Maintenance," Naval Sea Systems Command, Washington, D.C., 1994.

Surface Mine Countermeasures Operations (C), NWP 3-15.11 (NWP 27-2) (Rev. B), Naval Doctrine Command, Norfolk, VA, 1993.

Chapter 9

MCM 1 Class Tactical Manual (C), NWP 3-15.61 (NWP 65-10) (Rev. A), Naval Doctrine Command, Norfolk, VA, 1993.

Surface Mine Countermeasures, MCM Class Ships, SW570-FO-MMO-030, “Rigging, Streaming, and Recovery,” Naval Sea Systems Command, Washington, D.C., 1992.

Surface Mine Countermeasures, MCM Class Ships (C), SW570-FO-MMO-040, “Operation and Maintenance,” Naval Sea Systems Command, Washington, D.C., 1994.

Chapter 10

Surface Mine Countermeasures, MCM Class Ships, SW570-FO-MMO-030, “Rigging, Streaming, and Recovery,” Naval Sea Systems Command, Washington, D.C., 1992.

Surface Mine Countermeasures, MCM Class Ships (C), SW570-FO-MMO-040, “Operation and Maintenance,” Naval Sea Systems Command, Washington, D.C., 1994.

Surface Mine Countermeasures Operations (C), NWP 3-15.11 (NWP 27-2) (Rev. B), Naval Doctrine Command, Norfolk, VA, 1993.

Chapter 11

Surface Mine Countermeasures, MCM Class Ships, SW570-FO-MMO-030, “Rigging, Streaming, and Recovery,” Naval Sea Systems Command, Washington, D.C., 1992.

Surface Mine Countermeasures, MCM Class Ships (C), SW570-FO-MMO-040, “Operation and Maintenance,” Naval Sea Systems Command, Washington, D.C., 1994.

Surface Mine Countermeasures Operations (C), NWP 3-15.11 (NWP 27-2) (Rev. B), Naval Doctrine Command, Norfolk, VA, 1993.

Chapter 12

Surface Mine Countermeasures, MCM Class Ships, SW570-FO-MMO-030, “Rigging, Streaming, and Recovery,” Naval Sea Systems Command, Washington, D.C., 1992.

INDEX

A

Acoustic device, 9-1

 A Mk 2 (g), 9-1

 TB-26, 9-2

 TB-27, 9-3

Acoustic minesweeping, 9-1

 automatic control unit, 9-4

 configurations, 9-6

 equipment, 9-1

 floats, 9-4

 power cable, 9-4

Anchor, 7-1

 chain, 7-1

 weighing, 7-8

Anchoring, 7-7

B

Beeswax, 5-8

Boat, 6-1

 davits, 6-1

 hoisting, 6-3

 lifeboat, 6-3, 6-7

 lowering, 6-2

 Navy, 6-1

Boat seamanship, 6-1

Boatswain's chair, 5-3

Bridles, 8-10

 depressor, 8-10

 otter, 8-10

Browning .50 caliber, 2-20

 description, 2-21

 maintenance, 2-23

 operation, 2-25

Buoy, 6-15

 lights, 6-15

 mooring, 7-9

 shape, 6-15

Buoyage system, 6-13

 regions, 6-15

C

Camels, 5-3

Canvas, 5-6

 care, 5-7

 sewing, 5-8

 stowage, 5-7

 treated, 5-7

Cardinal marks, 6-19

Combination minesweeping, 11-1

 types, 11-1

Connected replenishment, 5-13

Cutters, 8-4. *See also* "Minesweeping"

D

Daymarks, 6-23

Deck fittings, 5-1

 bits, 5-1

 bollard, 5-2

 chock, 5-1

 cleat, 5-1

 padeye, 5-2

Deck seamanship, 5-1

Depressor, 8-10

Depressor wire, 8-3

F

Fenders, 4-13, 5-2,

Flags, 6-7

single, 6-11

substitutes, 6-11

Floats, 8-7, 9-4

Fueling at sea, 5-17

K

Knots, 4-15

blackwall hitch, 4-18

double Matthew Walker, 4-16

fisherman's bend, 4-16

marline hitch, 4-18

masthead, 4-17

rolling hitch, 4-17

single bowline, 4-16

Spanish bowline, 4-17

timber hitch, 4-18

L

Lateral marks, 6-15

Lead line, 5-5

Leather, 5-6, 5-11

care, 5-12

sewing, 5-12

Line, 4-1

care, 4-3

characteristics, 4-6

construction, 4-1

handling, 4-3

mooring, 4-10

natural-fiber, 4-3

size, 4-2

splicing, 4-10

synthetic-fiber, 4-5

M

Magazine, 1-1

designation, 1-1

Magazine-Continued

inspections, 1-2

primary, 1-1

ready-service, 1-1

security, 1-2

temperatures, 1-3

types, 1-1

Magazine sprinkler systems, 1-4

alarm systems, 1-12

automatic control system, 1-5

heat-sensing device (HSD), 1-8

hydraulic control system, 1-10

testing, 1-13

Magnetic minesweeping, 10-1

cable, 10-1

configurations, 10-3

equipment, 10-1

Marine illumination, 3-5

Mk 1, 3-7

Mk 2, 3-5

Marine locator marker, 3-1

Mk 6, 3-2

Mk 58, 3-1

Marlinespike seamanship, 4-1

Mechanical minesweeping, 8-1

configurations, 8-10

depressor wire, 8-3

equipment, 8-2

sweep wire, 8-2

Messenger, 5-17

Minesweeping, 8-1

Acoustic, 9-1. *See also* "Acoustic minesweeping"

combination, 11-1. *See also* "Combination minesweeping"

magnetic, 10-1. *See also* "Magnetic minesweeping"

- Minesweeping—Continued
- mechanical, 8-1. *See also* “Mechanical minesweeping”
 - safety, 12-1
- Minesweeping cutters, 8-4
- Mk 9 cutter, 8-4
 - Mk 12 cutter, 8-4
 - Mk 14 cutter, 8-6
 - Mk 15 cutter, 8-7
- Moored minesweeping, 8-1
- Mooring, 4-10, 7-6
- buoy, 7-9
 - shackles, 7-4
 - swivels, 7-4
- Multiplane kites, 8-8
- M60 machine gun, 2-24
- assembly, 2-31
 - disassembly, 2-29
 - operation, 2-25
- N**
- Navy lights, 3-10
- Needles, 5-8
- O**
- Otter, 8-8
- Otter bridle, 8-10
- P**
- Palms, 5-8
- Pennants, 6-9
- substitutes, 6-11
- Pistol AN-M8 pyrotechnic, 3-7
- Pistol .45-caliber, 2-4
- cycle of operation, 2-7
 - field-stripping, 2-6
 - safeties, 2-6
- Pistol M9, 2-8
- disassembly, 2-8
 - operation, 2-8
- Pistol Mk 5 pyrotechnic, 3-5
- Pyrotechnics, 3-1
- handling, 3-12
 - safety, 3-12
 - storage, 3-12
- R**
- Rattle bars, 9-1
- Replenishment at sea, 5-20
- Rifle M14, 2-10
- controls, 2-10
 - field-stripping, 2-23
 - firing, 2-12
- S**
- Salvage, 7-14
- Seizings, 4-19
- flat, 4-19
 - racking, 4-20
 - round, 4-19
 - throat, 4-20
- Signaling, 6-7
- flaghoists, 6-7
- Signals, 6-11
- distress, 6-23
 - storm-warning, 6-12
- Small arms, 2-1
- cycles of operation, 2-2, 2-7
 - fundamentals, 2-1
 - grenade launcher, 2-33
 - handguns, 2-4. *See also* “Pistol .45-caliber” and “Pistol M9”
 - machine guns, 2-20. *See also* “Browning .50 caliber” and “M60”

Small arms—Continued

 maintenance, 2-36

 nomenclature, 2-1

 shotguns, 2-14

 Shoulder weapons, 2-10. *See also* “Rifle
 M14”

 special precautions, 2-35

Smoke signal, 3-5

 Mk 2, 3-5

 Mk 13, 3-9

Soundings, 5-5

Stage, 5-5

Stitches, 5-8

 baseball, 5-9

 flat, 5-9

Stitches—Continued

 herringbone, 5-9

 round, 5-8

 shoemaker’s, 5-12

Sweep wire, 8-2

T

Towing, 7-10

U

Underway replenishment, 5-12

W

Wire rope, 4-20

 clips, 4-21

 construction, 4-20

Assignment Questions

Information: The text pages that you are to study are provided at the beginning of the assignment questions.

ASSIGNMENT 1

Textbook Assignment: "Magazines, and Magazine Sprinkler Systems" chapter 1, pages 1-1 through 1-13; and "Small Arms," chapter 2, pages 2-1 through 2-20.

- 1-1. What type of magazine is designed to hold a ship's entire peacetime allowance of ammunition?
1. Primary
 2. Secondary
 3. Ready-service
- 1-2. What type of magazine or locker provides permanent stowage of ammunition convenient to the weapon that it serves?
1. Primary
 2. Secondary
 3. Ready-service magazine
 4. Ready-service locker
- 1-3. Which of the following publications provides specific information concerning shipboard ammunition stowage requirements?
1. NAVSEA OP 4
 2. NAVSEA OP 5
 3. NAVSEA SW030-AA-MMO-010
 4. NAVSEA S9522-AA-HBK-010
- 1-4. Who is the custodian of all magazine keys aboard ship?
1. The Officer of the Deck
 2. The Weapons Officer
 3. The Executive Officer
 4. The Commanding Officer
- 1-5. What is the primary source of magazine inspection criteria?
1. NAVSEA OP 4
 2. NAVSEA OP 5
 3. OPNAV Instructions
 4. Security Manual
- 1-6. What is the main purpose of the daily magazine inspection?
1. To check material condition
 2. To check and record temperatures
 3. To check for gear adrift
 4. To inspect the fire main
- 1-7. Magazine inspection MRCs contain the same criteria as used by what inspection team?
1. ESI
 2. ESO
 3. PSI
 4. SMI
- 1-8. At what time interval should magazine temperatures be taken?
1. Once daily
 2. Twice a day
 3. Once a week
 4. Once a month
- 1-9. Which of the following temperatures should be recorded on a magazine record card inside the magazine?
1. High only
 2. Low only
 3. High and low only
 4. High, low, and present

- 1-10. What is the purpose of the exhaust ventilator pipe and check valve in shipboard magazines?
1. To shut off the entry of fresh air into the magazine
 2. To vent pressure when the space is flooded by the sprinkler system
 3. To exhaust dangerous gases that may have built-up in the firemain
 4. To control the sprinkler system's pressure level
- 1-11. Sprinkler control valves are designed to operate at what minimum firemain pressure?
1. 40 PSI
 2. 50 PSI
 3. 70 PSI
 4. 100 PSI
- 1-12. A diaphragm-operated valve is held closed by what type(s) of pressure?
1. Spring pressure only
 2. Firemain pressure only
 3. Both spring and firemain pressure
 4. Mechanical linkage
- 1-13. Sprinkler system transmission lines should be constructed of which of the following materials?
1. Brass
 2. Copper
 3. Lead
 4. Steel
- 1-14. The automatic control unit consists of HSDs, transmission lines, and a PRP valve only.
1. True
 2. False
- 1-15. Heat-sensing devices are designed to create pressure in response to what condition(s)?
1. Fire only
 2. A rapid rise in temperature only
 3. Fire and a rapid rise in temperature
 4. A slow or rapid rise in temperature
- 1-16. At what temperature is the fusible link of an HSD designed to part?
1. 155°F
 2. 160°F
 3. 165°F
 4. 175°F
- 1-17. What force or condition activates the PRP valve?
1. A vacuum pressure
 2. A differential pressure
 3. Heat
 4. Barometric pressure
- 1-18. What sprinkler system component prevents the rapid increase in air pressure created in an individual HSD from pressurizing the entire system?
1. Vented check valve
 2. Orifice
 3. Drain line
 4. Pneumatically released pilot

- 1-19. What is the purpose of the compensating vent on the PRP valve?
1. To equalize the system after it has been activated
 2. To compensate for fluctuation in barometric pressure
 3. To allow the PRP valve to be adjusted for different temperature ranges
 4. To vent slight pressures caused by normal temperature changes
- 1-20. How much pressure is required to trip a PRP valve?
1. 8 oz
 2. 8 lb
 3. 5 oz
 4. 5 lb
- 1-21. What sprinkler system valve allows the system to be secured from a station other than the one from which it was activated?
1. Manual control valve
 2. Hydraulically-operated remote control valve
 3. Spring-loaded lift check valve
 4. Hydraulically-operated check valve
- 1-22. What sprinkler system valve permits a main sprinkler valve to close rapidly and completely?
1. Power-operated check valve
 2. Vacuum-operated lift valve
 3. Spring-loaded lift valve
 4. Hydraulically-operated check valve
- 1-23. What sprinkler system component prevents a buildup of pressure in the control piping because of valve leakage?
1. Hydraulically-operated check valve
 2. Orifice
 3. Pressure check valve
 4. Drain line
- 1-24. What magazine alarm indicates water in the dry side of the sprinkler system piping?
1. F
 2. FD
 3. FH
 4. WT
- 1-25. The F alarm should sound when the magazine temperature rises above 105°F.
1. True
 2. False
- 1-26. From what source does the Navy get most of its small arms?
1. The Springfield Armory
 2. The Marine Corps
 3. The Army
 4. The manufacturers
- 1-27. Small-arms maintenance requirements are found in what publications?
1. TMs
 2. Army FMs
 3. Marine Corps FMs
 4. MRCs
- 1-28. What is the Navy's equivalent of the Army's M1911A1?
1. Model 1911 Alteration 1
 2. Mk 1911 Mod 1
 3. Mark 1911 Model 1
 4. Model 1911 Mark 1

- 1-29. What is the bore diameter of the 12-gauge shotgun?
1. .410 in.
 2. .729 in.
 3. .120 in.
 4. 12 mm
- 1-30. What function in the small-arms cycle of operation keeps the bolt closed after firing to prevent loss of gas pressure?
1. Ejection
 2. Extraction
 3. Feeding
 4. Locking
- 1-31. What two small-arms components work together to remove a spent cartridge case from the chamber and expel it from the weapon?
1. Case remover and ejector
 2. Extractor and ejector
 3. Case remover and extractor
 4. Sear and case extractor
- 1-32. What type of small-arms weapon requires the trigger to be pulled each time a round is to be fired?
1. Automatic
 2. Blowback-operated
 3. Gas-operated
 4. Semiautomatic
- 1-33. What type of small-arms weapon uses the force of the burning propellant to operate the bolt and feeder mechanism?
1. Automatic
 2. Blowback-operated
 3. Gas-operated
 4. Semiautomatic
- 1-34. In what type of small-arms operation is the weight of the breech bolt an important factor?
1. Automatic
 2. Blowback-operated
 3. Gas-operated
 4. Recoil-operated
- 1-35. In what type of small-arms operation are the barrel and the bolt locked together for a short time as they travel rearward after firing?
1. Automatic
 2. Blowback-operated
 3. Gas-operated
 4. Recoil-operated
- 1-36. What type of small-arms operation allows a weapon to keep firing as long as the trigger is kept pulled?
1. Automatic
 2. Blowback-operated
 3. Gas-operated
 4. Recoil-operated
- 1-37. What term is defined as the greatest distance a weapon can be expected to fire accurately?
1. Maximum accurate range
 2. Accurate range
 3. Effective distance
 4. Maximum effective range
- 1-38. What term is defined as the number of rounds per minute that a weapon can fire in full automatic operation?
1. Cyclic rate of fire
 2. Sustained rate of fire
 3. Maximum rate of fire
 4. Timed rate of fire

- 1-39. The magazine of an M1911A1 pistol can hold a total of how many rounds?
1. Five
 2. Six
 3. Seven
 4. Nine
- 1-40. The M1911A1 pistol uses what type of operation?
1. Autoloading
 2. Automatic
 3. Gas operation
 4. Recoil operation
- 1-41. Which of the following actions should you take before performing any work on a weapon?
1. Dry-fire the weapon
 2. Make sure the weapon is clear of ammunition
 3. Obtain permission from the work center supervisor
 4. Inform the work center supervisor
- 1-42. What is the first step in field-stripping an M1911A1 pistol?
1. Removing the slide stop
 2. Releasing the operating spring tension
 3. Removing the firing pin
 4. Removing the barrel bushing
- 1-43. Which of the following is a positive safety on the M1911A1 pistol?
1. Safety lock
 2. Grip safety
 3. Disconnect safety
 4. Half-cocked safety
- 1-44. On an M1911A1 pistol, when does the disconnecter function to prevent firing?
1. When the hammer is not fully cocked
 2. When the safety lock is engaged
 3. When the slide is fully forward
 4. When the slide is not fully forward
- 1-45. How does the grip safety prevent firing of the M1911A1 pistol?
1. By locking the sear in place
 2. By locking the hammer in place
 3. By directly preventing movement of the sear
 4. By preventing movement of the trigger
- 1-46. During firing, what action unlocks the barrel of an M1911A1 pistol from its slide?
1. The downward pivot of the barrel during recoil
 2. The spring action of the extractor
 3. The spring action of the operating spring
 4. The camming action of the barrel link as it passes over the disconnecter
- 1-47. The M9 pistol operates by which of the following methods?
1. Gas
 2. Blowback
 3. Short-recoil
 4. Long-recoil

- 1-48. The M9 has a magazine capacity of what maximum number of rounds?
1. 7
 2. 10
 3. 12
 4. 15
- 1-49. What is the maximum effective range of the M9 pistol?
1. 50 meters
 2. 1,000 meters
 3. 1,200 meters
 4. 1,800 meters
- 1-50. During firing, what action recoils the slide and barrel assembly of an M9 pistol?
1. The upward pivot of the barrel
 2. The spring action of the extractor
 3. The pressure developed from expanding gases
 4. The camming action of the barrel link as it passes over the disconnecter
- 1-51. The M9 pistol can be assembled and disassembled with the safety in the OFF position.
1. True
 2. False
- 1-52. The safety is in what location on the M-14 rifle?
1. On the left rear side of the receiver
 2. Forward of the trigger guard
 3. On the right rear side of the receiver
 4. In the center of the rear hand grip
- 1-53. What condition probably exists if the safety on an M-14 rifle will not engage?
1. There is no magazine in the weapon
 2. The bolt is not fully forward
 3. The weapon is not cocked
 4. The weapon is not loaded
- 1-54. What device activates the bolt lock of an M-14 rifle to hold the bolt open after the last round is fired?
1. The connector
 2. The disconnecter
 3. The magazine latch
 4. The magazine follower
- 1-55. The M-14 rifle uses what type of operation?
1. Blowback
 2. Gas
 3. Radial
 4. Recoil
- 1-56. When is an M-14 rifle considered clear?
1. After the last round is fired, the bolt is open, and the safety is set
 2. When the safety is set, the bolt is open, and there is no round in the chamber only
 3. When the magazine is out, the bolt is open, and there is no round in the chamber only
 4. When the bolt is open, the magazine is out, the safety is set, and there is no round in the chamber

- 1-57. What action should you take to remove the firing mechanism of an M-14 rifle?
1. Rotate the trigger guard away from the stock while depressing the trigger
 2. Rotate the trigger guard 90 degrees away from the stock
 3. Depress the retaining latch using the maintenance tool provided
 4. Depress the retaining latch using the pointed end of a cartridge
- 1-58. Field-stripping an M-14 rifle does NOT include which of the following steps?
1. Removing the extractor from the bolt
 2. Removing the bolt from the weapon
 3. Removing the stock from the receiver
 4. Removing the operating rod and connector
- 1-59. The M-14 is designed to fire what maximum number of rounds per minute during fully automatic fire?
1. 250
 2. 350
 3. 750
 4. 850
- 1-60. In which of the following positions should the spindle valve of the M-14 rifle be to propel a line-throwing projectile?
1. In
 2. Out
 3. On
 4. Off
- 1-61. When fully loaded, the tubular magazine of the M870 shotgun holds what maximum number of rounds?
1. Five
 2. Six
 3. Three
 4. Four
- 1-62. The safety is in what location on the M870 shotgun?
1. In the center of the rear hand grip
 2. On top of the receiver
 3. In the front of the trigger guard
 4. To the rear of the trigger guard
- 1-63. To put the M870 shotgun in the SAFE condition, you should push the safety in what direction?
1. Left to right
 2. Right to left
 3. Front to back
 4. Back to front
- 1-64. To pump the fore-end to the rear when you cock the M870 shotgun, you should take which of the following actions?
1. Release the safety
 2. Set the safety
 3. Press the action bar lock
 4. Release the action bar lock

- 1-65. What is the function of the action bar lock on the M870 shotgun?
1. It disconnects the trigger and sear assembly while the bolt is open and aligns each round of ammunition for proper seating
 2. It aligns each round of ammunition for proper seating and locks the action closed
 3. It locks the action closed and disconnects the trigger and sear assembly while the bolt is open
 4. It aligns each round of ammunition for proper seating and prevents double feeding
- 1-66. What action should you take to remove the barrel of the M870 shotgun?
1. Unscrew the barrel retaining nut
 2. Drive out the barrel retaining pins
 3. Rotate the barrel lock 90 degrees
 4. Remove the magazine cap
- 1-67. What action should you take to remove the breech bolt from the M870 shotgun?
1. Drive out the breech bolt retaining pin
 2. Remove the fore-end unit from the receiver
 3. Remove the bolt retainer and then pull the bolt through the ejection port
 4. Remove the trigger plate assembly and pull the bolt through the bottom of the receiver
- 1-68. The safety switch is in what location on the M500 shotgun?
1. On top of the receiver
 2. To the rear of the trigger guard
 3. To the front of the trigger guard
 4. On the bottom of the receiver
- 1-69. Where is the action lock release located on the M500 shotgun?
1. On top of the receiver
 2. To the rear of the trigger guard
 3. To the front of the trigger guard
 4. On the bottom of the receiver
- 1-70. The Mk 87 Mod 1 line-throwing kit launcher is installed on an M-14 rifle in what manner?
1. The flash suppressor is removed from the rifle and the launcher is screwed onto the barrel in its place
 2. The launcher is clamped to the gas cylinder of the rifle
 3. The launcher is clamped around the flash suppressor
 4. The launcher is slid over the flash suppressor and latched to the bayonet lug
- 1-71. What factor determines the active life of a chemical light wand?
1. Its age
 2. Its chemical composition
 3. The ambient temperature
 4. Barometric pressure

1-72. What is the approximate length of a roll of shot line?

1. 330 ft
2. 500 ft
3. 550 ft
4. 600 ft

1-73. What is the maximum reliable range of a line-throwing projectile fired from an M-14 rifle?

1. 80 yd
2. 90 yd
3. 95 yd
4. 100 yd

1-74. When a line-throwing projectile is fired from a M-14 rifle the spindle valve should be in the horizontal position.

1. True
2. False

1-75. Which of the following grenade cartridges should you use for the M-14 rifle?

1. M 64
2. M 85
3. M164
4. M195

ASSIGNMENT 2

Textbook Assignment: "Small Arms (continued)," chapter 2, pages 2-21 through 2-36; "Pyrotechnics," chapter 3, pages 3-1 through 3-13; "Marlinespike Seamanship," chapter 4, pages 4-1 through 4-21.

- 2-1. What is the maximum effective range of the M2 BMG?
1. 2,000 yd
 2. 4,000 yd
 3. 5,000 yd
 4. 7,400 yd
- 2-2. The M2 BMG uses what type of operation?
1. Blowback
 2. Gas
 3. Recoil
 4. Spring and cam
- 2-3. When the M2 BMG is fired, what factor determines automatic or semi-automatic mode of operation?
1. The position of the firing selector switch
 2. The position of the safety switch
 3. The position of the bolt latch release lock
 4. The set of triggers the operator uses
- 2-4. If firing continues after you release the M2 BMG trigger, what emergency action must you take?
1. Keep the weapon on target and allow it to expend all ammunition
 2. Open the feeder cover and remove the ammunition belt
 3. Break off the ammunition belt
 4. Twist the ammunition belt
- 2-5. Why should excessive oiling of the M2 BMG be avoided?
1. It is wasteful and unnecessary
 2. When the gun is fired, the oil may splatter on the operator, possibly getting in his eyes
 3. It is a fire hazard during sustained firing
 4. It can solidify, causing sluggish operation
- 2-6. What is the maximum effective range of the M-60 machine gun?
1. 1,100 yd
 2. 1,200 yd
 3. 1,000 m
 4. 1,200 m
- 2-7. The M-60 machine gun uses what type of operation?
1. Blowback
 2. Gas
 3. Recoil
 4. Semiautomatic

- 2-8. What action causes the firing pin to strike the primer of a chambered round in the M-60 machine gun?
1. The hammer striking the rear of the firing pin
 2. A machined knob on the face of the bolt striking the primer as the bolt closes
 3. The firing pin being carried forward into the primer by the operating rod yoke
 4. The hammer striking the rear of the bolt and transmitting force to the firing pin and into the primer
- 2-9. What action causes the bolt of the M-60 machine gun to lock into the barrel?
1. The cammed barrel causes the bolt to turn 90 degrees counter-clockwise, locking its three lugs into machined slots in the barrel
 2. The operating rod yoke rides against the bolt camming slot to turn the bolt 90 degrees clockwise
 3. Spring pressure
 4. Two locking levers are cammed out and over the two bolt lugs as it closes the breech
- 2-10. Which of the following is NOT a component in the operating group of the M-60 machine gun?
1. Bolt
 2. Drive spring
 3. Sear
 4. Spring guide
- 2-11. How is the M79 grenade launcher cocked?
1. The operator cocks the hammer manually by using his thumb
 2. The weapon cocks itself as the bolt is retracted
 3. The weapon cocks itself as it is opened
 4. The operator retracts the charging lever
- 2-12. What action is accomplished when the barrel locking latch of the M79 grenade launcher is moved all the way to the right?
1. The safety is set
 2. The barrel is locked in preparation for firing
 3. The safety is disengaged
 4. The direct fire sight is made visible for use
- 2-13. What is the battle sight range of the M79 grenade launcher?
1. 50 - 80 ft
 2. 165 - 265 ft
 3. 50 - 80 yd
 4. 165 - 265 m
- 2-14. What action must you take to remove the barrel from the stock of an M79 grenade launcher?
1. Remove the retaining latches
 2. Remove the securing pin
 3. Remove the stock
 4. Remove the fore-end
- 2-15. What initiator activates the igniter battery of a Mk 58 marine location marker?
1. Seawater
 2. A pull tape
 3. A twist key
 4. A transfer fuze

- 2-16. A Mk 58 marine location marker should burn for approximately what maximum time?
1. 20 to 30 min
 2. 30 to 40 min only
 3. 40 to 60 min only
 4. 30 to 60 min
- 2-17. The pull ring of a Mk 6 marine location marker activates what device or solution?
1. Quick match
 2. 900-sec delay fuze
 3. First candle starting mix
 4. The ignition squib
- 2-18. When conducting man-overboard drills, you should use what marine location marker, if one is available?
1. Mk 58 Mod 0
 2. Mk 58 Mod 1
 3. Mk 6
 4. Mk 2
- 2-19. How is the color of a Mk 2 marine illumination signal determined at night before it is fired?
1. By the color of the paper cartridge
 2. By the number of indentations in the base of the cartridge
 3. By the texture of the closing wad
 4. By the outside texture of the paper cartridge
- 2-20. The star of a Mk 2 marine illumination signal should burn for approximately what maximum time?
1. 6 sec
 2. 8 sec
 3. 10 sec
 4. 4 sec
- 2-21. The Mk 5 pyrotechnic pistol should be fired at what angle?
1. 45°
 2. 60°
 3. 75°
 4. 90°
- 2-22. Unfired signals should NOT be left in the Mk 5 pyrotechnic pistol for what reason?
1. It is not a good practice
 2. The positive safety could malfunction
 3. The pistol and the signal are required to be stored away from each other
 4. The pistol is always cocked when the breech is closed
- 2-23. What type of signal is produced by the Mk 1 Mod 1 marine illumination signal?
1. A red parachute-suspended star only
 2. A red or green parachute-suspended star
 3. A red, green, or yellow 7- to 11-second star
 4. A free-falling white comet
- 2-24. Which of the following signals is NOT designed to be fired from the AN-M8 pyrotechnic pistol?
1. Mk 1 Mod 0 marine illumination signal
 2. Mk 1 Mod 1 marine illumination signal
 3. Mk 2 marine illumination signal
 4. AN-M37A2 aircraft illumination signal

- 2-25. What color smoke is produced by the Mk 13 marine smoke and illumination signal?
1. Yellow
 2. Red
 3. Orange
 4. Green
- 2-26. At night, what feature identifies the flame end of a Mk 13 marine smoke and illumination signal?
1. Three beads on the plastic cap
 2. A smooth plastic cap
 3. A single protrusion on the plastic cap
 4. A ridge cast into the signal body
- 2-27. The flame end of a Mk 13 marine smoke and illumination signal is ignited in what manner?
1. By rubbing a scratching surface across an igniting compound
 2. With a twist igniter
 3. With a pull ring
 4. With a saltwater battery
- 2-28. What, if anything, should be done with a Mk 1 Navy light that gives off a vinegar smell?
1. It should be used as soon as possible
 2. It should be turned in as soon as possible
 3. It should be disposed of immediately
 4. Nothing
- 2-29. What total number of signals is contained in the Mk 79 Mod 2 personnel distress kit?
1. 5
 2. 7
 3. 9
 4. 10
- 2-30. What color star signal is fired from the Mk 79 Mod 0 personnel distress kit?
1. Green
 2. Orange
 3. Red
 4. White
- 2-31. Ordnance handlers should be constantly aware of which of the following characteristics of pyrotechnics?
1. Some may be activated by exposure to fresh water
 2. All are highly unstable
 3. All are very stable and require little care in handling
 4. Some are intended to burn with intense heat
- 2-32. Which of the following situations can cause the accidental activation of a pyrotechnic device during handling?
1. Exposure to fresh water
 2. Dents or cracks in the outer body
 3. Lack of proper grounding
 4. Exposure to nonorganic substances
- 2-33. Moisture can have which of the following effects on pyrotechnic devices?
1. It can make them more sensitive and dangerous
 2. It can make them less dependable
 3. It can make them more difficult to ignite
 4. Each of the above
- 2-34. Navy pyrotechnics are designed to withstand what minimum/maximum temperature range?
1. -20°F to 100°F
 2. -65°F to 100°F
 3. -65°F to 160°F
 4. -20°F to 165°F

- 2-35. The smoke and fumes of Navy pyrotechnics are non-toxic and cause only mild irritation to the eyes and nasal passages of personnel when exposed in any concentration.
1. True
 2. False
- 2-36. One of the advantages of braided lines over twisted (rope-laid) ropes is that they do not flex open to admit dirt. This characteristic is also a disadvantage because they are braided so tightly that
1. after wetting, they do not dry as quickly
 2. interior strands cannot be inspected readily
 3. they are too stiff to handle readily
 4. they kink easily
- 2-37. Which of the following lines consists of fibers twisted to form yarns, yarns twisted to the left to form strands, and strands twisted to the right to form line?
1. Three-strand, right-laid
 2. Three-strand, left-laid
 3. Cable-laid
 4. Machined-laid
- 2-38. What type of construction is used for cotton heaving lines?
1. Hollow braided
 2. Stuffer braided
 3. Double braided
 4. Solid braided
- 2-39. A line that has an equal number of right-twisted and left-twisted strands paired to make up a line is known as what type of line?
1. Plaited
 2. Braided
 3. Twisted
 4. Solid
- 2-40. The core of double-braided line accounts for how much of the line's total strength?
1. 30%
 2. 35%
 3. 45%
 4. 50%
- 2-41. If a line must be stowed when it is wet, how should it be laid?
1. In tight coils
 2. In loose coils
 3. In long flakes
 4. In short flakes
- 2-42. Winding a right-laid line in a counterclockwise direction on a winch drum will cause the line to do what?
1. Stretch
 2. Twist
 3. Kink
 4. Unravel
- 2-43. How must you handle secured lines during wet weather to prevent damage to them?
1. Replace them with wire rope
 2. Slack them off
 3. Slush them down
 4. Serve them with small stuff

- 2-44. Which of the following conditions is an indication that a natural fiber line has deteriorated as a result of age or exposure?
1. Decreased diameter
 2. Bristly surface
 3. Smooth surface
 4. Yellow or brown color
- 2-45. Which of the following conditions indicates internal wear in natural fiber line?
1. Reduced diameter
 2. Broken or dislodged yarns
 3. White powdery residue inside the lay
 4. Bristling of ends
- 2-46. At what angle to the direct line pull should you be positioned while you are tending synthetic fiber line that is under tension?
1. 45%
 2. 60%
 3. 75%
 4. 90%
- 2-47. Which of the following synthetic fiber rope construction has the highest resistance to abrasion?
1. Dacron
 2. Nylon
 3. Polypropylene
 4. Plaited
- 2-48. Before you use new three-strand synthetic fiber line, what should you do with it?
1. Soak it in salt water
 2. Stretch it
 3. Soak it in fresh water for 24 hours
 4. Fake it out on deck and allow it to relax for 24 hours
- 2-49. How much of its strength can a polypropylene line, without ultraviolet inhibitors, lose when exposed to sunlight?
1. 50%
 2. 20%
 3. 30%
 4. 40%
- 2-50. What is line called that is 1 3/4 inches or less in circumference?
1. Three strand
 2. Left-laid
 3. Small stuff
 4. Threads
- 2-51. When a tattletale cord suspended from two points on a synthetic line becomes taut, what does it indicate?
1. The line is about to part
 2. The line is too small for the job
 3. The critical point has been reached
 4. The SWL has been reached
- 2-52. Tattletale cords are made of what size line?
1. 6-thread manila
 2. 9-thread manila
 3. 15-thread manila
 4. 21-thread manila

- 2-53. The line handling term "check five" most clearly means
1. take a heavy strain on number five line, right up to breaking strength
 2. check number five line and report its condition
 3. take a heavy tension on number five line, rendering only enough around the bitts to prevent parting
 4. take a heavy tension on number five line, checking it constantly for indications of parting
- 2-54. What term is used when two mooring lines are placed over the same bollard and one eye is led through the eye of the other so they do not disturb each other?
1. Passing the eye
 2. Through the eye
 3. Dipping the eye
 4. Securing the eye
- 2-55. Which of the following are two characteristics of synthetic lines?
1. High elasticity and low friction
 2. Low elasticity and high friction
 3. Moderate elasticity and low friction
 4. No elasticity and high friction
- 2-56. What is the term used for wire rope that has its strands shaped prior to the laying up process?
1. Preshaped
 2. Prelayed
 3. Preformed
 4. Preflexed
- 2-57. Which of the following bends consists of taking a half hitch with the ends of two lines around a standing part of the other, and seizing the bitter end?
1. Fisherman's
 2. Becket
 3. Reeving line
 4. Carrick
- 2-58. What bend is used to bend a line to a becket or an eye?
1. Becket
 2. Fisherman's
 3. Reeving line
 4. Carrick
- 2-59. Which of the following knots is best suited for making an eye in the middle of a line?
1. Bowline
 2. French bowline
 3. Running bowline
 4. Single bowline on a bight
- 2-60. The rolling hitch is best used for which of the following applications?
1. Reeving awnings and bending sails
 2. Hoisting logs and spars
 3. As a stopper on mooring lines and falls
 4. Securing lines to hooks
- 2-61. What hitch is used on spars, planks, and other rough-surfaced material?
1. Barrel
 2. Timber
 3. Marlin
 4. Rolling

- 2-62. Which of the following knots is used to take the load off a weak spot in a line?
1. Monkey's fist
 2. Sheepshank
 3. Manrope
 4. Turk's head
- 2-63. What type of seizing should you use if the marriage of lines is to be under little or no strain?
1. Racking
 2. Round
 3. Throat
 4. Flat
- 2-64. What is the best seizing to use when there will be an unequal strain on two parts of a line which are seized together?
1. Flat
 2. Round
 3. Racking
 4. Throat
- 2-65. The first step in making a long splice is to unlay the end of each rope. How many turns should you unlay?
1. 5
 2. 7
 3. 10
 4. 15
- 2-66. What is the maximum allowable age of natural-fiber line used in critical operations?
1. 1 yr
 2. 2 yr
 3. 3 yr
 4. 5 yr
- 2-67. Which of the following Aramid[®] line sizes is equivalent to "8" double-braided nylon?
1. 4 1/8
 2. 4 3/4
 3. 5 3/8
 4. 5 7/8
- 2-68. What does the term EASE TWO mean?
1. Hold what you got
 2. Slack line two
 3. Put less tension on two
 4. Stop heaving
- 2-69. What minimum number of heaving lines should be laid out at each line handling station?
1. One
 2. Two
 3. Three
 4. Four
- 2-70. Which of the following synthetic lines has the lowest breaking strength?
1. Nylon
 2. Polyester
 3. Polypropylene
 4. Aramid
- 2-71. What is the minimum number of wire rope clips required for a 1-inch 6x19 wire?
1. Five
 2. Two
 3. Three
 4. Four
- 2-72. To strengthen a hook, what mousing should you use?
1. Marline
 2. Rope yarn
 3. Shackle
 4. Six-thread

2-73. What NSTM chapter deals with the size, care, use, and construction of wire rope?

1. 077
2. 583
3. 589
4. 613

2-74. A spring line should lead at what angle from a ship to the pier?

1. 30°
2. 35°
3. 40°
4. 45°

2-75. A line loaded in excess of 75 percent of its breaking strength will be damaged permanently.

1. True
2. False

ASSIGNMENT 3

Textbook Assignment: "Deck Seamanship," chapter 5, pages 5-1 through 5-21;
"Boat Seamanship," chapter 6, pages 6-1 through 6-25;
"Anchoring, Mooring, and Towing," chapter 7, pages 7-1 through 7-3.

3-1. What deck fitting should you use to make fast a line that has been led through a chock?

1. A cleat
2. A bitt
3. A chock
4. A bollard

3-2. What deck fitting consists of a double-end pair of projecting horns used for belaying a wire?

1. A cleat
2. A bitt
3. A chock
4. A padeye

3-3. Which of the following devices are used to protect the side of a ship from contact with a pier or another ship?

1. Padeyes
2. Bollards
3. Chocks
4. Fenders

3-4. There are how many different types of chocks?

1. One
2. Two
3. Three
4. Four

3-5. Camels are used to marry mooring lines together by wrapping the lines snugly with small stuff.

1. True
2. False

3-6. When you are aloft in the boatswain's chair, what command should you give to inform the deck crew to let go of the gantline?

1. AVAST HEAVING
2. UP BEHIND
3. LET GO
4. GANTLINE

3-7. What officer should you receive permission from before going aloft?

1. Commanding officer
2. Operations officer
3. Communications officer
4. Officer of the deck

3-8. What does the number designation of canvas indicate?

1. Width
2. Thread count
3. Thickness
4. Weight per square yard

3-9. What should you do with your tools when you are working aloft?

1. Put them in your pockets
2. Have someone throw them to you
3. Tie them to your chair
4. Tie them to your belt

- 3-10. What type of device, if any, should you use to secure all tools, buckets, and brushes to the ship when you are working over the side?
1. Lanyard
 2. Shackle
 3. Wire rope
 4. None
- 3-11. What bend is used to tie the gantline to the boatswains chair?
1. A becket
 2. A double becket
 3. A short splice
 4. A rope yarn
- 3-12. When the stage is properly rigged, which of its parts should support all the weight?
1. Horns
 2. Plank
 3. Gantlines
 4. Stage hitch
- 3-13. What is the approximate weight of a lead line?
1. 1 to 2 lb
 2. 3 to 4 lb
 3. 5 to 6 lb
 4. 7 to 14 lb
- 3-14. How deep is the water when the leadsman reports A QUARTER LESS THAN THREE?
1. 2 3/4 fathoms
 2. 13 3/4 fathoms
 3. 16 1/4 fathoms
 4. 18 1/4 fathoms
- 3-15. How many types of sail palms are used in the Navy?
1. One
 2. Two
 3. Three
 4. Four
- 3-16. What is the purpose of beeswax in sewing canvas?
1. To coat the needles
 2. To put on the canvas
 3. To reduce the wear on the sail twine
 4. To mark the holes
- 3-17. What is the first word or command you should say when you are ready to make the heave on a lead line?
1. LEAD LINE IN MOTION
 2. WATCH-O-WATCH
 3. LEAD LINE AWAY
 4. HEADS UP
- 3-18. What type of stitch should be used when a strong seam is required?
1. Round
 2. Herringbone
 3. Baseball
 4. Flat
- 3-19. What type of stitch should be used to mend tears in heavy or painted canvas?
1. Herringbone
 2. Baseball
 3. Flat
 4. Round
- 3-20. In which of the following widths is single-ply leather belting available?
1. 1 to 6 in.
 2. 2 to 8 in.
 3. 7 to 12 in.
 4. 8 to 14 in.
- 3-21. Leather will rend, crack, and shrink considerably if it is exposed to which of the following elements?
1. Oil
 2. Moisture
 3. Heat
 4. Pressure

- 3-22. Why should you put paper between hides of leather that are stowed flat, one on top or the other?
1. To allow them to shrink
 2. To keep them from cracking
 3. To keep them from sticking
 4. To keep them clean
- 3-23. The actual grommet in the handsewn grommet is made of what material?
1. Leather
 2. Marline
 3. Sail twine
 4. Canvas
- 3-24. Which of the following is the correct procedure for sewing bolt ropes to canvas?
1. Keep the rope taut and the canvas slack
 2. Keep the rope and the canvas taut
 3. Keep the canvas taut and the rope slack
 4. Keep the canvas and the rope slack
- 3-25. What stitch is the strongest and self locks?
1. Flat
 2. Round
 3. Herringbone
 4. Baseball
- 3-26. Which of the following sail needles is the largest?
1. 8
 2. 10
 3. 11
 4. 16
- 3-27. Which of the following jobs requires the use of a roping palm?
1. Sewing tears in light canvas
 2. Handsewing grommets
 3. Sewing on bolt ropes
 4. Sewing tears in heavy canvas
- 3-28. Which of the following stitches is most commonly used to join two pieces of canvas together?
1. Flat
 2. Herringbone
 3. Baseball
 4. Round
- 3-29. Which of the following cleaning solutions should you use to scrub dirty canvas?
1. Strong detergent and bleach
 2. Strong ammonia and water
 3. Mild soap and water
 4. Mild vinegar and oil
- 3-30. The Navy uses a variety of specially treated canvas including types which are resistant to fire and all EXCEPT which of the following agents?
1. Water
 2. Gasoline
 3. Acid
 4. Oil
- 3-31. Which of the following designators represents the heaviest weight of canvas?
1. No. 1
 2. No. 5
 3. A
 4. E

- 3-32. What measurement is used for issuing canvas?
1. Bolt
 2. Square foot
 3. Square yard
 4. Linear yard
- 3-33. The two most common methods of fueling at sea are
1. close-in and span-wire
 2. close-in and wire-highline
 3. span-wire and wire-highline
 4. burton and wire-highline
- 3-34. What does the term STREAM mean?
1. Standard transfer, except arms and munitions
 2. Standard tensioned replenishment alongside method
 3. Standard replenishment as moving
 4. Standard traveling alongside method
- 3-35. Who has the responsibility for selecting a suitable replenishment course and speed?
1. The CO of the delivery ship
 2. The CO of the receiving ship
 3. The officer in tactical command
 4. The senior officer present afloat
- 3-36. What is the color of the 120-foot marker on the B/B phone/distance line?
1. Green
 2. Red
 3. Yellow
 4. Blue
- 3-37. For night replenishment, what color and how many chemical lights are rigged at the 600-, 100-, 140-, and 180-foot markers?
1. Red, one
 2. Blue, two
 3. Yellow, one
 4. White, two
- 3-38. Which line is the main line used to haul any basic rig across between ships?
1. Messenger
 2. Shot line
 3. B/B phone/distance line
 4. Highline
- 3-39. Which of the following factors determine(s) the method to be used for a particular replenishment operation?
1. Type and quantity of cargo to be transferred
 2. Capacity of the rig and associated fittings
 3. Type and location of the receiving station
 4. All of the above
- 3-40. An MCM ship has what type of small boat?
1. Motorwhale
 2. Rigid-hull inflatable
 3. Mk 5 lifeboat
 4. Mk 6 lifeboat
- 3-41. What type of davit should be used to raise and lower a RIB?
1. Gravity
 2. Double-link
 3. Slewing boat
 4. Crescent

- 3-42. Where should the monkey lines tend while a boat is being lowered, to prevent them from fouling on an object or structure in the boat?
1. Over and inboard, between the ship and the boat
 2. inside the boat, coiled on deck
 3. Over the outboard side of the boat, away from the ship
 4. Hand tended from the deck of the ship to the inside of the boat
- 3-43. Which of the following personnel is responsible for making a small boat ready and getting the crew into the boat?
1. Engineer
 2. Petty officer in charge
 3. Senior Boatswain
 4. Coxswain
- 3-44. Once waterborne, what is the sequence of events that you should use in casting off a small boat: (a) Cast off forward (b) Cast off aft (c) Cast off the sea painter (d) Cast off the steadying lines?
1. a, c, d, b
 2. b, a, c, d
 3. b, a, d, c
 4. d, b, c, a
- 3-45. When a boat is to be hoisted in by davits, what is the first line a boatcrew should secure?
1. Frapping
 2. Monkey
 3. Steadying
 4. Sea painter
- 3-46. The standard shipboard allowance of inflatable lifeboats is a quantity that will provide for what percentage of a ship's crew?
1. 85%
 2. 100%
 3. 110%
 4. 125%
- 3-47. The primary difference between the Mk 5 Mod 2 and Mk 6 inflatable lifeboats is that the
1. Mk 5 Mod 2 is in a ridged container
 2. Mk 6 is in a ridged container
 3. Mk 5 Mod 2 holds more people
 4. Mk 6 holds more people
- 3-48. At what depth is the automatic launching feature on inflatable lifeboats designed to activate?
1. 30 to 60 ft
 2. 20 to 50 ft
 3. 10 to 40 ft
 4. 5 to 15 ft
- 3-49. What degree of lip is designed on the standard Navy lifeboat stowage cradle to prevent the encapsulated lifeboat from falling out?
1. 10°
 2. 15°
 3. 20°
 4. 25°
- 3-50. What size nylon cord is attached to the shackle of the hydrostatic release and passes through the thimble of the wire rope harness?
1. 1/4 in.
 2. 1/2 in.
 3. 3/4 in.
 4. 5/8 in.

- 3-51. Which of the following is the best definition of the hoist on a signal flag?
1. The hoist is that part of the flag that is used to haul it up
 2. The hoist is that part of the flag that hauls up the next flag in the signal
 3. The hoist is the vertical width of the flag when it is flying free
 4. The hoist is the entire flag signal
- 3-52. A signal should be read from which of the following directions?
1. Top down and from outboard in
 2. Bottom up and from outboard in
 3. Bottom up and from inboard out
 4. Top down and from inboard out
- 3-53. When a signal is long enough to be shown in three displays, where should the heading be hoisted?
1. In the first display only
 2. In the first display and repeated at the end of the display
 3. On a separate halyard and kept flying until the last hoist of the text is hauled down
 4. On the second halyard
- 3-54. Which of the following terms describes a flag hoist when it is hoisted three-fourths of the way up?
1. Close-up
 2. At the dip
 3. Hauled down
 4. Triatic way
- 3-55. You want a flag hoist display to read MIKE, MIKE, OSCAR, ALFA. Which of the following flags should you fly?
1. MIKE, MIKE, OSCAR, MIKE, ALFA
 2. MIKE, FIRST SUBSTITUTE, OSCAR, MIKE, ALFA
 3. MIKE, FIRST SUBSTITUTE, OSCAR, FIRST SUBSTITUTE, ALFA
 4. MIKE, FIRST SUBSTITUTE, OSCAR, SECOND SUBSTITUTE, ALFA
- 3-56. What flag should your ship fly when transferring fuel or explosives?
1. FOXTROT
 2. KILO
 3. ECHO
 4. BRAVO
- 3-57. Your ship is preparing to berth with its port side to the starboard side of another ship. What is the proper signal display for your ship?
1. OSCAR close up on the starboard yardarm
 2. INDIA at the dip on the port yardarm
 3. ROMEO close up on the port yardarm
 4. YANKEE at the dip on the starboard yardarm
- 3-58. You are standing watch and recognize your ship's call sign followed by JULIETT hoisted on another ship. What does this mean?
1. The ship is preparing to come alongside
 2. The ship has a semaphore message for your ship
 3. The ship has registered mail for your ship
 4. The ship is requesting line handlers from your ship

- 3-59. What flag(s) is/are carried made up and ready to break?
1. OSCAR only
 2. FIVE only
 3. OSCAR and FIVE
 4. INDIA
- 3-60. In the United States, which of the following weather signals is hoisted by day to indicate a gale warning?
1. One red pennant
 2. Two red pennants
 3. One red flag with a black center
 4. Two red flags with black centers
- 3-61. Which of the following lights displayed by the national weather service on a station indicates small craft warnings?
1. A white light over a red light
 2. A red light over a white light
 3. A red light over a red light
 4. A white light between two red lights
- 3-62. Navigational buoys should be depended on exclusively because of their unsinkable construction.
1. True
 2. False
- 3-63. Which of the following buoys is a tall structure on a broad base and smaller than a lighthouse buoy?
1. Can
 2. Nun
 3. Spherical
 4. Pillar
- 3-64. What color lights are reserved for port and starboard lateral marks?
1. Yellow and white only
 2. Red and green only
 3. Red, green, and white
 4. Yellow, white, and green
- 3-65. What international buoyage region covers Europe?
1. A
 2. B
 3. C
 4. D
- 3-66. In which of the following directions should a vessel or boat be safe in passing a north cardinal mark?
1. East
 2. West
 3. North
 4. South
- 3-67. Which of the following color bands on a cardinal mark indicate a westerly direction?
1. Black band above a yellow band
 2. Black band below a yellow band
 3. Black band with a yellow band above and below
 4. Black band above and below a yellow band
- 3-68. Which of the following markings indicates a midchannel buoy?
1. Red and white horizontal strips
 2. Red and white vertical strips
 3. Red and green vertical strips
 4. Red and black vertical strips

3-69. A new danger cardinal mark should exhibit what color light(s)?

1. Red only
2. Green only
3. Red and green
4. White

3-70. What are unlighted aids to navigation (except unlighted buoys) called?

1. Daymarks
2. Nightmarks
3. Buoys
4. Beacons

3-71. Every buoy, daymark, and light structure in the Intracoastal Waterway has what shape on its surface painted yellow?

1. Square
2. Diamond
3. Band
4. Triangle

3-72. What type of anchor is used on board MCM ships?

1. Standard
2. Stockless
3. Windless
4. Lightweight

3-73. What is the length of a standard shot of anchor chain?

1. 50 ft
2. 90 ft
3. 100 ft
4. 150 ft

3-74. Which of the following components should be used to attach an anchor to an anchor chain?

1. Detachable link
2. Bending shackle
3. Chain swivel
4. Stopper

3-75. Detachable link parts are interchangeable as long as they come from the same size link.

1. True
2. False

ASSIGNMENT 4

Textbook Assignment: "Anchoring, Mooring, and Towing (continued)," chapter 7, pages 7-3 through 7-15; "Mechanical Minesweeping," chapter 8, pages 8-1 through 8-15; "Acoustic Minesweeping," chapter 9, pages 9-1 through 9-8; "Magnetic Minesweeping," chapter 10, pages 10-1 through 10-6; "Combination Minesweeping," chapter 11, pages 11-1 through 11-12; "Minesweeping Safety," chapter 12, pages 12-1 through 12-3.

- 4-1. Where should you look on standard Navy stockless anchors to find the serial number?
1. On the shank
 2. On the flat of the crown
 3. On the side of the fluke
 4. On the end of the arm
- 4-2. What is the function of the stud on the Navy die-lock chain?
1. To assure proper fit of the chain in the wildcat
 2. To provide a grasping point for rousing out the chain
 3. To prevent the chain from kinking and the links from pounding on adjacent links
 4. To sound the chain while heaving in the anchor
- 4-3. What component should be used to connect shots of anchor chain together?
1. Chain swivel
 2. Center shackle
 3. Detachable link
 4. Anchor safety shackle
- 4-4. Which of the following components minimizes the kinking and twisting of the anchor chain?
1. Chain swivel
 2. Bending shackle
 3. Chain stopper
 4. Mooring shackle
- 4-5. What type of chain stopper is located the closest to the hawespipe?
1. Riding
 2. Towing
 3. Housing
 4. Carpenter
- 4-6. What item(s) of gear that riding and housing stoppers do not have is/are added to a towing chain stopper?
1. An extra detachable link
 2. Locking plates
 3. An extra studded link
 4. A length of chafing chain
- 4-7. What is the standard size mortise (opening), in inches, on all mooring shackles, regardless of their size?
1. 5 in.
 2. 6 in.
 3. 7 in.
 4. 8 in.
- 4-8. Which of the following terms applies to a 5-to 15-fathom length of wire rope having thimbles at both ends, one of which is fitted with a length of open line chain ending in a pelican hook?
1. Dip rope
 2. Lizard line
 3. Chaffing pendant
 4. Clear hawse pendant

- 4-9. What color is the entire next-to-last shot of anchor chain painted?
1. Red
 2. White
 3. Yellow
 4. Blue
- 4-10. The bitter end of the anchor chain should be secured to a pad eye in the chain locker with what type of shackle?
1. Safety
 2. Screw pin
 3. Mooring
 4. plate
- 4-11. How often should the anchor chain, regardless of size, be overhauled and placed in a good state of preservation?
1. Every 12 months
 2. Every 18 months
 3. Every 24 months
 4. Every 36 months
- 4-12. What person is in charge of the forecastle when personnel are anchoring and weighing anchor?
1. Ship's boatswain
 2. Senior petty officer
 3. First lieutenant
 4. Executive officer
- 4-13. You should start braking after the anchor is let go, and as soon as it
1. clears the hawsepipe
 2. reaches the bottom
 3. stops pulling the chain
 4. enters the water
- 4-14. What is the typical scope of chain veered for a ship anchoring in 12 fathoms of water?
1. 30 fathoms
 2. 40 fathoms
 3. 70 fathoms
 4. 110 fathoms
- 4-15. What report should you make to the bridge when the flukes of the anchor have broken out and the crown still rests on the bottom?
1. Anchor breaking ground
 2. Anchor is up and down
 3. Anchor is clear
 4. Anchor's aweigh
- 4-16. When preparing to moor to a buoy, the ship lowers a boat with the buoy party when it is how many yards from the buoy?
1. 1,000
 2. 1,800
 3. 2,000
 4. 2,500
- 4-17. When you are rigging for the trolley method of mooring to a buoy, what serves as the trolley?
1. Any size wire strap
 2. A large D-ring
 3. Small fairlead blocks
 4. Large shackles
- 4-18. When you rig a ship to be towed, where should you break the anchor chain?
1. At the bending shackle
 2. At the detachable end link
 3. At the swivel
 4. At the stopper

- 4-19. Which of the following devices holds the parts of a detachable link together?
1. Lead plug
 2. Hairpin
 3. Taper pin
 4. C-link
- 4-20. How many different types of salvages are being used in the Navy today?
1. One
 2. TWO
 3. Three
 4. Four
- 4-21. What type of salvage operation is used in emergency services for vessels and aircraft in distress at sea?
1. Harbor
 2. Rescue
 3. Offshore
 4. Combat
- 4-22. Mechanical minesweeping equipment is designed to eliminate what type of mines?
1. Ground
 2. Bottom
 3. Moored
- 4-23. Standard mechanical minesweeping gear is designed to counter what types of mines?
1. Shallow
 2. Very shallow only
 3. Very deep only
 4. Very shallow and very deep
- 4-24. What type of mechanical minesweeping equipment is used aboard MCM ships?
1. I
 2. M
 3. N
 4. O
- 4-25. A sweepwire should only be streamed from the starboard side of an MCM ship.
1. True
 2. False
- 4-26. Which of the following components is designed to maintain a sweepwire at a predetermined depth?
1. Otter
 2. Depressor
 3. Float pendant
 4. Tow wire
- 4-27. What is the typical length of a sweepwire?
1. 1,800 ft
 2. 2,500 ft
 3. 4,000 ft
 4. 4,500 ft
- 4-28. What is the safe working strength of a sweepwire?
1. 24,000 lb
 2. 16,000 lb
 3. 32,000 lb
 4. 64,000 lb
- 4-29. Right-lay wire should be used for a port sweepwire.
1. True
 2. False
- 4-30. What is the size of a depressor wire?
1. 1/4 in.
 2. 5/8 in.
 3. 1/2 in.
 4. 3/4 in.
- 4-31. Which of the following cutters should you use to cut a sweepwire in an emergency?
1. Mk 9
 2. Mk 12
 3. Mk 14
 4. Mk 15

- 4-32. An end cutter is designed to protect which of the following components?
1. Otter
 2. Depressor wire
 3. Float
 4. Kite
- 4-33. Which of the following cutters is NOT an explosive cutter?
1. Mk 9
 2. Mk 12
 3. Mk 14
 4. Mk 15
- 4-34. A modified Mk 9 cutter should never be installed on a port sweepwire.
1. True
 2. False
- 4-35. A Mk 12 Mod 2 cutter is initiated by a mine's mooring coming in contact with what component?
1. Firing plunger
 2. Rocker arm
 3. Trip pin
 4. Anvil
- 4-36. Which of the following cutters has is capable of cutting multiple moorings?
1. Mk 9
 2. Mk 12
 3. Mk 14
 4. Mk 15
- 4-37. The modified Mk 14 Mod 0 cutter is interchangeable from a port sweep to a starboard sweep.
1. True
 2. False
- 4-38. What explosive cartridge should you install in a Mk 15 Mod 0 cutter for use on deck?
1. Mk 154
 2. Mk 155
 3. Mk 194
 4. Mk 196
- 4-39. What color should be the top stripe on a float's flag for a starboard sweep?
1. Red
 2. White
 3. Black
 4. Yellow
- 4-40. What size float should be used to support the otter in a mechanical minesweeping operation?
1. 1
 2. 2
 3. 3
 4. 5
- 4-41. Which of the following components will change the function of the multiplane kit from an otter to a depressor?
1. Float
 2. Bridle
 3. Float pendant
 4. Sweepwire
- 4-42. Acoustic minesweeping is used to cut the moorings of influence mines.
1. True
 2. False
- 4-43. During a high-speed influence sweeping operation, what component should be used to deter arching of the sweep wire?
1. Otter
 2. Bridle
 3. Auxiliary depressor
 4. Float pendant

- 4-44. What device or method generates the sound in the TB-26?
1. Mechanical oscillator
 2. Spring-driven hammer
 3. Water flow through the eddies
 4. Acoustic power cable
- 4-45. The acoustic power cable is designed to supply power to and to tow the TB-26 and TB-27.
1. True
 2. False
- 4-46. The acoustic power cable has what number of nonbuoyant sections, if any?
1. One
 2. Two
 3. Three
 4. None
- 4-47. The automatic control unit generates what type(s) of signal(s)?
1. Acoustic only
 2. Magnetic only
 3. Acoustic and magnetic
- 4-48. Which of the following floats is the smallest in size?
1. 0
 2. 1
 3. 5
- 4-49. What size float should you use to support a TB-27?
1. 0
 2. 1
 3. 5
- 4-50. Magnetic minesweeping is basically creating a strong enough magnetic field around an MCM ship to fool a mine into thinking a ship is passing overhead.
1. True
 2. False
- 4-51. A magnetic sweep may be streamed alone or in combination with a mechanical sweep.
1. True
 2. False
- 4-52. What section of the Q-3 cable is water cooled?
1. AQ-3
 2. PQ-3
 3. CL-1
 4. CL-3
- 4-53. What color band separates the AQ-3 and PQ-3 sections?
1. Red
 2. Black
 3. White
 4. Green
- 4-54. What is the primary difference between the cables CL-1 and CL-3?
1. Length
 2. Diameter
 3. Construction material
 4. Buoyancy
- 4-55. The K-4 electrode consists of which of the following conductive materials?
1. Brass
 2. Copper
 3. Steel
 4. Magnesium

- 4-56. What is the length of a K-4 electrode?
1. 50 ft
 2. 100 ft
 3. 150 ft
 4. 300 ft
- 4-57. Which of the following magnetic sweeps should be used to sweep mines in fresh water?
1. Straight tail sweep M Mk 5(a)
 2. Diverted loop M Mk 6(a)
 3. Diverted loop M Mk 6(h)
 4. Double diverted loop M Mk 7(b)
- 4-58. What minimum number of CL-1 cables should be used for an "S"-type magnetic sweep?
1. One
 2. Two
 3. Three
 4. Four
- 4-59. The S-3 section is not used in a double diverted loop sweep.
1. True
 2. False
- 4-60. Which of the following sweep configurations, if any, will simulate a ship's pressure signature?
1. Diverted loop
 2. FA 2
 3. FA 2A
 4. None
- 4-61. What color safety helmet should you wear if you are assigned as a deck rigger in minesweeping operations?
1. Brown
 2. Gray
 3. White
 4. Blue